

Your fast and easy guide to  
finding the perfect computer

# Buying a Computer

FOR  
**DUMMIES**<sup>®</sup>

2004 Edition



**Dan Gookin**

Author of the #1 bestseller, *PCs For Dummies*

**A Reference for the Rest of Us!**



FREE eTips at  
[dummies.com](http://dummies.com)

*Buying a  
Computer*  
FOR  
DUMMIES®  
2004 EDITION

**by Dan Gookin**



WILEY

Wiley Publishing, Inc.

## Buying a Computer For Dummies®, 2004 Edition

Published by  
**Wiley Publishing, Inc.**  
111 River Street  
Hoboken, NJ 07030  
www.wiley.com

Copyright © 2003 by Wiley Publishing, Inc., Indianapolis, Indiana

Published by Wiley Publishing, Inc., Indianapolis, Indiana

Published simultaneously in Canada

No part of this publication may be reproduced, stored in a retrieval system or transmitted in any form or by any means, electronic, mechanical, photocopying, recording, scanning or otherwise, except as permitted under Sections 107 or 108 of the 1976 United States Copyright Act, without either the prior written permission of the Publisher, or authorization through payment of the appropriate per-copy fee to the Copyright Clearance Center, 222 Rosewood Drive, Danvers, MA 01923, (978) 750-8400, fax (978) 646-8700. Requests to the Publisher for permission should be addressed to the Legal Department, Wiley Publishing, Inc., 10475 Crosspoint Blvd., Indianapolis, IN 46256, (317) 572-3447, fax (317) 572-4447, e-mail: permcoordinator@wiley.com.

**Trademarks:** Wiley, the Wiley Publishing logo, For Dummies, the Dummies Man logo, A Reference for the Rest of Us!, The Dummies Way, Dummies Daily, The Fun and Easy Way, Dummies.com and related trade dress are trademarks or registered trademarks of John Wiley & Sons, Inc., and/or its affiliates in the United States and other countries, and may not be used without written permission. All other trademarks are the property of their respective owners. Wiley Publishing, Inc., is not associated with any product or vendor mentioned in this book.

**LIMIT OF LIABILITY/DISCLAIMER OF WARRANTY: WHILE THE PUBLISHER AND AUTHOR HAVE USED THEIR BEST EFFORTS IN PREPARING THIS BOOK, THEY MAKE NO REPRESENTATIONS OR WARRANTIES WITH RESPECT TO THE ACCURACY OR COMPLETENESS OF THE CONTENTS OF THIS BOOK AND SPECIFICALLY DISCLAIM ANY IMPLIED WARRANTIES OF MERCHANTABILITY OR FITNESS FOR A PARTICULAR PURPOSE. NO WARRANTY MAY BE CREATED OR EXTENDED BY SALES REPRESENTATIVES OR WRITTEN SALES MATERIALS. THE ADVICE AND STRATEGIES CONTAINED HEREIN MAY NOT BE SUITABLE FOR YOUR SITUATION. YOU SHOULD CONSULT WITH A PROFESSIONAL WHERE APPROPRIATE. NEITHER THE PUBLISHER NOR AUTHOR SHALL BE LIABLE FOR ANY LOSS OF PROFIT OR ANY OTHER COMMERCIAL DAMAGES, INCLUDING BUT NOT LIMITED TO SPECIAL, INCIDENTAL, CONSEQUENTIAL, OR OTHER DAMAGES.**

For general information on our other products and services or to obtain technical support, please contact our Customer Care Department within the U.S. at 800-762-2974, outside the U.S. at 317-572-3993, or fax 317-572-4002.

Wiley also publishes its books in a variety of electronic formats. Some content that appears in print may not be available in electronic books.

Library of Congress Control Number: 2003105669

ISBN: 0-7645-4077-7

Manufactured in the United States of America

10 9 8 7 6 5 4 3 2 1

1B/RX/QX/QT/IN



WILEY is a trademark of Wiley Publishing, Inc.

## About the Author

**Dan Gookin** got started with computers back in the post-vacuum-tube age of computing: 1982. His first intention was to buy a computer to replace his aged and constantly breaking typewriter. Working as slave labor in a restaurant, however, Gookin was unable to afford the full “word processor” setup and settled on a computer that had a monitor, keyboard, and little else. Soon, his writing career was under way with several submissions to fiction magazines and lots of rejections.

His big break came in 1984, when he began writing about computers. Applying his flair for fiction with a self-taught knowledge of computers, Gookin was able to demystify the subject and explain technology in a relaxed and understandable voice. He even dared to add humor, which eventually won him a column in a local computer magazine.

Eventually, Gookin’s talents came to roost as a ghostwriter at a computer book publishing house. That was followed by an editing position at a San Diego magazine. During this time, he also regularly participated in a radio talk show about computers. In addition, Gookin kept writing books about computers, some of which became minor bestsellers.

In 1990, Gookin came to IDG Books Worldwide (now Wiley Publishing, Inc.) with a book proposal. From that initial meeting unfolded an idea for an outrageous book: a long overdue and original idea for the computer book for the rest of us. What became *DOS For Dummies* blossomed into an international bestseller with hundreds of thousands of copies in print and in many translations.

Today, Gookin still considers himself a writer and a computer “guru” whose job it is to remind everyone that computers are not to be taken too seriously. His approach to computers is light and humorous yet very informative. He knows that the complex beasts are important and can help people become productive and successful. Gookin mixes his knowledge of computers with a unique, dry sense of humor that keeps readers informed — and awake. His favorite quote is “Computers are a notoriously dull subject, but that doesn’t mean that I have to write about them that way.”

Gookin’s titles for Wiley Publishing include the best-selling *DOS For Dummies*, *Word For Windows For Dummies*, and the *Illustrated Computer Dictionary For Dummies*. All told, he has written more than 80 books about computers. Gookin holds a degree in communication from the University of California, San Diego.

You can e-mail Dan on the Internet: [dang@wambooli.com](mailto:dang@wambooli.com).

## **Publisher's Acknowledgments**

We're proud of this book; please send us your comments through our online registration form located at [www.dummies.com/register/](http://www.dummies.com/register/).

Some of the people who helped bring this book to market include the following:

### ***Acquisitions, Editorial, and Media Development***

**Project Editor:** Rebecca Whitney  
**Acquisitions Editor:** Greg Croy  
**Technical Editor:** Lee Musick  
**Editorial Manager:** Carol Sheehan  
**Media Development Supervisor:**  
Richard Graves  
**Editorial Assistant:** Amanda M. Foxworth  
**Cartoons:** Rich Tennant,  
[www.the5thwave.com](http://www.the5thwave.com)

### ***Production***

**Project Coordinators:** Dale White,  
Ryan Steffen  
**Layout and Graphics:** Kelly Emkow, Joyce  
Haughey, Stephanie Jumper, Jacque  
Schneider  
**Proofreaders:** John Tyler Connoley,  
Andy Hollandbeck, Susan Moritz,  
Kathy Simpson, Brian H. Walls,  
TECHBOOKS Production Services  
**Indexer:** TECHBOOKS Production Services

---

### **Publishing and Editorial for Technology Dummies**

**Richard Swadley**, Vice President and Executive Group Publisher  
**Andy Cummings**, Vice President and Publisher  
**Mary C. Corder**, Editorial Director

### **Publishing for Consumer Dummies**

**Diane Graves Steele**, Vice President and Publisher  
**Joyce Pepple**, Acquisitions Director

### **Composition Services**

**Gerry Fahey**, Vice President of Production Services  
**Debbie Stailey**, Director of Composition Services

# Contents at a Glance

<b>Introduction .....</b>	<b>1</b>
<b>Part I: Understanding the Whole Ordeal .....</b>	<b>3</b>
Chapter 1: Buying a Computer (Step-by-Step) .....	5
Chapter 2: Basic Training .....	15
Chapter 3: Computers from A to Z .....	23
Chapter 4: Introduction to Hardware and Software .....	35
<b>Part II: Hardware and Software Overview .....</b>	<b>41</b>
Chapter 5: All about Mr. Microprocessor .....	43
Chapter 6: Memory Stuff (Temporary Storage) .....	53
Chapter 7: Disks of Every Type (Permanent Storage) .....	63
Chapter 8: Monitor and Graphics Stuff .....	77
Chapter 9: Keyboard, Mouse, and Joystick .....	87
Chapter 10: Expansion Options .....	93
Chapter 11: Modems, Networking, and Sound .....	101
Chapter 12: Special Issues for Notebook and Laptop Computers .....	111
Chapter 13: Your Computer's Operating System .....	119
Chapter 14: Everything You Wanted to Know about Software (But Were Afraid to Ask) .....	129
<b>Part III: Finding Your Perfect Computer .....</b>	<b>141</b>
Chapter 15: Shopping for Software .....	143
Chapter 16: Matching Hardware to Your Software .....	157
Chapter 17: Surveying the Shopping Landscape .....	167
Chapter 18: Tips for Online Shopping .....	179
Chapter 19: Searching for Service and Support .....	185
Chapter 20: Buying the Computer .....	191
Chapter 21: Helpful Hints for Computer Setup .....	197
<b>Part IV: Living with Your Computer .....</b>	<b>209</b>
Chapter 22: Time to Get a Printer .....	211
Chapter 23: Moving to Your New Computer .....	221
<b>Part V: The Part of Tens .....</b>	<b>229</b>
Chapter 24: When to Buy, When to Sell, When to Upgrade .....	231
Chapter 25: Ten Common Mistakes Made By First-Time Computer Buyers .....	237
Chapter 26: Ten Warning Signs .....	241
Chapter 27: Ten Other Things You Should Buy .....	245
Chapter 28: Ten Tips and Suggestions .....	251
<b>Index.....</b>	<b>255</b>



# Table of Contents

.....

<b>Introduction .....</b>	<b>1</b>
About This Book .....	1
And Just Who Are You? .....	2
Icons Used in This Book .....	2
Where to Go from Here .....	2
<b>Part 1: Understanding the Whole Ordeal .....</b>	<b>3</b>
<b>Chapter 1: Buying a Computer (Step-by-Step) .....</b>	<b>5</b>
The Five Steps to Buying a Computer .....	6
Step 1: Figure out what you want to do with your computer .....	7
Step 2: Look for software .....	8
Step 3: Find hardware .....	10
Step 4: Shop for service and support .....	11
Step 5: Buy your computer .....	13
Don't Sit Around Waiting to Buy! .....	13
<b>Chapter 2: Basic Training .....</b>	<b>15</b>
Basic Parts .....	16
Console .....	16
Monitor .....	17
Keyboard .....	18
Beyond the Basic Parts .....	18
Mouse .....	18
Speakers .....	19
Modem .....	20
Printer .....	20
Scanner .....	21
Network options .....	22
Peripherals and other expansion options .....	22
<b>Chapter 3: Computers from A to Z .....</b>	<b>23</b>
What Is a Computer? .....	23
The traditional desktop computer .....	24
The Macintosh option .....	25
Laptops for every kind of lap .....	28
Palmtop computers .....	30
Gaming consoles .....	30
Workstations and servers .....	31
Mainframes .....	33
"How Much Will This Cost?" .....	33



## **Chapter 4: Introduction to Hardware and Software . . . . . 35**

Hardware: The Hard Stuff .....	35
The microprocessor (the main piece of hardware) .....	36
Basic hardware .....	37
Software, the Other Hard Stuff .....	38
The operating system .....	38
Applications and other programs .....	39
Putting It All Together .....	40

## ***Part II: Hardware and Software Overview . . . . . 41***

### **Chapter 5: All about Mr. Microprocessor . . . . . 43**

The Microprocessor Rules .....	43
The name game .....	43
Families, names, and flavors .....	44
The measure of power .....	46
Zooooom! (Microprocessor speed) .....	46
Some Microprocessor Q&A .....	47
“What does ‘[blank] or greater’ mean when talking about a microprocessor?” .....	47
“Are all Pentium processors the same?” .....	48
“Should I buy an upgradable microprocessor option?” .....	48
“What’s the cache?” .....	49
“Is the Celeron a good Pentium compatible?” .....	49
“Should I buy a non-Intel CPU if it saves me money?” .....	49
“What is Socket 7?” .....	50
“What’s the ‘heat sink’?” .....	50
“What is ‘hyperthreading’?” .....	50
“Do computers with dual processors run faster than computers with single processors?” .....	50

### **Chapter 6: Memory Stuff (Temporary Storage) . . . . . 53**

Say Hello to Mr. Byte .....	53
Memory Madness .....	55
Behold the chip! .....	55
The size of the thing (capacity) .....	56
Fast memory and faster memory .....	56
Goodbye, Mr. Chips! .....	57
Some technical memory terms .....	58
Main Memory versus Video Memory .....	60
Banks o’ Memory (RAM) .....	61
How Much Memory Do You Need? .....	62

---

<b>Chapter 7: Disks of Every Type (Permanent Storage) .....</b>	<b>63</b>
Why Disk Storage? .....	63
What is a disk, and what is a drive? .....	64
Types of drives .....	65
Capacity .....	66
Hard drive speed .....	67
CD-ROM drive speed .....	68
Cache or buffer memory .....	69
Fixed or removable? .....	69
The mystical drive controller .....	70
Disk Driving Your Computer System .....	71
Picking a hard drive .....	72
Your shiny, removable storage .....	73
Gotta have a floppy drive too .....	74
The Zip disk alternative .....	75
<b>Chapter 8: Monitor and Graphics Stuff .....</b>	<b>77</b>
The Graphical System .....	77
The Monitor Part .....	78
CRT or LCD? .....	79
Judge me by my size, will you? .....	81
I'll take two, please .....	82
The Graphics Adapter Part .....	83
Video RAM .....	84
The 3-D thing .....	84
How it plugs in .....	85
Read them labels! .....	86
<b>Chapter 9: Keyboard, Mouse, and Joystick .....</b>	<b>87</b>
Keyboards .....	88
Mice and Other Nonfurry Pointing Devices .....	89
Joysticks and Game Controllers .....	91
<b>Chapter 10: Expansion Options .....</b>	<b>93</b>
Connecting Stuff by Using Ports .....	93
The USB port .....	94
The Firewire port .....	95
The printer port .....	95
The serial port .....	96
Mouse and keyboard ports .....	97
The joystick/MIDI port .....	97
A Full House of Cards .....	98
Why you may need expansion slots .....	98
Types of expansion slots .....	99



**Chapter 11: Modems, Networking, and Sound . . . . . 101**

- Say Hello to Mr. Modem .....101
  - Modems are measured by their speed .....102
  - Your typical, everyday dial-up modem .....103
  - Faster modems: Cable, DSL, satellite .....104
- Networking Computers .....105
  - Networking hardware to get with the computer .....105
  - Networking hardware to buy after the purchase .....106
- Sound Off! .....107
  - The bleeping circuitry .....107
  - Tweeting and woofing .....108
  - Adding a microphone .....109

**Chapter 12: Special Issues for Notebook and Laptop Computers . . . . . 111**

- Laptop Considerations .....112
  - Special (expensive) microprocessors .....113
  - Disk drives .....113
  - A battery of issues .....114
  - The skinny on laptop weight .....115
  - The anti-mouse .....115
  - Laptop communications .....116
  - Security issues .....116
- Laptop Expansion Options .....116
  - “I’ve seen these ports before!” .....117
  - The PCMCIA port .....117

**Chapter 13: Your Computer’s Operating System . . . . . 119**

- Understanding Operating Systems .....120
  - Working with you .....120
  - Controlling the software .....121
  - Controlling the hardware .....122
- Operating System Survey .....123
  - Windows XP, Home, and Professional .....123
  - Mac OS .....124
  - Linux .....125
  - Palm OS .....127
  - The antique, the immortal, and the dead .....127

**Chapter 14: Everything You Wanted to Know about Software (But Were Afraid to Ask) . . . . . 129**

- Doing the Internet .....130
  - Browsing the Web .....130
  - Getting your e-mail .....130
- Productivity Software .....131
  - Word processing .....131
  - Databases .....132

Home-budgeting software .....	132
Spreadsheets .....	133
Graphics .....	135
Recreation and Education .....	136
Games .....	136
Education .....	136
Utility Programs .....	137
Programming .....	138
Software for Nothing and Almost Free .....	138
Public domain software .....	139
Freeware or open source .....	139
Shareware .....	139
Demo software .....	140
Beware of illegal or pirated software .....	140

## ***Part III: Finding Your Perfect Computer ..... 141***

### **Chapter 15: Shopping for Software ..... 143**

How to Buy Software .....	143
Taking a test drive .....	144
Other sources for test-driving .....	145
How Helpful Is the Software? .....	146
Types of help you find in software .....	146
Don't forget support! .....	147
After You Find What You Want. . . . .	148
Stuff you find on the software box .....	149
Filling in the form: Example 1 .....	150
Filling in the form: Example 2 .....	151
At last: The software worksheet .....	154

### **Chapter 16: Matching Hardware to Your Software ..... 157**

The Hardware Worksheet .....	157
Filling in the worksheet (step-by-step) .....	159
Choose an operating system .....	159
Pick a microprocessor .....	159
Calculate your memory needs .....	160
Calculate your hard drive storage .....	161
More storage decisions .....	162
Other hardware stuff .....	163
A Sample for You to Review .....	164

### **Chapter 17: Surveying the Shopping Landscape .... 167**

Reading a Computer Ad .....	167
Finding computer advertisements .....	168
Dissecting an ad .....	168

Recognizing common tricks used to make an advertised price look really cheap .....	170
The myth of the free (or almost free) computer .....	171
Some Q&A Before You Rush Out to Buy .....	171
“Should I get a quote?” .....	171
“Can I haggle?” .....	172
“Should I get a discount off the manufacturer’s suggested retail price?” .....	172
“Isn’t there any way to get a deal on a computer?” .....	172
“Is it better to buy from a noncommissioned salesperson?” .....	173
“What about buying a used computer?” .....	173
“What about refurbished stuff?” .....	173
“You didn’t say anything about the swap meet” .....	174
Where to Buy .....	174
Your locally owned and operated computer store .....	175
National chains .....	175
The megastore .....	176
Mail-order brand names .....	177
Mail-order pieces’ parts .....	177

## **Chapter 18: Tips for Online Shopping . . . . . 179**

Buying on the World Wide Web .....	179
Finding a place to buy .....	180
Placing your order .....	181
Comparison shopping .....	183
Sleazy tricks used by online retailers .....	183
Tracking Your Order .....	184

## **Chapter 19: Searching for Service and Support . . . . 185**

How to Find Service and Support .....	185
Service Questions .....	186
“How long is your warranty?” .....	186
“Do you fix the computers at your shop?” .....	186
“Can you fix my computer at my home or office?” .....	187
Support Questions .....	187
“Can I phone someone to ask questions?” .....	188
“Do you offer classes?” .....	188
Support Issues for Buying on the Internet .....	189

## **Chapter 20: Buying the Computer . . . . . 191**

A Review of the Five Steps .....	191
What to Spend “Extra” Money On .....	192
When Do I Get My Computer? .....	193

Don't Ever Put a Deposit on a Computer! .....194  
 Hey, Bud! You're Ready to Buy .....194  
     A few last-minute buying tips .....195  
     The final step is to . . . .....195

**Chapter 21: Helpful Hints for Computer Setup . . . . . 197**

Check the Shipment .....198  
 Setting Up the Computer .....198  
     Open the boxes .....198  
         “What can I toss out?” .....200  
         “Should I keep the boxes?” .....200  
 Putting It Together .....201  
     Where will Mr. Computer live? .....201  
     Preparing to plug things in .....202  
     Setting up the console .....202  
     Attaching the mouse and keyboard .....203  
     Attaching other devices .....203  
     Setting up the monitor .....203  
     Plugging in other stuff .....204  
     Finishing up .....205  
 Turning the Thing On .....205  
     What to turn on first? .....205  
     Turning it off .....206  
 Breaking It In: The Burn-In Test .....206  
 What's Next? .....206  
     Dealing with software .....207  
     Dealing with other hardware .....207  
 Understanding Your System .....208

***Part IV: Living with Your Computer* .....209**

**Chapter 22: Time to Get a Printer . . . . . 211**

Different Printers for Different Printing .....211  
     Printer speed .....212  
     The print quality .....212  
     How much? .....213  
 Laser Printers Go “Fwoom Pkt Shhh!” .....214  
 Ink Printers Go “Thwip, Sft-Sft-Sft, Clunk!” .....214  
 Buying the Printer .....215  
     What does your software say? .....216  
     Printer shopping .....216  
     Printers do not come with cables! .....216  
     Printers don't come with paper, either! .....217  
     Buy some extra ink .....217  
 Setting Up the Printer .....218  
     Printer pieces' parts .....218  
     Connecting the printer cables .....219  
     Telling your computer about the printer .....219

**Chapter 23: Moving to Your New Computer . . . . . 221**

Moving Over Hardware .....	221
Antiques: Don't bother .....	222
Monitors .....	222
Disk drives .....	222
Memory .....	223
Expansion cards .....	223
Printers .....	224
Modems .....	224
Other peripherals .....	224
Transferring Your Software .....	225
Reinstalling applications .....	225
Moving over data .....	226
Eliminating the preinstalled bonus crap .....	227

**Part V: The Part of Tens . . . . . 229****Chapter 24: When to Buy, When to Sell,  
When to Upgrade . . . . . 231**

Unlike Wine and Cheese, Computers Don't Age Well .....	231
Should You Upgrade? .....	232
Which hardware to upgrade first .....	232
My \$.02 on upgrading your microprocessor .....	233
Upgrading software .....	234
Upgrading your operating system .....	234
Should You Sell Your Beloved Computer? .....	235
Buying a Used Computer .....	236

**Chapter 25: Ten Common Mistakes Made  
By First-Time Computer Buyers . . . . . 237**

Buying Hardware before Software .....	237
Dropping Brand Names .....	238
Shopping for the Cheapest Computer System .....	238
Being Unprepared for the Sale .....	238
Forgetting Some Extra Items .....	238
Not Paying by Credit Card .....	239
Not Reading the Setup Manuals .....	239
Forgetting That Software Is Expensive .....	239
Buying Too Much .....	239
Not Counting Learning Time .....	240

**Chapter 26: Ten Warning Signs . . . . . 241**

Industry "Standards" versus the Ads .....	241
Out-of-Date Stock .....	242
Money Down Required .....	242

---

Missing Pieces .....	243
No Address in the Mail-Order Ad .....	243
Salespeople Too Busy to Help .....	243
Salespeople in the Store Ignore You .....	243
No Classroom .....	244
No Software Documentation .....	244
<b>Chapter 27: Ten Other Things You Should Buy . . . . .</b>	<b>245</b>
Mousepad and Wristpad .....	245
Power Strip .....	246
Surge Protector .....	247
UPS .....	247
Printer Cable .....	248
Printer Paper .....	248
More Inky Stuff .....	248
Removable Disks .....	249
CD Caddy .....	249
A Roll of Paper Towels .....	250
<b>Chapter 28: Ten Tips and Suggestions . . . . .</b>	<b>251</b>
Your Computer Has a Clock .....	251
Get a Second Phone Line .....	252
After a While, Reread the Manuals .....	252
Put a Timer on That Internet .....	253
Get Antivirus Software .....	253
Subscribe to a Computer Magazine .....	253
Join a Computer Users' Group .....	253
Buy a Great Book .....	254
Remember That You Are in Charge .....	254
Don't Let the Computer Run Your Life .....	254
<b><i>Index</i> .....</b>	<b>255</b>





# Introduction

---

**W**elcome to *Buying A Computer For Dummies* — a book which assumes that you know *nothing* about a computer but are strangely compelled to buy one. If that's you, you have found your book!

This book is not a buyer's guide. In it, you won't find endless, boring lists of prices and products and useless part numbers. Instead, this book assumes that you need a computer for some reason. You'll discover that reason and then read about how to find software to carry out that task. From there, you'll match hardware to your software and end up with the computer that's perfect for you.

Because this is a *For Dummies* book, you can expect some lively and entertaining writing — not boring computer jargon. Nothing is assumed. Everything is explained. The result is that you'll have your own computer and *enjoy* the buying process.

## About This Book

Buying a computer is a five-step process, which this book fully explains. Along the way, you'll read about computer hardware and software and fill in some worksheets that help you configure a computer just for you.

The five steps to buying a computer are outlined in Chapter 1. After that, the book is divided into several parts, each of which occurs at a different stage in the buying process:

Part I overviews the entire process.

Part II discusses computer hardware and software: what it is and why you need it.

Part III details the buying process: where to buy, how to read a computer ad, and how to find service and support before the sale.

Part IV deals with setting up your new computer.

Part V is the traditional *For Dummies* “Part of Tens” — various lists for review or to help you get on your way.

## And Just Who Are You?

Let me assume that you're a human being who wants to own a computer. You probably don't have one now, or, if you do, it's very, *very* old and you desire a new one. Other than that, your experience with a computer is very limited. You have heard the jargon and know some brand names, but that's about it. If that's you, this is your book.

This book concentrates on buying a computer, which can be either a PC, Macintosh, handheld, laptop, or game console. Although all the information applies to buying *any* computer, the main thrust involves buying a desktop computer.

## Icons Used in This Book



Lets you know that something technical is being mentioned. Because it's technical, and written primarily as nerd trivia, you can freely skip the information if you want.



Flags useful information or a helpful tip. When you're visiting the computer store, for example, make sure that you leave with the same number of children you had when you arrived.



Something to remember, like all computers need a monitor or else you'll never see what it is you're doing.



Oops! Better watch out. You have lots of warnings to heed when you're buying a computer. This icon lets you find them right quick.

## Where to Go from Here

Steadily grab this book with both hands, and start reading at Chapter 1. Then continue reading. Occasionally, you may be asked to visit a computer store or find a computer advertisement. Do so when asked. Fill in the worksheets that are offered. Then get ready to go out and buy yourself a computer.

# Part I

# Understanding the Whole Ordeal

The 5<sup>th</sup> Wave By Rich Tennant



"Look at that craftsmanship. Notice the patina. It's already three years old. In the computer industry, that makes it a *genuine antique.*"

## *In this part . . .*

**O**, being a consumer is so much fun. Money be damned! There is just this immediate pleasure of getting something new, something smartly packaged. And nothing is newer or more crisply packaged than a personal computer. Even if you're an old hand with computers, there is something infinitely delightful with first opening the box and ripping off that shrink-wrap.

I'll be honest: Despite the friendly packaging and delightful out-of-box experience of a new computer, computers are daunting. They have lots of cables and connectors. They have buttons galore, which, unlike the microwave, aren't labeled Popcorn or Baked Potato. Where are the Word Processor or Internet Shopping buttons? Oops! Did you make a mistake?

Relax. The whole ordeal of buying a computer can be made utterly painless. It's possible to buy a computer that's just right for you, paying the least amount of money and getting all the stuff you need, plus proper service and support. That's why this book was written.

## Chapter 1

# Buying a Computer (Step-by-Step)

---

### *In This Chapter*

- ▶ The five steps to buying a computer
  - ▶ Step 1: Decide what you want the computer to do
  - ▶ Step 2: Find software to get that job done
  - ▶ Step 3: Find hardware to make the software go
  - ▶ Step 4: Shop for service and support
  - ▶ Step 5: Buy that computer!
- 

**A**ll human beings share some basic fears. Snakes. Spiders. Bowlers with cheap toupees. And perhaps the most recent horror to join the human menagerie of terror: buying a computer. It's a nightmare! It's from *The Twilight Zone*! It's like being in a Fellini movie!

Of course, buying a computer isn't really that scary. Sure, you can't escape from gruesome (well, tiresome) computer jargon. And technology marches forward like creeping radioactive slime from outer space, paralyzing you with fear that what you buy today will quickly become obsolete. Heck, even an "old hand" at computers can be intimidated by new gizmos and options.

*Fear! Dread! Uncertainty! Doubt!*

Does it really need to be that bad? No! Just like buying anything, the more you know about what you're buying, the better you can make your decision. A well-informed shopper is a smart shopper. The key to becoming a smart computer shopper is to follow the five easy steps outlined in this chapter.

- ✔ I should tell you up front that the biggest mistake people make in buying a computer is shopping for price rather than service. Although lots of places will sell you the cheapest computer in the galaxy, don't expect them to offer much after-sale support.
- ✔ Yes, you need support.
- ✔ The second biggest mistake is shopping for hardware before shopping for software. I explain the difference and why software is more important in Chapter 4.
- ✔ Though you can use this book to help you find a nice used computer, I don't recommend buying one as your first computer. Why? No support (see Chapter 19).

## *The Five Steps to Buying a Computer*

If you want to buy the perfect computer, the one Santa would have given you had you been good all year, you should follow these five simple steps:

### **1. Decide what you want the computer to do.**

There are as many reasons for buying a personal computer as people to think up the reasons. And owning a computer brings more benefits than could possibly be listed — even by a computer. So you have no excuse for not completing this step. When you finish this task, the rest of the steps fall nicely into place.

### **2. Find the software that will get you the result you want.**

### **3. Find the hardware to run your software.**

Most people confuse the order of Steps 2 and 3, worrying about hardware before software. But the software does the work; the hardware merely obeys the software. Put another way, you don't buy a TV set to watch the TV's imitation mahogany cabinet. No, you watch what's *on* the TV, the programming. Likewise, you buy a computer to run software. Ipso fatso, the software is more important. (But you can read more about this topic in Chapter 4.)

#### 4. Shop for service and support.

This step is the most important one — more important than buying the computer. Too many shoppers overlook service and support and regret it later. I rant about this subject at length later in this chapter.

#### 5. Buy that computer!

Although this statement seems obvious, I know lots of folks who put off the purchase, holding out for a better deal or newer technology that's just "moments away." Bah! When you're ready to buy, buy. 'Nuff said.

I've used these steps myself, and touted them for years. They work. Especially when you're buying something high-ticket like a computer, you don't want to make a simple mistake.



- ✓ If you haven't already decided what a computer can do for you, flip through Chapter 14 to see what the little beasts are capable of.
- ✓ The *software* gets the work done. You buy hardware to support the software you've chosen.
- ✓ *Service* means getting the computer fixed. *Support* means getting H-E-L-P when you need it. *Everyone* needs service and support with a new computer. Everyone.

## *Step 1: Figure out what you want to do with your computer*

A survey was taken a while back to find out why some people do not yet own a computer. The number-one reason? (Can you guess?) No, it wasn't that computers are too expensive. The number-one reason that people don't buy computers is that they haven't yet figured out what to do with one!

The first step toward buying your own computer is to decide what you want to do with it. Like other handy devices you own — a telephone, a car, a refrigerator, and that lava lamp — you need a reason to have a computer. Well? What do you see yourself doing on a computer?





- ✔ The number-one reason to buy a computer now is “to do the Internet.” With your computer, you can exchange e-mail, browse the Web, view news and sports, entertain yourself, chat, shop, trade stocks, mind your finances, or just plain goof off.
- ✔ It helps to picture yourself in the future, working on a computer. What are you doing (besides swearing at it)?
- ✔ Some people know instantly what they want a computer to do. I want a computer to help me write. My son wants a computer to play games. My grandmother doesn’t have a computer, although she could use one to help her with her church flock and to write up her meeting notes.
- ✔ If you ever work with lists, numbers, 3-x-5 cards, home finances, stocks, bonds, or Swiss bank accounts, or if you trade in plutonium from the former Soviet Union, you need a computer.
- ✔ If you’re buying a computer to complement the one at your office, you probably need something similar at home.
- ✔ If you’re buying a computer for your kids in school, ask their teachers what types of computers best run the software the school uses. Buy something similar for home.

## *Step 2: Look for software*

After you know what you want the computer to do, you go out and look for software to get the job done. This task involves going to software stores and seeing what’s available or asking friends who have computers what they recommend.

When you’ve found the software you need, take notes. Each software package has its hardware requirements listed right on the box — like the nutritional contents on a box of cereal. Write that information down, using a form similar to the one shown in Figure 1-1.

Chapter 15 shows you how to fill out the form. That’s your ticket for the next step: Buy hardware to run your software.



- ✔ You should try software before you buy it. Just about any computer store lets you try it: Sit down at the computer and play with the software you plan to buy. See how much you like it. See whether it works the way you expect it to. Does it make sense? If not, try something else.



- ✔ You're not buying anything in this step. You're just looking at various software packages you'll purchase later and jotting down their hardware appetite. That information — the stuff on the side of the box — helps you assemble your perfect computer system.
- ✔ After you find something you like, you fill in the Software Worksheet. Fill in one worksheet for each program you plan on buying.

## Software Worksheet

Product name: \_\_\_\_\_

Developer: \_\_\_\_\_

Price: \_\_\_\_\_

Category:	Office	Word processing	Spreadsheet	Presentation
	Utility	Database	Graphics	Education
	Internet	Networking	Programming	Financial
	Multimedia	Entertainment	Reference	Other

Type of support: Vanilla    Chocolate    Carob    Fudge

Operating systems: Windows 98/Me    2000    NT    XP Home/Pro  
 Macintosh: OS 9    OS X  
 Linux: \_\_\_\_\_  
 DOS: \_\_\_\_\_  
 Other: \_\_\_\_\_

Microprocessor: Pentium II    III    4    Other: \_\_\_\_\_  
 G3    G4  
 Alpha  
 Speed: \_\_\_\_\_ MHz

Memory (RAM) needed: \_\_\_\_\_ megabytes

Hard disk storage: \_\_\_\_\_ megabytes

Media: CD-ROM    DVD    Floppy

Graphics: Memory: \_\_\_\_\_ megabytes

Printer: \_\_\_\_\_

Recommendations: \_\_\_\_\_  
 \_\_\_\_\_  
 \_\_\_\_\_

**Figure 1-1:** The software worksheet.

## Step 3: Find hardware

After reviewing your software lineup, your next step is to match the software's requirements with a suitable computer. The idea is to find the hardware that can run your software. The software knows what it needs (it's on the side of the box), and you've collected all that information on the Software Worksheets, so this next step is simple: Fill the order.

Figure 1-2 shows a sample of this book's Hardware Worksheet. The information you find there may look intimidating now, but after you do your software research, filling in the worksheet is cinchy.

Thanks to the worksheet, you will know exactly what type of computer hardware you need. You'll never be steered to the wrong machine.

But don't buy anything yet!

- ✔ Most people make the mistake of shopping for hardware first and software second. After all, what you're buying is a *computer*. But now you know that what the computer *does* with software is more important.
- ✔ By matching your software needs to your computer hardware, you avoid a perilous fate; you *do not* become one of the sorry people who have to return to the computer store weeks later to upgrade their memory or hard drive or something else they should have had in the first place.



### Have a little class

I don't steer any of my friends to a local computer store unless it has a classroom attached. It's wonderful to know that a store is so dedicated to happy users that it devotes floor space to a classroom.

Some people take classes *before* they buy their computer. I recommend buying the computer first and taking the classes afterward. That way, you have something to go home and practice on. Also, with the computer in your possession, you know specifically which questions to ask. (If you've already attended such a class, you know that new computer owners ask more detailed and useful questions.)

Hardware Worksheet			
Operating system:	Windows:	_____	
	Macintosh:	_____	
	Linux:	_____	
Microprocessor:	Pentium G4 Other:	_____	
	Speed:	_____MHz	
Memory (RAM):	_____megabytes		
Hard drive storage:	_____gigabytes		
Removable media:	Standard 1.4MB Zip drive	No floppy	Other: _____
Optical media:	CD-ROM	CD-R	CD-RW
	DVD SuperDrive	DVD-R	DVD-RW DVD-RAM
			Other: _____
Graphics adapter:	_____megabytes		
	Other: _____		
Monitor:	Size: _____inches	Dot pitch: _____mm	
	Traditional CRT LCD	Other: _____	
Modem:	Internal Dial-up	External DSL	Cable Satellite
	Speed: _____	(bps)	
Mouse or pointing device:	Standard Trackball	Optical	Wireless Wheel
		Other: _____	
Ports:	Serial:	COM1	COM2
	Printer:	LTP1	
	USB ports:		Firewire: _____
	Joystick	MIDI	Other: _____
Printer:	Brand: _____		
	Laser	Ink	Impact
	Color	Options: _____	

**Figure 1-2:** The hardware worksheet.

## *Step 4: Shop for service and support*

Crazy Omar and Discount Dave may have deals on computers, and you can pick up a computer at the massive warehouse or membership store along with a six-month supply of pop and a vat of peanut butter — but what kind of support do those places offer? Especially

if you're a first-time buyer, there's no substitute for after-sale support. The support consideration far outweighs getting a deal or finding the cheapest computer in the land.

- ✔ It's easy to forget service and support because it's not mentioned prominently in the ads. Instead, you see prices and deals and sales. Ignore them!
- ✔ *Service* is the ability to fix your computer if something goes wrong with it. The best service is on-site, where someone comes to you and fixes your little electronic friend right where it lives. The worst service is when you have to pack up your computer and ship it to some overseas factory.
- ✔ *Support* is help. It can be in the form of classes, phone support, or training.
- ✔ The trade-off for a cheap computer is little service and no support.
- ✔ Chapter 19 goes into more detail about shopping for service and support. That chapter is very important! Read it! I'm not being funny!

**WARNING!**

## Buyer beware!

I'd like to tell you that lousy computer dealers don't exist, but they do. Even big businesses and longtime computer gurus get snagged into computer-buying tricks and traps. Here are my best tips and advice to avoid common computer-buying scams:

- ✔ **Check the ad for a street location.** Most fly-by-night operations work from P.O. boxes or rental mailboxes. Legitimate business have real street locations that you can drive by and see.
- ✔ **Never put money down on a computer.** That's typically the earmark of a rob-Peter-to-pay-Paul scheme. Pay the full price. You may have to wait while the system is being assembled, but that's not the same thing as making a down payment.
- ✔ **Run like the devil if the dealer insists that you pay only cash.**
- ✔ **Also consider running if the dealer doesn't accept credit cards.**
- ✔ **Always pay by credit card — never with cash or a check.** Many consumer protection laws are available to credit card users that are not available to people who pay with cash or by check.
- ✔ **Always make sure that you get what you paid for.** Check the invoice and, if you're suspicious, have a third-party repair place check your computer.

## *Step 5: Buy your computer*

When you're ready to buy your computer, buy it. You know what you need the computer for, you know what software to buy, you know what hardware to buy, and you've found a proper dealer with service and support. *So buy it!*

The buying process is covered in Part III of this book.

## *Don't Sit Around Waiting to Buy!*



It's only natural to hesitate a bit before buying a new computer. In fact, Step 5 (buying your computer) is the hardest of all the steps.

Money isn't the main thing that keeps people from finally buying a new computer. No, it's the rapid advancement of technology that instills hesitation. Computer technology speeds forward like a rocket sled on a frozen lake. A computer you buy today is guaranteed to be obsolete in three years, a dinosaur in five years, and nearly useless in ten. People see this situation as a warning: Don't buy today's computer; wait for the next generation!

Oh, pish. . . .

Although it's true that the next generation of computers will be better, faster, and probably less expensive, it's also true that waiting . . . gets you nowhere. It's like not catching a bus because you assume that the next bus will have fewer people on it or be cleaner. That may be the case, but while you're waiting, you're going nowhere.

The bottom line is when you're ready to buy, buy.



## Chapter 2

# Basic Training

---

### *In This Chapter*

- ▶ The console
  - ▶ The monitor
  - ▶ The keyboard
  - ▶ The mouse
  - ▶ Speakers
  - ▶ The modem
  - ▶ The printer
  - ▶ The scanner
  - ▶ The network card
  - ▶ Other peripherals and options
- 

**p** sychologists claim that we all keep basic images in our heads, images we use to identify things in the world. For example, everyone stores an image of a dog in his head. Say “dog” and that image comes up, which you use to identify all things dog in the world. The same is true with a computer.

When you think “computer,” an image comes into your head, a prototype computer by which you can judge other objects in the world, identifying them properly as a computer or a looks-like-a-computer rather than a looks-like-a-dog.

The sections that follow describe the various pieces of a computer, some of which you may be familiar with and some of which you probably don’t know. This is your basic training for tagging the most elementary parts of a computer.



## Basic Parts

The basic parts of all computers are

- ✓ The console
- ✓ The monitor
- ✓ The keyboard

The following sections help familiarize you with each item.

### Console

The main part of any computer system is the *console*. It's a box that contains the computer's innards — all the electronics that make the computer go. Figure 2-1 illustrates a type of console.

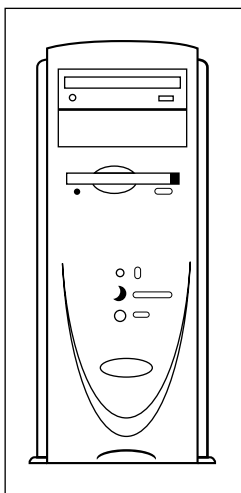

**Figure 2-1:** A typical computer console.

---

Some consoles are mere boxes, usually with slots for inserting disks plus a host of buttons. Other consoles, such as those used in computer laptops, may contain *everything*. Whatever. The name for the box is console.

- ✓ That's “CON-sole,” not “con-SOLE,” which means to provide comfort.

- ✔ The console is where the computer *really* is. My aunt thinks that the computer is in the monitor (covered next). But that's just where you look. The real computer is in the console. Everything else is an add-on.
- ✔ Some computers, such as the iMac, combine the console and the monitor. Your typical laptop or notebook computer combines the monitor and the keyboard into the console.
- ✔ A palmtop computer is basically its own console. Ditto for game machines, which are merely computer consoles that you plug into a TV set.

## Monitor

To see a computer's output, you need a monitor. In the old days, and it's still true for some game machines, a TV set was used rather than a "monitor." But as computer graphics grew more and more sophisticated, people preferred separate computer monitors (see Figure 2-2).

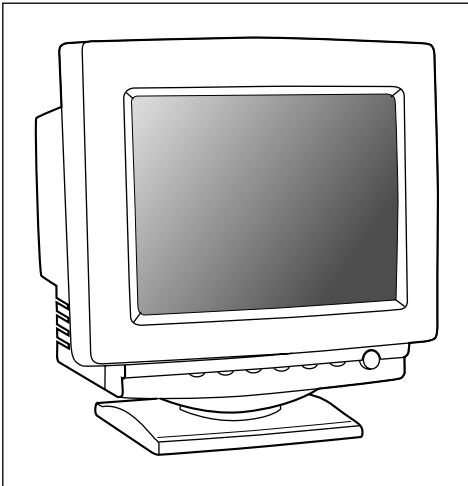

**Figure 2-2:** A typical computer monitor.

The monitor displays information on the *screen*, which is the glassy part of the monitor. (The monitor itself is the entire box.) The screen shows information generated by the computer, usually telling you what the computer is up to or giving you some other form of entertaining (or frustrating) feedback.

- ✔ Chapter 8 discusses monitors in depth.
- ✔ Because laptop and palmtop computers don't have a separate monitor box, the monitor is often just referred to as "the screen" on those systems.
- ✔ Game consoles produce sophisticated graphics, yet don't display as much text as a desktop computer would. Therefore, a TV set is okay for a game console's monitor, but for a full-on computer, a TV set has too low a resolution to make it practical.
- ✔ Future digital televisions will most likely be fully compatible with your computer, allowing you to use your TV as an alternative form of computer monitor.

## *Keyboard*

Computers lack ears. You'd never know this by the way people continually yell at computers. Even so, that's not the main way you communicate with a computer. For most of us, typing is the key. For that, you need a keyboard.

The type of keyboard a computer has depends on the computer's purpose. Most computers have a full, typewriter-size keyboard connected to the console with a curly cable. Some computers, laptops, and handhelds have a built-in keyboard. Some computers, such as palmtops and game consoles, lack keyboards altogether.

- ✔ If a computer lacks a keyboard, you generally communicate with the computer in some other way. For palmtops, you use a pen (or your finger) to enter information, by either punching buttons or touching the screen directly. For game consoles, you use a gamepad or high-tech joystick for input.
- ✔ Chapter 9 has more information on keyboards.

## *Beyond the Basic Parts*

Now that you think you have a grip on the basic parts, say Hello to the whole hoard of external add-ons. Many of these were once considered "bonuses" for a computer. Now they're more or less standard.

## *Mouse*

The keyboard's pal is the mouse.

No, not that kind of mouse. It's a computer mouse (see Figure 2-3), used with most computers to help you mess with graphical information. (And everything is graphics these days.)

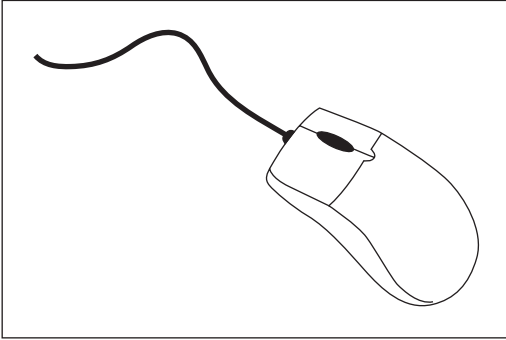

**Figure 2-3:** A modern computer mouse.

---

All computers now sold come with their own mouse. Even so, you can opt to toss that mouse out and buy yourself a better one — or you can order a better mouse with your computer when you make the buying decision.

- ✔ Chapter 9 explains more about your computer mice choices.
- ✔ Laptops have various mouse alternatives, devices that perform the same function but aren't exactly mice. (Read more about this topic in Chapter 9.)
- ✔ Palmtop and game consoles generally don't need computer mice.

## *Speakers*

All computers make noise. They hum. They chirp. They warble. But the real sounds a computer makes are possible only through speakers. Sometimes, these speakers are buried inside the console; other times, they're external left and right speakers, just like a stereo.

Fortunately, unlike with a visit to the stereo store, you don't need to bone up that much on computer speakers. Generally, speakers are options for only some types of computers. Even then, your options are Basic, Very Good, and Overpriced. If you're into audio in any way, you'll probably care enough to know the proper terms, so this part of the computer isn't an issue to you. Otherwise, Chapter 11 goes into all the detail you should care to know.

- ✔ All desktop computers have the option of having external speakers. Most computers come with a set of cheapie speakers, though you often have the choice of upgrading to something more swanky.
- ✔ Some laptops have external speaker options, but most laptop computers have tiny built-in speakers, designed merely to scare your seatmates when you play a DVD movie too loudly on an airplane.
- ✔ Smaller, handheld, and palmtop computers lack true speakers, though they do have the ability to beep and bleep and may, in some cases, be able to play music. (The point is that you don't buy that type of computer specifically to hear opera.)
- ✔ Game consoles usually have left and right sound outputs, which you can either plug into a TV or directly into your home stereo.

## *Modem*

Once an option on most computers, modems are now pretty much standard. What they do is allow your computer to use phone lines to communicate with other computers or the Internet. How computers do this is covered briefly in Chapter 11, but that's not important. The issue is that modems are necessary if you want to use your computer to cruise the Internet.

- ✔ Chapter 11 covers everything you need to know about choosing a modem.
- ✔ The type of modem that comes with a computer is the standard dial-up modem. If you plan on using DSL or cable, you must buy a separate modem for that service. In that case, your PC doesn't need a dial-up modem (unless you want to use it as a backup).
- ✔ Dial-up modems are also used to send and receive faxes.
- ✔ Modems are generally included in laptop computers, though some of the less expensive models may not have them. It's best to ask.

## *Printer*

Every computer needs a printer, though the printer itself isn't really thought of as part of the core computer system. That's because,

unlike the other gizmos mentioned in this chapter, the printer is an extra purchase. Even so, that doesn't make it any less necessary.

A printer is used to put information down on paper, to create a "hard copy" of the stuff you see on the screen. That copy is the final result of your computing efforts.

Computer printers come in a variety of styles, sizes, and abilities, all of which are covered in Chapter 22.

- ✔ Most computers need a printer, but keep in mind that printers don't come with computers. You must purchase printers separately.
- ✔ You can share one printer among several computers. You have a number of ways to do this, which are all covered in Chapter 22.
- ✔ You can use a printer with a laptop computer, as long as the laptop computer has a printer connection (a printer *port*).
- ✔ Printers are generally not required for small computers or game machines.

## Scanner

Another optional item that's becoming more and more popular is the *scanner*. It's a device that works like a photocopier, though rather than make a duplicate, the scanner creates a graphical image of whatever you scan, saving that information inside the computer. That's how you can send out all those baby pictures via e-mail.

Scanners aren't a required item, though they're popular and cheap enough that most people toss one in as part of the basic computer purchase.

- ✔ If you're serious about digital imaging, you probably want to get a nice, expensive, feature-laden scanner. Otherwise, any cheap old scanner will do.
- ✔ High-end scanners have options for scanning images at higher resolutions, accepting transparencies and slides, and other options that bring the scanner's price up to the "I'm obscenely serious" level.

## *Network options*

What was once an option for businesses is now a common feature on most computers: the network interface card (NIC) or Ethernet adapter. This circuitry allows your computer to connect to a network of other computers, printers, and even modems.

Although you may not think that a network option is needed on a single computer that you want to use in your home or office, DSL and cable modems now need that network connection to give you high-speed Internet access. That makes it a nice, built-in feature to have.

- ✔ Network options can come in the form of expansion cards, or they're often built into the computer's main circuitry, the motherboard.
- ✔ See Chapter 11 for more information on network options.

## *Peripherals and other expansion options*

The list of devices you can add to your computer system is endless. You'll probably pick up most of these items after you buy a computer, but you may want to have some installed at the time of purchase, especially if they're necessary to run your software.

Anything beyond the basic computer unit (console, monitor, keyboard, mouse) is considered a *peripheral*. These devices expand or enhance your computer and what it can do.

For example, a printer is really a peripheral device. Another common peripheral is a scanner or a digital camera.

Beyond peripherals, *expansion* options are options added to the inside of a computer. For example, you could add a special TV card that lets you view TV or edit videotape on your computer. The possibilities are limitless.

- ✔ Just about anything hanging off a computer's main box is a peripheral. *Peripheral* is a term you can use to impress the people at the computer store.
- ✔ Peripherals are usually found in the domain of desktop computers. Laptops and smaller systems lack the expansion options of their larger cousins.

## Chapter 3

# Computers from A to Z

### *In This Chapter*

- ▶ Traditional PC computers
- ▶ The Macintosh
- ▶ Laptops
- ▶ Handheld and palm computers
- ▶ Game machines
- ▶ Workstations, servers, and mainframes
- ▶ The so-called “free” computers

You think nothing today of having a telephone that looks like Elvis Presley, Mickey Mouse, or the starship *Enterprise*. But 50 years ago? No way! Phones back then were black, heavy desktop models. Some were mounted on the wall, but basically all phones were alike. Choices were few.

Computers don't all look alike any more, either. There are different makes and models, from the ancient, boxy, dinocomputers weighing several tons each to the slender Palm handheld weighing 4 ounces. This chapter provides a swift introduction to the various makes, models, and styles of computers, from A to Z.

✔ Refer to Chapter 2 for information on what the various computer components are.

## *What Is a Computer?*

I suppose in the book *Brain Surgery For Dummies* (Wiley Publishing, Inc.), one of the first chapters is titled “What Is a Brain?” The idea is that not everyone attempting to buy a computer (or slice into a brain) is really all that comfortable with the concept. And that's why *For Dummies* books are written: to remove the fear and put some fun into understanding difficult concepts!



A computer is an electronic device. It consists of two parts: hardware and software. Say that out loud: hardware and software.

The *hardware* is the physical part of the computer: the console plus all the electronics inside and outside the console. In fact, everything described in Chapter 2 is hardware. It's the more familiar part of the computer, but that doesn't make it more important than software.

The *software* is the brains of the operation. It consists of special instructions (programs) that tell the hardware exactly what to do. Unlike hardware, software is tough to describe. Sure, it comes in boxes and lives on shiny disks, but the software is actually the instructions on those disks and not the disks themselves.

When you buy a computer, you're buying both hardware and software. Even though the emphasis is usually on the hardware (IBM-this, Dell-that), it's the software that's more important.

I discuss hardware and software in more detail in Part II of this book (and specifically in Chapter 4). For now, however, know that computers or any number of similar computing devices consist of hardware and software. You need both to have a computer.

## *The traditional desktop computer*

The original IBM PC (see Figure 3-1) is the prototype for all *desktop* computers. The main box, the *console*, sits flat and square on the desktop. The monitor perches on top of the console, and the keyboard sits in front. Despite this historical tradition, most PCs no longer resemble their desktop ancestors.

The most popular computer configuration now is the minitower model, which is like a desktop model turned on its side (see Figure 3-2). The minitower is more versatile than the old desktop style; you can set the console right next to the keyboard and monitor (as shown in Figure 3-2), or you can set the minitower on the floor and out of view.



- ✓ PC is an acronym for Personal Computer. This name comes from the first IBM model, the IBM PC.
- ✓ Before the IBM PC, personal computers were called *microcomputers*. It was a disparaging term because other computers of the day were much larger.



- ✔ The minitower is named that way because the original on-its-side PC was dubbed the *tower* model. Minitowers are more compact than full towers, and they lack much of the internal expansion room found in larger models.
- ✔ Smaller desktop models are still available. They're usually called *small-footprint* computers because the footprint is the amount of space the computer occupies on your desk.
- ✔ Small-footprint computers lack expandability options. For example, if you want AGP graphics, you probably won't find that expansion option in a small-footprint computer case.
- ✔ Some new-model PCs have both the console and the monitor in the same box. These systems don't yet have an official nickname.

## The Macintosh option

Beyond the PC world lives the Macintosh, a popular alternative to the traditional, stodgy IBM-type computers. A Mac (as it's called) is known to be the irreverent computer, usually adored by creative types or people just wanting to be different.

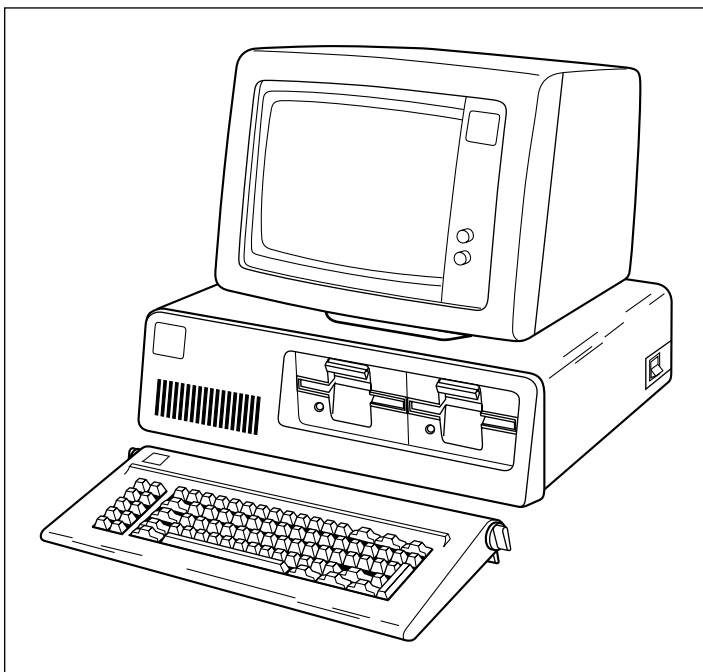

**Figure 3-1:** The original IBM PC.

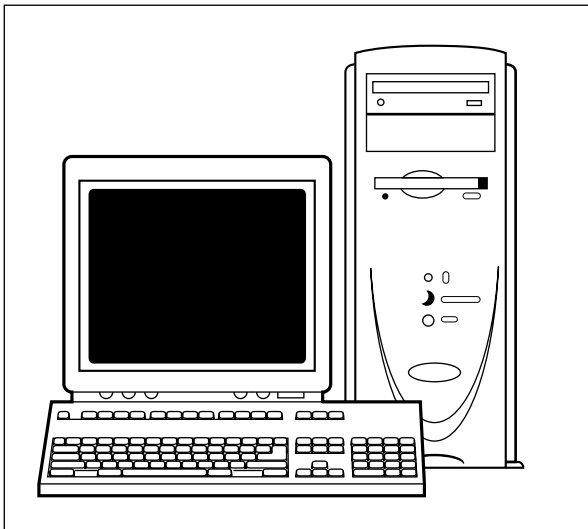

**Figure 3-2:** A present-day minitower computer.

The most popular Macintosh model sold today is the iMac (see Figure 3-3), where the *i* may stand for Internet or Intelligent or any of a number of Interesting things. The iMac is an all-in-one package — monitor and console — and comes with everything you need to get started computing or use the Internet. It's now the top-selling individual computer model.



## Be mindful of the case design!

Although some computer boxes look sleeker than others — and that is a purchase decision — you have to make more practical decisions in choosing a case — noise, for example.

Some case designs are quieter than others. Computers do make noise, mostly from the internal fan. Some manufacturers take care with their designs to make their computers quieter. For example, most Macintoshes make hardly a sound, whereas some mom-'n'-pop custom computers tend to be noisier than a room full of 8-year-olds playing video games.

Another consideration is those translucent cases and colorful computers. You pay a premium for buying those types of cases with your computer. However, many after-market dealers sell fancy computer case upgrades, similar to the after-sale market for car accessories.

A more powerful and expandable alternative to the iMac is the G4 Macintosh (see Figure 3-4), which is more on par with a high-end minitower PC. This Mac model is much more expandable than the iMac, which makes it well-suited to “power users.”

- ✔ Truly, the iMac is the easiest computer to set up and use.
- ✔ Generally speaking, the Mac excels at doing graphics and music. Most graphics production facilities use Macintoshes over PCs. In Hollywood, the Mac is the most popular computer model for just about everything.
- ✔ There is a myth that Macintosh computers are more expensive than your typical PC. Although on a dollar-per-dollar basis, this statement is true, it is *not* true when you compare a Mac with an equally equipped PC. In that case, the Mac is a bargain.



**Figure 3-3:** The iMac.

---

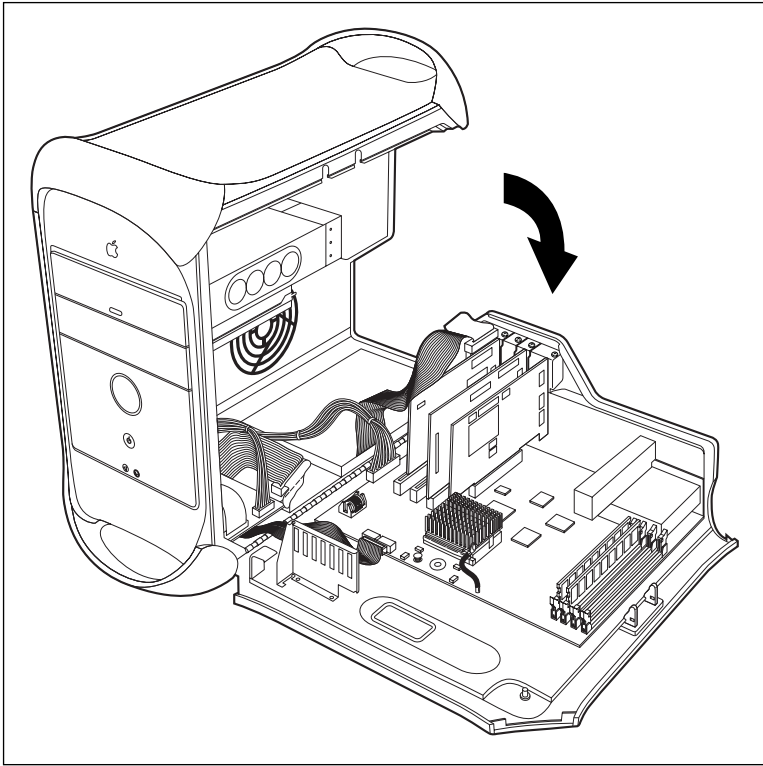

**Figure 3-4:** The G4 Mac displaying its guts.

## *Laptops for every kind of lap*

Portable computers are available for people on the go or anyone who wants a smaller computer than the traditional desktop model. For example, if you take your work home with you, it's just easier to have a laptop you can lug back and forth than to try to share information between home and office computers.

Laptops have the same features as desktop computers, but smaller. Figure 3-5 shows a typical PC laptop, which has everything a desktop PC has but all shoved into the space of a typical notebook. Because of their smaller components, laptops usually run more than twice the cost of a comparable desktop system.

On the Macintosh side, the PowerBook is the laptop of choice (see Figure 3-6). It's essentially a G4 Macintosh all crammed into a tiny space. Also, the iMac type of laptop is a lower-end model called the iBook. Unlike desktop Macintoshes, the laptop versions are very price-competitive with PC laptops.

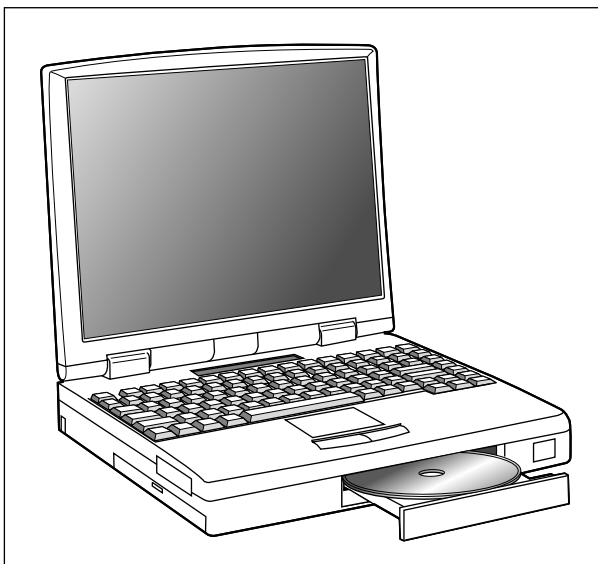

**Figure 3-5:** A typical PC laptop.

---

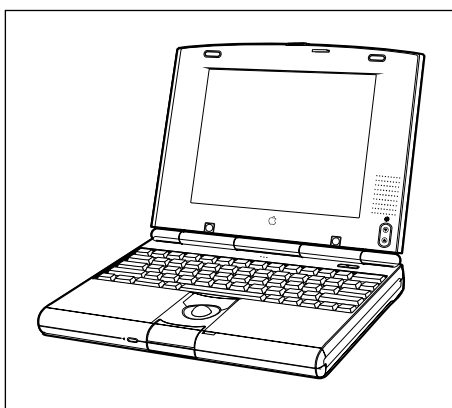

**Figure 3-6:** A Macintosh PowerBook.

---

- ✓ Laptop computers are also known as *notebooks*. (In the olden days, the term *notebook* implied a lightweight laptop, but all laptops are now light enough to be notebooks.)
- ✓ I don't generally recommend laptops as your first computer purchase. Even so, in some circumstances a laptop will suit you far better than a desktop can.
- ✓ Also see Chapter 12, which covers the issues involved with buying a laptop computer.

## Where does Linux fit in?

Linux is an operating system, or software. It is not a brand of computer. Even so, if Linux is to be found on a computer, it's most likely to end up on a PC. Some custom-made computers have Linux pre-installed. But, generally speaking, most Linux users have standard PCs.

You can also run Linux on the Macintosh, though that's rather rare. Because the standard Mac is more expensive than the typical PC, most Linux users save money and use PCs for their hardware rather than the more expensive Macs.

## *Palmtop computers*

The most recent rage in computing is the palmtop system. In this case, the typical computer and its monitor are shrunk to wallet-size (men's or women's). Yes, these are real computers, but within the ranks of the palmtops, you find a wide variety of types.

The most popular palmtop device is the Palm handheld computer (see Figure 3-7). It's neither a real computer nor an electronic organizer, but more of a "data gatherer." Although you can play games with it, write notes, or doodle, it's more of a supplement to a desktop computer than a full-on replacement.

- ✔ Other palm-size computers are available, though they tend to be along the lines of pocket organizers or often specialty computers that you generally don't find for sale to the public.
- ✔ The Palm handheld is a revolutionary computer because it doesn't pretend to be a miniversion of a full-on computer. It serves as a notepad, address book, and scheduler, and it has lots of unique software. The Palm never pretends that it's a big computer squished into a little box; it does specialized tasks and does them well.
- ✔ The Palm can talk with both Macintosh and PC computers, making it an ideal supplement to a desktop system.

## *Gaming consoles*

Though they're often sneered at by "real" computer owners, gaming consoles are also viable computers in their own right. This was true even back in the days of the early Atari machines. If it has input and output, uses hardware and software, and you can manipulate it, it's probably a computer.

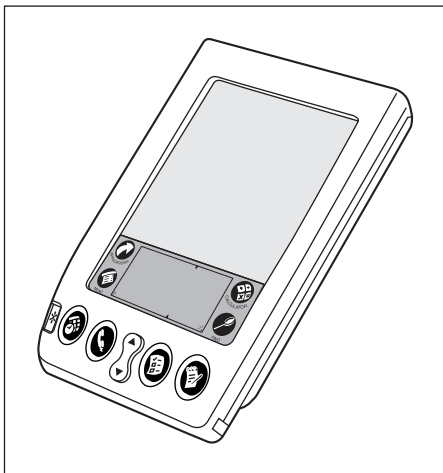

**Figure 3-7:** The Palm computer.

Several manufacturers make home game consoles: There's the Sony PlayStation (see Figure 3-8), Nintendo Game Cube, Microsoft Xbox, and quite a few more. Each of these consoles has lots of technology built into it. Sure, it may not crunch numbers or process words, but it does one thing and does it very well: plays games.

- ✔ As with buying any computer, the key here is *software*. Your choice of one of the game consoles will most likely depend on which games you want to play — not on the technical specs of the console itself. (This lesson is an obvious one for game consoles, but one that people buying PCs and Macintoshes need to learn.)
- ✔ Some game consoles have graphics and computing technology that blow away anything you find in a desktop computer.

## *Workstations and servers*

The term *workstation* is loosely defined when it comes to computers. In one point of view, a workstation is any high-power computer with the latest microprocessor, lots of memory, tons of hard disk storage, and a huge price tag.

Workstations can be targeted to people doing specific tasks that require lots of computing power. For example, you could configure a standard PC with lots of memory and graphics horsepower and stir in the proper software, and you would have a graphics workstation. Or, you could buy a computer made by Silicon Graphics, one that's specifically designed to be a graphics workstation.



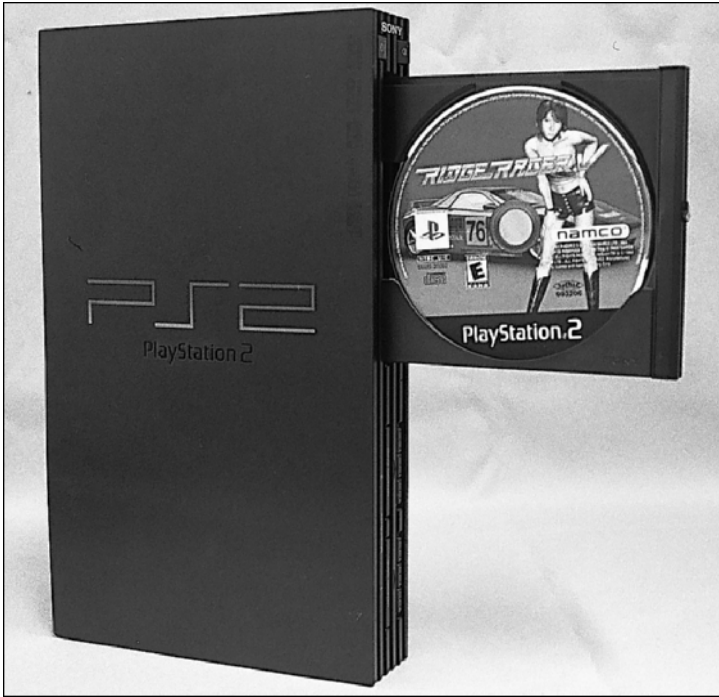

**Figure 3-8:** A game console.

On the other end of the spectrum, workstations can also be dumb old computers. For example, a PC slaved to a network where some minion enters orders is a type of workstation. (The term is vague, but don't blame me!)

Then there is the server.

A *server* is *another* high-end computer that works as the center of a computer network. For example, most large offices (and many small ones) have a central computer called the server (or file server). It contains the programs and information used by all other computers on the network. Again, this computer is a high-end, technology-packed PC or Macintosh that merely runs the network.

- ✔ Silicon Graphics is the company that makes the computers most often used to create computer animation in the movies and on TV.
- ✔ Most readers of this book aren't buying themselves servers. These systems are installed by networking consultants or

professionals configuring an entire office with computers. (The information in this book does apply to servers and to regular computers.)

- ✔ See Chapter 5 for more information on microprocessors.

## Mainframes

The final computer category I describe is the most ancient: the mainframe, or “big iron,” that used to do all the computing work before personal computers became popular in the late 1970s.

- ✔ You can still buy mainframe computers. Unfortunately, the information in this book doesn’t help you choose the proper mainframe for your business (or home, if you’re that eccentric).
- ✔ The typical home computer sold today has far more power than all the mainframes of 30 years ago.
- ✔ Smaller mainframes were known as minicomputers. They were used, for example, to run a small office back in the 1970s and ’80s. As PCs became more sophisticated, they took over the role of the minicomputer.
- ✔ Supercomputer is another classification of computer, though it’s really like a mainframe. A *supercomputer* is specifically designed to do many tasks quickly. Most jobs delegated to the supercomputers of the past decade are now accomplished by a team of regular computers working together.



## “How Much Will This Cost?”

You’re probably curious about how much this machine costs. Honestly, price isn’t important right now. (Refer to the five steps in Chapter 1). Still, you’re probably curious, so why not toss out some numbers?



These numbers have no value until you’re ready to buy a computer. (You understand why at the end of Part III.)

If you want a state-of-the-art computer capable of handling most software, plan on spending about \$1,000, maybe a few hundred less.

Some computers — such as workstations, high-end PCs, or Macintoshes — cost more. You could pay, for example, \$2,000 or higher for the latest computer model with the fastest microprocessor and all that techy stuff.

Then there's the cost of software, which is rarely added into the purchase price. Most people spend as much — if not more — on software than they do on their computer hardware.

There. Now you know. But what does it all mean. . . ?

- ✔ The iMac is about the most affordable computer, considering the technology you get for the price. Ditto the iBook Macintosh laptop.
- ✔ Most laptops cost two to three times as much as their desktop counterparts. The reason? Miniaturization. That huge miniaturizing computer in Utah costs a lot to rent.
- ✔ Most game consoles run between \$150 to \$300.
- ✔ Handheld computers and palmtops run from less than \$100 for the daybook models to around \$700 for the recent stuff. Handheld computers integrated with cell phone technology cost more.
- ✔ Cost should *not* be the most important factor in buying a computer. Keep in mind the five steps from Chapter 1! Software availability, and especially service and support, can affect price beyond what they print in the newspaper.



## The “free” computer

It was the rage back in the late 1990s to sell computers without *any* cost. Yup, they were free. Of course, the computers weren't really given away. You had to pay for them, but you typically got back that much money (if not more) in the form of instant rebate coupons. So the price ended up being nothing.

Nothing is free, of course. So although millions walked away with free computer hardware, they soon discovered that they had signed up for years of not-so-free Internet service. For example, a \$700 computer was “given away,” but the buyer had to pay for Internet service for *four years* at \$20 a month. (That's \$960.)

Despite the long-term contract, people still walked away with “free” computers for months. But consider this: If the computer broke or was lost or stolen or it exploded, those suckers still had to pay \$20 a month for the Internet. Even if they replaced their damaged or lost computers, they still had to pay.

Pay! Pay! Pay!

These scams are rare. Occasionally, you get a deal. But beware of anything “free.” Always check the fine print when you sign up for a service. For any price, being stuck with something you don't need is hardly being free.

## Chapter 4

---

# Introduction to Hardware and Software

---

### *In This Chapter*

- ▶ All about hardware
  - ▶ The microprocessor
  - ▶ Basic PC hardware
  - ▶ All about software
  - ▶ The operating system
  - ▶ How everything works together
- 

**T**he old alchemists believed that everything was composed of water, air, earth, or fire. To me, that means “warm mud,” but on the upside, the alchemists also believed that you could turn lead into gold.

Computer scientists, looking much like alchemists but without the funny hats, believe that all computers are composed of two parts: hardware and software. If you can figure out how those two elements work, you can use a computer to turn silicon into gold.

This chapter covers the basics of all computer systems: hardware and software. You gotta know which is which because one is far, far more important than the other. It’s when you don’t know which is more important that you end up buying a computer that may not be right for you.

## *Hardware: The Hard Stuff*

Computer hardware is easy to identify: It’s anything you can touch. The monitor, computer box (console), keyboard, printer, modem, and the doodads inside the box — it’s all hardware.



- ✔ If you can touch it, it's hardware.
- ✔ If you drop it on your foot and you say "ouch," it's probably hardware.
- ✔ Here's one that baffles most people: Floppy disks and CD-ROM disks are hardware. Even though they store software, the disks themselves are hardware. The software — like music on a cassette tape — is not the hardware on which it is stored.
- ✔ The most important piece of hardware is the computer's microprocessor.

## *The microprocessor (the main piece of hardware)*

All hardware in any computer is geared to work best with a single chip. That chip is the computer's *microprocessor*.

The entire computer, no matter how big it is or who makes it, is designed around a single type of microprocessor. The microprocessor determines the design and potential of the rest of the computer.

In keeping with years of computer industry tradition, microprocessors are given silly names: Pentium, Power PC, Alpha, and Athlon for example. Also, microprocessor names look like numbers: 80386, 486, and 68040. You also see combinations of the two: K6, Pentium 4, G3. The names do have some significance, although they're nothing to fret over now. Just know that Pentium is the name of a microprocessor chip and not some ancient building to visit when you're in Rome.

All the details of the microprocessor are presented in Chapter 5. At this point, all you need to know is that the microprocessor is the most important piece of hardware in a computer.

- ✔ The microprocessor is not the computer's brain; the brain part (if it has any) is the software, which is covered in the latter part of this chapter.
- ✔ The microprocessor is also called the CPU, or central *processing unit*.
- ✔ Some folks call the microprocessor just processor, for short. They're probably the same folks who call McDonald's Mickey Dee's, even though they're not saving any syllables.

## Basic hardware

The microprocessor isn't the computer. Though the type of microprocessor used in a computer tells you a great deal about the computer and the rest of the hardware, the microprocessor is merely the center of attention. Supporting the microprocessor are many other items inside and outside the computer's box. Here's the short list:

✔ **BIOS:** The BIOS ("BYE-oss") is the computer's personality. It rules over the computer's basic parts, such as the printer, keyboard, monitor, and memory. The BIOS exists as a special program burned onto a silicon chip. BIOS stands for Basic Input/Output System. Sometimes it's called *firmware*.

Although the BIOS controls the basics of the computer, it doesn't run everything. For that, the computer needs an operating system.

✔ **Memory:** By itself, the microprocessor doesn't remember much. It's like an absentminded professor: smart and quick but forgetful. To help the microprocessor store information to manipulate, Random Access Memory, or RAM, is used. Chapter 6 discusses memory.

✔ **Bus:** Not one of those big yellow vehicles that took you to school, the computer's bus is a line of communications between the microprocessor and everything else in the computer. Like the microprocessor, the bus operates at a specific speed. You pay more for a faster bus, but you get your money back in improved performance.

✔ **Storage devices:** Computer memory is short-term memory; its contents are erased when you turn off the power. For long-term storage, other devices are used, including hard disks, CD-ROMs, floppy disks, and other media and storage devices. Chapter 7 covers this topic.

This basic hardware lives inside the console for the most part. Other basic hardware surrounds the computer, like supplicants worshipping a shrine: the monitor, the keyboard, the mouse or pointing device, the printer, the modem (which is sometimes inside the console), and other gizmos.



All this stuff is hardware, and all of it works with the microprocessor to create the hardware side of your computer system. By itself, hardware is unimportant. Only with the proper software driving everything do you get the most from your hardware.

- ✔ About half the computer hardware lives inside the computer box, officially known as the *console*. The other half sits outside, connected to the box with cables. In fact, cables are a very big and ugly part of any computer — something they don't show you in the ads.
- ✔ Refer to Chapter 2 for information on specific pieces of hardware in a computer system.
- ✔ Some external devices are called *peripherals*. For example, the printer is a peripheral. Although the keyboard and monitor could be considered peripherals, they're too important to the computer's basic operation to be called that. (It's a subject for semanticists and college professors to debate.)

## Software, the Other Hard Stuff

*Software* is the brains of the operation. Some people claim that the microprocessor is the computer's brain. No. No. No. No. No. The microprocessor is just a big, flat, expensive piece of technology — like a Keebler fudge cake with metal legs. You need software to make the microprocessor seem like it has any sort of intelligence.

### *The operating system*

The main piece of software controlling your computer is the *operating system*. It's the operating system — not the microprocessor — that tells the whole computer what to do. All hardware, including the microprocessor, must obey the operating system. And all software must work with the operating system.

The operating system has three important jobs: control the hardware, control the software, and give you (the human) a way to ultimately control everything yourself.

**Control that hardware!** The operating system tells the computer what to do and how to do it. Although the microprocessor inside the computer may be doing the work, the operating system is giving the orders.

Closely linked to the operating system is the BIOS (see the section "Basic hardware," earlier in this chapter). The operating system gives instructions, in the course of its duties, to *both* the microprocessor and the BIOS.

**Supervise that software!** All the software you use (everything — all the applications, programs, utilities, and games) must work with the operating system. In fact, software is written for the operating system, not for the computer or microprocessor. Only a few games are written directly to the computer's hardware. Just about every other program is designed for a specific operating system.



The key to a successful operating system is a large software base (lots of computer programs that work under that operating system). That base is what makes the traditional operating systems so successful. Even though everyone hated DOS, it could run millions of programs. That's what made it so popular (albeit infamously so).

**Work with humans!** Finally, the operating system has to present you, the person ultimately in charge of the computer, with a reasonable method of controlling things. Most computers now do so using a graphical interface, showing you pictures and images to represent computer concepts.

The operating system has to show you ways to run programs and ways to control the computer's hardware. Chapter 13 discusses various operating system types in detail and shows why some operating systems do this final job better than others.

- ✔ The operating system and the microprocessor must work together to give you the best possible computer. When they work together, they're said to be *compatible*.
- ✔ You'll likely be using only one operating system. Some computers can have more than one, but that's appealing only for diehard hobbyists.
- ✔ Even handheld computers and game consoles have operating systems. They may not be as complex as a desktop computer's operating system, but the operating system is there nonetheless.

## *Applications and other programs*

Like a general without an army, an operating system by itself merely looks impressive. The operating system's army in this case is all the programs you have on your computer, which is how you get work done. (Operating systems merely control things; they don't do any real work for you.)



In the Big Picture, the application programs are the reasons you buy your computer. You find yourself a nice and tidy word processor, which runs under a specific operating system, which requires a certain amount of hardware to help it do your stuff. That's the true chain of command.

## Putting It All Together

Everything in your computer must work together if you ever expect to get anything from it. Operating systems are written toward specific microprocessors, BIOSes, and other hardware. Programs are written toward specific operating systems as well as toward specific hardware. It all works together.

When hardware doesn't work with software, you have an incompatibility. (That's bad.) For example, you cannot run the Macintosh operating system on a PC. Why? Because the Macintosh uses a different type of microprocessor and has an utterly different BIOS. Different hardware and software just don't work together.

The hardware must obey the software. The software must work under the operating system. And everything has to work well with you. And then everything — hardware, software, and you — can all live happily ever after.



- ✔ Remember that *you* are in charge. You pick the software, which then tells you which hardware to get. That's the best way to buy a computer.
- ✔ All the pieces must fit together well for you to end up buying the best computer you can.
- ✔ What's the most important piece (besides you)? The software. That's why Step 2 in the buying process (refer to Chapter 1) is looking for software. When you find it, the rest of the pieces fall naturally into place.

# Part II

# Hardware and Software Overview

The 5<sup>th</sup> Wave By Rich Tennant

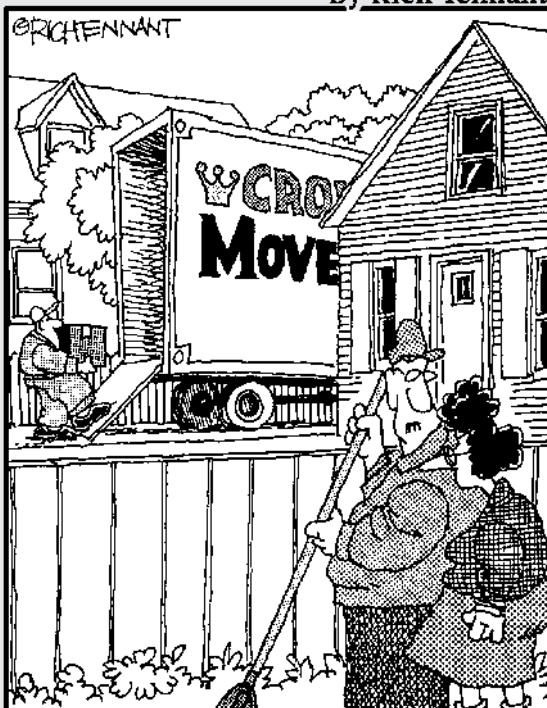

"They both traveled a lot and were big Internet users. Finally, three years and two modems later, they broke up due to insufficient bandwidth."

## *In this part . . .*

**I**t's the software that controls the hardware, which should have been drilled into your skull by now if you've read through Part I of this book. Yet, to understand the buying process, you must first know about some computer hardware. After all, if you buy software that says "16MB on-board 3D graphics RAM required," it helps to know what that phrase means before deciding whether it's for you. It's like being able to understand the destructive effects of water before you buy a boat.

The chapters in this part of the book cover computer hardware and software. This part has three purposes. The first is to familiarize you with various hardware doodads, especially those items you see in a computer ad. The second is to let you know how to buy those items, in case you want to upgrade your hardware and software in the future. The third is to familiarize you with the software and applications that the hardware supports. Read this stuff lightly first and then get into the dirty details later, when the urge strikes you.

## Chapter 5

# All about Mr. Microprocessor

---

### *In This Chapter*

- ▶ Understanding the microprocessor
  - ▶ Judging a microprocessor's speed
  - ▶ Dealing with strange terms
  - ▶ Microprocessor Q&A
- 

**A**t the center of everything in your computer's hardware is the microprocessor. It's your PC's traffic cop, the conductor for a mad electronic orchestra. Because all the other hardware in your computer depends on the microprocessor's capabilities, your computer needs a good, fast microprocessor to make things run smoothly and sweetly.

## *The Microprocessor Rules*

As your computer's main chip, the microprocessor rules over all other hardware in the computer system. Truly, it is the center of the hardware universe: All hardware is geared to perform well with the microprocessor, and all software is written to be understood by the microprocessor.

Knowing how the microprocessor works isn't crucial. More important is being able to compare microprocessors to ensure that you get the best one you can afford in your new computer.

The following sections help you cope with the various measurements of a microprocessor.

### *The name game*

Microprocessors are given unusual names and numbers, much like the various planets they visit on *Star Trek*. Before you understand

anything about a microprocessor, you must know its name. After that, I introduce you to the various yardsticks by which a microprocessor is judged.



- ✓ Another term for microprocessor is CPU, which stands for central *processing unit*. Many ads use CPU rather than microprocessor for space reasons.
- ✓ CPU is also improperly used to describe the computer box, or console. Beware of the double usage when shopping.
- ✓ The microprocessor can also be referred to as a processor.
- ✓ Microprocessors are rarely referred to as Bobby.

## *Families, names, and flavors*

Microprocessors come in families. It works that way because today's computers are based on older models, which used the ancestors of today's modern microprocessors. At the root of these microprocessor family trees are the simple CPUs that ran desktop calculators of the last century.

(Doesn't that seem weird, to use "last century" when referring to something just 25 years ago?)

When the first microcomputers appeared in the late 1970s, they used whatever microprocessors were available. Several firms made different microprocessors at the time, so computer designers picked whatever was available or, more commonly, whatever was cheap. Those decisions made back then have long-stretching consequences that affect which microprocessor lives in your computer now.

It all boils down to two separate families. They are the G3/G4 and Pentium families.

**G3/G4:** All Macintosh computers sold today have either the G3 or G4 microprocessor in their hide. It's that simple: If it has the Apple logo on it, it has a G3 or G4 CPU somewhere inside. Which is which? The G4 is better and more expensive. The G3 is found on only lower-end machines. The G4 is found in the mid- to high-range machines, with some of the upper-end Macs sporting *two* G4 processors. Omigosh!

**Pentium:** All PC computers sold today have some variation of the Intel Pentium microprocessor in their bosoms. Like the G3/G4, Pentium IIIs and Pentium 4 microprocessors are now available. But

beyond that is even more variety in the names and flavors of the Pentium. Table 5-1 lists some details for you. Note that not all Pentium-family chips are called Pentium or are made by Intel. Yet they're all similar enough to the Pentium that choosing one over the other doesn't affect how you run any software.

- ✔ Other microprocessors exist, of course, less common than the Pentium and G4 families. For example, the Alpha (or DEC Alpha) microprocessor is a very fast CPU commonly found on high-end workstations and custom computers. Also, the SPARC microprocessor, from Sun Microsystems, is found on Sun's own proprietary workstations.
- ✔ If the computer is a handheld or laptop, it uses a specially designed low-power version of the desktop microprocessor. The family names and numbers of those chips aren't necessary to know. For those systems, selecting a microprocessor isn't a major consideration as part of your purchase.
- ✔ The original Pentium begat the Pentium Pro, which begat the Pentium II, which begat the Pentium III, which begat the Pentium 4. Software-wise, these chips are all very similar. Hardware-wise, the ones with the higher numbers run much faster.
- ✔ Before the Pentium, PC microprocessors were given numbers. You might hear the terms 486 or 386 tossed around by old-timers. (Of course, in the computer biz, an old-timer might be a 12-year-old.)



**Table 5-1 Microprocessor Madness**

<i>Name</i>	<i>Manufacturer</i>	<i>Notes</i>
Athlon	AMD	The high-end Pentium-compatible microprocessor from AMD; similar to a Pentium 4
Celeron	Intel	Inexpensive Pentium III alternative from Intel
Duron	AMD	Inexpensive Pentium III alternative from AMD
Itanium	Intel	High performance 128-bit microprocessor, generally not found in desktop systems
Pentium 4	Intel	Current best technology for the typical PC
Pentium III	Intel	Still available, cheaper alternative to a Pentium 4
Xeon	Intel	64-bit processor found only in servers

## The measure of power

The power of a microprocessor is measured in *bits*. How many bits can the microprocessor swallow in one gulp? The more bits, the more information (data) the microprocessor is capable of bandying about.



In a way, the number of bits can be compared to lanes on a freeway. If you have only two lanes, too many cars congest traffic, and things slow down. But a six-lane freeway has plenty of room for lots of cars, and traffic flows smoothly.

- ✔ Early microprocessors dealt with only 8 bits or 16 bits at a time.
- ✔ All microprocessors now handle information in 32-bit chunks or larger.
- ✔ The G4 and the Itanium can process information in 128-bit chunks. Unlike the G4, found on high-end Macintoshes, the Itanium is not found in your typical desktop PC. It's used mainly for servers in large computer centers.

## Zooooom! (Microprocessor speed)

The only technical detail most folks pay attention to is a microprocessor's speed. How fast does it go?

Microprocessor speed is measured in megahertz, abbreviated MHz. Faster chips are measured in gigahertz, abbreviated GHz:

$$1,000\text{MHz} = 1.0 \text{ GHz}$$

The higher the speed value, the faster the chip. And, naturally, the faster the chip, the more expensive it is:

$$\text{Fast microprocessor} = \text{Better} \text{ ☺} = \text{More expensive} \text{ ☹}$$

My first Pentium moved along at 90 MHz. That's a heck of a lot faster than my first IBM PC, which plugged along at just under 5 MHz. Today's systems zoom at speeds up to 3,000 MHz or better (3,000 MHz can be more properly written as 3.0 GHz). Tomorrow's chips will move even faster.

Speed, of course, is all relative. Even though some microprocessor speed values may look like they're 5 or 100 times faster than others,

the true speed you get depends on what you do with a computer. For example, a computer with a 2,000 MHz microprocessor “feels” only slightly faster than a 1,000 MHz model. You pay much more for that tiny difference.



✔ Microprocessor speed is also referred to as *clock speed*. It’s just another term for how fast the CPU goes.

✔ Avoid comparing speeds between different microprocessors; the true test lies in how fast the *software* runs. A graphical image may load faster on a Macintosh with a 500 MHz G4 than it does on a PC with a 1000 MHz Pentium 4.

✔ Buy the fastest microprocessor you can afford!



✔ Your brain has a speed rating of only about 2 MHz (not *you* individually — everyone in general). The human brain can do several million things at a time, however, whereas the microprocessor does only one thing at a time, which is one reason that humans consider themselves to be superior to computers.

## Some Microprocessor Q&A

The following common questions crop up when normal people attempt to understand computer microprocessors. The answers provided in this section educate you without converting you into a Jolt-cola-swilling, Doritos-munching computer geek.

### ***“What does ‘[blank] or greater’ mean when talking about a microprocessor?”***

Computer hardware is always developed before computer software. As an example, consider that someone had to invent the bassoon before anyone could write music for it.

To deal with the lag time, software developers take advantage of the fact that older PC microprocessors are compatible with the recent stuff. Software that ran on an archaic IBM PC with an 8088 microprocessor still runs now on a Pentium. (It runs very fast.)

Because of this *backward compatibility*, and seeing how the marketing folks like to ensure that their product is available to the widest



possible audience, software often advertises itself as requiring a “Pentium II or greater” microprocessor. That means your computer needs at least a Pentium II CPU to run the software. Pentium III, Pentium 4, and anything else that came after the Pentium II or is compatible with those chips, also applies. Pentium I or an older 486 CPU? Forget it!



- ✓ The term *386 or greater* is often used even though it has been years since you could buy a computer with a 386 microprocessor. Ditto for *486 or greater*.
- ✓ My nerdy side just wants to blurt this out: Technologically speaking, a Pentium is really nothing more than a very fast 386. Design-wise, the chips operate identically; the latest Pentiums merely sport various speed-enhancing additions.

## ***“Are all Pentium processors the same?”***

Generally speaking, yes. However! If the software specifically requests a certain microprocessor, you *must* go with it. If the software says “Requires a Pentium III running at 800 MHz or better,” you must get yourself that microprocessor *at a minimum*. I hope you get something faster, such as a Pentium 4 or a Pentium III running at a higher speed.

## ***“Should I buy an upgradable microprocessor option?”***

Why isn’t this option a trend any more? Because this option proved to be too expensive and not worth it in the long run. Newer microprocessors can rarely plug into the old microprocessor’s slot. So manufacturers who boast of such a feature are full of hot air.

Another point: Buying a whole new computer is often cheaper than merely upgrading your microprocessor. That way, you get all new computer components built to take advantage of the new microprocessor. And it’s cheaper because PC manufacturers buy microprocessors by the truckload, which means that they are cheap. Buying one microprocessor at a time is expensive.

(Also see Chapter 24, about upgrading your equipment, for more ranting on this topic.)

## “What’s the cache?”

An obscure attribute of a microprocessor is the cache (pronounced “cash”). A *cache* is a storage place. In a microprocessor, the cache is used to store instructions a software program gives the computer. The larger that cache storage area, the faster the microprocessor goes.

You may occasionally see a cache value used in describing a microprocessor. For example, a salesperson may boast that his Pentium computer has a “2MB L2 cache.” This abbreviation means that the microprocessor has two million bytes of memory to help speed it up.

What’s the point? The larger the cache, the better the microprocessor performs. Use the cache size for comparison when you get around to shopping — if you care to; most of the time, my eyes gloss over when salespeople get technical.



- ✓ L2 means “Level two.” You would have to be a scientist in a white lab coat to want to know any more than that. However:
- ✓ Get as much Level 2 cache as possible. If you have a choice between two microprocessors and one has more L2 (Level 2) cache, get the one with more L2 cache.

## “Is the Celeron a good Pentium compatible?”

The Celeron is made by Intel, so it’s the closest thing you can get to a Pentium without the Pentium name. Essentially, a Celeron is a Pentium II with either no L2 cache or a very small L2 cache. This “lack of cache” subtracts significantly from its speed, but reduces the price enough to make it an attractive processor for home systems.

I don’t recommend getting a PC with a Celeron microprocessor unless it’s all you can afford.

## “Should I buy a non-Intel CPU if it saves me money?”

Absolutely. The days of flaky wannabe microprocessors are in the past. Any non-Intel microprocessor will do the job and save you some money. However, if buying an Intel microprocessor will make you sleep better at night, get one.

## “What is Socket 7?”

*Socket 7* is a real, live socket inside your computer’s box into which the microprocessor is plugged. This socket allows you to upgrade your microprocessor later, if you have a Socket 7 computer and buy a replacement Socket 7 microprocessor.

- ✔ I do not recommend upgrading microprocessors, which is discussed earlier in this chapter.
- ✔ There is also the Slot 1 standard, which is an Intel-specific standard for upgrading microprocessors.

## “What’s the ‘heat sink?’”

Because the microprocessor runs so fast, it needs a way to help cool itself off. The computer console’s fan just isn’t up to the job. So scientists designed a *heat sink* to help dissipate the heat generated by the CPU. It works like a fancy hat that sits atop the microprocessor chip, though without a sports team logo.

Some CPUs have, rather than a heat sink, wee little fans attached to them to help dissipate the heat.

## “What is ‘hyperthreading?’”



*Hyperthreading* is a new technology on Pentium 4 microprocessors, and some salespeople may urge you to get these more expensive microprocessors just because of this feature. Don’t bother! No must-have applications now support hyperthreading. Remember that software pushes the hardware. So, in this case, hyperthreading is an expensive option you don’t need (unless you have money to blow).

## “Do computers with dual processors run faster than computers with single processors?”

Again, speed is relative. The advantage of a two- (or more) CPU computer is that the main (*master*) microprocessor can offload some duties to the companion (*slave*) microprocessor(s). That speeds things up, just as having several people working on your house at one time gets the job done faster.



## “What happened to the ‘math coprocessor’?”

A *math coprocessor* is a special companion chip for the microprocessor, kind of like a pocket calculator. Its job is to do mathematical computations, and it's engineered to do them more swiftly than the microprocessor can do on its own.

All microprocessors now have built-in math coprocessors. If your software demands a math coprocessor, you're all set. Only if you buy a used computer do you otherwise have to question whether it has a math coprocessor.

- ✓ The math coprocessor is often called an FPU, or *floating-point unit*. Same thing.
- ✓ All Pentium-compatible and G3/G4 microprocessors come with built-in math coprocessors.



## Chapter 6

# Memory Stuff (Temporary Storage)

---

### *In This Chapter*

- ▶ Measuring computer memory
  - ▶ Sizing up a memory chip
  - ▶ Gauging memory speed
  - ▶ Knowing about main memory versus video memory
  - ▶ Using SIMMs and DIMMs
  - ▶ Understanding memory terms
  - ▶ Filling your memory banks
- 

**T**wo types of storage are in every computer: temporary and permanent. It's like your brain: You can remember lots of things right away, using its temporary storage. But unless you commit the information to memory, you had better write it down, which is permanent storage.

In a computer, temporary storage is provided by memory, or RAM (Random Access Memory). The more RAM your computer has, the smoother it operates and the more information you can “play” with at once. How much RAM you need in your computer is covered in Part III. For now, this chapter offers an introduction to computer memory and its associated terms, jargon, and folderol.

## *Say Hello to Mr. Byte*

With videotape, the storage unit is a minute. You buy a videotape that records, for example, 120 minutes of stuff. The gas tank in your car stores fuel by the gallon. The storage unit for beer is the

12-ounce can. You don't buy 72 fluid ounces of beer; you buy a six-pack. In a computer, the basic unit of storage is a *byte*.

What a byte is and how it works aren't important. What's important to know is what a byte stores:

One byte stores one character of information.

The word *byte*, for example, contains four letters, or four characters. A computer uses 4 bytes of storage to store that word. The word *closet* requires 6 bytes. The indented sentence before this paragraph requires 45 bytes of storage, which includes all the letters, the spaces between the words, and the period at the end of the sentence.

To make a large number of bytes easy to describe, modern scientists have stolen some ancient Greek words: *kilo*, *mega*, and *giga*, which sound like bad guys the Power Rangers would fight, but are really terms used to describe the size of something. Bytes are measured in these terms:

- ✔ **Kilobyte:** 1,024 bytes, or about a thousand bytes
- ✔ **Megabyte:** 1,048,576 bytes, or about a million bytes
- ✔ **Gigabyte:** 1,099,511,628 bytes, or about a billion bytes

These terms are used to describe both temporary and permanent storage in a computer — how much room you have for the stuff you create. It's okay to round these oddball numbers to the nearest big numbers. From now on, that's what I do:

- ✔ **Kilobyte:** 1,000 bytes
- ✔ **Megabyte:** 1,000,000 bytes
- ✔ **Gigabyte:** 1,000,000,000 bytes

To give you a better understanding, think of a kilobyte of storage as enough room to store all the text on this page (about half a page of single-spaced typewritten text). That's 1,000 characters — a *kilobyte* of storage.

A *megabyte* is one million bytes of storage. That's enough room to store a novel, several pictures of your cousin's family (including the dogs), or about one minute of recorded music.

A *gigabyte* is an awesome amount of computer storage — one billion bytes, or 1,000 megabytes. Rarely does any single thing require a gigabyte of storage. Instead, you use gigabytes to store the multiple-megabyte files you and your computer collect.

You need to know about these sizes because two types of computer storage use them for measurement: the computer's memory and the computer's disk storage.



- ✓ A byte stores one character.
- ✓ One thousand bytes are in a kilobyte (“KILL-uh-bite”). The abbreviation for kilobyte is K or KB.
- ✓ One million bytes are in a megabyte (“MEG-uh-bite”). The abbreviation for megabyte is M or MB.
- ✓ One billion bytes are in a gigabyte (“GIG-uh-bite”). The abbreviation for gigabyte is G or GB.
- ✓ That’s “GIG-a-byte,” not “JIG-a-byte” or “giggle-byte.”
- ✓ Beyond the gigabyte is the *terabyte*, which is one trillion bytes of storage. Outrageous? Perhaps. Consider, however, that having a computer with a 40GB hard drive today would have been considered outrageous just ten years ago, when 40MB hard drives were the rage.
- ✓ Twenty-four cans of beer are in a case, and 24 hours are in a day. Coincidence?

## Memory Madness

After measuring memory in bytes, you come to the nitty-gritty of things. Enough memory terms are out there to boggle any first-time computer user. Normally, no one would care. The terms used to describe memory are technical, like lots of things in the computer, but advertisers seem to *love* the terms, so they pop up all over.

The following sections help you sift through what’s important and what’s not when it comes to memory.

### *Behold the chip!*

There must be a law somewhere that says “Chip is an inefficient term for describing anything.” Look at your grocery store: The chip section is divided into regular potato chips, flavored chips, corn chips, tortilla chips, and even anti-chips, like those puffy cheese things. Computer memory is similar.

Computer memory comes in the form of chips. But because of some weird scientific mumbo jumbo, you need eight or nine chips for them to be useful in a computer. Those eight or nine chips create a *bank* of memory.



- ✔ There are no nacho-cheese-flavored memory chips.
- ✔ RAM chips are rarely sold singularly any more. Instead, they're soldered together in groups of eight or nine, which is covered in the section "Goodbye, Mr. Chips!" later in this chapter.
- ✔ Memory chips are RAM chips, though other annoying terms exist. See the section "Some technical memory terms," later in this chapter.

## *The size of the thing (capacity)*

Though each memory chip is about the same size, what's really important is the chip's *capacity*. How many bytes of RAM are in that single chip?

RAM chips come in several sizes, from tiny 1-kilobyte chips to chips that can store 256MB or more, all in one little package. Obviously, the more memory, the more expensive the chip.

Which do you need? It depends on your computer and how it's set up, which is covered later in this chapter.

## *Fast memory and faster memory*

In addition to its capacity, computer memory is gauged by its speed, similar to a microprocessor. With memory, the speed is measured in *nanoseconds* (abbreviated *ns*), or billionths of a second.

Here is one nanosecond: 0.000000001.

Whew! That's fast.

You may see a RAM chip advertised as 6ns. That means the memory hums along at six nanoseconds.

- ✔ The speed describes how fast the memory can be accessed. This speed depends on your computer's configuration; adding faster RAM chips to a slow PC does not (unfortunately) perk things up.
- ✔ Memory speed is not seriously important when you buy a computer. The dealer installs whichever memory works best in that system. Memory speed becomes an issue when you buy *more* memory for your computer. The speed of that additional memory should match the speed already used in your computer.



- ✓ Again, the faster the memory, the more you pay for it.
- ✓ Another aspect of RAM speed is how fast the computer's bus runs. High-end PCs may have a bus speed of 133 MHz, and other PCs may plod along at 100 MHz. You need to match the RAM speed with the PC's bus speed — though this is a more technical aspect handled by the manufacturer or computer dealer than a choice you must make.

## Goodbye, Mr. Chips!

To make handling the chips easier, memory manufacturers solder a whole bank of chips together on a single tiny strip of fiberglass about the size of a pocket comb. That strip is called a DIMM, as shown in Figure 6-1, and it does, indeed, make up one whole bank of memory. This is very handy.

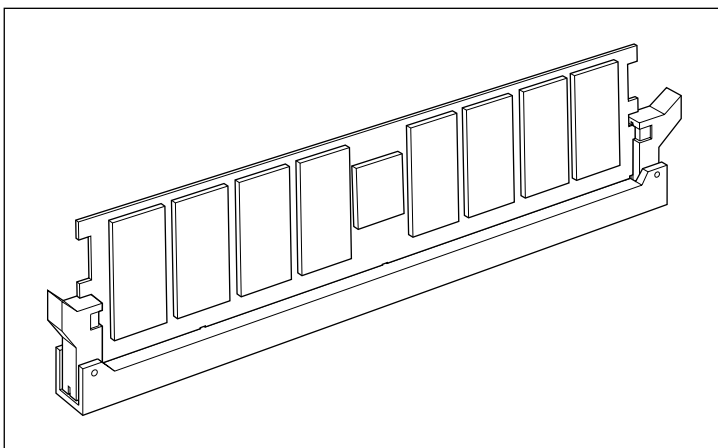

**Figure 6-1:** A typical RAM chip.

Like individual memory chips, DIMMs are described by their capacity (the amount of RAM they have) and their speed. A third measurement is the number of *pins* the DIMM has.

DIMMs plug into a special slot inside the computer's case. Some slots have 72 connectors, some have 168, and some have other oddball numbers. These connectors are called *pins* even though they aren't really pins. If you ever upgrade memory, you need to ensure that you get the proper number of pins on a DIMM to match your computer's needs.

- ✔ DIMM stands for *dual in-line memory module*.
- ✔ A special type of DIMM is the SODIMM (or SO-DIMM), where the SO stands for Small-Outline. These supercompact memory modules are for use in laptop computers and other high-end PCs.
- ✔ Before the DIMM was the SIMM. You may still find one of these on an older computer. SIMM stands for Single Inline Memory Module.

## *Some technical memory terms*



Memory isn't simply referred to as memory. Just when the computer industry reaches the point where memory can be just "memory," they invent a new type of memory. So along comes a new acronym or technical description to distinguish the New Memory from the Old Memory. Ugh.

Honestly, the only places you see these terms are in memory ads. In the real world, even engineers just call it RAM or memory. The rest is all scientific fluff that makes good (or bad) ad copy:

**DRAM:** Another term for RAM. Pronounced "DEE-ram," it stands for Dynamic Random Access Memory. It's more impressive than RAM, I suppose, but not as impressive as SDRAM or EDO RAM. Whoa! No way!

## What is flash memory?

*Flash memory* is a special type of memory chip that retains its information even when the computer is turned off. Normally, memory (RAM) requires electricity to retain its information. Turn off the power and the contents of RAM go bye-bye (which is why it's important to save information to disk, the computer's permanent storage area).

Flash memory doesn't require electricity to retain its information. It remembers things long after the power is off. For this reason, flash memory is used for special information the computer must remember at all times.

It would be swell if all memory in a computer were flash memory, so you wouldn't have to worry about losing information during a power outage. Unfortunately, flash memory is more expensive and not as fast as regular memory. So you typically find it used as digital camera storage or in other applications where speed isn't an issue.

## What about ROM?

ROM stands for Read-Only Memory. Like RAM, it's another type of memory in your computer. The microprocessor can read ROM just like RAM, but unlike RAM, the contents of ROM cannot be changed. Hey! It's read-only.

When it comes to buying a computer, you have no need to worry about how much ROM is in a computer. All computers come with all the ROM they need.

**ECC:** An acronym for Error Checking and Correction, which can require extra circuits to ensure that memory is being properly written to and read from.

**EDO:** An acronym for Extended Data Out. Whatever that means, EDO is a special type of fast or more efficient memory. Advertisers love the term (primarily because marketing types love three-letter acronyms). Say "EE-doh" RAM.

**FPM:** Acronym for Fast Page Mode, often used with RAM, as in FPM RAM. It's faster. Smarter. Better. Using it implies that the neighbor's dog is ugly.

**Nonparity:** Memory chips that don't use parity, as described next.

**Parity:** Another nerdy term; refers to a self-check that memory chips can perform on themselves every time the memory is accessed. Do you need parity? Maybe. A computer manufacturer decides whether it wants to put parity in its PCs. Other than that information, anything else I could say about parity would put you to sleep.

**PC100, PC133:** Memory designed to work with very fast PCs. This type of memory is necessary only if you have a PC with the PC100 or PC133 or a similar chip.

**RDRAM:** Special Rambus DRAM, which operates at superhigh speeds. Alas, no computer has been built to use this memory. Perhaps it will become more common in the future.

**SDRAM:** *Synchronous* DRAM, a special form of DRAM chip! Basically, it's better memory because of lots of technical things that no one really understands.

**SRAM:** An even faster type of RAM, but not as fast as EDO.

Generally speaking, these terms come and go. Some become obsolete (or worn out). Some new ones may crop up. Sometimes, a manufacturer may rename an older standard to make it sound newer in the ads. Whatever.

## Main Memory versus Video Memory

Memory is used in computers in two places. First, there's main memory, where all the "action" takes place. Second, there's video memory, which is used to help the computer display graphics.

Both main and video memory values are often listed in computer ads. So, for example, you may see a new computer with 256MB of memory and also 64MB of video memory. That means the computer has 256MB of memory in which you can work but an additional 64MB of memory for displaying fancy graphics.

Along with this different type of memory come two utterly confusing memory terms. Often, they are used in ads to describe the video memory in a computer:

**SGRAM:** A special type of video memory. It's just SDRAM (see the preceding section), but the *G* in this acronym stands for Graphics: Synchronous Graphics Random Access Memory.

**VRAM:** Video Random Access Memory, another form of video memory that is probably not as flashy as SGRAM because SGRAM has more letters in its acronym.

Again, this is advertisement-only information. Whenever you see VRAM or SGRAM or any other type of video-RAM-whatever, know that it's memory used by the computer for displaying graphics.



- ✔ Your computer needs both main and video memory. You cannot have one and not the other.
- ✔ Some computers boast *sharable* memory, in which the main RAM is used to supplement video memory. This is often a cheap alternative to stuffing a computer with both types of RAM. Yes, it works. No, I do not recommend such a system — unless graphics or games are *not* one of the reasons you're getting a computer.

## Banks o' Memory (RAM)

Science fiction TV shows typically feature computers with *banks* of memory. Although that term is accurate, it's a poor measurement.

The computer you buy will indeed have banks of memory. The DIMM cards plug into these slots inside the computer. Each slot is known as a *bank*. However, the way your memory is configured in each bank may be important.



When you order your computer, try to get the manufacturer to install all your computer's memory into as few banks as possible. For example, Figure 6-2 shows a setup with four banks of memory. A 64MB DIMM is plugged into each bank, which gives that computer a total of 256MB of RAM — a goodly amount for now, but what about future expansion?

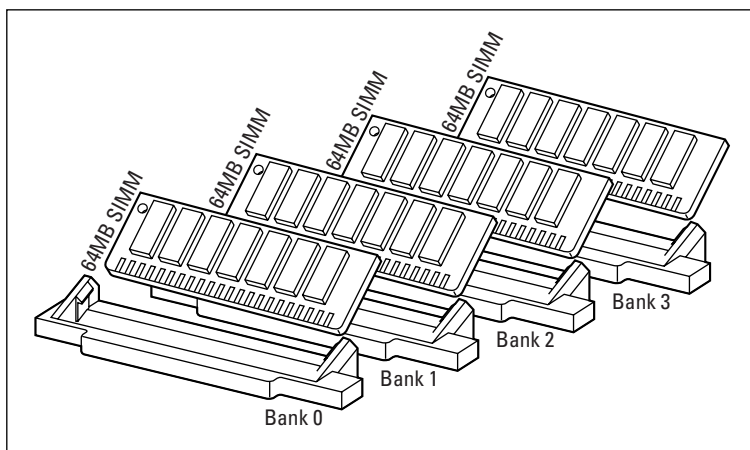

**Figure 6-2:** Memory banks in a computer.

Suppose that someday you want to add another 256MB of memory to this same computer. Sounds good, but because this system has only four banks and each bank is full, you have only one option: Toss out all your memory (for which you paid dearly) and replace it with 512MB of new memory. Yes, that's a waste of money.

A better situation is shown in Figure 6-3: All memory is plugged into one bank. If you want to upgrade, all you need is another DIMM, which plugs into another, open bank. And, you still have more banks available for future upgrades.

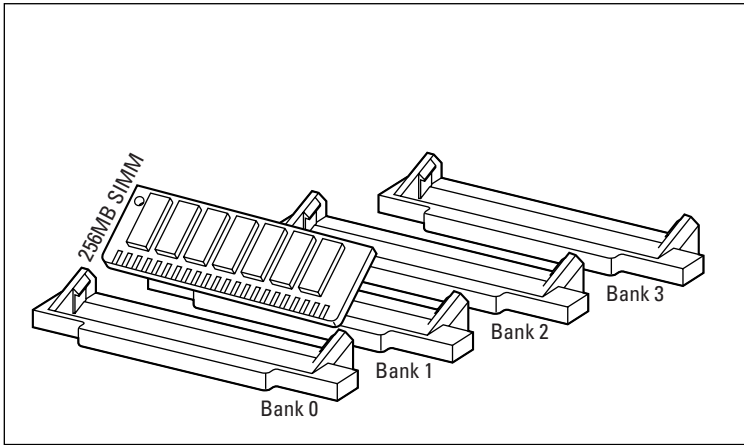

**Figure 6-3:** A better memory bank configuration.

- ✓ Try to have the dealer put as much memory as possible into a single bank.
- ✓ Yes, as you may have guessed, one 256MB DIMM costs more than four 64MB DIMMs. You save money on upgrades, though.
- ✓ Indeed, this information is technical! For example, some computers insist that *all* memory banks have the same amount of memory in them. If you have three 64MB SIMMs in three banks and want to add a 128MB DIMM to the last bank, you can't do it. (Hey! Don't blame me! Beat up an engineer!)



## How Much Memory Do You Need?

How much memory will your new computer need? The answer depends on your software. The bottom line is that you need memory (or RAM) in your computer.

Memory in your computer is measured in *megabyte* units. The standard quantity for most new computers is 128MB of memory, or RAM. Some come with more memory, typically 256MB.

Some inexpensive computers may have only 64MB of RAM — or less. Avoid them. Windows XP barely runs in 128MB. It needs 256MB.



Watch out for computers advertised with no memory or 0K or 0MB of RAM. This sales ploy makes a computer look cheaper than other models sold with memory included. All computers need memory, so you have to pay for it one way or another.

## Chapter 7

---

# Disks of Every Type (Permanent Storage)

---

### *In This Chapter*

- ▶ Understanding disk storage
  - ▶ Knowing the different types of drives
  - ▶ Judging a drive's speed and capacity
  - ▶ Controlling a disk drive
  - ▶ Choosing drives for your computer
  - ▶ Surveying various types of drives
  - ▶ Adding a Zip drive
- 

**A**fter the microprocessor and computer memory, the next most important element in your computer is permanent storage, or the disk drives. Most computers have several different types of disk drives, each of which is useful for some specific task. This chapter sifts through the spinning pile of disk information, pointing out what's necessary and offering background information to help you read the various advertisements and make sense of them.

## *Why Disk Storage?*

*Disk storage* is the second type of storage inside a computer. The first type is memory, or RAM. That's where the work takes place; the microprocessor busies itself there, running programs and storing all the wonderful stuff you create.

When you're done working, you need a more permanent place to store your stuff in the computer. That place is on a disk drive somewhere, usually the *hard drive*. You direct the program you're using to "save" your stuff on the hard drive, making a permanent copy you can use later.





- ✔ All computers need disk storage. Some computers even have several forms of disk storage: a hard drive, CD-ROM drive, and floppy drive. Each of these has specific uses, as covered later in this chapter.
- ✔ Some handheld computers don't have physical disk drives. Instead, they contain special memory that isn't erased when the power is turned off.
- ✔ Don't confuse the terms RAM (or computer memory) and disk memory. Some computer manuals and books may refer to disk storage as disk memory. Although this term is technically correct, it's confusing. Disk storage and RAM are two different places in a computer. Whenever you see the term disk memory, just think disk storage instead.
- ✔ For more information on microprocessors, see Chapter 5.
- ✔ Computer memory (RAM) is covered in Chapter 6.

## *What is a disk, and what is a drive?*

There are hard disks, hard drives, and hard disk drives. What's the difference? Nothing, of course.

The *disk* is literally a disk. The computer writes information to the disk, where it is stored exactly like information is recorded on a cassette tape, only the disk media is flat and round.

The *drive* is the device that spins the disk, reading and writing information.

So a disk drive is the entire unit. Inside a typical computer, you find several disk drives: a hard disk drive, a CD-ROM disk drive, perhaps a DVD disk drive, and a floppy disk drive. Each of those devices is the drive, and the thing that stores the information is the disk (see Figure 7-1).

- ✔ The most common abuse of the terms disk and drive comes when referring to a hard disk drive. It can be called both the hard disk and the hard drive. Because it's all contained in the same unit, both terms are correct.
- ✔ For other types of drives (CD-ROM, floppy, Zip), the disk is removable. Therefore, there really is a difference, for example, between a CD-ROM drive and a computer CD; the CD is the disk and the CD-ROM drive is the device that reads information from the disk.
- ✔ Don't mind the technical terms used so far! They're all explained later in this chapter. Just keep reading.

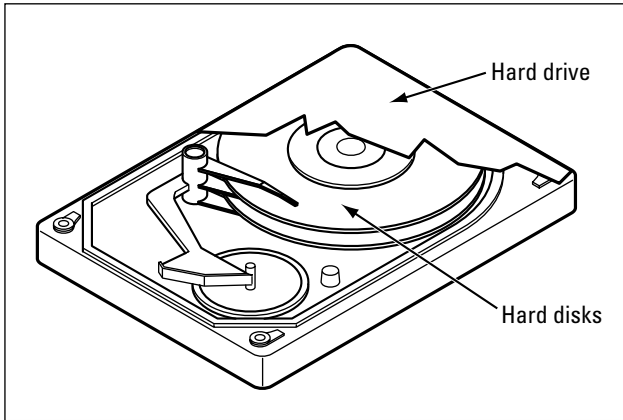

**Figure 7-1:** A run-of-the-mill hard disk drive.

## *Types of drives*

Many interesting and unusual types of disk drives are available for any computer. Most commonly, you find these three types of drives:

**Hard drive:** The standard, high-capacity, high-speed drive found in all computers, desktops, and laptops. This is the main form of disk storage.

**CD-ROM:** Nearly all computer software comes on CD, making a CD-ROM drive part of all standard desktop and laptop configurations. The CD-ROM, however, is a *read-only* medium; you cannot save information to a standard CD.

**Floppy:** The original computer disk drive, though floppy disks are rapidly falling out of fashion. Some software still comes on floppy disk, and you can save your stuff to a floppy and mail it, but beyond that, today's large files are just too big for floppies. For this reason, several new models of computers don't come with floppy drives; however, most computers still sport them, and I think that it's a good idea to have one.

The following drives are becoming more common and may someday exist on all PCs as a new standard:

**CD-R, CD-R/W:** The same type of drive as a CD-ROM drive, but this drive also allows you to create your own CDs, either data CDs or music CDs. Most of these drives read and write both CD-R and CD-RW disks. Also called a CD-R/RW drive.

**DVD:** Looking like a CD-ROM drive, and capable of reading computer CDs, a DVD drive is also capable of reading DVD data disks and playing DVD movies. The disks store 4 to 16 times as much information as a standard CD, making them the CD-ROM drive replacement for the future. These drives may also be called DVD-ROM, though plain old DVD seems to be most popular.

**DVD-R, DVD-RAM, DVD-RW:** Like a CD-R drive, but these DVD drives let you record your own DVD disks. Note the multiple formats here; the industry has not yet settled on a standard type of recordable DVD disk.

**Zip:** A common supplement to the floppy disk drive is the Zip drive. Zip drives read Zip disks, which can store anywhere from 100 to 750 times the amount of information on a typical floppy disk. Someday, the Zip drive may replace the floppy drive.

Even more types of drives and storage options are available. Here's the incomplete list:

**SuperDrive:** The Apple term for this combination CD-R/RW and DVD-R drive is SuperDrive. Other names are probably used as well, but it's essentially the same type of combo drive.

**SuperDisk:** Once known as an LS-120 Super Floppy, this disk can record up to 240MB of information on a disk the same size as a standard floppy disk. It's more of a Zip disk competitor than anything else.

You can find more information about each of these drive types later in this chapter.

Even more types of storage exist, though they're typically for special purposes and not sold with the standard computer setup. For example, there are various removable hard drives, magneto-optical drives, Jaz drives (like a big brother to the Zip drives), and other specific drives. Knowing whether you need one depends on what you do with your computer. Generally speaking, if you're in one of the specific areas of computing where those types of drives are used, you know about it. Otherwise, forget the weird drive types.

## *Capacity*

The first measure of all disk drives is how much information they store. As with computer memory, the measuring rod of disk storage is the byte.

Table 7-1 lists the storage capacities of the common, popular types of disk drives.

<i>Drive Type</i>	<i>Storage Capacity (per Disk)</i>
Floppy	1.4MB
Zip	100MB, 250MB, and 750MB
CD-ROM, CD-R, CD-R/W	Up to 720MB
DVD-ROM	Up to 8GB (16GB on two sides of the disk)
Hard drive	Up to 100GB (and even higher)

The only figure you really need to pay attention to is for hard drive storage. Hard drives don't come in standard sizes. Instead, you find hard drives that store anywhere from 20GB of information on up to a whopping 100GB and higher. You pay more for more storage or less for less. You want to ensure that you get more storage than you need so that you don't run out.



- ✓ Remember that a megabyte is one million bytes and a gigabyte (GB) is one billion bytes (or 1,000MB).
- ✓ How much storage capacity do you need? That depends on your software and how you use the computer. This book shows you how to calculate the exact amount and then add a bit more so that you don't run out of disk storage.
- ✓ If you're not satisfied with the preceding information tidbit, consider that I would have at least a 20GB hard drive minimum in a new computer.



- ✓ Disk storage is relatively cheap. Buy more than you need if you can afford it.
- ✓ Even if you do run out of disk storage, most computers have room to add a second hard drive internally, giving you even more storage.

## *Hard drive speed*

The faster the disk drive, the faster you can read information from that disk drive. Faster is definitely better. And, naturally, the faster it is, the more expensive the disk will be. Speed doth have its price. . . .



## Looking for a hard drive deal?

If you have money to throw, throw it at everything. But most of us aren't loaded and have to face some tough buying decisions. Fortunately, I can relate a secret tip to you when it comes to getting a great deal on a hard drive.

The best value for a hard drive comes from the models two or three notches lower than the highest-capacity model. For example, rather than a top-of-the-line, high-capacity 100GB drive, consider an 80GB or 60GB drive as a better value. With the 100GB drive, you're paying more for leading-edge technology. On a dollar-per-megabyte scale, two 60GB drives may end up being a better deal.

Disk drive speed is measured in RPM, or *rotations per minute* — like old stereo records. Remember the 45 rpm and the 33 rpm? How about the old 78 rpm? Well, with disk drives, rpm is measured in the thousands.

If you can afford it, try to get a hard drive that spins at 7200 rpm. That type of drive performs better than one running at 5400 rpm.



Other, technical values are associated with disk drives. Try not to get mired in the access time or transfer rate or anything else. Those values are trivial with respect to day-to-day operations; the differences between them are laughable (unless you're an engineer, of course, and you laugh only at ionization jokes).

## CD-ROM drive speed

Unlike hard drives, the speed of a CD-ROM drive is measured in terms of *X*. For example, you can have a 32X CD-ROM drive or a 40X CD-ROM drive.

The *X* is the number of times faster the drive is than the original computer CD-ROM drive. That drive, which is the same speed as a standard music CD player, was 1X. The next-generation drives could read data twice as fast and were dubbed 2X. And so on and so on.

So, for example, if you see a 32X drive advertised, you now know in your computer buying wisdom that the said CD-ROM drive is a whopping 32 times faster than the piddly old original CD-ROM drive.

CD-R drives have two X numbers, such as 8/12. The lower number is the speed at which the drive can write information. The higher number is the speed at which data can be read. To put this concept in practical terms, to record an hour's worth of music on CD-R that can write at 12X takes you only 5 minutes. (That's 12 times faster than 1X, which takes one hour to write one hour's worth of music.)

CD-R/RW drives have a third X number, which is the speed at which the RW drives are written to. This number is different from the CD-R value because CD-RW disks are written to in a different manner from CD-R discs.

DVDs? DVD-Rs? They don't have X values listed. Supposedly, they're all just fast.

## Cache or buffer memory

Another thing to look for in a hard drive is the cache memory.



The *cache* is a supplemental storage place on the drive, composed of a given amount of memory (special memory, not regular computer RAM). That memory is used to speed up the drive by storing often-read information in the cache memory. Reading the information from cache memory rather than from the disk itself can markedly increase the hard drive's performance.

The larger the cache memory on a disk drive, the better. A minimum, a hard drive should have a 2MB cache. Top-of-the-line models may have as much as 8MB of cache memory. That's good.

- ✓ Cache is pronounced "cash."
- ✓ A hard drive cache may also be called *buffer memory*.
- ✓ Other disk drives may also use cache memory. Again: More is better.

*Bottom line:* The higher the value for cache memory, the better.

## Fixed or removable?

Is your hard drive fixed? Probably. Betcha didn't even know it was broken! Ha-ha.

Oh, my sides. . . .

## Three more confusing disk drive terms

Computer jargon is endless. There's no need, ever, for you to memorize any computer term; as long as you have a computer dictionary handy (like the *Illustrated Computer Dictionary For Dummies*, which I wrote, from Wiley Publishing, Inc.), you become acquainted with any computer term. So don't be surprised when the following disk drive terms visually assault you:

**Form factor:** This is merely a description of the disk drive's size. Each computer console has room for different-size drives. For example, you may have a spare half-height drive bay in your G4 Mac. You would need a half-height drive to fill that bay. That's the form factor in action. (This issue is obviously one you can refer to your dealer.)

**RAID:** This acronym means, basically, a whole stack of hard drives — like a stack of pancakes. Each hard drive mirrors information on the other drives, which means that information is rarely, if ever, lost. This type of hard drive setup is used only in mission-critical applications or for servers. Individual computer buyers need not concern themselves with RAID drives (they're too spendy, for one).

**Head:** In addition to being the froth at the top of a sloppily poured beer, a head on a disk drive is the device that reads and writes information. It's also called a floating head or flying head.

Seriously, a *fixed* drive is one that's mounted inside the computer case, or the console. The drive cannot be removed, other than by taking out a screwdriver and uninstalling the thing.

The opposite of a fixed drive is a *removable* drive, such as a floppy drive, CD-ROM drive, and other drives where the disk actually spits out.

## *The mystical drive controller*

The last description of a disk drive in this chapter is how it connects to the rest of the computer. To do so, it needs an *interface*. That's one of those \$100 business words that means “to talk or exchange information.” For example, “Larry cannot interface with the elevator” means that Larry doesn't know how to push the buttons.

With a disk drive, the interface is how the disk drive itself communicates with the rest of the computer. The interface is merely a clutch of electronics. The disk drive uses the interface to talk with the microprocessor, BIOS, and other interesting parts of the computer.

Fortunately for you, today's hard drives use the standard ATA interface or some variant of it. This means there's nothing more to think about regarding how your hard drive connects to the computer. Whew! That's one less thing to learn, but still know that this *disk drive controller* helps connect the disk drives to the computer's main circuitry, or motherboard.

## *Disk Driving Your Computer System*

When you get your computer, you most likely get three disk drives in it:

- ✓ A hard drive
- ✓ A CD-ROM or DVD drive
- ✓ A floppy drive

That's one fixed disk and two removable disks, which should cover every possible disk drive need you could ever dream up.

The following sections go into more detail about each type of disk device and describe some additional decision-making thought processes and options.

### **Things that fill up a hard drive**

Your computer's operating system takes up room, as do your applications and, of course, the data you create. Generally speaking, such basic things occupy only a small slice of the hard drive pie. Here are what really consumes disk storage:

**Computer games:** These programs take up lots of disk space, thanks to their graphics and sounds.

**Music (MP3) files:** If you're into storing music files on your computer, be prepared for them to take up lots of room. In fact, if this is your thing, consider a PC with *two* hard drives, one specifically dedicated to your music.

**Video:** Worse than music files, video files take up huge amounts of storage. If you're into video editing or just watching, you need lots of room. Again, consider a second hard drive specifically for your videos.





DVD drives can read CD disks, so if your new computer has a DVD drive, you don't need a second CD drive — unless you want one for the heck of it (or want a CD-R/RW drive).

## Picking a hard drive

All computers must have at least one hard drive. You can compare speed and other trivia, but the real meat on the plate is the hard drive's capacity. You want to ensure that your new computer has enough hard drive storage for all your computer software as well as all the stuff you create and store there.

Part III of this book tells you how to determine the amount of hard drive storage you need. Generally speaking, you probably need anywhere from 10GB to 30GB of storage. Most computers are now typically sold with a hard drive within that range, but be aware that you can order a computer with an even larger hard drive. Or, heck, order a computer with *two* hard drives. The manufacturers and dealers are flexible as long as you have the moolah to pay for it.



- ✔ Your computer needs at least one hard drive.
- ✔ Beware! Some shifty dealers may advertise a computer without a hard drive! They do that to knock a few hundred dollars off the purchase price and make their stuff appear competitive. Don't buy anything from those people!
- ✔ Some smaller systems, such as game machines and handhelds, don't require a hard drive. Instead, they use special memory to store information. In the case of game systems, storage sometimes takes the form of memory cartridges, which plug into the game's console.
- ✔ As with memory, you can always add more hard drives to your computer. The only limitation is the space inside *and* outside your computer.
- ✔ Laptop hard drives are very small and very expensive. Generally, you cannot add a second hard drive to a laptop internally, but you can add an external hard drive or use a PCMCIA storage device to expand the laptop's storage capacity. My advice: Get a large hard drive in your laptop in the first place.
- ✔ Avoid buying any computer with less than a 10GB hard drive. Although those smaller sizes were popular a few years back, they're just not beefy enough to hold today's software.
- ✔ The first IBM PC was sold without a hard drive. The IBM PC/XT, introduced in 1983, came with a 10MB hard drive. Yes, that was considered oodles of storage space back then.





## Why worry about hard drive size now when you can upgrade later?

Oops! Bad-thinking department: The whole idea behind this book is that you get the computer you want *when you buy it*. Sure, you can upgrade a computer later. That's one of the nifty things about the computer. Today's computers are easy and inexpensive to upgrade. But if you make the right decision when you buy, you don't have to worry about upgrading later.

For the hard drive, the idea is to buy a nice roomy hard drive when you get your computer, one that will store all your junk for years to come without worrying about upgrading. So do pay attention when, later in this book, you find out how to calculate disk storage. And don't let a dealer sell you short either: Buy all the disk storage you need with the computer. Buy now, not later.

## *Your shiny, removable storage*

The second-most popular disk drive in your new computer is the read-only, removable drive. In human terms: the CD-ROM or DVD drive. Either one is a must on any new system, with the emphasis on getting a DVD drive if you possibly can.

CD-ROM and DVD drives handle read-only media. That means that you can only read from the disks; you cannot store information there, like you can with a hard drive. That may sound like a gyp, but the truth is that lots of stuff you get for the computer is read-only. (If you need to write information, you can always use the hard drive.)

If possible, you can get both types of disk drives, and remember that DVD drives can also read CD-ROM disks.

Another alternative is to get two drives: a CD-R/RW drive and a DVD drive. Or, better, get the SuperDrive alternative, which is a combination CD-R/RW and DVD-R drive that can read and write all the shiny disk formats. It's a very handy and useful option, but expensive.

- ✔ Your computer should come with at least one CD-ROM drive. You need one. The CD-R/RW, DVD, or DVD-R drives are fun bonuses, but you don't really need them to do basic computer work. On the other hand:
- ✔ A great reason to get both a DVD and CD-R/RW drive when you buy your computer is that the manufacturer sets up and



configures everything. If you buy or upgrade after the sale, it's more of an ordeal to get the new hardware to work with your system.

- ✔ You cannot write information to a standard CD-ROM or DVD drive. It's read-only, which is the *RO* in CD-ROM: Compact Disk, Read-Only Memory. CD-R/RW and DVD-R drives can, however, create discs.
- ✔ You buy special disks to use a CD-R/RW or DVD-R drive. Furthermore, special software must be used to prepare a CD-R, CD-R/W, or DVD-RAM disk for writing. The software usually comes with the drive and can be used to create musical or video disks.
- ✔ Oh, yes, you can play musical CDs on your computer (as long as your computer has speakers so that you can hear the music). A special program is required, although it should come with your computer or the operating system.

## *Gotta have a floppy drive too*

The floppy is no longer a requirement for all computers. Apple no longer sells new computers with floppy drives. They are common on PCs, but not really needed. Like Apple, some PC manufacturers have gotten rid of the floppy drive as a standard feature, but even so they still offer the drive as an option, which I recommend. So the floppy, useless as it is, remains a standard doodad on PCs.



## **More DVD suffixes than you would care to know about**

CD-ROM drives are simple. You want to write your own CD with a CD-R drive, where the R stands for *r*ecordable. You want a CD-R you can erase? Get a CD-RW drive, which is *r*ewritable. It's simple — even more so because CD-R/RW drives can do both operations at one time.

On the DVD side, however, is the DVD-R, which is similar to the CD-R. But, alas, that's not the only available option. No, there are also DVD+R, DVD-RW, DVD+RW, and DVD-RAM to fuss over. You see, unlike the evolution of the CD-R, the recordable DVD drive has too many conflicting standards. Aaargh!

At this point, the standards aren't anything to worry about. If you need to create DVD disks, just pick a standard or use whichever standard is recommended by your video software. If compatibility concerns you, you can get a drive made by Sony that — for a premium in price — reads and writes *all* the formats.

The floppy drive has two drawbacks. The first is that its disks store only a paltry 1.44MB of information. That's puny. In the land of the 10GB hard drive, a 1.44MB floppy drive isn't even a percentage.

The second drawback is that the disks are unreliable. If you can get one to work, great. Otherwise, I've plowed through a box of ten floppy disks and found only two my computer could use. That's not good.

Here are some floppy drive issues:

- ✔ You have to buy floppy disks for your floppy drive. Buy disks labeled HD or High Density or "1.44MB."
- ✔ All floppy disks must be formatted before you can use them. If possible, try to buy the disks preformatted (it says so on the box). Otherwise, you have to format them yourself, which you do by using your computer's operating system.
- ✔ If the floppy disks don't format, throw them away!
- ✔ Floppy disks are for convenience only; no one in their right mind stores anything on a floppy disk. You use the floppy disk for copies of things for transporting files between computers, or to create a boot disk to start your computer in an emergency.

## *The Zip disk alternative*

Although a floppy drive may not be entirely useful, the concept is valid: You need a small, formatted, removable disk for your computer, one on which you can write information. Had the computer industry continued developing the floppy drive, it still could be a valid form of removable media. But, alas, the floppy drive was neglected. So replacements have sprouted up, the most popular of which is the Zip drive.

The Zip drive eats Zip disks that can store up to 750MB of stuff on a single disk, which is hundreds of times the information stored on a single floppy. So the Zip disk appears as an option on many computers, one that I recommend.

- ✔ Zip disks come in three sizes: 100MB, 250MB, and 750MB. Each of these sizes corresponds to a certain version of Zip drive. The original drive used only the 100MB disks. The next generation used 250MB and could also read and write to the 100MB disks. The current generation can read and write to all three disk sizes.



- ✔ The Macintosh and PC varieties of Zip disks are different. Though they look alike, the disks *are* different. Make sure that you buy the proper disks for whichever computer system you end up with.
- ✔ Macintosh Zip drives can read both Mac and PC Zip disks. But PC Zip drives cannot read Macintosh Zip disks without some sort of helper software or utility.
- ✔ Don't worry if your computer doesn't come with a Zip disk; you can always add one later.

## Chapter 8

---

# Monitor and Graphics Stuff

.....

### *In This Chapter*

- ▶ Understanding monitors and graphics cards
  - ▶ Gauging a monitor's size
  - ▶ Choosing an LCD monitor
  - ▶ Using more than one monitor
  - ▶ Understanding the graphics adapter
  - ▶ Taking advantage of 3-D
  - ▶ Reading a graphics adapter description
- .....

**C**omputer monitors and graphics get far more attention than they deserve, probably because it's the monitor you see in the store. It's flashy. It's eye-catching. But such a display can be misleading because there's much more to computer graphics than the monitor.

Fortunately, monitors are pretty basic and choosing one isn't that tough. The other part of the computer graphics equation is the video adapter card, which can get a little technical. This chapter helps erase any smudges from your graphical journey.

## *The Graphical System*

All computers have two parts to their graphical system: the monitor and the graphics adapter or controller. They are the inside and outside parts, the part you see and the part dwelling inside the computer box.

The monitor is the part you see, the TV-set thing. Or, in the case of game consoles, it's a real TV. But for most computers, laptops, and handheld computers, the monitor is what displays information.

The graphics adapter is the circuitry that *drives* the monitor, controlling how and where the information is displayed. See? The monitor is the dumb part, requiring another piece of hardware — the graphics adapter — to do the work, kind of like an actor requiring a writer, though without all the glamour and prestige.

- ✔ When you buy a computer, you need both a monitor and a graphics adapter.
- ✔ Laptops and handhelds come with the monitor built-in. However, you can add an external (separate) monitor for use with most laptops.

## The Monitor Part

No personal computer is complete without a monitor. You need one. It's a choice you must make, though some computer models, such as the iMac and all laptops and handhelds, have the monitor included. Otherwise, the monitor is a thing you must select at the time of purchase.

All computer monitors sold today are color. All of them are technically similar with only a few variations (see the nearby sidebar “Mysterious monitor measurements”). The only decisions you need to make about a monitor are its size and whether to go for one of the snazzy LCD displays.



- ✔ My best advice for judging a monitor is to look at it in the store. See whether you like the way it displays colors.
- ✔ Most stores have graphics or animation running on their demonstration monitors. Ask to view a document to better judge the image quality. Is the text crisp?
- ✔ You don't need to buy the same brand of monitor as your computer console. If you want, you can buy the monitor separately, in which case they knock a few dollars off the computer purchase price. Be aware, however, that buying the same brand of monitor is usually cheaper because of volume discounts offered by the manufacturer.



- ✔ Beware of computers advertised without a monitor. Because you need a monitor, you must add its cost to the computer purchase.

- ✔ What you see on the glassy part of the monitor is called the *screen*, or *display*. The term *monitor* refers to the hardware itself.
- ✔ No, you cannot use your TV set as a monitor for your computer. Although TV sets are good for watching TV, their resolution isn't good enough for viewing computer information.
- ✔ A game console is geared for using a TV set as its monitor. This is the only exception to the preceding point.
- ✔ A few handheld computers have monochrome (noncolor) screens, which usually display several shades of gray. For most handheld computers, this is just fine.

## CRT or LCD?

Nothing introduces you to the time-honored computer theme of using three-letter acronyms (TLAs) better than computer graphics. For the hardware, fortunately, only two TLAs are worth knowing: CRT and LCD. These describe the two basic types of monitors now available.



## Mysterious monitor measurements

Oh, I could spend all day muttering over the various technical aspects of a computer monitor. Instead, I've jotted down some terms and descriptions that should help you if the need to know arises:

**Bandwidth (frequency):** The speed at which information is sent from a computer to a monitor, measured in megahertz (MHz). The higher this value, the better (less flickering).

**Dot pitch:** The distance between each dot (or *pixel*) on the graphics screen (measured from the center of each dot). The closer the dots, the better the image. A dot pitch of 0.28 millimeters is really good, and smaller values are even better.

**Interlaced/non-interlaced:** The method by which a monitor paints an image on a screen. An interlaced monitor paints the image twice, which tends to cause the image to flicker. What you want is a non-interlaced monitor, which doesn't flicker (as much).

**Scan rate:** The rate at which a monitor's electron gun paints an image on the screen, as measured in kilohertz (KHz). The higher the scan rate value, the better (again, less flickering).



## Missing pixels

Unlike a CRT monitor, an LCD monitor creates its image by having millions of individual pixels on the screen — like tiny red, green, and blue lights. Although this produces a much sharper, less flickering image than a CRT, the odds are really good that some of the pixels may arrive “dead” on your monitor.

A dead pixel on an LCD screen can be easy or hard to see. I have two on my 18-inch Mitsubishi monitor. They only show up well when the screen is blank; one pixel is green, and the other is red. Normally, however, I don’t notice them. Some of the better monitors don’t have any dead pixels; I’ve yet to see a dead pixel on an Apple LCD display.

How many dead pixels are okay? It depends on the monitor manufacturer’s warranty. For my Mitsubishi monitor, it’s 12 pixels. Any more and I could get the monitor replaced. So if you get an LCD monitor, first check the warranty to see how many dead pixels are considered okay. Then run a monitor diagnostics program to see whether the monitor has, in fact, any dead pixels. (The diagnostics program comes with the monitor.)

CRT stands for *cathode ray tube*, which is the glass part of any traditional TV set or computer monitor. The advantage of CRT monitors is that they’re inexpensive. The disadvantages are that they’re bulkier, taking up a great deal of desk space, they weigh more, and they aren’t as energy efficient as LCD monitors. Still, that “cheap” aspect weighs in favor with most computer buyers, so they go with the traditional CRT monitor.

LCD stands for *liquid crystal display*, which is the new flat-screen monitor that is all the rage. These monitors are essentially the same types that appear on laptop computers, though designed for use with a desktop model. LCD monitors are thin, lightweight, and energy saving. Plus they look very, very cool on your desk. The drawback? They’re expensive! Prices are coming down, and it’s cheaper if you buy an LCD monitor bundled with the computer. But they still cost more than their CRT counterparts.

- ✔ Both CRT and LCD monitors connect to the same type of graphics adapter plug on the back of your PC.
- ✔ Some high-end LCD monitors do sport their own, unique digital graphics adapter. For example, the Apple Cinema Display connects to the digital port on the Apple display adapter (on Apple G4 computers only).
- ✔ Some LCD monitors rotate 90 degrees, allowing you to view them in portrait or landscape modes.

- ✔ The best way to judge an LCD monitor is to view only *text* on the screen. Don't be fooled at the store by fancy graphics displays, which always look stunning. The true test is viewing text, not graphics.
- ✔ Be sure to check the LCD in a variety of lighting situations. Some monitors cannot be seen in very bright lights. Some monitors cannot be seen from far right or left angles.
- ✔ Unlike LCD monitors, most CRTs let you display graphics in a variety of resolutions and color settings. LCDs, on the other hand, typically use only one mode for displaying everything.
- ✔ Be sure to compare LCD versus CRT at the larger aspect ratios. Some larger LCDs tend to lose their color saturation, whereas larger CRTs don't. Only the Apple Cinema displays seem to hold their color punch at higher resolutions.
- ✔ Don't confuse LCD with *flat-screen* monitors. All LCDs are flat-screen. But a few CRTs have flat picture tubes and are advertised as being flat screen. This is not the same as having an LCD monitor, though the flat-screen CRTs do display a nicer image than traditional curved-screen models.
- ✔ Don't get an LCD if you plan on playing computer games! Generally speaking, LCDs are too slow to update for real-time game action. True gamers use only CRT monitors.



## *Judge me by my size, will you?*

Monitors are measured like TV sets: diagonally in inches, as shown in Figure 8-1.

A typical monitor measures about 17 inches diagonally. Low-end models measure 15 and 14 inches diagonally. If you want to spoil yourself, consider a 19-, 20-, or 21-inch monitor. Those sizes are nice, but they also tend to cost as much as the computer itself!

- ✔ Beware! A monitor's diagonal measurement may *not* be the same as its viewing area. On a CRT monitor, the screen size is a few inches smaller than the glass.
- ✔ LCD monitors have a diagonal measurement that is completely accurate; the screen size and image size are the same. Therefore, a typical 15-inch LCD monitor has roughly the same display area as a 17-inch CRT monitor.
- ✔ Large monitors are *very nice*. I bought one on a whim and now have *three* of them!
- ✔ If you're vision impaired, a 21-inch monitor is the answer to your prayers! It shows text nice and big.

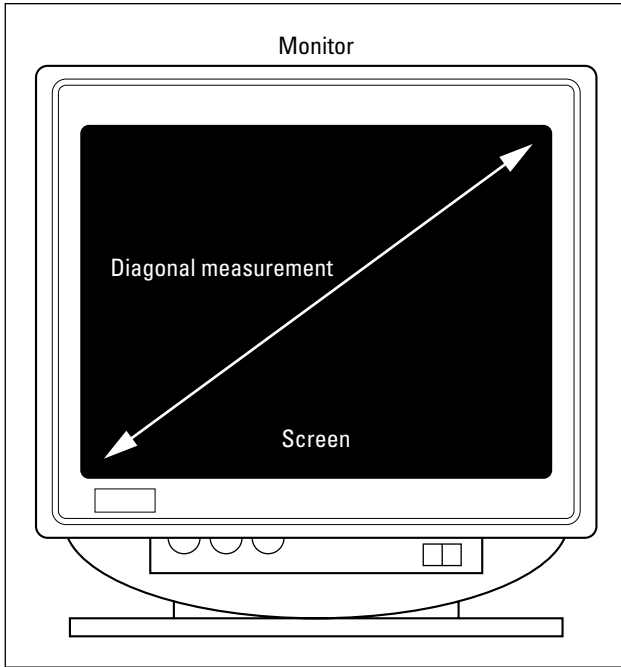

**Figure 8-1:** How the computer monitor diagonal measurement is made.

---

## *I'll take two, please*

Both the Macintosh and PC have the ability to support more than one monitor at a time. The Mac has had the ability for years, but only PCs running Windows 98, Windows Me, or Windows XP Professional can have two or more monitors attached.

Although this feature generally remains a curiosity, having two monitors can really be a boon to productivity: Imagine viewing a Web page on one screen while working on another. (I used to write books on my old dual-monitor PC with the outline on one screen and the word processor on the other.)

- ✔ If you plan to use a second monitor, consider adding it later as an upgrade. Even so, a few dealers offer computer systems with two monitors out of the box.
- ✔ Although you can plug a second USB monitor into the iMac, doing so doesn't let you use both monitors at one time. Because of that, the iMac is an exception to the two-monitor rule. Other Macs, however, can have multiple monitors installed.



- ✓ Each monitor requires its own graphics adapter; however, some dual-monitor adapters run two monitors from a single adapter.
- ✓ Better than two monitors, just consider getting a single large-screen monitor. For example, I had two 17-inch monitors on my old G3 Mac, but a single 21-inch monitor would have worked much better.

## The Graphics Adapter Part

The graphics adapter (or *card*) is the part of your graphics system that lives inside the console. It controls the image displayed on the monitor's screen.

Several yardsticks measure graphics cards. Most are trivial at this stage of the game; computers have become so advanced in the past decade that few graphics cards lack features once considered excessive. Three worthy features remain, however, that you should pay attention to: graphics memory, 3-D graphics ability, and the interface (or how the card communicates with the other parts of your computer).



### Graphics cards for real video

You can't walk into a movie any more without wondering how much of it is computer generated and how much is real. Computer graphics (CG) is pretty common in Hollywood. And on your computer? Real graphics are getting more and more common too.

It's entirely possible to hook your computer up to a videocamera, VCR, or television to record, edit, play, and save your own videos. If that's what you're after, you should consider another few goodies for your new computer.

First, remember that all your hardware requirements are dictated by your software. So, following this book's five steps, you need to first look for your video-editing software. After you find that, the box lists recommended hardware. If any special graphics adapter is required, it's listed.

Second, mostly what you need in order to work with real-life video on a computer is some way to get the video *out* of the computer and into the real world. To make this possible, many video adapters come with *video out* connectors (also called RCA jacks). If video editing is a path you're considering, you should add such a connector to your wish list for a graphics adapter.



Some graphics cards demand a fast microprocessor. Don't trade off by saving money on a cheap microprocessor and then getting an advanced graphics adapter. With some powerful graphics cards, you *need* the fastest, best microprocessor. It says so on the graphics adapters box. Watch out for that.

## Video RAM

Video memory is special memory (RAM) used to help your PC's graphics controller display lots of colors and high-resolution graphics. The more video memory the graphics adapter has, the better your graphics card — and the more expensive.



- ✔ Try to obtain a graphics card that has *at least* 8MB of video memory. A card with 32MB of memory is just grand. More is better, of course. I've seen graphics cards with up to 128MB of graphics memory. Golly!
- ✔ If possible, try to find a card that can be upgraded later — for example, a card with 32MB of video memory to which you can add even more video RAM if necessary.
- ✔ The best way to find out how much video RAM you need? Check with your software! Fussy graphics and game software tell you *right there on the box* how much video RAM you need.
- ✔ Video RAM is called *VRAM*. Refer to Chapter 6 for more memory information.



- ✔ If graphics is your thing — if, for example, you're planning on playing games or working with graphics (not just viewing them) — avoid a computer advertised with “shared graphics memory.” Although that's an okay option for typical computer usage (browsing the Web or word processing), it's not acceptable for anything beyond.

## The 3-D thing

When you work with graphics in a computer, you have two types of applications: 2-D and 3-D. Drawing and painting programs are typically 2-D. The images created are flat, like photographs or paintings. These programs do require graphics oomph from the video adapter, but not as much as 3-D.

Most 3-D graphics applications are games, where the action all takes place in an artificial world where you can go up, down, left, right, back, and forth and get killed by all sorts of interesting creatures.

That requires lots of smarts, so a graphics card with 3-D circuitry is a must. Oh, and some programs let you paint or create in a 3-D graphics environment, minus all the death found in 3-D games.

- ✔ Even a 3-D graphics card doesn't help you much unless you have a powerful microprocessor to assist your software. Check on the software box; typically, the 3-D graphics adapter is only half the equation. It also lists a minimum microprocessor speed and version.
- ✔ Game programmers try to make their software run on as many computers as possible. Even so, there are still a few preferred, or "sweet," graphics adapters a game may run especially well on. If you want to run a specific game, double-check the software to see which graphics adapter the programmer recommends. The difference is worth it.
- ✔ Most graphics cards can do 2-D, no problem. In fact, don't even look for 2-D in the graphics card description; it's often just assumed.
- ✔ If you're into games, make sure that your graphics adapter has support for Microsoft DirectX 9, the latest version of the Microsoft gaming graphics interface.



## *How it plugs in*

A hot graphics adapter may be the most prized part of your computer purchase, but make sure that it can plug into your new computer! The third thing you need to look for in a graphics adapter is its interface. Two types are available:

- ✔ **AGP:** This is the type of graphics adapter you crave. It's meat on the bone! AGP stands for Accelerated Graphics Port, and it's the fastest video interface available. Your computer's motherboard must have an AGP connector to use this type of card.
- ✔ **PCI:** If your computer lacks an AGP, you plug the graphics adapter into a PCI slot inside the computer case. PCI stands for Peripheral Component Interconnect (try saying that while chewing cauliflower). It's still a worthwhile way to connect a graphics adapter to your computer, but just not as good as AGP.

Some computers have built-in graphics adapters. In those cases, you can disable the internal components and add an AGP or PCI graphics adapter (if that type of slot is available inside the box). That's an easy way to upgrade your system without having to use a screwdriver or blowtorch.



- ✓ Not all computers come with an AGP connector on the motherboard.
- ✓ Special, proprietary connectors are also available, such as the digital display connector on Apple G4 computers. Some proprietary connectors may be sold with the monitor.
- ✓ For more information on AGP and PCI, see Chapter 10.

## *Read them labels!*



Sometimes, the way a PC graphics card is described in a computer ad can drive you nuts. You may find Voodoo and Rage and GeForce and other, often strange monikers. Hey! Relax. It's all marketing mustard, a tangy bit of spice spread over the dull circuitry to give the kids something to boast about during recess.

Here are some real-life examples of graphics cards, as advertised in computer magazines and on the Internet:

- ✓ VisionTek Xtasy 6964 (Nvidia GeForce3 Ti 500)
- ✓ ATI All-In-Wonder 128 Pro AGP 4x 32MB
- ✓ TNT2-M64 PCI 32MB video card
- ✓ 3DFORCE4 MX440 64MB SDRAM dual VGA NVIDIA AGP

Yes, those are all real examples (well, more or less). All those random burps and squeaks are describing graphics cards that can plug into a PC or Macintosh computer.

Try to dig through the marketing mustard to pick out some real tidbits of information. For example, notice the 64MB or 32MB in a couple of them? That's video memory information. Also, see the AGP in a few? There's your interface information. Some monikers and numbers are internal only, but sometimes you can gauge pretty well from the marketing slugs what the video card is about:

- ✓ Galaxy 37X Mondo Duplo Diamond Pro V1000

Then again, sometimes you can't. Oh, well. It helps to ask.



Generally speaking, use any values listed for comparison. The more advanced (and expensive) the graphics adapter, the more techy tidbits they can boast about. And, O! They will boast!

## Chapter 9

# Keyboard, Mouse, and Joystick

### *In This Chapter*

- ▶ Selecting a keyboard
- ▶ Getting the perfect mouse
- ▶ Adding a joystick to the system

I enjoy eating at swanky restaurants, but I prefer those types of restaurants that have pictures on the menus. For some reason, the descriptions themselves don't do anything for me: free-range, aioli, confit, twice reduced, and a host of Italian and French words that, to me at least, would mean so much more if there were just simple pictures nearby. But I digress. . . .

Choosing the parts to a computer should be picture-menu simple. Sometimes, they are. For example, most people don't give a second thought to the keyboard or mouse included with a computer. Yet you really do have a choice. Many fancier dealers and manufacturers offer several brands. And you can always buy a better keyboard or mouse after your purchase. This chapter takes you on the tour, complete with pictures.

Oh, and joysticks are thrown into the mix, just 'cause they don't fit anywhere else in this book.

- ✔ The only time you're truly limited in your keyboard or mouse choices is with laptop or handheld computers. With those, you take what they give you.
- ✔ Although game consoles don't have true keyboards or mice, you often do have options for the various controller pads. Alternative pads are available for nearly every game-playing paddle.
- ✔ No matter what type of restaurant it is, nothing irks me more than stone-cold butter. What is it with those people?



## Keyboards

Keyboards allow you to “talk” to your computer. They’re a necessary part of any computer system, and as such, the keyboard usually comes with the computer console right there in the box. You still have a choice, though: Many computer manufacturers give you the choice of optional keyboards, and you can always buy a better, fancier keyboard after your computer purchase.

As an example of a fancier keyboard, Figure 9-1 shows the Microsoft Natural keyboard, which is designed to be easier on your wrists than standard computer keyboards. Keyboards like this one are available for both PC and Macintosh computers.

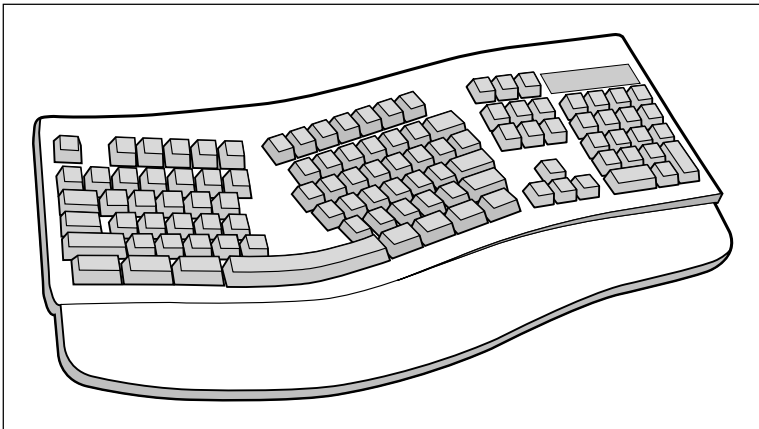

**Figure 9-1:** The Microsoft Natural keyboard.



- ✔ Macintosh and PC keyboards are different. If you’re going to buy a keyboard separately from your computer, make sure that it matches your computer choice.
- ✔ A USB keyboard works with any Macintosh or PC that has a USB port. See Chapter 10 for more information on USB ports.
- ✔ The iMac uses a USB keyboard. If you buy a replacement, make sure that it’s a USB keyboard designed for the iMac.
- ✔ Handheld and palm computers have built-in keyboards or touch pads, which is part of their charm. Even so, if you need to “type” on such a computer, you can get optional keyboards.
- ✔ Game consoles use game controllers (joysticks) rather than keyboards.



- ✔ Aside from ergonomic variations, some keyboards come with special features: built-in speakers, clocks, a USB hub, calculators, and touch pads or built-in mouse-like controllers.
- ✔ Some keyboards come with specialty buttons — for example, buttons to instantly connect you to the Internet or pick up your e-mail. Keep in mind that these buttons are *not* part of a standard computer.
- ✔ Before personal computers became popular, computer terminals had these incredible keyboards. They had the basic keyboard layout on a typewriter and a number of specific function keys. Some terminals even had keys that said Insert Line, Move Block, Close File, and Get Me Cola. These days, computer keyboards are a little more conservative.

## Mice and Other Nonfurry Pointing Devices



A mouse is an input device, like your keyboard, and is required for nearly all of today's graphical software. You can't use your computer without a mouse. For that reason, nearly every computer sold has a mouse in the box — the computer mouse kind.

You can buy two main types of computer mice: optical and mechanical. The optical mouse is better, using an electronic eye to detect movement. Mechanical mice are cheaper, using a rolling ball to determine how the mouse is moving. However, mechanical mice wear out over time.



### Specialty computer mice

The variety of computer mice is seemingly endless. You can choose from cordless mice, pen mice, tablet mice, and a whole host of other mice. See how they run? Ahem.

The most common alternative, or specialty, computer mouse is the trackball mouse. Often called the upside-down mouse, a *trackball* has a large, easily manipulated ball on top; it doesn't roll around on your desktop. Artists and graphical types love this type of mouse because it offers more control over the mouse pointer on the screen than traditional, handheld mice.

Then again, graphical artist types also love the electric pen and tablet, which is more like traditional painting than using any type of computer mouse.

Also available are wireless mice. They help you avoid tangled cords on the desktop, though the mice do need batteries and they're not smooth enough to be reliable for games or intricate graphics work.

- ✔ Just like the keyboard that comes with your computer, if you don't like your computer's mouse, you can buy yourself another one.
- ✔ The standard PC mouse is the Microsoft mouse (see Figure 9-2), though other manufacturers seem to be more creative with their mice, especially Logitech.
- ✔ The current mouse craze is the IntelliMouse, from Microsoft. It has a third button, or *wheel*, between the standard left and right buttons. As with all hardware, however, to make the best use of the IntelliMouse, you need software that works with it.
- ✔ If you go with a wireless mouse, choose the RF model over the infrared. RF works better on a messy desk. Also look for a mouse with a recharging cradle. It not only helps keep the cordless mouse charged, but also helps you find it in a hurry when you need it.
- ✔ There is a difference between the PC's mouse and the Macintosh's mouse — primarily, that the latter has only one button. (However, computer guru Ted Nelson claims that the Mac's mouse actually has four buttons, three of which are on the keyboard.)
- ✔ You can always upgrade to a newer, better mouse after your computer purchase.
- ✔ The plural of *computer mouse* is *computer mice*, though you need only one mouse for your computer.

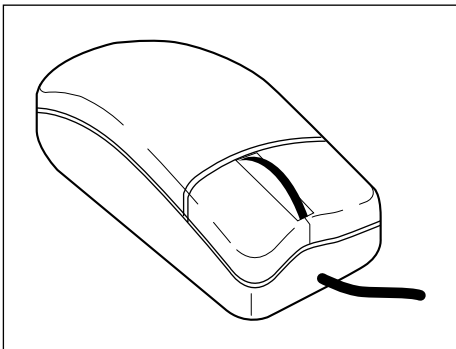
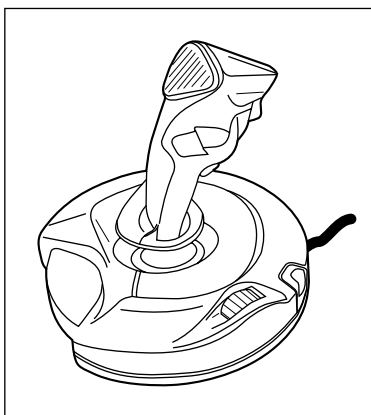

**Figure 9-2:** The standard Microsoft mouse.

## Joysticks and Game Controllers

They look at you funny these days when you call it a joystick. That term just implies too much fun for the serious-minded computer gamer. No, they're *game pads* now, or *game controllers*. Even the early IBM PC documentation referred to the joystick connection on the back of the computer as an “analog-to-digital port.” How stuffy.

The variety of joysticks available these days is almost endless. Gone are the simple X-Y joysticks. Joysticks now look like they belong in a fighter jet rather than on your desktop. They have buttons and buttons, “HAT” switches, swivels, locks and all sorts of amazing doodads to flip, pull, and throw (see Figure 9-3).



**Figure 9-3:** A typical, rather tame type of joystick.

Some joysticks look like car steering wheels, complete with foot pedals. Flight simulator “games” use yokes and sticks. It’s amazing.

Of course, the big question is “Which joystick do I need?”

To pick the perfect joystick, merely look at the back of the software box. Sophisticated games sport a list of recommended joysticks. Buy one of those listed. If you have more than one game that could use a joystick, choose whichever controller is compatible with (or recommended by) both games.



- ✓ A joystick is *not* part of the traditional computer purchase. Generally, you buy it later.
- ✓ Though your computer may have a joystick port specifically designed to connect the joystick, most gamers now prefer the USB brand of joystick over the old joystick-port type.

- ✔ Never rush out and buy a joystick because it's "cool." Confirm that your software works well with the joystick before buying.
- ✔ Not all computer games require a joystick. Many games, in fact, play better using the mouse or a combination of the mouse and keyboard. Quite a few game players become adept at using the keyboard by itself.



## Weird joystick things to look for

Many computer users are serious about games. I know computer gamers who rush out to buy and configure a single PC to play a specific game. They're nuts! But the results are worth it. Plus, they have the inside scoop; so many games have a recommended list of graphics cards, RAM, audio specs, and joysticks that it makes putting such a system together a cinch.

Here are some of the more interesting joystick features you can look for:

**Analog versus digital:** Serious gamers prefer an analog joystick, which offers more real-world response than a digital one. Digital joysticks are gauged in absolute measurements. For example, an old digital joystick may register only eight directions, like the standard eight compass directions. But an analog joystick can point in any direction easily.

**The base:** Some players like to hold the joystick in their hands. In fact, that's the idea behind the game pad: You hold it. But other players like a joystick that sits stable on the desktop. If you want a joystick to stick, ensure that the base is either heavy enough to do so or that it has suction cups or some other method of keeping the joystick secure while you play.

**Force feedback:** Some joysticks and game pads are designed to provide the realistic sensation of resistance as you pilot your spaceship or zoom around the Indianapolis Motor Speedway. For example, the joystick "pushes" against you if you try to take too tight of a turn. Or, if you hit a wall, you "feel" that sensation through the joystick.

**HAT switch:** I'm sure that HAT is a military term and stands for something. Either that, or it's that the HAT switch is typically mounted on top of the joystick, like a hat. HAT switches are used like a joystick on top of the joystick. In many 3D games, the HAT switch lets you "slide" left and right or up and down. Or, it can be used to position a firing reticule on the screen without changing the player's orientation. Whatever the purpose, having the HAT switch is nice.

**Programmable buttons:** Some joysticks come with extra buttons (I've seen more than 16 on a single joystick) that you can assign to specific functions in the game. These buttons come in handy because you can play the game without having to type keyboard commands. Or, by having programmable buttons, you may be able to change the function of many buttons on the joystick, giving you control in a way you're more accustomed to.

## Chapter 10

# Expansion Options

---

### *In This Chapter*

- ▶ Identifying various computer ports
  - ▶ Understanding the versatile USB port
  - ▶ Using various types of expansion slots
  - ▶ Discovering which expansion slots you need
- 

**E**very computer has flashy and nonflashy parts. The flashy stuff (graphics, microprocessors, memory, disk drives, and so on) is easy to discuss. Even an obscure concept like RAM can easily be understood. But computer expansion options? That's a tough nut to crack.

Unflashy as they are, inside your computer and on the console's rump are several connectors, slots, and methods for adding and expanding your computer system. This topic is trivial in that lots of the information is technical, but it's necessary in that you want to ensure that your computer is expandable. That expansion is one of the keys to any computer's success, and you appreciate having those options open to you when the time comes.

## *Connecting Stuff by Using Ports*

When the *Love Boat* is out to sea, it's all by itself. The guest star passengers are left to fall into and out of love, and the goofy passengers are left to provide comic entertainment with Gopher and Isaac. But when the *Love Boat* was in port, it was connected to a larger world where people could shop, mill about, see the cliff divers, and generally communicate with the real world.

In a computer, a port is another place where the computer can communicate with the real world or with other computer devices. A computer should come with a host of *ports*, which are different types of connectors to which a variety of wonderful and exotic devices can be attached.

Here is the list of the most common ports on a computer:

- ✔ USB port
- ✔ Firewire port
- ✔ Printer (parallel) port
- ✔ Serial (modem) port
- ✔ Keyboard and mouse port
- ✔ Joystick/MIDI port

The following sections describe each type of port, whether you need it, or why you would want it.

- ✔ Not every computer needs every type of port. Just a few will do.
- ✔ Another type of port is the network or Ethernet port, in which you plug a network cable. See Chapter 11 for the details.
- ✔ In fact, in the future, computers may just come with one or two types of ports. One of them will most likely be the USB port, which is proving to be quite popular and versatile.
- ✔ Laptop and handheld computers have their own special ports. See Chapter 12 for more information on laptops.

## The USB port

The most popular and versatile port you can have on a computer is the USB port. USB, which stands for Universal Serial Bus, offers a quick and easy method of adding external devices to your computer — plug-in simple, in fact.

The number of USB devices you can add to your computer is almost unlimited. The types of devices are nearly as varied: monitors, scanners, modems, game pads, keyboards, mice, and Zip or Jaz drives, and the list goes on and on.



- ✔ Get a computer with at least two USB ports.
- ✔ Note that some PCs have extra USB ports on the front of the console. Sometimes, these are hidden by a little door. Their purpose? Game controller connection!
- ✔ You can add more USB ports to any computer. A USB *hub* can be purchased to add more ports, or often some USB devices come with extra ports on them.



- ✔ Actually, there is a limit to the number of USB devices you can connect to a single computer: 127. But, hey, that's almost unlimited!
- ✔ On the Mac, you use the USB port to connect your keyboard, mouse, printer, scanner, and any other external devices you may buy; the Mac lacks specific printer, mouse, and keyboard ports that the PC has.
- ✔ The only thing USB doesn't do well is add external disk drives. Although USB disk drives are available, USB just isn't fast enough to do that well. Instead, you have two alternatives: USB 2.0, available on some computers specifically to support high-speed USB 2.0 peripherals, or a port standard known as *Firewire*, which is covered next.

## *The Firewire port*

The Firewire port works much like the USB port: You can use it to connect one device after another, expand your system with Firewire hubs, and even plug and unplug Firewire devices without having to turn your computer off and on. But the true advantage of Firewire is that it's many, many times faster than plain old USB.

- ✔ The Macintosh comes standard with Firewire ports. Not all PCs come with Firewire ports, but you can buy them as an add-on or expansion card.
- ✔ For attaching external disk drives (or any storage), and especially for doing live video, Firewire is a must.
- ✔ Ensure that you buy Firewire peripherals (rather than USB) so that you can use your Firewire port.
- ✔ The Firewire port is also known as the IEEE 1394 port.

## *The printer port*

Shockingly enough, a *printer port* is the hole in the back of your computer where you plug in your printer. That's easy.

- ✔ All PCs have at least one printer port. It's part of the computer console.
- ✔ Macintoshes use the USB port for printing.
- ✔ Handheld computers and game consoles don't need printers.





- ✔ On the PC, the printer port can also be used to connect an external device in addition to a printer. You can use the printer port to add an external disk drive, CD-ROM, CD-R or CD-RW, DVD, scanner, Zip drive, or any number of interesting devices.
- ✔ You can connect only one device to the printer port in addition to the printer. If you want to connect more than one device to the printer or if you have trouble with the printer and the other device on the printer port, you need to get something called an A-B switch. Your dealer can set you up with one, if necessary.
- ✔ The printer port may also be known as a parallel port, EPP/ECP port, or Centronics port. Officially, it's LPT1, which is the old IBM PC designation (and is still used in some remote parts of Windows).

## The serial port

The serial port was the original “versatile” computer port. Used primarily with early computer modems, the serial port could also connect a mouse, scanner, printer, or a number of interesting devices to a computer.

The serial port is now generally used to connect an external modem to a computer. (See Chapter 11 for more information on modems.) It may also be used to connect two computers for file-exchange purposes. And some PCs still use the serial port to connect a computer mouse.

Beyond the simple options I mention, the serial port has really fallen out of favor recently. In fact, in a few years it may vanish from the computer's rear end, replaced by the more efficient USB port.

- ✔ Your computer should have at least one serial port. Most PCs have two.
- ✔ The Mac doesn't have a serial port and instead uses the USB port to attach devices.
- ✔ Serial ports have a variety of different names used to describe them: modem port, COM1 (the old IBM PC name), AUX, mouse port, and RS-232C port.



## Optional information on infrared ports

Another type of port, found mostly on laptop and other portable computers, is the *infrared (IR)* port. It allows other computers with infrared ports to connect and share data, though it may also be used to connect a computer wirelessly to some device. For this reason, this port isn't considered a standard on most computers. About the only place it's standard is on various handhelds, where the IR port can be used to quickly "beam" information between two systems.

## Mouse and keyboard ports

The mouse and keyboard ports are used to — can you guess? — connect a mouse or keyboard to a PC. There is one port for each device, and though they look the same, they really are different. Obey the labels! The mouse port is for the mouse, and the keyboard port is for the keyboard.

- ✔ Beyond the keyboard and mouse, nothing else plugs into the keyboard and mouse ports on a PC.
- ✔ Future PCs will, hopefully, abandon the mouse and keyboard ports in favor of the USB port. In fact, if you have a USB mouse and USB keyboard for your PC, you can plug them into USB ports and not even use the specialty mouse and keyboard ports.

## The joystick/MIDI port

Nearly all PCs now sold have a joystick port on them; it's more or less standard equipment. Yup, that's where you plug the joystick into a PC.

The joystick port also doubles as a MIDI port. You plug a special MIDI connector into the joystick port, which can be used to connect your PC to a MIDI musical instrument to help you play or compose digital music.

- ✔ Macintosh joysticks all plug into the USB port. For MIDI, the Mac requires a special MIDI adapter.
- ✔ You can use two joysticks on a single computer by purchasing a gizmo known as a *splitter*.



- ✔ MIDI stands for Musical Instrument Digital Interface. It's a big, round, ugly hole (hey — a port!) that you may have seen on any electronic musical instruments you may have lying around your house. The MIDI port is used to connect those instruments to each other and then to a computer. With the proper software, the computer can play the instruments and, lo, you have a symphony on your hands!
- ✔ The joystick port is officially known as the *analog-to-digital* port (or *A-to-D* port). The port can be used for a variety of tasks, most of which are of the science-fair variety: For example, I have one of those twirly wind things (an *anemometer*) that's a home-brew weatherman's kit. It sits on the roof of my office and plugs into my PC's joystick port. That way, I can tell when the wind is blowing without having to look at the trees outside.

## A Full House of Cards

The key to any computer's hardware success is expandability. The old Apple computer triumphed over its peers in the late 1970s because the Apple II could be expanded; inside the computer's case was a row of *expansion slots*. Into those slots, users could plug *expansion cards*, which greatly increased the computer's abilities.

The first IBM PC also had expansion slots, which helped ensure its success. And though the early Macs lacked expansion slots, pressure from users eventually won Apple over, and the G4 line now sports expansion slots for power users who want them (though the iMac doesn't have expansion slots).

### *Why you may need expansion slots*

Expansion slots allow you to add new options or features to those that come with a standard computer. The slots aren't as necessary as they were in the past; the early IBM PCs lacked such luxurious features as a video adapter, serial ports, or even extra memory. All that could be added by plugging in the proper expansion cards.

Computers now often come with everything you need. For example, the iMac has an internal modem, network adapter, and room for more memory. Any further expansion can be added via the USB or Firewire ports. But some power users may want more than that, so other computers come with expansion slots.

- ✔ Expansion slots simply increase the flexibility of your computer system.
- ✔ Some low-end home computers or all-in-one systems, like the iMac, are designed for people who need basic computers and, therefore, probably don't need expansion slots. If you need expansion slots, however, steer clear of those systems.
- ✔ For example, if you want to add a network card, a second monitor or video adapter, a satellite modem, a Firewire adapter, ports, an improved sound card, or any of a number of options, your computer needs expansion slots.
- ✔ I just upgraded my older Mac with an expansion card that contains USB ports. By adding the expansion card, I was able to give my Mac USB ports so that I can now use USB devices. I could have added the same card to a PC to give it USB expandability as well.
- ✔ Expansion cards usually ensure that you can upgrade and improve your system in the years to come.

## *Types of expansion slots*

As with everything else, a computer can't have just one typical expansion slot. After all, technology has vastly improved since the days of Tinker Toys.

For historical and evolutionary reasons, most computers have several different types of expansion slots inside their boxes. Sure, some are better than others. Still, a mixture of several types is generally preferred. Here are the popular ones:

- ✔ **PCI:** This type of expansion slot is the most popular found on both the Macintosh and PC. The PCI expansion slot connects directly to the computer's microprocessor, which makes it very fast. It stands for Peripheral Component Interconnect, just in case that question comes up on *Jeopardy*.
- ✔ **AGP:** A special slot designed specifically for video adapters (refer to Chapter 8) is the Accelerated Graphics Port, or AGP slot. Although PCI video adapters are available, if your computer has an AGP port, you're better off buying and using an AGP video adapter.
- ✔ **ISA:** The original slot found on the first IBM PC is still around, mostly because ISA expansion cards are still with us. In fact, ISA isn't really an acronym for anything; it stands for Industry Standard Architecture, which is just a TLA (three-letter acronym) for "what everyone uses."

Which type of expansion slots should you have? Well, supposing that you want a computer with plenty of expansion slots, I recommend three to five (or more) PCI slots. PCs (not Macs) may also have one or two ISA slots for backward compatibility (though they're optional). And having an AGP slot is nice if you want to use the latest, greatest video adapters (on the PC).



- ✔ Computer memory once plugged into expansion cards. Computers are now designed so that their memory chips plug directly into the computer's main circuitry (refer to Chapter 6, the section about RAM).
- ✔ Some PCI expansion cards can even be used in either a PC or a Mac. (I've purchased both a network card and a USB expansion card that can work with either the Mac or the PC.) But be aware that some PCI cards are Mac- or PC-only.
- ✔ Computer scientist types refer to the expansion slots as the bus, so they use the term PCI bus rather than PCI slot. Same difference.

## Chapter 11

---

# Modems, Networking, and Sound

---

### *In This Chapter*

- ▶ Finding a nice, fast modem
  - ▶ Discovering various modem options
  - ▶ Configuring your computer for a network
  - ▶ Hearing the computer (sound options)
- 

**T**he desktop computer is just about 25 years old. And, like most young people, it wants its own phone. Actually, the phone isn't the issue. What the computer wants is to *communicate*. To meet that end, you can plug in or add on a variety of devices to a computer to make it more communicative. This includes not only modems to talk with other computers around the world, but also a network to talk with other computers in the home or office.

This chapter covers the communications options for your new computer. There are modems and network decisions to be made. In addition, the computer can also communicate by bleeping, screeching, talking, and playing music at you. That's done with sound-producing hardware, which is also thrown into this chapter.

## *Say Hello to Mr. Modem*

A *modem* is a device that lets your computer communicate with other computers. A variety of types, models, and speeds of modems is available, which all depends on how you eventually connect your computer to the Internet.



- ✔ Traditionally, modems were used to connect one computer to another over phone lines. Modems can now use special wires, the same cable as your cable TV, or even no wires at all.
- ✔ Mostly, modems are used to connect your computer to the Internet.
- ✔ Modem is a contraction of *modulator-demodulator*. The original modems converted digital signals from the computer (ones and zeros) into tones that could travel over the phone lines. That's *modulation*. The receiving modem then converted the tones from the phone line back into digital signals for the computer. That's *demodulation*.

## *Modems are measured by their speed*

Regardless of the type of modem, the main modem measurement is speed. How fast does it go?

Modem speed is measured in *kilobits per second*, or Kbps. The higher the value, the better.

The typical dial-up modem (see the next section) is known as the 56 Kbps modem. That means it communicates at speeds as fast as 56 Kbps, (though often not that fast).

DSL, cable, and other, faster modems are capable of speeds upward of 128 Kbps. Some cable-modem connections can even achieve speeds of 1,500 Kbps, which is about the fastest form of online communications you can get with a computer. (To go faster requires special telephone company connections.)



- ✔ Obviously, you want the fastest modem you can afford.
- ✔ Keep in mind that after the initial purchase, you do pay more on a monthly basis for a faster modem than a slower model.
- ✔ You may hear the term *baud rate* used to describe a modem's speed. This term is arcane — and you can even tell the joker that he's being arcane using a silly term like *baud rate*. The more accurate term is *bps*; baud rate is used to describe signal changes in Teletype equipment, which used to apply to computer modems in the 1970s but now is no longer the case.

## Your typical, everyday dial-up modem

The most common computer modem is known as the *dial-up modem*. That's because it uses standard phone lines to connect to the Internet and has to dial the phone just like you do. These are the slowest modems, but they're also the most common and least expensive. Only if you really need online speed do you want anything more powerful.

Most computers come with an internal modem preinstalled. You can save a few bucks by asking that the modem be removed, especially if you plan on using another type of modem for your Internet connection. However, I recommend keeping the internal modem as a backup, just in case.

- ✔ The modem connects the computer to a phone line using a standard phone cable. You can also plug a telephone into the modem so that you can use the telephone when the computer isn't *online*, or connected to the Internet.
- ✔ Dial-up modems can also be external. My advice: Get the internal modem when you buy your computer. That way, it's all installed, configured, set up, and running. You have nothing else to mess with.
- ✔ External modems are nice in that you can turn them off. But they're also more expensive and pretty much an oddity today (except for the high-speed modems, covered later in this chapter).
- ✔ Dial-up modems don't raise your phone bill. Using a modem is like using a telephone. The only difference is that your computer is doing the talking (it's more like horribly screeching) into the phone. Your phone company charges you the same whether you or your computer make the call, and long-distance charges still apply. And, of course, you have to pay for Internet access, but that's an access fee and not a charge for using the modem.
- ✔ Dial-up modems also double as fax modems. Using special software, you can let your computer send or receive faxes. This feature is one not offered with other types of modems.
- ✔ If you're going to use a dial-up modem, my advice is to have a second phone line — one dedicated to the computer — installed in your home or office.





## *Faster modems: Cable, DSL, satellite*

Beyond the dial-up modem are high-end modems for the fastest Internet connection. These modems are generally *not* purchased with the computer. Instead, you arrange to get them from the company providing your Internet service.

Three types of high-end, faster modems are available: Cable, DSL, and satellite, as covered in the following sections.

- ✔ Your computer may require a network card, or *NIC*, to connect to the cable, DSL, or satellite modem. Consider this when you buy; even though you may not be planning to use a network, the network card may still be necessary. (Check with your Internet provider to be sure.)
- ✔ Most DSL and cable modems are external. I've seen satellite modems that are internal, but I know that external models are also available.
- ✔ Even though you have a fast modem, consider keeping a dial-up modem in your computer. You can use the modem as a backup, and it's always good for sending and receiving faxes.

### *Cable modems*

These modems are available anywhere cable service is available (though not all cable providers offer Internet connection). It's the cheapest and fastest Internet connection you can buy.

- ✔ Cable modems can go up to 1,500 Kbps or faster.
- ✔ The only true drawback to the cable modem is that the more people there are online, the slower the connection. (The speed isn't guaranteed.)
- ✔ Another drawback is that cable modem service isn't available everywhere.
- ✔ For playing online games, cable modems are the best, hands-down!

### *DSL modems*

These fast modems are available in limited areas, usually within a few miles of the phone company's main office. If you're within that area (and your Internet provider lets you know), you can use this service.

- ✔ DSL stands for Digital Subscriber Line.
- ✔ DSL modems range in speed from 128 Kbps on up through 1,500 Kbps. The speed depends on the modem, but also on your location and distance from the phone company's office.
- ✔ Also unique to DSL is that you can buy modems with separate speeds. For example, a DSL modem can receive information at 768 Kbps, but sends information at 128 Kbps. This item is cheaper than getting a bidirectional 768 Kbps modem.

### ***Satellite modems***

The satellite modem is a great option for areas where cable or DSL isn't available. This technology has come a long way in recent years; speed has gone up and price has gone down. However, the setup cost remains high because you need not only the satellite modem but also a satellite dish.

## ***Networking Computers***

Another way to make computers talk to each other is through a network. A *network* is actually two or more computers connected using some type of network cable. The computers can share information, access common disk drives, and share printers.

Networked computers can easily share files, printers and modems. This arrangement saves money over buying printers for each computer, plus by sharing high-speed Internet connections you can put only one computer on the DSL or cable modem, and then the rest of the computers on the network can "borrow" that connection whenever they need.

### ***Networking hardware to get with the computer***

If you decide to buy a computer and put it on a network, you must ensure that it comes with the proper network hardware. For many computers, such as any of the Apple Macintosh line, the networking hardware is included. This is also true of many PCs, though for some computers you still have to request the hardware extra.

Primarily what your computer needs is a *NIC* (“nick”), which is an insider term for *network interface card*. That’s an expansion card that either plugs into your computer or is part of the motherboard, as is the case with the iMac and G3 or G4 Macintosh.

- ✔ The NIC should be 10/100Base-T Ethernet compatible. It has a standard RJ-45 connector, plus perhaps a few blinking lights, just to add some excitement to the PC’s derriere.
- ✔ Ask anyone who has ever installed a network card: Have the dealer set it up when you buy the computer.

## *Networking hardware to buy after the purchase*

To connect the computers, you need two things: network cable (I call it network “hose”) and a connection box, known as a hub or switch. It works as shown in Figure 11-1.

You plug the network cable into the RJ-45 hole on the back of the PC. The other end of the cable plugs into the hub or switch. Then you repeat this process for each computer you want to put on the network.

If you have a cable or DSL modem, you plug it into the hub or switch as well. Likewise if you have a network-ready printer: Just plug it directly into the hub or switch.

That pretty much sums up the hardware part. Oh, you can get fancy with wiring your cable into the wall and using patch bays in the closet and so on. But what I’ve just described, and what’s shown in Figure 11-1, is pretty much it.

- ✔ The software part of the setup is the real headache, though Windows XP computers seem to do networking very well.
- ✔ You can network computers with different operating systems. Windows computers generally speak well with each other. But to get Windows, Macintosh, or Linux computers to talk, you need to get extra software. It’s painful, but it can be done.
- ✔ A *hub* is merely a box that lets you connect all your network devices into a single location.
- ✔ A *switch* is a faster, better version of a hub. I recommend getting a switch rather than a hub.



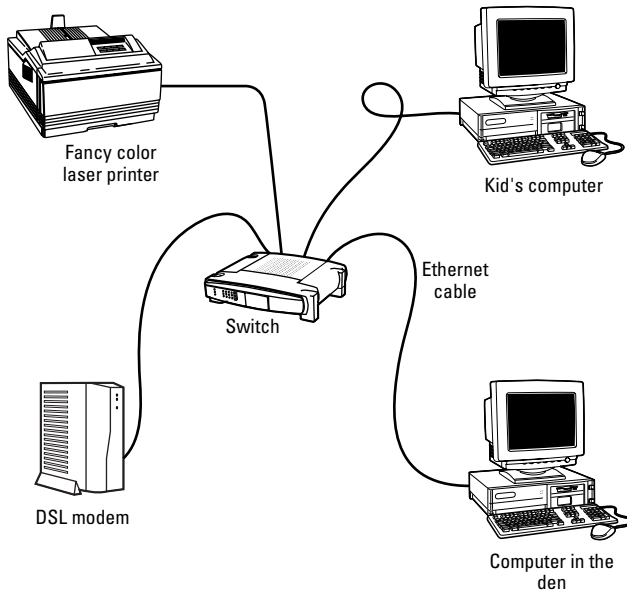

**Figure 11-1:** The basics of connecting a computer network.

---

## *Sound Off!*

The final computer communication element in this chapter involves the system's speaker, which is often augmented by external speakers, bass units, surround sound, and enough volume to wake the neighbors. Heh-heh.

### *The bleeping circuitry*

All computers come with built-in sound circuitry. They are all capable of producing just about any sound, from synthesized music to CD-quality sound to human-voice imitations. Many computer demos you see in the store have top-notch sound playing, although the management turns down the volume to keep the employees sane.

- ✓ All computers contain the basic circuitry required to play computer games. Specialty sound hardware can be purchased as an upgrade. In fact, if you're into audio production or running your own digital music studio, you no doubt want better sound circuitry than what comes with the typical PC.

- ✔ The sound circuitry also includes a music synthesizer, which allows the computer to play music synthesizer or MIDI (“MIH-dee”) files. You can also create your own music, if you have MIDI-creation software.
- ✔ Special software is required to produce a human voice on a computer. All Macintosh computers come with this software as part of the operating system; on the PC, special programs must be purchased to emulate the human voice.

## *Tweeting and woofing*

In addition to having sound circuitry, all computers are sold with speakers. The number and quality of the speakers varies, of course.

Some computers have stereo speakers built into the console or monitor. For example, the iMac and most Compaq Presario models have speakers to the left and right of the console. Likewise, some computers come with tiny left and right speakers. These speakers, whether they’re built-in to the monitor or separate, are okay, but not the best.

No, the best choice for PC speakers are extra add-ons, which don’t usually come in the computer box. Expect to pay up to \$90 for a good-quality speaker set, which includes a subwoofer (for the bass sounds). If you want to go way out, get a speaker system with surround sound. Such a setup works great, if you have software that uses it.



TIP



WARNING!

- ✔ Unless you’re really into sound (music, games, video), don’t worry about buying your computer new speakers. The speakers that come with it work fine.
- ✔ Avoid battery-powered external speakers. If you’re stuck with a pair, buy an AC adapter for them so that you don’t have to mess with batteries.
- ✔ Speakers are measured in wattage; the larger the wattage value, the fuller the sound.
- ✔ Watch out for speakers rated with a combined sound wattage value. Each speaker should be rated individually.
- ✔ A *subwoofer* is a special bass booster, usually sitting on the floor beneath the computer desk. Try to get a subwoofer rated between 100 to 150 watts — or more, if you like that bass sound.



- ✔ If you would rather not scare the neighbors with your computer sounds, you can always plug in a pair of headphones.
- ✔ If you go with surround sound, ensure that you have the proper number of speakers for the surround sound specification. For Dolby 5.1, that's five speakers — left, center, right, left-surround, and right-surround — plus a subwoofer, or bass. Dolby 6.1 uses six speakers and a bass (a rear-center speaker is added). And Dolby 7.1 uses seven speakers and a bass (three speakers in front and four in the back).

## *Adding a microphone*

All computer sound circuitry comes with the ability for input as well, which is provided in the form of a microphone. This item allows you to record your own voice or enjoy such diversions as Internet Phone.

Whether or not a microphone is included with a computer is anyone's guess. Sometimes they come, sometimes they don't. When they do come with the computer, the microphone is usually of marginal quality or built into the monitor or console somehow — not the best possible place for a microphone.

- ✔ If you're into computer recording, you can always add a nice, trusty mic later. Computers use a standard mini-din connector (a teensy plug-in thing) for mic input.
- ✔ If you plan on experimenting with computer dictation, get a combination headset microphone. Often, an inexpensive model is bundled with the computer dictation software.



## Chapter 12

# Special Issues for Notebook and Laptop Computers

### *In This Chapter*

- ▶ Understanding specific laptop hardware
- ▶ Gauging battery life
- ▶ Finding a lightweight laptop
- ▶ Pointing devices
- ▶ Connecting your laptop
- ▶ Securing your laptop
- ▶ Expanding your laptop

**L**aptop computers, officially known as *notebooks*, are piece-by-piece identical to their desktop brethren. The big difference is, of course, that laptops are designed smaller and lighter to be portable. They're computers on the go, which makes them ideal in many work situations where you're away from the office or as a supplement to your standard desktop system.

Buying a laptop works just like buying any computer; the same five steps outlined in Chapter 1 still apply. Beyond that, special attention must be paid to those laptop features that differ from desktop features. This chapter outlines those issues, allowing you to select the best laptop hardware for your needs.

- ✔ Laptops make an ideal computer for anyone "on the go." Salespeople thrive on laptops.
- ✔ Laptops make an excellent second computer, allowing you to take work with you when you're away from your desktop.





- ✓ Laptops are ideal for students away at college, who may not have the room for a bulky desktop.
- ✓ As an old fogey who's been around the computer business for quite a while, I prefer the term laptop over notebook. When you shop, you often see either or both terms. I use laptop because it was the first term used to describe this type of computer back in the late 1980s.

## Laptop Considerations

Desktop computers won their fame by being expandable. Laptop computers won their fame by sacrificing expandability for portability; you don't buy a laptop with the notion of "upgrading it later." You buy a laptop to have a computer anywhere you are: in a plane flying across the country, in a coffee shop, or in a bungalow over the lagoon in Bora Bora.

All the technical descriptions of a desktop computer apply to laptops as well: microprocessor, RAM, and disk storage, for example. Beyond that, laptops have special considerations that desktop users would never dream of. Chief among these are

- ✓ Microprocessors
- ✓ Battery life
- ✓ Weight
- ✓ Pointing device
- ✓ Removable or swappable drives
- ✓ Communications

Each of these considerations (and more) is discussed in the sections that follow.



### What about software?

There's nothing special about software on a computer laptop. If the program works on a desktop system, it also works on the laptop model. Some applications have special "minimum" installation options so as not to use too much of the laptop's hard drive space. Plus, you may find some special laptop software that helps you use your portable system, such as a program to use the fax machine or wireless modem or configure the system to play music on a portable MP3 player — but that software typically comes with the laptop itself.



## Some hardware you may want to have in a PC laptop

Recently, Intel announced a new laptop technology named *Centrino*. It's a marketing term for a bunch of chips and such that truly boost the ability of your mere mortal PC laptop. (This technology isn't available for Macintosh laptops. Yet.)

The Centrino technology includes a special Pentium "M" microprocessor, designed for top laptop performance. Plus, the Centrino laptop includes the latest wireless communications technology, which means that your laptop is ready to go to any of the new cybercafé or wireless computer locations in the country and immediately take advantage of that technology.

Obviously, buying a laptop with Centrino technology is a good thing. (Other, technical aspects of the Centrino technology also help laptop performance — stuff too geeky to mention here.)

## *Special (expensive) microprocessors*

Laptops use special versions of the microprocessors used in desktop computers. These microprocessors are often physically smaller and use less power than their desktop brethren. They also contain the circuitry required to manage the laptop's battery. Because of that, they're also more expensive.

- ✓ It's the smaller nature of many of a laptop's components that make laptops more expensive than desktop computers.
- ✓ Other internal electronics in addition to the microprocessor are also smaller and use less power, which again adds to the price of the laptop.
- ✓ Avoid laptops that use standard desktop microprocessors. Those chips use battery power quickly but also tend to get too hot for the laptop's tiny case. If in doubt, ask: "Does this laptop have a special laptop microprocessor?" (The numbers, names, and IDs for such microprocessors are too numerous to list here.)



## *Disk drives*

Laptops come with very small hard drives, but don't let their size fool you. Often, a teensy laptop hard drive can store as much as its

desktop counterpart. The difference in size is made up for by the price; tiny hard drives are expensive.

Forget about a floppy drive with your laptop. Instead, get — at minimum — a laptop with a CD-R/RW drive. That way, your laptop can read all CD disks as well as create its own CD-R or CD-RW disks.

Also consider the CD-R/RW and DVD-R/RW drives, such as the SuperDrive that comes on the Apple Macintosh laptops. These drives can read all the shiny media, both CDs and DVDs, plus write to CD and DVD disks. Again, you're going to pay a premium price to have it all.

## *A battery of issues*

A laptop can use electricity from a wall outlet or its own, internal battery. The length of time the battery can power the laptop is, obviously, important. A fancy, high-end laptop may have impressive hardware statistics, but if you can use the thing for only an hour before plugging it in, you may as well lug around a desktop.

A good laptop should have batteries that power it for at least two hours, though six hours is better. Any quotes for longer battery life are most likely exaggerated. (Battery life tests are made under ideal conditions — not the same conditions under which you would be using the laptop.)

The best *type* of battery you can get is the *lithium ion*. Second best is nickel-metal hydride (NiMH). Both are rechargeable and can be recharged without having to drain them fully.

Avoid NiCad batteries. Although they're rechargeable, they suffer from *the memory effect*, which means that if you run on battery power, you have to fully drain the battery before it's recharged, or else the battery life gets cut short.



- ✔ You may notice an interesting trade-off between laptop features and battery life. High-performance features drain battery juice quickly. So, if using your laptop unplugged is important to you, cut back on the RAM and microprocessor speed.
- ✔ Some laptops can “hot swap” batteries. That is, you use one for two hours and it drains. Then you can instantly replace that battery with another — without turning off the laptop. This process works only when the spare battery is fully charged.



✔ Beware of laptops that claim longer battery life, yet measure that claim based on swapping batteries. You want to compare laptops based on the life of *one* battery at a time.

✔ If possible, try to use your laptop as much as possible without the batteries. Most laptop owners are adept at finding power sockets in airports, hotel lobbies, and restaurants. If you must, you can always rely on the batteries.



✔ Charge your laptop's battery the night before you leave on a trip. That way, the battery is always ready to go in the morning.

✔ Many handheld and palmtop computers use standard flashlight batteries. Because those computers don't consume lots of power, they can operate for hours — sometimes days — on a pair of AA or AAA batteries.

## *The skinny on laptop weight*

The ideal laptop weighs in at about 4 pounds. Even so, some models may push 10 pounds. The difference seems trivial now, but wait until you lug a laptop across O'Hare airport. You want to look light and carefree toting your laptop, not like you're trying to smuggle plutonium.

Note that laptops weigh more than their advertising boasts. What the manufacturers fail to mention is the weight of the portable AC adapter, spare batteries, and other add-ons. Consider all that when you buy.

✔ If weight is a serious issue for you, consider getting a handheld or palmtop PC.

✔ Going along with weight is the issue of size. Laptops can vary in size from the dimensions of a college dictionary to superthin, like a magazine.

## *The anti-mouse*

Laptops need a pointing device just like desktop computers do. The problem is that standard mice, although a great laptop addition, aren't always practical to have on the road. Therefore, laptops come with alternative pointing devices.

The most common anti-mouse is the touchpad. You touch this flat area, above or below the keyboard, with your finger to move the mouse. Clicking is done by either tapping the touchpad or pressing a button nearby.



Despite the usefulness of the touchpad, most laptop owners also carry a standard mouse. If they can find a nice surface to compute on, using the standard mouse is generally better than mastering the touchpad.

## *Laptop communications*

All laptops are sold with standard dial-up modems as well as built-in networking through the standard Ethernet RJ-45 jack. Try to avoid any laptop that lacks either of these important options. (Note that laptops with wireless networking may lack the RJ-45 jack.)

## *Security issues*

The same things that make laptops appealing to computer buyers also make them appealing to computer thieves: Laptops are easy to steal. To ensure against this problem, get a laptop that lets you attach a security device.

- ✓ The security device can be as simple as inserting a locking cable through the laptop's case. You can purchase a locking cable anywhere.
- ✓ Forget software passwords and encryption. Although that may protect your laptop's data, it's not the files on the hard drive that the crooks are after — it's the unit itself! Hard drives are often erased before the laptop is resold. You can do that whether or not your files are encrypted or password-protected.

## *Laptop Expansion Options*

Despite their teensy size, laptops do have various options for expanding their world. For example, most laptops have room for you to add more memory. Some let you swap out a CD-ROM drive for a second hard drive or perhaps some specialty drive. But beyond these specifics, most laptops have common expansion features.

## *"I've seen these ports before!"*

Like desktop computers, laptops also come with ports for connecting external devices. For example, most laptops come with a connector to add on a mouse, keyboard, or external monitor. They may also have a printer port, USB, or even a Firewire port for even more diverse connectivity.

- ✔ Most newer laptops use the USB port to let you add on a keyboard or mouse.
- ✔ The external monitor port not only lets you use a larger monitor with the laptop, but also works to support a second monitor or video projector when you're making a presentation: You connect the digital project to the laptop's monitor port and then use your software to set up that port as a second monitor.
- ✔ Some laptops lack ports and use instead a docking station, or port replicator. This device attaches to the laptop, and then you can use that device to attach standard PC peripherals.
- ✔ Note that Macintosh laptops use USB ports as their printer ports. PC laptops can do so as well!

## *The PCMCIA port*

The PCMCIA port is the way most laptops deal with expansion. PCMCIA ports eat PCMCIA cards, which are tiny slabs of electronics about the size of a credit card but ¼-inch thick (or thicker). These cards can contain memory, a hard drive, security devices, or other expansion options that increase your laptop's hardware universe.

- ✔ If your laptop already comes with everything you need, having a PCMCIA port may not be necessary.
- ✔ The current PCMCIA standard is known as Type II.
- ✔ PCMCIA stands for Personal Computer Memory Card International Association. So now you know. But it has been rumored that PCMCIA stands for People Can't Memorize Computer Industry Acronyms.



## Chapter 13

# Your Computer's Operating System

---

### *In This Chapter*

- ▶ How operating systems work
  - ▶ Where you fit into the picture
  - ▶ Operating systems and software and hardware
  - ▶ Various operating systems
  - ▶ Older operating systems
- 

**A**ll computer hardware, from the slowest microprocessor to the fastest graphics system, is utterly worthless without the proper software to control it. I know, I know: Hardware is all the flash when you buy a computer. But all the hardware covered from Chapters 5 through 12 means nothing unless you have the software to take advantage of it.

The number-one piece of software in any computer is the *operating system*. It's the first program that runs when you turn on your computer, the program other programs defer to, the head program in charge, the boss, the czar, *el queso grande*, the king o' everything. This chapter discusses your operating system options.

- ✔ Choosing an operating system is a decision you should make *before* you select computer hardware. (Hardware is covered first in this book because you need to know those terms before you can select the software.)
- ✔ Yes, you have a choice when it comes to operating systems. Much to Microsoft's chagrin, the entire world does not run on Windows. And even within Windows, there are variations and versions.



## Understanding Operating Systems

An *operating system* is a program that controls your computer. It coordinates three things:

- ✔ Your computer's software
- ✔ Your computer's hardware
- ✔ You

Each of these items is important. All these items together comprise your computer system. So, as the grand coordinator, the operating system is an important element, bringing it all together and keeping everything running smoothly.

- ✔ Of the three elements, you (obviously) are the most important. How the operating system interacts with you is your primary concern in choosing an operating system.
- ✔ Second-most important is the *software base*, the number and variety of programs available to a specific operating system.
- ✔ Finally, the operating system is written to control specific hardware.

By itself, the operating system doesn't really *do* anything. It's not productivity software, like a word processor or graphics program. It's not a game or a utility or even remotely entertaining. The operating system is merely in charge. Something has to be.

### Working with you

Software is more important than hardware, and the most important piece of software is the computer's operating system. Therefore, your choice of operating system must be a good one.



Forget about the hardware! Shut out the junk around the screen, and merely concentrate on the information being presented by the operating system. Does it make sense? Is it easy? Does it give you the control you need? Can you figure things out? Are you familiar or comfortable with it? These questions are all important ones to ask, more important than "I wonder who made this nifty monitor. . . ?"

Operating systems can be either friendly or powerful. *Friendly* means that the operating systems are easy to learn and use. *Powerful* means that the operating system may not be friendly, but it offers you more direct control over the computer itself.

- ✔ Try out an operating system by running a program. See how it goes.
- ✔ Check out how the operating system displays information about files and folders. (Have someone in the store demonstrate this to you. Have that person show you a file and a folder.)
- ✔ Make a note of which operating system appeals to you the most. Don't let any hardware prejudices unfairly influence you — not yet, at least.
- ✔ You can easily become bored or frustrated with an easy and friendly operating system, even if you like that type of operating system when you first start using a computer. Therefore, if you're at all technically minded, consider a more powerful operating system rather than a friendly one.
- ✔ On the friendliness scale, the Macintosh operating system is about as friendly as you can get. Windows tries, but it's still not as friendly as a Mac.
- ✔ Linux is the least friendly operating system. It can look as friendly as Windows or the Macintosh, but it requires much more training and has greater potential for letting you do dangerous things quite easily.
- ✔ Friendly operating systems generally sport friendly software. The programs on a Macintosh, for example, are intuitive after you know the feel of the operating system.

## *Controlling the software*

The second gauge of an operating system's worthiness is its software base. A *software base* is merely the number and variety of programs available to a specific operating system. The more, the better.

The trap here is a technical one. Suppose that you find and love an operating system that works with you. The operating system is well designed, friendly where it's supposed to be, and powerful where you need it. But, alas, there just isn't any software available. Maybe you can find a few programs, but some of the software you really need just isn't there or isn't as nice as you would like. In that case, forget about using that operating system.

- ✔ One of the operating system's jobs is to control the software. As such, software is geared to work with a particular operating system, and the software reflects many characteristics of the operating system under which it works.



- ✔ A larger software base ensures an operating system's success, even if that operating system stinks.
- ✔ Of course, an overabundance of software shouldn't be the key to buying any computer. If the operating system you choose has exactly the software you need, you're set.
- ✔ Sometimes, a vast software base isn't the only way to judge an operating system. For example, most of the best graphics and design software is still available primarily for the Macintosh. Although Windows versions of such software exist, those programs are generally not as good as the Mac originals.
- ✔ If you're using proprietary software, such as an inventory system written specifically for your company, you need whichever operating system that software requires. This example is one of the rare instances in which the software base doesn't matter.

## Controlling the hardware

The operating system's final task is to control the computer hardware, telling it exactly what to do with itself. So, when you tell a program to print, the operating system is the one which ensures that the information is properly sent to the printer.

Each operating system is written to one or more hardware standard. For example, Windows is written to the PC hardware standard. The Macintosh operating system runs only on Macintosh computers.

Some operating systems are *multiplatform*, which means that they can run on a variety of hardware configurations. For example, Linux can run on a variety of computers. If you have a PC, you buy Linux for the PC; if you have some other type of computer, you buy Linux for it; and so on.

- ✔ An operating system carries with it a software base. So, for example, you can choose Windows as your operating system because it's friendly to you and has lots of software available.
- ✔ Operating systems are generally purchased at the time you buy your computer, which means that everything is set up for you by the dealer.
- ✔ The operating system controls the microprocessor. In fact, operating systems are written for specific microprocessors.

## Operating System Survey

Believe it or not, you do have a choice when it comes to selecting an operating system. Not every computer store carries all operating systems at one time, so you may have to shop around. But options are out there and available — *if you're willing to look.*

The following sections highlight the various operating systems now available. Consider this a mere survey; use your own, personal observations and judgments to select an operating system just for you.

### *Windows XP, Home, and Professional*

Windows is the most popular operating system available, sold with more than 80 percent of all computers. It's friendly and powerful (see Figure 13-1), with a large software base and plenty of games. Chances are that your new computer will have Windows XP installed.

Windows XP comes in two flavors: Home and Professional. Both are *very* similar with only a few subtle differences between them. Even so, the only real reason to go with Home over Professional is if you plan on playing computer games, especially older games from Windows 98 or Windows Me. Otherwise, Windows XP Professional is the way to go.

- ✔ If you want to play games or you consider yourself more of a “consumer” than a business user, get Windows XP Home Edition.
- ✔ Note that Windows XP Professional costs more than the Home version.
- ✔ Only a few extra features are in Windows XP Pro that Windows XP Home lacks. Visually, the two operating systems are indistinguishable from one another.
- ✔ A special version of Windows is available for tablet computers.

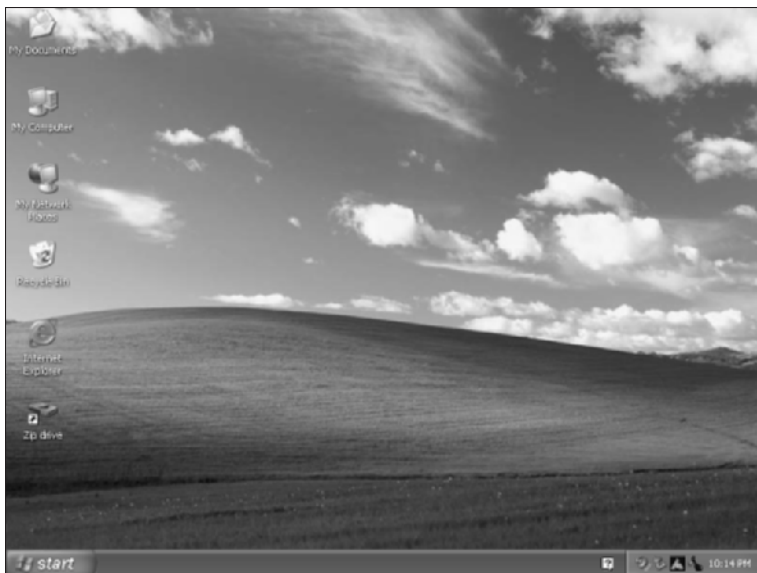

**Figure 13-1:** Windows XP looks like this.

## Mac OS

The Macintosh operating system (see Figure 13-2) is synonymous with the Macintosh hardware: Buy a Mac, get an operating system. Although it would be nice to purchase the Mac OS (operating system) for the PC, you just can't. Alas.



### How is the BIOS different from the operating system?

If the operating system is the main software program in charge of the computer, what's the BIOS for?

The *BIOS* is software that's written and "saved" to a ROM chip inside the computer. The instructions there tell the computer how to do basic things and accomplish simple tasks. But the software does not control the computer itself. Instead, the operating system takes over and uses the BIOS to help it control everything.

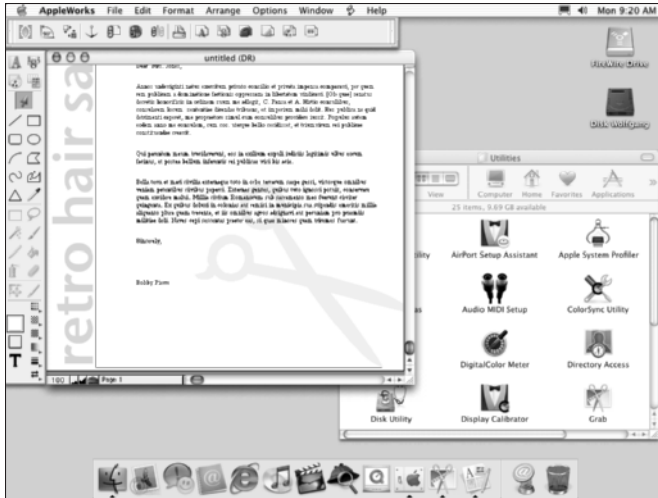

**Figure 13-2:** The Macintosh OS looks like this.

Even if you know that your plans include a PC with Windows in your future, I urge you to find a computer store that sells the Apple Macintosh and then sit down and take a test drive. You'll find that the salespeople are enthusiastic and helpful and that it's a good thing to survey the variety before you consign yourself to Windows slavery.



- The Mac OS is the only true alternative to Windows.
- If you're planning on using your computer for graphics, you would be remiss not to survey what's available on the Mac.
- The Mac OS is tightly tied to the Macintosh hardware.
- Be aware that in addition to being tied to a certain version of the Mac OS, Macintosh software is also geared to specific microprocessors. For today's systems, you want Mac software geared to the G3/G4 processor.

## Linux

*Linux* is a free operating system that runs on just about any computer hardware platform, but particularly on PCs.

Well, Linux isn't *exactly* free. You do pay for a release of Linux, but that also includes bells and whistles and programs that make installing Linux a snap. You can even add Linux to a computer that already runs Windows and "share" both operating systems.

Linux can be cryptic at times, but as long as you add a friendly *shell*, which adds a graphical user interface to the program, it can be easy to use. So, unless you're a programmer or Unix maven, look for a version of Linux with a shell program that helps you get used to the operating system. (This is the trade-off for Linux being as powerful as it is — even more powerful than Windows.) Figure 13-3 shows Linux being run with a shell.

- ✔ Linux is similar to the Unix operating system. If you like, you can get the Unix operating system for your computer as well. But why bother when Linux can be had for next to nothing?
- ✔ Linux distributions go by product names such as Red Hat Linux, Mandrake Linux, and SuSE Linux.
- ✔ Linux is sort of available for Macintosh hardware. Still, why bother paying more for Mac hardware and *not* running Mac software? Instead, just buy an old used Pentium (or better) PC and try out Linux.
- ✔ With continued modification, Linux may one day be a popular alternative to the Windows hegemony.

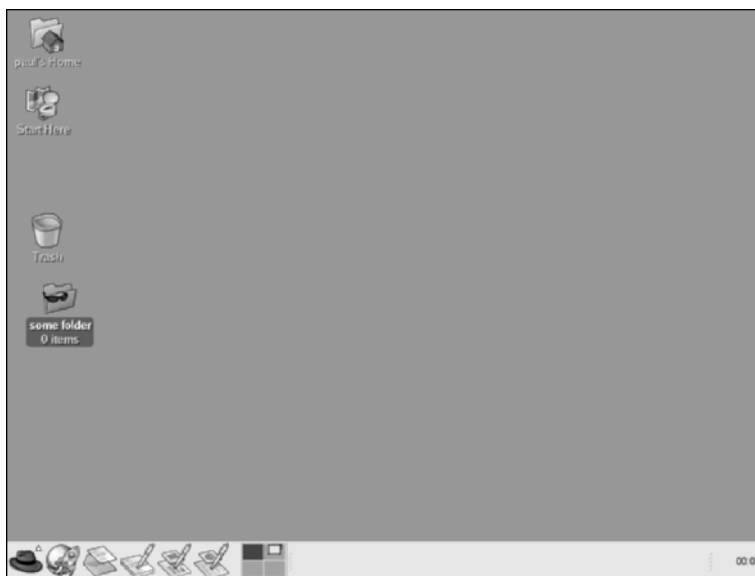

**Figure 13-3:** Here is Linux running a graphical interface.

---

## *Palm OS*

Like the Macintosh OS, the *Palm OS* is a proprietary operating system for the palm-type handheld computers. I mention it here because it's your only choice if you get a Palm computer. Figure 13-4 shows what it looks like.

The Palm OS is simple and elegant, not trying to do everything a desktop computer operating system does. A vast software base is available, most of it free on the Internet. If only desktop operating systems could be so simple and unencumbered. . . . (*wistful sigh*).

## *The antique, the immortal, and the dead*

Even more operating systems are available. New ones are being developed all the time, though rarely do you see a stack of software boxes in the Software-o-Rama for them. These are the curiosities. The ugly cousins. The ancestors of today's computer operating systems.



Figure 13-4: The Palm OS looks like this.



## Here comes the Sun

On the high end, computers made by Sun Microsystems run the Solaris operating system, a version of Unix customized by Sun. At one time, you could buy versions of Solaris for PC hardware, though by being free, Linux has pretty much taken the wind from Solaris' sails.

I don't really talk about Sun in this book, though its equipment is solid and reliable and many businesses run on Sun workstations. However, these machines are not for individual or home users, or even for small businesses. Yet, they remain a viable alternative for larger companies.

**DOS:** Yeah, DOS is dead. IBM still makes a version of it, though, called PC-DOS. Lots of DOS programs are still out there, many of them available for free (because the developers don't stand a chance of making money any other way!). A free version of DOS, called DR DOS, is also available from the Internet. It's quite popular with the anti-Windows crowd.

**OS/2:** Before Windows, OS/2 was to be the successor to DOS. Ha! Never happened. IBM still makes OS/2 available, though. But you can't get software for it, or at least nothing worth looking at. And if it has no software, the thing really has no point to it, eh?

**Unix:** Unix is the oldest operating system available, originally developed for minicomputers, but now available for just about every computer made. Various flavors of Unix are available, from the Solaris operating system for Sun workstations to FreeBSD and OpenBSD for most hardware platforms.

I could probably rattle off about a dozen other operating systems that have come and gone over the years. Each one had its time and place, but now they're consigned to the dustbin of history.

## Chapter 14

---

# Everything You Wanted to Know about Software (But Were Afraid to Ask)

---

### *In This Chapter*

- ▶ Internet programs
  - ▶ Productivity software
  - ▶ Word-processing programs
  - ▶ Database applications
  - ▶ Home budgeting software
  - ▶ Spreadsheet software
  - ▶ Graphics programs
  - ▶ Games and learning software
  - ▶ Utility programs
  - ▶ Writing your own programs
  - ▶ Free and almost free software
- 

**Y**our computer needs software like an orchestra needs a conductor, like a car needs a driver, like an actor needs a script — you get the idea. Whatever it is that a computer does, it does it because of software. And you can choose from a great heaping hoard of software out there.

The information in this chapter properly describes the more popular categories of software and what each one does. Odds are good that you'll pick one or more of the following types of software, depending on your needs, likes, and whims.

## *Doing the Internet*

The most popular thing to do with a computer now is communicate online with the Internet. To do that, you need various pieces of software; the Internet itself isn't a specific program, but rather many programs that *use* the Internet's communications abilities to send and receive information all over the galaxy.

The good news about the Internet is that most of the software you need comes with a computer. Even if the software isn't part of the operating system, the manufacturer tosses in sample Internet programs to help you get started. The two main programs are the Web browser and the e-mail program.

### *Browsing the Web*

What most people call "the Internet" is really the World Wide Web. To surf its many pages, locations, and interesting places, you need a piece of software called a *Web browser*.

Windows comes with the Internet Explorer Web browser, which is considered by Microsoft to be a part of the Windows operating system.

The Macintosh comes with a copy of Internet Explorer, but also other Web browsers, such as Apple's own browser, called Safari.

Linux systems come with a host of browsers, usually the Mozilla browser, Opera, Netscape, plus many others.

The good news is that even more browsers are out there to choose from. Many are available for free on the Internet. If you don't like what you have, you can always pick up and try something new without spending a dime.

### *Getting your e-mail*

The second basic program is an e-mail reader, which also comes included with each operating system. As with a Web browser, many free alternatives are available on the Internet if you're not happy with what your operating system provides.

Some high-end e-mail programs come with various "office" types of applications. For example, with Microsoft office, the Outlook e-mail program is available. On the Mac, the high-end program is Entourage.

## Productivity Software

After the Internet, the next most popular form of software is what's generally called *productivity* software. These programs are the ones that get things done, the workhorses. Even if your main purpose for having a computer is playing games or doing graphics or just surfing the Web, you still find yourself needing at least a few productivity applications to keep yourself occupied.

### Word processing

The most popular type of application on any computer is the word processor, as shown in Figure 14-1. As an office tool, the computer first replaced the typewriter. Word processors have come a long way, of course, from being just a better typewriter. Modern word processors can correct grammar and spelling as you type, and they allow you to include pictures and format your text in various and sundry ways.

At one time, several “levels” of word processor existed: one for beginners, one for writers, one for lawyers, and so on. However, most major programs have combined all these tools from the different levels; you pay for them whether you need them or not. That situation makes word processors full featured yet expensive.

- ✔ Most computer operating systems come with a basic word processor.
- ✔ The most popular word processor is Microsoft Word. Both PC and Mac versions of Word are available.
- ✔ Other word processors are available. For Windows, the Works word processor is popular with beginners. On the Mac, the AppleWorks program also contains an easy-to-use word processor.
- ✔ The original, arcane word processor for all personal computers was WordStar.
- ✔ If you're into writing plays or movies, some special word-processing software has been developed especially for you. This type of software is advertised in the back of both movie and computer magazines.



**Figure 14-1:** A word processor.

## Databases

A *database* program is used to manipulate information, such as a listing of your record collection or a tally of unruly employees. The database software stores the information and then helps you sort it, sift it, print it, retrieve it, or mangle it in any number of interesting ways.

Many database programs are available, from simple ones that just organize your party invites and Christmas card lists to advanced databases that involve some type of programming knowledge. The good news is that you can find a variety, so whatever your needs are, you're going to find some database program to help you manage your stuff.

A typical and quite popular example for a database is *personal organizer* software. This type of program includes an address list, appointment calendar, and other goodies. It's basically an electronic version of the old-fashioned date book, ideal for keeping details about customers or vendors or overseas secret agents.

## Home-budgeting software

Nothing helps mind the bills like a computer. For this task, you should look into two popular programs: Quicken and Microsoft Money. Both do similar things and have the same purpose: to help you balance your checkbook, write checks, manage your money, and do all those wondrous things the computer industry advertising promised in the past decade.

## Desktop publishing

A more advanced type of word processing is called *desktop publishing*. These programs combine the text produced by a word processor with graphics and other tools to create ready-to-publish documents — far better than any mortal word processor is capable of.

If you plan on doing any publishing, you need desktop publishing (DTP) software in addition to your word processor and graphics applications.

The most popular desktop publishing programs are QuarkXPress and PageMaker. Unfortunately, they're also the most expensive and difficult to figure out how to use. ("Professional" software usually is.)

Other desktop publishing programs include Microsoft Publisher and Adobe InDesign.

There are even versions of programs available to help you manage your company or small business. Plus, these programs — as well as Quicken and Microsoft Money — also integrate into various income-tax-paying software that really saves you time come tax season.

The true advantage to home budgeting software is ordering checks that can be printed on your computer's printer. Note that it isn't necessary to buy these checks from the same company that produces your home budgeting software.

## Spreadsheets

A *spreadsheet* is an unusual type of program, combining the power of a calculator with the breadth and depth of a huge table. Although spreadsheets are mostly used for "number crunching" or working with financial data, just about any information you can fit into a grid works well in a spreadsheet.

Spreadsheets rarely are considered home or personal software. However, I find them flexible enough that I do take advantage of them — and this type of software typically comes with the Office type of program that includes your word processor. So, if you have the program, why not use it? But if you need the program, you'll be thankful to have it.

- ✔ Spreadsheets are not just for numbers. They can produce graphs, charts, and organizational charts; and spreadsheets work with any type of lists (see Figure 14-2). If your information appears in any type of grid, working with it in a spreadsheet is a breeze.

## Bundled software packages

The software industry knows that you'll be getting lots of software with your new computer. For this reason, they cut you a break; most of the common software you need is bundled into a productivity package or office "suite." For example, the Microsoft Office suite comes with a word processor, spreadsheet, e-mail program, plus other applications depending on which version of Office you get (and how much you pay).

Even better news: These bundled software packages often come "free" with the computer. You do pay for them, but the cost is built into your purchase, so the damage doesn't seem as bad.

The advantage to bundled software is that everything generally works well together. That's nice. The disadvantage is that you may get stuck with something you don't need. That's just something you have to put up with, which is why it's a good idea to survey what's available before you accept one bundled package or office suite over another.

- ✓ The most popular spreadsheet program for the PC is Microsoft Excel, and Excel is also available on the Mac.
- ✓ AppleWorks is another popular spreadsheet program for the Macintosh.
- ✓ The original, prototype spreadsheet was VisiCalc. It stood for *visible calculator*. You may find a copy in a computer museum near you.

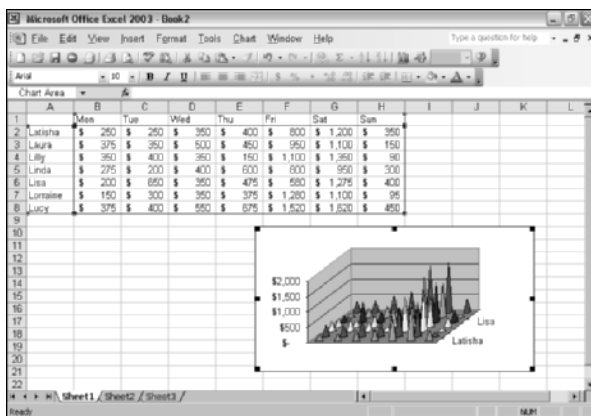

Figure 14-2: A typical spreadsheet showing off a graph.

## Graphics

Graphics software falls into two categories: drawing and painting programs. These programs enable you to create and manipulate a graphical image on the screen. Each one uses a different technique to create the image.

Drawing programs are much more precise than painting programs. They deal with objects and vectors rather than with dots on the screen.

Painting programs are more recreational and not as accurate as drawing programs. They enable you to paint more realistic images, as shown in Figure 14-3. Drawing programs, on the other hand, are more technical in nature, just as a blueprint is more technical than a painting of the eventual structure.

- ✔ If you're an engineer or architect, you probably will spend some serious bucks for a decent graphics system. The advantage of these systems is that changing a design is easy because the thing is stored in a computer.
- ✔ Almost every aspect of graphic arts is now done by using a computer. Most of the best stuff is available on the Macintosh, with some applications also available on Windows.
- ✔ Don't forget computer animation! Many introductory animation programs produce videos that rival the early computer graphics systems of the 1980s — and at a fraction of the cost.

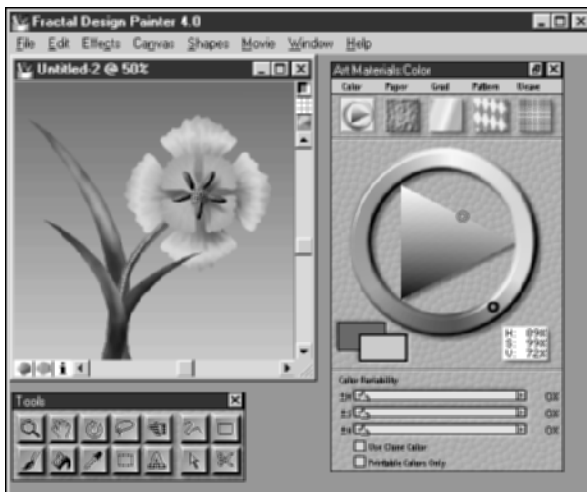

Figure 14-3: A painting program.



## Recreation and Education

Though few people admit it, computers can be used to play games. Oh, and don't forget education — although with a computer, a thin line exists between education and entertainment; both are rather fun.

### Games

This whole personal computer craze really started with the home arcade games of the early 1980s. Although the arcade games are going strong, it's hard to compare those machines that only play games with a computer that plays games *and* does other things, like process words and browse the Internet.

Many different types of computer games are available: arcade-style (see Figure 14-4), shoot-'em-ups; classics, such as Chess, Go, and Othello; adventure games; "little man" games, à la Pac Man; and simulation games (flight simulators, war simulators, and business simulators). The creativity well never runs dry with computer games.

- ✔ Serious gamers use PCs and not home game machines for their main systems. PCs are more customizable and easier to upgrade with the latest technology. Game machine consoles are closed boxes.
- ✔ The Macintosh is also a great gaming platform. The only drawback is that it takes longer for popular games to be "ported over" to the Macintosh than it does for the PC.
- ✔ More and more, new games are also appearing on the Linux platform.

### Education

If computers are magnets, kids are tiny balls of steel. They love computers. They're bold. And there's a reason for that. Nope, it's not that kids today are smarter than we were. It's that kids *have no fear*. In fact, I recommend that you get your kids their own computer. Data loss means little to them.

Some great educational programs are out there, from stuff to teach toddlers their colors and numbers to encyclopedias and SAT exam simulators. Thankfully, much of what's out there is really good. Although some bad programs are out there, just ask around at a PTO meeting and you quickly find out what's good and what stinks.



**Figure 14-4:** An arcade type of computer game.

- ✓ Generally speaking, all the Microsoft reference titles tend to be very good.
- ✓ For small kids, I can recommend programs in the Jumpstart series. Also, my kids love the *Sesame Street* and *Dr. Seuss* programs.

## Utility Programs

A special category of software is the utility program. These programs differ from applications in that they aren't used for productivity. A utility program doesn't do your work on the computer; it works on the computer itself. A *utility* program typically does one of three things: improve performance, diagnose a problem, or repair something.

Utilities come in bundles of several dozen programs. For example, one program may recover files you deleted, another may rescue a damaged hard drive, and another may protect your e-mail from nasty computer viruses.

- ✓ Utilities are also referred to as *tools*.
- ✓ Your computer's operating system comes with a host of utilities for doing various computer chores.
- ✓ About the oldest and most venerated set of utility programs is Norton Utilities. It's available for both the Mac and the PC.

- ✔ One of the best utilities to own is a virus scanner. This type of program ensures that your computer isn't infected with a nasty program (a *virus*) that can really foul things up.
- ✔ If you ever find yourself saying "I wish I had just one little program that could. . . ." or "I keep repeating these same steps over and over. Can't the computer do that for me?" you need a utility. Chances are that something is available which does that specific job. If not, you can write your own computer program, as covered in the next section.

## Programming

Computer programming enables you to write and run your own computer software. So, if you tire of everything in this chapter and really want something *just for you*, you can write a computer program to make that happen.

Many different programming *languages* are available for the computer. Some are easy. Some are hard. The good news is that it's easy to figure out on your own. Many self-paced books and tutorials are available, and most programming languages are very helpful when it comes to spotting errors and offering suggestions on how to fix things. Perhaps the best news is that you don't have to be good at math to understand a programming language. Just having a healthy curiosity about computers helps.

- ✔ Don't be fooled: It takes a long time to write a program, even a simple one. Still, you can do it. No one will stop you. It's one of the more charming things about a computer.
- ✔ The most popular programming language is C++. Unfortunately, it's not the easiest to start using.
- ✔ The easiest programming language to use is BASIC. The most popular version is Microsoft Visual Basic. In a way, it lets you create a Windows program as easily as cut-and-paste.
- ✔ Other languages are available, each with its individual charms and detractions — plus an army of devout followers.

## Software for Nothing and Almost Free

Believe it or not, not all software costs money. A good number of programs, in fact, are available for nothing or almost free. Some

software may come “free” with your computer; some may be available from nice people who write software and give it away because they’re eccentric geniuses and expect their rewards in the hereafter.

- ✔ You can find these free and almost free software programs all over the place. Computer stores sometimes have bins full of disks of free stuff (though you pay for the disk it’s copied on).
- ✔ The most popular place to pick up free software? The Internet.

## *Public domain software*

The freest type of free software is known as *public domain* software. It’s the freest because the author of the package has donated it to the public domain: He declines ownership. Believe it or not, plenty of public domain programs are available. No cost. Ever.

- ✔ Public domain software says so, either in the program or in the documentation. Never assume that something is public domain just because someone else tells you that it is.
- ✔ Do not sell public domain software or buy it from anyone. It’s free!

## *Freeware or open source*

*Freeware* is the term used for software that has no cost but isn’t in the public domain. The primary difference is ownership. Because public domain software has no owner, anyone could, theoretically, modify it and resell it. With freeware, the author gives the stuff away but retains ownership and control. The software may not be modified or often redistributed without the author’s permission.

- ✔ An example of freeware is Linux. The program is given away freely. (What you pay for is a Linux distribution, not Linux itself — a weird concept a lawyer may be able to explain.)
- ✔ Quite a hefty amount of Palm OS software is freeware, including the addicting Hearts game.

## *Shareware*

A popular form of free software is referred to as *shareware*. It’s software that’s available at no cost, just like public domain software and freeware. The exception is that if you use and enjoy the program, the author requests that you contribute a donation. After that, the software is usually “unlocked” and more features are available or the author provides free updates in the future.

- ✓ I've used many shareware programs and pay for those I continue to use.
- ✓ The fee for buying shareware is really cheap, often \$10 or less.
- ✓ Unlike real software, which you cannot give away, shareware authors encourage you to give their programs away.

## Demo software

Another category of free software is the *demo* program. These programs are special versions of major applications you can try before you buy. Sometimes, they're the real thing and lack only a few features. Other times, the demo software self-destructs after a few weeks (the demo is over).

## Beware of illegal or pirated software



Though you can find lots of software available without cost, many programs still are sold through retail channels. These programs are *not* free and are not meant to be given away.

Do not accept any software you can otherwise buy for free. Even if a well-meaning, innocent friend is offering the program, don't accept it. This practice constitutes theft. Only if the software states that it's free (or a "demo") can you legally use it without paying.

# Part III

# Finding Your Perfect Computer

The 5<sup>th</sup> Wave

By Rich Tennant

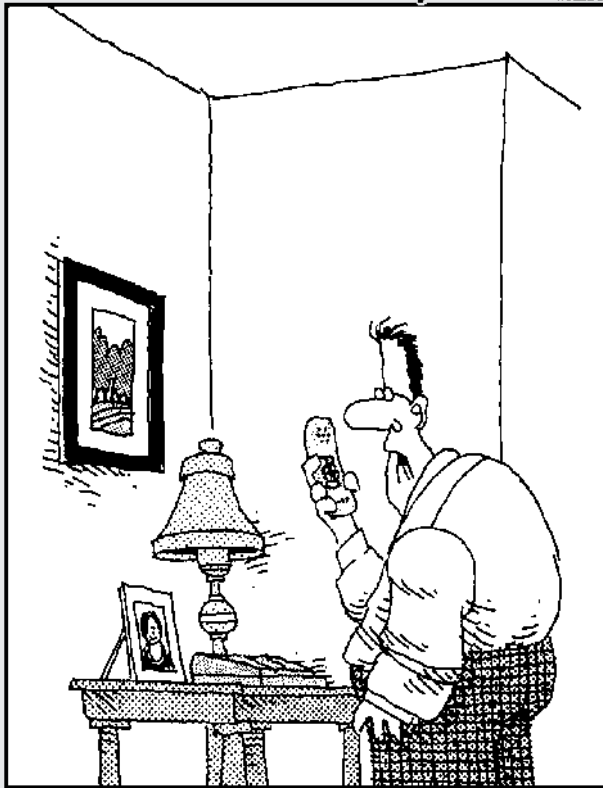

"I'm ordering our new PC. Do you want it left-brain or right-brain-oriented?"

## *In this part . . .*

**I**f buying groceries were as complex as buying a computer, we would all starve. Food is easy to buy in a store, probably because you enjoy eating. I'll even bet that the first cavewoman to eat an avocado wasn't thinking about whether it was a fruit or vegetable or how much fat was in it or which vitamins it supplied or what other kinds of food would go well with it. Nope, he was thinking "Big pit."

This part of the book continues with the five-step process of buying a computer. The next several chapters continue with Steps 2–5: the task of hunting for software, finding hardware, searching for service and support, and, finally, buying a computer. The idea here is to remove the complexity and make computer buying as easy as grocery shopping.

Oh, and an avocado is a fruit. So is a tomato. (But for political reasons, the United States government legally declared that a tomato is a vegetable. Go figure.)

## Chapter 15

# Shopping for Software

---

### *In This Chapter*

- ▶ Test-driving software
  - ▶ Looking for help
  - ▶ Checking for developer support
  - ▶ Reading the software box
  - ▶ Filling in the software worksheet
- 

**S**ee computer. See computer go. Go, computer, go! And how does the computer go? Software!

After deciding what it is that you want your computer to do, the second step in buying a computer is to shop for software. After all, it's the *software* that does the work. Even though a computer's hardware specs may look great on paper or the advertising promises the latest and greatest technology, that means nothing without the software to drive it. Gotta have that software! This chapter tells you how to find stuff that works with you and gets your job done.

## *How to Buy Software*

Before heading off to the Mr. Software store, you should know what it is that you're about to do. I don't want you to walk around and pick up various software boxes because they're pretty or look impressively hefty. No, you need a plan of attack. Here 'tis:

- ✔ Take a test drive.
- ✔ Confirm the support that's available.
- ✔ Obtain product information.
- ✔ Fill in this book's software worksheet.





## Some stuff about software boxes you don't have to read

Software looks great on the shelf — and there's a reason for that. It's designed to look alluring, impressive, fun, exciting, or whatever the software promises. But don't be fooled by clever packaging.

Here are some little-known facts about software in the box, on the shelf, in the store:

- ✓ Software boxes contain lots of air. They used to contain manuals, disks, coupons, and other stuff. Now, the typical software box contains a CD in a paper envelope, plus maybe a thin pamphlet-size manual. Even so, the boxes are just as big as when the software came with a 500-page manual and a 350-page reference book.
- ✓ Some software boxes do contain manuals and references. How can you tell? Pick the thing up!
- ✓ All software boxes are a certain size because psychologists have determined that a given size looks good on the shelf at the software store.
- ✓ A theory a few years ago implied that software boxes were made intentionally larger than necessary so as to literally push the competition off the shelves!
- ✓ For a while, the product name on the software box appeared one-third of the way from the top. The reason was that the shelves at Egghead Software were tilted in such a way that you couldn't see the top third of the box. (Even now, the product name appears on the lower half of the software box.)

The sections that follow outline each of the steps in your software plan of attack.

- ✓ Don't buy anything just yet! You're shopping, not buying.

## *Taking a test drive*

Buying software is a matter of taste. Like discovering new food, you should sit down at a computer and try out any software you plan to buy. Any store that sells software should let you do so. All you have to do is ask "Can I try out the Mobius spreadsheet?" As a buyer, you're entitled to take a test drive.

What should you look for? Look for things you like. If the program is a word processor, how easy is it for you to start typing? Do the various things on the screen look obvious to you? Is it cryptic? Does it feel slow or awkward? Make a note of these things, and if

the word processor isn't to your liking, try another. You should apply this technique to all the software you test-drive.



- ✔ Most computer stores have machines set up on which you can test-drive the software. Some office-supply and department stores may be set up this way.
- ✔ Don't feel guilty about asking to test-drive! If the dealer says No, go somewhere else.
- ✔ Please, please don't have a salesperson demo the software; that person is often too familiar with it to do you any good. It's up to you to fiddle with the software.
- ✔ When you find something you like, fill out a software worksheet for it (see the sample worksheet at the end of this chapter).

## Other sources for test-driving



Not everyone lives near the dream Software-o-Rama that carries everything and lets you test-drive *and* has truly knowledgeable and trustworthy employees. If you're not so lucky, you can consider some other test-driving sources:

**Your guru:** Having a computer-knowledgeable friend can be a boost to picking out some good software. Let your friend show you some of his or her favorite software packages. That's how I got started years ago; I basically used everything my computer guru was using on his computer. Although it wasn't what I ended up with, it was a good start.

**Computer groups:** Most areas have coffee groups that meet to discuss computers and hear guest speakers. These groups are listed in the newspaper or local computer circulars. Stop by and visit one to find out what people use and what their opinions are.

**Buy what's popular:** Another tactic some people use is to look at what's popular. If you live out in the boonies (like I do), call up a mail-order place and ask what sells best (for example, "What's the best-selling database for a philatelist like me?"). Then have the person you're talking to read the requirements from the side of the box for you. That person may also be able to fax you information, if you have access to a fax machine.

**Check the Internet:** If you're already blessed with a computer, or are clever enough to borrow one at the library, you can surf the Internet, visiting both software stores and the manufacturer's own home page for information. Also check out online reviews at places such as [www.zdnet.com](http://www.zdnet.com) and [www.cnet.com](http://www.cnet.com).

**Use school or the office:** An easy way to instantly decide which software is best for you is to go with what you know. If you use WordPerfect at work, why not buy it for home? Likewise, find out what kind of software your child uses in school and buy it to use at home.



Please make sure that you don't "borrow" software from work or school. Though it seems an easy and effortless thing to do, it's really theft. Always buy every software package you use or own unless it states right up front that it's free or in the public domain.

## How Helpful Is the Software?

Most software developers have given up on *user friendly*. Thank goodness. Whenever a developer tries to make something user friendly, it usually winds up being inane or boring. Rather than look for software that's friendly, you should examine the various ways the developer has to offer you aftersale help.

Two kinds of help are in any software package you plan to buy: help in the form of online help (while the program is running) and help from the software developer, in the form of phone support.



- ✓ If you can't get help using your software, you probably bought the wrong thing in the first place (which is what this chapter tries to prevent).
- ✓ Because many places don't let you return computer software after you open it, make sure that you're buying the right thing in the first place.

## Types of help you find in software

Programs nice enough to offer help come in several varieties:

**Online help.** Wherever you are using the program, you can press a special key to see a list of options or review the manual. This technique is good for looking up topics or seeing how things are done. (Online help is different from help on the Internet; see the end of this list.)

**Contextual help.** This is the same kind of help as online help, except that the helpful information you see pertains to whatever you're doing in the program. If you're about to print, for example, the helpful information is about printing. If you're about to save something to a disk, the helpful information is about saving.

**Tutorial help.** When you pay a bit more for a program, it usually comes with a manual for reference and a tutorial for learning. This is always a good thing. The tutorial trains you in using the program step-by-step. Doing the exercises is the best way to become familiar with the program. (Consider getting a good book on the product if the tutorial really reeks.)

**Internet help.** You can also obtain help from the Internet. The company may have an e-mail address you can use or offer support on a Web page (look for the FAQ, or Frequently Asked Questions). You can also find online forums in the newsgroups to get help from regular schmoes who use the program.

## *Don't forget support!*

Some software manufacturers offer telephone support when you really get stuck. With phone support, you can call up the company and directly ask questions about the software. Strange, but true. In fact, one reason that WordPress shot to the top of the charts in the late 1980s was because of its wonderful toll-free phone support.

Not all software phone support is created equal. It comes in what I call the four flavors: vanilla, chocolate, carob, and fudge. These are my flavors, by the way — not an industry standard (well, maybe in the ice cream industry).

**Vanilla:** With this type of phone support, you pay for not only the phone call but also the support. When the software developer answers the phone, you're usually greeted with "Hi! What's your credit card number?" These developers charge you per call (often per minute) just so that you can ask questions about their products.

**Chocolate:** With this type of support, which is better than the vanilla type, you pay for only the phone call. After you get connected, you simply wait on hold until someone happens by to answer your question. The *answer* is free; it's just that most of these places tend to involve long-distance calls.

**Carob:** This type of support is like chocolate, but not as good. It starts out like chocolate: You get free support but must pay for the phone call. After 90 days (or so), you pay for everything — the phone call *and* the support. (I call it carob because it's like chocolate, but not really as good.)

**Fudge:** Fudge phone support is the best. With this kind of support, you get an 800 number to call — a free phone call for free support. The only drawback is that these numbers are busy — all the time.

Tangential to this type of support is support on the Internet. For the cost of an e-mail message (next to nothing), you can write to the company and complain away. I can't properly rate this support, though. In some cases, my questions were answered immediately and properly. In other cases, my questions were outright ignored. Until this situation evens out, rate software on its phone support as I just described.



- ✔ Take note of the kind of support offered by the developer of the software you've chosen. If the type of support isn't listed on the box, ask a salesperson what type of support is available.
- ✔ The computer industry prefers selling hundreds of software packages at a time to major corporations and big businesses. Its support polices are designed mostly to please those big customers. People like you and me (and small businesses), who are intrepid enough to buy our own computers, are often left out in the cold.
- ✔ Another great source of aftersale support can be found in a computer book. Although the manual may be gone and support may cost \$35 a session, for less than that you can get — and keep — a real book written by someone who really knows the program and explains it well. I recommend it!
- ✔ I find it interesting that WordPerfect started its slide from dominance at just about the same time the suits cut back on free support. You would think that the computer industry would learn from this, but no.

## *After You Find What You Want. . . .*

When you feel that you've found a software package that will get your work done much easier, don't buy it! Instead, make a note of it. Fill out a form similar to the one shown at the end of this chapter. Describe the software you've found to get the job done.

- ✔ Fill in forms for *all* the software you're interested in, even stuff you may plan on buying later. Just go nuts! The reasons for this process become obvious in Chapter 16.
- ✔ After you've found your software, wait. Buying time isn't here yet. Your next step is to find the hardware to match the software you've selected. For now, keep your software worksheets handy.



- ✔ Write down information about *all* the software packages you're interested in. If you can't decide between two packages, fill out a worksheet for both. You can decide which one you want to buy later, when you buy a computer.

## *Stuff you find on the software box*

Software comes in a box. Inside the box are the disks, perhaps a manual or getting-started booklet, and other goodies, such as registration cards, keyboard templates, bumper stickers, buttons, and more sheets of random paper than you ever find in a Publisher's Clearing House giveaway.

On the side of the box are the software program's "nutritional requirements." You should find a list of the equipment the software requires. You typically find one or more of these informational tidbits:

- ✔ Which computer or operating system is required. If it's an operating system, a version number may be listed.
- ✔ Which microprocessor is required.
- ✔ How much memory (RAM) it needs.
- ✔ How much hard drive space it needs.
- ✔ Which type of graphics is required (graphics memory, 3-D support, and resolution, for example).
- ✔ Whether it has any special hardware requirements (mouse or joystick, for example).
- ✔ Whether any special options are required or preferred.
- ✔ Which kind of support is offered.

You may see even more information about even more confusing issues. Don't let that boggle you now! (If you need to, refer to Part II of this book to reacquaint yourself with computer hardware.)



- ✔ Information on the side of the software package tells you which type of computer runs the software best. If you eventually buy computer hardware that matches or exceeds those requirements, you're doing just great.
- ✔ Never buy any software without first reading its box! I'm serious. Even a pro (well, myself!) should read the box before buying. I've had to return a few software packages because they were for the wrong computer or were incompatible with my equipment. Reading the box would have saved me — uh, I mean "those people" — some time.

## Filling in the form: Example 1

Figure 15-1 shows the information on the side of a software box, just like you find in a store. It's from a program named Adobe Acrobat, which is a file-sharing utility.

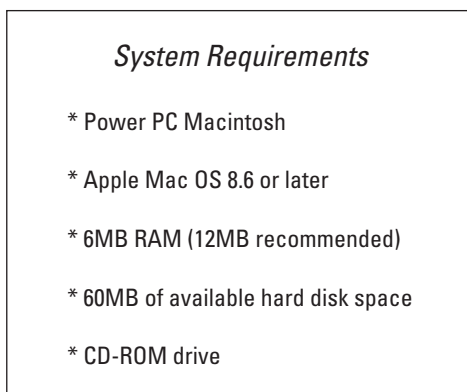

**Figure 15-1:** Software requirements on the side of the box.

---

This product costs \$220 and has chocolate. In addition, here's a distillation of what the software tells you about itself:

- ✔ You need a Power PC Macintosh.
- ✔ You need Apple system software (Mac OS) Version 8.6 or a later version.
- ✔ You need 6MB of RAM, but 12MB is recommended, so you really need 12MB of RAM.
- ✔ You need at least 60MB of hard drive space.
- ✔ Your computer needs a CD-ROM drive.

Fill in your software worksheet according to the information specified in this list. If you don't know how to fill in one of the items, leave it blank (or ask a salesperson for more information). Figure 15-2 shows how to fill out the worksheet.

- ✔ Generally, if some information isn't listed, it's probably not crucial to the operation of the software. Don't worry about it.
- ✔ Note that this product is a Macintosh product, running on the Mac OS ("system software"). A PC version is, doubtless, available as well. If you're undecided between PC and Mac, take down information for *both* versions — including price.

Software Worksheet				
Product name:	<u>Adobe Acrobat</u>			
Developer:	<u>Adobe</u>			
Price:	<u>\$220</u>			
Category:	Office	Word processing	Spreadsheet	Presentation
	<u>Utility</u>	Database	Graphics	Education
	Internet	Networking	Programming	Financial
	Multimedia	Entertainment	Reference	Other
Type of support:	Vanilla	<u>Chocolate</u>	Carob	Fudge
Operating systems:	Windows 98/Me	2000	NT	XP Home/Pro
	Macintosh:	<u>OS 9</u>	OS X	<b>8.6 or later</b>
	Linux:	_____		
	DOS:	_____		
	Other:	_____		
Microprocessor:	Pentium II	III	4	Other: _____
	G3	<u>G4</u>		
	Alpha			
	Speed:	<u>n/a</u>		_____ MHz
Memory (RAM) needed:	<u>12</u>			_____ megabytes
Hard disk storage:	<u>60</u>			_____ megabytes
Media:	<u>CD-ROM</u>	DVD	Floppy	
Graphics: Memory:	_____ megabytes			
Printer:	_____			
Recommendations:	_____			
	_____			
	_____			

**Figure 15-2:** A filled-out software worksheet.

## *Filling in the form: Example 2*

Microsoft is anything but brief. Its description for the requirements to run Microsoft Office XP (or 2002) isn't exactly an example of brevity, as shown in Figure 15-3. What's there can be deciphered, though. Assume that this package costs \$499 and that Microsoft is famous for its carob level of support.



*Microsoft Office XP System Requirements*

- \* Computer with Pentium 133 megahertz (MHz) or higher processor; Pentium III recommended
  
- \* Windows 98 or Windows 98 Second Edition  
24MB of RAM plus an additional 8MB of RAM for each Office program (such as Microsoft Word) running simultaneously
- \* Windows Me, or Microsoft Windows NT  
32MB of RAM plus an additional 8MB of RAM for each Office application (such as Microsoft Word) running simultaneously
- \* Windows 2000 Professional  
64MB of RAM plus an additional 8MB of RAM for each Office application (such as Microsoft Word) running simultaneously
- \* Windows XP Professional or Windows XP Home Edition  
128 MB of RAM plus an additional 8MB of RAM for each Office application (such as Microsoft Word) running simultaneously
  
- \* Office XP Standard  
210MB of available hard disk space
- \* Office XP Professional and Professional Special Edition<sup>2</sup>  
245MB of available hard disk space
  
- \* CD-ROM drive
  
- \* Super VGA (800 x 600) or higher-resolution monitor with 256 colors
  
- \* Microsoft Mouse, Microsoft IntelliMouse, or compatible pointing device

**Figure 15-3:** Software requirements.

---



- ✔ You need a Pentium running at 133MHz or higher, though a Pentium III is recommended.
- ✔ This product can run on Windows 98, Windows Me, Windows 2000 Professional, or Windows XP, Pro or Home versions. But, note for each one that a different RAM requirement is stated.
- ✔ Whenever multiple RAM requirements are listed, specify the largest one. In this case, it's 128MB for Windows XP, plus 8MB each for each office application. Elsewhere on the box, it states that Office comes with as many as eight applications, so 8 x 8 is 64MB — call it 192MB of RAM.
- ✔ Disk space shows either 210MB or 245MB. Again, pick the highest value to be safe, or 245MB.
- ✔ You need a CD-ROM drive.

- ✔ You need Super VGA or better graphics. Most PCs are sold with this feature, so you should be okay. (You cannot run Windows without that level of graphics.)
- ✔ A mouse is also required, which is required for Windows, so it's not really worth mentioning.

Figure 15-4 shows how the software worksheet could be filled in for Microsoft Office XP.

### Software Worksheet

Product name: Microsoft Office XP

Developer: Microsoft

Price: \$499

Category: Office    Word processing    Spreadsheet    Presentation  
                   Utility            Database            Graphics            Education  
                   Internet            Networking            Programming            Financial  
                   Multimedia            Entertainment            Reference            Other

Type of support: Vanilla    Chocolate    Carob    Fudge

Operating systems: Windows 98/Me    2000    NT    XP Home/Pro  
                   Macintosh: OS 9    OS X  
                   Linux: \_\_\_\_\_  
                   DOS: \_\_\_\_\_  
                   Other: \_\_\_\_\_

Microprocessor: Pentium II    III    4    Other: \_\_\_\_\_  
                   G3    G4  
                   Alpha  
                   Speed: 133 MHz

Memory (RAM) needed: 192 megabytes

Hard disk storage: 245 megabytes

Media: CD-ROM    DVD    Floppy

Graphics: Memory: \_\_\_\_\_ megabytes

Printer: \_\_\_\_\_

Recommendations: mouse recommended  
                   \_\_\_\_\_  
                   \_\_\_\_\_

**Figure 15-4:** A software worksheet for Office XP.

## At last: The software worksheet

Figure 15-5 shows the software worksheet before it has been filled out. You should use a sheet like it when you software shop. You can even customize it, adding special items you find along the way. In fact, you may find that a stack of 3-by-5 cards works better. The idea is to document as much information as you can from a software box.

### Software Worksheet

Product name: \_\_\_\_\_

Developer: \_\_\_\_\_

Price: \_\_\_\_\_

Category: Office      Word processing      Spreadsheet      Presentation  
                  Utility      Database      Graphics      Education  
                  Internet      Networking      Programming      Financial  
                  Multimedia      Entertainment      Reference      Other

Type of support: Vanilla      Chocolate      Carob      Fudge

Operating systems: Windows 98/Me      2000      NT      XP Home/Pro  
                  Macintosh: OS 9      OS X  
                  Linux: \_\_\_\_\_  
                  DOS: \_\_\_\_\_  
                  Other: \_\_\_\_\_

Microprocessor: Pentium II      III      4      Other: \_\_\_\_\_  
                  G3      G4  
                  Alpha  
                  Speed: \_\_\_\_\_ MHz

Memory (RAM) needed: \_\_\_\_\_ megabytes

Hard disk storage: \_\_\_\_\_ megabytes

Media: CD-ROM      DVD      Floppy

Graphics: Memory: \_\_\_\_\_ megabytes

Printer: \_\_\_\_\_

Recommendations: \_\_\_\_\_  
                  \_\_\_\_\_  
                  \_\_\_\_\_

**Figure 15-5:** The software worksheet (or something similar).

Fill out the sheets as you software-shop. Look for stuff you like, stuff you need now, and stuff you're thinking about for later. Then get ready to move on to the next step in the buying process.



## Things to look out for in software descriptions

Before getting all excited, you should bear in mind a few warnings when you're reading the information on the side of a software box.

If the word *recommended* is used, beware! The box may say, for example, that it requires 64MB (megabytes) of RAM but that 160MB is recommended. This recommendation usually means that you *need* 160MB, or else the product won't perform to expectations.

Beware of the "upgrade" version. Sometimes, software is sold as an *upgrade*, which means that its manufacturer assumes that you have the old or original version already on your computer. If you don't, the upgrade doesn't install properly, and you're out of luck and money. (Because upgrade versions are generally cheaper, don't think that you've found a bargain or are saving money by getting one when you don't have the original version already.)



## Chapter 16

---

# Matching Hardware to Your Software

---

### *In This Chapter*

- ▶ Using the hardware worksheet
  - ▶ Filling in the worksheet
  - ▶ Examining a sample worksheet
- 

**W**hen you know about the software you'll be running, you can better gauge how much hardware you need. It's superior to guessing; by gathering information on the software (refer to Chapter 15), you're more than prepared to know exactly what type of hardware you need to successfully run that software, both now and well into the future. The battle is half over.

This chapter covers how to select the hardware you need in your new computer. The chapter centers on filling in the computer-buying hardware worksheet. Filling that in is the third step toward buying a computer.

- ✔ Buying the computer is still two steps away, so don't get ahead of yourself!
- ✔ Please continue to avoid brand names and part numbers at this stage.

## *The Hardware Worksheet*

Your software gets the job done for you, but only if you find the hardware horsepower to make the software happy. That's the second-biggest mistake people make when they're buying a computer: not getting enough hardware. Fortunately, that mistake won't happen to you.

Figure 16-1 shows the hardware worksheet. When you fill out this worksheet properly, it tells you exactly which type of computer you need. It doesn't tell you a brand name, and it doesn't recommend a store. That stuff comes later.

With the worksheet filled out and in your hand, you can visit any computer store in the land and find a computer that's perfect for you.

### Hardware Worksheet

Operating system: Windows: \_\_\_\_\_  
 Macintosh: \_\_\_\_\_  
 Linux: \_\_\_\_\_

Microprocessor: Pentium G4 Other: \_\_\_\_\_  
 Speed: \_\_\_\_\_MHz

Memory (RAM): \_\_\_\_\_megabytes

Hard drive storage: \_\_\_\_\_gigabytes

Removable media: Standard 1.4MB No floppy  
 Zip drive Other: \_\_\_\_\_

Optical media: CD-ROM CD-R CD-RW  
 DVD DVD-R DVD-RW DVD-RAM  
 SuperDrive Other: \_\_\_\_\_

Graphics adapter: \_\_\_\_\_megabytes  
 Other: \_\_\_\_\_

Monitor: Size: \_\_\_\_\_inches Dot pitch: \_\_\_\_\_mm  
 Traditional CRT LCD Other: \_\_\_\_\_

Modem: Internal External  
 Dial-up DSL Cable Satellite  
 Speed: \_\_\_\_\_(bps)

Mouse or pointing device: Standard Optical Wireless Wheel  
 Trackball Other: \_\_\_\_\_

Ports: Serial: COM1 COM2  
 Printer: LTP1  
 USB ports: \_\_\_\_\_Firewire: \_\_\_\_\_  
 Joystick MIDI Other: \_\_\_\_\_

Printer: Brand: \_\_\_\_\_  
 Laser Ink Impact  
 Color Options: \_\_\_\_\_

**Figure 16-1:** The hardware worksheet.

## *Filling in the worksheet (step-by-step)*

Start with a blank piece of paper. You use this piece of paper to create your own copy of the hardware worksheet, putting on it what's necessary and needed for your personal computer. As you go through each of the following sections, write down the information you have gathered from your various software worksheets or 3-by-5 cards (whichever the case).

If you're still up in the air between a Macintosh and a PC, create two hardware worksheets. (The same advice applies for any two types of computer systems, though the decisions aren't as varied for game consoles and portable computers.)

It may also help to keep a calculator handy.

## *Choose an operating system*

Look over all your software worksheets and locate the most advanced operating system listed. That's the operating system you need on your new computer. Granted, there are a few things to note:

- ✔ All Macintosh computers come with the latest version of the Mac OS (or "Apple system software"). If you're leaning toward a Macintosh, just circle Macintosh on that form.
- ✔ If any program specifies Windows XP Home Edition, or is compatible with older versions of Windows, such as Windows 98 or Windows Me, you need Windows XP Home Edition. (This advice applies mostly to games that don't run on Windows XP Professional Edition.)
- ✔ If the software has no written restrictions, and playing computer games isn't in your future, get Windows XP Pro.
- ✔ Linux software supposedly runs on all distributions of Linux. But pay attention if special Linux distributions (Red Hat or Mandrake, for example) are mentioned.

Write down your operating system selection.

## *Pick a microprocessor*

You want the latest and fastest microprocessor you can afford. For the sake of filling out this worksheet, however, write down the latest microprocessor your software specifies.



For example, you may get these results:

- ✔ Pentium or better
- ✔ Pentium II at 133 MHz
- ✔ Pentium III

The latest, greatest system in that bunch is a Pentium III. That's what you want.

For the processor speed, write down the fastest rating specified by any software package. For example, if some game program says that it needs at least a 333 MHz Pentium, write down that value.

- ✔ Yes, yes: You will probably get something much faster and maybe fancier than the minimum requirements you're writing on the hardware worksheet. Be patient.
- ✔ All Macintosh G4 computers are compatible with G3 and all Power Macintosh software. But if the box says that it needs G4, get a G4. Likewise, if the box says that it needs *dual* G4s, you need a computer with two G4 microprocessors.

## *Calculate your memory needs*

To find out how much memory your computer should have, look for the *highest* value specified on your software worksheets. Don't add up the values; simply note the highest one.

Suppose that the memory requirements from various software packages are 12MB, 16MB, 64MB, and 148MB. You pick the highest value, which is 148MB. That's the *minimum* amount of memory your computer should have.

Note that despite an application's memory needs, memory is packed into a computer in predetermined chunks, such as

- 128MB
- 256MB
- 512MB
- 1024MB or 1GB

If one of your applications needs 148MB of RAM, for example, you have to get a computer with at least 256MB of RAM. Likewise, if an application needs 640MB of RAM, a computer with 1024MB of RAM is in the cards.

As with the microprocessor, if you can afford more memory, get it. The value you calculate here merely tells you a good *minimum* amount of memory you should have. Calculate that value and enter it on your hardware worksheet.



- ✔ More memory is better.
- ✔ The amount of memory the software needs should be *less* than the total amount of memory in your computer. You never want to cut this value short.
- ✔ Windows XP requires at least 256MB of RAM to run, so most Windows XP systems can run any program that has RAM requirements of 256MB or less.
- ✔ If a memory size is *recommended*, always go with it. The minimum memory size is put there by marketing types who want the package to have the widest appeal. The engineers who design the software set the recommended value.

## Calculate your hard drive storage

Unlike computer memory, hard disk storage is a cumulative thing. It adds up. And you will, eventually, run out of hard drive storage. The idea is to put that day off as far in the future as possible.

Add all the hard disk storage requirements from all your software worksheets. If the package doesn't list the storage requirements, use the value 10MB. Total 'em all up.

Suppose that you have the following storage requirements (the two for 10MB are from two packages that don't list hard drive storage requirements):

131MB  
10MB  
10MB  
26MB  
65MB  
210MB

The total of those values is 452MB.

After you add the values, double the result. In this example, the amount is 904MB. If you're using a database or graphics program,

double the number again. The result is approximately the *minimum* amount of disk space you need in order to use your computer.

But that's just for programs. You must also consider the data files you plan to create.

If you plan on using your computer for Internet access, e-mail, and the Web, plus perhaps word processing and home accounting, add 4GB to the amount of hard drive storage you need.

If you plan on using your computer for digital photography, add another 10GB to your storage needs.

If you plan on using your computer to play music, add 20GB to your hard drive needs.

If you plan on storing computer video on your system, add another 40GB of storage.

Note that these are just wild estimates. The idea is to have a hard drive that has enough room for you in the future. The last thing you want is to have to upgrade a 6-month-old computer with a new hard drive because of a lack of planning before the purchase.



- ✓ Relatively speaking, hard drive storage is cheap.
- ✓ Disk storage is different from memory storage. A program uses memory only when it runs. Every program, however, as well as the files and documents the program creates, has to be stored on the hard disk.

## *More storage decisions*

Chances are that your software doesn't require any specific type of disk drive, such as a CD-R or Zip disk. If it does, jot down that information. Otherwise, you probably can get by with whatever comes with the computer.

- ✓ I can recommend a Zip or Jaz drive if you're working on graphics and need some way to move those graphics files to another location. These types of removable disks are also wonderful for taking work home from the office.
- ✓ Don't lament the iMac's lack of a floppy disk drive. You can always add a USB floppy drive later if you discover that you *really* need one. Ditto for any other floppy-drive-less computer.



- ✓ Write down the fastest CD-ROM rating listed on your software worksheets. If one program requires a 12X CD-ROM, for example, write down that value. Otherwise, you can leave this item blank; whatever the dealer gives you should be fast enough.
- ✓ If your video software requires a specific type of DVD-R or DVD-RW drive, mark it down. Also mention whether you need a + or a - type of DVD drive.
- ✓ If you can, try to specify the *tray* type of CD-ROM, where a tray slides out and you lay the disk in the tray. Personally, I find that method of sticking CDs into the drive easier than the slot-type of CD-ROM drives (like you have in your car). If this issue is important to you, mark it on the worksheet.

## Other hardware stuff

After your memory and storage requirements, the rest of a computer system tends to fall into place without many heavy decisions on your part. Here's a rundown of almost everything left in your computer system:

**Graphics:** Write down any specific graphics requirements your software lists; for example, “256 color display” or “64MB video memory recommended.” If the game you're wanting to play requires a specific graphics processor unit (GPU), note it on the worksheet. You must make sure that whatever graphics adapter you buy is capable of those feats, at least at minimum.

**Monitor:** A monitor is a personal-preference item. I recommend getting an LCD monitor if you can afford it. Bigger monitors, LCD or CRT, are more expensive.



Make sure that you get a multiscanning, noninterlaced monitor. If you can't afford it, that's okay. I recommend it, though. Also make sure that the dot pitch is at least .28 mm or *smaller*.

**Modem:** Unless you're planning on getting DSL or cable Internet access, you need a dial-up modem. At a minimum, you can use it as a fax machine on your computer.

- ✓ By not getting a modem, you may save a few dollars on the purchase price.
- ✓ Note that your Internet Service Provider (ISP) provides you with a DSL or cable modem; these items aren't purchased with the basic computer setup you're buying now.

**Mouse:** You can have many fancy mice, so make sure that you visit a computer store to see what's available. The dealer will probably give you a choice. Remember to get a fancy mouse, such as the wheel mouse, only if your software knows what to do with it.

**Sound:** Most sound cards sold with computers are generally compatible with all the games out there. Only if your software requests a specific sound card should you write it down on the worksheet.



Be sure that your computer comes with external speakers. For extra money, you can get the subwoofer option, which beefs up your computer's sound. All this equipment is extra and not truly required. If your money is tight, you should spend it elsewhere.

**Ports:** PCs should have at least two COM (serial) ports and one LPT1 (printer) port. Any extra ports you get depend on your needs.

All computers, Mac and PC, should have at least two USB ports. Having a Firewire in addition to USB is even better.

If possible, try to get a computer with the USB 2.0 standard, which is faster than the original USB port.

The joystick port is still available on most PCs, though pretty much all computers use USB joysticks (or *game pads*) now.

**Other options:** Specify any other items your PC may need: a scanner, backup power supply, graphics tablet, or whatever else your software programs may specify.

Part II has more specific information about the hardware mentioned in this list.

## A Sample for You to Review

Figure 16-2 shows how a sample worksheet may be filled in. Your sheet should look something like this one when you're through reviewing your software requirements. (Or, you may have two sheets: one for a future Mac and another for a future PC.)



- ✓ The first thing to notice is that not every item is required.
- ✓ Remember that you're configuring a minimal computer. The model you probably get will have more stuff in it.

### Hardware Worksheet

Operating system: Windows: **XP Home**  
 Macintosh: \_\_\_\_\_  
 Linux: \_\_\_\_\_

Microprocessor: Pentium G4 Other: III  
 Speed: 333 MHz

Memory (RAM): 160 megabytes

Hard drive storage: 45 gigabytes

Removable media: Standard 1.4MB No floppy  
Zip drive Other: \_\_\_\_\_

Optical media: CD-ROM CD-R CD-RW  
 DVD DVD-R DVD-RW DVD-RAM  
 SuperDrive Other: \_\_\_\_\_

Graphics adapter: 64 megabytes  
 Other: \_\_\_\_\_

Monitor: Size: \_\_\_\_\_ inches Dot pitch: \_\_\_\_\_ mm  
 Traditional CRT LCD Other: \_\_\_\_\_

Modem: Internal External  
 Dial-up DSL Cable Satellite  
 Speed: \_\_\_\_\_ (bps)

Mouse or pointing device: Standard Optical Wireless Wheel  
 Trackball Other: IntelliMouse Explorer

Ports: Serial: COM1 COM2  
 Printer: LTP1  
USB ports: Firewire:  
 Joystick MIDI Other: \_\_\_\_\_

Printer: Brand: \_\_\_\_\_  
 Laser Ink Impact  
 Color Options: \_\_\_\_\_

**Figure 16-2:** A sample, filled-in hardware worksheet.



## Chapter 17

---

# Surveying the Shopping Landscape

---

### *In This Chapter*

- ▶ Reading a computer ad
  - ▶ Avoiding advertising tricks
  - ▶ A shopping Q&A
  - ▶ Visiting your local computer store
  - ▶ Visiting a megastore
  - ▶ Ordering mail-order computers
- 

**T**hey sell computers everywhere, so finding one to purchase isn't a big issue. "Two slurpies, a Lotto ticket, and one of those Pentiums, please." Of course, you don't want to walk into just anywhere to buy your computer.

Lots and lots of places sell computers. Some are dedicated computer stores, some are mom-'n'-pop places, some do mail order, some sell directly from the factory, and some places even sell washers and dryers right next to the iMacs. This chapter describes each place and gives you an idea of what to expect when you walk in.

Where do you start? Probably by picking up the paper and reading the computer ads. Heck, you have probably been doing that already. Now find out what it all really means.

## *Reading a Computer Ad*

The first step in buying that computer is to look at computer ads. Although this process can be boring, it's definitely not as boring as bewildered browsing in a warehouse-size computer store. After all, because you're reading this book, you're going to show up



knowing exactly what you need; you don't have to be sold anything. Computer stores aren't really set up for that kind of customer (just look around the next time you visit one of the stores).

## *Finding computer advertisements*

You can find computer ads in computer magazines, your local newspaper, and freebie computer fliers.

**Newspapers.** Look in the sports section on Saturday (don't ask me why). That's usually where you find some computer-related ads from the local stores. You may also want to check the business section throughout the week. Some newspapers even have computer-specific inserts.

**Computer magazines.** Visit a magazine rack and look for computer magazines. It doesn't matter how technical they are; you're doing research at this point and are using the magazines for their advertising. The library is a great place for this kind of research.

**Free circulars.** Many communities have free computer magazines or tabloids published locally. They're crammed full of ads from local vendors with some prices — plus service and support — that meet your needs.

## *Dissecting an ad*

Figure 17-1 shows a computer ad I mocked up myself this morning. It lists various "systems" along with their hardware contents and prices. It's typical of what you might see from most dealers.

Systems displayed in ads such as the one shown in Figure 17-1 are set up primarily for price comparison with competitors. This statement doesn't imply that your choices are limited to what's displayed. Feel free to mix and match components in a system as you need them. If the dealer won't do that, shop elsewhere.

Don't fear the abbreviations! Although I'm sure that some fondness for computer jargon is responsible, space restrictions are the most likely reason that the ads say *RAM* rather than *memory* and *GB* or *G* rather than *gigabytes*. You may even see *HDD* used in place of *hard disk drive*. *VRAM* means *video RAM* or *video memory*. You often find customized products, such as the "clackity" keyboard or maybe some special type of mouse.

# JERRY'S PC HUT

---

**Bargains!**

*SUPER!*



**Thunder!**

Intel® Celeron™ CPU 1.7GHz,  
128K cache, Intel 845GL Chipset  
Onboard Video/Audio/LAN, USB  
2.0, 128MB PC 2100 DDR RAM,  
Floppy, 20GB IDE Hard drive  
52X CD-ROM (no monitor)

**\$499**

**Deals!**

*WOW!*



**Lightning!**

Intel®Pentium® 4 512k L2 cache  
P4-478 845G Chipset Video/  
Audio/LAN motherboard, USB 2.0,  
256MB, floppy, 60GB ATA/133 HD,  
48X/12X/48X CD-RW, Intel Extrim  
Graphics, Modem, speakers

1.8GHz	\$659
2.0GHz	679
2.66GHz	789
3.0GHz	1050

**Internet!**

*DROOL!*



**Armageddon!**

Intel®Pentium® 512k L2 cache  
Black tower case, 300W power,  
RAID, Serial ATA, USB 2.0,  
512MB DDR RAM, floppy, WD  
80GB 7200 RPM 8MB cache,  
48X/12X/48X CD-RW, 16X DVD,  
GeForce Ti 4200 128MB, modem  
5 piece speaker system

2.5GHz	\$1199
2.8GHz	1409
3.0GHz	1629

---

**Monitors**

15" CRT	\$CALL.00
17" CRT	\$100.00
19" CRT	\$200.00
15" LCD	\$300.00
17" LCD	\$500.00
18" LCD	\$650.00

**Printers**

Voov Ink Print	\$120
Strombo Photo Ink	\$290
Office Laser	\$600
Color Laser	\$1200

**Even More!**

We have the largest selection of quality PC hardware, including mice, scanners, digital cameras, adapters, cables, gizmos and gadgets. Plus:

- \* PC supplies: Paper, CDs, CD-Rs, mouse pads & other stuff
- \* Shareware CD bargain bin
- \* Computer books and magazines
- \* Saturday classes
- \* On-site service
- \* 24/7 tech support hotline

---

**Jerry's PC Hut**  
1940 Debbie Drive  
Temecula, CA 92592  
**909-555-1899**  
Open Monday ~ Friday,  
9:00 am 'till 8:30 pm  
Saturday from  
9:00 am to 6:00 pm  
Closed Sundays!

**Software**

Call about the custom software configuration we do for each system. Options include:

- \* Microsoft Works
- \* Microsoft Office
- \* Adobe

Free Espresso!

---

**DON'T BE A NUT — COME TO JERRY'S PC HUT!**

**Figure 17-1:** A typical computer ad.

One important abbreviation you often see is \$CALL. It means that the advertiser wants you to phone up to see what price it offers. You can interpret \$CALL in several ways: The price is too ridiculously cheap to advertise (which happens), the price changes frequently (that happens, too), or someone there just wants to talk to someone on the phone (not often).



Note that some items are missing from the computer descriptions. Most importantly, *where is the monitor?* Those prices may look cheap, but all PCs need a monitor.

One good thing to note in any ad is the phone number *and* address. Although just about any place lists its phone number, you know that a dealer is legit if it has a street address. (Some fly-by-night operations never give addresses.)

Finally, don't forget service and support! The ad may not say anything about what's offered, so be sure to phone or visit the store before you make a decision.



- ✔ Name-brand manufacturers (Dell, Compaq, and Micron, for example) also have ads similar to the one shown in Figure 17-1. Even though your system may not be listed, remember that you can mix and match.
- ✔ Macintosh and PC rarely mix. Some places do carry both. But if you cannot find specific information on Macintosh computers, buy a Macintosh-specific magazine, like *MacWorld*.

## ***Recognizing common tricks used to make an advertised price look really cheap***



Because the competition is fierce, computer dealers go to great lengths to make their systems look cheaper than the other guys'. Here are some common tricks you may want to look for or inquire about when you find a ridiculous price:

- ✔ Not including the price of the monitor or video adapter card (the most common trick).
- ✔ Not including the price of the microprocessor (although this practice sounds ridiculous, it happens).
- ✔ Not including the price of the operating system. Technically, this item should be "thrown in," but the dealer may be saving a few bucks by not including it.
- ✔ Not including any memory in the computer. Look for 0K RAM or 0MB RAM in the ads, or see whether the memory value is missing.
- ✔ Including manufacturer's rebate coupons, which lower the price only *after* you turn them in.
- ✔ Omitting support or service!
- ✔ Showing an unrelated illustration, usually a picture of a computer that may or may not look like what's being advertised. For example, watch out for "Model 400 shown" or "Optional monitor shown" written in tiny print below the illustration.

## *The myth of the free (or almost free) computer*

The final trick you find lurking out there is the free, \$0, or \$100 computer. Basically, they make the price so low by preselling you several years' worth of Internet service with the computer. So the Internet provider is buying your computer in exchange for your subscribing to its service.

It works like this: When you buy the computer, you sign up for three years of Internet service. You get, in exchange, a certificate for \$300 to \$600 off the purchase price of your computer. So, you walk home with a new PC or Macintosh, having paid only \$100. And then the bills come.

Every month for 36 months to come, you have to pay your Internet provider \$20 or so a month. It's part of your purchase agreement. That's great if you were planning on doing so anyway, but if you want to change Internet providers, you still have to pay for 36 months. Or, if you don't like the computer and it ends up in the closet, you're still paying \$20 for 36 months (\$720 total).

My advice? If — and that's a big *if* — the computer is exactly what you need according to this book *and* you have the proper service and support for it, consider the “free” or cheap computer as an option. However, also keep in mind that I'm not recommending them to any of my friends, not even as a joke.

## *Some Q&A Before You Rush Out to Buy*

In keeping with the theme of the preceding section, you may have even more buying questions right now. This section lists some general questions and answers (the preceding section is specific to the free-computer phenomena). Hopefully, the one question you want to ask is among the following.

### *“Should I get a quote?”*

Most stores offer a “meet or beat” way to price a computer. They claim to meet or beat any advertised price on similar or the same equipment. If you like to shop this way, get several quotes from different sources before you buy.

When you're comparing prices, don't forget to factor in a few dollars for service and support. How much? Anywhere from \$50 to \$300, depending on the kind of support that's added. A lack of support can cost you from \$50 to \$300 to maybe much, much more if you're not careful.



- ✓ Why add \$50 to \$300 for service and support? That's probably how much it will cost you when you *don't* get it: Add up gas, phone calls, the cost of a tutor or community college course — you get the idea.
- ✓ Although some hole-in-the-wall place always wants your business when you buy something, will it want to see you again when you have a question or need help?
- ✓ Chapter 18 discusses how to easily comparison-shop on the Internet.

## ***“Can I haggle?”***

The days of haggling over buying a computer are long gone. It used to be that computers were marked up so much that only a complete nebbish would pay the list price. You could typically count on a 20 to 50 percent discount in swankier stores.

Now the competition between stores is too great to allow for any haggling. The price you see advertised is usually what it sells for. Computers still have a manufacturer's suggested retail price (MSRP), and you may see that ridiculous value listed above the store's "discount." Whatever. Don't expect to get any more breaks than that.

## ***“Should I get a discount off the manufacturer's suggested retail price?”***

Yes, especially on software. The “street price” of all computer whatnots is always less than the manufacturer's price — a weird holdover from the days of haggling.

## ***“Isn't there any way to get a deal on a computer?”***

About the only way left to get a lower price on a new computer is to buy two or more at a time. This technique works just about

anywhere and with anything: Buy two or more cars, and the car dealer will cut you some slack. Be forewarned, however, that some computer stores don't start to cut deals until the 10th or 100th computer you buy!



You probably don't need two or more computers for your first computer purchase. Does that leave you out? Nope! Just find an associate or willing relative who is also on the verge of buying. Sometimes, you can receive substantial discounts for purchasing two computers at the same time, often without losing valued service and support.

### ***“Is it better to buy from a noncommissioned salesperson?”***

I've been buying computers for more than 17 years and have yet to find a commissioned salesperson. Because most stores are either discount or locally owned, there's no commission to be made. I would guess that only the manufacturer's direct sales reps who sell to major accounts get commissions, although I doubt that even that's the case anymore.

If commissioned salespeople bug you, you can always consider going elsewhere.

### ***“What about buying a used computer?”***

A used computer is a bad idea for a first-time buyer. Why? Because you're cutting off your service and support, for not only the hardware but also any software they throw in. You get no guarantees or warranties with used equipment. For a second purchase, sure, but not when you're just starting out.

### ***“What about refurbished stuff?”***

I have purchased a few refurbished computers, but only because they came with a manufacturer's warranty. The equipment was older, but because it served the purpose I had in mind, it was fine for me. And it was cheap!



Do watch out for refurbished stuff masquerading as new equipment. Always read the fine print. The dealer must tell you that it's refurbished, but it doesn't have to shout its lungs out at you.

## *“You didn't say anything about the swap meet”*

The reason I don't mention swap meets — even computer swap meets — is that no service and support are available. True, if you find a local dealer that is simply making its presence known at the swap meet, that's okay — as long as the dealer has local service and classes or some kind of support.

Swap meets are havens for fly-by-night outfits and jerks who sell stolen or substandard crap from the back of pickup trucks. I don't mean that everyone there is shifty; some reputable dealers do show up. If you do business with a jerk, though, don't expect him to be there the next weekend.

## *Where to Buy*

Looking over the ads gives you an idea of what's out there. Eventually, however, you have to pick a few places to phone or visit and get a more lasting impression. You don't want to shop by price alone. A store's reputation is based on service and support, which you can't determine over the phone.

When it comes time to narrow your choices, you can buy your computer from several types of places:

- ✓ A local computer store
- ✓ National chains
- ✓ A megastore
- ✓ Mail order

Any of these options is fine by me for buying a first-time computer. Even mail-order places offer service and support, though the support takes place over the phone rather than in a classroom.



One additional place to buy a computer is the Internet. Obviously, you need a computer to use the Internet, so if you don't yet have one, that choice won't do you any good right now. Still, Chapter 18 covers the topic of online buying if you already have Internet access.

## *Your locally owned and operated computer store*

If you're one to support your local economy, a locally owned store is probably your first choice for buying a computer. These places may look tacky. Although they may have stuff on Costco tables and boxes stacked in back, they may also have fair prices and owners who offer more personal support than their Big Brother competitors.

The most serious issue about a local store is how long it has been in business. Any store that has been around for three years or more probably has an excellent reputation (or at least a reputation you can verify). Give new places a chance, but consider hanging out in the lobby or checking the service counter to see whether it has any disgruntled customers. You may also ask for a list of satisfied customers to confirm its reputation.

- ✔ I often go to local stores to pick up something quick: a keyboard, modem, or some piece of software that they have in stock.
- ✔ Some smaller stores may have to order your computer or assemble it. Although this process takes time, you're getting a custom computer. Larger stores tend to sell things "off the rack."
- ✔ Another type of local store is a university bookstore, but don't think that it's cheaper! Some computer manufacturers used to offer decent discounts to students who bought computers at their school bookstores. That may not be the case any more. Never assume that the school bookstore is cheaper than a local store.



## *National chains*

National computer chains have been replaced by computer megastores (see the next section). However, some national stores that are not necessarily computer stores do carry computers: Sears, Radio Shack, KMart, Costco, Sam's Club, and other places sell computers — even Macintoshes — right next to stereos and videotape.

The big benefit of buying a computer at a national chain is that they're everywhere. Unlike with local dealers, you never have to worry about finding a Radio Shack or Sears because they're all over the place.



The big drawback to national chains is that they're not geared specifically toward helping people buy computers. Although some places are exceptions, it's hard to expect sincere support from the guy who sells you a computer, a hair dryer, and a country-and-western compact disc. These places don't have a classroom to teach you about AppleWorks or Windows, and don't expect to get far when you phone up to ask a question about formatting a disk.

## *The megastore*

*Megastores* are those super computer stores, some bigger than a grocery store, that have everything and anything to do with a computer. You can browse, check out new hardware, ask questions, take classes, and spend money until you have to take out a third mortgage.

One downfall of these stores is that their sales staff turns over quickly. Just as I start a relationship with someone, he's off to another job. This quibble is a minor one as long as the new clerk is just as knowledgeable as the guy he's replacing.

Before you commit to one of these megastores, be sure to check on its warranties and return policies, and double-check on its service and support. Also find out *who* fixes the stuff. Is it fixed there, or does the store just ship broken stuff to some factory in another state?



## What about building your own computer?

Do you want to build your own computer from scratch? It certainly is possible for the PC (Macs are made only by Apple). Many places sell the pieces' parts, and everything plugs in or is screwed in to one thing or another. Buy a book about making your own PC, use a knowledgeable friend's help, or do it on your own. It's possible. Unfortunately, it's not a task I recommend for anyone starting out.

The main problem with rolling your own PC is that you get no service or support. Even if you're gutsy enough to try, you have no one to turn to when something doesn't work right. Individual parts may be covered by a warranty, but not the complete unit.

Some may argue that building your own computer is cheaper, which may or may not be true. However, I would seriously factor into the bottom line the support you're not getting. Never build your first computer. Your second or third, okay — but not the first.

## *Mail-order brand names*

Welcome to the new millennium, where you can have just about anything mailed to your house — including a computer! You typically order from a catalog or magazine article, someone quotes you a price, and a few days or weeks later, your computer shows up, ready to go.

(Okay, the computer shows up in a box, and you have to set it up. Don't worry — this book shows you how! See Chapter 21.)

Mail-order computers offer the same things as your local dealer or megastore. The only difference is that it's sent to your home or office rather than to a loading dock. The price is often cheaper because you aren't charged an in-store markup, and often you can dodge your state's sales tax (though those days are rapidly drawing to a close).

Many people are concerned about mail-order computers showing up dead or damaged. Before you order, make sure that you get a no-questions-asked return policy and that the manufacturer pays (or reimburses you) for shipping. Most places have these types of policies, and, even so, rarely does equipment arrive damaged.

About the only downside to mail-order computers is that their support takes place over the phone. Most places offer an 800 number you can call at just about any time to ask a question. If you're more comfortable with in-person support, however, consider a local dealer or megastore.

One other perk to look for is free on-site service. This service is especially important if you live or work in the boonies, as I do. Make sure that this service is offered even after the warranty period expires, and double-check that your city and state are included in the on-site service deal.

## *Mail-order pieces' parts*



There's a difference between a mail-order brand-name computer and what I call "mail-order pieces' parts": No one should buy a mail-order pieces' parts computer as a first computer. Instead, if you take the mail-order route, buy a brand name you know: Apple, Compaq, Dell, Gateway, IBM, or one of a host of others I don't have time to list.

The main way you can recognize a pieces' parts mail-order outfit is that it sells pieces' parts in addition to complete computer systems. Right along with its main Pentium systems, you see a list of hard drives, memory, video cards, modems, printers, and other stock, ready to roll. Sure, those prices look good, but if the outfit doesn't offer the kind of service and support you need, why bother?

## Chapter 18

# Tips for Online Shopping

---

### *In This Chapter*

- ▶ Buying a computer on the Web
  - ▶ Using a catalog store
  - ▶ Building your own PC on a Web site
  - ▶ Computer-buying tips
  - ▶ Using a shopping agent
  - ▶ Tracking your order
- 

**Y**ou may find it odd that computers are required in order to buy computers, but that's the way it works on the World Wide Web. This situation makes sense: In the early days of radio, the items that were advertised the most were new radios. So why not sell computers on the Web?

If you have access to the Internet, you can use it as a resource for computer shopping. Every major computer manufacturer and nearly all the national catalogs plus many local stores have an Internet presence. The advantages and disadvantages of this new approach are what's covered in this chapter, along with other related information for anyone willing to computer-shop on the Web.

## *Buying on the World Wide Web*

Can you buy a computer on the Web? Certainly! Every computer I have bought in the past five years has been purchased through the Web. The last time I phoned in a computer order from a catalog was in 1997. (The last time I bought a computer in a store was in 1988!) But that's me. What about you?

If you're new to buying a computer, I don't recommend getting your first computer from the Internet. Why? Because you're undercutting the kind of service and support that would be available to

you otherwise. Finding those things hard is enough when you're shopping locally; imagine trying to find them on the Internet!

For people already bathed in the computer experience, buying online has some real advantages. As an example, if you know *exactly* what you want, you can easily find it online as opposed to searching through a catalog or wasting time on the phone or in a computer warehouse.

- ✔ Service and support *are* available from the Internet. Chapter 19 covers this issue.
- ✔ Buying on the Internet is often cheaper because you're not paying for overhead.
- ✔ If you already have a computer, you can easily buy peripherals or upgrades on the Internet.
- ✔ Buying online isn't foolproof. I have never had trouble with any computer company, but other online retailers have turned out to be rotten apples. As usual, if you have a recommendation from a friend or reliable source, go with it.



## *Finding a place to buy*

Every major computer manufacturer, most catalogs, and even local dealers have a presence on the Web. Therefore, finding them on the Internet is as easy as knowing their names.

Generally speaking, you find two types of stores on the Internet. One is the catalog store, which is essentially an electronic version of the same type of catalog you may receive as junk mail from time to time. The second is the store that lets you configure your computer the way you want, which is more the traditional walk-in computer store model.

**The catalog store:** Catalog stores are merely electronic representations of their pagebound junk mail brothers. A Web page catalog usually opens with a list of bargains or popular deals. You should find somewhere on the page a list of categories to browse or a place where you can search for specific hardware. Products may be listed by manufacturer, type of microprocessor, or price.

Note that nearly all the products listed in a catalog are sold as is. Generally speaking, with a catalog-type Web page, you cannot reconfigure items, and your choice of options is limited to what the manufacturer provides. The price is therefore cheaper than if you have special requests, but your choices are limited.

**Manufacturer's Web stores:** Another way to shop (a way more in tune with how this book is set up) is to build your own computer. That usually happens only with manufacturer's Web pages and their online stores.

The manufacturer begins with a basic system setup. Then you use the Web page to select various options and see how that affects the bottom-line price. For example, adding another 256MB of memory may cost you \$100, but selecting a smaller monitor may save you \$100.

As you work the steps on the manufacturer's Web page, the cost of the computer configuration is updated, calculated and displayed. You then select an operating system, software options, and shipping options.

If you make an error, such as selecting an incompatible piece of hardware, the Web page lets you know.

Even if you're not buying right now, the manufacturer's Web page can really help you get an idea of what each option costs and how much you will save if you change a configuration.



✓ Remember to use your hardware worksheet from Chapter 16 to help you get the best possible computer to match your software. Buying more hardware than you need (if you can afford it) is great!

✓ You can find a complete list of online computer retailers on Yahoo!:

<http://shopping.yahoo.com/computers/>



✓ Ensure that the vendor has a phone number and street address. You don't want to get stuck online and have to fumble with e-mail to get satisfaction. It's just doesn't work.

## *Placing your order*

Eventually, you reach a place on the Web page where you have to place the order. It's either the checkout button or the shopping cart button or some other obvious means to tell the Web page that you're done shopping and are ready to buy.

When you're ready to check out, review the items in your order. Confirm items and quantities or remove items from the list. Use the Update button if you change quantities or remove items.

When you're ready to buy, click the Checkout button or Continue button. The next few Web pages contain forms you must fill out.

Some Web pages want you to *log in* at this point, which is merely a handy way to recognize a returning customer. If you have never been to the Web page, you should create a new account. Having an account means that you don't have to reenter information each time you buy something.

You need to list your billing and shipping address. Eventually, you have to cough up a credit card number and expiration date. Gotta pay for it, you know.

After filling in everything and clicking the proper buttons, you eventually see an order confirmation page. *Print this page*. The page contains your order number, the items you ordered, plus the final damage to your credit card. If you cannot print the page, carefully copy down the order number. Do this step for future reference.

Many online retailers send an e-mail confirmation of your order. Print that out.

Now, you just sit and wait for the computer to arrive. You did opt for the express delivery option, right?



- ✔ If you're afraid to order online, look for an option that lets you print or e-mail the order form. You can then phone in the order using an order ID number or simply quote the catalog numbers over the phone.
- ✔ Nothing is wrong with ordering online. As long as you heed my advice in this book, you should have a pleasant experience and be able to quickly handle any problems that may crop up.
- ✔ Never has a reported case of credit card fraud involved an online retailer. Never! Buying online is as safe, if not safer, than ordering from a catalog or buying something in a store.
- ✔ Always pay with a credit card when you buy online. Though no reported fraud has ever taken place, I would be leery of a company wanting your bank account or Social Security number to buy a computer. They are absolutely not required.
- ✔ Avoid places that require your credit card number *before* you've selected anything to buy.
- ✔ You can check up on a potential dealer online by visiting the Better Business Bureau, at [www.bbbonline.org](http://www.bbbonline.org). Note that not all businesses are listed with the BBB.



- ✔ When you create an account for an online retailer, use a common user name or ID for yourself and a unique password. Do not use your credit card number as a password.
- ✔ Have your order shipped by a company that tracks its shipments. Tracking is covered at the end of this chapter.

## Comparison shopping

Buying a computer isn't about getting the lowest price. But if you have discovered that the computer you want is a common model — like a Presario or an iMac — you can take advantage of the Web to search for the lowest price, at [www.mySimon.com](http://www.mySimon.com), for example.

The mySimon site collects items and prices from various online retailers and shows you what comes up. Obviously, this isn't my recommended method for computer shopping. Only (and it's a big only) if your hardware worksheets have shown that you can have a generic type of prepackaged computer does this site help you find the best price. Otherwise, you may need to stick with a build-your-own method similar to the one offered by most manufacturer's sites, as described earlier in this chapter.



- ✔ You can find mySimon at [www.mysimon.com](http://www.mysimon.com).
- ✔ Technically, mySimon is known as a *shopping agent*.
- ✔ Another online shopping agents is Roboshopper: [www.roboshopper.com](http://www.roboshopper.com).

## Sleazy tricks used by online retailers

Not every online retailer is a jerk. Many offer quality stuff at low prices and ship it cheap. Some places cut corners to save money or to look better than their competition. The following list warns of some well-known tactics used by less reputable online dealers.

- ✔ **Bait-and-switch:** A very cheap computer or component is advertised but — oh, no! — it's suddenly out of stock or back-ordered when you check into it. An alternative is offered instead for a much higher price.
- ✔ **Repackaged goods are sold without any warning:** Although nothing is wrong with returns or refurbished equipment, you should have the option of buying either them or new stuff if you like. Refurbished goods should be clearly marked.
- ✔ **Handling charges or exorbitant shipping charges:** The cheapest price may not be the least you will spend! Some sleazy dealers add “handling” charges to your purchase,



which jacks up the price. Be sure that you understand all charges you will pay before you buy.

- ✔ **Credit cards are charged at the time of order rather than at the time of shipping:** If this is the case, you don't have to pay. Inform your credit card company and it will be happy to hold the charge for you. Say that you want to place the charge *in dispute*. Instructions are on the back of every credit card bill. You don't have to pay for something you didn't receive or for receiving something you didn't order. It's fraud, and it's illegal.
- ✔ **Your stuff is shipped elsewhere, and it's your fault:** It's not your fault. It's *their* fault. They must correct it, or else you don't have to pay. (See the preceding bullet.)

Even more tricks exist, but keep in mind that mail-order catalogs and local dealers can do many sneaky, nasty things too.

## Tracking Your Order

You probably just can't wait to get your new computer. Although anticipation is half the fun, you can while away the time by monitoring your purchase's progress on the Web.

Most retailers have internal tracking, which lets you monitor your computer's progress as it is assembled, tested, and shipped.

Even more fun is tracking the delivery as it hops around the United States. Get a shipment tracking number from the Web site as soon as your order ships. Then you can use the delivery service's Web page to see where your shipment is and when it's due to arrive.

Some Web sites automatically link you to a shipper's tracking service. If not, I list some common shipping companies here; armed with a tracking number, you can visit these sites to see exactly where your new stuff is and when you will finally get your hot little hands on it:

- ✔ **Airborne Express:** [www.airborne.com](http://www.airborne.com)
- ✔ **DHL:** [www.dhl.com](http://www.dhl.com)
- ✔ **Federal Express:** [www.fedex.com](http://www.fedex.com)
- ✔ **UPS:** [www.ups.com/tracking/tracking.html](http://www.ups.com/tracking/tracking.html)
- ✔ **U.S. Postal Service:** [www.usps.com](http://www.usps.com)

Click the Track or Tracking link on the main page. In some cases, you may have to select your country first.

## Chapter 19

# Searching for Service and Support

---

### *In This Chapter*

- ▶ Some important service questions to ask
  - ▶ Some important support questions to ask
  - ▶ Support issues for Internet shopping
- 

**A** common mistake new computer buyers make is spending all their time worrying about the brand name of a computer or the size of its monitor. But you can't overlook one extremely important factor: the service and support you need after you set up your computer.

Step 4 in the buying process is to shop for service and support, which is covered in this chapter. If you know anyone who has had a bad computer-buying experience, that person probably forgot this step. After reading this chapter, you won't be the one making that mistake.

## *How to Find Service and Support*

In this section, I make some enemies: Large warehouse stores and department stores are the worst places to buy a computer. Sure, the price may be nice, but after you buy your computer, you're on your own, and that's a mighty lonely place to be if you have a computer question with nowhere to go to get help. It's almost sad, really. My eyes are welling up now, just thinking about it (sniff, sniff).

The moral to this pathetic story is that shopping for service and computer support is just as important as shopping for the computer itself — more so if you're buying your first computer and don't want to feel lost.

To help you, use the list of questions in the next section to grill your prospective computer salesperson. If the salesperson answers most of the questions to your satisfaction, you have found your service and support. If not, you buy somewhere else.



- ✔ Price is not the most important part of buying a computer. You need service and support more than you need a deal.
- ✔ Not all warehouse or department stores have awful-to-no service and support. It helps to ask, though, so that you don't become one of the legions who discovers a lack of it later.

## Service Questions

*Service* means “Where does my computer get fixed?” and also “Who pays for it?” Consider asking the questions in this section.

### ***“How long is your warranty?”***

A typical computer warranty is only about half a page long, but that's not important. What is important is the length of *time* the warranty covers your computer.

All major computer manufacturers offer some type of warranty, from a few months to several years. Does the dealer support that warranty and offer additional coverage? Consider it a plus.

- ✔ Computer warranties may seem rather short — 90 days? But, really, that's enough to cover it. Electronic things, like computers, break early in their life cycle if anything is wrong. Otherwise, after 90 days of smooth operation, your computer should be good for at least four or five years.
- ✔ Be sure to check whether the warranty is a replacement or repair warranty. Replacement is better; few things on a computer can be repaired in a cost-effective way.
- ✔ After four or five years, the hard drive tends to die and the computer's internal battery needs replacing.

### ***“Do you fix the computers at your shop?”***

If the place that sells your computer fixes them too, great. If your dealer has to send your computer to Japan to have it fixed, buy it somewhere else.

## Extended-service policies? Don't bother unless. . . .

I don't recommend that anyone purchase an extended-service policy for a computer. The reason is simple: Computers are electronics. If it's going to break, it will break during the first few weeks of use. If your computer can survive that long, it should be around for its full lifetime, which should be anywhere from four to five years — longer if you take good care of your equipment.

The exception is for laptop computers. Because their internal parts are, by their nature, expensive and more integrated than desktop systems, do definitely consider getting an extended warranty for as long as you expect to keep your laptop. Paying a few hundred dollars now beats having to pay \$1,000 later to replace a laptop's motherboard. In that case, the extended warranty is worth every penny.



Note that many dealers don't fix the computers they sell. Instead, you must contact the manufacturer directly. They don't even accept bad equipment and rarely do they ship it for you. This is not a plus.

### *“Can you fix my computer at my home or office?”*

Because I live in a remote part of northern Idaho, I always insist that any computer I buy comes with an on-site service policy. When one of my computers broke awhile back, a representative from the company came to my home and fixed it right there on my kitchen table. (And, the service rep had a great view of the lake while fixing my computer.)

On-site service is a bonus, well worth it if you have to pay extra for it — especially if you live way out of town, like in Idaho.

## *Support Questions*

*Support* is help after the sale. It's not help in fixing the computer; it's help for you as a computer user.

For your software, you use the developer's phone support — or buy a good book. For some hardware, you may have to call the hardware manufacturer directly; for what you buy from your dealer, however, you should be able to call them. (Some supernice dealers even help you with your software questions.)

## A sample support question to ask

If you're unsure about whether a dealer truly allows you to ask questions after the sale, call up before you buy and ask this question:

"I am installing a game, and it says that I need to 'swap disks.' What does that mean?"

The answer to this question is something along the lines of "Take one disk out of the disk drive and put the next disk into the disk drive." It works just like changing cassettes in your car radio. If the dealer makes it sound easy on the phone, you have found good support. If the person sounds annoyed by the question or tells you to call the game developer, buy your computer somewhere else.

## "Can I phone someone to ask questions?"

This question is important. Does the dealer have someone available to help you? Many superdiscount places lack the proper support staff to deal with your aftersale troubles. Nothing is more frustrating than to plunk down Big Bucks for a computer and have the dealer ignore you when you come back for help 24 hours later.



- ✓ **Hint:** Any place that also sells TV sets and Levi's next to its computers probably doesn't give you much aftersale service and support.
- ✓ Your salesperson may not be the person you end up calling for support. Salespeople sell. Support people answer questions. (Although sometimes your salesperson may help, don't count on it.)
- ✓ Test the dealer! See the nearby sidebar, "A sample support question to ask," just to make sure that the sales rep is being honest about phone support.

## "Do you offer classes?"

All the better computer dealers have a classroom with a real live, human teacher right there, ready to help you do something bizarre, such as run Windows. It's a major plus. Some dealers have classes in conjunction with local universities or high schools. Great.

- ✓ Expect to pay perhaps a little more for the support, handholding, and general warm-fuzzy feeling you want. The price you pay is more than offset by removing aftersale anxiety.

- ✔ Obviously, buying from a catalog or on the Internet means that you won't have any classroom handy. That's right! It's a good reason to consider paying a bit more for local service and support.
- ✔ I first went out to buy a computer with \$1,500 in my pocket. I waited and waited in the showroom and eventually grabbed a salesman by the arm and said "What can you tell me about this Apple II computer?" He said, "Why don't you just go out and buy a book on it?" Needless to say, I bought my first computer elsewhere.

## *Support Issues for Buying on the Internet*

Buying on the Internet is just like mail order when it comes to getting support. Depending on what you bought and where, you could end up with an 800 number, on-site service, or the lonely echoes of your palpitating heart. But with buying online, you have to *dig* to find out which type of support is available and how the service works. Here are my suggestions:

- ✔ Always buy from places offering toll-free tech support. Many online dealers have a support line for everything they sell. Some have you call the manufacturer, which can be a letdown. Avoid a dealer who offers help only through its Web page.
- ✔ Ensure that the dealer supports what it sells and that it doesn't redirect you elsewhere. This is a "fine print" issue. Always read all the conditions when you buy. Sometimes, you have to click a special link to discover what the conditions are. Beware!
- ✔ If possible, try to sign up for on-site service.
- ✔ Scour that Web page! Look for support issues like a FAQ (Frequently Asked Questions) list, troubleshooting guide, comment location, feedback, or even maybe a chat room. Often, you can find common problems and their solutions on a vendor's Web page.
- ✔ E-mail support works, but it's spotty. When I ordered a computer online and the monitor was bad, I e-mailed the vendor. It replied quickly and sent me a new monitor along with a shipping tag. I put the old monitor in the new monitor's box and shipped it back. It cost me nothing, and I never spoke with a person. To me, that was amazing.

- ✔ On the flip side of e-mail support is the runaround issue. You can e-mail Microsoft all you want about its software bundled with your new computer, but Microsoft will tell you that it's up to the dealer to give you support. The dealer will claim it's Microsoft's job. And so it goes.
- ✔ If buying on the Internet worries you in any way, don't!

## Chapter 20

# Buying the Computer

---

### *In This Chapter*

- ▶ A quick review of the buying process
  - ▶ Spending your “extra” money
  - ▶ Taking the plunge and making the purchase
  - ▶ Remembering some last-minute buying tips
- 

**F**ind someone whose fingernails have been chewed to the nubs, and he has probably been looking for a computer. Simply mention “buying a computer” to anyone, especially someone who is now looking, and he’ll probably faint — maybe even die.

This book arms you with all the knowledge you need in order to know what a computer does. You have been braced, studied, quizzed, and oriented. It’s time to buy. A whole chapter for that? Yup. Buying is the big move that many people put off. This chapter is devoted entirely to motivating you to go for it.

## *A Review of the Five Steps*

Buying a computer is cinchy, as long as you follow the five steps as outlined in Chapter 1. As a review, here they are:

### **1. Identify your computer needs.**

This step is easy. What do you want the computer to do? Answer that question and everything else falls into place.

### **2. Find the software to meet those needs.**

This step is where you software-shop, which is covered in Chapter 15. The software boxes themselves describe the hardware required in order to run the software. (Remember that it’s the software that’s more important). Filling out your software worksheets marks the end of this step.



### 3. Find the hardware to run your software.

Part II of this book reviews all the hardware and software issues for you. Matching up all your software worksheets to the hardware worksheet is covered in Chapter 16.

### 4. Locate a place you can do business with — some outfit with both the service and support you need.

This step is the most neglected. If you ever have any problems buying a computer, or know of anyone who relates a horror story, the problem was omitting this important step.

### 5. Buy the computer.

Do it!

Why is this last step so hard? Because buying a computer frightens many people. Hopefully, those people will turn to this chapter first and then read the previous chapters to bone up on what's important. After that, this last step should be a snap.

## *What to Spend “Extra” Money On*

Buying anything above and beyond what you have written on your worksheets depends on how much you can afford. So, the real question is “Where should I spend my money first?”

Without a doubt, spend any “extra” money you may have on the following items, in this order:

- ✔ **Microprocessor:** First and foremost, buy yourself the fastest microprocessor you can afford. This is a must. If your software craves only a humble Pentium III, go for a Pentium 4. If you can afford the fastest Pentium 4, spend your money there. You won't regret it.
- ✔ **Hard drive:** Second, buy a higher-capacity hard drive. If you have followed the hard drive size calculation from Chapter 16 and can afford a larger hard drive, buy it.
- ✔ **Memory:** Get more memory. If your software can get by with 256MB, 512MB is even better. If you can afford it, get 1GB.
- ✔ **Monitor:** True, a 17-inch monitor is plenty big enough, but 19 inches impresses. And those 21-inch monitors — if you have the money — are wonderful.



The idea is to spend more money on the things that are the hardest to upgrade later. Everything on a computer can be swapped out for something faster and better, although some things are more easily swapped than others.

The most difficult upgrade is the microprocessor, so that gets first priority. Then comes the hard drive and the memory. Most computers can sport a second hard drive, and memory is easy to upgrade. Doing so first, however, saves you the trouble later (especially if you have the money now). Finally, you can replace a monitor at any time.



Often, the second or third item from the top is the best bargain. For example, rather than get the top-of-the-line hard drive or microprocessor, get the model that's one or two notches below that. There, you will find a bargain because you're not paying merely for the boasting rights of having the (current) top-of-the-line stuff.

## *When Do I Get My Computer?*

It's possible to go to buy a computer and walk out of the store with it that day. Most home and personal systems can be found this way. The iMac, for example, comes in its own, friendly box, as do numerous low-end and home PCs. It has everything you need! But if you have ordered a special configuration, receiving it may take longer.

Most of the time, plan on waiting anywhere from a couple of hours to several days for your computer, depending on how busy the dealer is and whether the dealer tests on your computer before giving it to you. (Read more about that subject in Chapter 21.)

Mail-order computers may arrive right away, or they may take anywhere from a week to three weeks to arrive. The amount of time depends on how busy the dealer is and whether the parts you need are in stock. Always ask! Never assume that the Federal Express driver is sitting there with his engine idling and waiting to unload your new computer.

- ✓ Computer sales are seasonal, like most things. End-of-the year, back-to-school, and Christmas are the busiest times to order and the longest times to wait for custom systems.
- ✓ High demand means that you have to wait.

- ✔ Custom computers also take time to build. I have waited up to three weeks before one of my systems was waiting for pickup on the dock. (I tracked its progress on the Web — which was interesting to watch.)

## Don't Ever Put a Deposit on a Computer!



When someone asks you for a deposit up front for your computer, run like the wind! Up-front deposits are one surefire way to find a shady computer dealer. You should never put down a deposit on a computer. The best way to be sure is to always pay by credit card.

Not everyone is out to rip you off. Most classic computer-store scams, however, involve a “rob Peter to pay Paul” scheme. Writing a check for your computer at this type of place usually means that you lose your money.

Paying with a credit card is the best option because you can always cancel your order. Most dealers don't charge your card until the computer ships or you pick it up. If you don't receive your computer and the charge shows up on your bill, call the dealer and ask what's up. If the answers or attitude don't sit well with you, immediately phone your credit card company and place the charge “in dispute.” The credit card company will tell you what to do from there.



Don't fret over having to put a deposit down to hold a special on-order item. For example, you may need some special piece of equipment that's not in stock. If so, a 5 to 20 percent deposit is okay to hold it. Again, use the dealer's reputation as the deciding factor and pay by credit card.

## Hey, Bud! You're Ready to Buy

It's time to take the plunge. Jump in with both feet, and get that computer. As always, you need to take into consideration and remember some things when you're buying your dream computer:

- ✔ Ask your dealer about *burn-in*, a period before you buy a computer when the dealer puts it through its paces, just to ensure that everything is working properly.



- ✔ Don't forget software! You need software to make your computer hardware go. Software is expensive; you eventually spend as much on software as you spend on your computer.
- ✔ You may want to get other items for your computer: a printer, scanner, digital camera, or other “toys.” These items are covered in Chapters 22 and 23, but for now just worry about the computer. You have enough to deal with when you get it!
- ✔ If your dealer offers classes, now would be a good time to sign up for one. Give yourself a week or so alone with your computer before you show up (with your yellow pad full of questions).

## *A few last-minute buying tips*

Never worry about technology making your computer obsolete. For example, you may hear a rumor that Apple is coming up with a new, more powerful line of iMacs — so what? Buy your iMac now and start using it now. The difference between today and tomorrow's computer is so slight that it's not worth mentioning. (Today's computer versus *next year's* computer is another issue, but you won't be waiting that long.)



Computer ads are riddled with cryptograms and small words that may earn you big points in Scrabble but confuse the heck out of any first-time computer buyer. Check any unfamiliar terms with *The Illustrated Computer Dictionary For Dummies*, 3rd Edition (Wiley Publishing, Inc.). Also, look in that book's index to find a more detailed definition or explanation.



Never pay for a computer with a check; use a credit card.



Try not to buy your computer on a Saturday. This advice has nothing to do with the zodiac. It's just that Saturday tends to be the busiest day for buying a computer. Also, most computer stores close on Sunday, so if you get stuck the first night, you have no one to call.

Allow yourself time to get to know your computer. Don't expect to rush home and instantly be brilliant with it. These things take time.

## *The final step is to . . .*

Go for it! When you're finally ready to buy, take a deep breath and buy your computer!



## Chapter 21

---

# Helpful Hints for Computer Setup

---

### *In This Chapter*

- ▶ Opening the boxes and unpacking everything
  - ▶ Finding a place for your computer
  - ▶ Setting up the console
  - ▶ Connecting cables
  - ▶ Setting up the monitor
  - ▶ Examining surge protectors
  - ▶ Turning the computer on
  - ▶ Turning the computer off
  - ▶ Dealing with hardware and software
  - ▶ Understanding your computer
- 

**N**othing can be more pleasing than opening up something new. Computer marketing types even have a name for it: the *out-of-box experience*. It almost sounds religious.

“Yes, Doctor, I had an out-of-box experience. For a moment, I saw our old bread machine, and then the water heater that blew up last year. It told me that I had to go back . . . go back to assemble my computer.”

Sheesh.

If you haven't yet put your computer together, this chapter offers some helpful hints and strategies. If your computer is fully assembled and up and running, skim to the section “Breaking It In: The Burn-In Test,” later in this chapter, for some helpful hints for putting your computer's wee li'l rubber feet to the fire.

## Check the Shipment

First things first. When you get the computer, review the packing slip. Compare it with your order. Ensure that everything you're due has come.

If you ordered from a catalog or the Internet, review the boxes before signing the delivery sheet. The friendly delivery service guy even helps you out if you notice a damaged box. Most services return the box immediately if it appears damaged. Just remember *not* to sign for damaged material!

- ✓ Count the boxes! An iMac comes in one box, and most other computers come in two — one for the monitor and another for the console. If you have ordered a printer, scanner, or other peripherals (like mondo speakers), they probably come in extra boxes as well.
- ✓ Sometimes, packing lists come separately, or you may have an invoice. Either way, make sure that you have all the boxes you need.

## Setting Up the Computer

Unless the nice person you bought your computer from sets it up right there on your desk, you have to do it yourself. It's much easier than it was in the early days. The first Apple computer (which cost \$666 in 1977, by the way) came as a bag of electronic parts. You had to solder the whole thing together from scratch!

Today, assembling a computer is easy, often easier than assembling a stereo or hooking up a VCR (but not by much). You don't even need a screwdriver.

### *Open the boxes*

Setting up a computer starts with opening big boxes — typically, two or three.

If one box screams "Open me first!" open it first. It probably contains instructions. Otherwise, open the console box and look for the setup instructions.



## Box-opening etiquette

Be careful when you're opening any box. The "grab and rip" approach can be dangerous because those massive ugly staples used to close the box can fling off and give you an unwanted body piercing. (It's fashionable in parts of Silicon Valley to have a large staple through the eyebrow.)

The same advice holds true with using a box knife: Use a small blade because you don't want to slice through or into anything electronic — or fleshy, for that matter.

After you find the instructions, locate the sheet that lists all the parts that came with your computer. Try to find all the parts to make sure that you have everything. Nothing is more distressing than discovering on Saturday that you're missing a part and having to wait until late in the day on Monday to use your computer.

If you bought any expansion options — extra memory or a network card, for example — the dealer will have installed them. You don't have to plug them in on your own.

Also, don't panic if you can't find some small computer part (like the keyboard) when you're unpacking your computer. These beasts come in lots of boxes and in boxes within boxes. Look everywhere before calling your dealer and accusing him of omitting something.



- ✔ Some boxes have opening instructions. I kid you not! My huge monitor had to be opened on top and then turned upside down so that I could lift the box off of the monitor. Remember that gravity is your friend.
- ✔ There is no easy way to ensure that the stuff installed inside the computer is really what you paid for. Generally speaking, however, news of improperly installed hardware, or "switcheroos," travels quickly. Your computer guru can quickly tell you whether your computer's console contains all the guts you have paid for.
- ✔ Always keep the phone numbers of your dealer and computer manufacturer handy. (Space is provided on the Cheat Sheet in the front of this book.) Also, look out for special support numbers; some manufacturers offer a 24-hour, toll-free support number. Write them numbers down!



## “What can I toss out?”

Nothing, yet. You can unpack most of the material in the boxes now if you like, setting each item aside. You will probably have several stacks:

- ✔ The monitor, with its cables
- ✔ The console
- ✔ The power cable
- ✔ The mouse
- ✔ The keyboard
- ✔ A stack of disks
- ✔ A stack of “free” offers and other paperwork
- ✔ Reference material

Just keep everything in its stack for now. You need each item as you build your computer. Eventually, after a few days or weeks, you can review all the stuff that came with your computer and decide what you want to keep. Some “free” offers can get tossed right away, but wait before throwing anything out until you *know* what it is.

## “Should I keep the boxes?”

Computers are shipped with a great deal of packing material, plastic bags, twist ties, rubber bands, nylons, suntan oil, and so on. For now, keep *everything*.

There are two reasons to keep the boxes and packing materials: to return a bum computer to the dealer and for when you move.

If the computer dies on you, you need something in which to ship it back. Believe me, it’s worth it to keep the original boxes. Some dealers claim that not shipping the computer in its original box voids your warranty. That’s not good.

If you move frequently, you should keep the boxes. Many moving companies don’t insure your computers unless they’re in the original packing material with the original foam peanuts and Hershey bars.



- ✔ Also, be on the lookout for boxes within boxes! Don’t toss out any box until you’ve examined it thoroughly for anything you may need.

- ✔ The boxes do make for clutter. After a year, I throw my boxes out. A year is usually well past the time a computer or monitor may turn sour, so then it's okay. (Back when I moved often, though, I kept all my boxes forever.)

## *Putting It Together*

Now that you know where the computer goes and you have everything situated for optimal computer usage, go ahead and put it together. How? Although each computer is different, you put everything together in some standard ways.

The whole operation takes about half an hour, or more if you have additional items, such as printers or scanners to install.

- ✔ Be patient. Take care. Give yourself plenty of room and time.
- ✔ Keep pets and small children at a distance when you set up your computer. If you keep a cold beverage handy, put it in a safe place (like in another time zone), where spilling it won't be a problem.
- ✔ You may need a flashlight to see behind your computer.

## *Where will Mr. Computer live?*

Find a home for your computer. Clear off your desk or tabletop, allowing enough room for the computer and keyboard. Remember that your computer will have an octopus of cables and peripherals around it. Make room for all that stuff too.

The computer must live somewhere near a power outlet, preferably an independent circuit with a grounded plug.



If it's a 20 amp circuit, all the better, though most computers and laser printers can function fine from standard 15 amp circuits. (If this amp stuff confuses you, never mind.)

- ✔ Computers need room to breathe. Don't put your computer in a closet, box, recessed vault, grotto, or other cave-like place with poor ventilation.
- ✔ Don't put your computer by a sunny window because that heats up the computer and gives it anxiety.
- ✔ If you can sit on the table, the table can support the computer. Don't put Mr. Computer on a wobbly table or anything you wouldn't sit on yourself (like the cat).



- ✔ The obvious place to set the computer is on a well-supported computer desk.
- ✔ An *independent circuit* is one not shared by other devices in your home or office. For example, if you plug your computer into the same circuit as the refrigerator or air conditioner, it may blow a fuse when either of those devices turns on.
- ✔ If you have a desktop computer, you can set the monitor on top of the console. If you have a minitower, set the monitor to the side. The minitower can even go on the floor, if you like.
- ✔ Try to position the computer so that no lights shine directly into the monitor. Your eyes can get frazzled from the glare of the lights or the sun. My eye doctor tells me that monitor glare is, in fact, the biggest cause of eye fatigue from using a computer.

## Preparing to plug things in

Just about everything on a computer has a plug that plugs into the wall socket. Your monitor, computer box, printer, and anything else that's peripheral (such as a modem) has to plug into a wall socket. Find that wall socket now!

- ✔ I recommend buying one of those *power strips* that lets you plug four, six, or more items into one receptacle.
- ✔ Make sure that the power strip is *off*. That way, when you plug something into it, the something doesn't turn itself on (which you don't want at this point).
- ✔ An even better deal is to get a surge suppressor or a UPS (short for uninterruptible power supply). A *surge suppressor* protects your computer against power surges, and a *UPS* gives you time to save your work when the power goes down. Check out the nearby sidebar "Ode to plugging things into the wall" for more information.

## Setting up the console

The first thing you're most likely to set up is the *console*, which is the box that everything else plugs into. It's the least mobile of the units you unpack, so setting it up first gives you a good starting base.

Remove the console from its plastic bag, if you haven't already done so.

Don't slide the console against the back of the desk just yet. In fact, twist the console around 90 degrees so that it's facing right or left. You need access to the back of it.

Plug the power cable into the console and then — ensuring that the console is turned off — plug the power cable into the wall. If you hear the console switch on after you plug it in, no problem: Just turn it off.



A map or large sheet of paper may come with your computer. That sheet tells you how and where to plug various things in. Refer to that sheet as you work through the following sections.

## *Attaching the mouse and keyboard*

Plug the mouse and keyboard into the console.

On a PC, the mouse and keyboard each has its own tiny hole into which it plugs. Each one plugs in only one way (you have to line up the pins with the holes). You have to push hard to plug one in wrong, so don't force things.

String the mouse cable out on your desk to ensure that it's not tangled or looped.

Set the keyboard and mouse out of the way so that you can attach other devices.

For the Mac, the keyboard plugs into the console and then the mouse plugs into the keyboard.

## *Attaching other devices*

If your computer has special external speakers, plug them in now. Locate the speaker holes on the computer. Plug the speakers in.

If you see left and right speaker holes, great! Otherwise, you need to plug in one speaker and then plug the second speaker's cord into the back of the first speaker. If you have a woofer unit, everything probably plugs into it first.

If the speakers need electrical power, ensure that the speakers are turned off and then plug them into the power strip.

## *Setting up the monitor*

If your monitor is separate from the console, set the monitor beside the console. This is not its final resting place — it's merely a way to set it down while you work.

Plug the monitor into the console.



## Ode to plugging things into the wall

Nearly everything that comes with a computer should be plugged into the wall or some similar wall-socket-like device. Ideally, the console and monitor should be plugged into a UPS, or uninterruptible power supply — a power source capable of running the computer during brief power outages.

Other devices should be plugged into a power strip or surge protector.

Printers can also be plugged into a power strip. A laser printer, however, should be plugged directly into the wall. (Printers don't need to be plugged into a UPS; just wait until the power comes on again to print.)

Here are some other power and electrical issues and rules:

- ✔ Never use an extension cord to meet your power needs. People trip over extension cords and routinely unplug them.
- ✔ Don't use any power splitters or those octopus-like things that turn one socket into three.
- ✔ Computers need grounded sockets, which must have three prongs in them.
- ✔ If the UPS has extra sockets, plug in your desk clock or an external modem.
- ✔ Not every UPS has full UPS sockets. For example, some UPS devices may have two full UPS sockets and two surge-protected sockets that are not backed up by battery.

Ensure that the monitor is turned off and then plug it into a power receptacle. If you have a UPS, plug the monitor into the UPS.

## *Plugging in other stuff*

Finally, anything else you bought also has to be plugged into the computer box. For example, an *external* modem (one that lives outside your computer) has a cable that connects the modem to your computer. The modem also has a cable that connects to a phone jack in the wall, plus a place for you to plug your desktop phone into the modem. (Yes, this process is complex, but if it weren't, it wouldn't be a computer!)

If you already have a printer, plug its printer cable into its back. Then plug the other end of the cable into the back of the console.

Plug in anything else as well.

## Finishing up

Plug all the power cords into the wall socket. Ensure that everything is switched off and then plug it all in.

Reorient the console so that it's facing forward and the ugly cables are 'round back. (Do this gently so that you don't unplug anything.)

If you have a desktop computer, you can set the monitor on top of the computer now.

Set up everything just the way you want.



- ✔ Do not set a large (19-inch or larger) CRT monitor on top of a desktop PC unit. The heavy monitor may crush the console, which is designed to support only lighter-weight monitors.
- ✔ If you don't have enough cable to put the keyboard and monitor to one side of the console, you can buy extension cables at your favorite computer store.
- ✔ Some monitors come with a tilt-and-swivel base, which enables you to move the monitor to various orientations, albeit stiffly. This type of base is also an option you can buy for the monitor if it's not already built in.
- ✔ As with the console, the monitor needs to breathe. Don't set anything on top of the monitor or cover its wee tiny air vents in any way.

## Turning the Thing On

To use your computer, turn everything on!

### *What to turn on first?*

Almost everything connected to a computer has an on-off switch. So, the question is obviously "Which thing do I turn on first?" An equally valid question is "What do I turn off last?" Decisions, decisions. . . .

The answer? Seriously, turn on the console *last*. Turning everything on at once is okay, but if you have a choice, make the console the last thing you turn on. That way, it "sees" and recognizes all the devices plugged into it.

## Turning it off

For both the Mac and the PC, you must properly shut down the computer. This process involves selecting a Shutdown command. Where it can be found depends on which version of Windows or Mac OS you're using.

If the computer shuts down by itself, great. The console turns itself off and you can turn off everything else by flipping its switch. If the console doesn't switch off automatically, flip its switch (or punch its button).

## Breaking It In: The Burn-In Test



One way to ensure that your new equipment is up to snuff is to put it through a special test — the *burn-in test*. The object of this test is to break in your new computer during its warranty period. If something is amiss, you want to know about it before the warranty expires.

When you take your new computer home, follow these two instructions:

- ✓ Keep your computer turned on 24 hours a day for two weeks.
- ✓ Once a day, turn the machine off, wait for a full minute, and then turn it back on.

Because of the way electronic components are designed, faulty chips usually go bad within their first 48 hours of use. By testing your computer this way, you're certain to find any faults immediately. Turning the power supply off and on each day helps to ensure that it's tough enough to stand the load.

After the two-week test, you can obey whatever on-off habits you have deemed proper for your computer. At that point, in fact, it will probably behave itself for years!

## What's Next?

With the computer all set up and ready to roll, you're probably tempted to turn it on. But, wait. You should look for a few things before you steamroller ahead:

- ✓ Find any manuals that came with your computer. Look for the ones that contain directions and troubleshooting help. Keep these manuals handy.

- ✔ Always retain the manuals that came with your computer plus any software manuals. Keep any disks and their software manuals together.
- ✔ You can throw away most of the little scraps of paper now. Don't throw away anything that has a phone number on it until you've written the number down elsewhere.
- ✔ Mail in your registration or warranty card. Note the computer's serial number, and file it away. In an office situation, you should keep track of all your equipment's serial numbers.

## *Dealing with software*

You may have purchased some software with your computer. If so, great. However, leave all those boxes alone for now. One mistake many beginners make is overwhelming themselves with computer software. Although it's okay to buy lots of software (and if you haven't, you will probably buy more later), using it all right away is counterproductive.

- ✔ Your computer's operating system is the most important piece of software you have. Find out about it first (see Chapter 13).
- ✔ Refer to Chapter 13 for more information about operating systems.
- ✔ If you have anything you must do — a priority project, for example — set the software you need aside from the rest of the stuff. For example, if learning how to use Quicken, Word, or QuarkXPress is your top priority, set aside the software and get ready to learn and use it first. Everything else can wait.
- ✔ Remember that no job can be done immediately. No matter how annoying your boss is, you must learn to use software before you can be productive with it. Give yourself at least two weeks before you squeeze something brilliant from a computer.



## *Dealing with other hardware*

You may have purchased other hardware goodies, each waiting for hookup and installation. Put them on hold for now. Trying to learn too much can boggle you. Handle the basics first, install extra hardware later.

- ✔ Installing internal hardware requires some type of computer nerd. True, you can do it yourself. Many books and magazine articles go into the details, if you want to bother with installing internal hardware. My advice: Force someone else to do it.



- ✔ External hardware requires a power cable and some type of cable to connect it with the computer. A few devices don't use a power cable (they run off your brain waves). Also, you need special software to run the external hardware; a scanner requires scanning software, and a modem requires communications software.

## *Understanding Your System*

Give yourself time to read about your system, time to play, and time to relax and have fun with your computer. Believe it or not, the best way to understand how to use a computer system is to play around with it. Poke around. Test things. Try weird options, and see what they do. As long as you're not rushed to start your serious work, you have time to easily grow with the system. After the workload comes, you'll feel good about the system, and, lo, that expected and much-rumored frustration won't be there.



- ✔ After you have used your software for about a month, go back and reread the manual; you will be surprised at how much clearer it seems. It makes sense! (People who write manuals are overly familiar with the product and forget what it's like to be a novice.)
- ✔ By reading the manual a second time, you pick up a few more tips and some shortcuts. This trick is just another one the experts use to become experts.
- ✔ As a kind word of advice, give yourself two weeks to find out about your software before you start doing serious work with it.
- ✔ The more time you have to play with and figure out how to use your software, the more productive you become.
- ✔ Give yourself three weeks (if you have it) to become used to your new computer system. Then, when you're ready to get to work, you will know some tricks and you should proceed smoothly. Heck, you may be a computer wizard by then!

# Part IV

# Living with Your Computer

The 5<sup>th</sup> Wave

By Rich Tennant

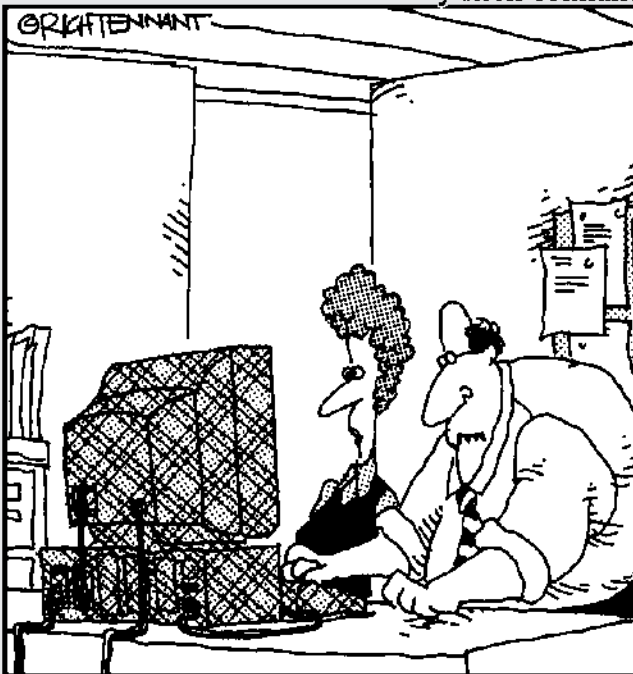

"Jeez-I thought the Registry just defined the wallpaper on the screen."

## *In this part . . .*

**W**ouldn't it be great if expedient and cheery young people in white lab coats would set up your new computer for you, making everything just so? Not only that, but they could sing show tunes while they snappily danced around your home or office. It's close to that. Many of today's systems come nearly ready to go with only a few things for you to assemble. Other systems take more time, but the issue here is that the buying process doesn't really stop after you've signed the receipt. No, there's more to do, and this book is here to help you do it.

This part of the book is devoted to aftersale euphoria — or depression. There's no sense in being left in a lurch with boxes, unpacking, assembling, and trying to work with things. So, this part of the book takes you through the stages of computer assembly and getting it up and running. Then I'll cover other things you need or may want for your computer, along with some good advice on how to maintain your computer for years to come.

## Chapter 22

# Time to Get a Printer

---

### *In This Chapter*

- ▶ Understanding the various types of printers
  - ▶ Buying a printer
  - ▶ Buying extra items for the printer
  - ▶ Setting up your printer
- 

Your new computer needs a printer. It's a necessary part of the purchase — like software. You can buy the computer and the printer together, or you can come back for it later. Either way, every computer needs a printer eventually.

This chapter covers the printer purchase. Fortunately, if you already have your computer and its software, picking a printer is a snap. As with the computer, it's software that controls your printer. Your software can instantly help you narrow your printer choices and options.

## *Different Printers for Different Printing*

Forget brand names. When it comes to printers, you can choose from two basic printer models:

- ✔ Laser
- ✔ Ink jet

Both types of printers get the job done. Both can do color. Beyond that, they differ in speed, quality, and cost.

- ✔ Generally speaking, you'll probably get an ink jet printer. They're fast, quiet, and relatively inexpensive — and they do color.



- ✔ Laser printers are a must if you're in business. Their chief advantage is that they're faster than ink jets.
- ✔ If you want color, go with an ink jet printer. Color lasers have dropped in price, but you still pay a premium — for both the printer and its supplies.
- ✔ Other types of printers exist. The most common is the all-in-one printer/copier/scanner/fax, such as the Hewlett-Packard OfficeJet. Also common are bubble printers and LED printers.
- ✔ Impact printers are required if you're printing on multipart forms. This type used to be the most popular type of computer printer (the “dot matrix” printers of days gone by). Now it's a special-order item.

## *Printer speed*

A printer's speed is measured in pages per minute, or ppm. The higher the value, the better. Some laser printers can manage 30 ppm, under optimal conditions, of course (usually repeatedly printing the same page of simple text). The more complex the graphics, the slower the printer goes.

Most ink jet printers manage between 8 ppm and 22 ppm. Color laser printers are very slow, typically dribbling out 6 ppm or fewer. Remember that what you see in the ads is an optimal value. The page-per-minute values you experience will doubtlessly be less.

## *The print quality*

Print quality is judged by how well the printer produces an image on paper, which depends on how many tiny dots the printer can squeeze on a square inch of paper. The more dots, the higher the printer's resolution and the better the image.

Early laser printers could print 300 dots horizontally by 300 dots vertically. Today's models can easily manage 600 x 600 dots in a square inch. Some models can manage 1,200 dots per inch (dpi), which is the same resolution as a professional typesetting machine.

Ink jet printers have similar dots-per-inch values. Higher resolution is available, but you pay more for it. Also, the print quality on an ink jet printer depends greatly on the paper quality. Special ink jet printer paper is available and produces a much better image (the paper literally absorbs the image).

## How much?

Printers range in price from less than \$100 for a cheap model I wouldn't wish on anyone to \$2,000 for high-quality color laser printers. You'll probably pay anywhere from \$250 to \$600 or more for your printer, depending on what you get.

Several things affect a printer's price. The top two are quality and speed. But between the various models, you find subtle differences based on these factors:

✔ **Memory:** Some printers come with about a megabyte of their own RAM, more or less. The more memory you add to a printer, the faster it goes — especially for graphics. In fact, if you plan to print lots of graphics, pay the extra money and load your printer up with RAM.

✔ **Brains:** Some printers are actually computers, ones specifically designed to print on paper (not foul up your phone bill). Cheaper printers? They're cheap because they don't have brains.

For example, you may notice that one color ink printer costs \$390 and another model — just as technically good — costs \$120. The difference? The \$390 model has a brain. The \$120 model uses your computer as its brain, which means that it takes that model longer to print *and* your computer slows down while the printer is printing.

✔ **PostScript:** A special type of laser printer is the PostScript printer. Essentially another type of computer, this one is dedicated to producing high-quality images. The PostScript printer does all the thinking on its own. Your software merely says “Do this” and the printer does the rest, freeing up the computer to do other things.

PostScript printers originally appeared for the Macintosh computer. Although you can get one for your PC as well, you have two pills to swallow. The first is that PostScript printers are expensive. All them thar PostScript brains cost money. The second pill to swallow is that PostScript printers work best with software that produces PostScript output, primarily graphics applications, though you can look on the side of any software box to see whether it's PostScript-happy.

✔ **Other stuff:** Oh, and other factors determine a printer's price: whether it has optional networking, a wider paper-feed mechanism for printing “sideways,” an alternative paper tray for legal paper, a duplex device for printing on both sides of a sheet of paper, and other details too technical to bore you with here.



✓ For some reason, the USB version of a printer costs more than the printer port version of the same printer.

Remember that all Macintoshes now use USB printers. If you have a Mac, you must get a USB printer.

## Laser Printers Go “Fwoom Pkt Shhh!”

*Laser printers* are similar to the old desktop copying machine, and they work on the same principles. The difference is that a laser printer receives its information from the computer rather than use a reflected image, which is how the copy machine does it. A laser beam is used to draw the image.

Laser printers have really come down in price over the past decade. Today’s models are cheap and reliable and don’t use all the watts required of the earlier models.



To print the image, the laser printer uses a toner cartridge. This item can be expensive! If you have a choice between two laser printers of similar quality, check the cost of the toner cartridge. You may think that you’re saving money on a printer now, but if it costs you \$150 a year (or more often) to replace the toner cartridge, are you really saving money?

Color laser printers? They use *four* toner cartridges (black, magenta, cyan, yellow). That can get spendy over time.

## Ink Printers Go “Thwip, Sft-Sft-Sft, Clunk!”

Up front, what you fear: Ink printers work by spewing ink all over paper, similar to the way a three-year-old spits water on his little brother in the bathtub.

Now, the truth: An *ink jet printer* works by lobbing a tiny ball of ink precisely at the paper, forming a teensy-tiny dot on the page. The ink dries instantly, and the resulting piece of paper doesn’t smudge. In many cases, the paper looks *exactly* like it came from a high-priced laser printer.

Another truth: Ink can be any color. Most of the newer, swankier ink jet printers lob four different colors of ink at the page: black, cyan, yellow, and magenta. These colors combine to make outstanding — almost photographic — output.

The only downside to the ink printer is the cost of the replacement ink cartridges. In two words, these cartridges are outrageously expensive! Not only that, but the cartridges also run dry when you print often, forcing you to continually pay for newer cartridges! It's an endless cycle!



- ✔ Odds are pretty good that you'll get an ink printer for your first computer purchase. It's a good way to go.
- ✔ If you can afford it, get an ink jet printer that uses separate ink cartridges for each of the four color inks: black, cyan, yellow, and magenta.
- ✔ Because little mechanical movement is involved, ink jet printers are quiet. Sometimes the brand name implies something about the printer's silence: Quietwriter, Whisperwriter, and Gaspingsforairwriter, for example.
- ✔ When you buy the printer, make sure to buy some spare ink cartridges.
- ✔ That special photographic paper is expensive. I just bought a box of eight sheets for \$15. (Call me dumb, but it's what I do for a living.) The output on that paper, however, is almost the same as an 8-x-10 photograph.

## *Buying the Printer*

Buying a printer can be done at the time you buy a computer or later, after you've toyed with the computer a while. No rule says that every computer must have a printer. And you don't have to print everything you do on the computer.

- ✔ Your computer manufacturer's brand-name printer isn't required for your brand-name computer. Just about any computer can have any printer attached. It doesn't matter.
- ✔ Printers can be added to a computer at any time.
- ✔ Your computer has the ability to control more than one printer at a time. You can add many printers via the USB cable. On a PC without USB, you must add additional printer ports to connect more than one printer.



## *What does your software say?*

To find out which printer works best for you, check your software.

Not all software has specific printer suggestions. Some software merely says on the box, “Any PC- or Windows-compatible printer.” But some types of software, especially graphics programs, say “Any compatible printer or PostScript printer.” In that case, you should look into getting a PostScript printer for the best possible (and fastest) output.

## *Printer shopping*

You don’t have to buy the printer at the same place you bought the computer. It’s nice, for example, if you had a pleasant buying experience and want to honor that place with repeat business. But if its price is too high or it doesn’t sell what you want, feel free to go elsewhere.



- ✔ If you’re set on a specific make and model of printer, consider using the Internet to shop — after all, you have a computer now! Use a shopping agent, like mySimon (as described in Chapter 18) to help you find the cheapest printer.
- ✔ The same rules for buying a computer — or buying any extra hardware — apply for buying a printer.

## *Printers do not come with cables!*

Before diving in to the fast and exciting world of printer types, you should note one little-known axiom of the computer-buying world: Printers do not come with cables. Gasp!

Unlike a stereo or VCR, which comes with all the required cables, a computer printer doesn’t come with everything you need to hook it up to your computer. The reason is simple: Not all printers are hooked up to the same type of computer.



- ✔ The printer cable can’t be more than 20 feet long, which is kind of common sense because the best place for your printer should be within arm’s reach — or did you know that? Well, now you do.
- ✔ A USB printer cable should be three meters (nine feet) or less in length.

- ✔ Note that a USB cable has A and B connectors. Ensure that you get the proper one for your printer to plug into your computer.
- ✔ Most computers are now sold with a “smart” printer port. If your printer takes advantage of the smart printer port, ensure that you buy a smart printer cable. Some cheaper printer cables lack the smart feature (which is merely a few extra lines of data).

## ***Printers don't come with paper, either!***

It almost goes without saying that your printer needs paper. Laser printers eat regular copy-machine paper, or you can pay more to get special high-quality paper.

Ink jet printers can print on any paper as well, though do yourself a favor and get special ink printer paper. It costs more, but the quality is worth it. Also, specialty papers are available for creating photographic-quality output as well as iron-on T-shirt transfers, transparencies, and other fancy time-wasters.

Don't bother with fanfold paper (the kind with the sheets connected to each other) unless you have a printer that has a proper paper feeder. Some ink printers have them, nearly all impact printers have them, but laser printers do not.

- ✔ Always buy the proper paper for your printer. Look in the documentation that came with your printer. Sometimes, printer manufacturers recommend the kind of paper that is best for your printer.
- ✔ Stock up on paper! Nothing is worse than running out of paper and not having any backup. Go to a discount paper warehouse place, if one is near you, and buy a whole box.

## ***Buy some extra ink***

As long as you're at it, buy your printer a second toner cartridge or backup ink supply. That way, if you run out quicker than you expected, you have the replacement handy.

## Setting Up the Printer

Setting up a printer is a snap. Like most things, there is a hardware part and a software part to adding a printer to your computer system.

Initially, you set up the printer similarly to the way you set up everything else: Take it out of the box, unpack it, and then set it where you want it. Put the printer near the computer — the nearer, the better — although it doesn't need to be too close.



- ✓ Keeping the printer at arm's length can come in handy.
- ✓ Be sure to look inside the printer box for its software discs (CDs), manuals, font cartridges, and other stuff the printer needs.

### *Printer pieces' parts*

Printers come in many pieces. You have the printer itself, the ribbon or toner cartridge, and the thing that holds the paper. An instruction sheet that comes with the printer explains what goes where. Find that sheet and heed its instructions.

Basic printer setup requires yanking a few shipping items from the printer's insides, installing the ribbon and toner cartridge, setting up the paper-feeding mechanism or paper tray, adding any font cards, and plugging in the cables.

- ✓ Si la feuille du mode d'emploi a l'air français, c'est peut-être parce que c'est écrit en français. La plupart des modes d'emploi ont des directives en plusieurs langues. Il faut chercher la version en anglais.
- ✓ If the instruction sheet reads like it's written in French, it probably is. Most instruction sheets list instructions in several languages. Look for the English version.
- ✓ Some printers may require a detailed internal setup, which means that you yank out several plastic doohickeys, peel tape, and apply salve to the printer's aching foot pads. Those parts hold the printer's insides inside during shipment. You don't need to keep them; freely toss them out (even if you plan on moving the printer later).
- ✓ If you purchased extra memory for your printer, install it before you turn the printer on. Or, better still, have your dealer install it for you.

## Sharing one printer between two computers

It's possible — and often cheaper — to share one printer between two or more computers. So, although it may seem nifty to have a printer for each computer, it's really not practical. The better solution is to *network* your computers and then share the printer between them.

Networking involves both hardware and software. You need the hardware to physically connect both computers, and then the networking software ensures that the computers can talk with each other, share files, and do other nice networky things. Connect the printer to one or the other computer and inform the operating system that the printer is to be shared, and then both computers can access it.

For more information on networking, refer to a good networking book or general PC reference.

## *Connecting the printer cables*

Printers have two required cables: the power cable, which plugs into a wall socket, and the printer cable, which plugs into the computer. (Congress passed a law ten years ago requiring that every computing device have, at minimum, two cables.)

- ✔ The majority of printers plug into the computer's printer port. Aren't you glad that makes sense?
- ✔ Some PCs use a serial printer that plugs into the PC's serial port.
- ✔ If your printer has both printer port and serial port options, use the printer port. You'll thank me later.
- ✔ The PC standard of tomorrow is the Macintosh standard of today: All Mac printers plug into the USB port.

## *Telling your computer about the printer*

The final step to setting up a printer is to let the computer know about it. You do this by using the software disk that came with the printer.

The printer's setup manual may tell you the sequence of steps. For example, some printers may just need to be plugged into the computer. At that point, the computer may recognize the printer and set things up automatically. Most of the time, however, you do manual setup.

Because each operating system handles printers differently, refer to your own operating system's manual or a good book for information on the software side on setting up a printer.

## Chapter 23

---

# Moving to Your New Computer

---

### *In This Chapter*

- ▶ Transferring hardware to a new computer
  - ▶ Using an older printer
  - ▶ Reinstalling your old applications
  - ▶ Moving data files to the new computer
  - ▶ Eliminating preinstalled software
- 

**O**ftentimes, your new computer purchase is really a replacement computer purchase. For example, you were computing in the Stone Age with an old Packard Bell, or maybe you're upgrading your first Pentium to a brand-spanking new Pentium 4 powerhouse. I upgrade my office computers every four years. It's a thrill!

Although the new computer may delight you, what do you do with all the *stuff* on your old computer? Does it just sit there? Or, can you move it over to the new system? The answers lie in this chapter, which covers moving both hardware and software to your new computer system.

## *Moving Over Hardware*

If your main reason for buying a new computer is to replace an older computer, consider what really needs replacing. Quite a bit of the older computer's hardware may find a home inside or alongside the new computer. It all depends on the shape of the older system's components. The following sections illuminate what can, might, and shouldn't be moved to the new system.

## *Antiques: Don't bother*

If your early computer is older than four years, the thing probably has no hardware that would serve the new computer well. For example, I have an old, old Macintosh Quadra. Nothing inside that computer would work with a new Mac system. Nope, nothing. Ditto for older PCs versus newer systems.

- ✔ If you have purchased any new peripherals or monitors for the older system, they may be able to be passed on to the new system. See the following sections.
- ✔ So, the hardware is crummy — but don't forget your data and software! See the sections later in this chapter for moving over your software.
- ✔ Honestly, computers never really go out of date as long as they work. The new computers are faster, but given the choice between using an old clunky IBM PC/AT, DOS, and WordPerfect 4.2 versus a typewriter, I would take the old clunky PC any day of the week.

## *Monitors*

CRT monitors tend to fade and fuzz out with time. If your older computer's monitor is doing well or you just bought yourself a new LCD monitor, you can move it over to your new computer. Not buying a monitor can shave a few hundred dollars from a new computer's purchase price.

As an example, I purchased one of those new flat-screen LCD monitors for an older computer whose monitor was on its dying days. When I replaced that computer a few years later, I simply bought a new console and moved the LCD monitor over to the new computer.



- ✔ As long as the monitor is in good shape, use it!
- ✔ Even if you already have a monitor for your new computer, you can add the second monitor to the system. Most computers support dual monitors. (Windows XP Home Edition, sadly, does not.) Note that you need a second video adapter to make this happen.

## *Disk drives*

I would not recommend removing older hard drives and installing them into new computers. The hard drive is one of the first things to go on an older system, so relying on it for a new computer is

risky. Even installing the older hard drive as a “backup” is questionable. No, you’re better off just getting the information from the hard drive and using a newer unit.

External disk drives can easily be moved to a new computer, simply by plugging them in. Always make sure that you have the original installation disks, which helps the new computer recognize your older hardware.

Some internal disk drives, CD-ROMs, or maybe a new DVD or CD-R you added can be moved over to the new system — no problem. Again, remember the original software installation disk so that the operating system recognizes the new hardware.

## *Memory*

Memory is something you generally cannot move from computer to computer. The reason is that older memory is probably much “fatter” than your new computer can handle. By fatter, I mean the memory is probably of lower capacity and slower speed; a new computer probably needs higher-capacity memory (64MB versus 16MB SIMMS, for example) and faster access times. No, moving over memory is a waste of time.

## *Expansion cards*

Some expansion cards may work in the newer system; some may not. The best advice I can offer is that if you have recently purchased an expansion card for the older system *and* it offers some feature the newer system lacks, consider the move.

Suppose that you just bought a USB expansion card for your old PC and the new PC also lacks USB ports. Moving over the old USB expansion card could be a good move. Ditto for newer network cards and high-end graphics adapters.

- ✔ See Chapter 10 for more information on expansion cards.
- ✔ You ensure the best success by moving plug-and-play expansion cards to a new system.
- ✔ PCI and AGP cards are the best candidates for transfer to a new computer.
- ✔ Also worthwhile are specialty cards: video input cards for any video-editing software you own, sound synthesis, and special waveform cards, as well as anything else you need with your software.



## Printers

The easiest thing to move from an older computer to a newer model is a printer. This makes total sense: There's no point in buying a whole new printer just because you have a new computer. As long as the printer is working just fine, keep it!

- ✔ You may need a new printer cable. For example, new Macintoshes require USB printers. If your older Mac printer used the old Mac printer interface, you need to buy a USB-to-Mac printer adapter. Most mail-order places have this item.
- ✔ Don't forget your printer's original software disk! You may need it to install the software drivers for your new computer.
- ✔ My main printer has been used with four different computers. It's a robust little guy who has served me well for more than nine years!

## Modems

Internal modems need to stay internal. Don't even bother removing one from your old computer. If you have followed my buying advice, your new computer already has an internal modem. For cable and DSL or external dial-up modems — yes! — most definitely, move them over to the new system.

## Other peripherals

Peripherals can easily be moved from an old computer to a newer model. For example, I'm typing these words on a classic IBM keyboard that I have been using for almost eight years now — even though this computer is only three years old. (I'm picky when it comes to computer keyboards.) This IBM keyboard, if it lasts, may even find its way to whichever computer replaces my current model. . . .

Scanners can also be passed from computer to computer, as can most other peripherals. As long as you always have a way to connect the device to the computer and you still have the software and installation manuals, reinstalling the peripheral for the new system is a snap.

- ✔ No, there is no reason to buy a new scanner for a new computer if your old scanner works just fine.
- ✔ This peripheral-keeping and -sharing will become even more popular as USB devices take over the world.

- ✔ As you get more adept at using and upgrading computers, you may find yourself ordering the minimum when you buy. Just transplant your favorite items from the old system to the new model and you're off and running in no time!

## Transferring Your Software

There are two parts to the software you transfer to your new computer. The first is the programs you have accumulated — programs you want to install on the new system. The second part is the data you have created. You may want to keep all that stuff as well — which, in many cases, is probably more important than all that old software anyway!

### Reinstalling applications

Because you're an honest person, you purchased all your software from a retail store, or the software was included with your computer purchase. Whatever the case, you have the original box, manuals, and disks that came with the software. (That stuff is important — pray tell you didn't toss it out!)

When you move to the new system, you need to “move over” your old software: Simply reinstall each program on your new computer.



You *must* reinstall the software. You cannot simply copy the program files from one computer to another. These days, software has to be installed properly for it to work. If you copy the programs from the old computer (however that's done), things most likely will not work to your expectations.

I suggest installing the software as you need it. For example, if the first thing you want to try with your new computer is your word processor, install it. Ditto for a game or an “office” suite or any software you use.



- ✔ Some software has to be uninstalled and reregistered before you can reinstall it on your new system. This process typically involves a phone call to the developer.
- ✔ Some software may need corresponding hardware installed. For example, your imaging software may yearn for the presence of a scanner. Better install that scanner first.
- ✔ Older software may not be compatible with the newer computer or its operating system. Oops! If you see any sort of error message or get a warning about incompatibilities —

*ka-ching!* — you need to pay for an upgraded version of the program. Yes, this happens.

- ✔ Some applications on your old computer may be “upgrade” or “OEM” versions. For example, the version of Microsoft Word that came with your old PC may be an OEM-only version (it was supplied by the computer manufacturer), and you may have trouble installing it on a new computer. My advice: Try your best! If it doesn’t install, you have to go out and buy the program. Yes, I know that this is unfair, but it’s how it works.
- ✔ Occasionally, an upgrade merely needs to “see” the preceding version’s disk in order to install the upgrade. That’s a good reason for hanging on to your old software manuals and disks.

## *Moving over data*

Ah! The tricky part. On your older computer, you probably have lots of files you have created — documents, images, and other information you need and use every day. I call them “data files.” The object is to get those data files over to your new computer — if not all of it, at least the stuff you really, *really* need.

Here are the methods you can use to move over your data files:

**By disk:** Copy all your data files from the old computer to a CD-R or Zip disc. Then move the files over to the new computer, copying them from the removable disk to the hard drive. Yes, this is lots of work. (I have done it many times.)

**By network:** If your computers are connected by a network, you can easily access the files on the old system and “beam” them to the new computer. This method is by far the easiest and most efficient way to do things. In my office, I typically keep the old system up on the network for months to ensure that I’ve pulled off every single file I need.

**By cable:** Second best to the network method of transferring files is to directly connect both computers using a special data-transfer cable, available at most computer and office supply stores. You can then use software that came with your computer to help you move the files (for example, the Data Migration Wizard that comes with Windows XP).

**By gizmo:** Lexar Media ([www.lexarmedia.com](http://www.lexarmedia.com)) makes a nifty solid-state USB drive that you can plug into any computer with a USB port. You can use this palm-size device to copy files from the older computer to the new, with no cables or disk swapping needed.

However you make the connection — disk or cable — moving over the files is an important part of making the move. I miss the files I have left behind on various computers over the years.



- ✔ An interesting piece of software to check out is the Miramar System ([www.miramar.com](http://www.miramar.com)) Desktop DNA. It grabs not only software but also personalized settings and other options, allowing you to move your old computer's "personality" to the new system.
- ✔ Also available is the Personality Transport program, from Tranxition Corporation ([www.tranxition.com](http://www.tranxition.com)).

## *Eliminating the preinstalled bonus crap*

Most computers sold today come with prepackaged *stuff*. I find this most unnerving.

Sometimes, the stuff is useful; for example, you get a new computer and a brand-new version of Microsoft Office. Or, maybe you have your choice of Office versus a home package (including Quicken and maybe Word) or a gamers' package with a ton of nifty games. That's fine.

What's not fine are the bonus programs they give you that you don't want and will never use. That's bunk. And it junks up your hard drive. Of course, the question looms about what is really junk that you can remove versus which programs are valuable and keep the computer running.

- ✔ **Stuff you can freely delete:** I have noticed that most, if not all, new PCs and Macs come with programs to connect you with various online services. If you want to try them, swell! If not, delete them. Ditto for any other offer for online services or Internet connections you don't want or feel that you will never use. Zap 'em away.
- ✔ **Free trials:** These trials include anything you get that's offered as a free trial or demo version of some program you can zap away. Bother with keeping something to check it out only if you're interested. If you're not interested, remove it.



Be careful how you remove things! In Windows, always use the Control Panel's Add/Remove Software icon. Peruse the list that's displayed and uninstall anything there that you don't want. If you're unsure about something, phone the dealer and ask what it is or whether you need it. Then uninstall!

This problem isn't as pervasive on the Macintosh as it is on the PC. Only Apple makes the Mac, and Apple has not (at least since 1986, when I bought my first Mac) preinstalled junk the way junk is preinstalled on a PC.

Still, you may notice, for example, both Netscape and Internet Explorer available on your Mac. If you use one, drag the other's folder to the Trash. Ditto for AOL and other online service sign-up icons. If you don't need 'em, drag 'em to the Trash.

# Part V

# The Part of Tens

**The 5th Wave**

**By Rich Tennant**

AT 11:18 ON APRIL 25<sup>TH</sup> IN THE YEAR 2003, PC SOFTWARE AND HARDWARE REACHED A PERFECT APPLICATION-TO-MEMORY SYNCHRONICITY.

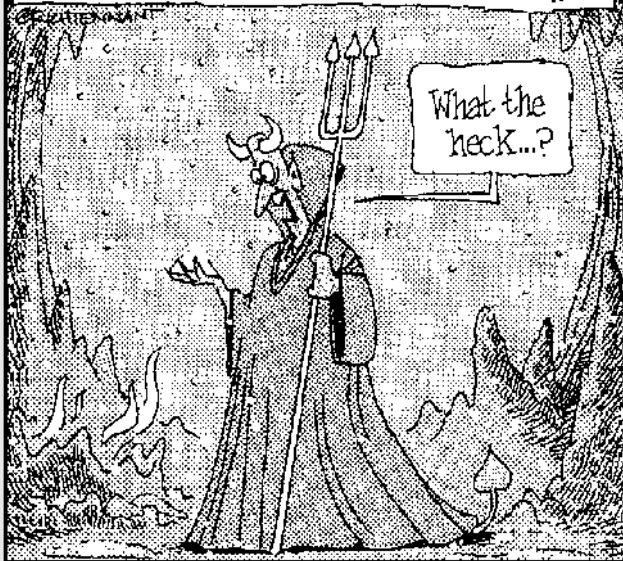

## *In this part . . .*

**L**ast-minute lists always need to be checked off. For example, when you travel by air, the pilot and copilot in the plane check off dozens of tiny items to ensure that the trip is a safe one, that they'll have enough coffee, and that they can see out of both eyes. The same types of lists need to be completed when you buy a computer.

The chapters in this part of the book contain lists of ten items (sometimes more, sometimes less), which you should review at various stages in the buying process. It's all good advice. Read it and heed it.

## Chapter 24

# When to Buy, When to Sell, When to Upgrade

---

### *In This Chapter*

- ▶ Knowing when your computer is a geezer
  - ▶ Deciding whether to upgrade your old stuff
  - ▶ Determining whether to upgrade the microprocessor
  - ▶ Upgrading your software
  - ▶ Upgrading your operating system
  - ▶ Selling your computer
  - ▶ Considering used computers
- 

**N**othing lasts forever. Well, except for death and taxes (but you die only once). Diamonds last a while. But most things have a life span. For example, rubber spatulas seem to last about three months before they get all melted and cracked. Cars? Maybe five or seven years (just enough time to pay off the loan). Computers? They have life spans too.

Expect your computer to last at least four to five years. Although a computer can last longer, technology advances so much and software demands new technology so strongly that after four years, your new computer is seriously outdated. What should you do? Should you sell it? Should you upgrade it? Should you buy a new one? This chapter helps you make those decisions.

## *Unlike Wine and Cheese, Computers Don't Age Well*

Nothing is more disappointing than reading a computer ad six months after you buy a computer and discovering that you could



have had, for the same money, a much better computer. Don't get discouraged! This situation happens *all the time*, which is why I say "Buy!" when you're ready to buy. You have your computer. You're using it. That's much better than waiting.

When exactly does your computer become a true geezer? Generally, after four or five years of duty. After that time, two things generally happen: The hardware becomes much better and cheaper, and the software starts craving that better hardware. A third thing also happens: Your computer starts to go south. The hard drive may start making a louder noise, especially when the system first starts up. It's a sign that the bearings are starting to go. (It's not an emergency; the drive may still have years of life left.)

## *Should You Upgrade?*

One of the joys of owning a computer is that you can upgrade or replace any of its components at any time — as long as the computer is turned off when you do so.

Upgrading is an easy alternative to tossing out a fairly good computer and spending more money on a new one. Upgrades are inexpensive. And, often, all you need is a simple upgrade: more memory, another monitor, another hard drive. A few twists of the screwdriver later and you have an almost new computer again. Upgrading should come from some serious need: Software demands more memory, you run out of disk storage, or something breaks.

### *Which hardware to upgrade first*

What you upgrade first depends on your needs. Does your software need more memory? Upgrade it. Is your monitor shot? Buy another one. Out of hard drive storage? Add another.

**Memory.** As long as your computer is properly configured for memory (refer to Chapter 6), plugging in another 128MB, or even 256MB, of RAM is relatively easy. This upgrade often solves a number of problems you may have with a sluggish computer.

**Hard drive.** Although plugging in another hard drive is easy, getting it going can be a pain. Hard drives must be formatted, and it's hard to find out exactly how that's done. Better leave this upgrade to your dealer.

The best part about upgrading a hard drive is that you can add a second hard drive of immense size. If you miscalculate and find

that 40GB of storage isn't enough, for example, buy an 80GB hard drive! You can install it right inside the console. Upgrading the hard drive is more expensive than upgrading memory. Because humans tend to collect things, however, you'll enjoy the extra space right away.

**Monitor.** Buying another monitor is cinchy: Buy it! Turn your computer off, unplug the old monitor, and plug in the new one. Done!



Old monitors don't keep their value. You cannot sell them, and you shouldn't toss them out in the trash. Instead, refer to your locality's disposal people for the proper method of tossing out an old computer monitor.

**Other stuff.** Just about everything in your computer can be upgraded. You can upgrade, in addition to the preceding items, your CD-ROM player, a floppy drive, a video adapter, or virtually any component in your computer.



Watch your upgrade costs! Sure, it may be fun to buy your computer a present in the form of an upgrade. Tally what you spend, though. If you're not careful, you may wind up spending more on your old computer than it would cost to buy a new one.

## *My \$.02 on upgrading your microprocessor*

Another hardware upgrade touted in the computer magazines is the microprocessor upgrade. It's not hard to do: The microprocessor slides or clips into a socket. Most computers are designed that way. I don't recommend it, though, for several reasons:

- ✓ **Cost:** When your dealer buys microprocessors to plug into his computers, he buys them by the truckload. He gets a discount; you don't. You pay top dollar for a new microprocessor, which can be several hundred dollars for the current top-of-the-line model. Spending your money on a memory upgrade may give you better results anyway.
- ✓ **Compatibility:** Although the new microprocessor may plug into the old one's slot, is the computer's circuitry geared to work with it? Motherboards are designed around specific microprocessors running at specific speeds. Although the new one may function, it may be crippled or inhibited by the older circuitry on the motherboard. What's the point of having a faster microprocessor when it has to slow down to access your computer's old memory, for example?

- ✔ **The whole motherboard upgrade:** This upgrade involves another microprocessor upgrade, which directly addresses the issue of compatibility, but not price! New motherboards (your computer's main circuitry) are spendy. If you go that route, you may as well buy a new case and a new hard drive and — hey! — you have a new computer! You have the old one too, gutted out and not good for anything.

## Upgrading software

You're often bombarded with developers' propaganda for upgrading their software. Hurry! Version 4.02 is available! It's only \$69 because you're a registered user and *we like you!*

When should you upgrade your software? As with everything else, the answer is "according to your needs." Do you *need* the new features the software offers? Does the new version fix the bugs that annoyed you? If so, buy it.

- ✔ It's possible and quite common to skip software upgrades. For example, skipping from version 3.2 to version 4.1 can save money *and* keep you current.
- ✔ If you're using the same software at home as you are at work, upgrade when your office does. If you don't, your older software at home may not be capable of reading the documents the newer software at work produces.
- ✔ A good argument to eventually upgrade any application, in fact, is to keep compatible with any new document formats. Eventually, you may find that others are using the software and that your older application cannot read those newer document formats.

## Upgrading your operating system

Like all software, your operating system eventually will have a new version. In days of yore, this situation caused a debate: Everything worked fine with the current operating system, so why upgrade? Even if the new version had exciting features, the upgrade may not have been compatible. It was a puzzle. Generally speaking, I can give you this advice:

*Never upgrade your operating system.*

The best way to get the next version of an operating system is to wait until you need to buy a new computer. The new version

comes installed on that computer. Otherwise, you risk a great deal by upgrading your current operating system, primarily that some of your older software may not be compatible, which would force you into paying lots of money for upgrades.

You may eventually encounter new software that requires the newest operating system. Traditionally, however, that doesn't happen until the new operating system is about two years old. Why? The answer is that because software developers don't want to lose you as a customer, they don't write a specific version of their applications until *everyone* has upgraded. So, don't panic.

## Should You Sell Your Beloved Computer?

I remember when friends of mine in the mid-1980s tried to sell their computers. They had sold cars, so they tried to figure the price of their used computers in the same way. The stuff never sold.

Used computers have no value. If you wait four or five years, the new stuff is so much better that you never can recover any value from your original purchase. I always have my accountant rapidly depreciate my computers, in fact, because they just don't hold any value.

If you do try to sell your computer, ask only \$50 to \$200 for it; use the higher price if it's a recent system. The best buyer is someone who already has that type of computer and wants to buy another one.

Sell everything when you sell. Make the computer as complete as you can. You can throw in software, too, although that doesn't add to the price of the computer. (Old software has no value.)



Ask for either cash (because it won't be that much) or a cashier's check for your old computer. The last insult you want is to sell something you paid \$2,000 for to a guy who writes you a rubber check.

A better thing to do with your old computers is to donate them to charities or schools. Give them as much computer as you can, including a printer. Give them your software manuals and disks. And, ask for a receipt based on the computer's fair market value (see an accountant for more information). You get more from the computer that way, as a tax deduction, and you give something back to your community.



## What about the hard drive and all your personal data?

When you get rid of your old computer, don't get rid of your personal data as well! The most secure thing to do is keep the hard drive. Offer your used system without a hard drive or, if you really want it to sell, buy a replacement hard drive for the computer. This is the safest way to ensure that your data doesn't get abused. (Companies that are serious about security remove hard drives from their old computers and have those drives physically destroyed.)

If physically removing the hard drive isn't practical, you can use software that bulk-erases the disk. This type of program comes with Norton Utilities (or Norton System Works). It's called *Wipe Disk*. Use it to utterly erase everything on your PC's hard drive so that none of your personal information is sold with the computer.

Other programs that can erase your hard drive include OnTrack's Data Eraser ([www.ontrack.com](http://www.ontrack.com)) and Jetico's BCWipe ([www.jetico.com](http://www.jetico.com)).

## Buying a Used Computer

You may have many reasons for buying an old computer. The most common is that you have a computer exactly like it and want another as a spare. Or, maybe your software just runs better with an older system. If so, buying a used computer saves you hundreds of dollars over buying a state-of-the-art system whose power just isn't needed.



Test-drive a used computer before you buy it. Take some software with you and load it up. Make sure that it runs. Save something to disk. Print something. If it works, the used computer is worthy.

Used computers, unless they have been used less than a year, are worth only a couple hundred dollars — max. Don't overpay! Check the classified ads to see what's being asked for used equipment. Then check the prices of new equipment and compare. Obviously, paying \$200 for an old 486 PC makes no sense with new PC models selling for \$400.



Someone may tell you, "Oh, but you also get \$2,000 worth of software for only \$200!" Just laugh at the person. "Ha-ha!" Old software has no value. Sure, the guy may have paid \$2,000 for it originally, but it's worth nothing now. Do insist that the seller include all the boxes (if they're available), original software, and documentation.

## Chapter 25

---

# Ten Common Mistakes Made By First-Time Computer Buyers

---

### *In This Chapter*

- ▶ Buying hardware rather than software
  - ▶ Shopping for brand names
  - ▶ Shopping for the cheapest system
  - ▶ Being unprepared for the sale
  - ▶ Forgetting the “extras”
  - ▶ Paying by check or cash
  - ▶ Not reading the setup manuals
  - ▶ Forgetting that software is expensive
  - ▶ Buying too much
  - ▶ Not counting learning time
- 

**I**f you have followed this book’s advice, you (hopefully) won’t fall into the trap of making one of the following ever-so-common mistakes. It’s worth putting them in a list, just as a reminder.

### *Buying Hardware before Software*

Software controls the hardware by telling it what to do. Don’t be tempted by marvelous hardware features. Don’t be lured into buying one brand or the other by some advertising campaign. Without software, the hardware is next to useless. Buy your hardware to support your software.

## *Dropping Brand Names*

When people find out what I do, they usually want my advice about buying a computer. “Dan,” they say, as they puff up their chests, about to impress me with some trivial tidbit, “I’ve been looking at the UltraDork computer. What do you think about it?”

“Big mistake,” I answer. It doesn’t matter which brand they mention; I always say the same thing. Software is more important than hardware. Most people don’t see that, so I’m not rude when I tell them. But thinking about brand names rather than what the computer will do is a big mistake.

## *Shopping for the Cheapest Computer System*

When you buy a *bargain system*, you will probably wind up with a competent and functional computer. When things go wrong, you want the dealer to provide service to get your system fixed. That bargain price often doesn’t include service, however. Look for a dealer you can grow friendly with. The dealer’s reputation, which is more important than price, is how it stays in business.

## *Being Unprepared for the Sale*

Computers have a different jargon (in case you haven’t noticed). Don’t expect a computer salesperson to be able to explain to you all the subtleties of things like VRAM, MMX, scan rate, MPEG, and USB 2.0. Some disreputable salespeople might even dupe you into paying more money for obsolete and unnecessary technology.

## *Forgetting Some Extra Items*

The ad says \$600, and you have just a hair over that — enough to pay the sales tax. Alas, you didn’t read the fine print: That \$600 computer doesn’t come with a monitor. Oops!

Ensure that you buy a complete computer system! Double- and triple-check the ads for any missing pieces. You need a monitor, a keyboard, memory, and a hard drive to make a computer system.

## *Not Paying by Credit Card*

Never pay for a computer with a check. Never pay cash. Always pay with a credit card. Why? Because credit charges can be put into dispute if anything nasty happens between you and the dealer. Credit card companies support their clients. If someone sells you junk, the credit card company doesn't force you to pay for it (as long as you have taken legitimate steps to resolve the problem).

Most banks don't let you reverse the charges on a check. If you pay cash to a shady dealer, your money is gone forever. Computer dealer scams aren't as popular as they used to be, but they still exist.

## *Not Reading the Setup Manuals*

As a general rule of advice from a self-proclaimed computer guru: Read things over before trying them. If you make a mistake or something doesn't happen right, read the instructions again and try a second time. Consider it a last resort to make that phone call to your dealer. Don't substitute the phone for the manual.

## *Forgetting That Software Is Expensive*

Contrary to what you may think, computer hardware is only half your cost. The computer software your computer needs probably costs the same amount as what you paid for your computer (over time, of course). Piece by piece, package by package, software is expensive.

## *Buying Too Much*

Start simple. If you buy too much stuff too quickly, you may go overboard and never find out all about your system. My recipe for becoming a computer guru, in fact, involves starting with a minimal system. After you have that mastered, upgrade slowly and learn as you go.



## *Not Counting Learning Time*

If you've just figured out that you need a computer "yesterday," you're too late. I advise everyone (businesspersons, students, or just the idle curious) to give themselves at least three weeks to use and become comfortable with their computer system before the real work starts.

## Chapter 26

# Ten Warning Signs

---

### *In This Chapter*

- ▶ Industry standards versus ads
  - ▶ Out-of-date stock
  - ▶ Money down required
  - ▶ Missing pieces
  - ▶ No address in mail orders
  - ▶ Salespeople too busy
  - ▶ You're ignored
  - ▶ No classroom
  - ▶ No software documentation
- 

**I**f all people were good, wholesome folks with high morals, standards, and a strong sense of customer support, I wouldn't have to write this chapter. Because this chapter is here, though, I suppose that you'll have a better understanding of human nature.

Because the computer industry is full of terms and standards that only real computer geeks have a knowledge or understanding of, it's rather easy to pull the wool over your eyes. I don't want that to happen. The best thing I can do is educate you on what to be aware of. Consider this chapter a computer-buying self-defense class.

*Hi-yah!*

## *Industry "Standards" versus the Ads*

Beware of computer hype! You may read about "groundbreaking" technology, but, honestly, unless you see that technology available in a computer ad, forget it.

A case in point is the current rage over the DVD disk. Yes, one day all computers will have DVD drives rather than CD-ROM drives. But check the ads! Lots of computers are still sold with CD-ROM drives. More importantly, where are the DVD disks in the software stores?

Any new hardware technology takes time to become accepted. Wait until something “fabulously new” is available on most new computer systems before you decide whether to buy one. Remember that software controls the hardware. You need software in order to use the new hardware regardless of whether every computer has the new hardware.

## Out-of-Date Stock

Computer dealers like to sell stuff they don’t have to fix. No one — neither you nor the dealer — likes to see you come back with your computer in the box because it doesn’t work. I don’t mean, however, that shady dealers don’t try to sell you old stuff just to get rid of it.

Do your research (like reading this book) before you walk into a store. Be aware of what is appropriate for your needs and what the computer industry suggests as standard (which you determine by reading the ads). You don’t want a pushy salesman convincing you that a CRT monitor is better than an LCD simply because he has three dozen stacked up in the storage room and the boss told him to get rid of them.

(I worked *one day* at a computer store. During my only sales meeting, we were told to “unload” an ailing computer, to steer customers to it first regardless of what their true needs were. Like I said, I worked there only one day.)

## Money Down Required

For what possible reason would anyone need money down on a computer? It’s just not necessary. Don’t believe them if they pull this bit: “We need the down payment to ensure that you are committed to buying this computer.” Computers are selling like hot-cakes, so it’s not like they would build a computer and be stuck with it forever if you didn’t take it. Someone else will buy it.

- ✔ Never put money down, especially cash, on a computer.
- ✔ Always pay for your purchase with a credit card.

## *Missing Pieces*

If you open the box and everything isn't there, take it back immediately! Chances are good that you were sold a computer someone else returned and everything wasn't put back properly. Tell the people at the computer store that you want another computer. Don't accept their giving you the missing parts. Unless someone there told you that you were buying a refurbished computer, he cannot legally sell it to you. Check the laws in your state about selling refurbished equipment.

## *No Address in the Mail-Order Ad*

It's an easy scam: They open a business with a rented postal box, they place an ad into a circular (and don't pay for it), and they have an 800 number. The orders fly in because the prices in the ad are just too good to be true. That's because they are; two days later, the "business" doesn't exist and folks are out thousands of dollars in cash.

Reputable dealers post their physical addresses in their ads, along with their local phone numbers.

## *Salespeople Too Busy to Help*

My theory has always been that if people are too busy to take my money, I don't want to give it to them anyway. Go someplace else, to wherever you find someone who's willing to answer your questions and take the time to fully explain what they have to offer you.

## *Salespeople in the Store Ignore You*

If the salespeople in the store are ignoring you, one of two things is going on: Either no one knows enough to walk up and help you, or no one gives a hoot whether you buy a computer. Apathy and ignorance are two qualities you don't ever want to do business with, regardless of whether you're buying a computer, a car, or some shoes.

(I was ready to plunk down \$800 for a new hard drive in a local store, and *everyone* in the store ignored me. The salesperson didn't know what a SCSI drive was. The techie only commented on the SCSI drive, not telling me whether it was in stock or available for sale. It was a nice store, too; it had a classroom in back and competitive prices. Because the people in there were jerks, though, I bought my \$800 hard drive by mail order.)

Also, be wary of any salesperson who refers to you behind your back as a “mark” — unless, of course, your name is Mark.

## No Classroom

If a store doesn't offer some kind of computer class to help you with your new purchase, the folks there really aren't concerned with giving you complete customer service. They're more concerned with making a sale.

If you're a first-time computer buyer, taking a class gives you a better sense of confidence to go exploring with your computer, and your frustration level will be much lower.

## No Software Documentation

All software comes with some kind of documentation: installation instructions, information on how to play or work the software, and maybe even some technical notes. This stuff is all-important. If the software documentation doesn't come with the computer, chances are that the software is stolen. Don't leave the store without seeing that documentation. If someone makes any of the following comments, leave the store!

- ✓ “The software doesn't come with any documentation.”
- ✓ “Oh, you'll be able to figure it out.”
- ✓ “The program tells you what to do as you go along.”



All software must be sold with documentation! Even if it's just a CD, that CD may have a serial number on it — or sometimes the entire manual!

## Chapter 27

---

# Ten Other Things You Should Buy

---

### *In This Chapter*

- ▶ Mousepad and wristpad
  - ▶ Power strip and surge protector
  - ▶ Uninterruptible power supply
  - ▶ Printer cable
  - ▶ Printer paper
  - ▶ Toner or ribbons
  - ▶ Removable disks
  - ▶ CD caddy
  - ▶ Roll of paper towels
- 

**T**his chapter is dedicated to the ten additional things, what-nots, and items you need to buy that will help with your whole computer-using experience. Buying these things is not optional. You really need them.

## *Mousepad and Wristpad*

Ever try to use a mouse with a dirty ball? No, really, I'm being serious. The mouse has a ball it rolls on, and if that ball becomes dirty, it doesn't roll smoothly and you have a heck of a time trying to get it to point, drag, or do anything.

A *mousepad* is a screen-size piece of foam rubber that sits on your desk and that the mighty mouse rolls on. A mousepad makes the

mouse roll more smoothly and keeps that mouse ball clean (as long as you don't drop cookie crumbs all over it).



- ✔ You get the best performance from your mouse if you buy a mousepad that is slightly textured. Smooth pads don't work as well.
- ✔ Optical mice don't need mousepads, but still having a mousepad is nice; it keeps a portion of your desktop clean for the mouse to slide around in.

Buying a wristpad is more of a health measure than a technical one. Lazy keyboarders drop their wrists to an unnatural position, which eventually causes stress on their wrists and their infamous carpal tunnels. This condition, of course, can be painful.

The purpose of a wristpad is to keep your arms and hands in a normal, healthy position. It fits right below your keyboard, and your wrists gently lie on it.

Wristpads are also available for your mousepad, sometimes both in one unit.

Neither a mousepad nor a wristpad is expensive, and you can get creative with a mousepad. Kinko's has a process in which you can put your kids' pictures (or pictures of your cats, if you don't like kids) on your mousepad.

## Power Strip

Not until you start putting together your computer and all its various gadgets does it occur to you that homebuilders truly underestimate the need for wall outlets.

You have to plug in your computer, printer, modem, scanner, lamp, clock, and answering machine. The list can get pretty long, and you're probably looking at one, maybe two, plugs to accommodate all this stuff.

*Power strips* are like short extension cords, except that they have several outlets to accommodate your computer paraphernalia.



The Kensington SmartSockets brand of power strip has a large, wide area that allows more room for the AC converters that often come on computer peripherals. I recommend this brand.

## Surge Protector

A *surge protector* is merely a dooded-up power strip. It's like a power strip with a fuse to even out the electricity in times of power glitches, which can crash your computer and make you lose everything you've been working on.

- ✔ A power strip can also be a surge protector. Some just have extra outlets. Others have surge protection in them, like the SmartSockets mentioned in the preceding section.
- ✔ Some surge protectors also come with filters for protecting the phone line and network cable.
- ✔ The more you pay for a surge protector, the better the protection. The highest level of protection is *spike protection*, which protects your computer from lightning strikes.
- ✔ Sorry — you can't get any “wrath of God” protection.

## UPS

UPS (not the delivery service) stands for *uninterruptible power supply*. It keeps the computer on (for a while) during a power outage.

By plugging your computer and monitor into the UPS, you have enough time to safely save and close all your documents before turning off your computer. The UPS also has surge protection, but you don't really have to plug *everything* into it. After all, who cares whether your modem or your printer goes off during an outage? The data in your computer is more important, and that's what the UPS protects.

- ✔ If you plug too much stuff into a UPS, your computer doesn't have enough power to last long enough to save any of your work. Plug just the computer and monitor into the UPS.
- ✔ Never plug a printer into a UPS; printing can wait until after the power comes back on.
- ✔ If possible, try to find a UPS that supports swappable batteries. That way, you can replace only the battery if the unit ever gets sluggish and not have to buy a whole new UPS.
- ✔ Most UPS systems are good for around five minutes, so don't dawdle! Save your work, and then turn off your computer!





## Printer Cable

Printers don't come with printer cables, which has always amazed me because you can't get your printer to work unless a cable connects your printer to your computer. It's like buying a television without a cord to plug into the wall. Ugh.

The only thing you need to worry about with printer cables is that your printer can be no farther than 20 feet away from your computer. Information tends to get lost at that distance. The most common length for printer cable is six feet.

(Note that the 20-foot limit applies to parallel printer cables. For USB printers, the limit is theoretically three meters, or about 10 feet.)

## Printer Paper

Paper. Gotta have it for the printer, or else the darn thing is kind of useless. Only a few rules apply when it comes to paper:



- ✔ Don't use *bond* paper in a laser printer. Bond paper may have a dust on it, which clogs up the printer.
- ✔ Don't use erasable typing paper. This type of paper is good for manual typewriters, where you have to erase all your typing mistakes, but with a computer, the dust on the erasable typing paper can clog up the printer's internals.
- ✔ Buy a whole box when you go to buy paper. You'll use it. Nothing is more frustrating than printing a report, running out of paper in the middle of it, and then realizing that you don't have any more.

## More Inky Stuff

Printers, like ink pens, run out of ink — except with a pen, you're more likely to throw the darn thing away and buy another one. You don't want to do that with a printer. That could get costly. Instead, you have to buy more ink.

Printer ink comes in various containers and exists in various states, depending on your printer.

- ✔ Ink jet printers use little containers of ink that are really supereasy to change (but very expensive!)

- ✓ Laser printers use a drop-in toner cartridge. These cartridges are fairly easy to install if you follow the directions.
- ✓ Impact (or dot matrix) printers use a ribbon.



Because all these printers require you to handle the ribbon or cartridge, you run a risk of getting this stuff on your hands. Be careful! It's ink. It doesn't come off easily. It kind of wears off more than it washes off. To help prevent that, wear some rubber gloves when you change the toner or ribbon in your printer.

## Removable Disks

Even though your hard drive has a huge capacity to store information, you still need removable disks. You use them for transferring information from one computer to another.

For your floppy drive, get floppy disks. Buy a box of preformatted disks for either the PC or the Macintosh.

If you have a specialty drive, like a Zip drive, get some of those disks too.

CD-R and CD-RW drives deserve to have their own media as well. Stock up on those disks, where buying them in bulk is often cheaper than buying them one at a time.

- ✓ Make sure that you get the proper-size floppy disks: 3½-inch, 1.44MB floppy disks. Try to buy them preformatted if possible.
- ✓ Zip disks are expensive. Buying them three or more at a time saves you some money.
- ✓ If possible, try to get the green-gold type of CD-R disks. They tend to be more reliable and compatible than the cheaper CD-R disks.



## CD Caddy

Software comes on CDs, plus you'll probably be creating your own CDs (both music and backup) and have music CDs handy by the computer. The best way to store these is to get one of those plastic or wire CD-holding tray things. You can find them at music stores as well as at office supply stores.

## *A Roll of Paper Towels*

Paper towels? You're surprised, right? Even though one of the rules for computer use is that you don't eat or drink by your computer, you will. It's inevitable. You'll succumb to temptation and grab a cup of coffee to keep you company.

Paper towels are for those times when you spill your beverage of choice. Spilling liquid of any kind can cause havoc with your computer, so either don't drink and compute or keep those paper towels close by.



Getting your keyboard wet fries the keyboard (metaphorically speaking — it's not like smoke and stuff billows out of the keyboard). You can try to let it dry out or use those paper towels to try to wipe up the liquid before it does too much damage.

## Chapter 28

# Ten Tips and Suggestions

---

### *In This Chapter*

- ▶ Your computer's clock
  - ▶ Get a second phone line
  - ▶ Reread your manuals
  - ▶ Put a timer on the Internet
  - ▶ Get antivirus software
  - ▶ Subscribe to a computer magazine
  - ▶ Join a users' group
  - ▶ Buy some computer books
  - ▶ Don't let the computer ruin your life
  - ▶ Have fun!
- 

**N**o one wants any surprises when using a computer. Imagine buying a new car, signing your name, being handed the keys, and then the salesperson saying “Oh, I forgot to tell you — this thing runs only on 110-octane super-doooper premium” or “Always hold your steering wheel with your left hand because the car pulls to the right.” Fortunately, owning a computer doesn't involve many surprises along those lines.

This chapter contains a list of ten tips, suggestions, and warnings. They're nothing major; they're just some last-minute items you may not know about — by-the-way sort of things to wrap up this book.

## *Your Computer Has a Clock*

You may not notice at first, but your computer keeps track of the time. And it remembers the time, even when you turn off the computer or unplug it. The reason is that the computer has a battery that helps it remember the time as well as a few other items.

Someday, in about five years, your computer's battery will die. You'll notice it because not only will your computer have lost track of the time, but you may also see an error message when the computer starts up. When that happens, phone your dealer and get a new battery installed.

Even though your computer has a clock, it makes a lousy time-piece. No two computers can keep track of the same time. Some are fast; most are slow. You have to reset your system's clock every month or so. If not, your computer could be lagging by as much as 20 or 30 minutes by the end of the year.

## Get a Second Phone Line

If you plan to use a computer and a dial-up modem, do yourself and everyone else a favor and get the computer its own phone line. I tried to phone up a friend one night, and his phone was busy for *three hours*. He was on the Internet and utterly unaware that anyone was trying to call.



- ✓ If the second line from the phone company costs you too much, consider getting a digital cellular phone instead. Often, the monthly bill for the cell phone (especially a digital model) is much less than buying a second phone line. And you can take the cell phone with you.
- ✓ Cable and DSL modems don't need a separate phone line. In fact, DSL "shares" a phone line with your regular telephone. (You need a DSL doohickey on the phone lines not connected to the DSL modem.)

## After a While, Reread the Manuals

Although computer manuals are horrid, they may begin to make sense a few weeks after you use your computer. Use any program for a while, and try to figure it out. Then go back and read the manuals. Not right away; take some time and do something with the program. Figure out how it works. After that, for some reason, the manual tends to make sense. I follow this simple advice, and for some reason, everyone thinks that I'm a computer genius.

## *Put a Timer on That Internet*

If you plan to be on the Internet, set a clock! The Internet sucks up time like a black hole in space. Limit yourself to 30 minutes or an hour for your Internet browsing, or else you'll see the sun rise some morning.

## *Get Antivirus Software*

If you're going to be on the Internet, you need antivirus software. This is not an option. Viruses and computer worms proliferate through e-mail and can be innocently copied from Web pages into your computer.

Some new computers come with antivirus software as part of the "free" software that comes with the computer. If not, buy antivirus software *at once!*

## *Subscribe to a Computer Magazine*

Now that you have a computer, it makes sense to get a computer magazine. That's where you find advice, tips, and information about computer things. The magazine keeps you up-to-date and informed better than dealers and developers, who put their own interests above yours.

Several levels of computer magazines are available, from novice magazines to hard-core nerd publications. Most bookstores have racks full of them, so take a few minutes to browse and pick up a few of the ones that interest you.

## *Join a Computer Users' Group*

Sociologists tell us that injured people tend to cluster after a catastrophe. It's a force of nature. Just like those walking wounded, computer users — dazed and bewildered — gather in small groups in cities across the land. They discuss. They share. They learn.

Refer to your local newspaper events column to see when and where any computer groups meet in your area.

## *Buy a Great Book*

I can't recommend books enough! Some great titles are out there to help you find out about anything you can do on a computer. When your dealer support craps out, when the developers admit that they loathe the customer, and when you have exhausted your friends and computer buddies, buy a good book.

As with magazines, be aware that different levels of books — beginner, intermediate, and advanced — are available for different computer users: You can get reference books, and you can get tutorial books. Buy what suits you best.

## *Remember That You Are in Charge*

The biggest problem most new owners have with a computer is taking it too seriously. Life is just too important to take anything seriously, especially a computer.

Above all, never think that it's your fault when something goes wrong. If you always blame yourself, you have a horrid time computing. The truth is that computers are dumb. They foul up all the time. It's not your fault.

## *Don't Let the Computer Run Your Life*

Computers are *not* a big deal. They're tools. You use them to extend your own abilities. They are not important. Human beings do not live to serve the computer.

If you find yourself overly enamored with your computer, make it a point to take a break every so often. Walk outside. Get some fresh air. Talk to a human being. If the universe has a center, it's not powered by a microprocessor.

Have fun.

# Index

## • Numbers •

1.44MB floppy drives, 75  
2-D graphics applications, 85  
2MB cache memory, 69  
3-D graphics applications, 85  
8MB cache memory, 69  
15 amp circuits, 201  
20 amp circuits, 201  
56 Kbps modems, 102  
64MB video memory, 163  
100MB Zip drives, 75  
250MB Zip drives, 75  
386 microprocessors, 48  
486 microprocessors, 36, 48  
750 Zip drives, 75  
8088 microprocessors, 48  
68040 microprocessors, 36  
80386 microprocessors, 36

## • A •

Accelerated Graphics Port (AGP),  
85–86, 99  
access, Internet, 22  
adapters  
dual-monitor, 83  
graphics, 83–85  
advertisements  
call ads, 169  
cautions, 170–171  
circulars, 168  
dissecting, 168–170  
industry standards versus, 241–242  
magazines, 168  
newspapers, 168  
tricks and scams, 170  
AGP (Accelerated Graphics Port),  
85–86, 99

Airborne Express Web site, 184  
Alpha microprocessors, 36  
analog-to-digital (A-to-D) ports, 98  
antivirus software, 253  
applications  
graphics, 85–86, 99  
overview, 39–40  
reinstalling, 225–226  
Athlon microprocessors, 36, 45  
ATI All-In-Wonder graphics cards, 86  
A-to-D (analog-to-digital) ports, 98

## • B •

back-to-school computer sales, 193  
backups, modems, 103  
backward compatibility, 48  
bandwidth, 79  
banks of memory, 61–62  
bargain systems, warning against, 238  
Basic Input/Output System (BIOS),  
37, 124  
batteries, laptop computers, 114–115  
baud rate, 102  
BCWipe program (Jetico), 236  
Better Business Bureau Web site, 182  
bits, defined, 46  
boxes, computer boxes  
keeping, 200–201  
opening, 198–200  
browsers, 130  
budgeting software, 132–133  
buffer memory, 69  
built-in speakers, 206  
burn-in-tests, 206  
bus topology, microprocessors, 37  
buying versus upgrading, 49  
bytes, 54–55



## • C •

cable modems, 104

cables

network, 106

printers, 216–217, 219, 248

cache

defined, 49

memory, hard drives, 69

call advertisements, 169

cards

expansion, 98, 223

graphics, 84, 86

case computer designs, 26

catalog stores, online shopping, 180

cathode ray tube (CRT), 80–81

CD caddies, 249

CD-R drives, 65

CD-ROM (Compact Disk, Read-Only Memory), 65, 68–69, 74

CD-R/W drives, 65

Celeron microprocessors, 45, 50

central processing unit (CPU), 36, 44

Centronics ports, 96

charities, computer donations, 235

cheat sheets, 199

chips, memory, 55–56

circuits, 201–202

classes

finding, 10

support, 188–189

clock, resetting, 251–252

clock speed, microprocessors, 47

CNet Web site, 145

color monitors, 78

commissioned versus noncommissioned salespeople, 173

Compact Disk, Read-Only Memory (CD-ROM), 65, 68–69, 74

Compaq manufacturer, 170

comparison shopping, online shopping, 183

compatibility

backward compatibility, 48–51

defined, 39

NICs (network interface cards), 106

computers. *See also* laptop

computers; notebooks

basic parts of, 16

case designs, 26

cheat sheets, 199

costs, 33–34

defined, 24

desktop, 24–25

donating, 235

finding room for, 201–202

free, scams, 34

gaming consoles, 30–31

handheld, 34

mainframes, 33

microcomputers, 24, 48

minicomputers, 33

minitower model, 24–25

networking, 105–107

notebooks, 29

palmtops, 30, 34

PCs (personal computers), 24–25

quotes for, 171–172

reasons for, 7–8

refurbished, 173–174

self built, 176

selling, 235

small-footprint, 25

state-of-the-art, 33

supercomputers, 33

tower models, 25

turning on/off, 205–206

used, 173–174, 236

when to buy, 231–232

when to upgrade, 232–235

workstations, 31–33

connections, ports, 93

consoles

description of, 16–17

gaming, 30–31, 74, 136–137

overview, 38

setting up, 202–203

contextual help systems, 146  
 controllers  
   disk drive, 70–71  
   game, 91  
   graphics, 77–78  
   mouse-like, 89  
 copy-machine paper, 217  
 cordless mouse, 89  
 costs  
   computers, 33–34  
   printers, 213–214  
   software, 35  
 CPU (central processing unit), 36, 44  
 credit card purchases, 239  
 CRT (cathode ray tube), 80–81  
 curved-screen monitors, 81

## • D •

Data Eraser program (OnTrack), 236  
 data transfer, 226–227  
 databases, personal organizer  
   software, 132  
 Dell manufacturer, 170  
 demo software, 140  
 deposits, warnings against, 194  
 desktop computers, 24–25  
 desktop publishing (DTP), 133  
 DHL Web site, 184  
 dial-up modems, 20, 103, 116  
 digital imaging, scanners, 21  
 Digital Subscriber Line (DSL)  
   modems, 104–105  
 DIMMs (dual in-line memory  
   modules), 57–58  
 discounts, 172–173  
 disk drives. *See also* hard drives  
   controllers, 70–71  
   fixed, 70  
   floppy disks, 65, 74–75  
   interfaces, 70  
   Jaz, 66  
   magneto-optical, 66  
   removable, 70, 249  
   storage capacities, 66–67

disk operating system (DOS), 128  
 displays, monitors, 79–81  
 donating computers, 235  
 dot pitch, defined, 79  
 dots per inch (dpi), 212  
 DRAM (Dynamic Random Access  
   Memory), 58  
 drawing programs, 135  
 drives. *See* disk drives; hard drives  
 DSL (Digital Subscriber Line)  
   modems, 104–105  
 DTP (desktop publishing), 133  
 dual in-line memory modules  
   (DIMMs), 57–58  
 dual-monitor adapters, 83  
 Duron microprocessors, 45  
 DVD drives, 66  
 DVD-R drives, 66  
 DVD-RAM drives, 66  
 DVD-RW drives, 66  
 Dynamic Random Access Memory  
   (DRAM), 58

## • E •

ECC (Error Checking and  
   Correction), 59  
 EDO (Extended Data Out), 59  
 educational software, 136  
 8MB cache memory, 69  
 8088 microprocessors, 48  
 80386 microprocessors, 36  
 electrical issues and rules, 204  
 e-mail  
   office type applications, 130  
   utility programs, 137  
   viruses, 137–138  
 encyclopedias, educational  
   software, 136  
 end-of-year computer sales, 193  
 Entourage e-mail program, 130  
 ergonomic keyboards, 88–89  
 Error Checking and Correction  
   (ECC), 59  
 Ethernet ports, 94

Excel spreadsheet program, 134  
expansion cards  
  defined, 98  
  transferring to new computer, 223  
expansion options  
  laptops, 116–117  
  peripherals and, 22  
expansion slots  
  reasons for, 98–99  
  selection considerations, 100  
  types of, 99  
Extended Data Out (EDO), 59  
extended-service policies, 187  
extension cords, 204  
external hardware, 207  
external speakers, 20

## • F •

fanfold paper, 217  
FAQ (Frequently Asked Questions),  
  help systems, 147  
Fast Page Mode (FPM), 59  
fax modems, 103  
Federal Express Web site, 184  
15 amp circuits, 201  
56 Kbps modems, 102  
Firewire ports, 95  
firmware, 37  
fixed drives, 70  
flash memory, 58  
flat screen monitors, 81  
floppy disks, 65, 74–75  
force feedback, joysticks, 92  
486 microprocessors, 36, 48  
FPM (Fast Page Mode), 59  
free computers, scams, 34  
free software, 138–140  
free trials, 227  
FreeBSD operating systems, 128  
freeware, 139  
Frequently Asked Questions (FAQ),  
  help systems, 147  
friendly operating systems, 120

## • G •

G3 microprocessors, 44–45  
G4 microprocessors, 44–45  
game controllers, 91  
gaming consoles, 30–31, 74, 136  
gigabytes (GB), 54–55  
gigahertz (GHz), 46  
GPU (graphics processor unit), 163  
graphics  
  adapters, 83–85  
  applications, 85–86, 99  
  graphical systems, 77–78  
  graphics cards, 84, 86  
  memory, 84  
  software, 135  
  video editing software, 83  
graphics processor unit (GPU), 163  
graphs, graphical systems, 77–78

## • H •

handheld computers, 34  
hard drives. *See also* disk drives  
  cache memory, 69  
  defined, 63, 65  
  erasing, 236  
  laptop computers, 114  
  selection considerations, 72  
  speed, 67–68  
  storage consumption issues, 71  
  storage requirements, 161–162  
  types of, 64–66  
  upgrading, 232–233  
  Zip drives, 66, 75–76  
hardware  
  buying before software, warning  
    against, 237  
  consoles, 38  
  controlling, 122  
  defined, 24  
  external, 207  
  finding, 10–11  
  firmware, 37

internal, installing, 207  
 memory, 37  
 microprocessors, 36  
 for networks, 105–106  
 OS (operating system), 122  
 overview, 35–36  
 peripherals, 38  
 shopping for, 10–11  
 software and, 40  
 storage devices, 37  
 transferring to new computer, 221–225  
 upgrading, 232–233  
 worksheets, 11, 157–158, 165  
 HAT switches, joysticks, 91–92  
 HD (High-Density) floppy disks, 75  
 headphones, sound circuitry, 109  
 heat sinks, 50  
 help systems. *See also* support  
   contextual, 146  
   Internet, 147  
   online, 146  
   tutorial, 147  
 Hewlett-Packard OfficeJet  
   printers, 212  
 High-Density (HD) floppy disks, 75  
 high-speed Internet access, 22  
 hot swap batteries, 114–115  
 hubs  
   defined, 106  
   USB (Universal Serial Bus), 94–95  
 human voices, sound circuitry, 108  
 hyperthreading, 51

**• I •**

IBM PCs, 24–25  
 iBook laptops, 28, 34  
 IEEE 1394 ports, 95  
 illegal software, 144  
*Illustrated Computer Dictionary*  
   *For Dummies* (Wiley Publishing),  
   70, 195  
 iMacs, 26–27, 34

independent circuits, 202  
 Industry Standard Architecture  
   (ISA), 99  
 infrared (IR) ports, 97  
 ink jet printers, 211–212, 214–215  
 ink, printer ink, having extra, 248–249  
 installing  
   hardware, internal, 207  
   software, reinstalling, 225  
 IntelliMouse, 90  
 interfaces, defined, 70  
 internal hardware, installing, 207  
 internal speakers, 20  
 Internet  
   help systems, 146–147  
   high-speed access, 22  
   purchasing from, support for,  
     189–190  
   uses for, 8  
   Web browsers, 130  
 Internet Service Provider (ISP), 163  
 IR (infrared) ports, 97  
 ISA (Industry Standard  
   Architecture), 99  
 Itanium microprocessors, 46

**• J •**

Jaz disk drives, 66  
 Jetico Web site, 236  
 joysticks  
   ports, 97–98  
   selection considerations, 91–92  
 Jumpstart series programs,  
   educational software, 136–137

**• K •**

K6 microprocessors, 36  
 KB (kilobytes), 54–55  
 Kbps (kilobits per second), 102  
 keyboards  
   attaching, 203  
   description of, 18

keyboards (*continued*)

- ergonomic, 88–89
  - Macintosh, 88
  - Microsoft Natural, 88
  - ports, 97
  - selection considerations, 87
  - specialty buttons, 89
  - USB, 88
- kilobits per second (Kbps), 102
- kilobytes (KB), 54–55

● **L** ●

- L2 (Level two) cache, 49
- laptop computers. *See also* computers; notebooks
- batteries for, 114–115
  - costs, 34
  - dial-up modems, 116
  - discussed, 28–29
  - expansion options, 116–117
  - hard drives, 114
  - iBook, 28, 34
  - ports, 117
  - PowerBook, 28
  - security devices, 116
  - selection considerations, 112–113
  - software, 112
  - touchpads, 116
  - uses for, 111–112
  - weight of, 115
- laser printers, 211–212, 214
- LCD (liquid crystal display), 80–81
- Level two (L2) cache, 49
- Lexar Media Web site, 227
- lighting situations, LCD and, 81
- Linux operating systems, 125–126
- liquid crystal display (LCD), 80–81
- lithium ion batteries, 114
- locally owned and operated computer stores, 175

● **M** ●

- Mac OS (operating system), 124–125
- Macs (Macintosh) computer options
- discussed, 25–27
  - drawing/painting programs, 139
  - gaming software, 136
  - keyboards, 88
- magazine advertisements, 168
- magneto-optical disk drives, 66
- mail-order computers, 177–178, 243
- main memory versus video memory, 60
- mainframe computers, 33
- Mandrake Linux operating systems, 126
- manuals
- not reading, warning against, 239
  - printers, 219–220
  - rereading, 252
- manufacturers, name brand, 170
- manufacturer's suggested retail price (MSRP), 172
- manufacturer's Web store, online shopping, 181
- master microprocessors, 51
- math coprocessors, 51
- measuring monitors, 81–82
- mechanical mouse, 89
- megabytes (MB), 54–55
- megahertz (MHz), 46
- megastores, 176
- memory
- amount needed, 62
  - banks, 61–62
  - buffer, 69
  - chips, 55–56
  - DIMMs (dual in-line memory modules), 57–58
  - DRAM (Dynamic Random Access Memory), 58
  - ECC (Error Checking and Correction), 59
  - EDO (Extended Data Out), 59

- flash memory, 58
- FPM (Fast Page Mode), 59
- graphics, 84
- main versus video, 60
- memory banks, 61–62
- minimum requirements, 160
- nonparity, 59
- parity, 59
- PC100, 59
- PC133, 59
- RAM (random access memory),
  - 37, 53, 61
- RDRAM (Rambus DRAM), 59
- recommended requirements, 161
- ROM (Read-Only Memory), 59
- SDRAM (Synchronous DRAM), 59
- SGRAM (Synchronous Graphics Random Access Memory), 60
- sharable, 60
- SIMMs (single in-line memory modules), 58
- speed, 56–57
- upgrading, 232
- VRAM (Video Random Access Memory), 60, 84
- MHz (megahertz), 46
- microcomputers, 24, 48
- Micron manufacturer, 170
- microphones, sound circuitry, 109
- microprocessors
  - Alpha, 36
  - Athlon, 36, 45
  - bits, 46
  - bus topology, 37
  - buying versus upgrading, 49
  - cache, 49
  - Celeron, 45, 50
  - clock speed, 47
  - common questions, 48–51
  - Duron, 45
  - 8088, 48
  - 80386, 36
  - 486, 36, 48
  - G3/G4, 44–45
  - hyperthreading, 51
  - Itanium, 46
  - K6, 36
  - master, 51
  - math coprocessors, 51
  - overview, 43
  - Pentium, 36, 45–46
  - 68040, 36
  - slave, 51
  - Socket 7, 50
  - SPARC, 45
  - speed of, 46–47
  - standard desktop, avoiding, 113
  - 386, 48
  - upgrading, 233–234
- Microsoft
  - Money budgeting software program, 132–133
  - Natural keyboards, 88
  - Xbox gaming consoles, 31
- MIDI (Music Instrument Digital Interface), 97–98
- minicomputers, 33
- minimum memory requirements, 160
- minitower computer models, 24–25
- Miramar System Web site, 227
- mistakes, computer buying, 237–240
- modems
  - backups for, 103
  - baud rate, 102
  - cable, 104
  - defined, 101
  - description of, 20
  - dial-up, 20, 103, 116
  - DSL (Digital Subscriber Line), 104–105
  - fax, 103
  - 56 Kbps, 102
  - phone-lines, 103
  - satellite, 105
  - screeching noises, 103
  - speed, 102
- money down required, warnings against, 242

## monitors

- adapters, dual-monitor, 83
  - bandwidth, 79
  - color, 78
  - CRT (cathode ray tube), 80–81
  - curved-screen models, 81
  - description of, 17–18
  - diagonal measurements, 81–82
  - displays, 79–81
  - dot pitch, 79
  - flat screen, 81
  - interlaced/non-interlaced, 79
  - LCD (liquid crystal display), 80–81
  - measuring, 81–82
  - multiple, reasons for, 82–83
  - pixels, 80
  - screens, 79
  - selection considerations, 78–79
  - setting up, 203–204
  - tilt-and-swivel base, 205
  - transferring to new computer, 222
  - upgrading, 233
- ## monocolor (monochrome)
- screens, 79
- ## mouse
- anti-mouse touchpads, 116
  - attaching, 203
  - controllers, 89
  - cordless, 89
  - description of, 18–19
  - IntelliMouse, 90
  - mechanical, 89
  - optical, 89
  - pen, 89
  - ports, 96–97
  - table, 89
  - trackball, 89
  - upside-down, 89
  - wireless, 90
- ## mousepads, 245–246
- ## Mozilla browsers, 130
- ## MP3 (music) files, 71
- ## MSRP (manufacturer's suggested retail price), 172

- multiplatform operating systems, 122
- multiscanning, 163
- Music Instrument Digital Interface (MIDI), 97–98
- music (MP3) files, 71
- mySimon Web site, 183

## ● N ●

- name brand manufacturers, 170
- nanoseconds (ns), 56
- national computer chains, 175–176
- Netscape browser, 128
- network interface cards (NICs), 22, 106
- networking computers, 105–107
- networks
  - cable for, 106
  - defined, 105
  - hardware options, purchasing, 105–106
  - print sharing, 219
- newspaper advertisements, 168
- NiCad batteries, 114
- nickel-metal hydride (NiMH) batteries, 114
- NICs (network interface cards), 22, 106
- Nintendo Game Cube gaming consoles, 31
- noncolor (monochrome) screens, 79
- nonparity, memory, 59
- Norton Utilities, Wipe Disk, 236
- notebooks. *See also* computers; laptop computers, 29
- ns (nanoseconds), 56

## ● O ●

- OfficeJet printers (Hewlett-Packard), 212
- 1.44MB floppy drives, 75
- 100MB Zip drives, 75
- online help system, 146

- online shopping
    - catalog stores, 180
    - comparison shopping, 183
    - manufacturer's Web store, 181
    - orders, placing, 181–183
    - overview, 179
    - purchasing considerations, 189–190
    - shopping agents, 183
    - tracking systems, 184
    - warnings, 183–184
  - on-site computer services, 177
  - Ontrack Web site, 236
  - OpenBSD operating system, 128
  - Opera browser, 128
  - operating system (OS)
    - DOS, 128
    - FreeBSD, 128
    - hardware, 122
    - Linux, 125–126
    - Mac OS, 124–125
    - multiplatform, 122
    - OpenBSD, 128
    - overview, 38–39, 119
    - Palm OS, 127
    - software base, 121–122
    - Solaris, 128
    - Unix, 126
    - upgrading, 234–235
    - user friendly versus powerful, 120
    - Windows XP, 123
  - optical mouse, 89
  - OS. *See* operating system
  - Outlook e-mail program, 130
  - out-of-date stock, warnings
    - against, 242
- p •**
- packing lists, 198
  - PageMaker desktop publishing
    - program, 133
  - pages per minute (ppm), 212
  - painting programs, 135
  - Palm OS (operating system), 127
  - palmtop computers, 30, 34
  - paper, printer paper, 212, 217, 248
  - paper towels, uses for, 250
  - parallel ports, 96
  - parity, memory, 59
  - PC100 memory, 59
  - PC133 memory, 59
  - PCMCIA (Personal Computer Memory
    - Card International Association)
      - ports, 117
  - PCs (personal computers), 24–25
  - pen mouse, 89
  - Pentium microprocessors, 36, 45–46
  - Peripheral Component Interconnect
    - (PCI), 86, 99
  - peripheral devices, 22, 38
  - Personal Computer Memory Card
    - International Association
      - (PCMCIA) ports, 117
  - personal computers (PCs), 24–25
  - personal organizer software, 132
  - Personality Transport program, data
    - transfer, 227
  - phone lines
    - dial-up modems, 103
    - second, 252
  - pin connectors, 57
  - pirated software, 140
  - pixels, 80
  - PlayStation gaming consoles, 31
  - ports
    - A-to-D (analog-to-digital), 98
    - Centronics, 96
    - defined, 93
    - Ethernet, 94
    - Firewire, 95
    - IEEE 1394, 95
    - IR (infrared), 97
    - joystick, 97–98
    - keyboards, 97
    - for laptop computers, 117
    - list of, 94
    - MIDI (Musical Instrument Digital
      - Interface), 97–98



ports (*continued*)

- mouse, 96–97
- parallel, 96
- PCMCIA (Personal Computer Memory Card International Association), 117
- printer, 95–96, 164
- serial, 96–97, 164
- USB (Universal Serial Bus), 94–95
- PostScript printers, 213
- Power PC microprocessors, 36
- power strips, 202, 246
- PowerBook laptop computers, 28
- ppm (pages per minute), 212
- printers
  - cables, 216–217, 219, 248
  - costs, 213–214
  - Hewlett-Packard OfficeJet, 212
  - ink, having extra, 217, 248–249
  - ink jet, 211–212, 214–215
  - laser, 211–212, 214
  - manuals for, 219–220
  - paper for, 212, 217, 248
  - ports, 95–96, 164
  - PostScript, 213
  - purchasing considerations, 20–21, 215
  - quality, 212
  - resolution, 212
  - setting up, 218–220
  - sharing between computers, 219
  - speed, 212
  - toner cartridges, 214, 217
  - transferring to new computer, 224
- processors. *See* microprocessors
- productivity software, 131–134
- programming software, 138
- programs
  - software, 24
  - utility, 137–138
- protection, spike protection, 247
- public domain software, 139
- purchasing versus upgrading, 49

• **Q** •

- QuarkXPress desktop publishing program, 133
- Quicken budgeting software program, 132–133
- quotes, obtaining, 171–172

• **R** •

- Rambus DRAM (RDRAM), 59
- random access memory (RAM), 37, 53, 61
- Read-Only Memory (ROM), 59
- recommended memory requirements, 161
- Red Hat Linux operating systems, 126
- refurbished computers, 173–174
- registration mail-ins, 207
- reinstalling software, 225
- removable disk drives, 70, 249
- resolution, print quality, 212
- Roboshopper Web site, 183
- ROM (Read-Only Memory), 59
- rotations per minute (RPM), 68

• **S**

- Safari browsers, 130
- sales, seasonal, 193
- salespeople, commissioned versus noncommissioned, 173
- SAT exam simulators, educational software, 136
- satellite modems, 105
- scams
  - advertisements, 170
  - avoiding, 12
  - computer costs, 34
  - free computers, 34
  - mail-order ads, no address in, 243
- scanners
  - high-end, 21
  - moving to new computer, 224–225

- multiscanning, 163
- purchasing considerations, 21
- screetching noises, modems, 103
- screens
  - flat screen monitors, 81
  - monitor screens, 17, 79
  - monochrome (noncolor), 79
- SDRAM (Synchronous DRAM), 59
- seasonal computer sales, 193
- second phone lines, 252
- security, laptop computers, 116
- self built computers, 176
- selling computers, 235
- serial ports, 96–97, 164
- servers, defined, 32
- services
  - extended-service policies, 187
  - how to find, 185–186
  - on-site, 177
  - shopping for, 11–12
  - warranties, 186
- 750 Zip drives, 75
- SGRAM (Synchronous Graphics Random Access Memory), 60
- sharable memory, 60
- shared printers between computers, 219
- shipments, reviewing, 198
- shopping, online
  - catalog stores, 180
  - comparison shopping, 183
  - manufacturer's Web store, 181
  - orders, placing, 181–183
  - overview, 179
  - purchasing considerations, 189–190
  - shopping agents, 183
  - tracking systems, 184
  - warnings, 183–184
- Silicon Graphics computer company, 32
- single in-line memory modules (SIMMs), 58
- sites. *See* Web sites
- 68040 microprocessors, 36
- 64MB video memory, 163
- slave microprocessors, 51
- small-footprint computers, 25
- small-outline dual in-line memory module (SODIMM), 58
- Socket 7 microprocessors, 50
- sockets, surge protected, 204
- software
  - antivirus, 253
  - budgeting, 132–133
  - controlling, 121–122
  - costs, 35
  - defined, 24
  - demo, 140
  - documentation not available, warnings against, 244
  - DTP (desktop publishing), 133
  - educational, 136–137
  - free, 138–140
  - freeware, 139
  - gaming consoles, 31, 136
  - graphics, 135
  - hardware and, 40
  - help systems, 146–147
  - illegal, 140
  - for laptop computers, 112
  - OS (operating system), 121–122
  - overview, 38–40
  - personal organizer, 132
  - pirated, 140
  - productivity, 131–134
  - programming, 138
  - programs, 24
  - public domain, 139
  - purchasing considerations, 143–144
  - reinstalling, 225
  - researching, 144–146
  - shopping for, 8–9
  - support systems, 147–148
  - testing, 144–146
  - transferring to new computer, 225–228
  - upgrading, 234
  - utility programs, 137–138
  - video editing, 83
  - worksheets, 9, 150–154

- Solaris operating systems, 128
- Sony PlayStation gaming consoles, 31
- sound
  - basic circuitry, 107
  - headphones, 109
  - human voice, 108
  - microphones, 109
  - music synthesizers, 108
  - speaker systems, 108–109
  - subwoofers, 108
  - surround, 109
- sound cards, 164
- SPARC microprocessors, 45
- speakers
  - built-in, 20
  - external, 20
  - purchasing considerations, 19–20
  - setting up, 203
  - sound circuitry, 108–109
- speed
  - CD-ROM, 68–69
  - comparisons between, avoiding, 47
  - hard drives, 67–68
  - memory, 56–57
  - microprocessors, 46–47
  - modems, 102
  - ns (nanoseconds), 56
  - printers, 212
- spike protection, 247
- splitters, 97, 204
- spreadsheets
  - Excel program, 134
  - overview, 133–134
  - VisiCalc, 134
- standard desktop microprocessors,
  - avoiding, 113
- state-of-the-art computers, 33
- storage
  - capabilities, disk drives, 66–67
  - consumption, 71
  - hardware devices, 37
- stores
  - catalog stores, 180
  - locally owned and operated, 175
  - mail-orders, 177–178
  - manufacturer's Web store, 181
  - megastores, 176
  - national computer chains, 175–176
  - subscriptions, 253
  - subwoofers, 108
  - supercomputers, 33
  - SuperDisks, 66
  - SuperDrives, 66
  - support. *See also* help systems
    - after-sale, 12
    - classes, 188–189
    - how to find, 185–186
    - Internet purchases, 189–190
    - sample support questions, 187–188, 190
    - shopping for, 11–12
    - software issues, 147–148
  - surge protectors, 204, 247
  - surround sound, 109
  - SuSE Linux operating systems, 126
  - switches, defined, 106
  - Synchronous DRAM (SDRAM), 59
  - Synchronous Graphics Random Access Memory (SGRAM), 60
  - synthesizers, sound circuitry, 108

## • T •

- table mouse, 89
- terabytes, 55
- testing
  - burn-in-tests, 206
  - software, 144–146
- 3-D graphics applications, 85
- 386 microprocessors, 48
- tilt-and-swivel base monitors, 205
- TNT2-M64 PCI graphics cards, 86
- toner cartridges, 214, 217
- touchpads, laptop computers, 116
- tower computer models, 25
- trackball mouse, 89
- tracking systems, online
  - shopping, 184
- Tranxition Corporation Web site, 227
- troubleshooting, manual help, 206
- turning computers on/off, 205–206
- tutorial help systems, 147

20 amp circuits, 201  
 2-D graphics applications, 85  
 250MB Zip drives, 75  
 2MB cache memory, 69

## • U •

uninterruptible power supply (UPS),  
     202, 204, 247  
 Universal Serial Bus (USB), 88, 94–95  
 Unix operating systems, 126  
 upgrading  
     hard drives, 232–233  
     hardware, 232–233  
     memory, 232  
     microprocessors, 233–234  
     monitors, 233  
     operating systems, 234–235  
     purchasing versus, 49  
     software, 234  
 UPS (uninterruptible power supply),  
     202, 204, 247  
 UPS Web site, 184  
 upside-down mouse, 89  
 U.S. Postal Service Web site, 184  
 USB (Universal Serial Bus), 88, 94–95  
 used computers, 173–174, 236  
 user friendly operating systems, 120  
 user groups, joining, 253  
 utility programs, 137–138

## • V •

video editing software, 83  
 video memory versus main  
     memory, 60  
 Video Random Access Memory  
     (VRAM), 60, 84  
 viruses  
     antivirus software, 253  
     utility programs, 137–138  
 VisiCalc spreadsheet program, 134  
 VisionTek Xtasy graphics cards, 86  
 voices, sound circuitry, 108  
 VRAM (Video Random Access  
     Memory), 60

## • W •

warranties, 186  
 Web browsers, 130  
 Web sites  
     Airborne Express, 184  
     Better Business Bureau, 182  
     CNet, 145  
     DHL, 184  
     Federal Express, 184  
     Jetico, 236  
     Lexar Media, 227  
     Miramar System, 227  
     mySimon, 183  
     Ontrack, 236  
     Roboshopper, 183  
     Tranxition Corporation, 227  
     UPS, 184  
     U.S. Postal Service, 184  
     Yahoo, 181  
     ZDNet, 145  
 weight, laptop computers, 115  
 Wiley Publishing (*Illustrated Computer  
     Dictionary For Dummies*), 70, 195  
 Windows XP operating systems, 123  
 Wipe Disk (Norton Utilities), 236  
 wireless mouse, 90  
 woofers, sound, 108  
 word processors, 131  
 worksheets  
     hardware, 11, 157–158, 165  
     software, 9, 150–154  
 workstations, 31–33  
 wristpads, 246

## Y •

Yahoo Web site, 181

## • Z •

ZDNet Web site, 145  
 Zip drives, 66, 75–76





# FOR DUMMIES®

Helping you expand your horizons and realize your potential

## PERSONAL FINANCE & BUSINESS



0-7645-2431-3

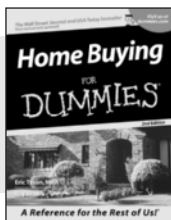

0-7645-5331-3

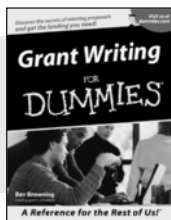

0-7645-5307-0

### Also available:

Accounting For Dummies  
(0-7645-5314-3)

Business Plans Kit For Dummies  
(0-7645-5365-8)

Managing For Dummies  
(1-5688-4858-7)

Mutual Funds For Dummies  
(0-7645-5329-1)

QuickBooks All-in-One Desk Reference For Dummies  
(0-7645-1963-8)

Resumes For Dummies  
(0-7645-5471-9)

Small Business Kit For Dummies  
(0-7645-5093-4)

Starting an eBay Business For Dummies  
(0-7645-1547-0)

Taxes For Dummies 2003  
(0-7645-5475-1)

## HOME, GARDEN, FOOD & WINE



0-7645-5295-3

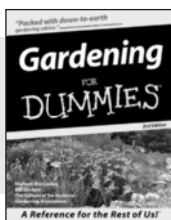

0-7645-5130-2

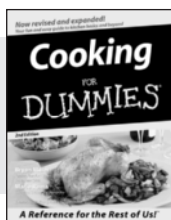

0-7645-5250-3

### Also available:

Bartending For Dummies  
(0-7645-5051-9)

Christmas Cooking For Dummies  
(0-7645-5407-7)

Cookies For Dummies  
(0-7645-5390-9)

Diabetes Cookbook For Dummies  
(0-7645-5230-9)

Grilling For Dummies  
(0-7645-5076-4)

Home Maintenance For Dummies  
(0-7645-5215-5)

Slow Cookers For Dummies  
(0-7645-5240-6)

Wine For Dummies  
(0-7645-5114-0)

## FITNESS, SPORTS, HOBBIES & PETS



0-7645-5167-1

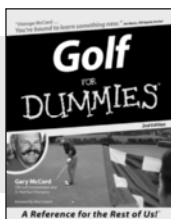

0-7645-5146-9

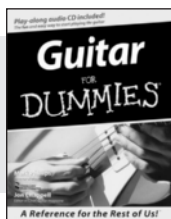

0-7645-5106-X

### Also available:

Cats For Dummies  
(0-7645-5275-9)

Chess For Dummies  
(0-7645-5003-9)

Dog Training For Dummies  
(0-7645-5286-4)

Labrador Retrievers For Dummies  
(0-7645-5281-3)

Martial Arts For Dummies  
(0-7645-5358-5)

Piano For Dummies  
(0-7645-5105-1)

Pilates For Dummies  
(0-7645-5397-6)

Power Yoga For Dummies  
(0-7645-5342-9)

Puppies For Dummies  
(0-7645-5255-4)

Quilting For Dummies  
(0-7645-5118-3)

Rock Guitar For Dummies  
(0-7645-5356-9)

Weight Training For Dummies  
(0-7645-5168-X)

Available wherever books are sold.

Go to [www.dummies.com](http://www.dummies.com) or call 1-877-762-2974 to order direct





# FOR DUMMIES®

**A world of resources to help you grow**

## TRAVEL



0-7645-5453-0

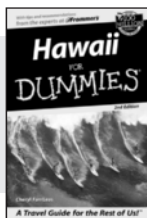

0-7645-5438-7



0-7645-5444-1

### Also available:

America's National Parks For Dummies (0-7645-6204-5)  
 Caribbean For Dummies (0-7645-5445-X)  
 Cruise Vacations For Dummies 2003 (0-7645-5459-X)  
 Europe For Dummies (0-7645-5456-5)  
 Ireland For Dummies (0-7645-6199-5)

France For Dummies (0-7645-6292-4)  
 Las Vegas For Dummies (0-7645-5448-4)  
 London For Dummies (0-7645-5416-6)  
 Mexico's Beach Resorts For Dummies (0-7645-6262-2)  
 Paris For Dummies (0-7645-5494-8)  
 RV Vacations For Dummies (0-7645-5443-3)

## EDUCATION & TEST PREPARATION

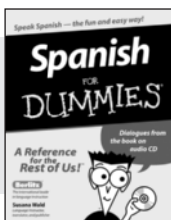

0-7645-5194-9

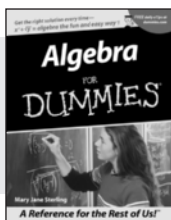

0-7645-5325-9

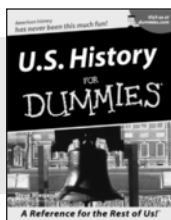

0-7645-5249-X

### Also available:

The ACT For Dummies (0-7645-5210-4)  
 Chemistry For Dummies (0-7645-5430-1)  
 English Grammar For Dummies (0-7645-5322-4)  
 French For Dummies (0-7645-5193-0)  
 GMAT For Dummies (0-7645-5251-1)

Inglés Para Dummies (0-7645-5427-1)  
 Italian For Dummies (0-7645-5196-5)  
 Research Papers For Dummies (0-7645-5426-3)  
 SAT I For Dummies (0-7645-5472-7)  
 U.S. History For Dummies (0-7645-5249-X)  
 World History For Dummies (0-7645-5242-2)

## HEALTH, SELF-HELP & SPIRITUALITY

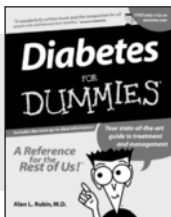

0-7645-5154-X



0-7645-5302-X

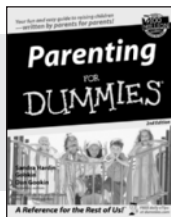

0-7645-5418-2

### Also available:

The Bible For Dummies (0-7645-5296-1)  
 Controlling Cholesterol For Dummies (0-7645-5440-9)  
 Dating For Dummies (0-7645-5072-1)  
 Dieting For Dummies (0-7645-5126-4)  
 High Blood Pressure For Dummies (0-7645-5424-7)  
 Judaism For Dummies (0-7645-5299-6)

Menopause For Dummies (0-7645-5458-1)  
 Nutrition For Dummies (0-7645-5180-9)  
 Potty Training For Dummies (0-7645-5417-4)  
 Pregnancy For Dummies (0-7645-5074-8)  
 Rekindling Romance For Dummies (0-7645-5303-8)  
 Religion For Dummies (0-7645-5264-3)

# FOR DUMMIES®



*A world of resources to help you grow*

## HOME & BUSINESS COMPUTER BASICS

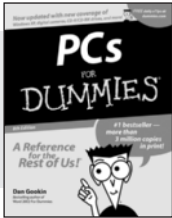

0-7645-0838-5

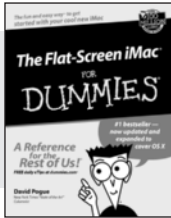

0-7645-1663-9

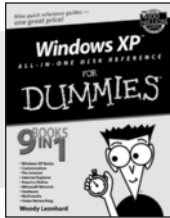

0-7645-1548-9

### Also available:

Excel 2002 All-in-One Desk Reference For Dummies (0-7645-1794-5)

Office XP 9-in-1 Desk Reference For Dummies (0-7645-0819-9)

PCs All-in-One Desk Reference For Dummies (0-7645-0791-5)

Troubleshooting Your PC For Dummies (0-7645-1669-8)

Upgrading & Fixing PCs For Dummies (0-7645-1665-5)

Windows XP For Dummies (0-7645-0893-8)

Windows XP For Dummies Quick Reference (0-7645-0897-0)

Word 2002 For Dummies (0-7645-0839-3)

## INTERNET & DIGITAL MEDIA

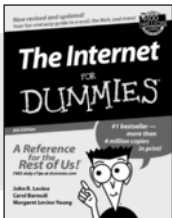

0-7645-0894-6

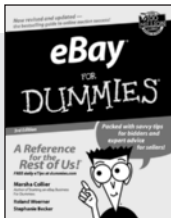

0-7645-1642-6

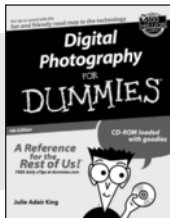

0-7645-1664-7

### Also available:

CD and DVD Recording For Dummies (0-7645-1627-2)

Digital Photography All-in-One Desk Reference For Dummies (0-7645-1800-3)

eBay For Dummies (0-7645-1642-6)

Genealogy Online For Dummies (0-7645-0807-5)

Internet All-in-One Desk Reference For Dummies (0-7645-1659-0)

Internet For Dummies Quick Reference (0-7645-1645-0)

Internet Privacy For Dummies (0-7645-0846-6)

Paint Shop Pro For Dummies (0-7645-2440-2)

Photo Retouching & Restoration For Dummies (0-7645-1662-0)

Photoshop Elements For Dummies (0-7645-1675-2)

Scanners For Dummies (0-7645-0783-4)

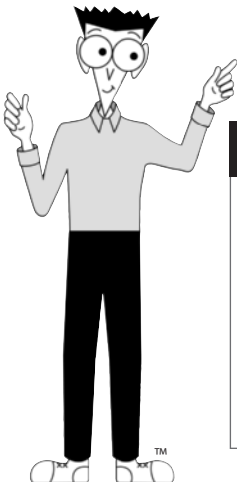

**Get smart! Visit [www.dummies.com](http://www.dummies.com)**

- Find listings of even more Dummies titles
- Browse online articles, excerpts, and how-to's
- Sign up for daily or weekly e-mail tips
- Check out Dummies fitness videos and other products
- Order from our online bookstore

Available wherever books are sold. Go to [www.dummies.com](http://www.dummies.com) or call 1-877-762-2974 to order direct





# FOR DUMMIES®

Helping you expand your horizons and realize your potential

## GRAPHICS & WEB SITE DEVELOPMENT

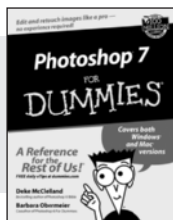

0-7645-1651-5

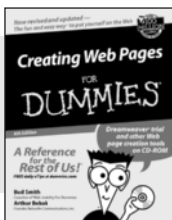

0-7645-1643-4

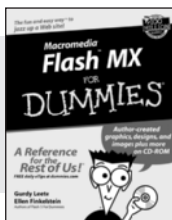

0-7645-0895-4

### Also available:

Adobe Acrobat 5 PDF For Dummies

(0-7645-1652-3)

ASP.NET For Dummies

(0-7645-0866-0)

ColdFusion MX for Dummies

(0-7645-1672-8)

Dreamweaver MX For Dummies

(0-7645-1630-2)

FrontPage 2002 For Dummies

(0-7645-0821-0)

HTML 4 For Dummies

(0-7645-0723-0)

Illustrator 10 For Dummies

(0-7645-3636-2)

PowerPoint 2002 For Dummies

(0-7645-0817-2)

Web Design For Dummies

(0-7645-0823-7)

## PROGRAMMING & DATABASES

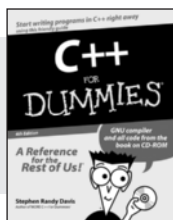

0-7645-0746-X

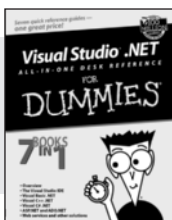

0-7645-1626-4

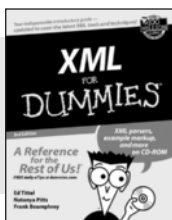

0-7645-1657-4

### Also available:

Access 2002 For Dummies

(0-7645-0818-0)

Beginning Programming For Dummies

(0-7645-0835-0)

Crystal Reports 9 For Dummies

(0-7645-1641-8)

Java & XML For Dummies

(0-7645-1658-2)

Java 2 For Dummies

(0-7645-0765-6)

JavaScript For Dummies

(0-7645-0633-1)

Oracle9i For Dummies

(0-7645-0880-6)

Perl For Dummies

(0-7645-0776-1)

PHP and MySQL For Dummies

(0-7645-1650-7)

SQL For Dummies

(0-7645-0737-0)

Visual Basic .NET For Dummies

(0-7645-0867-9)

## LINUX, NETWORKING & CERTIFICATION

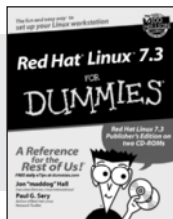

0-7645-1545-4

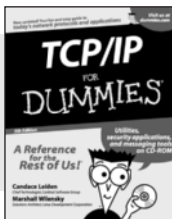

0-7645-1760-0

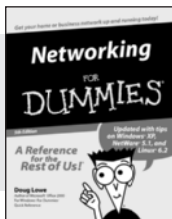

0-7645-0772-9

### Also available:

A+ Certification For Dummies

(0-7645-0812-1)

CCNP All-in-One Certification For Dummies

(0-7645-1648-5)

Cisco Networking For Dummies

(0-7645-1668-X)

CISSP For Dummies

(0-7645-1670-1)

CIW Foundations For Dummies

(0-7645-1635-3)

Firewalls For Dummies

(0-7645-0884-9)

Home Networking For Dummies

(0-7645-0857-1)

Red Hat Linux All-in-One Desk Reference For Dummies

(0-7645-2442-9)

UNIX For Dummies

(0-7645-0419-3)

Available wherever books are sold.

Go to [www.dummies.com](http://www.dummies.com) or call 1-877-762-2974 to order direct

