

Genetics
FOR
DUMMIES®

by Tara Rodden Robinson



WILEY

Wiley Publishing, Inc.

Genetics
FOR
DUMMIES®

Genetics
FOR
DUMMIES®

by Tara Rodden Robinson



WILEY

Wiley Publishing, Inc.

Genetics For Dummies®

Published by
Wiley Publishing, Inc.
111 River St.
Hoboken, NJ 07030-5774
www.wiley.com

Copyright © 2005 by Wiley Publishing, Inc., Indianapolis, Indiana

Published simultaneously in Canada

No part of this publication may be reproduced, stored in a retrieval system, or transmitted in any form or by any means, electronic, mechanical, photocopying, recording, scanning, or otherwise, except as permitted under Sections 107 or 108 of the 1976 United States Copyright Act, without either the prior written permission of the Publisher, or authorization through payment of the appropriate per-copy fee to the Copyright Clearance Center, 222 Rosewood Drive, Danvers, MA 01923, 978-750-8400, fax 978-646-8600. Requests to the Publisher for permission should be addressed to the Legal Department, Wiley Publishing, Inc., 10475 Crosspoint Blvd., Indianapolis, IN 46256, 317-572-3447, fax 317-572-4355, or online at <http://www.wiley.com/go/permissions>.

Trademarks: Wiley, the Wiley Publishing logo, For Dummies, the Dummies Man logo, A Reference for the Rest of Us!, The Dummies Way, Dummies Daily, The Fun and Easy Way, Dummies.com and related trade dress are trademarks or registered trademarks of John Wiley & Sons, Inc. and/or its affiliates in the United States and other countries, and may not be used without written permission. All other trademarks are the property of their respective owners. Wiley Publishing, Inc., is not associated with any product or vendor mentioned in this book.

LIMIT OF LIABILITY/DISCLAIMER OF WARRANTY: THE CONTENTS OF THIS WORK ARE INTENDED TO FURTHER GENERAL SCIENTIFIC RESEARCH, UNDERSTANDING, AND DISCUSSION ONLY AND ARE NOT INTENDED AND SHOULD NOT BE RELIED UPON AS RECOMMENDING OR PROMOTING A SPECIFIC METHOD, DIAGNOSIS, OR TREATMENT BY PHYSICIANS FOR ANY PARTICULAR PATIENT. THE PUBLISHER AND THE AUTHOR MAKE NO REPRESENTATIONS OR WARRANTIES WITH RESPECT TO THE ACCURACY OR COMPLETENESS OF THE CONTENTS OF THIS WORK AND SPECIFICALLY DISCLAIM ALL WARRANTIES, INCLUDING WITHOUT LIMITATION ANY IMPLIED WARRANTIES OF FITNESS FOR A PARTICULAR PURPOSE. IN VIEW OF ONGOING RESEARCH, EQUIPMENT MODIFICATIONS, CHANGES IN GOVERNMENTAL REGULATIONS, AND THE CONSTANT FLOW OF INFORMATION RELATING TO THE USE OF MEDICINES, EQUIPMENT, AND DEVICES, THE READER IS URGED TO REVIEW AND EVALUATE THE INFORMATION PROVIDED IN THE PACKAGE INSERT OR INSTRUCTIONS FOR EACH MEDICINE, EQUIPMENT, OR DEVICE FOR, AMONG OTHER THINGS, ANY CHANGES IN THE INSTRUCTIONS OR INDICATION OF USAGE AND FOR ADDED WARNINGS AND PRECAUTIONS. READERS SHOULD CONSULT WITH A SPECIALIST WHERE APPROPRIATE. THE FACT THAT AN ORGANIZATION OR WEBSITE IS REFERRED TO IN THIS WORK AS A CITATION AND/OR A POTENTIAL SOURCE OF FURTHER INFORMATION DOES NOT MEAN THAT THE AUTHOR OR THE PUBLISHER ENDORSES THE INFORMATION THE ORGANIZATION OR WEBSITE MAY PROVIDE OR RECOMMENDATIONS IT MAY MAKE. FURTHER, READERS SHOULD BE AWARE THAT INTERNET WEBSITES LISTED IN THIS WORK MAY HAVE CHANGED OR DISAPPEARED BETWEEN WHEN THIS WORK WAS WRITTEN AND WHEN IT IS READ. NO WARRANTY MAY BE CREATED OR EXTENDED BY ANY PROMOTIONAL STATEMENTS FOR THIS WORK. NEITHER THE PUBLISHER NOR THE AUTHOR SHALL BE LIABLE FOR ANY DAMAGES ARISING HEREFROM.

For general information on our other products and services, please contact our Customer Care Department within the U.S. at 800-762-2974, outside the U.S. at 317-572-3993, or fax 317-572-4002.

For technical support, please visit www.wiley.com/techsupport.

Wiley also publishes its books in a variety of electronic formats. Some content that appears in print may not be available in electronic books.

Library of Congress Control Number: 2005924624

ISBN-13: 978-0-7645-9554-7

ISBN-10: 0-7645-9554-7

Manufactured in the United States of America

10 9 8 7 6 5 4 3 2 1

10/RZ/QY/QV/IN



About the Author

Tara Rodden Robinson, R.N., B.S.N., Ph.D., is a native of Monroe, Louisiana, where she graduated from Ouachita Parish High School. She earned her degree in nursing at the University of Southern Mississippi and worked as a registered nurse for nearly six years (mostly in surgery), before running away from home to study birds in the Costa Rican rainforest. From the rainforests, Tara traveled to the cornfields of the Midwest to earn her Ph.D. in Biology at the University of Illinois, Urbana-Champaign. Her dissertation work was conducted in the Republic of Panama where she examined the social lives of Song Wrens. She got her post-doctoral training in genetics with Dr. Colin Hughes (University of Miami) and through a Postdoctoral Fellowship at Auburn University. Dr. Robinson received a teaching award for her genetics course at Auburn and was twice included in *Who's Who Among America's Teachers* (2002 and 2005).

Now, as assistant research professor in the Department of Fisheries and Wildlife at Oregon State University, Tara studies the genetics of birds and fish at Hatfield Marine Science Center in Newport, Oregon. Professor Robinson's research includes conducting paternity analysis to uncover the mysteries of birds' social lives, examining population genetics of endangered salmon, and using DNA to find out which species of salmon sea-going birds like to eat.

Professor Robinson conducts research on birds in locations all over the map including Oregon, Michigan, and the Republic of Panama. Her field research includes comparisons of the evolution of tropical and temperate birds, examining the effects of urbanization on swallows and bluebirds, describing the mating habits of Northern Mockingbirds, and documenting the effects of forest fragmentation on tropical bird populations. Recently, she and her husband, ornithologist W. Douglas Robinson, traveled to the island of Yap to survey birds and bats after a devastating typhoon wrecked the forests of that tiny, unique Micronesian state.

When not traveling, Professor Robinson enjoys playing Celtic and Scottish tunes on her fiddle and hiking the Coast Range of Oregon with her husband and their dog, Natchez.

Dedication

To my parents, Bill and Sammie Rodden.

And Douglas: You are my Vitamin D.

Author's Acknowledgments

I extend thanks to my wonderful editors at Wiley: Stacy Kennedy, Elizabeth Rea, and especially Mike Baker. Many other people at Wiley worked hard to make this book a reality; special thanks go to Melisa Duffy, Lindsay MacGregor, Abbie Enneking, Grace Davis, and David Hobson.

I appreciate the help of Doug P. Lyle, M.D., Walter D. Smith, Benoit Leclair, Maddy Delone and Jen Dolan of the Innocence Project, and Jorge Berreno at Applied Biosystems, Inc. I thank Paul Farber (Oregon State University), Iris Sandler (University of Washington), Robert J. Robbins (Fred Hutchinson Cancer Research Center), and Garland E. Allen (Washington University) for answering my queries about genetics history. Electronic Scholarly Publishing provided access to historically important genetics papers on the Web.

Many people provided support during the preparation of the manuscript: Jill Lee loosened my muscles, John and all the good people at Sunnyside Up supplied caffeine, and Bill Rodden read chapters. I acknowledge the support of the faculty, staff, and students of the Department of Fisheries and Wildlife, Oregon State University. Julia Whittington, DVM, of University of Illinois Urbana-Champaign School of Veterinary Medicine answered my questions about the reproductive physiology of cats and dogs. Oris Acevedo; the Smithsonian Tropical Research Institute; and the scientists of Barro Colorado Island, particularly Rachel Page and Egbert Leigh, provided congenial company and office space in Panama. My colleagues Michael Banks, Martin Wikelski, Bob Ricklefs, and Phil Rossignol provided constant encouragement.

I also want to thank my postdoctoral mentor, Colin Hughes (now of Florida Atlantic University). I send a hearty "War Eagle!" to my friends, former students, and colleagues from Auburn University, especially Mike & Marie Wooten, Sharon Roberts, and Shreekumar Pulai.

My deepest gratitude goes to my husband, Douglas, who patiently endured all the throes of writing and bouts of insomnia while unfailingly providing love, support, and "Vitamin D." I'm grateful to all our students at OSU, especially Suzanne Austin-Bythell. Our friends, Elsie and Elzy Eltzroth, Linda Audrain, and Craig Skinner cheered me on, and Shari Ame provided musical distraction. Finally, I thank my mom and dad for love, support, prayers, and gumbo.

Publisher's Acknowledgments

We're proud of this book; please send us your comments through our Dummies online registration form located at www.dummies.com/register/.

Some of the people who helped bring this book to market include the following:

Acquisitions, Editorial, and Media Development

Project Editor: Mike Baker

Acquisitions Editor: Stacy Kennedy

Copy Editor: Elizabeth Rea

Editorial Program Assistant: Courtney Allen

Technical Reviewer: Nathan Pankratz

Editorial Manager: Christine Meloy Beck

Editorial Assistant: Hanna Scott, Nadine Bell

Cover Photos: © U.S. Department of Energy Human Genome Program
(www.ornl.gov/hgmis)

Cartoons: Rich Tennant
(www.the5thwave.com)

Composition Services

Project Coordinator: Nancee Reeves

Layout and Graphics: Carl Byers, Kely Emkow, Barry Offringa, Heather Ryan, Erin Zeltner

Proofreaders: Leeann Harney, Jessica Kramer, Joe Niesen, Carl William Pierce, TECHBOOKS Production Services

Indexer: TECHBOOKS Production Services

Publishing and Editorial for Consumer Dummies

Diane Graves Steele, Vice President and Publisher, Consumer Dummies

Joyce Pepple, Acquisitions Director, Consumer Dummies

Kristin A. Cocks, Product Development Director, Consumer Dummies

Michael Spring, Vice President and Publisher, Travel

Kelly Regan, Editorial Director, Travel

Publishing for Technology Dummies

Andy Cummings, Vice President and Publisher, Dummies Technology/General User

Composition Services

Gerry Fahey, Vice President of Production Services

Debbie Stailey, Director of Composition Services

Contents at a Glance

<i>Introduction</i>	1
<i>Part I: Genetics Basics</i>	7
Chapter 1: What Genetics Is and Why You Need to Know Some	9
Chapter 2: Celling Out: Basic Cell Biology	19
Chapter 3: Mendel's Peas Plan: Discovering the Laws of Inheritance	37
Chapter 4: Law Enforcement: Mendel's Laws Applied to Complex Traits	51
Chapter 5: The Subject of Sex	65
<i>Part II: DNA: The Genetic Material</i>	79
Chapter 6: DNA: The Basis of Life	81
Chapter 7: Copying Your DNA: Replication	97
Chapter 8: RNA: Like DNA but Different	115
Chapter 9: Translating the Genetic Code	129
Chapter 10: What a Cute Pair of Genes: Gene Expression	143
<i>Part III: Genetics and Your Health</i>	159
Chapter 11: Sequencing Your DNA	161
Chapter 12: Genetic Counseling	175
Chapter 13: Mutation and Inherited Diseases	189
Chapter 14: The Genetics of Cancer	203
Chapter 15: Chromosome Disorders	221
Chapter 16: No Couch Needed: Gene Therapy	237
<i>Part IV: Genetics and Your World</i>	249
Chapter 17: Tracing Human History and the Future of the Planet	251
Chapter 18: Forensic Genetics: Solving Mysteries Using DNA	265
Chapter 19: Genetic Makeovers: Fitting New Genes into Plants and Animals	283
Chapter 20: Cloning: There'll Never Be Another You	299
Chapter 21: Ethics: The Good, the Bad, and the Ugly	313

<i>Part V: The Part of Tens</i>	323
Chapter 22: Ten Defining Events in Genetics	325
Chapter 23: Ten of the Hottest Issues in Genetics	333
Chapter 24: Ten Terrific Genetics Web Sites	341
<i>Glossary</i>	345
<i>Index</i>	349

Table of Contents

***Introduction* 1**

About This Book	1
Conventions Used in This Book	2
What You're Not to Read	2
Foolish Assumptions	3
How This Book Is Organized	3
Part I: Genetics Basics	3
Part II: DNA: The Genetic Material	4
Part III: Genetics and Your Health	4
Part IV: Genetics and Your World	4
Part V: The Part of Tens	4
Icons Used in This Book	5
Where to Go from Here	5

***Part I: Genetics Basics* 7**

Chapter 1: What Genetics Is and Why You Need to Know Some 9

What Is Genetics?	9
Classical genetics: Transmitting traits from generation to generation	10
Molecular genetics: The chemistry of genes	11
Population genetics: Genetics of groups	12
Quantitative genetics: Measuring the strength of heredity	13
Living the Life a Geneticist	13
Exploring a genetics lab	13
Sorting through careers in genetics	15

Chapter 2: Celling Out: Basic Cell Biology 19

Welcome to Your Cell!	19
Cells without a nucleus	20
Cells with a nucleus	21
Examining the basics of chromosomes	22
Mitosis: We Gotta Split, Baby!	26
Step 1: Time to grow	27
Step 2: Divvying up the chromosomes	29
Step 3: Splitsville	31
Meiosis: Making Cells for Sex	31
Meiosis Part I	33
Meiosis Part II	35
Mommy, where did I come from?	35

Chapter 3: Mendel's Peas Plan: Discovering the Laws of Inheritance	37
Flower Power: Gardening with Gregor Mendel	38
Getting the Lowdown on Inheritance Lingo	39
Making Inheritance Simple	40
Establishing dominance	41
Segregating alleles	43
Declaring independence	45
Finding Unknown Alleles	45
Using Basic Probability to Compute the Likelihood of Inheritance	46
Solving Simple Genetics Problems	48
Deciphering a monohybrid cross	48
Tackling a dihybrid cross	49
Chapter 4: Law Enforcement: Mendel's Laws Applied to Complex Traits	51
Dominant Alleles Rule . . . Sometimes	51
Wimping out with incomplete dominance	52
Keeping it fair with codominance	52
Dawdling with incomplete penetrance	53
Alleles Causing Complications	54
More than two alleles	54
Lethal alleles	56
Making Life More Complicated	56
When genes interact	56
Genes in hiding	57
Genes linked together	59
One gene with many phenotypes	62
Uncovering More Exceptions to Mendel's Laws	62
Genomic imprinting	63
Anticipation	63
Environmental effects	64
Chapter 5: The Subject of Sex	65
How You Got So Sexy	65
X-rated: Sex determination in humans	67
Surprising ways to get sex: Sex determination in other organisms	69
Sex-Determination Disorders in Humans	73
Extra Xs	74
Extra Ys	75
One X and no Y	75
Sex-linked Inheritance	76
X-linked disorders	76
Sex-limited traits	77
Sex-influenced traits	78
Y-linked traits	78

Part II: DNA: The Genetic Material 79**Chapter 6: DNA: The Basis of Life 81**

Deconstructing DNA	82
Chemical components of DNA	83
Assembling the double helix: The structure of DNA	87
Examining Different Sets of DNA	91
Nuclear DNA	91
Mitochondrial DNA	92
Chloroplast DNA	93
Digging into the History of DNA	93
Discovering DNA	93
Obeying Chargaff's rules	94
Hard feelings and the helix: Franklin, Wilkins, Watson, and Crick	95

Chapter 7: Copying Your DNA: Replication 97

Unzipped: Creating the Pattern for More DNA	98
How DNA Copies Itself	101
Meeting the replication crew	102
Splitting the helix	105
Priming the pump	106
Leading and lagging	106
Joining all the pieces	108
Proofreading replication	109
Replication in Eukaryotes	110
Pulling up short: Telomeres	110
Finishing the job	112
How Circular DNAs Replicate	113
Theta	113
Rolling circle	114
D-loop	114

Chapter 8: RNA: Like DNA but Different 115

You Already Know a Lot about RNA	115
Using a slightly different sugar	116
Meeting a new base: Uracil	117
Stranded!	119
Transcription: Copying DNA's Message into RNA's Language	119
Getting ready to transcribe	120
Initiation	124
Elongation	124
Termination	126
Post-transcription Processing	126
Adding cap and tail	126
Editing the message	127

Chapter 9: Translating the Genetic Code	129
Discovering the Good in a Degenerate	129
Considering the combinations	131
Framed! Reading the code	132
Not quite universal	133
Meeting the Translating Team	133
Taking the Translation Trip	133
Initiation	134
Elongation	137
Termination	138
Proteins Are Precious Polypeptides	139
Recognizing radical groups	140
Giving the protein its shape	142
Chapter 10: What a Cute Pair of Genes: Gene Expression	143
Getting Your Genes Under Control	144
Transcriptional Control of Gene Expression	146
Tightly wound: The effect of DNA packaging	147
Genes controlling genes	148
Hormones turn me on	151
Retroactive Control: Things That Happen After Transcription	153
Nip and tuck: RNA splicing	153
Shut up! mRNA silencing	155
mRNA expiration dates	155
Gene Control Lost in Translation	156
Modifying where translation occurs	156
Modifying when translation occurs	156
Modifying the protein shape	157
Part III: Genetics and Your Health	159
Chapter 11: Sequencing Your DNA	161
Trying on a Few Genomes	161
Sequencing Your Way to the Human Genome	164
The yeast genome	165
The elegant roundworm genome	166
The chicken genome	166
The Human Genome Project	167
Sequencing: Reading the Language of DNA	169
Identifying the players in DNA sequencing	169
Breaking down the sequencing process	170
Finding the message in sequencing results	172

Chapter 12: Genetic Counseling	175
Getting to Know Genetic Counselors	175
Building and Analyzing a Family Tree	176
Autosomal dominant traits	179
Autosomal recessive traits	180
X-linked recessive traits	182
X-linked dominant traits	184
Y-linked traits	185
Staying Ahead of the Game: Genetic Testing	186
General testing	186
Prenatal testing	187
Newborn screening	188
Chapter 13: Mutation and Inherited Diseases	189
Starting Off with Types of Mutations	189
Uncovering Causes of Mutation	190
Spontaneous mutations	191
Induced mutations	195
Facing the Consequences of Mutation	198
Evaluating Options for DNA Repair	199
Examining Common Inherited Diseases	200
Cystic fibrosis	201
Sickle cell anemia	201
Tay-Sachs	202
Chapter 14: The Genetics of Cancer	203
Defining Cancer	203
Benign growths	204
Malignancies	205
Metastasis: Cancer on the go	206
Recognizing Cancer as a DNA Disease	207
Exploring the cell cycle and cancer	208
Demystifying chromosome abnormalities	213
Breaking Down the Types of Cancers	214
Hereditary cancers	214
Preventable cancers	217
Chapter 15: Chromosome Disorders	221
Studying Chromosomes	221
Counting Up Chromosomes	223
Aneuploidy: Extra or missing chromosomes	223
Euploidy: Numbers of chromosomes	226
Chromosome Disorders	227
When chromosomes are left out	228
When too many chromosomes are left in	228
Other things that go wrong with chromosomes	232

Chapter 16: No Couch Needed: Gene Therapy237

Curing Genetic Disease	237
Finding Vehicles to Get Genes to Work	238
Viruses that join right in	239
Viruses that are a little standoffish	240
Inserting Healthy Genes into the Picture	240
Checking out a DNA library	243
Mapping the gene	245
Making Slow Progress on the Gene Therapy Front	246

Part IV: Genetics and Your World249**Chapter 17: Tracing Human History
and the Future of the Planet251**

Genetic Variation Is Everywhere	251
Allele frequencies	252
Genotype frequencies	255
Breaking Down the Hardy-Weinberg Law of Population Genetics	256
Relating alleles to genotypes	256
Violating the law	259
Mapping the Gene Pool	260
One big happy family	261
Uncovering the secret social lives of animals	262

Chapter 18: Forensic Genetics: Solving Mysteries Using DNA265

Rooting through Your Junk (DNA, That Is) to Find Your Identity	266
Investigating the Scene: Where's the DNA?	268
Collecting biological evidence	268
Moving to the lab	270
Catching Criminals (and Freeing the Innocent)	275
Matching the evidence to the bad guy	275
Taking a second look at guilty verdicts	277
It's All Relative: Finding Family	277
Paternity testing	277
Relatedness testing	280

**Chapter 19: Genetic Makeovers: Fitting New Genes
into Plants and Animals283**

Seeing Genetically Modified Organisms Everywhere	283
Making modifications down on the farm	284
Relying on radiation and chemicals	284
Introducing unintentional modifications	286
Putting Old Genes in New Places	286

Puttering with Transgenic Plants	288
Following the transgenesis process in plants	288
Exploring commercial applications	290
Weighing points of contention	291
Assessing outcomes	294
Toying with Transgenic Animals	294
Trifling with Transgenic Insects	297
Fiddling with Transgenic Bacteria	297
Chapter 20: Cloning: There'll Never Be Another You	299
Attack of the Clones	299
Like No Udder	300
Cloning before Dolly: Working with sex cells	300
Discovering why Dolly is really something to bah about	302
Clone It Yourself!	303
Making twins	303
Using a somatic cell nucleus to make a clone	304
Confronting Problems with Clones	306
Faster aging	306
Bigger offspring	307
Developmental disasters	309
Effects of the environment	309
Weighing Both Sides of the Cloning Debate	310
Arguments for cloning	310
Arguments against cloning	311
Chapter 21: Ethics: The Good, the Bad, and the Ugly	313
Going to Extremes with Genetic Racism	314
Taking Steps to Create Designer Babies	315
The myth of designer babies	315
The reality of the science: Prenatal diagnosis	316
Toying with Informed Consent	316
Placing restrictions on genetic testing	317
Practicing safe genetic treatment	318
Doling out information access	319
Genetic Property Rights	320
Part V: The Part of Tens	323
Chapter 22: Ten Defining Events in Genetics	325
The Publication of Darwin's Origin of Species	325
The Rediscovery of Mendel's Work	326
The Transforming Principle	327
The Discovery of Jumping Genes	328

The Birth of DNA Sequencing	329
The Invention of PCR	329
The Development of Recombinant DNA Technology	330
The Invention of DNA Fingerprinting	330
The Explanation of Developmental Genetics	331
The Work of Francis Collins and the Human Genome Project	332
Chapter 23: Ten of the Hottest Issues in Genetics	333
Pharmacogenomics	333
Stem Cell Research	334
Genetics of Aging	334
Proteomics	335
Bioinformatics	336
Nanotechnology	336
Gene Chips	337
Evolution of Antibiotic Resistance	338
Genetics of Infectious Disease	338
Bioterrorism	339
Chapter 24: Ten Terrific Genetics Web Sites	341
Cell Division	341
Mendelian Genetics	341
General Genetics Education	342
The Human Genome Project and Beyond	342
Genes We Share with Other Organisms	342
The Latest News	343
Genetic Disorders in Humans	343
Careers in Genetics	343
Pet Genetics	344
The Latest Discoveries	344
<i>Glossary</i>	345
<i>Index</i>	349

Introduction

Genetics affects every aspect of life on earth. As a science, it's one of the fastest growing fields because it has untold potential — for good and for ill. Although complicated and diverse, all genetics comes down to basic principles of heredity and how DNA is put together. So it turns out that genetics, in many ways, is surprisingly accessible. Genetics is a bit like taking a peek behind a movie's special effects to find a deceptively simple and elegant system running the whole show.

I may sound like a geek, but genetics is my favorite subject. If you'd told me I'd end up feeling this way when I took my first genetics course, I would have laughed. At first, I *hated* genetics (and I barely passed!). But as I learned more, I was hooked. Now, my career follows the genetics of birds in hopes of helping to conserve the natural beauty that makes our world such a wonderful place to be. In the pages to come, I hope that I communicate my genuine enthusiasm for this fascinating subject so that you, too, can appreciate the marvels of this complex science.

About This Book

Genetics For Dummies is an overview of the entire field of genetics. My goal is to explain each topic in such a way that anyone, even someone without any genetics background at all, can follow the subject and understand how it works. In an effort to make the book as current as possible, I've included many examples from the frontiers of research. I've also made sure that the book has detailed coverage of some of the hottest topics that you hear about in the news: cloning, gene therapy, and forensics. Most genetics texts don't cover these subjects in depth, if at all. I've also addressed the practical side of genetics: how it affects your health and the world around you. In short, this book is designed to be a solid introduction to genetics basics as well as to provide some details on the subject.

Genetics is a fast-paced field; new discoveries are published every week. You can use this book to help you get through your genetics course, or you can use it simply for self-guided study. *Genetics For Dummies* gives you enough information to get a handle on the latest press coverage, understand the genetics jargon that crime writers like to toss around, and translate information imparted to you by medical professionals. I've filled the book with stories of key discoveries and “wow” developments. I've tried to keep things light and inject some humor when possible, but, at the same time, I've made an effort to be sensitive to whatever your circumstances may be.

This book is a great guide if you know nothing at all about genetics. If you already have some background, then you're set to dive into the details of the subject and expand your horizons.

Conventions Used in This Book

I'm a real live, working scientist. It would be very easy for me to use scientific language that you'd need a translator to understand. But what fun would that be? Throughout this book, I've avoided jargon as much as possible, but at the same time, I use and carefully define terms that geneticists actually use. After all, it may be important for you to understand some of these multisyllabic jawbreakers in the course of your studies or your, or a loved one's, medical treatment.

To help you navigate through this book, I also use the following typographical conventions:

- ✓ *Italic* is used for emphasis and to highlight new words or terms that are defined in the text.
- ✓ **Boldface** is used to indicate keywords in bulleted lists or the action parts of numbered steps.
- ✓ `Monofont` is used for Web addresses.
- ✓ Sidebars are shaded gray boxes that contain text that's interesting to know but not necessarily critical to your understanding of the chapter or section topic.

What You're Not to Read

Anytime you see a Technical Stuff icon (see "Icons Used in This Book" later in this Introduction), you can cruise past the information it's attached to without missing a key explanation. For the serious reader, the technical bits add some depth and detail to the book. You also have permission to skip the shaded gray boxes known as sidebars — if you really want to. Doing so doesn't affect your understanding of the subject at hand. But you should know that I've stuck a lot of really cool stuff in these boxes — things like extracting DNA from an ancient human buried in a glacier and tracing Thomas Jefferson's family tree — so I'm guessing they'll grab your attention more often than not.

Foolish Assumptions

I'm honored to be your guide into the complex world of genetics. Given this responsibility, I thought about you a lot while writing this book. Here's how I've imagined you, my reader:

- ✔ You're a student in a basic genetics or biology class.
- ✔ You're simply curious to understand more about the science you hear reported in the news.
- ✔ You're an expectant or new parent or a family member who's deeply concerned about a precious child and struggling to come to terms with what doctors have told you.
- ✔ You're dealing with cancer or some hereditary disease, wondering what it means for you and your family.

If any of these descriptions strikes a chord, you've come to the right place.

How This Book Is Organized

I designed this book to cover background material in the first two parts and then all the applications in the rest of the book. I think you'll find it quite accessible.

Part I: Genetics Basics

This section explains how trait inheritance works. The first chapter gives you a handle on how genetic information gets divvied up during cell division; these events provide the foundation for just about everything else that has to do with genetics. From there, I explain simple inheritance of one trait and then move on to more complex forms of inheritance. This part ends with an explanation of how sex works — that is, how genetics determines maleness or femaleness and how your sex affects how your genes work. (There's another *For Dummies* book, written by one Dr. Ruth, that you can check out if you're wondering how sex *really* works.)

Part II: DNA: The Genetic Material

This part covers what's sometimes called *molecular genetics*. But don't let that term scare you off. It's the nitty-gritty details, but I break it all down so that you can follow right along. I track the progress of how your genes work from start to finish here: how your DNA is put together, how it gets copied, and how the building plans for your body are encoded in the double helix.

Part III: Genetics and Your Health

Part III is intended to help you see how genetics affects your health and well-being. To help you understand how scientists uncover the secrets stored in your DNA, I cover how DNA is sequenced. In the process, I relate the fascinating story behind the Human Genome Project. I cover the subjects of genetic counseling, inherited diseases, genetics and cancer, and chromosome disorders, such as Down syndrome. I also include a chapter on gene therapy, a practice that may hold the key to cures or treatments for many of the disorders described in this part of the book.

Part IV: Genetics and Your World

This part of the book explains the broader impacts of genetics and covers some hot topics that are often in the news. I explain how technologies work and highlight both the possibilities and the perils of each. I delve into population genetics (of both humans, both past and present, and endangered animal species), DNA and forensics, genetically modified plants and animals, cloning, and the issue of ethics, which is raised on a daily basis as scientists push the boundaries of the possible with cutting-edge technology.

Part V: The Part of Tens

In Part V, you get my lists of ten milestone events and important people who have shaped genetics history, ten of the next big things in the field, and more than ten Web sites (I couldn't leave any out!) that can provide you with more details on the interesting issues you find elsewhere in the book.

Icons Used in This Book

All *For Dummies* books use icons to help readers keep track of what's what. Here's a rundown of the icons used in this book and what they all mean.



I use this icon to flag information that's critical to your understanding or particularly important to keep in mind.



This icon alerts you to points in the text where I provide added insight on how to better get a handle on a concept. I draw on my teaching experience for these tips and alert you to other sources of information you can check out.



These details are useful but not necessary to know. If you're not a student, these sections may be especially skippable for you.



This icon points out stories about the people behind the science and accounts of how discoveries came about.



This fine piece of art alerts you to recent applications of genetics in the field or in the lab.

Where to Go from Here

With *Genetics For Dummies*, you can start anywhere, on any chapter, and get a handle on what you're interested in right away. I made liberal use of cross-references all over the book to help you get background details that you may have skipped earlier. The table of contents and index can point you to specific topics in a hurry, or you can just start at the beginning and work your way straight through. If you read the book from front to back, you'll get a short course in genetics in the style and order it's often taught in colleges and universities — Mendel first and DNA second.

Part I

Genetics Basics

The 5th Wave

By Rich Tennant



"You can do all the DNA testing you want Pinocchio, but I still feel this is your baby."

In this part . . .

Genetics, first and foremost, is concerned with how traits are inherited. The processes of cell division are at the root of how chromosomes get doled out to offspring. When genes are passed on, some are assertive and dominant while others are shy and recessive. The study of how different traits are inherited and expressed is called Mendelian genetics.

Genetics also determines your sex (as in maleness or femaleness), and your sex influences how certain traits are expressed. In this part, I explain what genetics is and what it's used for, how cells divide, and the basics of how traits are passed from parents to offspring.

Chapter 1

What Genetics Is and Why You Need to Know Some

In This Chapter

- ▶ Introducing the subject of genetics
 - ▶ Uncovering the activities of a typical genetics lab
 - ▶ Getting the scoop on career opportunities in genetics
-

Welcome to the complex and fascinating world of genetics. Genetics is all about physical traits and the code carefully hidden away in DNA that supplies the building plans for any organism. This chapter explains what the field of genetics is, and what geneticists do. You get an introduction to the big picture and a glimpse at some of the details found in other chapters of this book.

What Is Genetics?



Genetics is the field of science that examines how traits are passed from one generation to the next. Simply put, genetics affects *everything* about *every* living thing on earth. An organism's *genes*, snippets of DNA that are the fundamental units of heredity, control how it looks, behaves, and reproduces. Because all biology depends on genes, it's critical to understand genetics as a foundation for all the other sciences, including agriculture and medicine.



From a historical point of view, genetics is a young science. The principles that govern inheritance of traits by one generation from another were described (and promptly lost) less than 150 years ago. Around the turn of the 20th century, the laws of inheritance were rediscovered, an event that transformed biology forever. But even then, the importance of the star of the genetics show, DNA, wasn't really understood until the 1950s. Now, technology is helping geneticists push the envelope of knowledge every day.

Genetics is generally divided into four major subdivisions:

- ✓ **Classical genetics:** Describes how traits (physical characteristics) are passed along from one generation to another.
- ✓ **Molecular genetics:** The study of the chemical and physical structures of DNA, its cousin RNA, and proteins.
- ✓ **Population genetics:** Takes Mendelian genetics (that is, the genetics of individual families) and ramps it up to look at the genetic makeup of larger groups.
- ✓ **Quantitative genetics:** A highly mathematical field that examines the statistical relationships between genes and the traits they encode.

In the academic world, many genetics courses begin with classical genetics and proceed through molecular genetics, with a nod to populations or quantitative genetics. This book follows the same path because each division of knowledge builds on the one before it. That said, it's perfectly okay and easy to jump around between disciplines (in my own career, I started in molecular genetics, then went classical, and finally ended up in populations).

Classical genetics: Transmitting traits from generation to generation



Classical genetics is old school — the original form of genetics and, in many ways, still the best. At its heart, classical genetics is the genetics of individuals and their families. It focuses mostly on studying physical traits as a stand-in for the genes that control appearance, or *phenotype*.

Gregor Mendel, a humble monk and part-time scientist, founded the entire discipline of genetics, although he didn't know it. Mendel was a gardener with an unstoppable curiosity to go with his green thumb. His observations may have been simple, but his conclusions were jaw-droppingly elegant. This man had no access to technology, no computers, and no pocket calculator, yet he determined, with keen accuracy, exactly how inheritance works.

Classical genetics is sometimes referred to as:

- ✓ **Mendelian genetics:** You start a new scientific discipline, you get it named after you. Seems fair.
- ✓ **Transmission genetics:** This term refers to the fact that classical genetics describes how traits are passed on, or *transmitted*, by parent organisms to their offspring.

No matter what you call it, classical genetics includes the study of cells and chromosomes (which I delve into in Chapter 2). Cell division is the machine that runs inheritance. But you don't have to understand combustion engines to drive a car, right? Likewise, you can dive straight into simple inheritance (see Chapter 3) and work up to more complicated forms of inheritance (in Chapter 4) without knowing anything whatsoever about cell division. (Mendel didn't know anything about chromosomes and cells when he figured this whole thing out, by the way.)

The genetics of sex and reproduction are also part of classical genetics. *Sex*, as in maleness and femaleness, is determined by various combinations of genes and chromosomes (strands of DNA). But the subject of sex gets even more complicated (and interesting): The environment plays a role in determining the sex of some organisms (like crocodiles and turtles), and other organisms can even change sex with a change of address. If I've piqued your interest, you can find out all the slightly kinky details in Chapter 5.

Classical genetics provides the framework for many subdisciplines. Genetic counseling (covered in Chapter 12) depends heavily on understanding patterns of inheritance to interpret people's medical histories from a genetics perspective. The study of chromosome disorders such as Down syndrome (see Chapter 15) relies on cell biology and an understanding of what happens during cell division. Forensics (see Chapter 18) also uses Mendelian genetics to determine paternity and work out who's who with DNA fingerprinting.

Molecular genetics: The chemistry of genes



Classical genetics concentrates on studying outward appearances, but the study of actual genes falls under the heady title of *molecular genetics*. The area of operations for molecular genetics includes all the machinery that runs cells and manufactures the structures called for by the plans found in genes. The focus of molecular genetics includes the physical and chemical structures of the double helix, DNA, which I break down in all its glory in Chapter 6. The messages hidden in your DNA (your genes) constitute the building instructions for your appearance and everything else about you — from how your muscles function and how your eyes blink to your blood type, your susceptibility to particular diseases, and everything in between.

Your genes are expressed through a complex system of interactions that begins with copying DNA's messages into a somewhat temporary form called RNA (see Chapter 8). RNA carries the DNA message through the process of translation (covered in Chapter 9), which, in essence, is like taking a blueprint to a factory to guide the manufacturing process. Where your genes are concerned, the factory makes the proteins (from the RNA blueprint) that get folded in complex ways to make you.

The study of gene expression (how genes get turned on and off; flip to Chapter 10) and how the genetic code works at the levels of DNA and RNA is considered part of molecular genetics. Research on the causes of cancer and the hunt for a cure (which I address in Chapter 14) focus on the molecular side of things because mutations occur at the chemical level of DNA (see Chapter 13 for coverage of mutations). Gene therapy (see Chapter 16), genetic engineering (see Chapter 19), and cloning (see Chapter 20) are all subdisciplines of molecular genetics.

Population genetics: Genetics of groups

Much to the chagrin of many undergrads, genetics is surprisingly mathematical. One area in which calculations are used to describe what goes on genetically is population genetics.



If you take Mendelian genetics and examine the inheritance patterns of many different individuals who have something like geographic location in common, then you've got population genetics. *Population genetics* is the study of the genetic diversity of a subset of a particular species (for details, jump to Chapter 17). In essence, it's a search for patterns that help describe the genetic signature of a particular group, such as the consequences of travel, isolation (from other populations), mating choices, geography, and behavior.



Population genetics helps scientists understand how the collective genetic diversity of a population influences the health of individuals within the population. For example, cheetahs are lanky cats; they're the speed demons of Africa. Population genetics has revealed that all cheetahs are very, very genetically similar; in fact, they're so similar that a skin graft from any animal won't be rejected by any other animal. Because the genetic diversity of cheetahs is so low, conservation biologists fear that a disease could sweep through the population and kill off all the individuals of the species. It's possible that no animals would be resistant to the disease, and therefore none would survive, leading to the extinction of this amazing predator.

Describing the genetics of populations from a mathematical standpoint is critical to forensics (see Chapter 18). To pinpoint the uniqueness of one DNA fingerprint, geneticists have to sample the genetic fingerprints of many individuals and decide how common or rare a particular pattern may be. Medicine also uses population genetics to determine how common particular mutations are and in an attempt to develop new medicines to treat disease. (For details on mutations, flip to Chapter 13; see Chapter 21 for information on genetics and the development of new medicines.)

Quantitative genetics: Measuring the strength of heredity



Quantitative genetics examines traits that vary in really subtle ways and relates those traits to the underlying genetics of organisms. Characteristics like retrieving ability in dogs, egg size or number in birds, and running speed in humans are all controlled by a combination of whole suites of genes and environmental effects. Mathematical in nature, quantitative genetics takes a rather complex statistical approach to estimate how much variation in a particular trait is due to the environment and how much is actually genetic.

One application of quantitative genetics is determining how heritable a particular trait is. This measure allows scientists to make predictions about how offspring will turn out based on characteristics of the parent organisms. Therefore, quantitative genetics is used heavily in agriculture for plant and animal breeding. Heritability gives some indication of how much a characteristic (like crop yield) can change when selective breeding is applied. Most recently, quantitative genetics has been applied to a process called QTL analysis, which estimates how many genes control a particular trait (QTL stands for *quantitative trait loci*; loci in this context refers to some number of genes). The estimate obtained by QTL analysis is combined with sequencing (see Chapter 11) to map the location of various genes. (Chapter 16 describes the methods used to find genes on chromosomes.) Unfortunately, quantitative genetics is beyond the scope of this book.

Living the Life a Geneticist

The daily life of a geneticist can include working in the lab, teaching in the classroom, and interacting with patients and their families. In this section, you discover what a typical genetics lab is like and get a rundown of a variety of career paths in the genetics field.

Exploring a genetics lab

A genetics lab is a busy, noisy place. It's full of equipment and supplies and researchers toiling away at their workstations (called *lab benches*, even though the bench is really just a raised, flat surface that's conducive to working while standing up). Depending on whose lab you're in, everyone may look very official in white lab coats. Then again, some labs are very casual — jeans and T-shirts may be perfectly acceptable. Regardless of the attire, just about

every lab I've ever worked in had a stereo blaring away, the choice of music often determined by fierce (but usually good-natured) competition among lab mates. Besides stereos, every lab contains some or all of the following:

- ✓ Various sizes of disposable gloves to protect workers from chemical exposure as well as to protect DNA and other materials from contamination.
- ✓ Pipettes for measuring even the tiniest droplets of liquids with extreme accuracy.
- ✓ Glassware for precise measurement and storage of liquids.
- ✓ Electronic balances for making super-precise measurements of weights.
- ✓ Vials and tubes for chemical reactions.
- ✓ Chemicals and ultrapure water.
- ✓ Freezers and refrigerators for storing samples. Every lab has a regular refrigerator (set at 40 degrees Fahrenheit), a freezer (at -4 degrees), and an ultracold (at -112 degrees).

Freezers used in genetics labs aren't frost-free because the temperature inside a frost-free freezer cycles up and down to melt any ice that forms. Repeated freezing and thawing causes DNA to break into tiny pieces, which destroys it.

- ✓ Centrifuges for separating substances from each other. Given that different substances have different densities, centrifuges spin at extremely high speeds to force materials to separate so they can be handled individually. You're probably already familiar with the principle of how substances with differing densities separate — just look at how oil and water behave when mixed.
- ✓ Incubators for growing bacteria under controlled conditions. This equipment maintains exact temperatures and, often, certain amounts of carbon dioxide or oxygen to satisfy the requirements of various bacteria for growth. Many incubators contain shakers that slosh liquids around to mix oxygen into the solution.
- ✓ Autoclaves for sterilizing glassware and other equipment that can withstand exposure to the extreme heat and pressure that kills bacteria and viruses.
- ✓ Complex pieces of equipment such as thermocyclers (used for PCR; see Chapter 18) and DNA sequencers (see Chapter 11).
- ✓ Lab notebooks for recording every step of every reaction or experiment in nauseating detail. This obsessive record keeping is necessary because every experiment must be fully replicated (run over and over) to make sure the results are valid. The lab notebook is also a legal document that can be used in court cases, so precision and completeness are musts.
- ✓ Desktop computers packed with software for analyzing results and connecting via the Internet to vast databases packed with genetic information (flip to Chapter 24 for the addresses of some useful sites).



Researchers in the lab use the various pieces of equipment and supplies listed above to conduct experiments and run chemical reactions. Some of the common activities occurring in the genetics lab include:

- ✔ Separating DNA from the rest of the cell's contents (see Chapter 6)
- ✔ Measuring the purity of a DNA sample and determining how much DNA (by weight) is present
- ✔ Mixing chemicals that are used in reactions and experiments designed to analyze DNA samples
- ✔ Growing special strains of bacteria and viruses to aid in examining short stretches of DNA (see Chapter 16)
- ✔ Using DNA sequencing (covered in Chapter 11) to learn the order of bases that compose a DNA strand (which I explain in Chapter 6)
- ✔ Setting up polymerase chain reactions, or PCR (see Chapter 18), a powerful process that allows scientists to analyze even very tiny amounts of DNA
- ✔ Analyzing the results of DNA sequencing by comparing sequences from many different organisms (this information is found in a massive, publicly available database; see Chapter 24)
- ✔ Comparing DNA fingerprints from several individuals to identify perpetrators or assign paternity (see Chapter 18)
- ✔ Weekly or daily lab meetings when everyone in the lab comes together to discuss results or plan new experiments

Sorting through careers in genetics

Whole teams of people contribute to the study of genetics. The following are just a few job descriptions for you to mull over if you're considering a career in genetics.

Lab tech

Lab technicians handle most of the day-to-day happenings in the lab. The tech mixes chemicals for everyone else in the lab to use in experiments. Techs usually handle preparing the right sorts of materials to grow bacteria (which are used as vectors for DNA; see Chapter 16), setting up the bacterial cultures, and monitoring their growth. Also, techs are usually responsible for keeping all the necessary supplies straight and washing the glassware — not a glamorous job but a necessary one because labs use tons of glass beakers and flasks that have to be cleaned.

When it comes to actual experiments, lab technicians are responsible for separating the DNA from the rest of the tissue around it. They sometimes use prepackaged kits for this task, but some sorts of tissue (like that from

plants and insects) require complex procedures with many chemicals and complicated steps. After the DNA's separated from the cells, the tech tests it for purity (to make sure no contaminants, like proteins, are present). Using a rather complicated machine with a strong laser, the tech can also measure exactly how much DNA is present. When a sufficiently pure sample of DNA is obtained, techs may analyze the DNA in greater detail (with PCR or sequencing reactions).

The educational background needed to be a lab tech varies with the amount of responsibility demanded by a particular position. Most techs have a minimum of a bachelor's degree in biology or some related field and need some background in microbiology to understand and carry out the techniques of handling bacteria safely and without contaminating cultures. And all techs must be good record-keepers because every single activity in the lab is documented in writing in the lab notebook.

Graduate student and post-doc

At most universities, genetics labs are full of *graduate students* who are working on either master's degrees or PhDs. In some labs, these students may be carrying out their own, independent research. On the other hand, many labs focus their work on a specific problem, like some specialized approach to studying cancer, and every student in that sort of lab works on some aspect of what his or her professor studies. Graduate students do a lot of the same things that lab techs do (see the preceding section), plus they design experiments, carry out those experiments, analyze the results, and then work to figure out what the results mean. Then, the graduate student writes a long document (called a thesis or dissertation) to describe what was done, what it means, and how it fits in with other people's research on the subject. While working in the lab, grad students take classes and are subjected to grueling exams (trust me on the grueling part).

All graduate students must hold a bachelor's degree, and, to apply to grad school, must take a standardized test called the GRE (Graduate Record Exam). Performance on this examination determines eligibility for admission to schools and may be used for selection for fellowships and awards. (If you're going to be staring down this test in the near future, you may want to get a leg up by checking out *The GRE Test For Dummies*, by Suzee Vlk [Wiley].) In general, it takes two or three years to earn a master's degree. A doctorate (denoted by PhD) usually requires anywhere from four to seven years of education beyond the bachelor's level.

After graduating with a PhD, a geneticist-in-training may need to get more experience before hitting the job market. Positions that provide such experience are collectively referred to as *post-docs*. A post-doc (that is, a person holding a post-doc position) is usually much more independent when it comes to research than a grad student. The post-doc is often working to learn new techniques or acquire a specialty before moving on to a position as a professor or a research scientist.

Research scientist

Research scientists work in private industry to design experiments and direct the activities of lab techs. All sorts of industries employ research scientists, including:

- ✓ Pharmaceutical companies, to conduct investigations on how drugs affect gene expression (see Chapter 10) and to develop new treatments such as gene therapy (see Chapter 16)
- ✓ Forensics labs, to analyze DNA found at crime scenes and compare DNA fingerprints (see Chapter 18)
- ✓ Companies that analyze information generated by genome projects (human and others; see Chapter 11)
- ✓ Companies that support the work of other genetics labs by designing and marketing products used in research, such as kits used to run DNA fingerprints

A research scientist usually holds a master's degree or a PhD. With only a bachelor's degree, several years of experience as a lab tech may suffice. Research scientists have to be able to design experiments and analyze results using statistics. Good record keeping and strong communication skills (especially in writing) are musts. Most research scientists also have to be capable of managing and supervising people. In addition, financial responsibilities may include keeping up with expenditures, ordering equipment and supplies, and wrangling salaries of other personnel.

College or university professor

Professors do everything that research scientists do with the added responsibilities of teaching courses, writing proposals to get funds to support research, and writing papers for publication of research results. Professors supervise the lab techs, graduate students, and post-docs that work in their labs. Generally, such supervision means designing research projects and then ensuring the projects are done correctly in the right amount of time (and under budget!).

The number of courses a professor is required to teach varies according to the university. Small schools may require a professor to teach as many as three courses every semester. Upper-tier institutions (think Big Ten or Ivy League) may require only one course of instruction per year. (To put this in perspective, genetics courses may have as many as 200 students every semester. Most courses run 12 weeks with three lectures per week — writing an hour-long lecture from scratch takes me six to eight hours. Professors also write and grade exams. For three different courses, multiply the workload by three.) Genetics professors teach the basics as well as very advanced and specialty courses like recombinant DNA (covered in Chapter 16) and population genetics (covered in Chapter 17).

Regardless of the number of courses a professor is required to teach, he or she is usually expected to write proposals to funding agencies to get enough money to pay for research expenses. When funding is obtained, professors team up with lab techs, graduate students, and post-docs to do the work promised in the proposal. Professors are required to publish their research results in reputable, peer-reviewed journals. (*Peer-review* means the work is judged by two or more experts in the field and deemed valid.)

To qualify for a professorship, universities require a minimum of a PhD and most require additional post-doctoral experience. Job candidates must have already published research results to demonstrate the ability to do relevant research. Most universities also look for evidence that the candidate will be successful at getting grants — that means the candidate must usually get a grant before getting a job.

Genetic counselor

Genetic counselors work with medical personnel to interpret the medical histories of patients and their families. The counselor usually works directly with the patient to assemble all the information into a family tree (see Chapter 12). Then the counselor looks for patterns to determine which traits may be hereditary. Counselors can also tell which diseases are likely to be inherited more than others. Genetic counselors are trained to conduct careful and thorough interviews to make sure that no information is missed or left out.

Genetic counselors usually hold a master's degree. Training includes many hours working with patients to hone interview and analysis skills (under the close supervision of experienced professionals, of course). The position requires excellent record-keeping skills and strict attention to detail. Genetic counselors also have to be good at interacting with all kinds of people, including research scientists and physicians. And the ability to communicate very well, both in writing and verbally, is a must.

The most essential skill of a genetic counselor is the ability to be non-judgmental and non-directive. The counselor must be able to analyze a family history without bias or prejudice and inform the patient of his or her options without recommending any one course of action over another. Furthermore, the counselor must keep all information about his or her patients confidential, sharing information only with authorized personnel such as the person's own physician, to protect the patient's privacy.

Chapter 2

Celling Out: Basic Cell Biology

In This Chapter

- ▶ Wandering around the cell
 - ▶ Exploring chromosomes
 - ▶ Understanding simple cell division
 - ▶ Appreciating the complex process of meiosis
-

The study of genetics and the study of how cells work are closely related. The process of passing genetic material from one generation to the next depends completely on how cells grow and divide. To reproduce, a simple organism such as bacteria or yeast simply copies its DNA (through a process called *replication*, which I cover in Chapter 6) and splits in two. But organisms that reproduce sexually go through a complicated dance that includes mixing and matching strands of DNA (a process called *recombination*) and then reducing the amount of DNA in special sex cells to arrive at completely new genetic combinations for their offspring. These amazing processes are part of what makes you unique. So, come inside your cell — you need to be familiar with the processes of *mitosis* (cell division) and *meiosis* (the production of sex cells) to appreciate how genetics works.

Welcome to Your Cell!



There are two basic kinds of organisms:

- ✓ **Prokaryotes:** Organisms whose cells lack a nucleus and therefore have DNA floating loosely in the liquid center of the cell
- ✓ **Eukaryotes:** Organisms that have a well-defined nucleus to house and protect the DNA

A *nucleus* is a compartment filled with DNA surrounded by a membrane called a *nuclear envelope*.

The basic biologies of the two kinds of organisms are similar but not identical. Because all living things fall into these two groups, understanding the differences and similarities between cell types is important. In this section, I show you how to distinguish the two kinds of cells from each other, and you get a quick tour of the insides of cells — both with and without nuclei. Figure 2-1 shows you the structure of each type of cell.

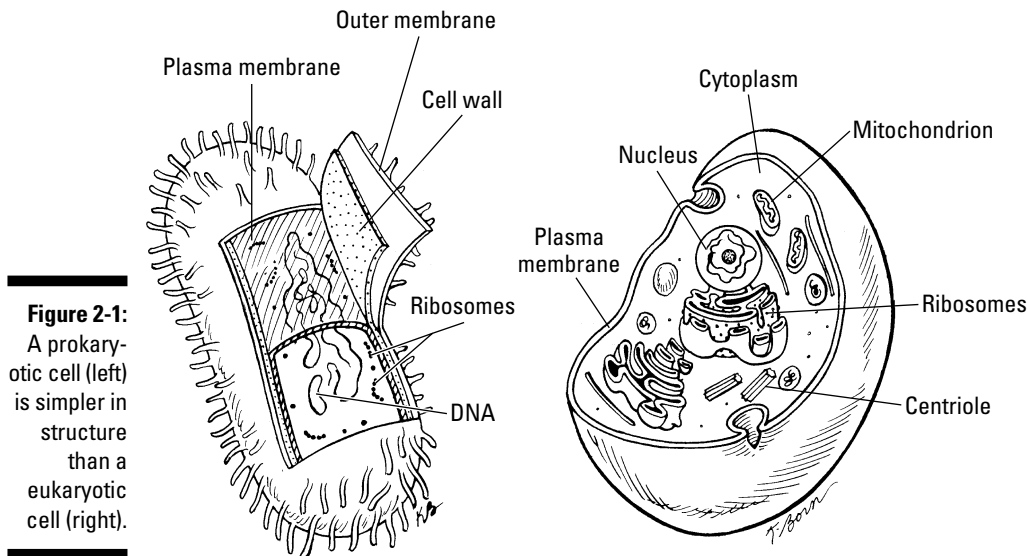

Figure 2-1: A prokaryotic cell (left) is simpler in structure than a eukaryotic cell (right).

Cells without a nucleus

Organisms composed of cells without nuclei are classified as *prokaryotes*, which means “before nucleus.” Prokaryotes are the most common forms of life on earth. You are, at this very moment, covered in and inhabited by millions of prokaryotic cells: bacteria. Much of your life and your body’s processes depend on these arrangements; for example, the digestion going on in your intestines is partially powered by bacteria that break down the food you eat. Most of the bacteria in your body are completely harmless to you. Other species of bacteria, however, can be vicious and deadly, causing rapidly transmitted diseases such as cholera.

All bacteria, regardless of temperament, are simple, one-celled prokaryotic organisms. None have cell nuclei, and all are small cells with relatively small amounts of DNA (see Chapter 11 for more on the amounts of DNA different organisms possess).

The exterior of a prokaryotic cell is encapsulated by a *cell wall* that serves as the bacteria's only protection from the outside world. A *plasma membrane* (*membranes* are thin sheets or layers) regulates the exchange of nutrients, water, and gases that nourish the bacterial cell. DNA, usually in the form of a single hoop-shaped piece (segments of DNA like this one are called *chromosomes*; see the section "Examining the basics of chromosomes" later in the chapter), floats around inside the cell. The liquid interior of the cell is called the *cytoplasm*. The cytoplasm provides a cushiony, watery home for the DNA and other cell machinery that carries out the business of living. Prokaryotes divide, and thus reproduce, by simple mitosis, which is covered in detail in "Mitosis: We Gotta Split, Baby!"

Cells with a nucleus

Organisms that have cells with nuclei are classified as *eukaryotes* (meaning "true nucleus"). Eukaryotes range in complexity from simple one-celled animals and plants all the way to complex multicellular organisms like you. Eukaryotic cells are fairly complicated and have numerous parts to keep track of (see Figure 2-1). Like prokaryotes, eukaryotic cells are held together by a *plasma membrane*, and sometimes a *cell wall* surrounds the membrane (plants, for example have cell walls). But that's where the similarities end.



The most important feature of the eukaryotic cell is the *nucleus* — the membrane-surrounded compartment that houses the DNA that's divided into one or more chromosomes. The nucleus protects the DNA from damage during day-to-day living. Eukaryotic chromosomes are usually long, string-like segments of DNA instead of the hoop-shaped ones found in prokaryotes. Another hallmark of eukaryotes is the way the DNA is packaged: Eukaryotes usually have much larger amounts of DNA than prokaryotes, so to fit all that DNA into the tiny cell nucleus, it must be tightly wound around special proteins. (For all the details about DNA packaging for eukaryotes, you can flip ahead to Chapter 6.)

Unlike prokaryotes, eukaryotes have all sorts of cell parts, called *organelles*, that help carry out the business of living. The organelles are found floating around in the watery cytoplasm outside the nucleus. Two of the most important organelles are:

- ✓ **Mitochondria:** The powerhouses of the eukaryotic cell, mitochondria pump out energy by converting glucose to ATP (adenosine triphosphate). ATP acts like a battery of sorts, storing energy until it's needed for day-to-day living. Both animals and plants have mitochondria.
- ✓ **Chloroplasts:** These organelles are unique to plants. They process the energy of sunlight into sugars that then are used by plant mitochondria to generate the energy that nourishes the living cells.

Eukaryotic cells are able to carry out behaviors that prokaryotes can't. For example, one-celled eukaryotes often have appendages, such as long tails (called *flagella*) or hair-like projections (called *cilia*) that work like hundreds of tiny paddles, to help them move around. Also, only eukaryotic cells are capable of ingesting fluids and particles for nutrition; prokaryotes must transport materials through their cell walls, a process that severely limits their culinary options.

In most multicellular eukaryotes, cells come in two basic varieties: body cells (called *somatic* cells) or sex cells. The two cell types have very different functions and are produced in very different ways.

Somatic cells

Somatic cells are produced by simple cell division called *mitosis* (see the section “Mitosis: We Gotta Split, Baby!” for details). Somatic cells of multicellular organisms like you are differentiated into special cell types. Skin cells and muscle cells are both somatic cells, for instance, but if you were to examine your skin cells under a microscope and compare them with your muscle cells, you'd see their structures are very different. The various cells that make up your body all have the same basic components (membrane, organelles, and so on), but the arrangements of the elements change from one cell type to the next so that they can carry out various jobs such as digestion (intestinal cells), energy storage (fat cells), or oxygen transport to your tissues (blood cells).

Sex cells

Sex cells are specialized cells that are used for reproduction. Only eukaryotic organisms engage in sexual reproduction, which is covered in detail at the end of this chapter in the section “Mommy, where did I come from?”. *Sexual reproduction* combines genetic material from two organisms and requires special preparation in the form of a reduction in the amount of genetic material allocated to sex cells — a process called *meiosis* (see “Meiosis: Making Cells for Sex” in this chapter for an explanation). In humans, the two types of sex cells are eggs and sperm.

Examining the basics of chromosomes

Chromosomes are threadlike strands that are composed of DNA. To pass genetic traits from one generation to the next, the chromosomes must be copied (see Chapter 6), and then the copies must be divvied up. Most prokaryotes have only one circular chromosome that, when copied, is passed on to the *daughter cells* (new cells created by cell division) during mitosis. Eukaryotes have more complex problems to solve (like divvying up half of the chromosomes to make sex cells), and their chromosomes behave differently during mitosis and meiosis. Additionally, there are various terms to describe the anatomy, shapes, the number of copies, and situations that eukaryotic chromosomes find themselves in. This section gets into the intricacies of chromosomes in the eukaryotic cells, because they're so complex.

Counting out chromosome numbers

Each eukaryotic organism has a very specific number of chromosomes per cell — ranging from one to many. For example, humans have 46 total chromosomes. These chromosomes come in two varieties:

- ✓ **Sex chromosomes:** These chromosomes determine gender. Human cells contain two sex chromosomes. If you're female, you have two X chromosomes, and if you're male, you have an X and a Y chromosome. (To find out more about how sex is determined by the X and Y chromosomes, flip ahead to Chapter 5.)
- ✓ **Autosomal chromosomes:** *Autosomal* simply refers to non-sex chromosomes. So, sticking with the human example, do the math, and you can see that humans have 44 autosomal chromosomes.

Ah, but there's more. In humans, chromosomes come in pairs. That means you have 22 pairs of uniquely shaped autosomal chromosomes plus 1 pair of sex chromosomes, for a total of 23 chromosome pairs. Your autosomal chromosomes are identified by numbers — 1 through 22. So, you have two chromosome 1s, two 2s, and so on. Figure 2-2 shows you how all human chromosomes are divided into pairs and numbered.

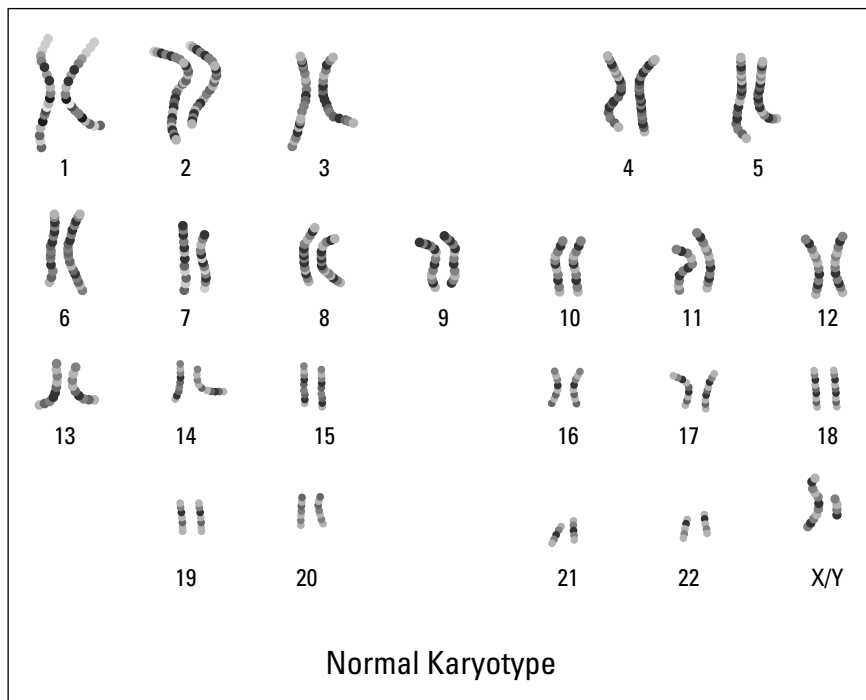

Figure 2-2:
The
46 human
chromo-
somes are
divided into
23 pairs.

When chromosomes are divided into pairs, the individual chromosomes in each pair are considered *homologous*, meaning that the paired chromosomes are identical to one another in shape and size. For example, your two single chromosome 2s are paired up because they're identical in shape and size. These homologous chromosomes are sometimes referred to as *homologs* for short.

Chromosome numbers can get a bit confusing. Humans are *diploid*, meaning we have two copies of each chromosome. Some organisms (like bees and wasps) have only one set of chromosomes (cells with one set of chromosomes are referred to as *haploid*); others have three, four, or as many as sixteen copies of each chromosome! The number of chromosome sets held by a particular organism is called the *ploidy*. For more on chromosome numbers, see Chapter 15.

The total number of chromosomes doesn't tell you what the ploidy of an organism is. For that reason, the number of chromosomes an organism has is often listed as some multiple of n . Thus, humans are $2n = 46$ (indicating that humans are diploid and the total number of chromosomes is 46). A single set of chromosomes referred to by the n is the haploid number. Human sex cells such as eggs or sperm are haploid (see "Mommy, where did I come from?" later in this chapter).



The homologous pairs of chromosomes in humans are thought to have started as one set (that is, *haploid*), with the entire set being duplicated at some point in some distant ancestor, many millions of years ago.

Examining chromosome anatomy

Chromosomes are often depicted in stick-like forms, which you can see in Figure 2-3. Chromosomes don't look like sticks, though. In fact, most of the time they're loose and string-like. Chromosomes only take on this distinctive shape and form when cell division is about to take place (during metaphase either through meiosis or mitosis). They're often drawn in this very distinctive shape and form because the special characteristics of eukaryotic chromosomes are easier to see. Figure 2-3 points out the important features of eukaryotic chromosomes.

The part of the chromosome that appears pinched together (located, in the figure, in the middle of the chromosome) is called the *centromere*. The placement of the centromere (whether it's closer to the top, middle, or bottom of the chromosome) is what gives each chromosome its unique shape (see Figure 2-4). The ends of the chromosomes are called *telomeres*. Telomeres are made of densely packed DNA and serve to protect the DNA message carried by the chromosome. (Flip ahead to Chapter 11 to find more about telomeres and how they may affect the process of aging.)

Figure 2-3:
Basic structure of eukaryotic chromosomes.

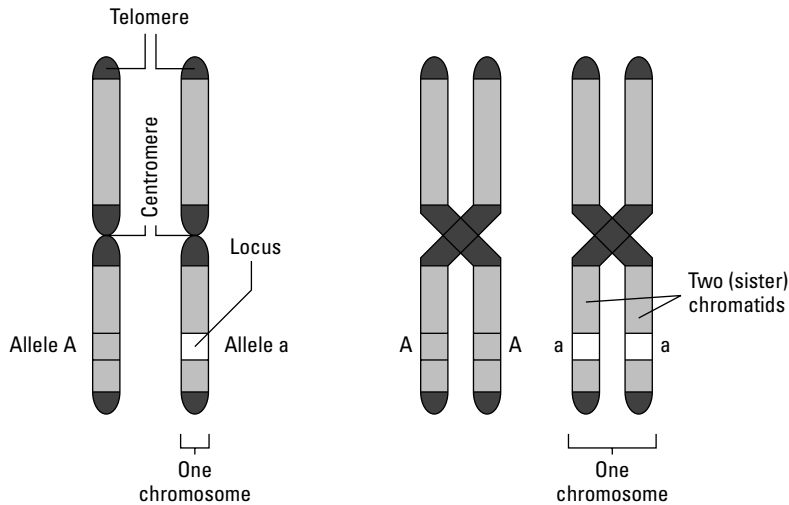

The differences in shapes and sizes of chromosomes are easy to see, but the most important differences between chromosomes are hidden deep inside the DNA. Chromosomes carry *genes*. *Genes* are sections of DNA that make up the building plans for physical traits. The genes tell the body how, when, and where to make all the structures that are necessary for the processes of living (for more on how genes work, flip ahead to Chapter 10). Each pair of homologous chromosomes carries the same — but not necessarily identical — genes. For example, both chromosomes of a particular homologous pair might contain the gene for hair color, but one can be a “brown hair” version of the gene — alternative versions of genes are called *alleles* (see Figure 2-3) — and the other can be a “blond hair” allele.

Figure 2-4:
Chromosomes are classified based on the locations of their centromeres.

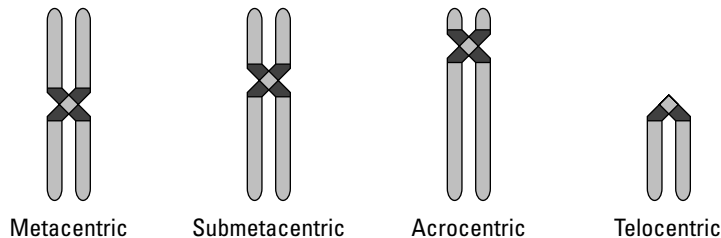

Any given gene can have one or more alleles. In Figure 2-3, one chromosome carries the allele *A* while its homolog carries the allele *a* (the relative size of an allele is normally very small; the alleles are large here so you can see them). The alleles code for the different physical traits (*phenotypes*) you see in animals and plants like hair color or flower shape. You can find out more about how alleles affect phenotype in Chapter 3.

Each point along the chromosome is called a *locus* (Latin for “place”). The plural of locus is *loci* (pronounced *low-sigh*). Most of the phenotypes that you see are produced by multiple genes (that is, genes occurring at different loci and often on different chromosomes) acting together. For instance, human eye color is determined by at least three different genes that reside on two different chromosomes. You can find out more about how genes are arranged along chromosomes in Chapter 15.

Mitosis: We Gotta Split, Baby!

Most cells have simple lifestyles: They grow, divide, and eventually die. Figure 2-5 illustrates the basic life cycle of a typical somatic (or body) cell.

The *cell cycle* (the stages a cell goes through from one division to another) is tightly regulated; some cells divide all the time, and others never divide at all. Your body uses mitosis to provide new cells when you grow and to replace cells that wear out or become damaged from injury. Talk about multitasking — you’re going through mitosis right now, while you read this book! Some cells divide only part of the time, when new cells are needed to handle certain jobs like fighting infection. Cancer cells, on the other hand, get carried away and divide too often. (In Chapter 14, you can find out how the cell cycle is regulated and what happens when it goes awry.)



The cell cycle includes *mitosis* — the process of reproducing the cell nucleus by division. The end result of each round of the cell cycle is a simple cell division that creates two new cells from one original cell. During mitosis, all DNA present in the cell is copied (see Chapter 7), and when the original cell divides, a complete collection of all the chromosomes (in humans, 23 pairs) goes to each of the two resulting cells. Prokaryotes and some simple eukaryotic organisms use mitosis to reproduce themselves. (More complex eukaryotic organisms use meiosis for sexual reproduction, in which each of the two sex cells sends only one copy of each chromosome into the eggs or sperm. You can read all about that in the section “Meiosis: Making Cells for Sex,” later in this chapter.)

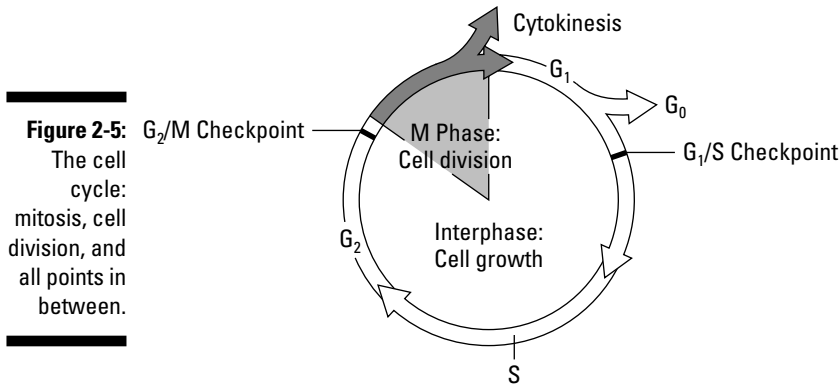

There are two important points to remember about mitosis:

- ✓ **Mitosis produces two identical cells.** The new cells are identical to each other *and* to the cell that divided to create them.
- ✓ **Cells created by mitosis have exactly the same number of chromosomes as the original cell did.** If the original cell had 46 chromosomes, the new cells each have 46 chromosomes.

Mitosis is only one of the major phases in the cell cycle; the other is *interphase*. In the following sections, I guide you through the phases of the cell cycle and tell you exactly what happens during each one.

Step 1: Time to grow

Interphase is the part of the cell cycle during which the cell grows, copies its DNA, and prepares to divide. Interphase is usually divided into three stages: the G₁ phase, the S phase, and the G₂ phase.

G₁ phase

When a cell begins life, such as the moment an egg is fertilized, the first thing that happens is the original cell starts to grow. This period of growth is called the G₁ phase of interphase. Lots of things happen during G₁: DNA supervises the work of the cell, *metabolism* (the exchange of oxygen and carbon dioxide) occurs, and cells breathe and “eat.”

Some cells opt out of the cell cycle, stop growing, and remain in G1 permanently. Your brain cells, for example, have retired from the cell cycle. Red blood cells and muscle cells don't divide, either. In fact, human red blood cells have no nuclei and thus possess no DNA of their own.

If the cell in question plans to divide, though, it can't stay in G1 forever. Actively dividing cells go through the whole cell cycle every 24 hours or so. After a predetermined period of growth that lasts from a few minutes to several hours, the cell arrives at the first checkpoint (see Figure 2-5). When the cell passes the first checkpoint, there's no turning back — it's a one-way trip to splitsville.



Various proteins control when the cell moves from one phase of the cycle to the next. At the first checkpoint, proteins called *cyclins* and enzymes called *kinases* control the border between G1 and the next phase. Cyclins and kinases interact to cue up the various stages of the merry-go-round of cell division. Two particular chemicals, CDK (cyclin dependent kinase) and G1 cyclin, hook up to escort the cell over the border from G1 to S — the next phase.

S phase

S phase is the point at which the cell's DNA is replicated. When the cell enters the S phase, activity around the chromosomes really steps up. All the chromosomes must be copied to make exact replicas that later are passed on to the newly formed daughter cells produced by cell division. DNA replication is a very complex process that gets full coverage in Chapter 7.



For now, all you need to know is that all the cell's chromosomes are copied during S, and the copies stay together as a unit (joined at the centromere; see Figure 2-3) when the cell moves from S into G2 — the final step in interphase. The replicated chromosomes are called *sister chromatids* (see Figure 2-3). Sister chromatids are alike in every way. They carry the exact same copies of the exact same genes. During mitosis (or meiosis), the sister chromatids are divided up and sent to the daughter cells as part of the cell cycle.

G2 phase

The *G2 phase* leads up to cell division. It's the last phase before actual mitosis gets underway. G2, also sometimes called *Gap 2*, gives the cell time to get bigger before splitting into two smaller cells. Another set of cyclins and CDK work together to push the cell through the second checkpoint located at the border between G2 and mitosis. (For details on the first checkpoint, jump back to the section "G1 phase.") As the cell grows, the chromosomes, now copied and hooked together as sister chromatids, stay together inside the cell nucleus. (The DNA is still "relaxed" at this point and hasn't yet taken on the fat, sausage-shaped appearance it assumes during mitosis.) After the cell crosses the G2/M checkpoint (see Figure 2-5), the business of mitosis formally gets underway.

Step 2: Divvying up the chromosomes

In the cell cycle, *mitosis* is the process of dividing up the newly copied chromosomes (that were created in interphase; see the preceding section) to make certain that the new cells each get a full set. Generally, mitosis is divided into four phases, which you can see in Figure 2-6 and read about in the following sections.

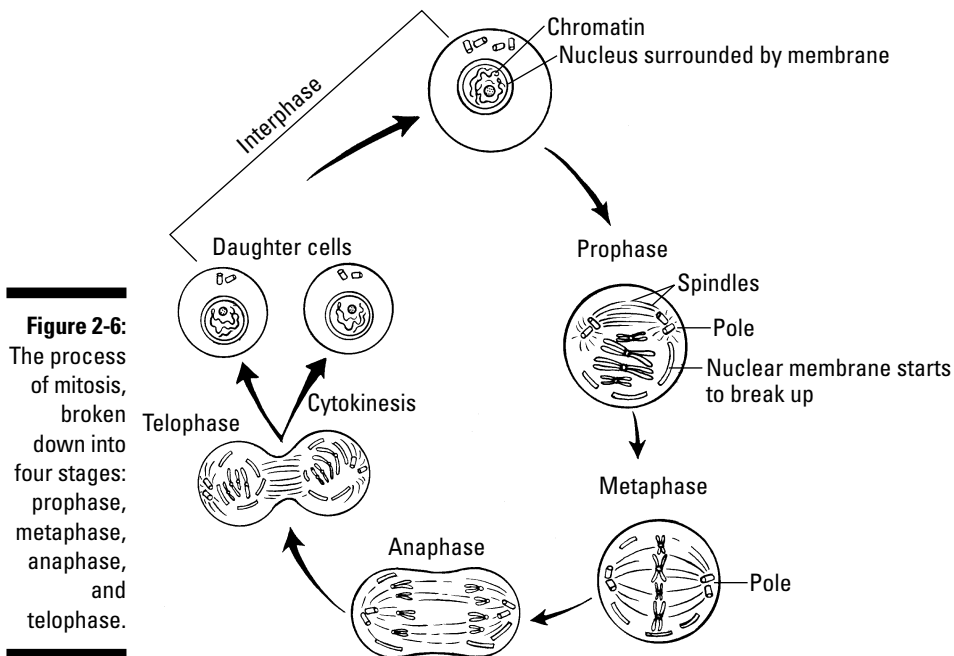

Figure 2-6: The process of mitosis, broken down into four stages: prophase, metaphase, anaphase, and telophase.



The phases of mitosis are a bit artificial because the movement doesn't stop at each point; instead, the chromosomes cruise right from one phase to the next. But dividing the process into phases is useful for understanding how the chromosomes go from being all mixed together to neatly parting ways and getting into the proper newly formed cells.

Prophase

During *prophase*, the chromosomes get very compact and condensed, taking on the familiar sausage shape. During interphase (see the “Step 1: Time to grow” section earlier in this chapter), the DNA that makes up the chromosomes is tightly wound around special proteins, sort of like string wrapped around beads. The whole “necklace” is wound tightly on itself to compress

the enormous DNA molecules to sizes small enough to fit inside the cell nucleus. But even when coiled during interphase, the chromosomes are still so threadlike and tiny that they're essentially invisible. That changes during prophase, when the chromosomes become so densely packed that they're easily seen with an ordinary light microscope.



At this time, chromosomes are duplicated to form sister chromatids (see Figure 2-3). Sister chromatids of each chromosome are exact, twin copies of each other. Each chromatid is actually a chromosome in its own right, but thinking of chromosomes as chromatids may help you keep all the players straight during the process of division.

As the chromosomes/chromatids condense, the cell nucleus starts breaking up, allowing the chromosomes to move freely across the cell as the process of cell division progresses.

Metaphase

Metaphase is the point when the chromosomes all line up in the center of the cell. After the nuclear membrane dissolves and prophase is complete, the chromosomes go from being a tangled mass to lining up in a more or less neat row in the center of the cell (see Figure 2-6). Threadlike strands called *spindles* grab each chromosome around its waist-like centromere. The spindles are attached to points on either side of the cell called *poles*.



Sometimes scientists use geographic terms to describe the positions of chromosomes during metaphase: The chromosomes line up at the equator and are attached to the poles. This trick may help you better visualize the events of metaphase.

Anaphase

During *anaphase*, the sister chromatids are pulled apart, and the resulting halves migrate to opposite poles (see Figure 2-6). At this point, it's easy to see that the chromatids are actually chromosomes. Every sister chromatid gets split apart so that the cell that's about to be formed ends up with a full set of all the original cell's chromosomes.

Telophase

Finally, during *telophase*, nuclear membranes begin to form around the two sets of separated chromosomes (see Figure 2-6). The chromosomes begin to relax and take on their usual interphase form. The cell itself begins to divide as telophase comes to an end.

Step 3: Splitsville

When mitosis is complete and new nuclei have formed, the cell divides into two smaller, identical cells. The division of one cell into two is called *cytokinesis* (*cyto* meaning cell and *kinesis* meaning movement). Technically, cytokinesis happens after metaphase is over and before interphase begins. Each new cell has a full set of chromosomes, just as the original cell did. All the organelles and cytoplasm present in the original cell are divided up to provide the new cell with all the machinery it needs for metabolism and growth. The new cells are now at interphase (specifically, the G1 stage) and are ready to begin the cell cycle again.

Meiosis: Making Cells for Sex

Meiosis is a cell division that includes reducing the chromosome number as preparation for sexual reproduction. Meiosis reduces the amount of DNA by half so that when fertilization occurs, each offspring gets a full set of chromosomes. As a result of meiosis, the cell goes from being diploid to being haploid. Or to put it another way, the cell goes from being $2n$ to being n . In humans, this means that the cells produced by meiosis (either eggs or sperm) have 23 chromosomes each — one copy of each of the homologous chromosomes. (See the section “Counting out chromosome numbers” earlier in this chapter for more information.)



Meiosis has many characteristics in common with mitosis. The stages go by similar names, and the chromosomes move around similarly, but the products of meiosis are completely different from those of mitosis. Whereas mitosis ends with two exactly identical cells, meiosis produces four cells each with exactly *half* the amount of DNA that the original cell contained. Furthermore, with meiosis, the homologous chromosomes go through a complex exchange of parts called *recombination*. Recombination is one of the most important aspects of meiosis and leads to genetic variation that allows each individual produced by sexual reproduction to be truly unique.

Meiosis goes through two rounds of division: meiosis I and the sequel, meiosis II. Figure 2-7 shows the progressing stages of both meiosis I and meiosis II. Unlike lots of movie sequels, the sequel in meiosis is really necessary. In both rounds of division, the chromosomes go through stages of division that resemble those in mitosis. However, the chromosomes undergo different actions in meiotic prophase, metaphase, anaphase, and telophase.

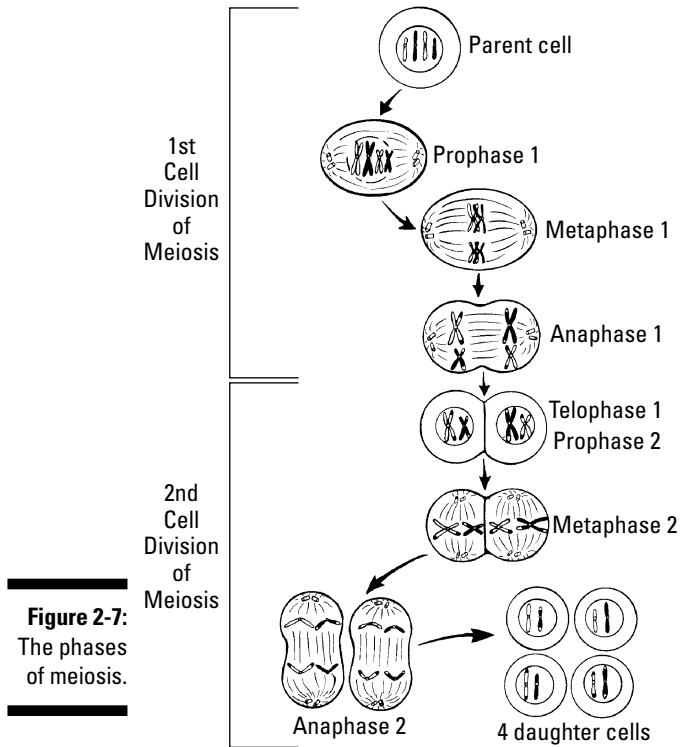

Figure 2-7:
The phases of meiosis.



In my experience, students often get stuck on the phases of meiosis and miss the most important parts of meiosis: recombination and the division of the chromosomes. To prevent that sort of confusion, I don't break down meiosis by phases. Instead, I focus on the activities of the chromosomes themselves.

In meiosis I:

- ✓ The homologous pairs of chromosomes line up side by side and exchange parts. This is called *crossing-over* or *recombination*, and it occurs during prophase I.
- ✓ During metaphase I, the homologous chromosomes line up at the equator of the cell (called the *metaphase plate*), and homologs go to opposite poles during the first round of anaphase.
- ✓ The cell divides in telophase I, reducing the amount of genetic material by half, and enters a second round of division — meiosis II.

During meiosis II:

- ✔ The individual chromosomes (as sister chromatids) condense during prophase II and line up at the metaphase plates of both cells (metaphase II).
- ✔ The chromatids separate and go to opposite poles (anaphase II).
- ✔ The cells divide, resulting in a total of *four* daughter cells each possessing *one* copy of each chromosome.

Meiosis Part I

Cells that undergo meiosis start in a phase similar to the interphase that precedes mitosis. The cells grow in a G1 phase, undergo DNA replication during S, and prepare for division during G2. (To review what happens in each of these phases, flip back to the section “Step 1: Time to grow.”) When meiosis is about to begin, the chromosomes condense. By the time meiotic interphase is complete, the chromosomes have been copied and are hitched up as sister chromatids, just as they would be in mitosis. Next up are the phases of meiosis I, which I profile in the sections that follow.

Find your partner

During prophase I (labeled “I” because it’s in the first round of meiosis), the homologous chromosomes find each other. These homologous chromosomes originally came from the mother and father of the individual whose cells are now undergoing meiosis. Thus, during meiosis, maternal and paternal chromosomes, as homologs, line up side by side. In Figure 2-2, you can see an entire set of 46 human chromosomes. Although the members of the pair seem identical, they’re not. The homologous chromosomes have different combinations of alleles at the thousands of loci along each chromosome. (For more on alleles, jump to the section “Chromosome anatomy,” earlier in this chapter.)

Recombining makes you unique

When the homologous chromosomes pair up in prophase I, the chromatids of the two homologs actually zip together, and the chromatids exchange parts of their arms. Enzymes cut the chromosomes into pieces and seal the newly combined strands back together in an action called *crossing-over*. When crossing-over is complete, the chromatids consist of part of their original DNA and part of their homolog’s DNA. The loci don’t get mixed up or turned around — the chromosome sequence stays in its original order. The only thing that’s different is that the maternal and paternal chromosomes (as homologs) are now mixed together.

Figure 2-8 illustrates crossing-over in action. The figure shows one pair of homologous chromosomes and two loci. At both loci, the chromosomes have alternative forms of the genes — in other words, the alleles are different: Homolog one has *A* and *b*, and homolog two has *a* and *B*. When replication takes place, the sister chromatids are identical (because they're exact copies of each other). After crossing-over, the two sister chromatids have exchanged arms. Thus, each homolog has a sister chromatid that's different.

Partners divide

The recombined homologs line up at the metaphase equator of the cell (see Figure 2-7). The nuclear membrane begins to break down, and in a process similar to mitotic anaphase, spindle fibers grasp the homologous chromosomes by their centromeres and pull them to opposite sides of the cell.

At the end of the first phase of meiosis, the cell undergoes its first round of division (telophase 1, followed by cytokinesis 1). The newly divided cells each contain one set of chromosomes, the now partnerless homologs, still in the form of replicated sister chromatids.



When the homologs line up, maternal and paternal chromosomes pair up, but it's a tossup as to which side of the equator each one ends up on. Therefore, each pair of homologs divides independently of every other homologous pair. This is the basis of the principle of independent assortment, which I cover in Chapters 3 and 4.

Following telophase I, the cells enter an in-between round called *interkinesis* (which means “between movements”). The chromosomes relax and lose their fat, ready-for-metaphase appearances. Interkinesis is just a “resting” phase in preparation for the second round of meiosis.

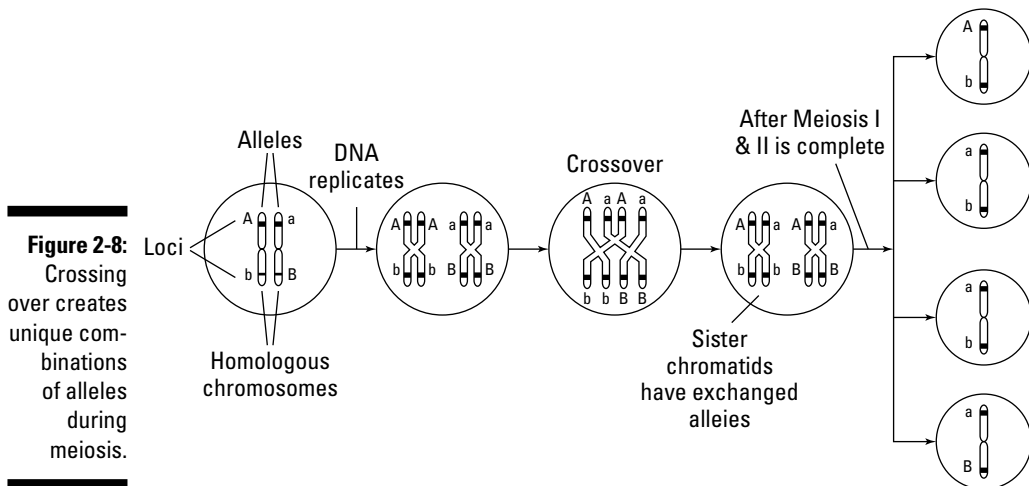

Meiosis Part II

Meiosis II is the second phase of cell division that produces the final product of meiosis: cells each containing only one copy of each chromosome. The chromosomes condense once more to their now-familiar fat, sausage shapes. Keep in mind that each cell has only a single set of chromosomes, which are still in the form of sister chromatids.

During metaphase II, the chromosomes line up along the equator of the cells, and spindle fibers attach at the centromeres. In anaphase II, the sister chromatids are pulled apart and move to opposite poles of their respective cell. The nuclear membranes form around the now single chromosomes (telophase II). Finally, cell division takes place. At the end of the process, each of the four cells contains one single set of chromosomes.

Mommy, where did I come from?

From gametogenesis, honey. Meiosis in humans (and all animals that reproduce sexually) produces cells called *gametes*. Gametes come in the form of sperm (produced by males) or eggs (produced by females). When conditions are right, sperm and egg unite to create a new organism, which takes the form of a *zygote*. Figure 2-9 shows the process of *gametogenesis* (the production of gametes) in humans.

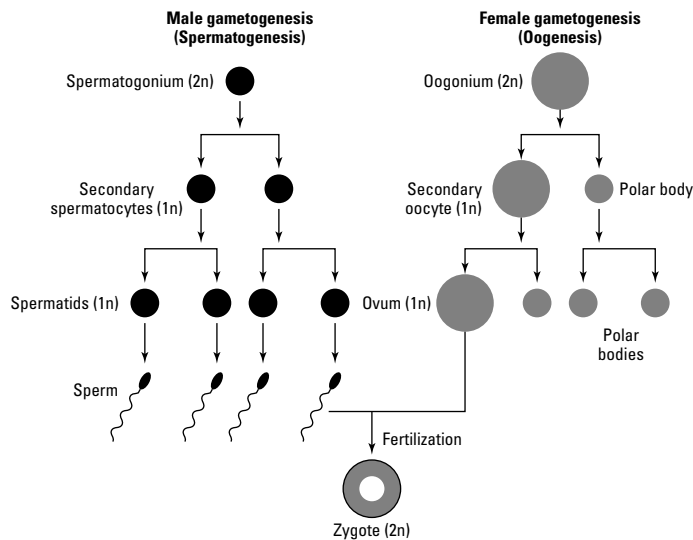

Figure 2-9:
Gameto-
genesis in
humans.

For human males, special cells in the male's sexual organs (testes) produce *spermatogonia*. Spermatogonia are $2n$ — they contain a full diploid set of 46 chromosomes (see the earlier section “Counting out chromosome numbers”). After meiosis I, each single spermatogonia has divided into two cells called *secondary spermatocytes*. These spermatocytes contain only one copy of each homolog (as sister chromatids). After one more division (meiosis II), the spermatids that become sperm cells have one copy of each chromosome. Thus, sperm cells are haploid and contain 23 chromosomes. Because males have X and Y sex chromosomes, half their sperm (men produce literally millions) contain Xs and half contain Ys.

Human females produce eggs in much the same way that men produce sperm. Egg cells, which are produced by the ovaries, start as diploid *oogonia* (that is, $2n = 46$). The big difference between egg and sperm production is that at the end of meiosis II, only one mature, haploid (23 chromosomes) sex cell (as an egg) is produced instead of four (see Figure 2-9). The other three cells produced are called *polar bodies*; the polar bodies aren't actual egg cells and can't be fertilized to produce offspring.



Why does the female body produce one egg cell and three polar bodies? Egg cells need large amounts of cytoplasm to nourish the zygote in the period between fertilization and when the mother starts providing the growing embryo with nutrients and energy through the placenta. The easiest way to get enough cytoplasm into the egg when it needs it most is to put less cytoplasm into the other three cells produced in meiosis II.

Chapter 3

Mendel's Peas Plan: Discovering the Laws of Inheritance

In This Chapter

- ▶ Gardening with Gregor Mendel
 - ▶ Segregating alleles to determine inheritance
 - ▶ Solving basic genetics problems using probability
-

Look at the leaves of a tree or the color of your own eyes. How tall are you? What color is your dog or cat's fur? Can you curl or fold your tongue? Got hair on the backs of your fingers? All the physical traits of any living thing originate in that organism's genes. Even if you don't know much about how genes work or even what genes actually are, you've probably already thought about how physical traits can be inherited. Just think of the first thing practically everyone says when they see a newborn baby: Who does he or she look most like, mama or daddy?

The *laws of inheritance* — how traits are transmitted from one generation to the next (including dominant-recessive inheritance, segregation of traits into gametes, and independent assortment of traits) — were discovered only a century or so ago. In the early 1850s, Gregor Mendel, an Austrian monk who dug gardening, looked at the physical world around him and, by simply growing peas in his garden, categorized the patterns of genetic inheritance that are still recognized today. In this chapter, you discover how Mendel's peas plan changed the way scientists view the world. If you skipped Chapter 2, don't worry — Mendel didn't know anything about mitosis or meiosis when he formulated the laws of inheritance.

Mendel's discoveries have an enormous impact on your life. If you're interested in how genetics affects your health (Part III), reading this chapter and getting a handle on the laws of inheritance will help you.

Flower Power: Gardening with Gregor Mendel

For centuries before Mendel planted his first pea plant, scholars and scientists argued about how inheritance of physical traits worked. It was obvious that *something* was passed from parent to offspring because diseases and personality traits seemed to run in families. And farmers knew that by breeding plants and animals with certain physical features that they valued, they could create varieties that produced desirable products, like tastier apples, more wool, or fatter cows. But just how inheritance worked and exactly what was passed from parent to child remained a mystery.

Enter the star of our gardening show, Gregor Mendel. Mendel was, by nature, a curious person. As he wandered around the gardens of the monastery where he lived in the mid-19th century, he noticed that his pea plants looked different from one another in a number of ways. Some were tall and others short. Some had green seeds, and others had yellow seeds. Mendel wondered what caused the differences he observed and decided to conduct a series of simple experiments. He chose seven characteristics of pea plants for his experiments, as you can see in Table 3-1:

Table 3-1 Seven Traits of Pea Plants Studied by Gregor Mendel

<i>Trait</i>	<i>Dominant Form</i>	<i>Recessive Form</i>
Seed color	Yellow	Green
Seed shape	Round	Wrinkled
Seed coat color	Gray	White
Pod color	Green	Yellow
Pod shape	Inflated	Constricted
Plant height	Tall	Short
Flower position	Along the stem	At the tip of the stem

For ten years, Mendel patiently grew many varieties of peas with various flower colors, seed shapes, seed numbers, and so on. In a process called *crossing*, he mated parent plants to see what their offspring would look like. When he passed away in 1884, Mendel was unaware of the magnitude of his contribution to science. A full 34 years passed after publication of his work (in 1868) before anyone realized what this simple gardener had discovered. (For the full story on how Mendel's research was lost and found again, flip to Chapter 22.)

If you don't know much about plants, understanding how plants reproduce may help you appreciate what Mendel did. To mate plants, you need flowers and the dusty substance they produce called *pollen* (the plant equivalent of sperm). Flowers have structures called *ovaries* (see Figure 3-1); the ovaries are hidden inside the *pistil* and are connected to the outside world by the *stigma*. Pollen is produced by structures called *stamen*. Like animals, the ovaries of plants also produce eggs that, when exposed to pollen (*pollination*), are fertilized to produce seeds. Under the right conditions, the seeds sprout to become plants in their own right. The plants growing from seeds are the offspring of the plant(s) that produced the eggs and the pollen. Fertilization can happen in one of two ways:

- ✓ **Out-crossing:** Two plants can be crossed. The pollen from one can be used to fertilize the eggs of another.
- ✓ **Self-pollination:** Some flowers produce both flowers and pollen, in which case the flower may fertilize its own eggs in a process called *selfing* or *self-pollination*. Not all plants can self-fertilize, but Mendel's peas could.

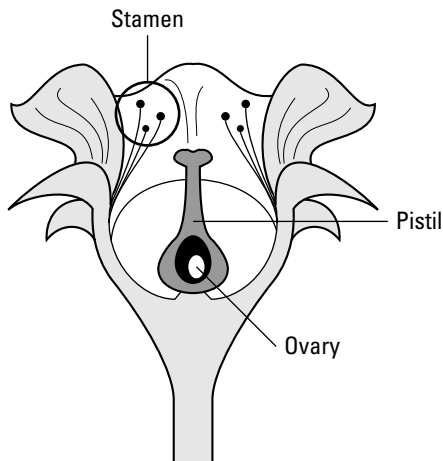

Figure 3-1:
Reproductive parts of
a flower.

Getting the Lowdown on Inheritance Lingo

You probably already know that genes are passed from parent to offspring and that somehow, genes are responsible for the physical traits (*phenotype*, such as eye color) you observe in yourself and the people and organisms around you. (For more on how genes do their jobs, you can flip ahead to Chapter 10.) The simplest possible definition of a *gene* is an inherited factor that determines some trait.



Genes come in different forms, called *alleles*. An individual's alleles determine the phenotype observed. The combinations of alleles of all the various genes that you possess make up your *genotype*. Genes occupy *loci*, specific locations along the strands of your DNA (*locus* is the singular form). Different traits (like eye color versus hair color) are determined by genes that occupy different loci, often on different chromosomes (see Chapter 2 for the basics of chromosomes). Take a look at Figure 3-2 to see how alleles are arranged in various loci along two pairs of generic chromosomes.

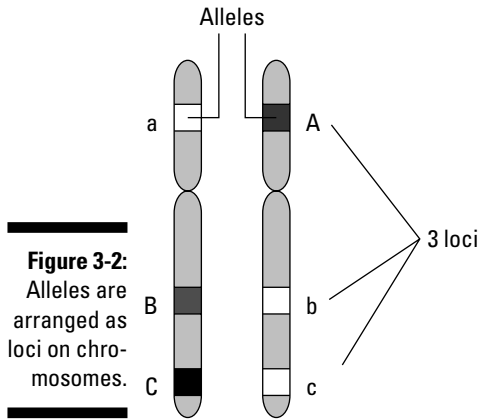

Figure 3-2:
Alleles are
arranged as
loci on chro-
mosomes.

In humans (and many other organisms), alleles of particular genes come in pairs. If both alleles are identical in form, that locus is said to be *homozygous*, and the whole organism can be called a *homozygote* for that particular locus. If the two alleles aren't identical, then the individual is *heterozygous*, or a *heterozygote*, for that trait. Individuals can be both heterozygous and homozygous at different loci at the same time, which is how all the phenotypic variation you see in a single organism is produced. For example, your eye color is controlled by at least three loci, your hair color is controlled by several loci different from eye color, and your skin color by yet other loci. You can see how figuring out how complex sets of traits are inherited would be pretty difficult.

Making Inheritance Simple

When it comes to sorting out inheritance, it's easiest to start out with how one trait — sometimes called *simple inheritance* — is transmitted from one generation to the next. This is the kind of inheritance that Mendel started with when first studying his pea plants.

Mendel's choice of pea plants and the traits he chose to focus on had positive effects on his ability to uncover the laws of inheritance.

- ✔ **The original parent plants Mendel used in his experiments were true breeding.** When true breeders are allowed to self-fertilize, the exact same physical traits show up, unchanged, generation after generation. True-breeding tall plants always produce tall plants, true-breeding short plants always produce short plants, and so on.
- ✔ **Mendel studied traits that had only two forms, or phenotypes, for each characteristic (like short or tall).** He deliberately chose traits that were either one type or another, like tall or short, green-seeded or yellow-seeded. Studying traits that came in only two forms made the inheritance of traits much easier to sort out. (Chapter 4 covers traits that have more than two phenotypes.)
- ✔ **Mendel worked only on traits that showed an *autosomal dominant* form of inheritance — that is, the genes were located on autosomal (or non-sex) chromosomes.** (More complicated forms of inheritance are discussed in Chapters 4 and 5.)

Before his pea plants began producing pollen, Mendel opened the flower buds. He cut off either the pollen-producing part (the stamen) or the pollen-receiving part (the stigma) to prevent the plant from self-fertilizing. After the flower matured, he transferred pollen by hand — okay, not technically his hand; he used a tiny brush — from one plant (the “father”) to another (the “mother”). Mendel then planted the seeds (the offspring) that resulted from this “mating” to see which physical traits were produced by each cross. The following sections explain the three laws of inheritance that Mendel discovered from his experiments.

Establishing dominance

For his experiments, Mendel crossed true-breeding plants that produced round seeds with true breeders that produced wrinkled seeds, crossed short true-breeders with tall true-breeders, and so on. Crosses of parent organisms that differ only by one trait, like seed shape or plant height, are called *monohybrid crosses*. Mendel patiently moved pollen from plant to plant, harvested and planted seeds, and observed the results after the offspring plants matured. His plants produced literally thousands of seeds, so his garden must have been quite a sight.

To describe Mendel's experiments and results, I refer to the parental generation with the letter *P*. The first offspring from a cross are referred to as *F1*. If *F1* offspring are mated to each other (or allowed to self-fertilize), the next generation is called *F2* (see Figure 3-3 for the generation breakdown).

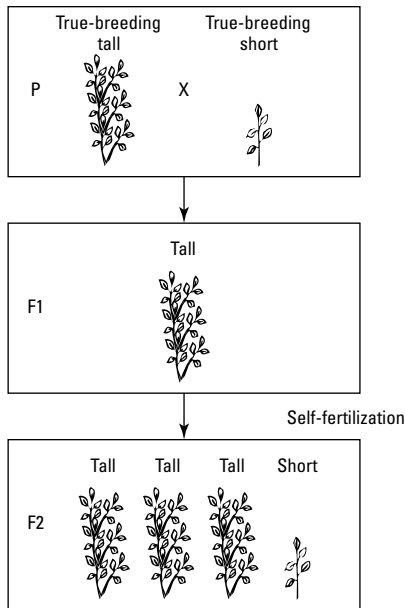

Figure 3-3: Monohybrid crosses illustrate how simple inheritance works.



The results of Mendel's experiments were amazingly consistent. In each and every case when he mated true breeders of different phenotypes, all the F1 offspring had the same phenotype as one or the other parent plant. For example, when Mendel crossed a true-breeding tall parent with a true-breeding short parent, *all* the F1 offspring were tall. This result was surprising because until then, many people thought inheritance was a blending of the characteristics of the two parents — Mendel had expected his first generation offspring to be medium height.

If Mendel had just scratched his head and stopped there, he wouldn't have learned much. But he allowed the F1 offspring to self-fertilize, and something interesting happened: About 25 percent of the F2 offspring were short, and the rest, about 75 percent, were tall (see Figure 3-3).

From that F2 generation, when allowed to self fertilize, his short plants were true breeders — all produced short progeny. His F2 tall plants produced both tall and short offspring. About one-third of his tall F2s bred true as tall. The rest produced tall and short offspring in a 3:1 ratio (that is, $\frac{3}{4}$ tall and $\frac{1}{4}$ short; see Figure 3-3).

After thousands of crosses, Mendel came to the very accurate conclusion that the factors that made seed shape, seed color, pod color, plant height, and so on were acting sets of two. He reached this understanding because *one* phenotype showed up in the F1 offspring, but *both* phenotypes were present among

the F₂ plants. The result in the F₂ generation told him that whatever it was that controlled a particular trait (such as plant height) had been present but somehow hidden in the F₁ offspring.



Mendel quickly figured out that certain traits seemed to act like rulers, or dominate, other traits. *Dominance* means that one factor masks the presence of another. Round seed shape dominated wrinkled. Tall height dominated short. Yellow seed color dominated green. Mendel rightly determined the genetic principle of *dominance* by strictly observing phenotype in generation and after generation and cross after cross. When true tall and short plants were crossed, each F₁ offspring got one height-determining factor from each parent. Because tall is *dominant* over short, all the F₁ plants were tall. Mendel found that the only time *recessive* characters (traits that are masked by dominant traits) were expressed was when the two factors were alike, as when short plants self-fertilized.

Segregating alleles

Segregation is when things get separated from each other. In the genetic sense, what's separated are the two factors — the alleles of the gene — that determine phenotype. Figure 3-4 traces the segregation of the alleles for seed color through three generations. The shorthand for describing alleles is typically a capital letter for the dominant trait and the same letter in lowercase for the recessive trait. In this example, I use *Y* for the dominant allele that makes yellow seeds; *y* stands for the recessive allele that, when homozygous, makes seeds green.



The letters or symbols you use for various alleles and traits are completely arbitrary. Just make sure you're consistent in how you use letters and symbols and don't get them mixed up.

In the segregation example featured in Figure 3-4, the parents (in the P generation) are homozygous. Each individual parent plant has a certain genotype — a combination of alleles — that determine its phenotype. Because pea plants are diploid (meaning they have two copies of each gene; see Chapter 2), the genotype of each plant is described using two letters. For example, a true-breeding yellow-seeded plant would have the genotype *YY*, and green-seeded plants are *yy*. The *gametes* (sex cells, as in pollen or eggs) produced by each plant bear only one allele. (Sex cells are haploid; see Chapter 2 for all the details on how meiosis produces haploid gametes.) Therefore, the true breeders can only produce gametes of one type — *YY* plants can only make *Y* gametes and *yy* plants can only produce *y* gametes. When a *Y* pollen and a *y* egg (or visa versa, *y* pollen and *Y* egg) get together, they make a *Yy* offspring — this is the heterozygous F₁ generation.



The bottom line of the principle of segregation is this parsing out of the pairs of alleles into gametes. Each gamete gets one and only one allele for each locus; this is the result of homologous chromosomes parting company during the first round of meiosis (see Chapter 2 for more on how chromosomes split up during meiosis). When the F1 generation self-fertilizes (to create the F2 generation), each plant produces two kinds of gametes: Half are Y, and the other half are y. Segregation makes four combinations of zygotes possible: YY, Yy, yY, or yy. (Yy and yY look redundant but are genetically significant because they represent different contributions [y or Y] from each parent.) Phenotypically, Yy, yY, and YY all look alike: yellow seeds. Only yy makes green seeds. The ratio of genotypes is 1:2:1 ($\frac{1}{4}$ homozygous dominant: $\frac{2}{4}$ heterozygous: $\frac{1}{4}$ homozygous recessive) and the ratio of phenotypes is 3 to 1 (dominant phenotype to recessive phenotype).

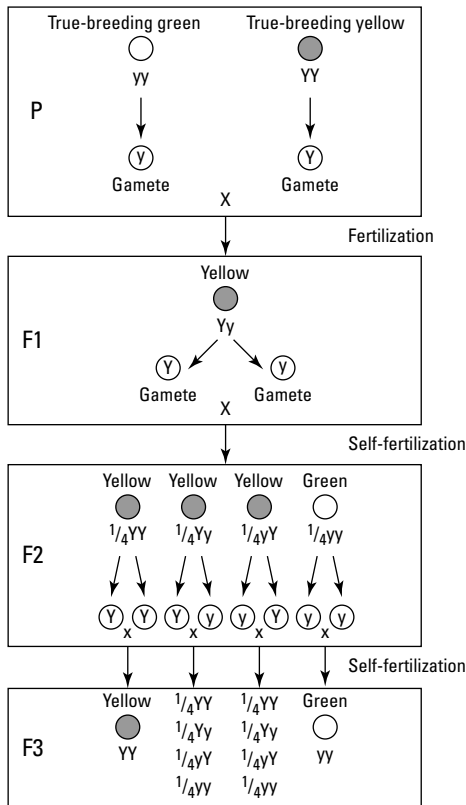

Figure 3-4: The principles of segregation and dominance as illustrated by three generations of pea plants with green and yellow seeds.

If allowed to self-fertilize in the F₃ generation, yy parents make yy offspring. YY parents produce only YY offspring. The Yy parents again make YY, Yy, and yy offspring in the same ratios observed in the F₂: $\frac{1}{4}$ YY, $\frac{1}{2}$ Yy, and $\frac{1}{4}$ yy.

Scientists now know that what Mendel saw acting in sets of two were genes. Single pairs of genes (that is, one locus) control each trait. That means that plant height was at one locus, seed color at a different locus, seed shape at third locus, and so on.

Declaring independence



As Mendel learned more about how traits were passed from one generation to the next, he carried out experiments with plants that differed in two or more traits. He discovered that the traits behaved independently — that is, that the inheritance of plant height had no effect on the inheritance of seed color, for example. The independent inheritance of traits is called the *law of independent assortment* and is a consequence of meiosis. When homologous pairs of chromosomes separate, they do so randomly with respect to each other. The movement of each individual chromosome is independent with respect to every other chromosome. It's just like flipping a coin: As long as the coin isn't rigged, one coin flip has no effect on another — each flip is an independent event. Genetically, what this random separation amounts to is that alleles on different chromosomes are inherited independently.

Segregation and independent assortment are very closely related principles. *Segregation* tells you that alleles at the same locus on pairs of chromosomes separate and that each offspring has the same chance of inheriting a particular allele from a parent. *Independent assortment* means that every offspring also has the same opportunity to inherit any allele at any other locus (but there are exceptions to this rule; see Chapter 4).

Finding Unknown Alleles

Mendel crossed parent plants in many different combinations in order to work out the identity of the hidden factors (which we now know as genes) that produced the phenotypes he observed. One type of cross was especially informative. A *testcross* is when any individual with an unknown genotype is crossed with a true breeding individual with the recessive phenotype (in other words, a homozygote).

Each cross provides different information about the genotypes of the individuals involved. For example, Mendel could take any plant with any phenotype and testcross it with a true-breeding recessive plant to learn which alleles the plant of unknown genotype carried. Here's how the testcross would work: A plant with the dominant phenotype, violet flowers, could be crossed with a true-breeding white flowered plant (ww). If the resulting offspring all had violet flowers, Mendel knew that the unknown genotype was homozygous dominant (WW). In Figure 3-5 you see the results of another testcross: A heterozygote (Ww) testcross yielded offspring of half white and half violet phenotypes.

Figure 3-5:
The results of testcrosses divulge unknown genotypes.

Testcross				
P	Violet flower		White flower	
	$W_$	X	ww	
↓				
F1	Violet	Violet	White	White
	Ww	Ww	ww	ww

Using Basic Probability to Compute the Likelihood of Inheritance



Predicting the results of crosses is easy because the likelihood of getting particular outcomes is governed by the rules of probability. The following are two important rules of probability that you should know:

- ✓ The **multiplication rule** is used when the probabilities of events are independent of each other — that is, the result of one event doesn't influence the result of another. The combined probability of both events occurring is the product of the events, so you multiply the probabilities.
- ✓ The **addition rule** is used when you want to know the probability of one event occurring as opposed to another, independent, event. Put another way, you use this rule when you want to know the probability of one event or another event happening, but not necessarily both.

For more details about the laws of probability, check out the sidebar “Beating the odds with genetics.”

Here's how the addition and multiplication rules are applied for monohybrid crosses (crosses of parent organisms that differ only by one trait). Suppose you've got two pea plants. Both plants have violet flowers, and both are heterozygous (Ww). Each plant will produce two sorts of gametes, W and w , with equal probability — that is, half of the gametes will be W and half will be w

for each plant. To determine the probability of a certain genotype resulting from the cross of these two plants, you use the multiplication rule and multiply probabilities. For example, what's the probability of getting a heterozygote (Ww) from this cross?

Because both plants are heterozygous (Ww), the probability of getting a W from plant one is $\frac{1}{2}$, and the probability of getting a w from plant two is also $\frac{1}{2}$. The word *and* tells you that you need to multiply the two probabilities to determine the probability of the two events happening together. So, $\frac{1}{2} \times \frac{1}{2} = \frac{1}{4}$. But there's another way to get a heterozygote from this cross: Plant one could contribute the w, and plant two could contribute the W. The probability of this turn of events is exactly equal to the first scenario: $\frac{1}{2} \times \frac{1}{2} = \frac{1}{4}$. Thus, there are two equally probable ways of getting a heterozygote: wW or Ww. The word *or* tells you that you must add the two probabilities together to get the total probability of getting a heterozygote: $\frac{1}{4} + \frac{1}{4} = \frac{1}{2}$. Put another way, there's a 50 percent probability of getting heterozygote offspring when two heterozygotes are crossed.

Beating the odds with genetics

When you try to predict the outcome of a certain event, like a coin flip or the gender of an unborn child, you're using probability. For many events, the probability is either-or, like a baby can be either male or female, and a coin can land either heads or tails. Both outcomes are considered equally likely (as long as the coin isn't rigged somehow). For many events, however, determining the likelihood of a certain outcome is more complicated. Deciding how to calculate the odds depends on what you want to know.

Take, for example, predicting the gender of several children born to a given couple. The probability of any baby being a boy is $\frac{1}{2}$, or 50 percent. If the first baby is a boy, the probability of the second child being a boy is still 50 percent because the events that determine gender are independent from one child to the next (see Chapter 2 for a rundown of how meiosis works to produce gametes for sex cells). That means the gender of one child has no effect on the gender of the next child. But if you want to know the probability of having two boys in a row, you multiply the probability of each independent

event together: $\frac{1}{2} \times \frac{1}{2} = \frac{1}{4}$, or 25 percent. If you want to know the probability of having two boys *or* two girls, you add the probabilities of the events together: $\frac{1}{4}$ (the probability of having two boys) + $\frac{1}{4}$ (the probability of having two girls) = $\frac{1}{2}$, or 50 percent.

Genetic counselors use probability to determine the likelihood that someone has inherited a given trait and the likelihood that a person will pass on a trait if he or she has it. For example, a man and woman are each carriers for a recessive disorder, such as cystic fibrosis. The counselor can predict the likelihood that the couple will have an affected child. Just as in Mendel's flower crosses, each parent can produce two kinds of gametes, affected or unaffected. The man produces half affected and half unaffected gametes, as does the woman. The probability that any child inherits an affected allele from the mom *and* an affected allele from the dad is $\frac{1}{4}$ (that's $\frac{1}{2} \times \frac{1}{2}$). The probability that a child will be affected *and* female is $\frac{1}{8}$ (that's $\frac{1}{4} \times \frac{1}{2}$). The probability a child will be affected *or* a boy is $\frac{3}{4}$ (that's $\frac{1}{4} + \frac{1}{2}$).

Solving Simple Genetics Problems

Every genetics problem, from those on an exam to determining what coat color your dog's puppies may have, can be solved in the same manner. Here's a simple approach to any genetics problem:

- 1. Determine how many traits you're dealing with.**
- 2. Count the number of phenotypes.**
- 3. Carefully read the problem to identify the question.** Do you need to calculate genetic or phenotypic ratios? Are you trying to determine something about the parents or the offspring?
- 4. Look for words that mean *and* and *or* to help determine which probabilities to add and which to multiply.**

Deciphering a monohybrid cross

Imagine that you have your own pea patch full of the same sort of peas that Mendel used in his experiments. After reading this book, you're filled with enthusiasm for genetics, so you rush out to count pea pods, having noticed that some plants have inflated pods and others have constricted pods. You know that last year you had one plant with inflated pods and that this year's plants are the offspring of last year's one inflated-pod plant (which self-fertilized). After counting pods, you discover that 37 of your plants have inflated pods, and 13 have constricted pods. (For the gardening-impaired, inflated pods are cylindrical, and constricted pods conform to the shape of the seeds inside the pod.) What was the genotype of your original plant? What is the dominant allele?

You've got two distinct phenotypes (constricted and inflated) of one trait, pod shape. You can choose any symbol or letter you please, but often, geneticists use a letter like *c* for constricted and then capitalize that letter for the other allele.

One way to start solving the problem of constricted versus inflated pod shape is to determine the ratio of one phenotype to the other. To calculate the ratios, add the total number of offspring together, $37 + 13 = 50$, and divide to determine the proportion of each phenotype, $37 \div 50 = 0.74$, or 74 percent have inflated pods. To verify your result, you can divide 13 by 50 to see that 26 percent of the offspring have constricted pods, and 74 percent plus 26 percent gives you 100 percent of your plants.

From this information alone, you've probably already realized (thanks to simple probability) that your original plant must have been heterozygous and that inflated is dominant over constricted. As I explain in the "Segregating alleles" section earlier in this chapter, a heterozygous plant (*Cc*) produces two kinds

of gametes (C or c) with equal probability (that is, half the time the gametes are C and the other half they're c). The probability of getting a homozygous dominant (CC) genotype is $\frac{1}{2} \times \frac{1}{2} = \frac{1}{4}$ (that's the probability of getting C twice: C once *and* C a second time, like two coin flips in a row landing heads). The probability of getting a heterozygous dominant (C and c, or c and C) is $\frac{1}{2} \times \frac{1}{2} = \frac{1}{4}$ (to get Cc) plus $\frac{1}{2} \times \frac{1}{2} = \frac{1}{4}$ (cC). The total probability of a plant with the dominant phenotype (CC or Cc or cC) is $\frac{1}{4} + \frac{1}{4} + \frac{1}{4} = \frac{3}{4}$. With 50 plants, you'd expect 37.5 of them to show the dominant phenotype — which is exactly what you observed.

Tackling a dihybrid cross

To become more comfortable with the process of solving simple genetics problems, you can tackle a problem that involves more than one trait: a *dihybrid cross*.

Here's the problem scenario. In guinea pigs, black fur is dominant. (If you're a guinea pig breeder, please forgive my oversimplification.) In a fit of largess, your mom gives you two amorous, identical guinea pigs: Lucy and Ricky. Much to your surprise (well, okay, you read *Sex For Dummies*, so you're not surprised), Lucy and Ricky produce several offspring. The surprising part is that not all the offspring look alike.

- ✓ One is white and has curly fur.
- ✓ Three are black and have curly fur.
- ✓ Three are white with smooth fur.
- ✓ Nine look just like Lucy and Ricky: black and smooth fur.

Besides the meaningful lesson about birth rates, what can you learn about the genetics of coat color and texture of your guinea pigs?

First, how many traits are you dealing with? I haven't told you anything about the gender of your baby guinea pigs, so it's safe to assume that sex doesn't have anything to do with the problem. (I take that back. Sex is the source of the problem, but see Chapter 5 for more on the genetics of sex.) You're dealing with two traits: color of fur and texture of fur.

Each trait has two phenotypes: Fur can be black or white, and texture of fur can be smooth or curly. In working through this problem, you're told upfront that black fur is a dominant trait, but you don't get any information about texture.

The simplest method is to examine one trait at a time — in other words, look at the monohybrid crosses. (Jump back to the section “Deciphering a monohybrid cross” for a refresher.)

Ricky and Lucy both have black fur. How many of their offspring have black fur? Twelve of sixteen, and $12 \div 16 = \frac{3}{4}$, or 75 percent. That means there were three black guinea pigs to every one white one.

Being identical in phenotype, Lucy and Ricky both have smooth coats. How many babies had smooth coats? Twelve of sixteen. There's that comfortingly familiar ratio again! The ratio of smooth to curly is 3 to 1.

From your knowledge of monohybrid crosses, you've probably guessed that Lucy and Ricky are heterozygous for coat color and, at the same time, are heterozygous for coat texture. To be sure, you can calculate the probability of certain genotypes and corresponding phenotypes of offspring for two guinea pigs that are heterozygous at two loci (see Figure 3-6).

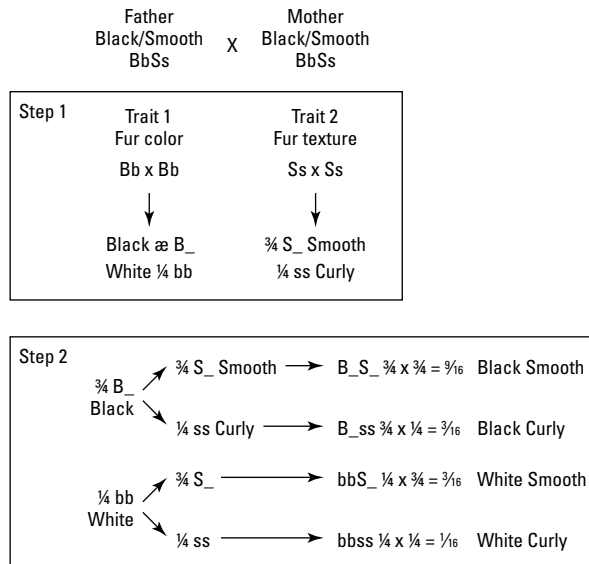

Figure 3-6: Genotypes and phenotypes resulting from a simple dihybrid cross.

The phenotypic ratio observed in Lucy and Ricky's offspring (9:3:3:1; see Figure 3-6) is typical for the F₂ generation in a dihybrid cross. The rarest phenotype is the one that's recessive for both traits; in this case, white and curly are both recessive. The most common phenotype is the one that is dominant for both traits. The fact that nine of your sixteen baby guinea pigs are black and smooth tells you that the probability of getting a particular allele for color and a particular allele for coat texture is the product of two independent events. Coat color and coat texture are coded by genes that are inherited independently — as you would expect under the principle of independent assortment.

Chapter 4

Law Enforcement: Mendel's Laws Applied to Complex Traits

In This Chapter

- ▶ Making exceptions to simple inheritance
 - ▶ Exploring how genes interact
-

Nearly 150 years have elapsed since Gregor Mendel cultivated his pea plants. The observations he made and the conclusions he drew accurately describe how genes are passed from parent to offspring. The basic laws of inheritance — dominance, segregation, and independent assortment — have stood the test of time. But inheritance isn't nearly as simple as Mendel's experiments suggest. Dominant alleles don't always dominate, and genes aren't always inherited independently. Some genes mask their appearances, and some alleles can kill. This chapter explains exactly how Mendel was right, and wrong, about the laws of inheritance and how they're enforced.

Dominant Alleles Rule . . . Sometimes

If Mendel had chosen a plant other than the pea plant for his experiments, he may have come to some very different conclusions. The traits that Mendel studied show *simple dominance* — when the dominant allele's phenotype, or physical trait (a yellow seed, for example), masks the presence of the recessive allele. The recessive phenotype (a green seed in this example) is only expressed when both alleles are recessive (which is written as yy in Chapter 3). (Take a look back at Chapter 3 for the definitions of commonly used genetics terms such as *allele*, *recessive*, and *homozygote*.) But not all alleles behave neatly as dominant-recessive. Some alleles show incomplete dominance and therefore seem to display a blend of phenotypes from the parents. This section tells you how dominant alleles rule the roost — but only part of the time.

Wimping out with incomplete dominance

A trip to the grocery store can be a nice genetics lesson. Take eggplant, for example. Eggplant comes in various shades of (mostly) purple that are courtesy of a pair of alleles at a single locus interacting in different ways to express the phenotype, purple fruit color. Dark purple and white colors are both the result of homozygous alleles. Dark purple is homozygous for the dominant purple allele (PP), and white is homozygous for the recessive allele (pp). When crossed, dark purple and white eggplants yield light purple offspring — the intermediate phenotype. This intermediate color is the result of the allele for purple being incomplete in its dominance of the allele for white (which is actually the allele for no color).



With *incomplete dominance*, the alleles are inherited in exactly the same way they always are: One allele comes from each parent. But the way those alleles are expressed — that is, the phenotype — is different. The alleles still conform to the principles of segregation and independent assortment. (You can find out about exceptions to the independent assortment rules in the section “Genes linked together” later in this chapter.)

Here’s how the eggplant cross works: The parent plants are PP (for purple) and pp (for white). The F1 generation is all heterozygous (Pp) just as you’d expect from Mendel’s experiments (see Chapter 3). If this were a case of simple dominance, all the Pp F1 generation would be dark purple. But, in this case of incomplete dominance, the F1 generation comes out light purple (sometimes called violet). (Less purple pigment is produced by the heterozygotes, making them lighter in color than homozygous purple plants.)

In the F2 (the result of crossing Pp with Pp), half the offspring have violet fruits (corresponding with the Pp genotype). One-quarter of the offspring are dark purple (PP) and one-quarter are white (pp) — these are the homozygous offspring. Rather than the 3:1 phenotypic ratio (three dark purple eggplants and one white eggplant) you’d expect to see with simple dominance, with incomplete dominance, you see a 1:2:1 ratio (one dark purple eggplant, two light purple eggplants, and one white eggplant) — the exact ratio of the underlying genotype (PP, Pp, Pp, pp).

Keeping it fair with codominance



When alleles share equally in the expression of their phenotypes, the inheritance pattern is considered *codominant*. Both alleles are expressed fully as phenotypes rather than experiencing some intermediate expression (like what’s observed in incomplete dominance).

One very good example of codominance is seen in human blood types. If you've ever donated blood (or received a transfusion), you know that your blood type is extremely important. If you receive the wrong blood type during a transfusion, you can have a fatal allergic reaction. Blood types are the result of proteins, called *antigens*, produced on the surfaces of red blood cells. Antigens protect you from disease in that they recognize invading cells (like bacteria) as foreign, bind to the cells, and destroy them.

The antigens you possess determine your blood type. Several alleles code for blood antigens. Two familiar blood types, A and B, are coded by dominant alleles. When a person has both A and B alleles, his or her blood produces both antigens simultaneously and in equal amounts. Therefore, a person who has an AB genotype also has the AB phenotype.

The situation with ABO blood types gets even more complicated by the presence of a third allele for type O in some folks. The O allele is recessive, so ABO blood types show two sorts of inheritance:

- ✓ Codominance (for A and B)
- ✓ Dominant-recessive (A or B paired with the O allele)

Type O is only expressed in the homozygous state. For more information on multiple alleles, check out the section "More than two alleles" later in this chapter.

Dawdling with incomplete penetrance



Some dominant alleles don't express their influence consistently. When dominant alleles are present but fail to show up as phenotype, the condition is termed *incompletely penetrant*. *Penetrance* is defined as the probability that an individual having a dominant allele will show the associated phenotype. *Complete penetrance*, means every person having the allele shows the phenotype. Most dominant alleles have 100 percent penetrance — that is, the phenotype is expressed in every individual possessing the allele.

One incompletely penetrant trait that shows up in humans is *polydactyly*, the condition of having extra fingers and toes beyond the usual ten each. Polydactyly is inherited as an autosomal (nonsex chromosomal) dominant trait, and men and women inherit the trait with equal frequency. Unlike most dominant traits, however, the inheritance of extra fingers and toes appears to skip generations because the allele doesn't always express the phenotype. For example, in one group of people examined for polydactyly, the trait showed up in 65 percent of people with the allele.



Geneticists usually talk about penetrance in terms of a percentage. In this example, polydactyly is 65 percent penetrant.

Breast cancer is another trait that's incompletely penetrant. One mutation (see Chapter 14 for more details) that can cause breast cancer is inherited as an autosomal dominant trait. However, penetrance is roughly 60 percent in persons carrying the allele, meaning that around 60 percent of persons carrying the allele will actually have breast cancer in their lifetimes.

Regardless of penetrance, when a trait is expressed, the degree to which the allele expresses the phenotype may differ from individual to individual; this variable strength of a trait is called *expressivity*. In persons with polydactyly, the expressivity of the trait is measured by the completeness of the extra digits — some people have tiny skin tags, and others have fully functional extra fingers or toes.

Alleles Causing Complications

The variety of forms that genes (as alleles) take accounts for the enormous diversity of physical traits you see in the world around you. There are many alleles for eye color and hair color, for example. In addition, several loci contribute to most phenotypes. Dealing with multiple loci and many alleles at each locus complicates patterns of inheritance and makes the patterns harder to understand. For many disorders, the form of inheritance isn't well understood because the patterns are masked by variable expressivity and incomplete penetrance. Additionally, multiple alleles can interact as incompletely dominant, codominant, or dominant-recessive (see "Dominant Alleles Rule . . . Sometimes" earlier in this chapter for the whole story). This section explains how various alleles of a single gene can wreak havoc with inheritance patterns.

More than two alleles

When it came to his pea plant research, Mendel deliberately chose to study traits that came in only two flavors. For instance, his peas had only two flower color possibilities: white and purple. The allele for purple in the common pea plant is fully dominant, so it shows up as the same shade of purple in heterozygous plants as it does in homozygous plants. In addition to being fully dominant, purple is completely penetrant, so every single plant that inherits the gene for purple flowers has purple flowers.

If Mendel had been a rabbit breeder instead of a gardener, his would likely be a different story. He may not have gotten the title "father of genetics" because the broad spectrum of rabbit coat colors would make most anyone simply throw up his hands.

To simplify matters, consider one gene for coat color in bunnies. The *C* gene has four alleles that control the amount of pigment produced in the hair shaft. These four alleles give you four rabbit color patterns to work with. The various rabbit color alleles are designated by the letter *c* with superscripts:

- ✔ **Brown (c^+):** Brown rabbits are considered *wild-type*, which generally is considered the “normal” phenotype. Brown rabbits are brown all over.
- ✔ **Albino (c):** White rabbits are homozygous for this color allele that doesn't produce any pigment at all. Therefore, white rabbits are considered *albino*. They have all white coats, pink eyes, and pink skin.
- ✔ **Chinchilla (c^{ch}):** Chinchilla rabbits are solid gray (specifically, they have white hair with black tips).
- ✔ **Himalayan (c^h):** Himalayan rabbits are white but have dark hair on their feet, ears, and noses.



Wild-type is a bit of a problematic term in genetics. Generally, wild-type is considered the “normal” phenotype, and everything else is “mutant.” *Mutant* is simply different, an alternative form that's not necessarily harmful. Wild-type tends to be the most common phenotype and is usually dominant over other alleles. You're bound to see wild-type used in genetics books to describe phenotypes such as eye color in fruit flies, for example. Though rare, the mutant color forms occur in natural populations of animals. In the case of domestic rabbits, color forms other than brown are the product of breeding programs specifically to obtain certain coat colors.



Although a particular trait can be determined by a number of different alleles (as in the four allele possibilities for rabbit coat color), any particular animal carries only two alleles at a particular locus at one time.

The *C* gene in rabbits exhibits a dominance hierarchy common among genes with multiple alleles. Wild-type is completely dominant over the other three alleles, so any rabbit having the c^+ allele will be brown. Chinchilla is incompletely dominant over Himalayan and albino. That means heterozygous chinchilla/Himalayan rabbits are gray with dark ears, noses, and tails. Heterozygous chinchilla/ albinos are lighter than homozygous chinchillas. Albino is only expressed in animals that are homozygous (cc).

The color alleles in monohybrid crosses for rabbit color follow the same rules of segregation and independent assortment that applied in the pea plants that Mendel studied (see Chapter 3). The phenotypes for rabbit color are just more complex. For example, if you were to cross an albino rabbit (cc) with a homozygous chinchilla ($c^{ch}c^{ch}$), in the F₂ generation (cc^{ch} mated with cc^{ch}) you'd get the expected 1:2:1 genotypic ratio (1 cc to 2 cc^{ch} to 1 $c^{ch}c^{ch}$); the phenotypes would show a corresponding 1:2:1 ratio (one albino, two light chinchilla, one full chinchilla).



Coat color in rabbits is actually controlled by a total of five genes. The section “Genes in hiding” later in this chapter delves into how multiple genes interact to create fur color.

Lethal alleles



Many alleles express unwanted traits (phenotypes) that indirectly cause suffering and death (such as the excessive production of mucus in the lungs of cystic fibrosis patients). Rarely, alleles may express the *lethal phenotype* — that is, death — immediately and thus are never expressed beyond the zygote. These alleles produce a 1:2 phenotypic ratio because only heterozygotes and homozygous nonlethals survive to be counted.

The first lethal allele to be described by scientists was associated with yellow coat color in mice. Yellow mice are *always* heterozygous. When yellow mice are bred to other yellow mice, they produce yellow and non-yellow offspring in a 2:1 ratio because all homozygous yellow mice die as embryos. Homozygous yellow has no real phenotype (beyond dead) because these animals never survive.

Lethal alleles are almost always recessive and thus are expressed only in homozygotes. One notable exception is the gene that causes Huntington disease. Huntington disease (also known as Huntington chorea) is inherited as an autosomal dominant lethal disorder, meaning that persons with Huntington develop a progressive nerve disorder that causes involuntary muscle movement and loss of mental function. Huntington is expressed in adulthood and is always fatal. It has no cure; treatment is aimed at alleviating symptoms of the disease.

Making Life More Complicated

Many phenotypes are determined by the action of more than one gene at a time. Genes can hide the effects of each other, and sometimes one gene can control several phenotypes at once. This section looks at how genes make life more complicated (and more interesting).

When genes interact

If you don't mind returning to the produce section of your local grocery store (no more eggplants, I promise), you can observe the interaction of multiple genes to produce various colors of bell peppers. Two genes (R and C) interact to make these mild, sweet peppers appear red, brown, yellow, or green. You see four phenotypes as the result of two alleles at each locus.

Figure 4-1 shows the genetic breakdown of bell peppers. In the parental generation (P), you start with a homozygous dominant pepper (RRCC), which is red, crossed with a homozygous recessive (rrcc) green pepper. (This is a dihybrid cross — that is, one involving two genes — like the one described at the end of Chapter 3.) To easily determine the expected genotypic ratios, you can consider each locus separately. For the F1 generation, that's really easy to do because both loci will be heterozygous (RrCc). Just like homozygous dominant peppers, fully heterozygous peppers are red. When the F1 peppers are allowed to self-fertilize, the phenotypes of brown and yellow show up.

Brown pepper color is produced by the genotype R_cc. The blank means that the R locus must have at least one dominant allele present to produce color, but the other allele can be either dominant or recessive. Yellow is produced by the combination rrC_. To make yellow pigment, the C allele must be either heterozygous dominant or homozygous dominant with a recessive homozygous R allele. The F2 generation shows the familiar 9:3:3:1 dihybrid phenotypic ratio (just like the guinea pigs do in Chapter 3). The loci assort independently just as you'd expect them to.

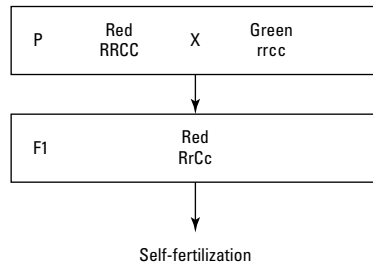

Figure 4-1: Genes interact to produce pigment in this dihybrid cross for pepper color.

	RC	Rc	rC	rc
RC	RRCC Red	RRCc Red	RrCC Red	RrCc Red
Rc	RRCc Red	RRcc Brown	RrCc Red	Rrcc Brown
rC	RrCC Red	RrCc Red	rrCC Yellow	rrCc Yellow
rc	RrCc Red	Rrcc Brown	rrCc Yellow	rrcc Green

Conclusion: 9/16 Red 3/16 Brown 3/16 Yellow 1/16 Green

Genes in hiding

As the preceding section explains, in pepper color, the alleles of two genes interact to produce color. But sometimes genes hide or mask the action of other genes altogether. This occurrence is called *epistasis*.

A good example of epistasis is the way in which color is determined in horses. Like that of dogs, cats, rabbits, and humans, horse hair color is determined by numerous genes. At least seven loci determine color in horses. To master epistasis in this section, you tackle the actions of only three genes: W, A, and E (see Table 4-1 for a rundown of the genes and their effects). One locus (W) determines the presence or absence of color. Two loci (E and A) interact to determine the distribution of red and black hair — the most common hair colors in horses.

A horse that carries one dominant allele for W will be albino — no color pigments are produced, and the animal has white skin, white hair, and pink eyes. (Homozygous dominant for the white allele is lethal; therefore, no living horse possesses the WW genotype.) All horses that are some color other than white are homozygous recessive (ww). (If you're a horse breeder, you know that I'm really oversimplifying here. Please forgive me.) Therefore, the dominant allele W shows *dominant epistasis* because it masks the presence of other alleles that determine color.

If a horse isn't white (that is, not albino), then two main genes are likely determining its hair color: E and A. When the dominant allele E is present, the horse has black hair (it may not be black all over, but it's black somewhere). Black hair's expressed because the E locus controls the production of two pigments, red and black. EE and Ee horses produce both black and red pigments. Homozygous recessive (ee) horses are red; in fact, they're always red regardless of what's happening at the A locus. Thus, ee is *recessive epistatic*, which means that in the homozygous recessive individual, the locus masks the action of other loci. In this case, the production of black pigment is completely blocked.

When a horse has at least one dominant allele at the E locus, the amount of black produced is controlled by the A locus. The A locus (also called *agouti*, which is a dark brown color) controls the production of black pigments. A horse with the dominant A allele produces black only on certain parts of its body (often on its mane, tail, and legs — a pattern referred to as *bay*). Horses that are aa are simply black. However, the homozygous recessive E locus (ee) masks the A locus entirely (regardless of genotype), blocking black color completely.

Genotype	Phenotype	Type of Epistasis	Effect
WW__	Lethal	No epistasis	Death
Ww__	Albino	Dominant	Blocks all pigments
wwE_aa	Black	Recessive	Blocks red
wwE_A_	Bay or brown	No epistasis	Both red and black expressed
ww ee__	Red	Recessive	Blocks black

This example of the genetics of horse hair color proves that the actions of genes can be very complex. In this one example, you see a lethal allele (W) along with two other loci that can each mask the other under the right combination of alleles. This potential explains why it can be so difficult to determine how certain conditions are inherited. Epistasis can act along with reduced penetrance to create extremely elusive patterns of inheritance — patterns that often can only be worked out by examining the DNA itself. (Genetic testing is covered in Chapter 12.)

Genes linked together

Roughly 30 years after Mendel's work was rediscovered in 1900 (see Chapter 22 for the whole story) and verified by the scientific community, the British geneticist Ronald A. Fisher realized that Mendel had been exceptionally lucky — either that or he'd cheated. Of the many, many traits Mendel could have studied, he published his results on seven traits that conform to the laws of segregation and independent assortment, have two alleles, and show dominant-recessive inheritance patterns. Fisher asserted that Mendel must have published the part of his data he understood and left out the rest. (After Mendel died, all his papers were burned, so we'll never know the truth.) The "rest" would include all the parts that make inheritance messy, like epistasis and *linkage*.



Because of the way genes are situated along chromosomes, genes that are very close together spatially (that is, fewer than 50 million base pairs apart; see Chapter 6 for how DNA is measured in base pairs) are inherited together. When genes are so close together that they're inherited together (either all or part of the time), the genes are said to be *linked* (see Figure 4-2). The occurrence of linked genes means that not all genes are subject to independent assortment. To determine if genes are linked, geneticists carry out a process called *linkage analysis*.

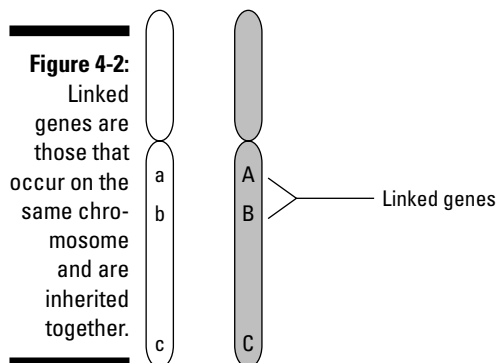

The process of linkage analysis is really a determination of how often *recombination* (the mixing of information, also called *crossing-over*, contained on the two homologous chromosomes; see Chapter 2) occurs between two or more traits. If traits are close enough together on the chromosome, they end up being linked more than 50 percent of the time. However, genes on the same chromosome can behave as if they were on different chromosomes because, during the first stage of meiosis (see Chapter 2), crossing-over occurs at many points along the two homologous chromosomes. If crossing-over splits two loci up more than 50 percent of the time, the genes on the same chromosome appear to assort independently as if the genes were on different chromosomes altogether.

Generally, linkage analysis is done by examining dihybrid crosses (dihybrid means two loci; see Chapter 3) between a heterozygote and a homozygote. If you want to determine the linkage between two traits in fruit flies, for example, you choose an individual that's $AaBb$ and cross it with one that's $aabb$. If the two loci, A and B, are assorting independently, you can expect to see the results shown in Figure 4-3. The heterozygous parent produces four types of gametes — AB, aB, Ab, ab — with equal frequency. The homozygous parent can only make one sort of gamete — ab. Thus, in the F1 offspring, you see a 1:1:1:1 ratio.

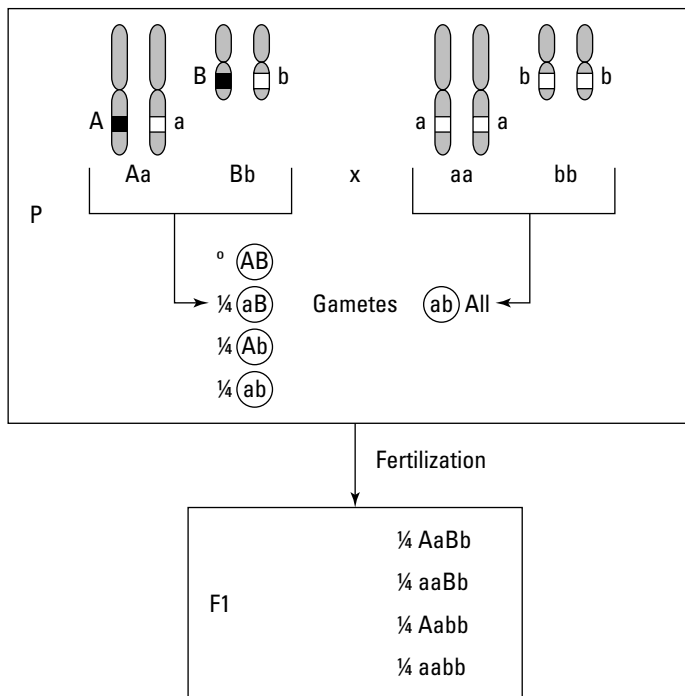

Figure 4-3:
Typical
results of a
dihybrid
testcross
when traits
assort inde-
pendently.

But what if you see a completely unexpected ratio, like the one shown in Table 4-2? What does that mean? These results indicate that the traits are linked.

As you can see in Figure 4-4, the dihybrid parent makes four sorts of gametes. Even though the loci are on the same chromosome, the gametes don't occur in equal frequency. Most of the gametes show up just as they do on the chromosome, but crossover occurs between the two loci roughly 20 percent of the time, producing the two rarer sorts of gametes (each is produced about 10 percent of the time). Crossover occurs with roughly the same frequency in the homozygous parent, too, but because the alleles are the same, the results of those crossover events are invisible. Therefore, you can safely ignore that part of the problem.

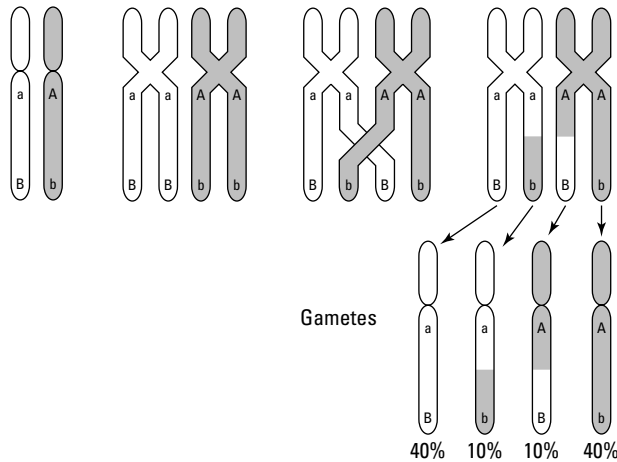

Figure 4-4:
A dihybrid
cross with
linked
genes.

Table 4-2 Linked Traits in a Dihybrid Testcross		
Genotype	Observed	Proportion
Aabb	320	40%
aaBb	318	40%
AaBb	80	10%
Aabb	76	10%



To calculate *map distance*, or the amount of crossover, between two loci, you divide the total number of recombinant offspring by the total number of offspring observed. The *recombinant offspring* are the ones that have a genotype different from the parental genotype. This calculation gives you a proportion: percent recombination. One map unit distance on a chromosome is equal to 1 percent recombination. Generally, one map unit is considered to be 1 million base pairs long.



As it turns out, four of the traits Mendel studied were situated together on chromosomes. Two traits were on chromosome 1, and two were on chromosome 4; however, the genes were far enough apart that recombination was greater than 50 percent. Thus all four traits appeared to assort independently just as they would have if they'd been on four different chromosomes.

One gene with many phenotypes

Certain genes can control more than one phenotype. Genes that control multiple phenotypes are *pleiotropic*. Pleiotropy is very common; almost any major single gene disorder listed in Online Mendelian Inheritance in Man (www.ncbi.nlm.nih.gov/entrez/query.fcgi?db=OMIM) shows pleiotropic effects.

Take, for example, phenylketonuria (PKU). This disease is inherited as a single gene defect and is autosomal recessive. When persons with the homozygous recessive phenotype consume substances containing phenylalanine, their bodies lack the proper biochemical pathway to break down the phenylalanine into tyrosine. As a result, phenylalanine accumulates in the body, preventing normal brain development. The primary phenotype of persons with PKU is mental retardation, but the impaired biochemical pathway affects other phenotypic traits as well. Thus, PKU patients also exhibit light hair color, unusual patterns of walking and sitting, skin problems, and seizures. All the phenotypic traits associated with PKU are associated with the single gene defect rather than the actions of more than one gene (see Chapter 12 for more details about PKU).

Uncovering More Exceptions to Mendel's Laws

As inheritance of genetic disorders is better studied, many exceptions to strict Mendelian inheritance rules arise. This section addresses three important exceptions.

Genomic imprinting

When traits are inherited on autosomal chromosomes, they're generally expressed equally in males and females. In some cases, the gender of the parent who contributes the particular allele may affect how the trait is expressed; this is called *genomic imprinting*.



Sheep breeders in Oklahoma discovered an amusing example of genomic imprinting. A ram named Solid Gold had unusually large hindquarters for his breed. Eventually, Solid Gold sired other sheep, which also had very large . . . butts. The breed was named Callipyge, which is Greek for “beautiful butt.” It turns out that six genes affect rump size in sheep. As breeders mated Callipyge sheep, it quickly became clear that the trait didn't obey Mendel's rules. Eventually, researchers determined that the big rump phenotype resulted only when the father passed on the trait. Callipyge ewes can't pass their big rumps on to their offspring.

The reasons behind genomic imprinting are still unclear. In the case of Callipyge sheep, scientists think there may be a mutation in a gene that regulates other genes, but why the expression of the gene is controlled by only paternal chromosomes remains a mystery. (Genomic imprinting is a big issue in cloning as well; see Chapter 20 for more on that topic.)

Anticipation

Sometimes traits seem to grow stronger and gain more expressivity from one generation to the next. The strengthening of a trait as it's inherited is called *anticipation*. Schizophrenia is a disorder that's highly heritable and often shows a pattern of anticipation. It affects a person's mood and how she views herself and the world. Some patients experience vivid hallucinations and delusions that lead them to possess strongly held beliefs such as paranoia or grandeur. The age of onset of schizophrenic symptoms and the strength of the symptoms tend to increase from one generation to the next.

The reason behind anticipation in schizophrenia and other disorders, such as Huntington disease, may be that during replication (covered in Chapter 7), repeated sections of the DNA within the gene are easily duplicated by accident (see Chapter 13 for more on mutation by duplication). Thus, in successive generations, the gene actually gets longer. As the gene grows longer, its effects get stronger as well, leading to anticipation. In disorders affecting the brain, the mutation leads to malformed proteins (see Chapter 9 for how genes are translated into protein). The malformed proteins accumulate in the brain cells, eventually causing cells to die. Because the malformed proteins may get larger in successive generations, the effects either show up when the person is young or with a more severe form of the disease.

Environmental effects

Most traits show little evidence of environmental effect. However, the phenotype produced by some genes is completely controlled by the environment the organism lives in. For example, the gene that gives a Himalayan rabbit its characteristic phenotype of dark feet, ears, and tail is a good example of a trait that varies in its expression based on the animal's environment. The pigment that produces dark fur in any animal results from the presence of an enzyme that's produced throughout the animal's body. But in this case, the enzyme's effect is deactivated at normal body temperature. Thus, the allele that produces pigment in the rabbit's fur is expressed only in parts of the body that are cooler than the rest; thus, Himalayan rabbits are all white when they're born (because they've been kept warm while inside their mother's body) but get dark noses, ears, and feet later in life. (Himalayans also change color seasonally and get lighter during the warmer months.)

Phenylketonuria (see "One gene with many phenotypes" earlier in this chapter) and other disorders of metabolism also depend on environmental factors, such as diet, for the expression of the trait.

Chapter 5

The Subject of Sex

In This Chapter

- ▶ Determining sex in humans and other animals
 - ▶ Sorting out disorders associated with sex chromosomes
 - ▶ Appreciating how sex affects other traits
-

Sex is a term with many meanings. For geneticists, sex usually refers to two related concepts: the phenotype of sex (either male or female) and reproduction. It's hard to underestimate the importance of sex when it comes to genetics. Sex influences the inheritance of traits from one generation to the next and how those traits are expressed. Sexual reproduction allows organisms to create an amazing amount of genetic diversity via their offspring, which is handy because genetically diverse populations are more resilient in the face of disease and disaster. Many different individuals carrying many different alleles of the same genes increases the likelihood that some individuals will be resistant to disease and the effects of disaster and will pass that resistance on to their offspring. (For more on the importance of genetic diversity, flip to Chapter 17.)

In this chapter, you discover how chromosomes act to determine sex in humans and other organisms, how sex influences the expression of various nonsex (autosomal) traits, and what happens when too many or too few sex chromosomes are present.

How You Got So Sexy



Presumably since the beginning of time, humans have been aware of the dissimilarities between the sexes. But it wasn't until 1905 that Nettie Stevens stared through a microscope long enough to discover the role of the Y chromosome in the grand scheme of things. Until Stevens came along, the much larger X chromosome was credited for creating all the celebrated differences between males and females.

From a genetics standpoint, the phenotypes of sex, male and female, depend on which type of gamete an individual produces. If an individual produces sperm (or has the potential to, when mature), it's considered male. If the individual can produce eggs, it's considered female. Some organisms are both male and female (that is, they're capable of producing viable eggs and sperm); this situation is referred to as *monoecy* (pronounced mo-*knee*-see, which means "one house"). Many plants, fish, and invertebrates (organisms lacking a bony spine like yours) are *monoecious* (mo-*knee*-shus).

Humans are *dioecious* (di-*ee*-shus; literally "two houses"), meaning that individuals have either functional male or female reproductive structures, but not both. Most of the species you're familiar with are dioecious: Mammals, many plants, insects, birds, and reptiles all have separate genders.

Organisms with separate genders get their sex phenotypes in various ways.

- ✔ Chromosomal sex determination occurs when the presence or absence of certain chromosomes control sex phenotype.
- ✔ Genetic sex determination occurs when particular genes control sex phenotype.
- ✔ The environment an organism develops in may determine its gender.

This section examines how chromosomes, genetics, and the environment determine whether an organism is male or female.



X marks the spot

Hermann Henking discovered the X chromosome while studying insects in the early 1890s. He wasn't quite sure what the lonely, unpaired structure did, but it seemed different from the rest of the chromosomes he was looking at. So rather than assign it a number (chromosomes are generally numbered according to size, largest to smallest), he called it X. In the early 1900s, Clarence McClung decided, rightly, that Henking's X was actually a chromosome, but he wasn't quite sure of its role. McClung started calling X the *accessory chromosome*. On the other hand, what we know as the Y chromosome carried the cumbersome moniker of "small ideochromosome." The prefix *ideo-* means unknown — in other

words, McClung and other geneticists of the time had no idea what the little Y guy was for.

Edmund Wilson discovered XX-XY sex determination in insects in 1905 (independent of Nettie Stevens, who accomplished the same feat that year). Wilson seems to have had the honor of naming the Y chromosome. According to three genetics historians I consulted on the topic, Wilson first used the name Y in 1909. There was nothing romantic about the Y designation; it was just convenient shorthand. The new name caught on rapidly, and by 1914 or so, all geneticists were calling the two sex chromosomes X and Y.

X-rated: Sex determination in humans



In humans and most other mammals, both males and females have the same overall number of chromosomes (humans have 46) in pairs (making humans *diploid*). Sex phenotype is determined by two sex chromosomes: X and Y. (Figure 5-1 shows the basic size and shape of these chromosomes.) Female humans have two X chromosomes, and male humans have one X and one Y. Check out the sidebar “X marks the spot” for how X and Y got their names. (Chromosomes have their stereotypical sausage shapes only during metaphase of mitosis or meiosis. Check out Chapter 2 for more details.)

Sexy X

During metaphase, the X chromosome truly has an x-shape, with the centromere placed roughly in the middle (see Chapter 2 for more about chromosomes and their shapes). Genetically speaking, unlike the relatively puny Y chromosome, X is quite large. Of the 23 pairs of chromosomes ordered by size, X occupies the eighth place, weighing in at slightly over 150 million base pairs long. (See Chapter 6 for more about how DNA is measured in base pairs.)

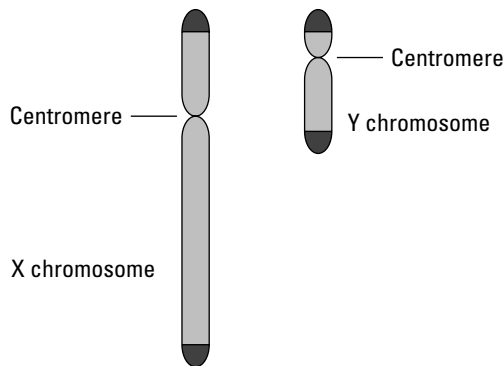

Figure 5-1:
Human X
and Y chro-
mosomes.

The X chromosome is home to between 900 and 1,200 genes and is incredibly important for normal human development. When no X is present, the zygote can't commence development. Table 5-1 lists a few of X's genes that are required for survival. Surprisingly, only one gene on X has a role in determining female phenotype; all the other genes that act to make females are found on the autosomal (nonsex) chromosomes.

Table 5-1 Important Genes Found on the X Chromosome	
<i>Gene</i>	<i>Function</i>
ALAS2	Directs formation of red blood cells
ATP7A	Regulates copper levels in the body
COL4A5	Required for normal kidney function
DMD	Controls muscle function and pathways between nerve cells
F8	Responsible for normal blood clotting

In all mammals (including humans), the developing embryo starts in what developmental biologists refer to as an *indifferent stage*, meaning the embryo has the potential to be either male or female. Here's how sex determination in mammals works: In roughly the fourth week of development, the embryo begins to develop a region near the kidneys called the *genital ridge*. Three genes (all on autosomes) kick in to convert the genital ridge tissue into tissue that can become sex organs. The tissue that is present by week seven in the embryo's development is called the *bipotential gonad* because it can become either testes or ovary tissue depending upon which genes act next.

If the embryo has at least one X and lacks a Y chromosome, two genes work together to give the embryo the female phenotype. The first gene, called DAX1, is found on the X chromosome. The second gene, WNT4, is found on chromosome 1. Together, these genes stimulate the development of ovary tissue. The ovary tissue excretes the hormone estrogen, which turns on other genes that control the development of the remaining female reproductive structures.

Little Y

In comparison to X, the Y chromosome is scrawny, antisocial, and surprisingly expendable. Y contains between 70 and 300 genes along its 50-million base pair length and is generally considered the smallest and least gene-rich human chromosome. Most of Y doesn't seem to code for any genes at all; slightly over half the Y chromosome is junk DNA. Individuals with only one X and no Y survive the condition (known as Turner syndrome, see the section "Disorders of Sex Determination in Humans" later in this chapter), demonstrating that Y supports no genes required for survival. Almost all the genes Y has are involved in male sex determination and sexual function.



Unlike the other chromosomes, most of Y doesn't recombine during meiosis (see Chapter 2 for details) because Y is so different from X — there are only small regions at the *telomeres* (the tips of chromosomes) that allow X and Y to pair during meiosis. Pairs of human chromosomes are considered homologous,

meaning the members of each pair are identical in structure and shape, and contain similar (although not identical) genetic information. X and Y are not homologous — they're different in size and shape and carry completely different sets of genes. Homologous autosomes can freely swap information during meiosis (a process referred to as crossing-over), but X and Y don't share enough information to allow crossing-over to occur. X and Y do pair up as if they were homologous so that the right number of chromosomes gets parsed out during meiosis (see Chapter 2).



Because Y doesn't recombine with other chromosomes, it's unusually good for tracing how men have traveled and settled around the world. The Y chromosome is even helping to rewrite British history. For centuries, people have believed that Anglo-Saxons conquered Britain and more or less ran everyone else out. In a 2003 survey of 1,700 British men, however, geneticists found evidence that most descended from the Celts — the original inhabitants of the British Isles. Y-chromosome studies have also helped revise American history; take a look at Chapter 18 for more details on how Y settled a long-standing debate about President Thomas Jefferson.

The most important of Y's genes is *SRY*, the Sex-determining Region Y gene, which was discovered in 1990. The *SRY* gene is what makes men. *SRY* codes for a mere 204 amino acids (flip ahead to Chapter 9 for how the genetic code works to make proteins from amino acids). Unlike most genes (and most of Y, for that matter), *SRY* is junk-free — it contains no introns (sequences that interrupt the expressed part of genes; see Chapter 8 for a full description).

SRY's most important function is starting the development of testes. Embryos that have at least one Y chromosome differentiate into males when the *SRY* gene is turned on during week seven of development. *SRY* acts with at least one other gene (on chromosome 17) to stimulate the expression of male phenotype in the form of testes. The testes themselves secrete testosterone, the hormone responsible for the expression of most traits belonging to males. (To find out how gene expression works, flip to Chapter 10.)

Surprising ways to get sex: Sex determination in other organisms

In mammals, sex determination is directed by the presence of sex chromosomes that turn on the appropriate genes to make male or female phenotypes. In most other organisms, however, sex determination is highly variable. This section looks at how various arrangements of chromosomes, genes, and even temperature affect the determination of sex.



Insects

When geneticists first began studying chromosomes in the early 1900s, insects were the organisms of choice. Grasshopper, beetle, and especially fruit fly chromosomes were carefully stained and studied under microscopes (check out Chapter 15 for how geneticists study chromosomes). Much of what we now know about chromosomes in general and sex determination in particular comes from the work of these early geneticists.

In 1901, Clarence McClung determined that female grasshoppers had two X chromosomes, but males had one (take a look at the sidebar “X marks the spot” for more about McClung’s role in discovering the sex chromosomes). This arrangement now known as XX-XO, with the O representing a lack of a chromosome, occurs in many insects. For these organisms, the number of X chromosomes in relation to the autosomal chromosomes determines maleness or femaleness. Two doses of X produce a female. One X produces a male.

In the XX-XO system, females (XX) are *homogametic*, which means that every gamete (in this case, eggs) that the individual produces has the same set of chromosomes composed of one of each autosome and one X. Males (XO) are *heterogametic*. Their sperm can come in two different types (which is where the hetero- part comes from). Half of a male’s gametes have one set of autosomes and an X; the other half have one set of autosomes and no sex chromosome at all. This imbalance in the number of chromosomes is what determines sex for XX-XO organisms.

A similar situation occurs in fruit flies. Male fruit flies are XY, but the Y doesn’t have any sex-determining genes on it. Instead, sex is determined by the number of X chromosomes compared to the number of sets of autosomes. The number of X chromosomes (it’s easier to think of this as the number of doses of X) an individual has is divided by the number of sets of autosomes (sometimes referred to as the haploid number, n ; see Chapter 2). This equation is the X to autosome (A) ratio, or X:A ratio. If the X:A ratio is $\frac{1}{2}$ or less, the individual is male. For example, an XX fly with two sets of autosomes would yield a ratio of 1 (2 divided by 2) and would be female. An XY fly with two sets of autosomes would yield a ratio of $\frac{1}{2}$ (1 divided by 2) and would be male.

Bees and wasps have no sex chromosomes at all. Instead, sex is determined by whether the individual is diploid (with paired chromosomes) or haploid (with a single set of chromosomes). Females develop from fertilized eggs and are diploid. Males develop from unfertilized eggs and are therefore haploid.

Birds

Like humans, birds have two sex chromosomes: Z and W. Female birds are ZW, and males are ZZ. Sex determination in birds isn’t well understood; two genes, one on the Z and the other on the W, both seem to play roles in whether an individual becomes male or female. The Z-linked gene suggests that like the XX-XO system in insects (see the preceding section), the number of Z

chromosomes may help determine sex (but with reversed results from XX-XO). On the other hand, the W-linked gene suggests the existence of a “female-determining” gene. The recently completed (as of this writing) chicken genome sequence (see Chapter 11 for the scoop) will provide critical information for geneticists to learn how sex is determined in birds. (The situation of sex determination gets even more complex for some bird-like animals, check out the sidebar “All of the above.”)

Reptiles

Most reptiles (like snakes and lizards) have their sex determined by sex chromosomes. However, most turtles and all crocodiles and alligators have their sex determined by the temperature the eggs experience during incubation. Female turtles and crocodilians dig nests and bury their eggs in the ground. Females usually choose nest sites in open areas likely to receive a lot of sunlight. Female turtles don’t bother to guard their eggs; they lay ’em and forget ’em. Alligators and crocodiles, on the other hand, guard their nests (quite aggressively, as I can personally attest) but let the warmth of the sun do the work.

Location, location, location

Some organisms have *location-dependent* sex determination, meaning the organism becomes male or female depending on where it ends up. Take the slipper limpet, for example. Slipper limpets (otherwise known by their highly suggestive scientific name of *Crepidula fornicata*) have concave, unpaired shells and cling to rocks in shallow seawater environments. (Basically, they look like half of an oyster.) All young slipper limpets start out as male, but a male can become female as a result of his (soon to be her) circumstances. If a young slipper limpet settles on bare rock, it becomes female. If a male settles on top of another male, the one on the bottom becomes a female to accommodate the new circumstances. If a male is removed from the top of a pile and placed on bare rock, he becomes a she and awaits the arrival of a male. After an individual becomes female, she’s stuck with the change and is a female from then on.

Bonellia worms have an even stranger system of sex determination. As larvae, ocean currents

sweep these worms along until they settle on the ocean floor, where they live and grow into adult worms. All *Bonellia* start as females. If a larvae settles and finds itself near an adult female, it crawls into her proboscis (essentially a long, flexible snout) and develops into a tiny male worm. The male lives its entire life inside the female, more or less like a parasite. His only job is to produce sperm to fertilize the female’s eggs.

Some fish also change sex depending on their locations or their social situations. Blue-headed wrasse, large reef fish familiar to many scuba divers, change into females if a male is present. If no male is around, or if the local male disappears, large females change sex to become males. The fish’s brain and nervous system control its ability to switch from one sex to another. An organ in the brain called the hypothalamus (you have one, too, by the way) regulates sex hormones and controls growth of the needed reproductive tissues.

All of the above

It has a bill like a duck and lays eggs, but it has fur and produces milk. This creature also produces venom (like a snake) that's excreted by males from spurs on their hind limbs. Did I mention that this thing can swim and senses electrical fields in the water to find fish? Is it a mammal? A bird? It's a platypus, and not only does it boast a truly strange combination of bird, reptile, and mammal characteristics, but it also has one of the most bizarre systems for determining sex. Platypuses (or is it platypi?) have a whopping ten sex chromosomes.

Platypuses are diploid. Males have 21 pairs of chromosomes plus ten sex chromosomes: five Xs and five Ys. Females have 21 pairs of chromosomes (identical to those of males) plus ten Xs. The fun doesn't stop there. The SRY gene that normally determines maleness in mammals — and yes, the platypus is considered a mammal —

is totally absent. Instead, platypuses have a version of the bird sex-determining gene that's located on one of the five X chromosomes.

The platypus's ten sex chromosomes aren't really homologous (homology would mean the chromosomes had been duplicated somehow). Because the sex chromosomes aren't all that similar to each other, during meiosis in a male, the Xs and Ys don't pair up like sex chromosomes usually do. Instead, the sex chromosomes of a male platypus form chains to ensure that the gametes get the right number of chromosomes (females' Xs seem to pair as usual). The details of how the ten sex chromosomes work to make male and female platypus phenotypes is still unknown. Scientists hope that studying platypuses will help them better understand the genetics of both mammals and birds.

In turtles, lower temperatures (78–82 degrees Fahrenheit) produce all males. At temperatures over 86 degrees, all eggs become females. Intermediate temperatures produce both sexes. Male alligators, on the other hand, are produced only at intermediate temperatures (around 91 degrees). Cooler conditions (84–88 degrees) produce only females; really warm temperatures (95 degrees) produce all females also.

An enzyme called *aromatase* seems to be the key player in organisms with temperature-dependent sex determination. Aromatase converts testosterone into estrogen. When estrogen levels are high, the embryo becomes a female. When estrogen levels are low, the embryo becomes male. Aromatase activity varies with temperature. In some turtles, for example, aromatase is essentially inactive at 77 degrees, and all eggs in that environment hatch as males. When temperatures around the eggs get to 86 degrees, aromatase activity increases dramatically, and all the eggs become females.



The increase in aromatase that makes reptiles female occurs only in the animal's brain. How changes in brain chemistry act to determine sex in these animals still isn't well understood. Humans also have a type of aromatase enzyme that does essentially the same job — that is, it converts testosterone into an estrogen (more specifically, into estradiol). In human males, estradiol is necessary for normal brain development (females secrete estrogen and don't have to convert testosterone).

Sex-Determination Disorders in Humans

Homologous chromosomes line up and part company during the first phase of meiosis, which I explain in Chapter 2. The dividing up of chromosome pairs ensures that each gamete gets only one copy of each chromosome and thus that zygotes (created from the fusion of gametes; see Chapter 2) have one pair of each chromosome without odd copies thrown in. But sometimes, mistakes occur. Xs or Ys can get left out, or extra copies can remain. These chromosomal delivery errors are caused by *nondisjunction*, which results when chromosomes fail to segregate normally during meiosis. (Chapter 15 has more information about nondisjunction and other chromosome disorders.)

Extra chromosomes can create all sorts of developmental problems. In organisms that have chromosomal sex determination, like humans, male organisms normally have only one X, giving them one copy of each gene on the X and allowing some genes on the X chromosome to act like dominant genes when, in fact, they're recessive (take a look ahead at “X-linked disorders” for more). Female organisms have to cope with two copies, or doses, of the X chromosome and its attendant genes. If both copies of a female's X were active, she'd get twice as much X-linked gene product as a male. (X-linked means any and all genes found on the X chromosome.) The extra protein produced by two copies of the gene acting at once derails normal development. The solution to this problem is a process called *dosage compensation*, when the amount of gene product is equalized in both sexes.

Dosage compensation is achieved in one of two ways:

- ✓ The organism increases gene expression on the X to get a double dose for males. This is what happens in fruit flies, for example.
- ✓ The female inactivates essentially all the genes on one X to get a “half” dose of gene expression.

Both methods equalize the amount of gene product produced by each sex. In humans, dosage compensation is achieved by *X inactivation*; one entire X chromosome is permanently and irreversibly turned off in every cell of a female's body.



X inactivation in humans is controlled by a single gene, called *XIST* (for X Inactive-Specific Transcript), that lies on the X chromosome. When a female zygote starts to develop, it goes through many rounds of cell division. When the zygote gets to be a little over 16 cells in size, X inactivation takes place. The *XIST* gene gets turned on and goes through the normal process of transcription (covered in Chapter 8). The RNA produced when *XIST* is transcribed isn't translated into protein (see Chapter 9 for how translation works and what it does). Instead, the *XIST* transcript binds directly to one of the X chromosomes to inactivate its genes (much like RNA interference; see Chapter 10 for the details).

X inactivation causes the entire inactivated chromosome to change form; it becomes highly condensed and genetically inert. Highly condensed chromosomes are easy for geneticists to spot because they soak up a lot of dye (see Chapter 15 for how geneticists study chromosomes using dyes). Murray Barr was the first person to observe the highly condensed, inactivated X chromosomes in mammals. Therefore, these inactivated chromosomes are called *Barr bodies*.

There are two very important things to remember about X inactivation:

- ✓ In humans, X inactivation is random. Only one X remains turned on, but which X remains on is left completely up to chance.
- ✓ If more than two Xs are present, only one remains completely active.

The ultimate result of X inactivation is that the tissues that arise from each embryonic cell have a “different” X. Because females get one X from their father and the other from their mother, their Xs are likely to carry different alleles of the same genes. Therefore, their tissues may express different phenotypes depending upon which X (mom’s or dad’s) remains active. This random expression of X chromosomes is best illustrated in cats.

Calico and tortoiseshell cats both have patchy-colored fur (often orange and black, but other combinations are possible). The genes that control these fur colors are on the X chromosomes. Male cats are usually all one color because they always have only one active X chromosome (and are XY). Females (XX), on the other hand, also have one active X chromosome, but the identity of the active X (maternal or paternal) varies over the cat’s body. Therefore, calico females get a patchy distribution of color depending on which X is active (that is, as long as her parents had different alleles on their Xs). If you have a calico male cat, he possesses an extra X and has the genotype XXY. XXY cats have normal phenotypes. Unlike cats, humans with extra sex chromosomes have a variety of health problems, which are summarized later in this chapter.

Extra Xs

Both males and females can have multiple X chromosomes each with different genetic and phenotypic consequences. When females have extra X chromosomes, the condition is referred to as *Poly-X* (*poly* meaning many). Poly-X females tend to be taller than average and often have a thin build. Most Poly-X women develop normally and experience normal puberty and normal menstruation and fertility. Rarely, XXX (referred to as Triplo-X) females have mental retardation; the severity of mental retardation and other health problems experienced by Poly-X females increases with the number of extra Xs. About one in every 1,000 girls are XXX.

Males with multiple X chromosomes are affected with *Klinefelter syndrome*. Roughly one in every 500 boys are XXY. Most often, males with Klinefelter are XXY, but as many as four extra X chromosomes have been observed. Like females, males affected by Klinefelter undergo X inactivation so that only one X chromosome is active. However, the extra X genes act in the embryo before X inactivation takes place. These extra doses of X genes are responsible for the phenotype of Klinefelter. Generally, males with Klinefelter are taller than average and have impaired fertility (usually they're sterile). Men with Klinefelter often have reduced secondary sexual characteristics (such as less facial hair) and sometimes have some breast enlargement due to impaired production of testosterone.



For additional information and to find contacts in your area, contact Klinefelter Syndrome and Associates at 1-888-999-9428 (www.genetic.org/ks) or the American Association for Klinefelter Syndrome Information and Support at 1-888-466-5747 (www.aaksis.org).

Extra Ys

Occasionally, human males have two or more Y chromosomes and one X chromosome. Most XYY men have a normal male phenotype, but XYY men are often taller and, as children, grow a bit faster than their XY peers. Studies conducted during the 1960s and 1970s indicated that XYY men were more prone to criminal activity than XY men. Since then, findings have documented learning disabilities (XYY boys may start talking later than XY boys), but it seems that XYY males are no more likely to commit crimes than XY males.

One X and no Y

In some cases, individuals end up with one X chromosome. Such individuals have *Turner syndrome* and are female. Affected persons often never undergo puberty and don't acquire secondary sex characteristics of adult women (namely breast development and menstruation), and they tend to have short stature. In most other ways, girls and women with Turner syndrome are completely normal. Occasionally, however, they have kidney or heart defects. Turner syndrome (also referred to as Monosomy X, meaning only one X is present) affects about one in 2,500 girls.



For additional information and to find contacts in your area, contact the Turner Syndrome Society of the United States at 1-800-365-9944 (or online at www.turner-syndrome-us.org) or the Turner Syndrome Society of Canada at 1-800-465-6744 (www.turnersyndrome.ca).

Sex-linked Inheritance

Sex not only controls an organism's reproductive options; it also has a lot to do with which genes are expressed and how. *Sex-linked genes* are ones that are actually located on the sex chromosomes themselves. Some traits are truly X- (such as hemophilia) or Y-linked (such as hairy ears). Other traits are expressed differently in males and females even though the genes that control the traits are located on nonsex chromosomes. This section explains how sex influences (and sometimes controls) the phenotypes of various genetic conditions.

X-linked disorders

Genes found on the X chromosome control X-linked traits. In 1910, Thomas H. Morgan discovered X-linked inheritance while studying fruit flies. Morgan's observations made him doubt the validity of Mendelian inheritance (see Chapter 3). His skepticism about Mendelian inheritance stemmed from the fact that he kept getting unexpected phenotypic ratios when he crossed red- and white-eyed flies. He thought the trait of white eyes was simply recessive, but when he crossed red-eyed females with white-eyed males (see Figure 5-2), he got all red-eyed flies — the exact result you'd expect from a monohybrid cross. The F₂ generation showed the expected 3:1 ratio, too.

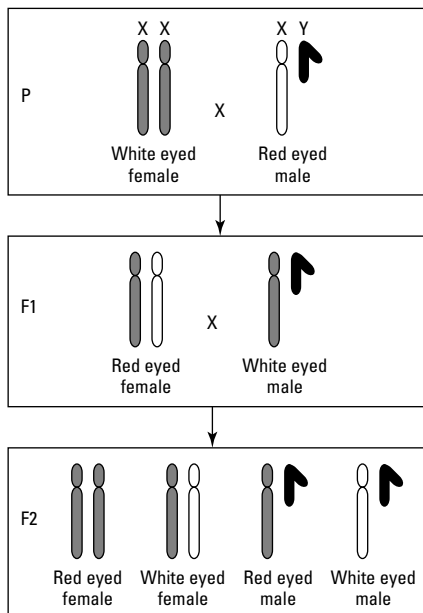

Figure 5-2:
The results
of Morgan's
fly crosses
for eye
color.

But when Morgan crossed white-eyed females with red-eyed males, all the expected relationships fell apart. The F1 generation had a 1:1 ratio of white- to red-eyed flies. In the F2, the phenotypic ratio of white-eyed to red-eyed flies was also 1:1 — not at all what Mendel would have predicted. Morgan was flustered until he looked at which sex showed which phenotype.

In Morgan's F1 offspring from his white-eyed mothers and red-eyed fathers, all the sons were white-eyed. Daughters of white-eyed females were red-eyed. In the F2, Morgan got equal numbers of white- and red-eyed males and females.

Morgan was well aware of the work on sex chromosomes conducted by Nettie Stevens and Edmund Wilson in 1905, and he knew that fruit flies have XX-XY sex chromosomes. Morgan and his students examined the phenotypes of 13 million fruit flies to confirm that the gene for eye color was located on the X chromosome. (The next time you see a fruit fly in your kitchen, imagine looking through a microscope long enough to examine 13 million flies!)

As it turns out, the gene for white eye color in fruit flies is recessive. The only time it's expressed in females is when it's homozygous. Males, on the other hand, show the trait when they have only one copy of the X-linked gene. For all X-linked recessive traits, the gene acts like a dominant gene when it's in the hemizygous (one copy) state. Any male inheriting the affected X chromosome shows the trait as if it were present in two copies. (X-linked dominant disorders also occur; see Chapter 12 for the details.)

In humans, X-linked recessive disorders rarely show up in females. Instead, X-linked recessive traits affect sons of women who are carriers. To see the distribution of X-linked recessive disorders, check out the family tree for the royal families of Europe in Chapter 12. Queen Victoria was apparently a carrier for the X-linked gene that causes hemophilia. None of Queen Victoria's ancestors appear to have had hemophilia; geneticists think that the mutation originated with Queen Victoria herself (see Chapter 13 for more about spontaneous mutations like these). Queen Victoria had one son with hemophilia and two of her daughters were carriers.

Sex-limited traits

Sex-limited traits are inherited in the normal autosomal fashion but are never expressed in one sex, regardless of whether the gene is heterozygous or homozygous. Such traits are said to have 100 percent penetrance in one sex and zero penetrance in the other. (*Penetrance* is the probability that an individual having a dominant allele will show its effects; see Chapter 4 for more.) Traits such as color differences between male and female birds are sex limited; both males and females inherit the genes for color, but the genes are expressed only in one sex (usually the male). In mammals, both males and females possess the genes necessary for milk production, but only females express these genes, which are controlled by hormone levels in the female's body (see Chapter 10 for more about how gene expression is controlled).

One trait in humans that's male-limited is precocious puberty. The corresponding gene, located on chromosome 2, causes boys to undergo the changes associated with teenage years, such as deeper voice and beard and body hair growth, at very early ages (sometimes as young as 3 years of age). The allele responsible for precocious puberty acts as an autosomal dominant, but only in males. Females, regardless of genotype, never exhibit this kind of precocious puberty.

Sex-influenced traits

Sex-influenced traits are coded by genes on autosomes, but the phenotype depends on the sex of the individual carrying the affected gene. Sex-influenced traits come down to the issue of penetrance: The traits are more penetrant in males than females. Horns, hair, and other traits that make male organisms look different from females are usually sex-influenced traits.

In humans, male-pattern baldness is a sex-influenced trait. The gene credited with male hair loss is found on chromosome 15. Baldness is autosomal dominant in men, and women only show the phenotype of hair loss when they're homozygous for the gene. The gene for male-pattern baldness has also been implicated in polycystic ovary disease in women. Women with polycystic ovary disease experience reduced fertility and other disorders of the reproductive system. The gene seems to act as an autosomal dominant for ovarian disease in women much as it does for male-pattern baldness in men, so women with ovarian disease are usually heterozygous for the condition (and thus, not bald).

Y-linked traits

The Y chromosome carries few genes, and the genes it does carry are all related to male sex determination. Therefore, most of the Y-linked traits discovered so far have something to do with male sexual function and fertility. As you may expect, Y-linked traits are passed strictly from father to son. All Y-linked traits are expressed because the Y is hemizygous (having one copy) and therefore has no other chromosome to offset gene expression. The amount of penetrance and expressivity that Y-linked traits show varies (see Chapter 4 more details about penetrance and expressivity of autosomal dominant traits).

One trait that seems to be Y-linked but isn't related to sexual function is hairy ears. Men with hairy ears grow varying amounts of hair on their outer ears or from the ear canals. The trait appears to be incompletely penetrant, meaning not all sons of hairy-eared fathers show the trait. Hairy ears also show variable expressivity from very hairy to only a few stray hairs. Aren't you glad that geneticists have focused the powers of science at their disposal on making such important discoveries? Check the section "Little Y" for a rundown of other Y-linked genes in humans and other mammals.

Part II

DNA: The Genetic Material

The 5th Wave

By Rich Tennant

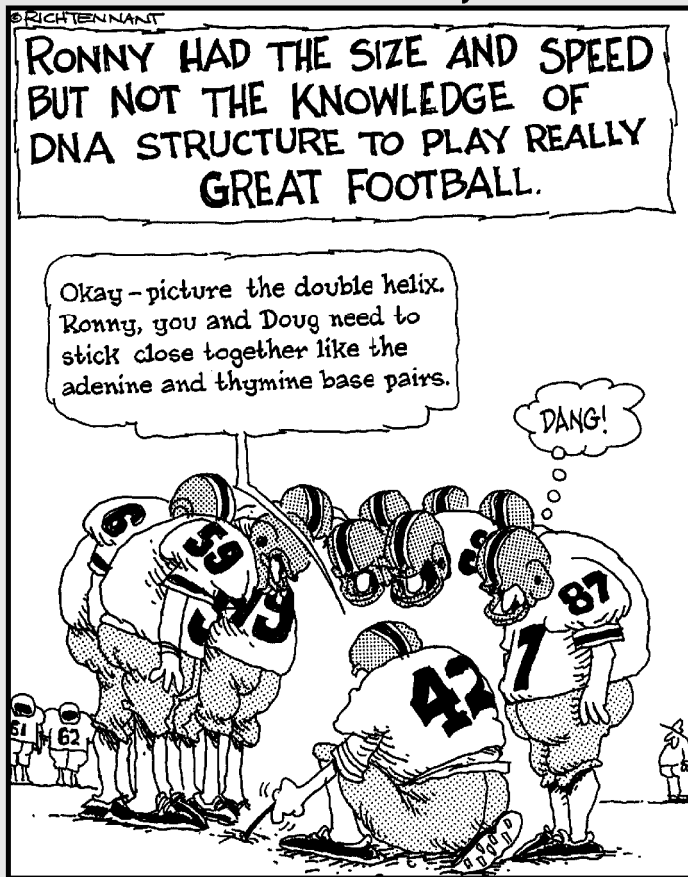

In this part . . .

The double helix is almost an icon. All life on earth depends on these elegant spiral staircases that hold all the genetic information of each and every individual. DNA's massive storage capacity comes from how it's put together. The physical and chemical makeup of DNA controls how it's copied and how its message is passed on.

In this part, I explain how DNA gets copied and how the messages are read and ultimately expressed as the traits of the organisms you see every day. The genetic code relies on DNA's close cousin, RNA, to carry the important messages of genes. The ultimate fate of DNA's messages is to create proteins, the building blocks of life. The following chapters tell you all about how DNA's blueprint is assembled from start to finish.

Chapter 6

DNA: The Basis of Life

In This Chapter

- ▶ Identifying the chemical components of DNA
 - ▶ Understanding the structure of the double helix
 - ▶ Checking out different “sets” of DNA
-

Allow me to introduce you to *deoxyribonucleic acid*, otherwise known as DNA. If the title of this chapter hasn't impressed upon you the importance and magnitude of those three little letters, consider that DNA is also referred to as “*the genetic material*” or “*the molecule of heredity*.” And you thought your title was impressive!



Every living thing on earth, from the smallest bacteria to the largest whale, uses DNA to store genetic information and transmit that info from one generation to the next; a copy of some (or all) of every creature's DNA is passed on to its offspring. The developing organism then uses DNA as a blueprint to make all its body parts. (Some non-living things use DNA to transmit information, too; see the sidebar “DNA and the undead: The world of viruses” for details.) To get an idea of how much information DNA stores, think about how complex your body is. You have hundreds of kinds of tissues that all perform different functions. It takes a lot of DNA to catalog all that. (See the section “Discovering DNA,” later in this chapter, to find out how scientists learned that DNA is the genetic material of all known life forms.)

The structure of DNA provides a simple way for the molecule to copy itself (see Chapter 7) and protects genetic messages from getting garbled (see Chapter 15). That structure is at the heart of forensic methods used to solve crimes, too (see Chapter 18). But before you can start exploring genetic information and applications of DNA, you need to have a handle on its chemical makeup and structure. That's where this chapter comes in. In this chapter, I explore the essential makeup of DNA, how it's put together, and the various sets of DNA present in living things.

DNA and the undead: The world of viruses

Viruses contain DNA, but they aren't considered living things. To reproduce, a virus must attach itself to a living cell. As soon as the virus finds a host cell, the virus injects its DNA into the cell and forces that cell to reproduce the virus. A virus can't grow without stealing energy from a living

cell, and it can't move from one organism to another on its own. Although viruses come in all sorts of fabulous shapes, they don't have all the components that cells do; in general, a virus is just DNA surrounded by a protein shell. So a virus isn't alive, but it's not quite dead either. Creepy, huh?

Deconstructing DNA

If you're like most folks, when you think of DNA, you think of a double helix. But DNA isn't just a double helix; it's a *huge* molecule — so huge that it's called a *macromolecule*. It can even be seen with the naked eye! (Check out the sidebar “Molecular madness: Extracting DNA at home” for an experiment you can do to see actual DNA.) If you were to lay out, end to end, all the DNA from just one of your cells, the line would be a little over six feet long! You have roughly 100,000,000,000,000 cells in your body (that's 100 trillion, for those of you who don't feel like counting zeros). Put another way, laid out altogether, the DNA in your body would easily stretch to the sun and back — nearly 100 times!

You're probably wondering how a huge DNA molecule can fit into a teeny tiny cell so small that you can't see it with the naked eye. Here's how: DNA is tightly packed in a process called *supercoiling*. Much like a phone cord that's been twisted around and around on itself, supercoiling takes DNA and wraps it around proteins called *nucleosomes*. Other proteins, called *histones*, hold the coils together. Together, the nucleosomes and histones form a structure similar to beads on a string. The whole “necklace” twists around itself so tightly that over six feet of DNA is compressed into only a few thousandths of an inch.

Although the idea of a DNA path to the sun works great for visualizing the size of the DNA molecule, an organism's DNA usually doesn't exist as one long piece. Rather, strands of DNA are divided into *chromosomes*, which are relatively short pieces. (I introduce chromosomes in Chapter 2 and discuss related disorders in Chapter 15.) In humans and all other eukaryotes (organisms whose cells have nuclei; see Chapter 2 for more), a full set of chromosomes is stored in the nucleus of each cell. That means that practically every cell contains a complete set of instructions to build the entire organism! The instructions are packaged as *genes*. A gene determines exactly how a specific trait will be expressed. Genes and how they work are topics discussed in detail in Chapter 10.



Cells with nuclei are found only in eukaryotes; however, not every eukaryotic cell has a nucleus. For example, humans are eukaryotes, but human red blood cells don't have nuclei. For more on cells, flip to Chapter 2.



The tutorial offered at molvis.sdsc.edu/dna/index.htm, a site hosted by the San Diego Supercomputing Center at the University of California-San Diego, provides an excellent complement to the information on the structure of DNA covered in this section, if you're willing to download a plug-in or two. You can access incredible, interactive views of precisely how DNA is put together to form the double helix. A click-and-drag feature allows you to turn the molecule in any direction in order to better understand the structure of the genetic material.

Chemical components of DNA

DNA is a remarkably durable molecule; it can be stored in ice or in a fossilized bone for thousands of years. DNA can even stay in one piece for as long as 100,000 years under the right conditions. This durability is why scientists can recover DNA from 14,000-year-old mammoths and learn that the mammoth is most closely related to today's Asian elephants. (Scientists have recovered ancient DNA from an amazing variety of organisms — check out the sidebar “Still around after all these years: Durable DNA” for more.) The root of DNA's extreme durability lies in its chemical and structural makeup.



Chemically, DNA is really simple. It's made of three components: nitrogen-rich bases, deoxyribose sugars, and phosphates. The three components, which I explain in the following sections, combine to form a *nucleotide* (see the section “Assembling the double helix: The structure of DNA” later in this chapter.) Thousands of nucleotides come together in pairs to form a single molecule of DNA.

Covering the bases

Each DNA molecule contains thousands of copies of four specific nitrogen-rich bases:

- ✓ Adenine (A)
- ✓ Guanine (G)
- ✓ Thymine (T)
- ✓ Cytosine (C)

As you can see in Figure 6-1, the bases are comprised of carbon (C), hydrogen (H), nitrogen (N), and oxygen (O) atoms.

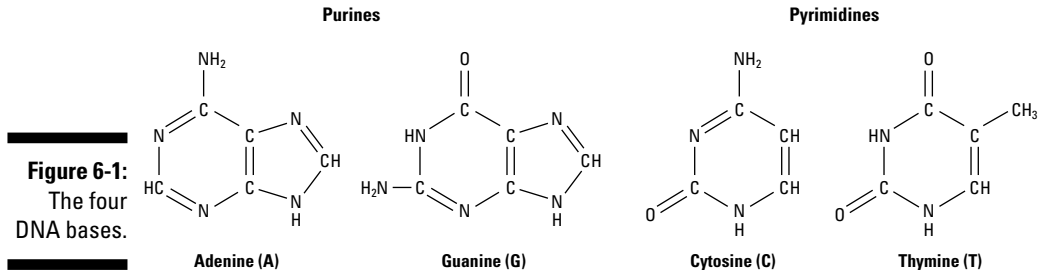

Molecular madness: Extracting DNA at home

Using this simple recipe, you can see DNA right in the comfort of your own home! You need a strawberry, salt, water, two clear jars or juice glasses, a sandwich bag, a measuring cup, a white coffee filter, clear liquid soap, and rubbing alcohol. (Other foods such as onions, bananas, kiwis, and tomatoes also work well if strawberries are unavailable.) When you've assembled these ingredients, follow the steps below.

1. Put slightly less than $\frac{3}{8}$ cup of water into the measuring cup. Add $\frac{1}{4}$ teaspoon of salt and enough clear liquid soap to make $\frac{3}{8}$ cup of liquid altogether. Stir gently until the salt dissolves into the solution.

The salt provides sodium ions needed for the chemical reaction that allows you to see the DNA in Step 6. The soap causes the cell walls to burst, freeing the DNA inside.

2. Remove the stem from the strawberry, place the strawberry into the sandwich bag, and seal the bag. Mash the strawberry thoroughly until completely pulverized (I rolled a juice glass repeatedly over my strawberry to pulverize it). Make sure you don't puncture the bag.
3. Add two teaspoons of the liquid soap-salt solution to the bag with the strawberry and

reseal the bag. Mix gently by compressing the bag or rocking the bag back and forth for at least 45 seconds to one minute.

4. Pour the strawberry mixture through the coffee filter into a clean jar. Let the mixture drain into the jar for 10 minutes.

Straining gets rid of most of the cellular debris (a fancy word for gunk) and leaves behind the DNA in the clean solution.

5. While the strawberry mixture is draining, pour $\frac{1}{4}$ cup of rubbing alcohol into a clean jar and put the jar in the freezer. After 10 minutes have elapsed, discard the coffee filter and pulverized strawberry remnants. Put the jar with the cold alcohol on a flat surface where it will be undisturbed and pour the strained strawberry liquid into the alcohol.
6. Let the jar sit for at least 5 minutes and then check out the result of your DNA experiment. The cloudy substance that forms in the alcohol layer is the DNA from the strawberry. The cold alcohol helps strip the water molecules from the outside of the DNA molecule, causing the molecule to collapse on itself and "fall out" out of the solution.

The four bases come in two flavors:

- ✓ **Purines:** The two purine bases found in DNA are adenine and guanine. If you were a chemist, you'd know that the word *purine* means a compound composed of two rings (check out adenine's and guanine's structures in Figure 6-1). If you're like me (not a chemist), you're likely still familiar with one common purine: caffeine.
- ✓ **Pyrimidines:** The two pyrimidine bases found in DNA are thymine and cytosine. The term *pyrimidine* refers to chemicals that have a single six-sided ring structure (see thymine's and cytosine's structures in Figure 6-1).



Because they're rings, all four bases are flat molecules. And as flat molecules, they're able to stack up in DNA much like a stack of coins. The stacking arrangement accomplishes two things: It makes the molecule both compact and very strong.



It's been my experience that students and other folks get confused by spatial concepts where DNA is concerned. In order to see the chemical structures more easily, DNA is often drawn as if it were a flattened ladder. But in its true state, DNA isn't flat — it's three-dimensional. Because DNA is arranged in strands, it's also linear. One way to think about this structure is to look at a phone cord (that is, if you can find a phone that isn't cordless). A phone cord spirals in three dimensions yet it's linear (rope-like) in form. That's sort of the shape DNA has, too.

The bases carry the information of DNA, but they can't bond together by themselves. Two more ingredients are needed: a special kind of sugar and a phosphate.

Adding a spoonful of sugar and a little phosphate

In order to make a complete nucleotide (thousands of which combine to make one DNA molecule), the bases must attach to deoxyribose and a phosphate molecule. *Deoxyribose* is ribose sugar that has lost one of its oxygen atoms. Figure 6-2 shows the structure of deoxyribose. When your body breaks down *Adenosine TriPhosphate* (ATP), the molecule your body uses to power your cells, ribose is released with a phosphate molecule still attached to it. Ribose loses an oxygen atom to become deoxyribose and holds onto its phosphate molecule, which is needed to transform a lone base into a nucleotide.

Figure 6-2:
The
chemical
structures
of ribose
and
deoxyribose.

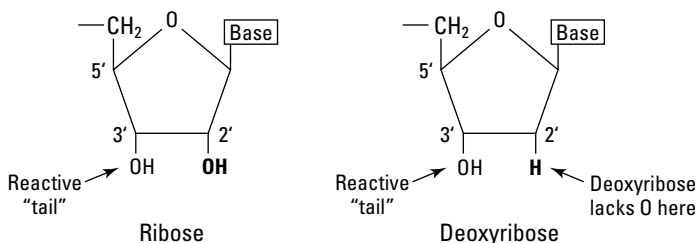

CASE STUDY



Still around after all these years: Durable DNA

When an organism dies, it starts to decay and its DNA starts to break down (for DNA, this means breaking into smaller and smaller pieces). But if a dead organism dries out or freezes shortly after death, decay slows down or even stops. Because of this kind of interference with decay, DNA has been recovered from animals and humans that roamed the earth as many as 100,000 years ago. This recovered DNA tells scientists a lot about life and the conditions of the world long ago. But even this very durable molecule has its limits — about a million years or so.

Oddly, one of the best sources of ancient DNA is poop. Yep, you heard me: poop. When an organism defecates, it sheds some intestinal cells along with its feces. Thus, both the organism and its diet can be studied from fossilized feces (*coprolites* if you want to get technical; okay, I admit it's gross!). For example, fossilized feces have yielded amazing insights about the lives of ground sloths, elephant-sized mammals that lived in North America until roughly 8,000 years ago. Samples from Nevada show that ground sloths occupied the same cave for over 20,000 years! As the global climate changed, sloth diets changed,

too, allowing scientists to track changes in the habitats of these giant herbivores.

Using DNA recovered from fossilized feces, scientists can also study the diets of our human ancestors. For example, researchers determined that Native Americans living in southwestern Texas 2,000 years ago had a diet of bighorn sheep and pronghorn antelope in addition to various plants growing in the region.

And to give you an example of DNA durability that doesn't have to do with poop (thank goodness!), in 1991, hikers in the Italian Alps discovered a human body frozen in a glacier. As the glacier melted, the retreating ice left behind a secret concealed for over 5,000 years: an ancient hunter. DNA has been recovered from this lonely hunter, his clothing, and even the food in his stomach. Apparently, red deer and ibex meat were part of his last meal. His food was dusted with pollen from nearby trees, so even the forest he walked through can be identified! The Ice Man, renamed Otzi, has yielded amazing insight about what life was like in northern Italy thousands of years ago.

Ribose (pictured in Figure 6-2) is the precursor for deoxyribose and is the chemical basis for RNA (see Chapter 8). The only difference between ribose and deoxyribose sugars is the presence or absence of an oxygen atom at the 2' site.



Chemical structures are numbered so you can keep track of where atoms, branches, chains, and rings appear. On ribose sugars, numbers are followed by an apostrophe (') to indicate the designation "prime." The addition of "prime" prevents confusion with numbered sites on other molecules that bond with ribose.

Deoxy- means that an oxygen atom is missing from the sugar molecule and defines the *D* in DNA. As an added touch, some authors write “2-” before the “deoxy-” to indicate which site lacks the oxygen — the number 2 site, in this case. The OH group at the 3’ site of both ribose and deoxyribose is a *reactive group*. That means the oxygen atom at that site is free to interact chemically with other molecules.

Assembling the double helix: The structure of DNA

Nucleotides are the true building blocks of DNA. In Figure 6-3, you see the three components of a single nucleotide: one deoxyribose sugar, one phosphate, and one of the four bases. (Flip back to “Chemical components of DNA” for the details of these components.) To make a complete DNA molecule, single nucleotides join to make chains that come together as matched pairs and form long double strands. This section walks you through the assembly process. To make the structure of DNA easier to understand, I start with how a single strand is put together.

Purine nucleotides

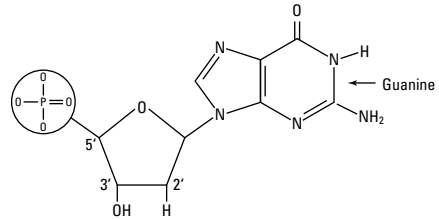
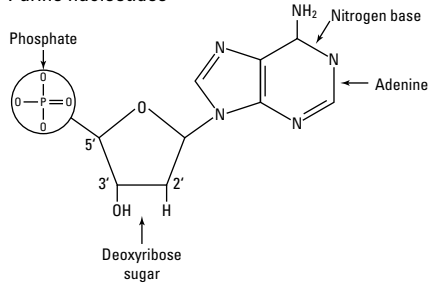

Pyrimidine nucleotides

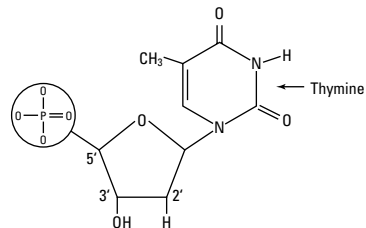
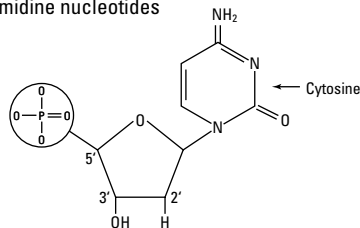

Figure 6-3:
Chemical structures of the four nucleotides present in DNA.



DNA normally exists as a double-stranded molecule. In living things, new DNA strands are *always* put together using a preexisting strand as a pattern (see Chapter 7).

Starting with one: Weaving a single strand

Hundreds of thousands of nucleotides link together to form a strand of DNA. But they don't hook up haphazardly. Nucleotides are a bit like coins in that they have two "sides" — a phosphate side and a sugar side. Nucleotides can only make a connection by joining phosphates to sugars. The bases wind up parallel to each other (stacked like coins) and the sugars and phosphates run perpendicular to the stack of bases. A long strand of nucleotides put together in this way is called a *polynucleotide* strand (*poly* meaning many). In Figure 6-4, you can see how the nucleotides join together; a single strand would comprise one-half of the two-sided molecule (the chain of sugars, phosphates, and one of the pair of bases).

Because of the way the chemical structures are numbered, DNA has numbered "ends." The phosphate end is referred to as the 5' (5-prime) end, and the sugar end is referred to as the 3' (3-prime) end. (If you missed the discussion on how the chemical structure of deoxyribose is numbered, check out the section "Adding a spoonful of sugar and a little phosphate," earlier in this chapter.) The bonds between a phosphate and two sugar molecules in a nucleotide strand are collectively called a *phosphodiester bond*. This is a fancy way of saying that two sugars are linked together by a phosphate in between.

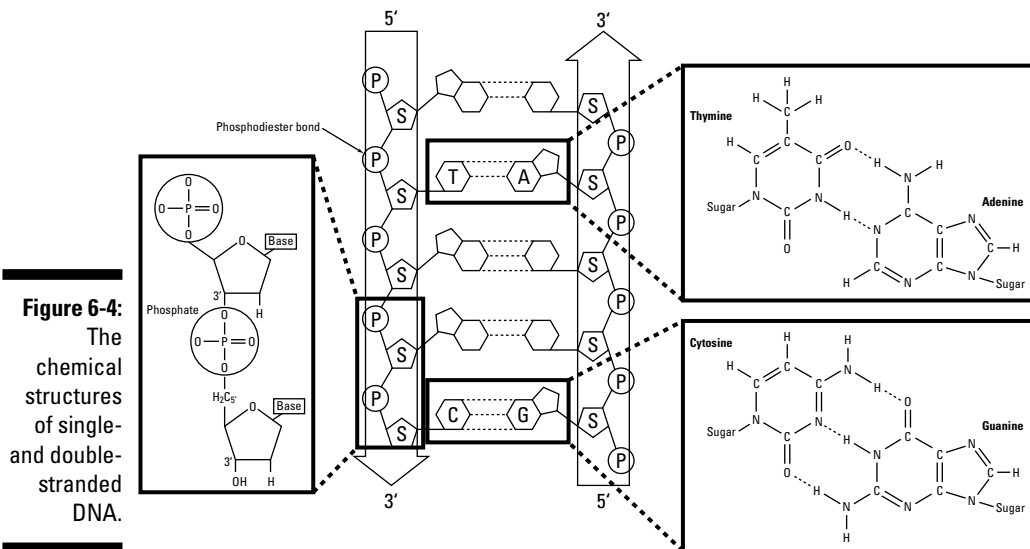

After they're formed, strands of DNA don't enjoy being single; they're always looking for a match. The arrangement in which strands of DNA match up is very, very important. A number of rules dictate how two lonely strands of DNA find their perfect matches and eventually form the star of the show, the molecule you've been waiting for — the double helix.

Doubling up: Adding the second strand

A complete DNA molecule has

- ✓ Two side-by-side polynucleotide strands twisted together.
- ✓ Bases attached in pairs in the center of the molecule.
- ✓ Sugars and phosphates on the outside, forming a “backbone.”

If you were to untwist a DNA double helix and lay it flat, it would look a lot like a ladder (see Figure 6-4). The bases are attached to each other in the center to make the rungs, and the sugars are joined together by phosphates to form the sides of the ladder. It sounds pretty straightforward, but this ladder arrangement has some special characteristics.



If you were to separate the ladder into two polynucleotide strands, you'd see that the strands are oriented in opposite directions (shown with arrows in Figure 6-4). The locations of the sugar and the phosphate give nucleotides heads and tails, two distinct ends. (If you skipped that part, it's in the earlier section “Starting with one: Weaving a single strand.”) The heads-tails (or in this case, 5'-3') orientation applies here. This head-to-tail arrangement is called *antiparallel*, which is a fancy way of saying parallel and running in opposite directions. Part of the reason the strands must be oriented this way is to guarantee that the dimensions of the DNA molecule are even along its entire length. If the strands were put together in a parallel arrangement, the angles between the atoms would be all wrong, and the strands wouldn't fit together.



The molecule is guaranteed to be the same size all over because the matching bases *complement* each other, making whole pieces that are all the same size. Adenine complements thymine, and guanine complements cytosine. The bases *always* match up in this complementary fashion. Therefore, in every DNA molecule, the amount of one base is equal to the amount of its complementary base. This condition is known as Chargaff's rules (see the “Chargaff's rules” section later in the chapter for more on the discovery of these rules).



Why can't the bases match up in other ways? First, purines are larger than pyrimidines (see “Covering the bases” earlier in the chapter). So matching like with like would introduce irregularities in the molecule's shape. Irregularities are bad because those “bumps in the road” can cause mistakes to be made when the molecule is copied (see Chapter 15).

An important result of the bases' complementary pairing is the way in which the strands bond to each other. Hydrogen bonds form between the base pairs. The number of bonds between the base pairs differs; G-C pairs have three bonds, and A-T pairs have only two. Figure 6-4 illustrates the structure of the untwisted double helix, specifically the bonds between base pairs. Every DNA molecule has hundreds of thousands of base pairs, and each base pair has multiple bonds, so the rungs of the ladder are very strongly bonded together.

When inside a cell, the two strands of DNA gently twist around each other like a spiral staircase (or a strand of licorice, or the stripes on a candy cane . . . anybody else have a sweet tooth?). The antiparallel arrangement of the two strands is what causes the twist. Because the strands run in opposite directions, they pull the sides of the molecule in opposite directions, causing the whole thing to twist around itself.

Most naturally occurring DNA spirals clockwise, as you can see in Figure 6-5. A full twist (or complete turn) occurs every ten base pairs or so, with the bases safely protected on the inside of the helix. The helical form is one way that the information that DNA carries is protected from damage that can result in mutation.

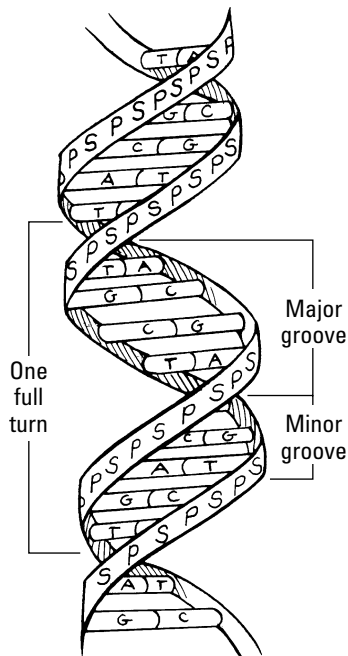

Figure 6-5:
The DNA
double helix.



The helical form creates two grooves on the outside of the molecule (see Figure 6-5). The major groove actually lets the bases peep out a little, which is important when it's time to read the information DNA contains (see Chapter 9).



Because base pairs in DNA are stacked on top of each other, chemical interactions make the center of the molecule repel water. Molecules that repel water are called *hydrophobic* (Greek for “afraid of water”). The outside of the DNA molecule is just the opposite; it attracts water. The result is that the inside of the helix remains safe and dry while the outside is encased in a “shell” of water.

There are a few additional details about DNA that you need to know:

- ✔ **A DNA strand is measured by the number of base pairs it has.**
- ✔ **The sequence of bases in DNA isn't random.** The genetic information in DNA is carried in the order of the base pairs. In fact, the genes are encoded in the base sequences. Chapter 9 explains how the sequences are read and decoded.
- ✔ **DNA uses a preexisting DNA strand as a pattern or template in the assembly process.** DNA just doesn't form on its own. The process of making a new strand of DNA using a preexisting strand is called *replication*. Replication is covered in detail in Chapter 7.

Examining Different Sets of DNA

All DNA has the same four bases, obeys the same base pairing rules, and has the same double helix structure. No matter where it's found or what function it's carrying out, DNA is DNA. That said, different sets of DNA exist within a single organism. These sets carry out different genetic functions. In this section, I explain where the various DNAs are found and describe what they do.

Nuclear DNA

Nuclear DNA is DNA found in cell nuclei, and it's responsible for the majority of functions that cells carry out. Nuclear DNA carries codes for phenotype, the physical traits of an organism (for a review of genetics terms, see Chapter 3). Nuclear DNA is packaged into chromosomes and passed from parent to offspring (see Chapter 2). When scientists talk about sequencing the human *genome*, they mean human nuclear DNA. (A genome is a full set of genetic instructions; see Chapter 11 for more about the human genome.) The nuclear genome of humans is comprised of the DNA from all 24 chromosomes (22 autosomes plus one X and one Y; see Chapter 2 for chromosome lingo).

Mitochondrial DNA

Animals, plants, and fungi all have mitochondria (for a review of cell parts, turn to Chapter 2). These powerhouses of the cell come with their own DNA, which is quite different in form (and inheritance) from nuclear DNA (see the preceding section). Each mitochondrion (the singular word for mitochondria) has many molecules of mitochondrial DNA — *mtDNA*, for short.

Whereas human nuclear DNA is linear, mtDNA is circular (hoop-shaped). Human mtDNA is very short (slightly less than 17,000 base pairs) and has roughly 37 genes, which account for almost the entire mtDNA molecule. These genes control cellular metabolism — the processing of energy inside the cell.

Half of your nuclear DNA came from your mom, and the other half came from your dad (see Chapter 2 for the scoop on how meiosis divides up chromosomes). But *all* your mtDNA came from your mom. All your mom's mtDNA came from her mom, and so on. All mtDNA is passed from mother to child in the cytoplasm of the egg cell (back to Chapter 2 for cell review!).

Meeting Rick and Eve: More on mitochondria

Mitochondrial DNA (mtDNA) bears a very strong resemblance to a bacterial DNA. The striking similarities between mitochondria and a certain bacteria called *Rickettsia* have led scientists to believe that mitochondria originated from *Rickettsia*. *Rickettsia* causes typhus, a flu-like disease transmitted by flea bites (the flea first bites an infected rat or mouse and then bites a person). As for the similarities, neither *Rickettsia* nor mitochondria can live outside a cellular home, both have circular DNA, and both share similar DNA sequences (see Chapter 11 for how DNA sequences are compared between organisms). Instead of being parasitic like *Rickettsia*, however, mitochondria are considered *endosymbiotic*, meaning they must be inside a cell to work (*endo-*), and they provide something good to the cell (*-symbiotic*). In this case, the something good is energy.

Because mtDNA is passed only from mother to child (see “Mitochondrial DNA” for an explanation), scientists have compared mtDNA from people all over the world to investigate the origins of modern humans. These comparisons have led some scientists to believe that all modern humans have one particular female ancestor in common, a woman who lived on the African continent about 150,000 years ago. This hypothetical woman has been called “Mitochondrial Eve,” but she wasn't the only woman of her time. There were many women, but apparently none of their descendents survive. A growing body of evidence suggests that all humans are descended from this rather small population of about 100,000 individuals, meaning that all people on earth have common ancestry.



Sperm cells have essentially no cytoplasm and thus, virtually no mitochondria. Special chemicals in the egg destroy the few mitochondria that sperm do possess.

Chloroplast DNA

Plants have three sets of DNA: nuclear in the form of chromosomes, mitochondrial, and *chloroplast DNA (cpDNA)*. Chloroplasts are organelles found only in plants, and they're where *photosynthesis* (the conversion of light to chemical energy) occurs. To complicate matters, plants have mitochondria (and thus mtDNA) in their chloroplasts. Like mitochondria, chloroplasts probably originated from bacteria (see the sidebar "Meeting Rick and Eve: More on mitochondria").

Chloroplast DNA molecules are circular and fairly large (120,000–160,000 base pairs) but only have about 120 genes. Most of those genes supply information used to carry out photosynthesis. Inheritance of cpDNA can be either maternal or paternal, and cpDNA, along with mtDNA, is transmitted to offspring in the cytoplasm of the seed.

Digging into the History of DNA



Back when Mendel was poking around his pea pods in the early 1860s (see Chapter 3), neither he nor anybody else knew about DNA. DNA was discovered in 1868, but its importance as the genetic material wasn't appreciated until nearly a century later. This section gives you a rundown on how DNA and its role in inheritance was revealed.

Discovering DNA

In 1868, a Swiss medical student named Johann Friedrich Miescher isolated DNA for the first time. Miescher was working with white blood cells that he obtained from the pus drained out of surgical wounds (yes, this man was dedicated to his work). Eventually Miescher established that the substance he called *nuclein* was rich in phosphorus and was acidic. Thus, one of his students renamed the substance *nucleic acid*, a name DNA still carries today. Like Mendel's findings on the inheritance of various plant traits, Miescher's work wasn't recognized for its importance until long after his death, and it took 84 years for DNA to be recognized as *the* genetic material. Until the early 1950s, everyone was sure that protein had to be the genetic material because, with only four bases, DNA seemed too simple.

In 1928, Frederick Griffith recognized that bacteria could acquire something — he wasn't quite sure what — from each other to transform harmless bacteria into deadly bacteria (see Chapter 22 for the whole story). A team of scientists lead by Oswald Avery followed up on Griffith's experiments and determined that the “transforming principle” was DNA. Even though Avery's results were solid, scientists of the time were very skeptical about the significance of DNA's role in inheritance. It took another elegant set of experiments using a *virus* that infected bacteria to convince the scientific community that DNA was the real deal.

Alfred Chase and Martha Hershey worked with a virus called a *bacteriophage* (which means “eats bacteria” even though the virus actually ruptures the bacteria rather than eats it). Bacteriophages grab onto the bacteria's cell wall and inject something into the bacteria. At the time of Hershey and Chase's experiment, the substance being injected was unidentified. The bacteriophage reproduces inside the cell and then bursts the cell wall open to free the viral “offspring.” Offspring carry the same traits as the original attacking bacteriophage, so it was certain that whatever got injected must be the genetic material given that most of the bacteriophage stays stuck on the outside of the cell. Hershey and Chase attached radioactive chemicals to track different parts of the bacteriophage; for example, they used sulfur to track protein because proteins contain sulfur, and DNA was marked with phosphorus (because of the sugar-phosphate backbone). Hershey and Chase reasoned that offspring bacteriophages would get marked with one or the other depending on which, DNA or protein, turned out to be the genetic material. The results showed that the viruses injected only DNA into the bacterial cell to infect it. All the protein stayed stuck on the outside of the bacterial cell. Their findings were published in 1952 (when Hershey was merely 24 years old!).

Obeying Chargaff's rules

Long before Hershey and Chase published their pivotal findings, Erwin Chargaff read Oswald Avery's paper on DNA as the transforming principle (profiled in Chapter 22) and immediately changed the focus of his entire research program. Unlike many scientists of his day, Chargaff recognized that DNA was the genetic material.

Chargaff focused his research on learning as much as he could about the chemical components of DNA. Using DNA from a wide variety of organisms, he discovered that all DNA had something in common: When DNA was broken into its component bases, the amount of guanine fluctuated wildly from one organism to another, but the amount of guanine always equaled the amount of cytosine. Likewise, in every organism studied, the amount of adenine equaled the amount of thymine. Published in 1949, these findings are so consistent that

they're called *Chargaff's rules*. Unfortunately, Chargaff was unable to realize the meaning of his own work. He knew that the ratios said something important about the structure of DNA, but he couldn't figure out what that something was. It took a pair of young scientists named Watson and Crick — Chargaff called them “two pitchmen in search of a helix” — to make the breakthrough.

Hard feelings and the helix: Franklin, Wilkins, Watson, and Crick



If you don't know the name Rosalind Franklin, you should. Her data on the shape of the DNA molecule revealed its structure as a double helix. Watson and Crick get all the credit for identifying the double helix, but Franklin did much of the work. While researching the structure of DNA at King's College, London, in the early 1950s, Franklin bounced X-rays off the molecule to produce incredibly sharp, detailed photos of the DNA molecule. Franklin's photos show a DNA molecule from the end, not the side, so it's difficult to envision the side view of the double helix you normally see. Yet, Franklin knew she was looking at a helix.

Meanwhile, James Watson, a 23-year-old postdoctoral fellow at Cambridge, England, was working with a 38-year-old graduate student named Francis Crick. Together, they were building enormous model of metal sticks and wooden balls, trying to figure out the structure of the same molecule Franklin had photographed.

Franklin was supposed to be collaborating with Maurice Wilkins, another scientist in her research group, but she and Wilkins despised each other (because of a switch in research projects in which Franklin was instructed to take over Wilkins's project without his knowledge). As their antagonism grew, so did Wilkins's friendship with Watson. What happened next is the stuff of science infamy. Just a few weeks before Franklin was ready to publish her findings, Wilkins showed Franklin's photographs of the DNA molecule to Watson — without her knowledge or permission! By giving Watson access to Franklin's data, Wilkins gave Watson and Crick the scoop on the competition.

Watson and Crick cracked the mystery of DNA structure using Chargaff's rules (see the section “Chargaff's rules” for details) and Franklin's measurements of the molecule. They deduced that the structure revealed by Franklin's photo, hastily drawn from memory by Watson, had to be a double helix, and Chargaff's rules pointed to bases in pairs. The rest of the structure came together like a big puzzle, and they rushed to publish their discovery in 1953. Franklin's paper, complete with the critical photos of the DNA molecule, was published in the same issue of the journal *Nature*.

In 1962, Watson, Crick, and Wilkins were honored with the Nobel Prize. Franklin wasn't properly credited for her part in their discovery but couldn't protest being left out because she had died of ovarian cancer in 1957. It's quite possible that Franklin's cancer was the result of long-term exposure to X-rays during her scientific career. In a sense, Franklin sacrificed her life for science.

Chapter 7

Copying Your DNA: Replication

In This Chapter

- ▶ Uncovering the pattern for copying DNA
 - ▶ Putting together a new DNA molecule
 - ▶ Revealing how circular DNA molecules replicate
-

Everything in genetics relies on *replication*, the process of copying DNA accurately, quickly, and efficiently. Replication is part of reproduction (producing eggs and sperm), development (making all the cells needed by a growing embryo), and maintaining normal life (replacing skin, blood, and muscle cells).

Before meiosis can occur (see Chapter 2), the entire genome must be replicated so that a potential parent can make the eggs or sperm necessary for creating offspring. After fertilization occurs, the growing embryo must have the right genetic instructions in every cell to make all the tissues needed for life. As life outside the womb goes on, almost every cell in your body needs a copy of the entire genome to ensure that the genes that carry out the business of living are present and ready for action. For example, because you're constantly replacing your skin cells and white blood cells, your DNA is being replicated right now so that your cells have the genes they need to work properly.

This chapter explains all the details of the fantastic molecular photocopier that allows DNA — the stuff of life — to do its job. First, you tackle the basics of how DNA's structure provides a pattern for copying itself. Then, you find out about all the enzymes — those helpful protein workhorses — that do the labor of opening up the double-stranded DNA and assembling the building blocks of DNA into a new strand. Finally, you see how the copying process works, from beginning (origins) to ends (telomeres).

Unzipped: Creating the Pattern for More DNA

DNA's the ideal material for carrying genetic information because it

- ✔ Stores vast amounts of complex information (genotype) that can be “translated” into physical characteristics (phenotype).
- ✔ Can be copied quickly and accurately.
- ✔ Is passed down from one generation to the next (in other words, it's *heritable*).



When Watson and Crick proposed the double helix as the structure of DNA (see Chapter 6 for coverage of DNA), they ended their 1953 paper with a pithy sentence about replication. That one little sentence paved the way for their next major publication, which hypothesized how replication might work. It's no accident that Watson and Crick won the Nobel Prize; their genius was uncanny and amazingly accurate. Without their discovery of the double helix, Watson and Crick never could've figured out replication because the trick that DNA pulls off during replication depends entirely on how DNA is put together in the first place.



If you skipped Chapter 6, which focuses on how DNA is put together, you may want to skim over that material now. The main points about DNA you need to know in order to understand replication are:

- ✔ DNA is double-stranded.
- ✔ The nucleotide building blocks of DNA always match up in a complementary fashion — A (adenosine) with T (thymine) and C (cytosine) with G (guanine).
- ✔ DNA strands run antiparallel to each other.



If you were to unzip a DNA molecule by breaking all the hydrogen bonds between the bases, you'd have two strands that each provides the pattern to create the other. During replication, special helper chemicals called *enzymes* bring matching (complementary) nucleotide building blocks to pair with the bases on each strand. The end result is two exact copies built on the *templates* provided by the unzipped original strands. Figure 7-1 shows how the original double-stranded DNA supplies a template to make copies of itself. This mode of replication is called *semiconservative*. No, this isn't how DNA may vote in the next election! In this case, semiconservative means that only half the molecule is “conserved,” or left in its original state. (*Conservative*, in the genetic sense, means keeping something protected in its original state.)

Figure 7-1:
DNA provides its own pattern for copying itself using semiconservative replication.

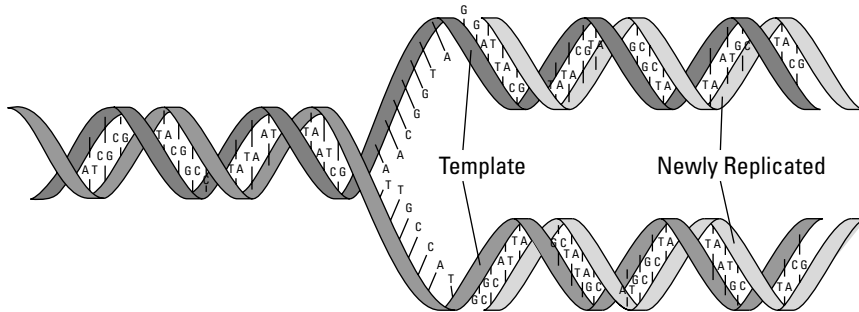

At Columbia University in 1957, J. Herbert Taylor, Philip Woods, and Walter Hughes used the cell cycle to determine how DNA is copied (see Chapter 2 for a review of mitosis and the cell cycle). They came up with two possible explanations: conservative or semiconservative replication.

Figure 7-2 shows how conservative replication might work. For both conservative and semiconservative replication, the original, double-stranded molecule comes apart and provides the template for building new strands. The result of semiconservative replication is two complete, double-stranded molecules, each composed of half “new” and half “old” DNA (which is what you see in Figure 7-1). Following conservative replication, the completed, double-stranded copies are composed of all “new” DNA, and the templates come back together to make one molecule composed of “old” DNA (as you can see in Figure 7-2).

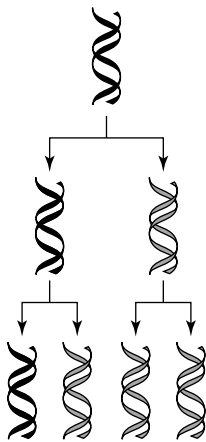

Figure 7-2:
Conservative replication.

To sort out replication, Taylor and his colleagues exposed the tips of a plant’s roots to water that contained a radioactive chemical. This chemical was a form of the nucleotide building block thymine, which is found in DNA. Before cells in

the root tips divided, their chromosomes incorporated the radioactive thymine as part of newly replicated DNA. In the first step of the experiment, Taylor and his team let the root tips grow for eight hours. That was just long enough for the DNA of the cells in the growing tips to replicate. The researchers collected some cells after this first step to see if one or both sister chromatids of each chromosome were radioactive. Then, for the second step, they put the root tips in water with no radioactive chemical in it. After the cells started dividing, Taylor and his team examined the replicated chromosomes while they were in metaphase (when the replicated chromosomes, called sister chromatids, are all lined up together in the center of the cell, before they're pulled apart to opposite ends of the soon-to-divide cell; see Chapter 2). The radioactivity allowed Taylor and his team to trace the fate of the template strands after replication was completed and determine if the strands stayed together with their copies (semiconservative) or not (conservative). They examined the results of both steps of the experiment to ensure that their conclusions were accurate.

If replication was semiconservative, Taylor, Woods, and Hughes expected to find that one sister chromatid of the replicated chromosome would be radioactive and the other would be radiation-free — and that's what they got. Figure 7-3 shows how their results ended up as they did. The shaded chromosomes represent the ones containing the radioactive thymine. After one round of replication in the presence of the radioactive thymine (step 1 in Figure 7-3), the entire chromosome appears radioactive.

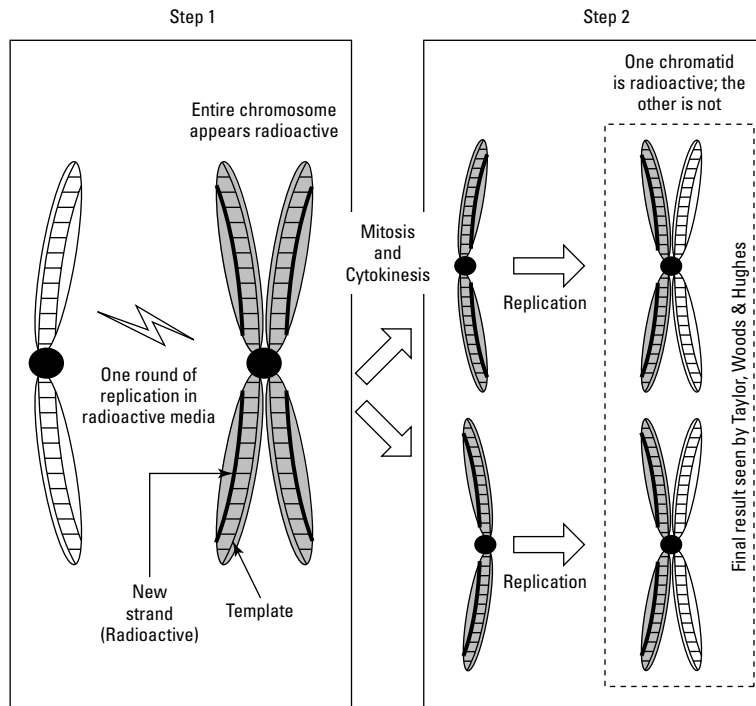

Figure 7-3: The results of Taylor, Woods, and Hughes's experiment show that DNA replication is semiconservative.

If Taylor and his team could have seen the DNA molecules themselves (as you do in the figure), they would have known that one strand of each double-stranded molecule contained radioactive thymine and the other did not (the radioactive strands are depicted with a thicker line). After one round of replication without access to the radioactive thymine (step two in Figure 7-3), one sister chromatid was radioactive, and the other was not. That's because each strand from step one provided a template for semiconservative replication: The radioactive strand provided one template, and the non-radioactive strand provided the other. After replication was completed, the templates remained paired with the new strands. This experiment showed conclusively that DNA replication is truly semiconservative — each replicated molecule of DNA is half “new” and half “old.”

How DNA Copies Itself

Replication occurs during interphase of each cell cycle, just before prophase in both mitosis and meiosis. If you skipped over Chapter 2, you may want to take a quick glance at it to get an idea of when replication occurs with respect to the life of a cell.

The process of replication follows a very specific order:

1. The helix is opened up to expose single strands of DNA.
2. Nucleotides are strung together to make new partner strands for the two original strands.

DNA replication was first studied in bacteria, which are prokaryotic (lacking cell nuclei). All nonbacterial life forms (including humans) are eukaryotes, which means these organisms are composed of cells with nuclei. There are a few minor differences between prokaryotic and eukaryotic DNA replication. Basically, bacteria use slightly different versions of the same enzymes that eukaryotic cells use, and most of those enzymes have similar names. If you understand prokaryotic replication, which I explain in this section, you have enough background to understand the details of eukaryotic replication, too.

Most eukaryotic DNA is linear, whereas most bacterial DNA (and your mitochondrial DNA) is circular. The shape of the chromosome (an endless loop versus a string) doesn't affect the process of replication at all. However, the shape means that circular DNAs have special problems to solve when replicating their hoop-shaped chromosomes. Take a look at the section “How Circular DNAs Replicate” later in this chapter to find out more.

Meeting the replication crew

For successful replication, several players must be present:

- ✓ **Template DNA**, a double-stranded molecule that provides a pattern to copy
- ✓ **Nucleotides**, the building blocks necessary to make new DNA
- ✓ **Enzymes and various proteins** that do the unzipping and assembly work of replication, called *DNA synthesis*

Template DNA

In addition to the material earlier in this chapter detailing how the template DNA is replicated semiconservatively (see “Unzipped: Creating the Pattern for More DNA”), it’s vitally important for you to understand all the meanings of the term *template*.

- ✓ Every organism’s DNA exists in the form of chromosomes. Therefore, the chromosomes undergoing replication and the template DNA used during replication are one in the same.
- ✓ Both strands of each double-stranded original molecule are copied, and therefore, each of the two strands serves as a template (that is, a pattern) for replication.



The bases of the template DNA provide critical information needed for replication. Each new base of the newly replicated strand must be complementary (that is, an exact match; see Chapter 6 for more about the complementary nature of DNA) to the base opposite it on the template strand. Together, template and replicated DNA (like you see in Figure 7-1) make two identical copies of the original, double-stranded molecule.

Nucleotides

DNA is made up of thousands of nucleotides linked together in paired strands. (If you want more details about the chemical and physical constructions of DNA, flip back to Chapter 6.) The nucleotide building blocks of DNA that come together during replication start off in the form of *deoxyribonucleoside triphosphates*, or *dNTPs*. A dNTP, like the one shown in Figure 7-4, is made up of



- ✓ A sugar (deoxyribose).
- ✓ One of four bases (adenine, guanine, thymine, or cytosine).
- ✓ Three phosphates.

Figure 7-4 shows a dNTP being incorporated into a double-stranded DNA molecule. The dNTPs used in replication are very similar in chemical structure to the ones that are found in double-stranded DNA (you can flip back to Figure 6-3 in Chapter 6 to compare a nucleotide to the dNTP shown in Figure 7-4). The key difference is the number of phosphate groups — each dNTP has three phosphates, and each nucleotide has one.

Take a look at the blow-up of the dNTP in Figure 7-4. The three phosphate groups (the “tri-” part of the name) are at the top (usually referred to as the 5-prime (5′) end of the molecule. At the bottom left of the molecule, also known as the 3-prime (3′) spot, is a little tail made of an oxygen atom attached to a hydrogen atom (collectively called an OH group or a reactive group). The oxygen atom in the OH tail is present to allow a nucleotide in an existing DNA strand to hook up with a dNTP; multiple connections like this one eventually produce the long chain of DNA. (For details on the numbered points of a molecule, such as 5′ or 3′, see Chapter 6.)

When DNA is being replicated, the OH tail on the 3′ end of the last nucleotide in the chain reacts with the phosphates of a newly arrived dNTP (as seen in the right-hand part of Figure 7-4). Two of the dNTP’s three phosphates get chopped off, and the remaining phosphate forms a phosphodiester bond with the previously incorporated nucleotide (see Chapter 6 for all the details about phosphodiester bonds). Hydrogen bonds form between the base of the template strand and the complementary base of the dNTP (see Chapter 6 for more on the bonds that form between bases). This reaction — losing two phosphates to form a phosphodiester bond and hydrogen bonding — converts the dNTP into a nucleotide. (The only real difference between dNTP and the nucleotide it becomes are the number of phosphates each carries.) Remember, the template DNA must be single-stranded for these reactions to occur (see “Splitting the helix” later in this chapter).

Each dNTP incorporated during replication must be complementary to the base it’s hooked up with on the template strand.



A nucleotide is a deoxyribose sugar, a base, and a phosphate joined together as a unit. A nucleotide is a nucleotide regardless of whether it’s part of a whole DNA molecule or not. A dNTP is also a nucleotide, just a special sort: a nucleotide triphosphate.

Enzymes

Replication can’t occur without the help of a huge suite of enzymes. *Enzymes* are chemicals that cause reactions. Generally, enzymes come in two flavors: those that put things together and those that take things apart. Both types are used during replication.

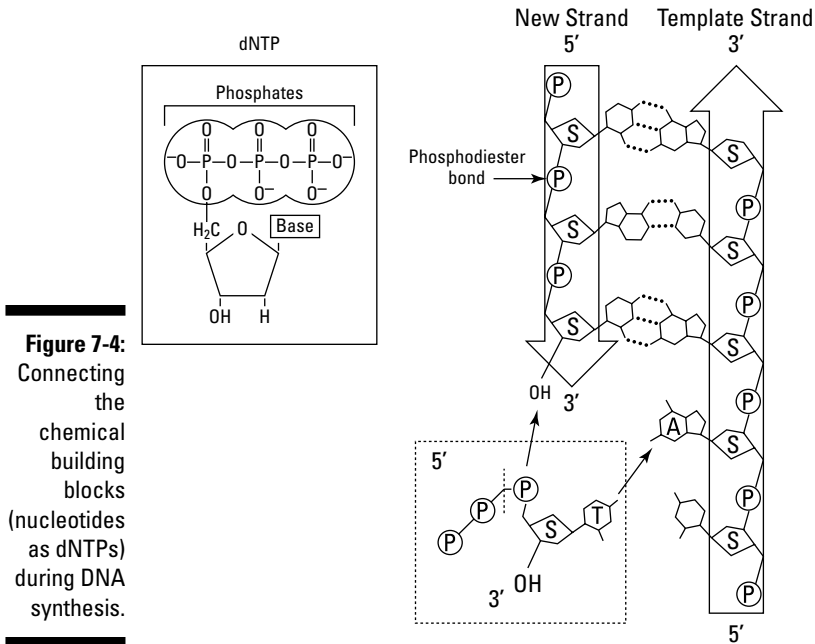

Although you can't tell which function an enzyme carries (building or destroying) by its name, you can always identify enzymes because they end in *ase*. The *ase* suffix usually follows a reference to what the enzyme acts on. For example, the enzyme *helicase* acts on the helix of DNA to make it single-stranded (helix + *ase* = *helicase*).

So many enzymes are used in replication that it's hard to keep up with them all. However, the main players and their roles are:

- ✓ **Helicase:** Opens up the double helix
- ✓ **Gyrase:** Prevents the helix from forming knots
- ✓ **Primase:** Lays down a short piece of RNA (a primer) to get replication started (see Chapter 8 for more on RNA)
- ✓ **DNA polymerase:** Adds dNTPs to build the new strand of DNA
- ✓ **Ligase:** Seals the gaps between newly replicated pieces of DNA
- ✓ **Telomerase:** Replicates the ends of chromosomes (the telomeres) — a very special job



There are five forms of DNA polymerase in prokaryotes and at least 13 forms in eukaryotes. In prokaryotes, DNA polymerase III is the enzyme that performs replication. DNA polymerase I removes RNA primers and replaces them with DNA. DNA polymerases II, IV, and V all work to repair damaged

DNA and carry out proofreading activities. Eukaryotes use a whole different set of DNA polymerases. (For more details on eukaryotic DNA replication, see the section “Replication in Eukaryotes” later in the chapter. You can also check out Table 7-1 for a list of some DNA polymerases used by eukaryotic cells and their functions.)

Splitting the helix

DNA replication starts at very specific spots, called *origins*, along the double-stranded template molecule. Bacterial chromosomes are so short (only about 4 million base pairs; see Chapter 11) that only one origin for replication is needed. Copying bigger genomes would take far too long if each chromosome had only one origin, so to make the process of copying very rapid, human chromosomes each have thousands of origins. (See the section “Replication in Eukaryotes” later in this chapter for more details on how human DNA is replicated.)

Special proteins, called *initiators*, move along the double-stranded template DNA until they encounter a group of bases that are in a specific order. These bases represent the origin for replication; think of them as a road sign with the message: “Start replication here.” The initiator proteins latch onto the template at the origin by looping the helix around themselves like looping a string around your finger. The initiator proteins then make a very small opening in the double helix.

Helicase (the enzyme that opens up the double helix) finds this opening and starts breaking the hydrogen bonds between the complementary template strands to expose a few hundred bases and split the helix open even wider. DNA has such a strong tendency to form double-strands that if another protein didn’t come along to hold the single strands exposed by helicase apart, they’d snap right back together again. These proteins, called *single-stranded-binding* (SSB) proteins, prop the two strands apart so replication can occur. Figure 7-5 shows the whole process of replication. For now, focus on the part that shows how helicase breaks the strands apart as it moves along the double helix and how the strands are kept separated and untwisted.

If you’ve had any experience with yarn or fishing line, you know that if string gets twisted together and you try to pull the strands apart, a knot forms. This same problem occurs when opening up the double helix of DNA. When helicase starts pulling the two strands apart, the opening of the helix sends extra turns along the intact helix. To prevent DNA from ending up a knotty mess, an enzyme called *gyrase* comes along to relieve the tension. Exactly how gyrase does this is unclear, but some researchers think that gyrase actually snips the DNA apart temporarily to let the twisted parts relax and then seals the molecule back together again.

Priming the pump

When helicase opens up the molecule, a Y forms at the opening. This Y is called a *replication fork*. You can see a replication fork in Figure 7-5, where the helicase has split the DNA helix apart. For every opening in the double-stranded molecule, two forks form on opposite sides of the opening. DNA replication is very particular in that it can only proceed in one direction: 5-prime to 3-prime ($5' \rightarrow 3'$). In Figure 7-5, the top strand runs $3' \rightarrow 5'$ from left to right, and the bottom strand runs $5' \rightarrow 3'$ (that is, the template strands are antiparallel; see Chapter 6 for more about the importance of the antiparallel arrangement of DNA strands). Replication must proceed antiparallel to the template, running $5'$ to $3'$. Therefore, replication on the top strand runs right to left; on the bottom strand, replication runs left to right.

After helicase splits the molecule open (as I explain in the preceding section), two naked strands of template DNA are left. Replication can't start on the naked template strands because it hasn't started yet. (That sounds a bit like Yogi Berra saying "It ain't over 'til it's over," doesn't it?) All funny business aside, nucleotides can only form chains if a nucleotide is already present with a free reactive tail on which to attach the incoming dNTP. DNA solves the problem of starting replication by inserting *primers*, little complementary starter strands made of RNA (see Figure 7-5).

Primase, the enzyme that manufactures the RNA primers for replication, lays down primers at each replication fork so that DNA synthesis can proceed from $5' \rightarrow 3'$ on both strands. The RNA primers made by primase are only about 10 or 12 nucleotides long. They're complementary to the single strands of DNA and end with the same sort of OH tail found on a nucleotide of DNA. (To find out more about RNA, you can flip ahead to Chapter 8.) DNA uses the primers' free OH tails to add nucleotides in the form of dNTPs (see "Nucleotides" earlier in this chapter); the primers are later snipped out and replaced with DNA (see "Joining all the pieces" later in this chapter).

Leading and lagging

As soon as the primers are in place, actual replication can get underway. *DNA polymerase* is the enzyme that does all the work of replication. At the OH tail of each primer, DNA polymerase tacks on dNTPs by snipping off two phosphates and forming phosphodiester bonds. Meanwhile, helicase opens up the helix ahead of the growing chain to expose more template strand. From Figure 7-5, it's easy to see that replication can just zoom along this way — but only on one strand (in this case, the top strand in Figure 7-5). The replicated strands keep growing continuously $5' \rightarrow 3'$ as helicase makes the template available. At the same time, on the opposite strand, new primers have to be added to take advantage of the newly available template. The new primers

are necessary because a naked strand (the bottom one in Figure 7-5) lacking the necessary free nucleotide for chain building is created by the ongoing splitting of the helix.

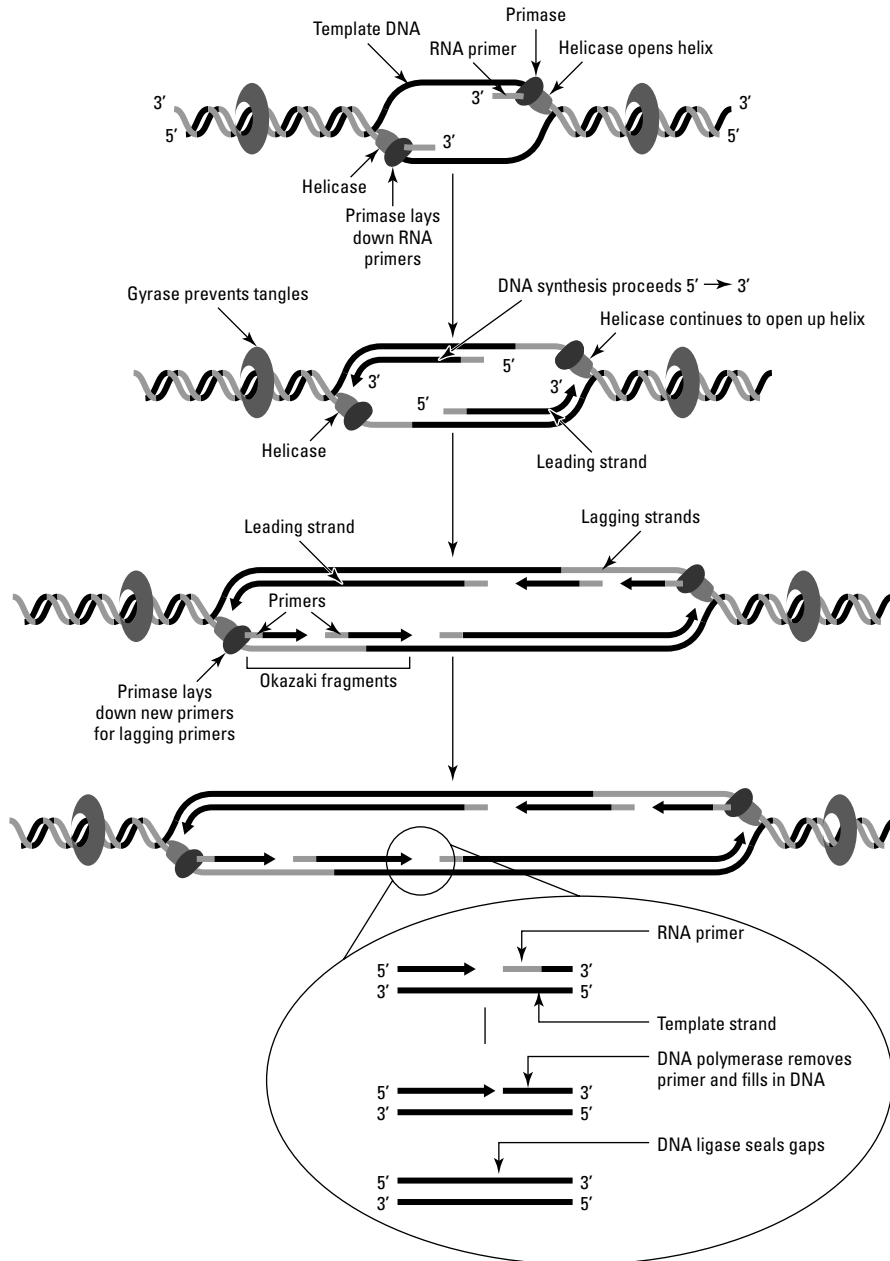

Figure 7-5:
The process
of
replication.

Thus, the interaction of opening the helix and synthesizing DNA 5' → 3' on one strand while laying down new primers on the other leads to the formation of *leading* and *lagging strands*.

- ✔ **Leading strands:** The strands being formed in one bout of uninterrupted DNA synthesis (you can see a leading strand in Figure 7-6). Leading strands follow the lead, so to speak, of helicase.
- ✔ **Lagging strands:** The strands that are begun over and over as new primers are laid down. Synthesis of the lagging strands stops when they reach the 5' end of a primer elsewhere on the strand. Lagging strands “lag behind” leading strands in the sense of frequent starting and stopping versus continuous replication. (Replication happens so rapidly that there’s no difference in the amount of time it takes to replicate leading and lagging strands). The short pieces of DNA formed by lagging DNA synthesis have a special name: *Okazaki fragments*, named for the scientist, Reiji Okazaki, who discovered them.

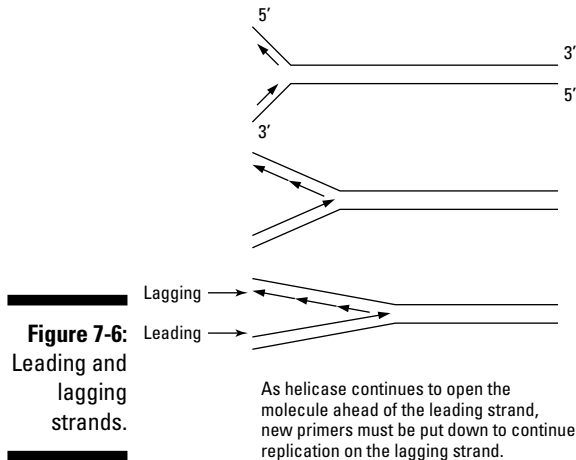

Figure 7-6:
Leading and
lagging
strands.

Joining all the pieces

After the template strands are replicated, the newly synthesized strands have to be modified to be complete and whole:

- ✔ The RNA primers must be removed and replaced with DNA.
- ✔ The Okazaki fragments formed by lagging DNA synthesis must be joined together.

A special kind of DNA polymerase moves along the newly synthesized strands seeking out the RNA primers. When DNA polymerase encounters the short bits of RNA, it snips them out and replaces them with DNA. Figure 7-5 illustrates this process. The snipping out and replacing of RNA primers proceeds in the usual 5' → 3' direction of replication and follows the same procedures as normal DNA synthesis (adding dNTPs and forming phosphodiester bonds).

After the primers are removed and replaced, one phosphodiester bond is missing between the Okazaki fragments. *Ligase* is the enzyme that seals these little gaps (“ligate” meaning to join things together). Ligase has the special ability to form phosphodiester bonds without adding a new nucleotide.

Proofreading replication

Despite its complexity, replication is unbelievably fast. In humans, replication speeds along at about 2,000 bases a minute. Bacterial replication is even faster at about 1,000 bases per *second!* Working at that speed, it's really no surprise that DNA polymerase makes mistakes — about one in every 100,000 bases is incorrect. Fortunately, DNA polymerase can use the backspace key!



DNA polymerase is constantly checking its work through a process called *proofreading* — the same way I proofread my work as I wrote this book. DNA polymerase looks over its shoulder, so to speak, and keeps track of how well the newly added bases fit with the template strand. If an incorrect base is added, DNA polymerase backs up and cuts the incorrect base out. The snipping process is called *exonuclease activity*, and the correction process requires DNA polymerase to move 3' → 5' instead of the usual 5' → 3' direction. DNA proofreading eliminates most of the mistakes made by DNA polymerase, and the result is nearly error-free DNA synthesis. Generally, replication (after proofreading) has an astonishingly low error rate of one in 10 million base pairs.

If DNA polymerase misses an incorrect base, special enzymes come along after replication is complete to carry out another process, called *mismatch repair* (much like my editors checked my proofreading). The mismatch repair enzymes detect the bulges that occur along the helix when non-complementary bases are paired up, and the enzymes snip the incorrect base out of the newly synthesized strand. These enzymes replace the incorrect base with the correct one and, like ligase, seal up the gaps to finish the repair job.



Replication is a complicated process that uses a dizzying array of enzymes. The key points to remember are:

- ✓ Replication always starts at an origin.
- ✓ Replication can only occur when template DNA is single-stranded.
- ✓ RNA primers must be put down before replication can proceed.

- ✓ Replication always moves 5' → 3'.
- ✓ Newly synthesized strands are complementary, exact matches to template (“old”) strands.

Replication in Eukaryotes

Although replication in prokaryotes (organisms without cell nuclei) and eukaryotes (organisms with cell nuclei) is very similar, there are four differences you need to know about:

- ✓ For each of their chromosomes, eukaryotes have many, many origins for replication. Prokaryotes generally have one origin per circular chromosome.
- ✓ The enzymes used by prokaryotes and eukaryotes for replication are similar but not identical. Compared to prokaryotes, eukaryotes have many more DNA polymerases, and these DNA polymerases carry out other functions besides replication. Take a look at Table 7-1 to see four of the 13 DNA polymerase enzymes used in eukaryotic replication.
- ✓ Linear chromosomes, found in eukaryotes, require special enzymes to replicate the *telomeres*, the ends of chromosomes.
- ✓ Eukaryotic chromosomes are tightly wound around special proteins in order to package large amounts of DNA into very small cell nuclei.

Table 7-1 **Some DNA Polymerases Used
in Eukaryotic Replication**

<i>DNA Polymerase</i>	<i>Function</i>
Alpha	Starts replication at the primer, repairs mistakes during proofreading
Beta	Recombines chromosomes during meiosis
Gamma	Replicates mitochondrial DNA
Delta	Carries out the majority of DNA synthesis

Pulling up short: Telomeres

When linear chromosomes replicate, the ends of the chromosomes, called *telomeres*, present special challenges. These challenges are handled in different ways depending upon what kind of cell division is taking place (that is, mitosis versus meiosis).

At the completion of replication for cells in mitosis, a short part of the telomere tips is left single-stranded and unreplicated. A special enzyme comes along and snips off this unreplicated part of the telomere. Losing this bit of DNA at the end of the chromosome isn't as big a deal as it may seem because telomeres, in addition to being the ends of chromosomes, are long strings of *junk DNA*. Junk DNA doesn't contain genes but may have other important functions (see Chapter 11 for the details).

For telomeres, being junk DNA is good because when telomeres get snipped off, the chromosomes aren't damaged too much and the genes still work just fine — up to a point. After many rounds of replication, all the junk DNA at the ends of the chromosomes is snipped off (essentially, the chromosomes run out of junk DNA), and actual genes themselves are affected. Therefore, when the chromosomes of a mitotic cell (like a skin cell, for example) get too short, the cell dies through a process called *apoptosis*. (Apoptosis is covered in detail in Chapter 14.) Paradoxically, cell death through apoptosis is a good thing because it protects you from the ravages of mutations, which can cause cancer.

If the cell is being divided as part of meiosis, telomere snipping is not okay. The telomeres must be replicated completely so that perfectly complete, full-size chromosomes are passed on to offspring. An enzyme called *telomerase* takes care of replicating the ends of the chromosomes. Figure 7-7 gives you an idea of how telomerase replicates telomeres. Primase lays down a primer at the very tip of the chromosome as part of the normal replication process. DNA synthesis proceeds from 5' → 3' as usual, and then, a DNA polymerase comes along and snips out the RNA primer from 5' → 3'. Without telomerase, the process stops, leaving a tail of unreplicated, single-stranded DNA flapping around (this is what happens during mitosis).

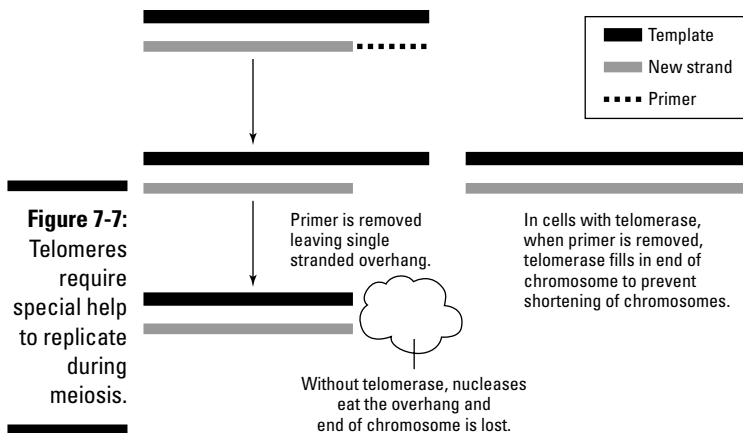

Telomerase easily detects the unreplicated telomere because telomeres have long sections of guanines, or Gs. Telomerase contains a section of cytosine-rich RNA, allowing the enzyme to bind to the unreplicated guanine-rich telomere. Telomerase then uses its own RNA to extend the unreplicated DNA template by about 15 nucleotides. Scientists suspect that the single-stranded template then folds back on itself to provide a free OH tail to replicate the rest of the telomere in the absence of a primer (see “Priming the pump” earlier in this chapter).

Finishing the job

Your DNA (and that of all eukaryotes) is tightly wound around special proteins called *nucleosomes* (not to be confused with nucleotides) so that the enormous molecule fits neatly into the cell nucleus. (Take a look at Chapter 6 for the details on just how big a molecule of DNA really is.) Like replication, packaging DNA is a very rapid process. It happens so quickly that scientists aren't exactly sure how DNA gets unwrapped from the nucleosomes to replicate and then gets wrapped around the nucleosomes again.

In the packaging stage, DNA is normally twisted tightly around hundreds of thousands of nucleosomes, much like string wrapped around beads. The whole “necklace” gets wound very tightly around itself in a process called *supercoiling*. Supercoiling is what allows the 3.5 billion base pairs of DNA that make up your 46 chromosomes to fit inside the microscopic nuclei of your cells. Altogether, about 150 base pairs of DNA are wrapped around each nucleosome and secured in place with a little protein called a *histone*. In Figure 7-8, you can see the nucleosomes, histones, and supercoiled “necklace.”

DNA is packaged in this manner both before and after replication. Because only 30 or 40 base pairs of DNA are exposed between nucleosomes, the DNA must be removed from the nucleosomes in order to replicate. If it isn't removed from the nucleosomes, the enzymes used in replication aren't able to access the entire molecule.

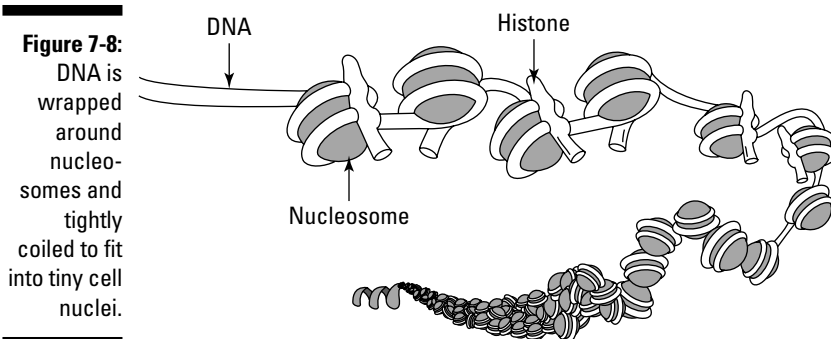



As helicase opens up the DNA molecule during replication, an unidentified enzyme strips off the nucleosome beads at the same time. As soon as the DNA is replicated, the DNA (both old and new) is immediately wrapped around waiting nucleosomes. Studies show that the old nucleosomes (from before replication) are reused along with newly assembled nucleosomes to package the freshly replicated DNA molecule.

How Circular DNAs Replicate

Circular DNAs are replicated in three different ways, as shown in Figure 7-9. Different organisms take different approaches to solve the problem of replicating hoop-shaped chromosomes. Theta replication is used by most bacteria, including *E. coli*. Viruses use rolling circle replication to rapidly manufacture vast numbers of copies of their genomes. Finally, human mitochondrial DNA and the chloroplast DNA of plants both use D-loop replication.

Theta

Theta replication refers to the shape the chromosome takes on during the replication process. After the helix splits apart, a bubble forms, giving the chromosome a shape reminiscent of the Greek letter theta Θ (see Figure 7-9). Bacterial chromosomes have only one origin of replication (see “Splitting the helix”), so after helicase opens the double helix, replication proceeds in both directions simultaneously, rapidly copying the entire molecule. As I describe in the section “Leading and lagging,” leading and lagging strands form, and ligase seals the gaps in the newly synthesized DNA to complete the strands. Ultimately, theta replication produces two intact, double-stranded molecules.

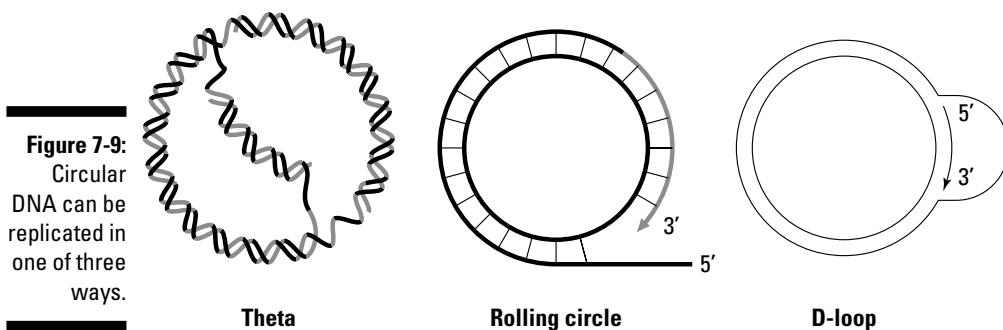

Rolling circle

Rolling circle replication creates an odd situation. No primer is needed because the double-stranded template is broken at the origin to provide a free OH tail to start replication. As replication proceeds, the inner strand is copied continuously as a leading strand (see Figure 7-9). Meanwhile, the broken strand is stripped off. As soon as enough of the broken strand is freed, a primer is laid down so replication can occur as the broken strand is stripped away from its complement. Thus, rolling circle replication is continuous on one strand and lagging on the other. As soon as replication is completed for one copy of the genome, the new copies are used as templates for additional rounds of replication. Viral genomes are often very small (only a few thousand base pairs), so rolling circle replication is an extremely rapid process that produces hundreds of thousands of copies of viral DNA in only a few minutes.

D-loop

Like rolling circle replication, *D-loop replication* creates a displaced, single strand (see Figure 7-9). Helicase opens the double-stranded molecule, and an RNA primer is laid down, displacing one strand. Replication then proceeds around the circle, pushing the displaced strand off as it goes. The intact, single strand is released and used as a template to synthesize a complementary strand.

Chapter 8

RNA: Like DNA but Different

In This Chapter

- ▶ Picking out the chemical components of RNA
- ▶ Meeting the various RNA molecules
- ▶ Transcribing DNA's message into RNA

DNA is the stuff of life. Practically every organism on earth relies on DNA to store genetic information and transmit it from one generation to the next. The road from genotype (building plans) to phenotype (physical traits) begins with *transcription* — making a special kind of copy of DNA. DNA's so precious and vital to eukaryotes (organisms made up of cells with nuclei) that it's kept packaged in the cell nucleus, like a rare document that's copied but never removed from storage. Because it can't leave the safety of the nucleus, DNA directs all the cell's activity by delegating responsibility to another chemical, RNA. RNA carries messages out of the cell nucleus into the cytoplasm (visit Chapter 2 for more about navigating the cell) to direct the production of proteins during translation, a process you find out more about in Chapter 9.

You Already Know a Lot about RNA

If you read Chapter 6, in which I cover DNA at length, you already know a lot about *ribonucleic acid*, or RNA. From a chemical standpoint, RNA's very simple. It's composed of:

- ✓ Ribose sugar (instead of deoxyribose, which is found in DNA)
- ✓ Four nucleotide bases (three you know from DNA — adenine, guanine, and cytosine — plus an unfamiliar one called uracil)
- ✓ Phosphate (the same phosphate found in DNA)



RNA has three major characteristics that make it different from DNA:

- ✓ RNA is very unstable and decomposes rapidly.
- ✓ RNA contains uracil in place of thymine.
- ✓ RNA is almost always single-stranded.

Using a slightly different sugar

Both RNA and DNA use a *ribose* sugar as a main element of their chemical structures. The ribose sugar used in DNA is deoxyribose (find out more about this sugar in Chapter 6). RNA, on the other hand, uses unmodified ribose. Take a careful look at Figure 8-1. You can see that three spots on ribose are marked with numbers. (On ribose sugars, numbers are followed by an apostrophe ['] to indicate the designation “prime;” see Chapter 6 for more information.) Ribose and deoxyribose both have an oxygen (O) atom and a hydrogen (H) atom (an OH group) at their 3' sites.

OH groups are also called *reactive groups* because oxygen atoms are very aggressive from a chemical standpoint (so aggressive that some chemists say they “attack” incoming atoms). The 3' OH tail is required for phosphodiester bonds to form between nucleotides in both ribose and deoxyribose atoms, thanks to their aggressive oxygen atoms. (For the scoop on how phosphodiester bonds form during replication, see Chapter 7.)

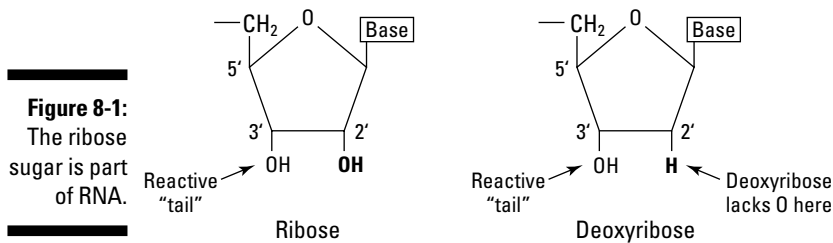

The difference between the two molecules is the absence (with deoxyribose) or presence (with ribose) of an oxygen atom at the 2' spot. One oxygen atom has a huge hand in the differing purposes and roles of DNA and RNA:

- ✓ **DNA:** DNA is such an important molecule that it must be protected from decomposition. The absence of one oxygen atom is part of the key to extending DNA's longevity. When the 2' oxygen is missing, as in deoxyribose, the sugar molecule is less likely to get involved in chemical reactions (because oxygen is chemically aggressive); by being aloof, DNA avoids being broken down.
- ✓ **RNA:** RNA is easily decomposed because its reactive 2' OH tail introduces RNA into chemical interactions that break the molecule up. Unlike DNA, RNA is a short-term tool the cell uses to send messages and manufacture proteins as part of gene expression (which I cover in Chapter 9). Messenger RNAs (mRNAs) carry out the actions of genes, turning them off and on again when needed. Put simply, to turn a gene “on,” mRNAs

have to be made, and to turn a gene “off,” the mRNAs that turned it “on” have to be removed. So, the 2' OH tail is a built-in mechanism that allows RNA to be decomposed, or *removed*, rapidly and easily when the message is no longer needed and the gene needs to be turned “off” (see Chapter 10 for more on turning genes off and on).

Meeting a new base: Uracil

RNA is composed of four nucleotide bases. Three of the four bases may be quite familiar to you because they're also part of DNA: adenosine (A), guanine (G), and cytosine (C). The fourth base, uracil (U), is found only in RNA. (In DNA, the fourth base is thymine. See Chapter 6 for details.) RNA's bases are pictured in Figure 8-2.

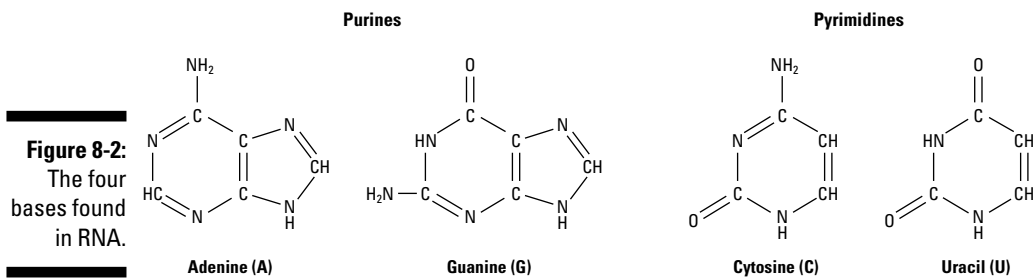

Uracil may be new to you, but it's actually the precursor of DNA's thymine. When your body produces nucleotides, uracil is hooked up with a ribose and three phosphates to form a ribonucleoside triphosphate (rNTP). (Check out Figure 8-5 later in the chapter to see an rNTP.) If DNA is being replicated, or copied (see Chapter 7 for the details on DNA's copying process), deoxyribonucleotide triphosphates (dNTPs) of thymine — not uracil — are needed, meaning that a few things have to happen:

- ✓ The 2' oxygen must be removed from ribose to make deoxyribose.
- ✓ A chemical group must be added to uracil's ring structure (all the bases are rings; see Chapter 6 for details on how these rings stack up). Folic acid, otherwise known as vitamin B9, helps add a carbon and three hydrogen atoms (CH₃, referred to as a *methyl group*) to uracil to convert it to thymine.

Uracil carries genetic information in the same way thymine does, as part of sequences of bases. (In fact, the genetic code that's translated into protein is written using uracil; see Chapter 9 for more on the genetic code.)



The complementary base pairing rules that apply to DNA (see Chapter 6) also apply to RNA: purines with pyrimidines, that is G with C, and A with U. So why are there two versions of essentially the same base (uracil and thymine)?

- ✓ Thymine protects the DNA molecule better than uracil can because that little methyl group (CH_3) helps make DNA less obvious to chemicals called *nucleases* that chew up both DNA and RNA. Nucleases are enzymes (chemicals that cause reactions to occur) that act on nucleic acids (see Chapter 6 for why DNA and RNA are called nucleic acids). Your body uses nucleases to attack unwanted RNA and DNA molecules (such as viruses and bacteria), but if methyl groups are present, nucleases can't bond as easily with the nucleic acid to break its chains. (The methyl group also makes DNA hydrophobic; see Chapter 6 for why DNA is afraid of water.)
- ✓ Uracil is a very friendly base; it easily bonds with the other three bases to form pairs. Uracil's amorous nature is great for RNA, which needs to form all sorts of interesting turns, twists, and knots to do its job (see the next section, "Stranded!"). DNA's message is too important to trust to such an easygoing base as uracil; strict base pairing rules must be followed in order to protect DNA's message from mutation (see Chapter 13 for more on how base pair rules protect DNA's message from getting garbled). Thymine, as uracil's less friendly near-twin, only bonds with adenine, making it perfectly suited to protect DNA's message.



Interfering RNAs

The process of linking genes with their functions used to be an arduous task. Until recently, scientists had to use "knockout" organisms to tease out the functions of genes one at a time. The process involved isolating a gene and disabling its function by introducing a mutation (see Chapter 13). The disabled gene was then engineered into a living organism, such as a mouse, to study the consequences of losing the function of the particular gene that was being studied. (See Chapter 19 for how genetically modified organisms are created.) As soon as the defect was spotted, the original function of the unmodified gene could be determined. But the discovery of *RNA interference* is changing the way genetics does business.

Geneticists can isolate cell mRNA without knowing what the mRNA codes for or which gene it comes from. Scientists then design special RNAs called RNAi, for *RNA interference*, that match the mRNAs. When it's introduced into the cell, RNAi destroys matching, naturally produced mRNAs before they can be translated by the ribosomes. In a groundbreaking study of gene function in roundworms, researchers introduced RNAi by simply feeding it to adult worms. Once in place, the RNAi halts all translation of the target mRNAs, thus temporarily "knocking out" the gene. When genes are turned off in this way, the disruption reveals to scientists the original gene function. By comparing the sequence of the "knocked out" mRNA to DNA, researchers can very rapidly locate and assign functions to thousands of genes.

Stranded!

RNA is almost always single-stranded, and DNA is always double-stranded. The double-stranded nature of DNA helps protect its message and provides a simple way for the molecule to be copied during replication. Like DNA, RNA loves to hook up with complementary bases. But RNA is a bit narcissistic; it likes to form bonds with itself (see Figure 8-3), creating what's called a *secondary structure*. The primary structure of RNA is the single-stranded molecule; when the molecule bonds with itself and gets all twisted and folded up, the result is the secondary structure.

Three major types of RNA carry out the business of expressing DNA's message. Although all three RNAs function as a team during translation (covered in Chapter 9), the individual types carry out very specific functions.

- ✓ **mRNA:** Regulates how genes are expressed
- ✓ **tRNA:** Carries amino acids around during translation (see Chapter 9 for more on translation)
- ✓ **rRNA:** Puts amino acids together in chains (see Chapter 9 for more on rRNA's role during translation)

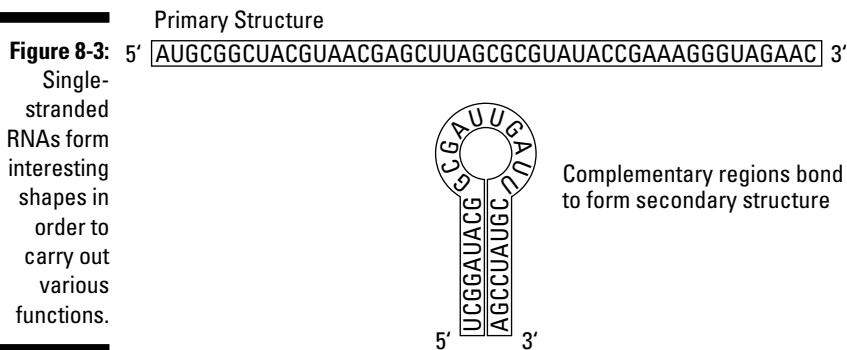

Transcription: Copying DNA's Message into RNA's Language

A *transcript* is record of something, not an exact copy. In genetics, *transcription* is the process of recording part of the DNA message in a related, but different, language — the language of RNA. (To review differences between DNA and RNA, jump back to “You Already Know a Lot about RNA,” earlier in this chapter.) Transcription is necessary because DNA is too valuable to be moved or

tampered with. The DNA molecule is *the* plan, and any error that's introduced into the plan (as a mutation, which I address in Chapter 13) causes lots of problems. If part or all of the DNA molecule were lost, the cell would die (flip to Chapter 14 for more on cell death). Transcription keeps DNA safe by letting a temporary RNA copy take the risk of leaving the cell nucleus and going out into the cytoplasm.



Messenger RNAs (mRNAs) are the specific type of RNA responsible for carrying DNA's message from the cell nucleus into the cytoplasm (check out Chapter 2 for a review of cell parts).

With *transcription*, the DNA inside the nucleus goes through a process similar to *replication* (see Chapter 7) to get the message out as RNA. When DNA is replicated, the result is another DNA molecule that's exactly like the original in every way. But in transcription, many mRNAs are created because, instead of transcribing the entire DNA molecule, only messages of genes are transcribed into mRNA. Transcription has several steps:

1. Enzymes identify the right part of the DNA molecule to transcribe (see "Getting ready to transcribe").
2. The DNA molecule is opened up to make the message accessible (see "Initiation").
3. Enzymes build the mRNA strand (see "Elongation").
4. The DNA molecule snaps shut to release the newly synthesized mRNA (see "Termination").

Getting ready to transcribe

In preparing to transcribe DNA into mRNA, three things need to be completed:

- ✓ Locate the proper gene sequence within the billions of bases that make up DNA
- ✓ Determine which of the two strands of DNA to transcribe
- ✓ Gather up the nucleotides of RNA and the enzymes needed to carry out transcription

Locating the gene

Your chromosomes are made up of roughly 3 billion base pairs of DNA and contain somewhere between 25,000 and 30,000 genes (see Chapter 11). But only about 1 percent of your DNA gets transcribed into mRNA. Genes, the sequences that do get transcribed, vary in size. The average gene is only about 3,000 base pairs long, but the human genome also has some gigantic genes — for example, the gene that's implicated in a particular form of muscular dystrophy (Duchenne) is a whopping 2.5 million base pairs.



Before a gene of any size can be transcribed, it must be located. The cue that says “start transcription here” is written right into the DNA in regions called *promoters*. (The promoter also controls how often the process takes place; see the “Initiation” section later in the chapter.) The sequence that indicates where to stop transcribing is called a *terminator*. The whole thing, the gene along with the promoter and the terminator, is called the *transcription unit* (see Figure 8-4).

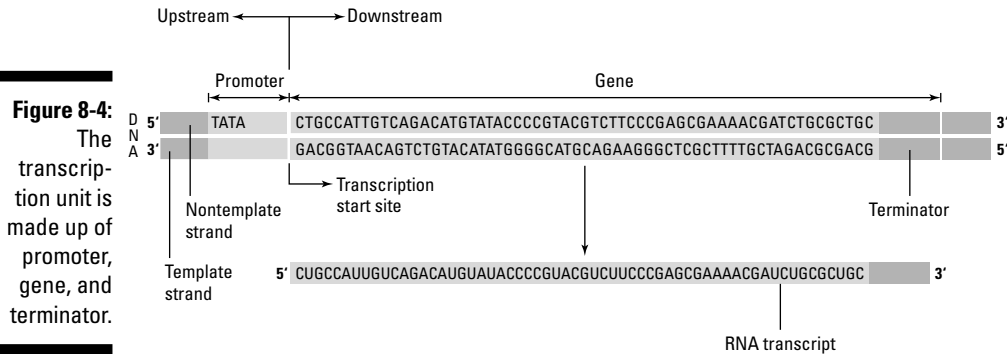

The promoter sequences tell the enzymes of transcription where to start work and are located within 30 or so base pairs of the genes they control. Each gene has its own promoter. In eukaryotes, the sequence of the promoter is always the same, and it’s called the *TATA box* because the sequence of the bases is TATAAA. The presence of TATA tells the transcription-starting enzyme that the gene to transcribe is about 30 base pairs away. Sequences, like TATA, that are the same in many (if not all) organisms are called *consensus sequences*, indicating that the sequences agree or mean the same thing everywhere they appear.

Locating the right strand: Sense and nonsense

By now you’ve (hopefully) picked up on the fact that DNA is double-stranded. Those double strands aren’t identical, though; they’re complementary, meaning that the sequence of bases matches up, but it doesn’t spell the same words of the genetic code (see Chapter 9 for genetic code info). The genetic code of DNA works like this: Bases of genes are read in three base sets, like words. For example, three adenines in a row (AAA) are transcribed into mRNA as three uracils (UUU). During translation, UUU tells the ribosome to use an amino acid called phenylalanine as part of the protein it’s making. If the complementary DNA, TTT, were transcribed, you’d wind up with an mRNA saying AAA, which specifies lysine. A protein containing lysine will function differently than one containing phenylalanine.



Because complements don’t spell the same genetic words, you can get two different messages depending on which strand of DNA is transcribed into mRNA. Therefore genes can only be read from *one* of the two strands of the double-stranded DNA molecule — but which one? The TATA box (the promoter; see

“Locating the gene”) not only indicates where a gene is but also tells which strand holds the gene’s information. TATA boxes indicate that a gene is about 30 bases away going in the 3’ direction (sometimes referred to as *downstream*). Genes along the DNA molecule run in both directions, but any given gene is transcribed only in the 3’ direction. Because only one strand is transcribed, the two strands are designated in one of two ways:

- ✓ **Template:** This strand provides the pattern for transcription.
- ✓ **Nontemplate:** This strand is the original message that’s actually being transcribed.

TATA is on the nontemplate strand and indicates that the other (complementary) strand is to be used as the template for transcription. Take a look at Figure 8-4 and compare the template to the RNA transcript — they’re complementary. Now compare the mRNA transcript to the nontemplate strand. The only difference between the two is that uracil appears in place of thymine. The RNA is the transcript of the nontemplate strand.



Because the strands have different meanings, the nontemplate makes sense as a transcript, and the template does not. Some scientists refer to the strands as “sense and nonsense” strands or sometimes “sense and antisense.” To complicate matters, not all scientists use the terms sense and nonsense in the same . . . sense. But if you stick to calling the two strands template and nontemplate, you can’t go wrong.

Gathering building blocks and enzymes

In addition to template DNA (see the preceding section), the following ingredients are needed for successful transcription:

- ✓ **Ribonucleotides**, the building blocks of RNA
- ✓ **Enzymes and proteins**, to assemble the growing RNA strand in the process of *RNA synthesis*

The building blocks of RNA are nearly identical to those used in DNA synthesis, which I explain in Chapter 7. The differences, of course, are that for RNA, ribose is used in place of deoxyribose, and uracil replaces thymine. Otherwise, the rNTPs (ribonucleoside triphosphates; see Figure 8-5) look very much like the dNTPs you’re hopefully already familiar with.

In a process similar to replication, transcription requires the services of various enzymes to:

- ✓ Find the promoter (see the “Locating the gene” section earlier)
- ✓ Open up the DNA molecule (see the “Initiation” section later)
- ✓ Assemble the growing strand of RNA (see the “Elongation” section later)

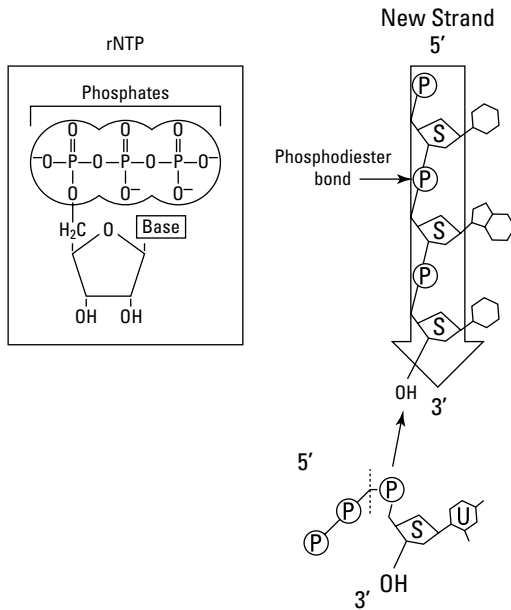

Figure 8-5:
The basic building block of RNA and the chemical structure of an RNA strand.

Unlike replication, though, transcription has fewer enzymes to keep track of. (You're welcome.) The main player is RNA polymerase. Like DNA polymerase (which you can meet in Chapter 7), *RNA polymerase* recognizes each base on the template and adds the appropriate complementary base to the growing RNA strand, substituting uracil where DNA polymerase would supply thymine. RNA polymerase hooks up with a large group of enzymes — called a *holoenzyme* — to carry out this process. The individual enzymes making up the holoenzyme vary between prokaryotes and eukaryotes, but their functions remain the same: to recognize and latch onto the promoter and to call RNA polymerase over to join the party.



Eukaryotes have three kinds of RNA polymerase, which vary only in which genes they transcribe.

- ✓ RNA polymerase I takes care of long rRNA molecules.
- ✓ RNA polymerase II carries out the synthesis of most mRNA and some tiny, specialized types of RNA molecules that are used in RNA editing after transcription is over (see “Post-transcription Processing” later in this chapter).
- ✓ RNA polymerase III transcribes tRNA genes and other small RNAs used in RNA editing.

Initiation

Initiation includes finding the gene and opening up the DNA molecule so that the enzymes can get to work. The process of initiation is pretty simple:

- 1. The holoenzyme (group of enzymes that hook up with RNA polymerase) finds the promoter.**

The promoter of each gene controls how often transcription makes an mRNA transcript to carry out the gene's action. RNA polymerase can't bind to a gene that isn't scheduled for transcription. In eukaryotes, *enhancers*, which are sequences sometimes distantly located from the transcription unit, also control how often a particular gene is transcribed. To find out more about how genes are turned on, flip to Chapter 10.

- 2. RNA polymerase opens up the double-stranded DNA molecule to expose a very short section of the template strand.**

When the promoter “boots up” to initiate transcription, the holoenzyme complex binds to the promoter site and signals RNA polymerase. RNA polymerase binds to the template at the start site for transcription. RNA polymerase can't “see” past the sugar-phosphate backbone of DNA, so transcription can't occur if the molecule isn't first opened up to expose single strands. RNA polymerase melts the hydrogen bonds between the double-stranded DNA molecule and opens up a short stretch of the helix to expose the template. The opening created by RNA polymerase when it wedges its way between the two strands of the helix is called the *transcription bubble* (see Figure 8-6).

- 3. RNA polymerase strings together rNTPs to form mRNA (or one of the other types of RNA, such as tRNA or rRNA).**

RNA polymerase doesn't need a primer to begin synthesis of a new mRNA molecule (unlike DNA replication; see Chapter 7 for details). RNA polymerase simply reads the first base of the transcription unit and lays down the appropriate complementary rNTP. This first rNTP doesn't lose its three phosphate molecules because no phosphodiester bond is formed at the 5' side. Those two extra phosphates remain until the mRNA is edited later in the transcription process (see “Post-transcription Processing” later in this chapter).

Elongation

After RNA polymerase puts down the first rNTP, it continues opening the DNA helix and synthesizing mRNA by adding rNTPs until the entire transcriptional unit is transcribed. The transcription bubble (the opening between DNA strands) itself is very small; only about 20 bases of DNA are exposed at a time. So as RNA polymerase moves down the transcription unit, only the part of the template that's actively being transcribed is exposed. The helix snaps

shut as RNA polymerase steams ahead to push the newly synthesized mRNA molecule off the template (see Figure 8-6). An enzyme like gyrase (see Chapter 7) probably works to keep the DNA molecule from getting knotted up during the opening, transcribing, and closing process (but scientists aren't certain at this point).

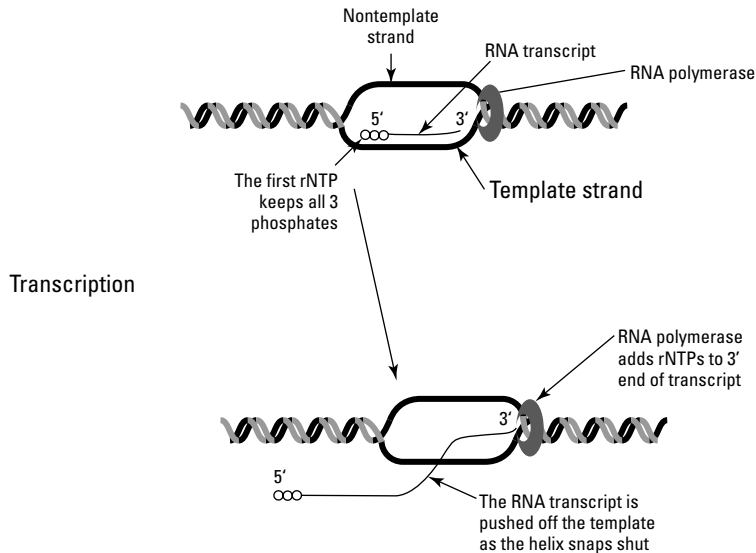

Figure 8-6:
Transcribing
DNA's
message
into RNA.

Like the human genome as a whole (see Chapter 11), the transcriptional units of genes contain sequences that appear to be “junk.” These parts of the gene aren't translated into protein and therefore don't code for phenotype (physical traits). As you may expect, geneticists have come up with terms for the “junk” parts and the “useful” parts:

- ✔ **Introns:** Noncoding sequences that get their name from their *intervening* presence. Genes often have many introns that fall between the parts of the gene that actually code for phenotype.
- ✔ **Exons:** Coding sequences that get their name from their *expressed* nature.

The entire gene — introns and exons — is transcribed (see Figure 8-6). After transcription has terminated, part of the editing process is the removal of introns. The process of snipping out introns and splicing together exons is covered in the section “Editing the message,” later in this chapter.



Prokaryotes don't have introns because prokaryotic genes are all coding, or exon. Only eukaryotes have genes interrupted by intron sequences. Almost all eukaryotic genes have at least one intron; the maximum number of introns in any one gene is 200. Scientists don't fully understand the function of introns, but they likely have something to do with how different mRNAs are edited.

Termination

When RNA polymerase encounters the terminator (as a sequence in the DNA, not the scary, gun-toting movie character), it transcribes the terminator sequence and then stops transcription. What happens next varies depending upon the organism.

- ✓ In prokaryotic cells, some terminator sequences have a series of bases that are complementary and cause the mRNA to fold back on itself. The folding stops RNA polymerase from moving forward and pulls the mRNA off the template.
- ✓ In eukaryotic cells, a special protein called a *termination factor* aids RNA in finding the right stopping place.

In any event, after RNA polymerase stops adding rNTPs, the mRNA gets detached from the template. The holoenzyme and RNA polymerase let go of the template, and the double-stranded DNA molecule snaps back into its natural helix shape.

Post-transcription Processing

Before mRNA can venture out of the cell nucleus and into the cytoplasm for translation, it needs a few modifications. And I just happen to cover them in the following sections.

Adding cap and tail

The “naked” mRNA that’s produced by transcription needs to get dressed before translation:

- ✓ A 5’ cap is added.
- ✓ A long tail of adenine bases is tacked on.

RNA polymerase starts the process of transcription by using an unmodified rNTP (see the section “Initiation” earlier in this chapter). But a 5’ cap needs to be added to the mRNA to allow the ribosome to recognize it during translation (see Chapter 9 for more on translation). The first part of adding the cap is the removal of one of the three phosphates from the leading end of the mRNA strand. A guanine, in the form of a ribonucleotide, is then attached to the lead base of the mRNA. (Figure 8-7 illustrates the process of cap and tail attachment to the mRNA.) Several groups composed of a carbon atom with three hydrogen atoms (CH_3 , called a methyl group) attach at various sites — on the guanine and on the first and second nucleotides of the

mRNA. Like the methyl groups that protect the thymine-bearing DNA molecule, the methyl groups at the 5' end of the mRNA protect it from decomposition as well as allow the ribosome to recognize the mRNA as ready for translation.

In eukaryotes, a long string of adenines are added onto the 3' end of the mRNA to further protect the mRNA from natural nuclease activity long enough to get translated (see Figure 8-7). This string is called the *poly-A tail*. RNA molecules are easily degraded and destroyed because of their temporary natures. Like memos, RNA molecules are linked to a specific task, and when the task is over, the memo is discarded. But the message has to last long enough to be read, sometimes more than once, before it hits the shredder (in this case, nucleases do the shredding instead of guilty business executives). The length of the poly-A tail determines how long the message lasts and how many times it can be translated by the ribosomes before nucleases eat the tail and destroy the message.

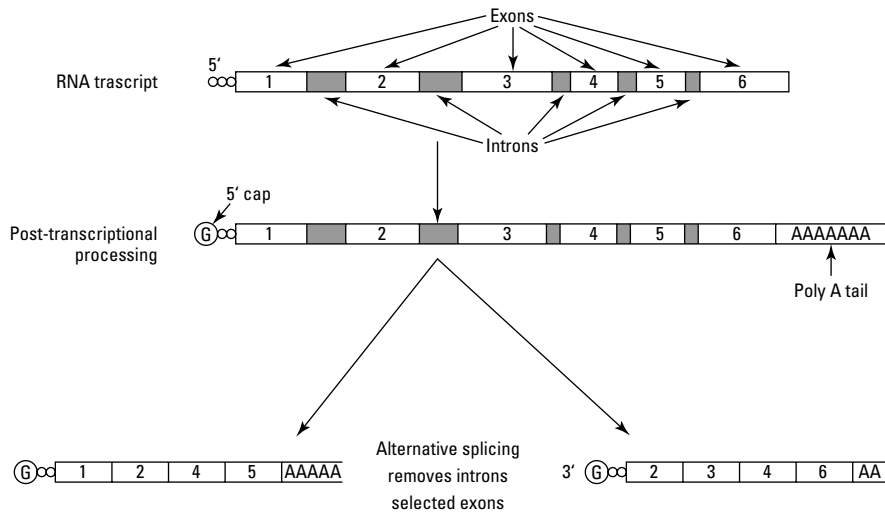

Figure 8-7:
Capping
things off.

Editing the message

The final step in preparing mRNA for translation is twofold: removing the noncoding intron sequences and stringing the exons together without interruptions between them. Several specialized types of RNA work to find the start and end points of introns, pull the exons together, and snip out the extra RNA (that is, the intron).

While it's still in the nucleus, a complex of proteins and small RNA molecules called a *spliceosome* inspect the newly manufactured mRNA. The spliceosome is like a roaming workshop that recognizes introns and works to remove them

from between exons. The spliceosome recognizes consensus sequences that mark the beginnings and endings of introns (take a look back at “Locating the gene” to review consensus sequences). The spliceosome grabs each end of the intron and pulls the ends toward each other to form a loop. This movement has the effect of bringing the beginning of one exon close to the end of the preceding one. The spliceosome then snips out the intron and hooks the exons together in a process called *splicing*. Splicing creates a phosphodiester bond between the two exon sequences, which seals them together as one strand of mRNA.



Some introns have the ability to remove themselves from the mRNA strand without the help of the spliceosome. The process is similar to the spliceosome's — the intron forms a loop, snips itself out, and splices the exons together.

Introns can be spliced out leaving all the exons in their original order, or introns *and* exons can be spliced out to create a new sequence of exons (see Figure 8-6 for a couple of examples). The splicing of introns and exons is called *alternative splicing* and results in the possibility for one gene to be expressed in different ways. Thanks to alternative splicing, the 30,000 or so genes in humans are able to produce around 90,000 different proteins.



The secret to the genetic flexibility of alternative splicing is sequences called *Alu elements*. *Alu* elements are fairly short sequences that show up all over the human genome (see Chapter 11 for how scientists are exploring the human genome) — there may be as many as 1 million copies of *Alu* in your DNA. *Alu* can be spliced into or out of genes (sometimes more than once) to create alternative forms of mRNA from the same original gene sequence. This sequence formerly known as “junk DNA” turns out to act as an exon. The enormous versatility of RNA editing has led some scientists to think of RNA as “the” genetic material instead of DNA.

After the introns are spliced and all the exons are strung together, the mRNA molecule is complete and ready for action. It migrates out of the cell nucleus, encounters an army of ribosomes, and goes through the process of translation — the final step in converting the genetic message from DNA to protein.

Chapter 9

Translating the Genetic Code

In This Chapter

- ▶ Exploring the features of the genetic code
- ▶ Translating genetic information into phenotype
- ▶ Molding polypeptides into functional proteins

From the building instructions to implementation, the message carried by DNA follows a very predictable path. First, DNA provides the template for transcription of the message into RNA. Then, RNA (in the form of messenger RNA) moves out of the cell nucleus and into the cytoplasm to provide the building plans for *proteins*. Every living thing is made of proteins, which are long chains of amino acids, called *polypeptides*, that are folded into complex shapes and hooked together in innovative ways.

All the physical characteristics (that is, the phenotype) of your body are made up of thousands of different proteins. Of course, your body is also composed of other things, too, like water, minerals, and fats. But *proteins* supply the framework to organize all those other building blocks, and *proteins* carry out all the functions that your body needs to undergo, like digestion, respiration, and elimination.

In this chapter, I explain how RNA provides the blueprint for manufacturing proteins, the final step in the transformation from genotype (genetic information) to phenotype. Before you can dive into the translation process, you need to know a few things about the genetic code — the information carried by mRNA — and how the code is read. If you skipped over Chapter 8, you may want to go back and review its material on RNA before moving on.

Discovering the Good in a Degenerate

When Watson and Crick (along with Rosalind Franklin; see Chapter 6 for the full scoop) discovered that DNA is made up of two strands composed of four bases, the big question they faced was: How can only four bases contain enough information to encode complex phenotypes?



Complex phenotypes (such as your bone structure, eye color, and ability to digest spicy food) are the result of combinations of proteins. The genetic code (that is, DNA transcribed as RNA; see Chapter 8) provides the instructions to make these proteins (via translation; covered in “Meeting the Translating Team” later in this chapter). *Proteins* are made up of long chains of amino acids. A total of twenty amino acids are found in proteins. These amino acids are strung together in various combinations to create chains called *polypeptides* (which is a fancy way of saying “protein”). Polypeptide chains can vary from 50 to 1,000 amino acids in length. Because there are 20 different amino acids and because chains are often more than 100 amino acids in length, the variety of combinations is enormous. For example, a polypeptide that’s only 5 amino acids long has 3,200,000 combinations!

After experiments showed that DNA was truly the genetic material (see Chapter 6), skeptics continued to point to the simplicity of the four bases found in RNA and argued that a code of four bases wouldn’t work to encode complex peptides. Reading the genetic code one base at a time — U, C, A, and G — would mean that there simply aren’t enough bases to make 20 amino acids. So, it was obvious to scientists that the code must be made up of multiple bases read together. A two-base code didn’t work because it only produced 16 combinations — too few to account for 20 amino acids. A three-base code (referred to as a *triplet code*) looked like overkill because a *codon*, which is a combination of three nucleotides in a row, that chooses from four bases at each position produces 64 possible combinations. Skeptics argued that a triplet code contained too much redundancy — after all, there are only 20 amino acids.

As it turns out, the genetic code is *degenerate*, which is a fancy way of saying “too much information.” Normally, degenerate means something to the effect of “bad and getting worse” (it’s usually used to describe some people — I won’t name names). In the genetic sense, the degeneracy of the triplet code means that the code’s highly flexible and tolerates some mistakes — which is a good thing.



Several features of the genetic code are important to keep in mind. The code is

- ✓ **Triplet**, meaning bases are read three at a time in codons.
- ✓ **Degenerate**, meaning 18 of the 20 amino acids are specified by two or more codons (see the next section, “Considering the combinations”).
- ✓ **Orderly**, meaning each codon is read in only one way and in only one direction, just as English is read left to right (see “Framed! Reading the code” later in this chapter).
- ✓ **Nearly universal**, meaning just about every organism on earth interprets the language of the code in exactly the same way (see “Not quite universal” for exceptions).

Considering the combinations

Only 61 of the 64 codons are used to specify the 20 amino acids found in proteins. The three codons that don't code for any amino acid simply spell "stop," telling the ribosome to cease the translation process (see "Termination" later in this chapter). In contrast, the one codon that tells the ribosome that an mRNA is ripe for translating — the "start" codon — codes for an amino acid, methionine. (The "start" amino acid comes in a special form; see "Initiation" later in this chapter.) In Figure 9-1, you can see the entire code with all the alternative spellings for the 20 amino acids. (See "Meeting the Translating Team" later in this chapter for more details about amino acids.)

As you can see in Figure 9-1, the number of alternative spellings for the different amino acids varies from one (methionine and tryptophan) to as many as six (leucine and serine).

First Letter ↓	Second Letter				Third Letter ↓
	U	C	A	G	
U	phenylalanine	serine	tyrosine	cysteine	U
	phenylalanine	serine	tyrosine	cysteine	C
	leucine	serine	STOP	STOP	A
	leucine	serine	STOP	tryptophan	G
C	leucine	proline	histidine	arginine	U
	leucine	proline	histidine	arginine	C
	leucine	proline	glutamine	arginine	A
	leucine	proline	glutamine	arginine	G
A	isoleucine	threonine	asparagine	serine	U
	isoleucine	threonine	asparagine	serine	C
	isoleucine	threonine	lysine	arginine	A
	methionine & START	threonine	lysine	arginine	G
G	valine	alanine	aspartate	glycine	U
	valine	alanine	aspartate	glycine	C
	valine	alanine	glutamate	glycine	A
	valine	alanine	glutamate	glycine	G

Figure 9-1:
The 64 codons of the genetic code, as written by mRNA.

For many of the amino acids, the alternative spellings differ only by one base — the third base of the codon. For example, four of the six spellings for leucine start with the bases CU. This flexibility at the third position of the codon is called a *wobble*. The third base of the mRNA can vary, or wobble, without changing the meaning of the codon and thus the amino acid it codes for. The wobble is possible because of the way tRNAs (transfer RNAs) and mRNAs pair up during the process of translation. The first two bases of the code on the mRNA and the partner tRNA (which is carrying the amino acid specified by the codon) must be exact matches. However, the third base of the tRNA can break the base pairing rules, allowing bonds with mRNA bases other than the usual complements. This rule violation, or wobble, allows for different spellings to code for the same amino acid. However, some codons, like one of the three stop codons (spelled UGA), have only one meaning; wobbles in this stop codon change the meaning from stop to either cysteine (spelled UGU or UGC) or tryptophan (UGG).

Framed! Reading the code

Besides its combination possibilities, another important feature of the genetic code is the way in which the codons are read. Each codon is separate, with no overlapping. And the code doesn't have any punctuation either — it's read straight through without pauses.

The codons of the genetic code run sequentially, as you can see in Figure 9-2. Each codon is read only once using a *reading frame*. A reading frame is a series of sequential, nonoverlapping codons. The position of the reading frame is defined by the *start codon*. In the mRNA pictured in Figure 9-2, the sequence AUG, which spells methionine, is a start codon. After the start codon, the bases are read three at a time without a break until the stop codon is reached. (Mutations often disrupt the reading frame by inserting or removing one base; see Chapter 13 for more details.)

Figure 9-2:
The genetic code is non-overlapping and uses a reading frame.

Nucleotide sequence	A U G C G A G U C U U G C A G . . .
Nonoverlapping code	<u>A U G</u> <u>C G A</u> <u>G U C</u> <u>U U G</u> <u>C A G</u> . . .
	1 2 3 4 5

Not quite universal

The meaning of the genetic code is nearly universal. That means nearly every organism on earth uses the same spellings in the triplet code. Mitochondrial DNA spells a few words differently than nuclear DNA, which may explain or at least relate back to mitochondria's unusual origins (see Chapter 6). Plants, bacteria, and a few microorganisms also use unusual spellings for one or more amino acids. Otherwise, the way the code is read — influenced by its degenerate nature, with wobbles, without punctuation, and using a specific reading frame — is the same. As scientists tackle DNA sequencing for various creatures (see Chapter 11), more unusual spellings are likely to pop up.

Meeting the Translating Team

Translation is the process of converting information from one language into another. In this case, the genetic language of nucleic acid is translated into the language of protein. Translation takes place in the cytoplasm of cells. After messenger RNAs (mRNAs) are created through transcription and move into the cytoplasm, the protein production process begins (see Chapter 8 for the lowdown on mRNA). The players involved in protein production include:

- ✓ **Ribosome:** The big protein-making factory that reads mRNA's message and carries out the message's instructions. Ribosomes are made up of ribosomal RNA (rRNA) and are capable of constructing any sort of protein.
- ✓ **The genetic code:** The message carried by mRNA (see "Discovering the Good in a Degenerate Code" earlier in this chapter for more on the genetic code).
- ✓ **Amino acids:** Complex chemical compounds containing nitrogen and carbon; 20 amino acids strung together in thousands of unique combinations are used to construct proteins.
- ✓ **Transfer RNA (tRNA):** Runs a courier service to provide amino-acid building blocks to the working ribosome; each tRNA summoned by the ribosome grabs the amino acid specified by the codon.

Taking the Translation Trip

Translation proceeds in a series of predictable steps:

1. A ribosome recognizes an mRNA and latches onto its 5' cap (see Chapter 8 for an explanation of how and why mRNAs get caps). The ribosome slurps up the mRNA and carefully scrutinizes it, looking for *codons* that form the words of the genetic code beginning with the start codon.

2. tRNAs supply the amino acids dictated by each codon when the ribosome reads the instructions. The polypeptide chain is assembled by the ribosome with the help of various enzymes and proteins.
3. The ribosome continues to assemble the polypeptide chain until it reaches the stop codon. The completed polypeptide chain is released.

After it's released from the ribosome, the polypeptide chain is modified and folded to become a mature protein.

Initiation

Preparation for translation consists of two major events:

- ✓ The tRNA molecules must be hooked up with the right amino acids in a process called *charging*.
- ✓ The ribosome, which comes in two pieces, must assemble itself at the start codon of the mRNA.

Charge! tRNA hooks up with a nice amino acid

Transfer RNA (tRNA) molecules are small, specialized RNAs that are produced by transcription. However, unlike mRNAs, tRNAs are never translated into protein; tRNA's whole function is ferrying amino acids to the ribosomes for assembly into polypeptides. tRNAs are uniquely shaped to carry out their jobs. In Figure 9-3, you see two depictions of tRNA. The illustration on the left shows you tRNA's true form. The illustration on the right is a simplified version that makes tRNA's parts easier to identify. The cloverleaf shape is one of the keys to the way tRNA works. tRNA gets its unusual configuration because many of the bases in its sequence are complements; the strand folds, and the complementary bases form bonds, resulting in the loops and arms of a typical tRNA.

The two key elements of tRNA are:

- ✓ **Anticodon:** A three-base sequence on one loop of each tRNA; the anticodon is complementary to one of the codons spelled by mRNA.
- ✓ **Acceptor arm:** The single-stranded tail of the tRNA; where the amino acid corresponding to the codon is attached to the tRNA.



The codon of mRNA specifies the amino acid used during translation. The anticodon of the tRNA is complementary to the codon of mRNA and specifies which amino acid each tRNA is built to carry.



Every cell has between 30 and 50 different tRNA molecules. Each amino acid has its own tRNA, but some amino acids can be carried by more than one sort of tRNA. These flexible tRNAs are called *isoaccepting tRNAs*.

Figure 9-3: tRNA has a very unique shape that helps it ferry amino acids to the ribosomes.

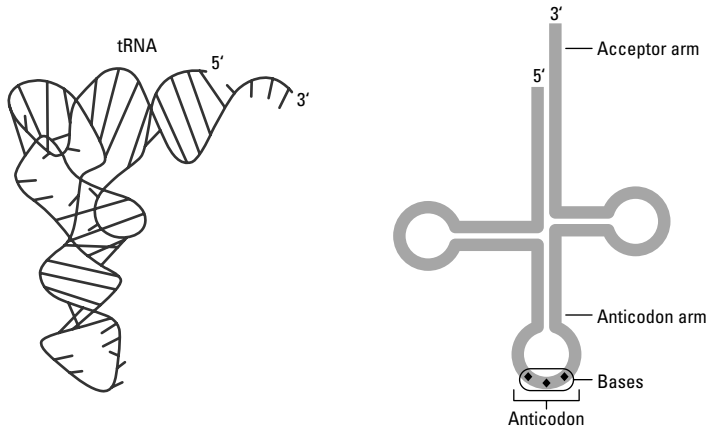

Like a battery, tRNAs must be charged in order to work. tRNAs get charged with the help of a special group of enzymes called *aminoacyl-tRNA synthetases*. Twenty synthetases exist, one for each amino acid specified by the codons of mRNA. Take a look the illustration on the right in Figure 9-3, the schematic of tRNA. The aminoacyl-tRNA synthetases recognize sequences of bases in the anticodon of the tRNA that announce which amino acid that particular tRNA is built to carry. When the aminoacyl-tRNA synthetase encounters the tRNA molecule that matches its amino acid, the synthetase binds the amino acid to the tRNA at the acceptor arm — this is the charging part. Figure 9-4 shows the connection of amino acid and tRNA. The synthetases proofread to make sure that each amino acid is on the appropriate tRNA. This proofreading ensures that errors in tRNA charging are very rare and prevents errors in translation later on. With the amino acid attached to it, the tRNA is charged and ready to make the trip to the ribosome.

Figure 9-4: tRNA charging.

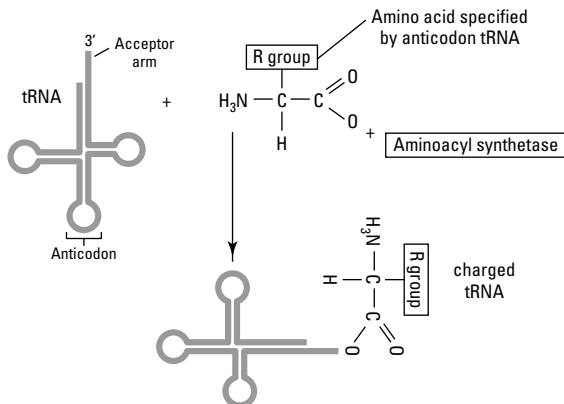

Putting the ribosome together

Ribosomes come in two parts called *subunits* (see Figure 9-5), and ribosomal subunits come in two sizes: large and small. The two subunits float around (sometimes together and sometimes as separate pieces) in the cytoplasm until translation begins. Unlike tRNAs, which match specific codons, ribosomes are completely flexible and can work with any mRNA they encounter. Because of their versatility, ribosomes are sometimes called the workbench of the cell.

When fully assembled, each ribosome has two sites and one slot:

- ✔ **A-site (acceptor site):** Where tRNA molecules insert their anticodon arms to match up with the codon of the mRNA molecule
- ✔ **P-site (peptidyl site):** Where amino acids get hooked together using peptide bonds
- ✔ **Exit slot:** Where tRNAs are released from the ribosome after their amino acids become part of the growing polypeptide chain

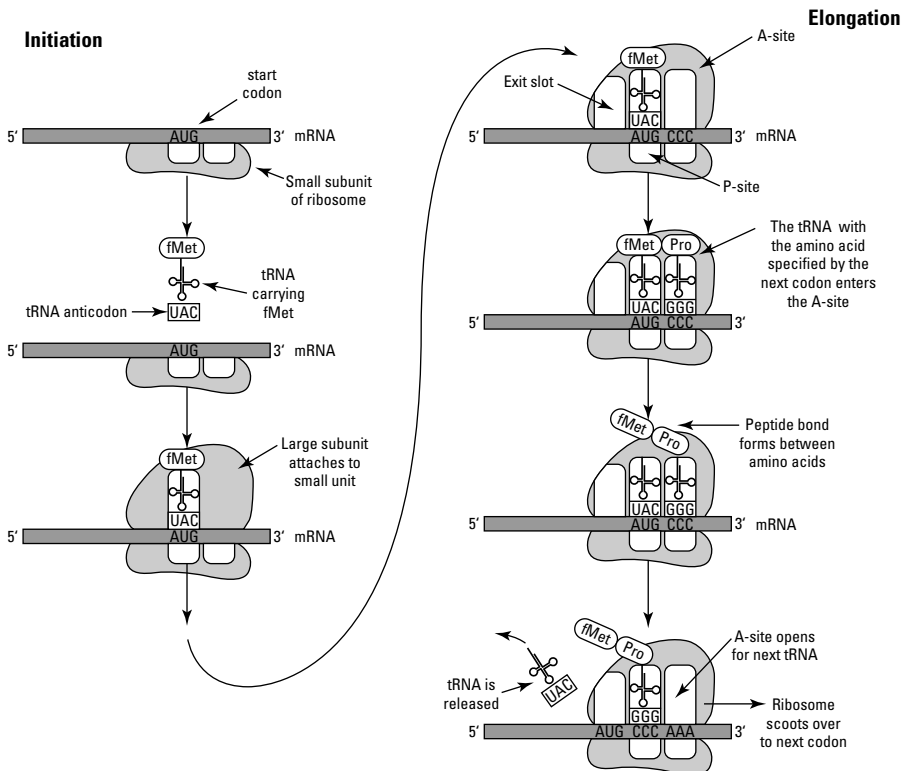

Figure 9-5:
Initiation
and
elongation.

Before translation can begin, the smaller of the two ribosome subunits recognizes and attaches to the 5' cap of the mRNA with the help of proteins called *initiation factors*. The small subunit then scoots along the mRNA until it hits the start codon (AUG). The P-site on the small ribosome subunit lines up with the start codon, and the small subunit is joined by the tRNA carrying methionine (UAC), the amino acid that matches the start codon. The “start” tRNA totes a special version of methionine called *fMet* (short for N-formylmethionine). This complex name refers to the fact that this is the only amino acid that can begin a polypeptide chain. Only the tRNA for fMet can attach to the ribosome at the P-site without first going through the A-site. The tRNA uses its anticodon, which is complementary to the codon of the mRNA, to hook up to the mRNA. The large ribosome subunit joins together with the small subunit to begin the process of hooking together all the amino acids specified by the mRNA (see Figure 9-5).

Elongation

When the initiation process is complete, translation proceeds in several steps called *elongation*, which you can follow in Figure 9-5.

1. The ribosome calls for the tRNA carrying the amino acid specified by the codon residing in the A-site. The appropriate charged tRNA inserts its anticodon arm into the A-site.
2. Enzymes bond the two amino acids attached to the acceptor arms of the tRNAs in the P- and A-sites.
3. As soon as the two amino acids are bonded, the ribosome scoots over to the next codon of the mRNA. The tRNA that was formerly in the P-site now enters the exit site, and because it's no longer charged with an amino acid, the empty tRNA is released from the ribosome. The A-site is left empty, and the P-site is occupied by a tRNA holding its own amino acid plus the amino acid of the preceding tRNA. The process of moving from one codon to the next is called *translocation* (not to be confused with the chromosomal translocations described in Chapter 15, where pieces of whole chromosomes are inappropriately swapped).



The ribosome continues to scoot along the mRNA in a 5' to 3' direction. The growing polypeptide chain is always attached to the tRNA that's sitting in the P-site, and the A-site is opened up over and over again to accept the next charged tRNA. The process comes to a stop when the ribosome encounters one of the three codons that specify “stop.” (For more on stop codons, see “Considering the combinations,” earlier in this chapter.)

Termination

No tRNAs match the stop codon, so when the ribosome reads “stop,” no more tRNAs enter the A-site (see Figure 9-6). At this point, a tRNA sits in the P-site with the newly constructed polypeptide chain attached to it by the tRNA’s own amino acid. Special proteins called *release factors* move in and bind to the ribosome; one of the release factors recognizes the stop codon and sparks the reaction that cleaves the polypeptide chain from the last tRNA. After the polypeptide is released, the ribosome comes apart, releasing the final tRNA from the P-site. The ribosomal subunits are then free to find another mRNA to begin the translation process anew. Transfer RNAs are recharged with fresh amino acids and can be used over and over. Once freed, polypeptide chains assume their unique shapes and sometimes hook up with other polypeptides to carry out their jobs as fully functioning proteins (see the “Proteins Are Precious Polypeptides” section later in the chapter).

Messenger RNAs may be translated more than once and, in fact, may be translated by more than one ribosome at a time. As soon as the start codon emerges from the ribosome after the initiation of translation, another ribosome may recognize the mRNA’s 5’ cap, latch on, and start translating. Thus, many polypeptide chains may be manufactured very rapidly.

Walking the Dogma

In other disciplines (say, physics), laws abound to describe the goings-on of the world. The law of gravity, for example, tolerates no violators. But genetics doesn’t have many laws because scientists keep acquiring new information. One exception is the *Central Dogma of Genetics*. Dogma isn’t law; rather, it’s more or less universally accepted opinion about how the world works. In this case, the Central Dogma of Genetics (coined by our old friend, Francis Crick, of DNA-discovery fame; see Chapter 6) says that the trip from genotype to phenotype is a one-way street. After RNA’s message is used to manufacture proteins through a process called *translation*, the operation can’t be reversed. Although we can infer what the RNA message must have been in order to make the resulting protein, we can’t convert the proteins themselves back into RNA.

Another idea that nearly attains the status of law is the *one gene–one polypeptide hypothesis*. *Polypeptides*, or as they’re more familiarly called proteins, are the products of gene messages. Back in the early 1940s, long before DNA was known to be the genetic material, two scientists, George Beadle and Edward Tatum, determined that genes code for proteins. Through a complex set of experiments, Beadle and Tatum discovered that each protein chain manufactured during translation is the product of only one gene’s message. If you read Chapter 8, you may be scratching your head right about now. Yes, many different mRNA combinations are possible from a single gene (thanks to the alternative splicing thing I cover in Chapter 8). But each combination acts alone to make one, and only one, protein. So, even though it’s possible to make multiple mRNAs from a single DNA message, each mRNA gets translated individually.

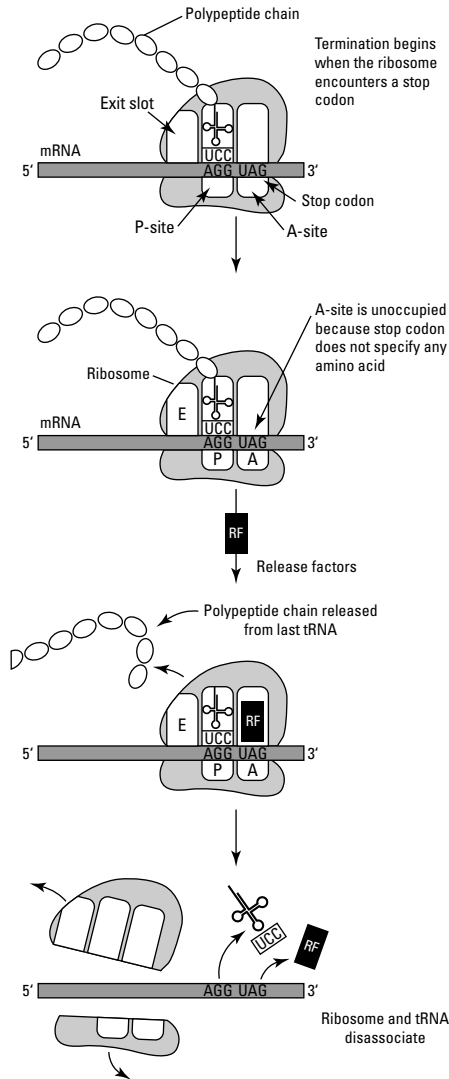

Figure 9-6:
Termination.

Proteins Are Precious Polypeptides



Besides water, the most common substance in your cells is protein. Proteins carry out the business of life. The key to a protein's function is its shape; completed proteins can be made of one or more polypeptide chains that are folded and hooked together. The way proteins fit and fold together depends on which amino acids are present in the polypeptide chains.

Recognizing radical groups

Every amino acid in a polypeptide chain shares several features, which you can see in Figure 9-7:

- ✓ A positively charged amino group (NH_2) attached to a central carbon atom
- ✓ A negatively charged carboxyl group (COOH) attached to the central carbon atom opposite the amino group
- ✓ A unique combination of atoms that form branches and rings, called *radical groups*, that differentiate the 20 amino acids specified by the genetic code



Oh, the difference a single amino acid makes

Hemoglobin proteins were one of the first proteins to be studied in detail, and the blood disorder sickle cell anemia was one of the first diseases to be understood from mutation at the DNA-level to phenotype. Sickle cell anemia was first described in 1910 when Dr. James Herrick published his case study of a young patient. The young man, a dental student, came to Dr. Ernest Irons, a 27-year-old intern, complaining of severe fatigue. His enlarged heart seemed completely overworked, and he was clearly anemic (his blood didn't contain enough hemoglobin to bring oxygen to his tissues). When Dr. Irons examined the young man's blood cells under a microscope, many of the cells looked odd. Instead of the normal, fat, donut-like shape Dr. Irons expected, many of the cells were comma-shaped, like a sickle (a knife used to harvest grain). Dr. Irons notified his supervisor, Dr. Herrick, who called the disorder sickle-cell anemia — a name it carries to this day. (When Herrick published his account of the case, he never mentioned Irons's role in the discovery of the disease.)

Sickle-cell anemia affects millions of people of African descent. In tropical climates where malaria is common, the presence of one allele for sickle-cell actually confers some immunity to this mosquito-transmitted disease. But persons who are homozygous (carrying two identical copies of an allele; see Chapter 2) for sickle-cell suffer from debilitating blood clots in their tiniest blood vessels — namely those in fingers, toes, and kidneys. The red blood cells of patients with sickle-cell disease take on the comma shape when oxygen levels in the blood are lower than normal, like when children are running full blast at play. The blood cell takes on this odd shape because the proteins don't fold properly. A single erroneous amino acid (valine) in each of the two beta-chains is substituted for the correct amino acid (glutamic acid). This one tiny change in the hemoglobin protein causes many people to suffer and die from sickle-cell disease each year.

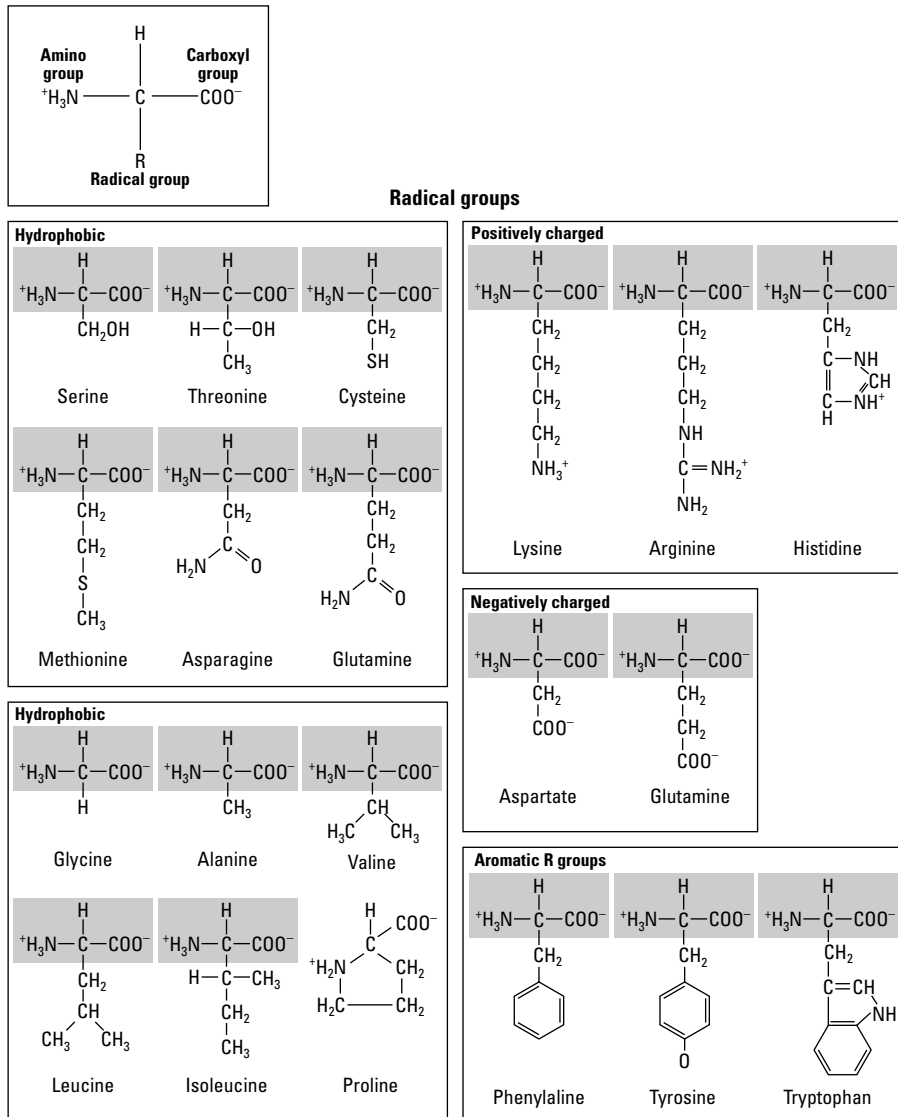

Figure 9-7:
The 20 amino acids used to construct proteins.

Amino acid radical groups come in four different flavors: water-loving (hydrophilic), water-hating (hydrophobic), negatively charged (bases), and positively charged (acids). When their amino acids are part of a polypeptide chain, radical groups of adjacent amino acids alternate sides along the chain (see Figure 9-7). Because of their differing affinities (those four flavors), the radical groups either repel or attract neighboring groups. This reaction leads to folding and gives each protein its shape.

Giving the protein its shape

Proteins are folded into complex and often beautiful shapes, as you can see in Figure 9-8. (To see more of the amazing forms proteins can get into, check out some of the Web sites I list in Chapter 24.) These arrangements are partly the result of spontaneous attractions between radical groups (see the preceding section for details) and partly the result of certain regions of polypeptide chains that naturally form spirals (also called helices, not to be confused with DNA's double helix in Chapter 6). The spirals may weave back and forth to form sheets. These spirals and sheets are referred to as a *secondary structure* (the simple, unfolded polypeptide chain is the *primary structure*).

Proteins are often modified after translation and may get hooked up with various other chemical groups and metals (such as iron). In a process similar to the post-transcription modification of mRNA, proteins may also be sliced and spliced. Some protein modifications result in natural folds, twists, and turns, but sometimes the protein needs help forming its correct conformation. That's what chaperones are for.

Chaperones are molecules that mold the protein into shape, kind of like a plastic surgeon on one of those TV makeover shows. Chaperones push and pull the protein chains until the appropriate radical groups are close enough to one another to form chemical bonds. This sort of folding is called a *tertiary structure*.

When two or more polypeptide chains are hooked to make a single protein, they're said to have a fourth degree, or *quaternary structure*. For example, the hemoglobin protein that carries oxygen in your blood is a well-studied protein with a quaternary structure. Two pairs of polypeptide chains form a single hemoglobin protein. The chains, two called *alpha-globin chains* and two called *beta-globin chains*, each form helices, which you can see in Figure 9-8, that wind around and fold back on themselves into tertiary structures. Associated with the tertiary structures are iron-rich *heme* groups that have a strong affinity for oxygen. Take a look at the sidebar "Oh, the difference a single amino acid makes" for more about the complex folds of hemoglobin. For more on how good proteins go bad, flip ahead to Chapters 10 and 13.

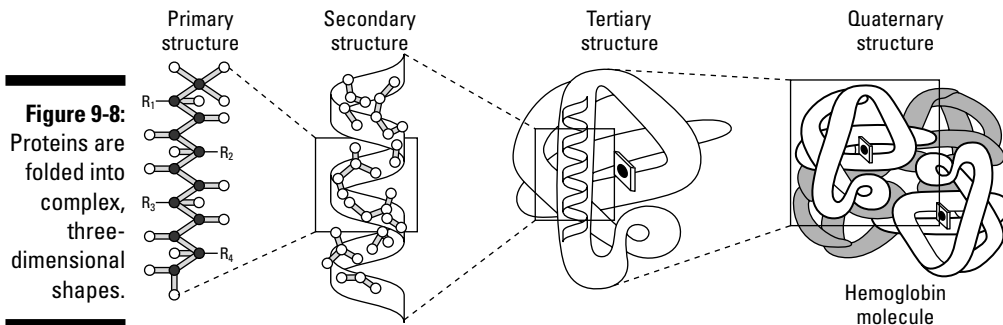

Chapter 10

What a Cute Pair of Genes: Gene Expression

In This Chapter

- ▶ Confining gene activities to the right places
 - ▶ Scheduling genes to do certain jobs
 - ▶ Controlling genes before and after transcription
-

Every cell in your body (with very few exceptions) carries the entire set of genetic instructions that make, well, everything about you. Your eye cells contain the genes for growing hair. Your skin cells contain the genes that code for your eye color. Your nerve cells contain the genes that turn on cell division — yet your nerve cells don't divide (under normal conditions; see Chapter 14 for what happens when things go wrong). Even genes that are supposed to be active in certain cells aren't active all the time — instead, those genes are turned on only when needed and then turned off again, like turning off the light in a room when you leave.

In a nutshell, this chapter explains why, then, your eyeballs aren't hairy, and that explanation boils down to the subject of gene expression. *Gene expression* is how genes make their products at the right time and in the right place. All the available genes aren't active in all cells all the time, so geneticists say that gene expression is tissue-specific, meaning only certain genes are active and working for each tissue type. This chapter examines how your genes work and what controls them.

Getting Your Genes Under Control



Gene expression occurs throughout an organism's life, starting at the very beginning. When an organism develops — first as a *zygote* (the fertilized egg) and later as an embryo — genes turn on to regulate the process. At first, all the cells are exactly alike, but that characteristic quickly changes. (Cells that have the ability to turn into any kind of tissue are *totipotent*; see Chapter 20 for more on totipotency.) Cells get instructions from their DNA to turn into certain kinds of tissues, such as skin, heart, and bone. After the tissue type is decided, certain genes in each cell become active, and others get permanently turned off. That's because gene expression is highly *tissue-specific*, meaning certain genes are active only in certain tissues or at particular stages of development.

In part, the tissue-specific nature of gene expression is due to location — genes in cells respond to cues from the cells around them. Other than location, some genes respond to cues from the environment; other genes are set up to come on and then turn off at a certain stage of development. Take the genes that code for hemoglobin, for example.

Your *genome* (your complete set of genetic information) contains a large group of genes that all code for various components that make up the big protein, called *hemoglobin*, that carries oxygen in your blood. Hemoglobin's a complex structure composed of two different types of proteins that are folded and joined together in pairs (see Chapter 9 for how proteins are produced and get folded to become functional). During your development, nine different hemoglobin genes interacted at different times to make three kinds of hemoglobin. Changing conditions make it necessary for you to have three different sorts of hemoglobin at different stages of your life. When you were an embryo and later, a fetus, you depended on your mother for oxygen. The oxygen in your mom's blood had to cross a membrane to get to you. The process of crossing any membrane is somewhat inefficient, so to compensate for the inefficiency of the transfer, your blood had to be extremely good at carrying oxygen to sustain your growth and development.

When you were still an embryo, your hemoglobin was composed mostly of epsilon-hemoglobin (Greek letters are used to identify the various types of hemoglobin). After about three months of development, the epsilon-hemoglobin gene was turned off in favor of two fetal hemoglobin genes (alpha and gamma). (Fetal hemoglobin is comprised of two proteins — two alphas and two gammas — folded and joined together as one functional piece.) When you were born, the gene producing the gamma-hemoglobin was shut off, and the beta-hemoglobin gene, which works for the rest of your life, kicked in.

Heat and light

Organisms have to respond quickly to changing conditions in order to survive. When external conditions turn on genes, it's called *induction*. Responses to heat and light are two types of induction that are particularly well understood.

When an organism is exposed to high temperatures, a suite of genes immediately kicks into action to produce *heat-shock proteins*. Heat has the nasty effect of mangling proteins so that they're unable to function properly, referred to as *denaturing*. You're already familiar with this effect — when you fry an egg, the clear albumin proteins denature and become opaque. Heat-shock proteins are produced by roughly 20 different genes and act to prevent other proteins from becoming denatured. Heat-shock proteins can also repair protein damage and refold proteins to bring them back to life. The genes that make heat-shock proteins are always on stand-by, ready for action as soon as heat creates a need for them. Heat-shock responses are best studied in fruit flies, but humans have a large number of heat-shock genes, too. These genes protect you from the effects of stress and pollutants. You're exposed to various sorts of pollutants and toxins all the time, and without heat-shock genes, you would age more quickly (because of accelerated cell death) and could become seriously ill as your organs lost large numbers of cells.

Plants must be able to respond to changing light conditions. A plant converts light energy

into sugars (which supply it with energy) with the help of an enzyme, *RBC* (RBC stands for the tongue-twister 1,5-bisphosphate carboxylase). Plants only produce RBC when they're exposed to light. Like its name, RBC is a big, complex protein made up of large and small parts called *subunits* (like the parts of ribosomes; see Chapter 9). The subunits of RBC are made by different genes, which, in many plants, are found in the *chloroplast*, that ring of DNA that only plants possess. Exposure to light kicks off transcription of the RBC genes.

Plants aren't the only organisms that respond to light. Various bird species monitor the length of the days to know when to migrate. Your daily rhythms of sleeping and waking are controlled, in part, by light. Even your mood may have a light connection. Many people suffer from a condition called *seasonal affective disorder*, or SAD — basically, the wintertime blues. SAD causes people to feel depressed, low on energy, and generally blah. Light signals your brain to slow its production of *melatonin*, the hormone that helps you sleep, but when the days are short and dark, your brain gets carried away and makes too much melatonin, leaving you groggy and down in the dumps. The symptoms of SAD seem to be relieved by exposure to sunlight or commercially available full-spectrum lights because exposure to light regulates the melatonin gene — a period of darkness turns it on, and bright light turns it off.

The genes controlling the production of all these hemoglobins are on two chromosomes, 11 and 16 (see Figure 10-1). The genes on both chromosomes are turned on in order, starting at one end of the group (the 5' end; see Chapter 6 for how DNA's set up with numbered ends) for embryonic hemoglobin. Adult hemoglobin is produced by the last set of genes on the 3' end.

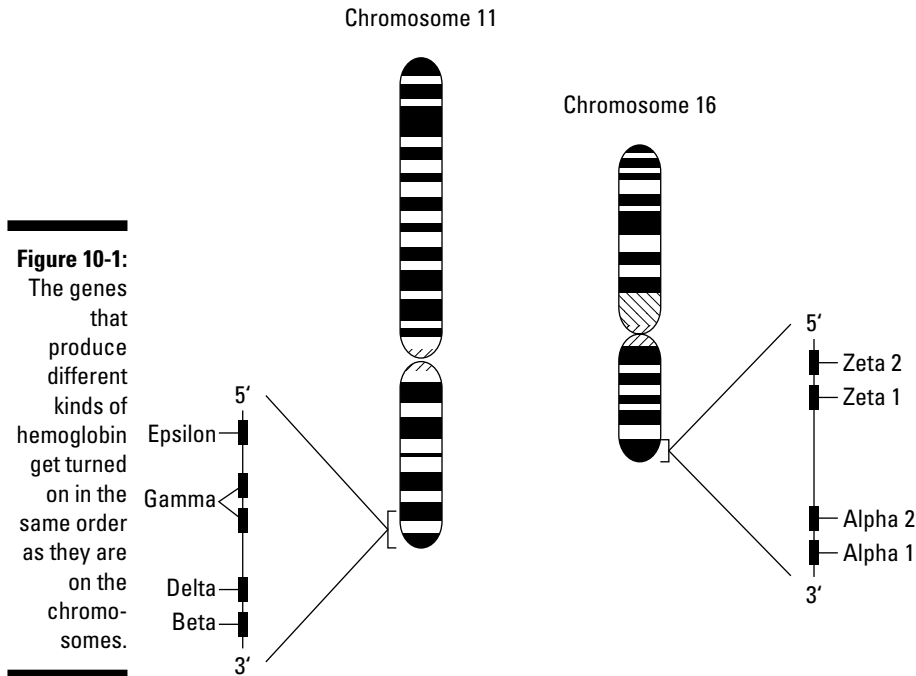

Transcriptional Control of Gene Expression

Most gene control in eukaryotes, like you and me, occurs during transcription. The basic transcription process is covered in Chapter 8; this section covers how and when transcription is carried out to control when genes are and aren't expressed.



When a gene is “on,” it’s being transcribed. When the gene is “off,” transcription is suspended. The only way that proteins (the stuff phenotype is made of; see Chapter 9) can be produced during translation is through the work of messenger RNA (mRNA). Transcription produces the mRNAs used in translation; therefore, when transcription is happening, translation is in motion, and gene expression is on. When transcription is stopped, gene expression is shut down, too. The timing of transcription can be controlled by a number of factors, which include:

- ✓ DNA accessibility
- ✓ Regulation from other genes
- ✓ Signals sent to genes from other cells by way of hormones



DNA must unwind a bit from its tight coils in order to be available for transcription to occur.

Tightly wound: The effect of DNA packaging



The default state of your genes is off, not on. Starting in the off position makes sense when you remember that almost every cell in your body contains a complete set of all your genes. You just can't have every gene in every cell flipped on and running amuck all the time; you want specific genes acting only in the tissues where their actions are needed. Therefore, keeping genes turned off is every bit as important as turning them on.

Genes are kept in the off position in two ways:

- ✓ **Tight packaging:** DNA packaging is a highly effective mechanism to make sure that most genes are off most of the time because it prevents transcription from occurring by preventing transcription factors from getting access to the genes. DNA is an enormous molecule, and the only way it can be scrunched down small enough to fit into your cell's nuclei is by being tightly wound round and round itself in supercoils. First, the DNA is wrapped around special proteins called histones. Then, the DNA and the histones, which together look a bit like beads on a string, are wrapped around and around themselves to form the dense DNA known as *chromatin*. When DNA's wrapped up this way, it can't be transcribed because transcription factors can't bind to the DNA to find the template strand and copy it.
- ✓ **Repressors:** Some proteins act to block transcription and prevent it from occurring. *Repressors* prevent transcription by binding to the same DNA sites that transcription activators would normally use or by interfering with the activities of the group of enzymes that kick off transcription (called the holoenzyme complex; see Chapter 8). In either case, DNA is prevented from unwinding, and the genes are kept turned off.

But genes can't stay off forever. So certain sections of DNA come pre-packaged for unwinding, allowing the genes in those areas to be turned on more easily whenever they're needed.



To find out which genes are prepackaged for unwrapping, researchers exposed DNA to an enzyme called DNase I, which actually digests DNA. DNase I isn't a part of normal transcription; instead, it provides a signal to geneticists that a region of packaged DNA is less tightly wound than regions around it. Geneticists added DNase I to DNA to see which parts of the genome were sensitive to being degraded by the enzyme's activity. The sections of DNA left

behind in these experiments contained genes that were always turned off in the tissue type the cell belonged to. The parts that were digested weren't tightly wound and thus harbored the genes that could be turned on when needed.

To turn genes on, the DNA must be removed from its packaging. To unwrap DNA from the nucleosomes, specific proteins must bind to the DNA to unwind it. There are lots of proteins including transcription factors, collectively known as *chromatin-remodeling complexes*, that carry out the job of unwinding DNA depending on the needs of the organism. Most of these proteins attach to a region near the gene to be activated and push the nucleosomes aside to free the DNA up for transcription. As soon as the DNA is available, transcription factors, which in some types of cells are always lurking around, latch on and immediately get to work.

As I explain in Chapter 8, transcription gets started when a group of enzymes called the holoenzyme complex binds to the promoter sequence of the DNA. Promoter sequences are part of the genes they control and are found a few bases away. *Transcription activator proteins* are part of the mix. These proteins help get all the right components in place at the gene at the right moment. Transcription activators also have the ability to shove nucleosomes out of the way to make the DNA template available for transcription.

Genes controlling genes

Genes are often controlled by the actions of other genes. There are four types of genes that micromanage the activities of others. In this section, I've divided these genes up into two groups based on how they relate to one another.

Micromanaging transcription

Three types of genes act as regulatory agents to turn transcription up (enhancers), turn it down (silencers), or drown out the effects of enhancing or silencing elements (insulators).

✓ **Enhancers:** This type of gene sequence turns on transcription and speeds it up, making transcription happen faster and more often. Unlike promoter sequences, which are always located just a few bases “upstream” from the genes they control (see Chapter 8 for navigating directions), enhancers can be upstream, downstream, or even smack in the middle of the transcription unit. Furthermore, enhancers have the unique ability to control genes that are very distantly located (like thousands of bases away) from the enhancer's position. Nonetheless, enhancers are very tissue-specific in their activities — they only influence genes that are normally activated in that particular cell type.

Researchers are still working to get a handle on how enhancers do their jobs. Like the proteins that turn transcription on, enhancers seem to have the ability to rearrange nucleosomes and pave the way for transcription to occur. The enhancer teams up with transcription factors to form a complex called the *enhanceosome*. The enhanceosome attracts chromatin-remodeling proteins to the team along with RNA polymerase to allow the enhancer to supervise transcription directly.

- ✔ **Silencers:** On the flip side of transcription regulation are the *silencers*. These are gene sequences that hook up with repressor proteins to slow or stop transcription. Like enhancers, silencers can be many thousands of bases away from the genes they control. Silencers work to keep the DNA tightly packaged and unavailable for transcription.
- ✔ **Insulators:** Sometimes called *boundary elements*, these sequences have a slightly different job. Insulators work to protect some genes from the effects of silencers and enhancers, confining the activity of those sequences to the right sets of genes. Usually, this protection means that the insulator must be positioned between the enhancer (or silencer) and the genes that are off limits to the enhancer's (or silencer's) activities.



Given that enhancers and silencers are often far away from the genes they control, you may be wondering how they're able to do their jobs. Most geneticists think that the DNA must loop around to allow enhancers and silencers to come in close proximity to the genes they influence. Figure 10-2 illustrates this looping action. The promoter region begins with the TATA box and extends to the beginning of the gene itself. Enhancers interact with the promoter region to regulate transcription.

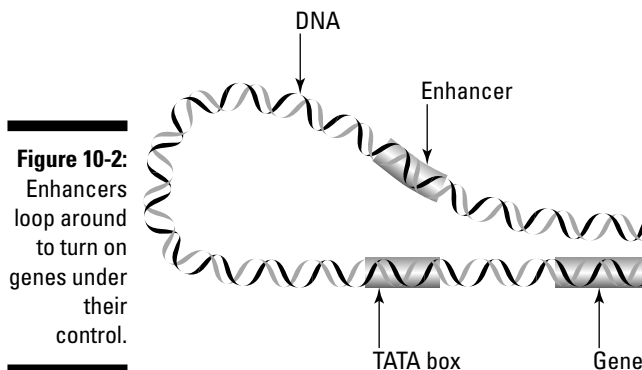

Figure 10-2:
Enhancers loop around to turn on genes under their control.

Jumping genes: Transposable elements

Some genes like to travel. They hop around from place to place inserting themselves into a variety of locations, both causing mutations in genes and

changing the ways other genes do business. These wanderers are called *transposable elements* (TEs), and they're quite common — 50 percent of your DNA is made up of transposable elements, also known as *jumping genes*.



Barbara McClintock discovered TEs in 1948. She called them *controlling elements* because they control gene expression of other genes. McClintock was studying the genetics of corn when she realized that genes with a habit of frequently changing location were controlling kernel color. In her research, these genes showed up first on one chromosome, but in another individual, the genes mapped to a completely different chromosome. (You can find out more about Dr. McClintock in Chapter 22.)

It appears that TEs travel at will, showing up whenever and wherever they please. How they pull off this trick isn't completely clear because TEs have several options when it comes to travel. They take advantage of breaks in DNA, but not just any break will do — the break must include little overhanging bits of single-stranded DNA (see Figure 10-3). Some TEs replicate themselves to hop into the broken spots. Others, which go by the special name *retrotransposons*, make use of RNA to do the job.

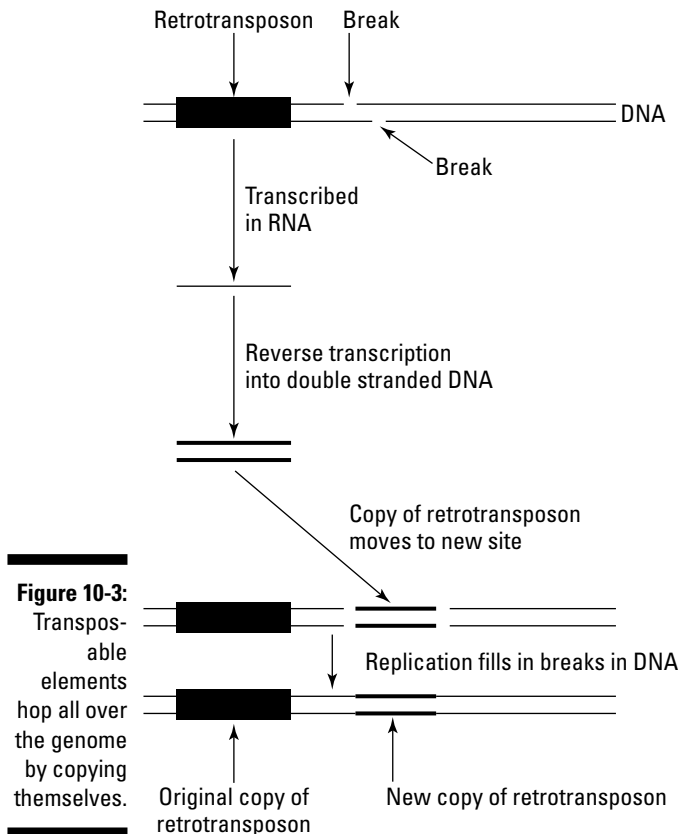

Retrotransposons are transcribed just like all other DNA (an RNA transcript is produced). But then the RNA transcript is transcribed again by a special enzyme to make a double-stranded DNA copy of the RNA transcript. Because the end result is a DNA copy made from an RNA transcript, the process used by retrotransposons is called *reverse transcription*. The DNA copy is then inserted into a break and the newly copied retrotransposon makes itself comfortable.



The most common retrotransposon in humans is the *Alu* element. You've got around a million or so copies of *Alu* and its relatives in your DNA. *Alu* elements and other, similar sequences called *LINE* elements (for Long Interspersed Sequences) control gene expression by inserting copies of themselves all over the genome. Some copies of *Alu* are known as *signal recognition particles* and control the expression of other genes by stopping translation as well as intercepting signals sent by other cells.

Hormones turn me on



Hormones are complex chemicals that control gene expression. They're secreted by a wide range of tissues in the brain, gonads (organs or glands, such as ovaries and testes, that produce reproductive cells), and other glands throughout the body. Hormones circulate in the bloodstream and can affect tissues far away from the hormones' production sites. In this way, they can affect genes in many different tissues simultaneously. Essentially, hormones act like a master switch for gene regulation all over the body. Take a look at the sidebar "Hormones make your genes go wild" for more about the effects hormones have on your body.

Hormones make your genes go wild

Dioxins are long-lived chemicals that are released into the environment through incineration of waste, coal-burning power plants, paper manufacturing, and metal smelting operations, to name a few. It turns out that dioxin can mimic estrogens and turn on genes all by itself. That's scary because it means that dioxin can cause cancer and birth defects.

Dioxin is a chemical with an unfortunate affinity for fat. Animals store dioxin in their fat cells, so most of the dioxins you're exposed to come

in the food you eat. Meats and dairy products are the worst offenders, but fatty fish sometimes contain elevated levels, too. It's long been known that dioxins affect estrogens, the hormones that control reproduction in women and, to some degree, men, too. The good news is that dioxin levels are on the decline. Dioxin emissions have declined by 90 percent over the last 18 years. Unfortunately, dioxin that's already present in the environment breaks down slowly, so it's likely to persist for some time to come.

A swing and a miss: The genetic effects of anabolic steroids

Anabolic steroids (or more correctly, anabolic-androgenic steroids) are in the news a lot these days. These steroids are synthetic forms of testosterone, the hormone that controls male sex determination (see Chapter 5). The anabolic aspect of anabolic-androgenic steroids refers to chemicals that increase muscle mass; the androgenic aspect refers to chemicals that control gonad functions such as sex drive and, in the case of men, sperm production. High-profile athletes, including some famous baseball players, may have abused one or more of these drugs in an effort to improve performance. Reports also suggest that use of anabolic steroids is common among young athletes in high school and college.

Hormones like testosterone control gene expression. Research suggests that testosterone exerts its anabolic effects by depressing the activity of a tumor suppressor gene that produces the protein *p27*. (Mutations of *p27* are implicated in one form of leukemia, a blood cancer. For more on tumor suppressor genes and their role in cancers, flip to Chapter 14.) When *p27* is depressed in muscle tissue, the tissue's cells can divide more rapidly, resulting in the bulky physique prized by some athletes. Anabolic steroids apparently also accelerate the effects of the gene that causes male pattern baldness (see Chapter 5); thus, men carrying that allele and taking anabolic steroids become permanently bald faster and at a younger age than normal.

Defects in tumor-suppressor genes such as *p27* are widely associated with cancer. Not only that, but some cancers depend on hormones to provide signals that tumor cells respond to (by multiplying). At least one study suggests that anabolic steroids are actually carcinogenic, meaning that their chemicals cause mutations that lead to cancer. Because illegally obtained steroids may also contain additional unwanted and potentially carcinogenic chemicals, mutagenic chemicals

may be introduced into the body while simultaneously depressing the activity of a tumor-suppressor gene. It doesn't take a genius to realize that this is dangerous. Cancers associated with anabolic-androgenic steroid abuse include liver cancer, testicular cancer, leukemia, and prostate cancer. Men with family histories of prostate or breast cancer should be especially cautious with steroid use because some scientists think that steroid use may increase the likelihood of cancer in people already at risk for the disease.

Anabolic steroid use has many side effects. Men may experience temporary loss of sperm production along with permanent enlargement of the breast tissue (a condition called gynecomastia). Additionally, these drugs increase sex drive but decrease the ability to get and maintain an erection (in other words, the spirit is willing, but the body is weak). Anabolic steroids also cause blood pressure to increase to potentially dangerous levels. Some men taking anabolic steroids have suffered heart attacks, and many experience permanent enlargement of the left side of the heart (the part that handles pumping blood out to the rest of the body). Violent behavior is also associated with the use of steroids; men often experience excessive rage and pathologically high energy levels (known in medical circles as mania). "Nutritional supplements" (such as Andro, the one Mark McGwire reportedly used) are chemical precursors of testosterone. However, these supplements apparently do little to increase muscle mass or enhance performance in any measurable way. Instead, they're associated with significant reductions in the "good" cholesterol (HDL, thought to protect the heart and blood vessels), and preteens taking these supplements are at risk for permanently stunted growth.

Some hormones are such large molecules that they often can't cross into the cells directly. These large hormone molecules rely on receptor proteins inside the cell to transmit their messages for them in a process called *signal transduction*. Other hormones, like steroids, are fat-soluble and small, so they easily pass directly into the cell to hook up with receptor proteins (check out the sidebar “A swing and a miss: The genetic effects of anabolic steroids” for details about the effects of performance-enhancing steroids). Receptor proteins (and hormones small enough to enter the cell on their own) form a complex that moves into the cell nucleus to act as a transcription factor to turn specific genes on.

The genes that react to hormone signals are controlled by DNA sequences called *hormone response elements* (HREs). HREs sit close to the genes they regulate and bind with the hormone-receptor complex. Several HREs can influence the same gene — in fact, the more HREs present, the faster transcription takes place in that particular gene.

Retroactive Control: Things That Happen After Transcription

After genes are transcribed into mRNA, their actions can still be controlled by events that occur later.

Nip and tuck: RNA splicing

As you discover in Chapter 8, genes have sections called *exons* that actually code for protein products. Often, in between the exons are *introns*, interruptions of noncoding DNA that may or may not do anything. When genes are transcribed, the whole thing, exons and introns, are all copied into mRNA. The mRNA transcript has to be edited — meaning the introns are removed — in preparation for translation. When multiple introns are present in the unedited transcript, various combinations of exons can result from the editing process. Exons can be edited out, too, yielding new proteins when translation rolls around. This creative editing process allows genes to be expressed in new ways; one gene can code for more than one protein. This genetic flexibility is credited for the massive numbers of proteins you produce relative to the number of genes you have (see Chapter 8 for more on the potential of gene editing).



One gene in which genetic flexibility is very apparent is *Dscam*. *Dscam* is named for the human disorder it's associated with: Down Syndrome Cell Adhesion Molecule. (*Dscam* may play a role in causing the mental disabilities that accompany Down syndrome.) In fruit flies, *Dscam* is a large gene with 115 exons and at least 100 splicing sites. Altogether, *Dscam* is capable of

coding for a whopping 30,016 different proteins. However, protein production from *Dscam* is tightly regulated; some of its products only show up during early stages of fly development. The human version of *Dscam* is less showy in that it makes only a few proteins, but other genes in the human genome are likely to be as productive at making proteins as *Dscam* of fruit flies, making this a “fruitful” avenue of research. Humans have very few genes relative to the number of proteins we have in our bodies. Genes like *Dscam* may help geneticists understand how a few genes can work to produce many proteins.

With scientists wise to the nip and tuck game played by mRNA, the next step in deciphering this sort of gene regulation is figuring out how the trick is done and what controls it. Researchers know that a complex of proteins called a *spliceosome* carries out much of the work in cutting and pasting genes together. How the spliceosome’s activities are regulated is another matter altogether. Knowing how it all works will come in handy though, because some forms of cancer, most notably pancreatic cancer, are the product of alternative splicing run amok.

Interfering RNAs knock out genes

The best way to understand how a gene works is to make it stop. That’s why the first gene function studies were done by inducing mutations (which I address in Chapter 13) and observing what went wrong with the organism (sounds a bit brutal, doesn’t it?). To say the least, using randomly induced mutations is a blunt-force approach because there’s no way to target specific genes. As technology became more sophisticated and geneticists learned more about the identity of DNA sequences (see Chapter 11), new approaches were developed. Geneticists learned how to introduce mutations directly into certain genes through a process called *site-directed mutagenesis*.

In another method to figure out how genes work, gene sequences can be snipped out of their DNA, mutated, and then introduced into the chromosome of the target organism using a process similar to cloning (which I cover in Chapter 20). This process creates a *transgenic organism* — that is, an organism that carries a foreign gene. (Transgenic is a more accurate way of saying *genetically modified*; this subject

is covered in detail in Chapter 19.) Knockout mice are a product of the transgenic approach to studying genes. The idea is to completely disable (or knock out) a gene and then study the effects of the loss-of-function (see Chapter 13 for more on loss-of-function mutations).

The world of RNAi (RNA interference; see “Shut up! mRNA silencing”) is changing the way geneticists study genes. The breakthrough moment came when two geneticists, Andrew Fire and Craig Mello, realized that by introducing certain double-stranded RNA molecules into roundworms, they could shut off genes at will. It turns out that for roundworms, scientists can put the RNAi into their food and knock out gene function not only in the worm that eats the concoction but in its offspring, too! Since this discovery in 2003, geneticists have used RNAi to knock out genes in all sorts of organisms, including chickens and mice. The most promising applications for RNAi are in gene therapy (jump to Chapter 16 for that discussion). Work is also underway to knock out the function of genes in viruses and cancer cells.

Shut up! mRNA silencing

After transcription produces mRNA, genes may be regulated through *mRNA silencing*. mRNA silencing is basically interfering with the mRNA somehow so that it doesn't get translated. Exactly how organisms like you and me use mRNA silencing, called *RNAi* (for *RNA interference*), to regulate genes isn't fully understood. Geneticists know that most organisms use RNAi to stymie translation of unwanted mRNAs and that double-stranded RNA provides the signal for the initiation of RNAi, but the details are still a mystery. The discovery of RNAi has produced a revolution in the way genes are studied; see the sidebar "Interfering RNAs knock out genes" for more.

RNA silencing isn't just used to regulate the genes of an organism; sometimes it's used to protect an organism from the genes of viruses. When the organism's defenses detect a double-stranded virus RNA, an enzyme called *Dicer* is produced. Dicer chops the double-stranded RNA into short bits (about 20 or 25 bases long). These short strands of RNA, now called *small interfering RNAs* (siRNAs), are then used as weapons against remaining viral RNAs. The siRNAs turn traitor, first pairing up with RNA-protein complexes produced by the host and then guiding those complexes to intact viral RNA. The viral RNAs are then summarily destroyed and degraded.

mRNA expiration dates

After mRNAs are sliced, diced, capped, and tailed (see Chapter 8 for how mRNA gets dressed up), they're transported to the cell's cytoplasm. From that moment onward, mRNA's on a path to destruction because enzymes in the cytoplasm routinely chew up mRNAs as soon as they arrive. Thus, mRNAs have a relatively short lifespan, the length of which (and therefore the number of times mRNA can be translated into protein) is controlled by a number of factors. But the mRNA's poly-A tail (the long string of adenines tacked on to the 3' end) seems to be one of the most important features in controlling how long mRNA lasts. Key aspects of the poly-A tail include:

- ✓ **Tail length:** The longer the tail, the more rounds of translation an mRNA can support. If a gene needs to be shut off rapidly, the poly-A tail is usually pretty short, allowing the RNA-eating enzymes to polish off the mRNA rapidly. With a short tail, when transcription comes to a halt, all the mRNA in the cytoplasm is quickly used up without replacement, thus halting protein production, too.
- ✓ **Untranslated sequences before the tail:** Many mRNAs with very short lives have sequences right before the poly-A tail that, even though they aren't translated, shorten the mRNA's lifespan.

Hormones present in the cell may also affect how quickly mRNAs disappear. In any event, the variation in mRNA expiration dates is enormous. Some mRNAs last a few minutes, meaning those genes are tightly regulated; other mRNAs hang around for months at a time.

Gene Control Lost in Translation

Translation of mRNA into amino acids is a critical step in gene expression. (Flip back to Chapter 9 for a review of the players and process of translation.) But sometimes genes are regulated during or even after translation.

Modifying where translation occurs

One way gene regulation is enforced is by hemming mRNAs up in certain parts of the cytoplasm. That way, proteins produced by translation are found only in certain parts of the cell, limiting their utility. Embryos use this strategy to direct their own development. Proteins are produced on different sides of the egg to create the front and back, so to speak, of the embryo.

Modifying when translation occurs

Just because an mRNA gets to the cytoplasm doesn't mean it automatically gets translated. Some gene expression is limited by certain conditions that block translation from occurring. For example, an unfertilized egg contains lots of mRNAs supplied by the female. Translation actually occurs in the unfertilized egg, but it's slow and selective. All that changes when a sperm comes along and fertilizes the egg: Preexisting mRNAs are slurped up by waiting ribosomes, which are signaled by the process of fertilization. New proteins are then rapidly produced from the maternal mRNAs.

Controlling gene expression by controlling translation occurs in one of two ways:

- ✓ The machinery that carries out translation, such as the initiator proteins that interact with ribosomes, is modified to increase or decrease how effectively translation occurs.
- ✓ mRNA carries a message that controls when and how it gets translated.

All mRNAs carry short sequences on their 5' ends that aren't translated, and these sequences can carry messages about the timing of translation. The untranslated sequences are recognized with the help of translation initiation factors that help assemble the ribosome at the start codon of the mRNA.

Some cells produce mRNAs but delay translation until certain conditions are met. Some cells respond to levels of chemicals that the cell's exposed to. For example, the protein that binds to iron in the blood is created by translation only when iron is available, even though the mRNAs are being produced all the time. In other cases, the condition of the organism sends the message that controls the timing of translation. For example, insulin, the hormone that regulates blood sugar levels, controls translation, but when insulin's absent, the translation factors lock up the needed mRNAs and block translation from occurring. When insulin arrives on the scene, the translation factors release the mRNAs, and translation rolls on, unimpeded.

Modifying the protein shape

The proteins produced by translation are the ultimate form of gene expression. Protein function and thus gene expression can be modified in two ways: by changing the protein's shape or by adding components to the protein. The products of translation, the amino acid chains, can be folded in various ways to affect their functions (see Chapter 9 for how amino acid chains are folded). Various components — carbohydrate chains, phosphates, and metals such as iron — can be added to the chain, also changing its function. Occasionally, the folding of proteins can go horribly wrong; for an explanation of one of the scariest products of this type of error, mad cow disease, check out the sidebar "Proteins gone wrong."

Proteins gone wrong

Cruetzfeldt-Jakob disease (CJD) is a frightening disorder of the brain. Sufferers first experience memory loss and anxiety and ultimately develop tremors and lose intellectual function. CJD is the human form of what's popularly known as *mad cow disease*. The pathogen isn't a bacteria, virus, or parasite — it's an infectious protein called a *prion*. One of the scariest aspects of prions is that they seem to be able to replicate on their own by hijacking normal proteins and refolding them.

The gene that codes for the prion protein is found in many different organisms, including humans. Once mutated (and what the unmutated version does isn't really clear), the protein produced by the gene folds into an unusual, flattened sheet. After one prion protein is acquired, that prion can hijack the normal products of

unmutated prion genes, turning them into misfolded monsters, too. Prion proteins gum up the brain of the affected organism and eventually have fatal results. As if this outcome weren't frightening enough, it seems that prions can jump from one species to another.

Scientists are fairly certain that some of the cows originally infected by mad cow disease contracted it by eating feed contaminated by sheep meat. The deceased sheep were infected with a prion that causes yet another icky disease called scrapie, which destroys the brains of infected animals. Scientists believe that when humans consume beef products from cows affected by mad cow disease, the prions in the meat can migrate through the human body and continue doing their dirty work.

Part III

Genetics and Your Health

The 5th Wave

By Rich Tennant

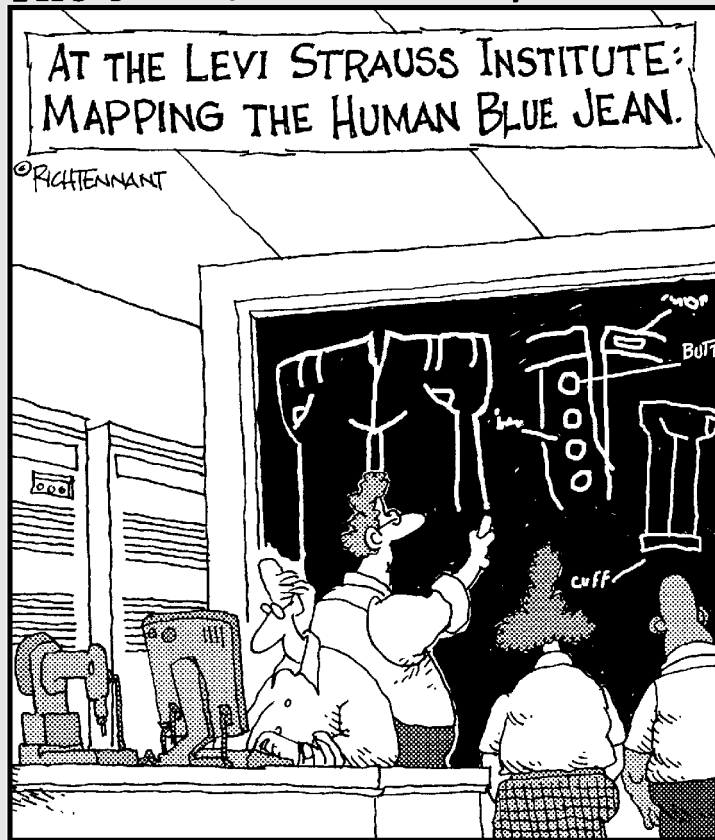

In this part . . .

Genetics affects your everyday life. Viruses, bacteria, parasites, and hereditary diseases all have their roots in DNA. That's why as soon as scientists uncovered the chemical nature of DNA, the race was on to read the code directly. The amazing technology of DNA sequencing has been used to uncover the hidden nature of the code. Genetic information is used to track, diagnose, and treat genetic diseases.

The chapters in this part help you unravel the mysterious connections between DNA and your health. I explain how genetic counselors read your family tree to help you better understand your family medical history. I cover the ways in which genes are altered by mutations as well as the consequences of those changes. And because serious problems arise when chromosomes aren't doled out in the usual way — leading to too many or too few — I explain what the numbers mean. Finally, I share some exciting information about how genetics may reshape medical treatments in the form of gene therapies.

Chapter 11

Sequencing Your DNA

In This Chapter

- ▶ Discovering the genomes of other species
 - ▶ Appreciating the contributions of the Human Genome Project
 - ▶ Sequencing DNA to determine the order of the bases
-

Imagine owning a library of 25,000 books. And I don't mean just any books; this collection contains unimaginable knowledge: solutions to diseases that have plagued humankind for centuries, basic building instructions for just about every creature on earth, even the explanation of how thoughts are formed inside your brain. There's just one problem with this fabulous library — it's written in a mysterious language, a code made up of only four letters that are repeated in arcane patterns. The very secrets of life on earth have been contained within this library since the dawn of time, but no one could read the books — until now.

The 25,000 books are the genes that carry the information that make you. The library storing these books is the human genome. Sequencing *genomes* (that is, all the DNA in one set of chromosomes of an organism), both our own and those of other organisms, means learning the order of the four bases (C, G, A, and T) that make up DNA. The order of the bases in DNA is incredibly important because it's the key to DNA's language. Learning the language is the first step in reading the books of the library. Most of your genes are identical to those in other species, so sequencing the DNA of other organisms, such as fruit flies, roundworms, chickens, and even yeast, supplies scientists with a lot of information about the human genome and how human genes function.

Trying on a Few Genomes

Humans are incredibly complex organisms. At least, we like to think so. But when it comes to genetics, we're not at the top of the heap. Many complex organisms have vastly larger genomes than we do. Genomes are usually measured in number of base pairs they contain; flip back to Chapter 6 for more

about how DNA is put together in base pairs. Table 11-1 lists the genome sizes and estimated number of genes for various organisms (for some genomes, like grasshoppers, the numbers of genes are still unknown). Human genome size runs a distant fourth behind lowly amoebas, salamanders, and grasshoppers. It's humbling, but true — a single-celled amoeba has a gigantic genome of over 675 billion base pairs. If genome size and complexity were related, which they obviously aren't, you'd expect the amoeba to have a small genome compared to other "more complex" organisms. On the flip side, it doesn't take a lot of DNA to have a big impact on the world. For example, the HIV virus, which causes AIDS, is a mere 9,700 bases long and is responsible for the deaths of roughly 20 million people worldwide. With only nine genes, HIV isn't very complex, but it's still very dangerous.

Even organisms that are very similar have vastly different genome sizes. Fruit flies have roughly 180 million base pairs of DNA. Compare that to the grasshopper genome, which weighs in at a whopping 180 *billion* base pairs. But fruit flies and grasshoppers aren't *that* different. So if it isn't organism complexity, what causes the differences in genome size observed among organisms?

<i>Species</i>	<i>Number of Base Pairs</i>	<i>Number of Genes</i>
HIV virus	9,700	9
<i>E. coli</i>	4,600,000	3,200
Yeast	12,000,000	6,300
Flu bacteria	19,000,000	1,700
Roundworm	97,000,000	20,000
Mustard weed	120,000,000	25,500
Fruit fly	180,000,000	13,600
Chicken	1,000,000,000	23,000
Mouse	2,500,000,000	30,000
Corn	2,500,000,000	59,000
Human	3,000,000,000	25,000–30,000
Grasshopper	180,000,000,000	?
<i>Amoeba dubia</i>	670,000,000,000	?
Salamander	765,000,000,000	?

Part of what accounts for the variation in genome size from one organism to the next is number of chromosomes. Particularly in plants, the number of chromosome sets (called *ploidy*; see Chapter 15) explains why some plant species have very large genome sizes. For example, wheat is hexaploid (six copies of each chromosome) and has a gigantic genome of 16 billion base pairs. Rice, on the other hand, is diploid (two copies of each chromosome) and has a mere 430 million base pairs.

Chromosome number doesn't tell the whole story, however. The number of genes found within a genome doesn't reveal how big the genome will be. Arguably, mice are somewhat more complex than corn, but they have 29,000 fewer genes! On top of that, the corn genome and mouse genome are roughly equal in size. Another example is that humans and the mustard weed both have about 25,000 genes. Yet the mustard weed genome is roughly half the size of the human genome (see Table 11-1 for more exact numbers). What the human genome has that the mustard weed genome may lack is lots of repetition.

DNA sequences fall into two major categories:

- ✓ Unique sequences found in genes (genes are covered in Chapter 9)
- ✓ Repetitive sequences that make up non-coding DNA



The presence of repetitive sequences of DNA in some organisms seems to best explain genome size — that is, large genomes have many repeated sequences that smaller genomes lack. Repetitive sequences vary from 150 to 300 base pairs in length and are repeated thousands and thousands of times. These big chunks of sequences don't code for proteins, though. Because all this repetitive DNA doesn't seem to do anything, it's been dubbed *junk DNA*.



Junk DNA has suffered a bum rap. For years, it was touted as a genetic loser, just along for the ride, doing nothing except getting passed on from one generation to the next. But no more. At long last, junk DNA is getting proper respect. Scientists realized quite some time ago that a lot of junk DNA gets transcribed into RNA (see Chapter 8 for the transcription process). But after being transcribed, this non-coding “junk” didn't appear to be translated into protein (see Chapter 9 for the translation process). New evidence suggests that junk DNA actually carries out important functions that regulate how organisms are put together. This explanation is based on the fact that as embryo development gets more and more involved (comparing roundworms to humans, for example), organisms have more and more noncoding, repetitive DNA. It remains to be seen if organisms with gigantic genomes (like the amoeba) are made up of vast amounts of noncoding DNA. The jury's still out, but it's likely that junk DNA does much more than simply take up space in the genome.

Sequencing Your Way to the Human Genome

One of the ways scientists figure out what functions various kinds of sequences carry out is by comparing genomes of different organisms. To make these comparisons, the projects described in this section use the methods explained in the section “Reading the Language of DNA” later in this chapter. The results of these comparisons tell us a lot about ourselves and the world around us.

The DNA of all organisms holds a vast amount of information. Amazingly, most cell functions work the same regardless of which animal the cell comes from. Yeast, elephants, and you all replicate DNA in the same way using almost identical genes. Because nature uses the same genetic machinery over and over, learning about the DNA sequences in other organisms tells us a lot about the human genome (and it’s far easier to experiment with yeast and roundworms than with humans). Table 11-2 is a timeline of the major milestones of DNA sequencing projects so far. In this section, you find out about several of these projects, including the granddaddy of them all, the Human Genome Project.

Table 11-2 Major Milestones in DNA Sequencing

<i>Year</i>	<i>Event</i>
1985	Human Genome Project is proposed.
1990	Human Genome Project officially begins.
1992	First map of all genes in the entire human genome is published.
1995	First sequence of an entire living organism — <i>Haemophilus influenzae</i> , a flu bacteria — is completed.
1996	Brewer’s Yeast genome is completed.
1997	Genome of <i>Escherichia coli</i> , the most common intestinal bacteria, is completed.
1998	Roundworm (<i>Caenorhabditis elegans</i>) genome is completed.
1999	First human chromosome, chromosome 22, is completely sequenced. Human Genome Project passes the 1 billion base pairs milestone.
2000	Fruit fly genome is completed. First entire plant genome — <i>Arabidopsis thaliana</i> , the common mustard plant — is sequenced.

<i>Year</i>	<i>Event</i>
2001	First working “draft” of the entire human genome is published.
2002	Mouse genome is completed.
2004	Chicken genome is completed.

The yeast genome

Brewer’s Yeast (scientific name *Saccharomyces cerevisiae*) was the first eukaryotic genome to be fully sequenced. (Eukaryotes have cells with nuclei; see Chapter 2.) Yeast has an established track record as one of the most useful organisms known to humankind. It’s responsible for making bread rise and for the fermentation that results in beer and wine. Not only is yeast popular for providing food and drink, it’s a favorite organism for genetic study. Much of what we know about the eukaryotic cell cycle (see Chapter 2) came from yeast research. Yeast has provided information about how genes are inherited together (called linkage; see Chapter 4) and how genes are turned on and off (see Chapter 10). Because many human genes have yeast counterparts, yeast is extremely valuable for learning about how our own genes work.

Yeast has roughly 6,000 genes and 16 chromosomes. Altogether, about 70 percent of the yeast genome consists of actual genes. Yeast genes work in neighborhoods to carry out their functions; genes that are physically close together on chromosomes are more likely to work together than those that are far apart. The discovery of gene networks in yeast may help researchers better understand how complex diseases such as Alzheimer’s, diabetes, and lupus are caused in humans. Disorders such as these aren’t inherited in simple Mendelian fashion (see Chapter 3) and are likely to be controlled by many genes working together.



The sequencing of the yeast genome was quite a feat. Over 600 researchers in 100 laboratories across the world participated in the project. The technology used at the time was much slower than what’s available to researchers now (see the sidebar “Making the Human Genome Project possible: Automated DNA sequencing” for details). Despite the technological disadvantage, the sequence produced by this phenomenal team of scientists was extremely accurate — especially when compared to the human genome (see “The Human Genome Project” section later in this chapter).

The elegant roundworm genome

The genome of the lowly roundworm, more properly referred to by its full name *Caenorhabditis elegans*, was the first genome of a multicellular organism to be fully sequenced. Weighing in at roughly 97 million base pairs, the roundworm boasts nearly 20,000 genes — only 5,000 fewer than the human genome — on just six chromosomes. Like our own genome, roundworms have lots of junk DNA; only 25 percent of the roundworm genome is made up of genes.

Roundworms are a fabulous study species because they reproduce sexually and have organ systems, such as digestive and nervous systems, similar to those in much more complex organisms. Additionally, roundworms have a sense of taste, can detect odors, and react to light and temperature, so they're ideal for studying all sorts of processes, including behavior. Full-grown roundworms have exactly 959 cells and are transparent, so figuring out how their cells work was relatively easy. Scientists determined the exact function of each of the 959 roundworm cells! Although these microscopic organisms live in soil, roundworms have contributed to our understanding of many human diseases.



One of the ways to learn what a gene does is to stop it from functioning and observe the effect. In 2003, a group of researchers fed roundworms a particular kind of RNA that causes gene function to be temporarily put on hold (see Chapter 10 for how this effect on gene function works). By briefly turning genes off, the scientists were able to determine the functions of roughly 16,000 of the roundworms' genes. Another study using the same technique identified how fat storage and obesity are controlled in roundworms. Given that an amazing 70 percent of proteins produced by humans have roundworm counterparts, these gene function studies have obvious implications for human medicine.

The chicken genome

Chickens don't get enough respect. The study of chicken biology has revealed much about how organisms develop from embryos to adults. For example, the study of human limb formation was greatly enhanced by the study of how a chicken's wings and legs are formed in the egg. Chickens have contributed to our understanding of diseases such as muscular dystrophy and epilepsy, and chicken eggs are the principle ingredient used to produce vaccinations to fight human disease epidemics. So when the chicken genome was sequenced in 2004, there should have been a lot of crowing about the underappreciated chicken.

The chicken genome is really different from mouse and human genomes. It's much smaller (about a third as big as the human genome), with fewer chromosomes (39 compared to our 46) and slightly fewer genes (23,000 or so). Roughly 60 percent of chicken genes have human counterparts. Unlike

mammals, some chicken chromosomes are tiny (only about 5 million base pairs). These micro-chromosomes are unique because they have a very high content of guanine and cytosine (see Chapter 6 for more about the bases that make up DNA) and very few repetitive sequences.

Not surprisingly, chickens have lots of genes that code for keratin — the stuff that makes their feathers (and your hair). The big surprise accompanying the completed chicken genome was that chickens have lots of genes for sense of smell. Until recently, scientists thought that most birds have a really poor sense of smell. Now, they realize that sense of taste is what birds lack. The chicken genome also revealed that a particular gene previously known only to exist in humans is also present in chickens. This gene, called interleukin 26, is important in immune responses and may allow researchers to better understand how to fight disease. One disease they're particularly interested in is avian flu, the bugs of which are often deadly to humans but don't make birds sick. Ultimately, comparing the chicken and human genomes may allow scientists to understand how and why diseases like the "bird flu" move so easily between humans and chickens.

The Human Genome Project

In 2001, the triumphant publication of the human genome sequence was heralded as one of the great feats of modern science. The sequence was considered a draft, and indeed, it was a really *rough* draft. The 2001 sequence was woefully incomplete (it represented only about 60 percent of the total human genome) and was full of errors that limited its utility. The first draft was filled with gaps (numbering in the thousands) and many of the sequences were misassembled, making accurate interpretation of the sequences impossible. In 2004, the project neared completion. As of this writing, the errors have been corrected for the most part, and the sequence now covers almost the entire genome.



The Human Genome Project (HGP) is akin to some of the greatest adventures of all time — it's not unlike putting a person on the moon. However, unlike the great technological achievements of space exploration which cost tens of billions of dollars and require technology that becomes obsolete or wears out, the HGP carries a mere \$3 billion price tag and has unlimited utility. When first proposed in 1985, the HGP was considered completely impossible. At that time, sequencing technology was slow, requiring several days to generate only a few hundred base pairs of data (see the sidebar "Making the Human Genome Project possible: Automated DNA sequencing" to find out how this process was sped up). James Watson, one of the discoverers of the structure of DNA way back in the 1950s (see Chapter 6), was one of the first to push the project (in 1988) from idea to reality during his tenure as director of the National Institutes of Health. When the project got off the ground in 1990, a global team of scientists from 20 institutions participated. (The 2001 human genome sequence paper had a staggering 273 authors.)



The enormous benefits of the HGP are underappreciated. Most genetic applications would not exist without the HGP. Here are just a few:

- ✓ Diagnosis and treatment of genetic disorders (which I cover in Chapter 12)
- ✓ Development of drugs and gene therapy (see Chapter 16)
- ✓ Identification of bacteria and viruses to allow for targeted treatment of disease. Some antibiotics, for example, target some strains of bacteria better than others. Genetic identification of bacteria is quick and inexpensive, allowing physicians to rapidly identify and prescribe the right antibiotic.
- ✓ Forensics applications, such as identification of criminals and determination of identity after mass disasters (flip to Chapter 18)
- ✓ Understanding of the causes of cancer (which I cover in Chapter 14)
- ✓ Knowledge of which genes control what functions and how those genes are turned on and off (see Chapter 10)
- ✓ Development of bioinformatics, an entirely new field focused on advancing technological capability to generate genetic data, catalog results, and compare genomes (flip to Chapter 23 for more)
- ✓ Generation of thousands of jobs and economic benefits of over \$25 billion in 2001 alone

Listing and explaining all the HGP's discoveries would fill this book and then some. As you can see in Table 11-2, all other genome projects — mouse, fruit fly, yeast, roundworm, mustard weed, and so on — were started as a result of the HGP.

As the HGP has progressed, the gene count in the human genome has steadily declined. Originally, researchers thought that humans had as many as 100,000 genes. But as new and more accurate information becomes available over the years, they've determined that the human genome has only about 25,000 genes. Genes are often relatively small base pair-wise (roughly 3,000 base pairs), meaning that less than 2 percent of your DNA actually codes for some protein. The number of genes on different chromosomes varies enormously from nearly 3,000 genes on chromosome 1 (the largest) to 231 genes on the Y-chromosome (the smallest).

One of the newest discoveries of the HGP is that the human genome is still "growing." Genes get duplicated and then gain new functions, a process that has produced as many as 1,100 new genes. Likewise, genes lose function and "die." Thanks to this death process, 37 genes in the human genome that were once functional now exist as "pseudogenes," which have the sequence structure of normal genes but no longer code for proteins (see Chapter 10 for more about genes). The Human Genome Project has revealed the surprisingly dynamic and still changing nature of the human genome.



Of the human genes that have been identified, only about half are understood well enough to know what they do. Comparisons with genomes of other organisms help identify what genes do because most of the proteins produced by human genes have counterparts in other organisms. Thus, humans share many genes in common with even the simplest organisms, such as bacteria and worms. Over 99 percent of your DNA is identical to that of any other human on earth, and as much as 98 percent of your DNA is identical to the sequences found in the mouse genome. Perhaps the greatest take-home message of the HGP is how alike all life on earth really is.

Sequencing: Reading the Language of DNA

The chemical nature of DNA (which I cover in Chapter 6) and the replication process (which you can discover in Chapter 7) are essential to DNA sequencing. DNA sequencing also makes use of a reaction that's similar to the polymerase chain reaction (PCR) used in forensics; if you want more details about PCR, check out Chapter 18.

Identifying the players in DNA sequencing

The ingredients for DNA sequencing are:

- ✓ **DNA:** From a single individual of the organism to be sequenced.
- ✓ **Primers:** Several thousand copies of short sequences of DNA that are complementary to the part of the DNA to be sequenced. (Primers require knowledge of part of the DNA sequence before starting; see the sidebar “Making the Human Genome Project possible: Shotgun sequencing” for how researchers know which primers to use and where they get them.)
- ✓ **dNTPs:** Many As, Gs, Cs and Ts, put together with sugars and phosphates as nucleotides, the normal building blocks of DNA.
- ✓ **ddNTPs:** Many As, Gs, Cs, and Ts as nucleotides that each lack an oxygen atom at the 3' spot.
- ✓ **Taq polymerase:** The enzyme that puts the DNA molecule together (see Chapter 18 for more details on *Taq*).

The use of ddNTPs is the whole key to how sequencing works. Take a careful look at Figure 11-1. On the left is a generic dNTP, the basic building block of DNA used during replication (if you don't remember all the details,

flip back to Chapter 6 for more on dNTPs). The molecule on the right is ddNTP (*di-deoxyribonucleoside triphosphate*). The ddNTP is identical to the dNTP in every way except that it has no oxygen atom at the 3' spot. No oxygen means no reaction because the phosphate group of the next nucleotide can't form a phosphodiester bond (see Chapter 6) without that extra oxygen atom to aid the reaction. The next nucleotide can't hook up to ddNTP at the end of the chain, and the replication process stops. So how does *stopping* the reaction help the sequencing process? The idea is to create short pieces of DNA that give the identity of each and every base along the sequence.

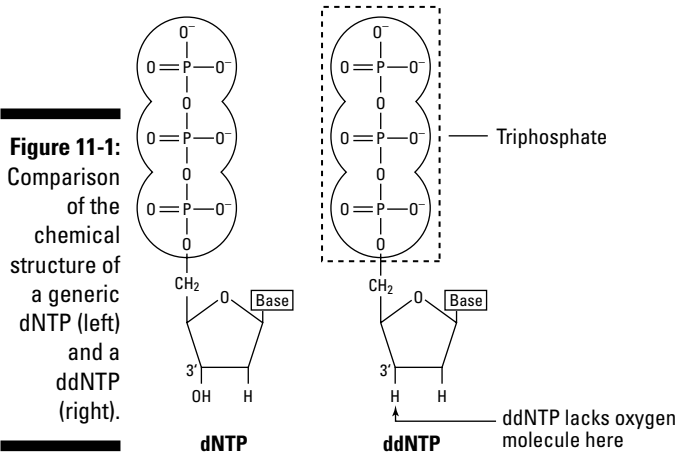

Breaking down the sequencing process

Here's how the process of sequencing works.

1. A mixture of the ingredients listed above is heated, melting the hydrogen bonds between the complementary bases of the template DNA. In essence, the DNA is “unzipped” into two template strands (technically, this unzipping is called *denaturing*). Step 1 of Figure 11-2 shows the denaturing process of the template DNA and its bases at this stage. Heat doesn't harm the phosphodiester bonds between the bases or damage the strands, so the template strands stay intact but unpaired throughout the sequencing process, and their information content isn't lost.
2. The mixture is cooled just enough to let the primers find their complements, as you can see in Figure 11-2. *Taq* polymerase finds the end of the primer and starts adding dNTPs complementary to the template strand going in the 3' direction (see Chapter 7 on replication for how DNA polymerases work and why the reaction proceeds in the 5' (3' direction).



As part of being incorporated into the strand, the dNTPs lose two phosphates, so technically, they're no longer dNTPs; instead, they're nucleotides (see Chapter 7). But to avoid confusing the different nucleotides — those that have reactive groups (dNTPs) and those that don't (ddNTPs) — I'll continue calling them dNTPs and ddNTPs, even though you now know that's not quite right.

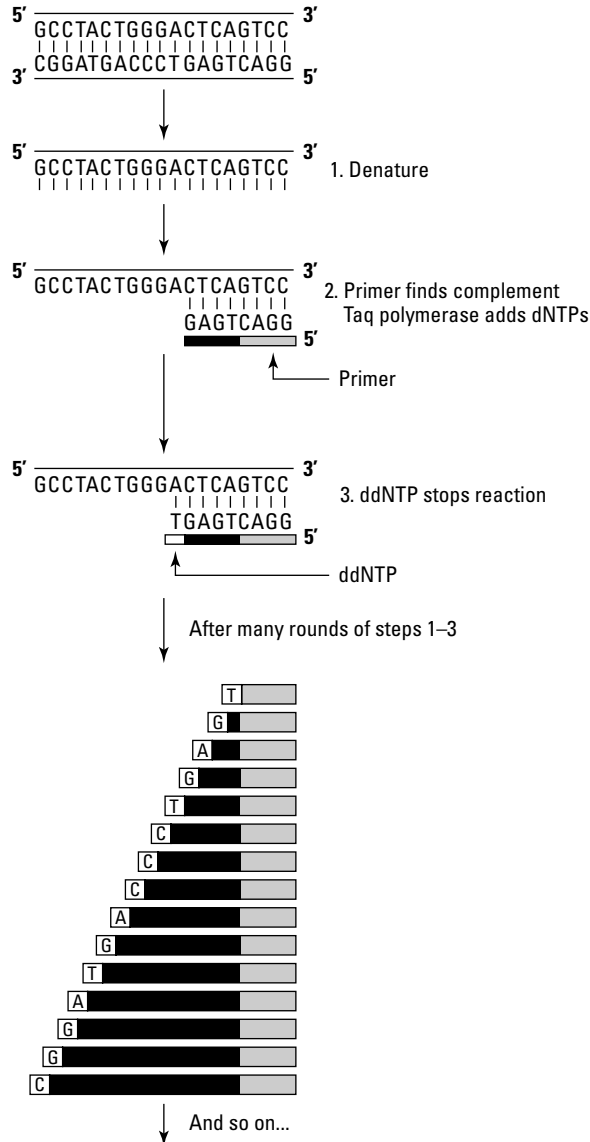

Figure 11-2:
The process
of DNA
sequencing.

3. *Taq* polymerase keeps adding dNTPs until, by random chance, a ddNTP is added. *Taq* polymerase can't add a dNTP (or another ddNTP for that matter) to the 3' end of a ddNTP because of the missing oxygen molecule. Therefore, what's left is a fragment of DNA (that is, the chain that's been building) that ends with a ddNTP. Each of the four ddNTPs carries a different colored dye, so the base — A, G, C, or T — that ends the reaction can be identified later.
4. The mixture is heated and cooled again and again. Thus, the reaction — melting (resulting in single-stranded templates), primers attaching, *Taq* polymerase adding dNTPs until a ddNTP stops the reaction — repeats. After 30 or 40 cycles, every single base along the entire template strand is represented by a complementary ddNTP that ends a fragment of DNA.

The end result of a typical sequencing reaction is 1,000 fragments representing 1,000 bases of the template strand. The shortest fragment is made up of a primer and one ddNTP representing the complement of the first base of the template. The next shortest fragment is made up of the primer, one nucleotide (from a dNTP), and a ddNTP — and so on (see Figure 11-2 for how the fragments stack up by size), with the largest fragment being 1,000 bases long.

Finding the message in sequencing results

In order to see the results of the sequencing reaction, the DNA fragments must be put through a process called *electrophoresis*. Electrophoresis is the movement of charged particles (in this case, DNA) under the influence of electricity. The purpose of electrophoresis is to sort the fragments of DNA by size, from smallest to largest. The smallest fragment gives the first base in the sequence, the second smallest fragment gives the second base, and so on until the largest fragment gives the last base in the sequence. This arrangement of fragments allows the sequence to be read in its proper order.

To carry out electrophoresis, DNA needs a medium to move through. A jelly-like substance called a *gel* is used for this purpose; the gel is made of *polyacrylamide*, the same stuff used to make soft contact lenses. When electricity is involved, opposites attract; so when exposed to two electrical poles, DNA, which carries a negative charge, is attracted to the positive pole (this is the electrophoresis part). The gel has pores in it (like the pores in your skin) that the DNA can wiggle through. As the DNA fragments worm their way through the gel, they generate friction, which creates resistance (like when you're pulling a couch over a carpeted floor). Small DNA fragments create less friction than large fragments, so the smaller fragments move the fastest.

A computer-driven machine called a sequencer uses a laser to “see” the colored dyes of the ddNTPs at the end of each fragment (see the sidebar “Making the Human Genome Project possible: Automated DNA sequencing” for the inner workings of a sequencer). The laser shines into the gel and “reads” the color of each fragment as it passes by. Fragments pass the laser

in size order, from smallest to largest. Each dye color signals a different letter: As show up green, Ts are red, Cs are blue, and Gs are yellow; the computer automatically translates the colors into letters and stores all the information for later analysis. The resulting picture is a series of peaks, like you see in Figure 11-3. Each peak represents a different base. The sequence indicated by the peaks is the *complement* of the template strand (see Chapter 6 for more on the complementary nature of DNA). When you know the complement of the template, you know the template sequence itself. This information can then be mined for the location of genes (see Chapter 9) and compared to the sequences of other organisms, such as those listed in Table 11-1.

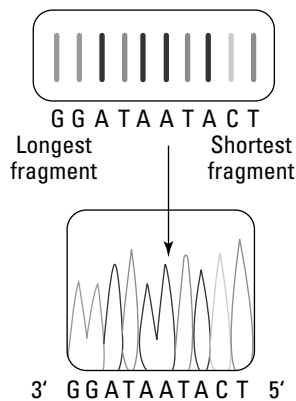

Figure 11-3:
Results of a
typical
sequencing
reaction.

Making the Human Genome Project possible: Shotgun sequencing

“Shotgun sequencing” may sound like a Hollywood western, but it’s really not. It’s the method researchers use to gather massive amounts of genetic data and put it together in the correct order. Shotgun sequencing is what allowed the Human Genome Project to be completed so quickly. Bacterial DNA was one of the first DNA to be sequenced, so in shotgun sequencing, scientists use knowledge of bacterial DNA to modify the bacterial chromosome. This modification allows them to slip in a chunk of DNA from another species. DNA from the organism to be sequenced, such as a human, is chopped into pieces using special enzymes (called restriction enzymes; see Chapter 22); then

researchers take the DNA fragments and pop them into the bacterial chromosomes. Using primers based on the already sequenced bacterial DNA, researchers can then sequence the inserted DNA. Powerful software programs compare all the sequences and look for identical sequences that signal a spot where two chunks of DNA fit together. These overlapping pieces are like the different shapes of a jigsaw puzzle, and the computer matches them together to create the larger picture. But because some parts of DNA are repetitive, it’s difficult to piece the repetitive parts together. This difficulty is why the HGP was hard to finish and explains why the first draft had so many errors.

Making the Human Genome Project possible: Automated DNA sequencing

The human genome has about 3 billion base pairs, and one round of sequencing identifies the order of only 1,000 bases. Prior to the Human Genome Project, sequencing was a very difficult and time-consuming enterprise. Getting a 1,000-base long sequence required about three days of work and used radioactive chemicals instead of dyes. Sequences were read by hand and had to be run over and over again to fill in gaps and correct mistakes. Every single sequence had to be entered into the computer by hand — imagine typing thousands of As, Gs, Ts, and Cs! It would have taken centuries to sequence the human genome using the old methods. The sheer magnitude of Human Genome Project required faster and easier techniques.

Numerous companies, government labs, and universities searched for solutions to make sequencing faster, better, and cheaper. The end

result was automated sequencing. The gel necessary for electrophoresis is contained inside a very thin tube (about the size of a wooden pencil lead) called a *capillary*. Each capillary is about two feet long, and there are usually 96 capillaries per sequencing machine. The fragments from the sequencing reaction are sucked into one end of the capillary, and electricity is applied. The DNA fragments start moving through the gel in the capillary tube and sort themselves out, shortest to longest. A laser sits at the far end of the gel and reads the color of each fragment as it passes by. Generally, one automated sequencer machine can produce 1,500 sequences (of 1,000 base pairs each) in about 24 hours. Many laboratories worked together using automated sequencers running 24 hours a day to power through the entire human genome. That's why it only took around 15 years to complete the HGP!

Chapter 12

Genetic Counseling

In This Chapter

- ▶ Using family trees to learn about your genes
 - ▶ Examining family trees for different kinds of inheritance
 - ▶ Exploring options for genetic testing
-

If you're thinking of starting a family or adding to your brood, you may be wondering what your little ones will look like. Will they get your eyes or your dad's hairline? But, if you know your family's medical history, you may also have significant worries about diseases such as cystic fibrosis, Tay-Sachs, or sickle cell anemia. You may worry about your own health, too, as you contemplate news stories dealing with cancer, heart disease, and diabetes, for example. All these concerns revolve around genetics and the inheritance of predisposition for a particular disease or inheritance of the disorder itself.

Genetic counselors are specially and rigorously trained to help people learn about the genetic aspects of their family medical histories. This chapter explains the process of genetic counseling, including how counselors generate family trees and estimate probability of inheritance and how genetic testing is done when genetic disorders are anticipated.

Getting to Know Genetic Counselors

Like it or not, you have a family. You have a mother and a father, grandparents, perhaps children of your own. You may not think of them, but you also have hundreds of ancestors — people you've never met — whose genes you carry and may pass down to descendants in the centuries to come.

Genetic counselors help people like you and me examine our families' genetic histories and uncover inherited conditions. *Genetic counselors* usually hold a master's degree in genetic counseling. They aren't trained as geneticists; instead, they have an extensive background in Mendelian genetics (and can solve genetics problems in a snap; see Chapters 3 through 5 for some examples) so that they can spot patterns that signal an inherited disorder. Genetic

counselors work with medical personnel like physicians and nurses to interpret medical histories of patients and their families. (For more on genetic counselors and other career paths in genetics, see Chapter 1.)

Genetics counselors perform a number of functions, including:

- ✓ Constructing and interpreting family trees, sometimes called *pedigrees*, to assess the likelihood that various inherited conditions will be (or have been) passed on to a particular generation.
- ✓ Counseling families about options for diagnosis and treatment of genetic conditions.

Physicians most commonly refer the following types of people or patients to genetic counselors:

- ✓ Women over 35 years of age who are pregnant or are planning a pregnancy
- ✓ People with a family history of a particular disorder, such as cystic fibrosis, who are planning a family
- ✓ Parents of a newborn who shows symptoms of a genetic disorder
- ✓ Women who are experiencing complications during a pregnancy
- ✓ Couples who have experienced more than one miscarriage or stillbirth
- ✓ Couples who are concerned about exposure to substances known to cause birth defects (such as radiation, viruses, drugs, and chemicals)
- ✓ People with a family history of inherited diseases like Parkinson's disease or certain cancers such as breast, ovarian, or prostate cancer who may be considering genetic testing to determine their risk of getting the disease

Many of the scientific reasons for the inheritance of genetic disorders are covered elsewhere in this book. Mutations within genes are the root cause of many genetic disorders (including cystic fibrosis, Tay-Sachs, and sickle cell anemia), and I cover mutation in detail in Chapter 13. Cancer — its causes and the genetic mechanics behind it — is covered in Chapter 14. Chromosomal disorders such Down syndrome, trisomy 13, and Fragile X are explained in Chapter 15. Finally, gene therapy treatments for inherited disorders are explained in Chapter 16.

Building and Analyzing a Family Tree

The first step in genetic counseling is drawing a family tree. The tree usually starts with the person for whom the tree is initiated; this person is called the *proband*. The proband can be a newly diagnosed child, a woman planning a

pregnancy, or an otherwise healthy person who's curious about risk for inherited disease. Often, the proband is simply the person who meets with the genetic counselor and provides the information used to plot out the family tree. The proband's position in the family tree is always indicated by an arrow, and he or she may or may not be affected by an inherited disorder.

A variety of symbols are used on family trees to indicate personal traits and characteristics. For instance, certain symbols convey gender, gene carriers, whether the person is deceased, and whether the person's family history is unknown. The manner in which symbols are connected show relationships between people, such as which offspring belong to which parents, whether someone is adopted, and whether someone is a twin. Check out Figure 12-1 for a detailed key to the symbols typically used in pedigree analysis.

In a typical pedigree, the age or date of birth of each person is noted on the tree. If deceased, the person's age at time of death and the cause of death are listed. Some genetic traits are more common in certain regions of the world, so it's useful to include all kinds of other details about family history on the pedigree, such as what countries people immigrated from. Every member of the family should be listed along with any medical information known about that person, including when medical disorders occurred. In the example included as part of Figure 12-1, the grandfather of the proband died of a heart attack at age 51. Including this information creates a record of all disorders with the relation to the family tree so that the counselor is more likely to detect every inherited disease present in the family. (Medical information doesn't appear in Figure 12-1, but it's normally a part of a tree.)

Medical problems often listed on pedigrees include:

- ✓ Cancer
- ✓ Alcoholism or drug addiction
- ✓ Mental illness or mental retardation
- ✓ Heart disease, high blood pressure, or stroke
- ✓ Asthma
- ✓ Kidney disease
- ✓ Birth defects, miscarriages, or stillbirths

Human couples have only a few children relative to other creatures, and we start producing offspring after a rather long childhood. Geneticists rarely see neat offspring ratios (such as four siblings with three affected and one unaffected) in humans that correspond to those observed in animals (take a look at Chapters 3 and 4 for more on common offspring ratios). Therefore, genetic counselors must look for very subtle signs to detect particular patterns of inheritance in humans.

	Male	Female	Sex specified	
Unaffected individual				Adoption: Brackets = adopted individuals; Dashed line = adoptive parents; Solid line = biological parents
Individual affected with trait				
Carrier: Has the gene but doesn't have the trait				Identical Nonidentical
Deceased individual				Twins
Proband				Example pedigree: Grandfather of the proband died of a heart attack at age 51. Grandfather is from generation I and referred to as I-1; proband, from generation III, is referred to as III-1.
Family history unknown				
Parents and Children: One boy and two girls (in birth order)				

Figure 12-1:
Symbols commonly used in pedigree analysis.

When the genetic counselor knows what kind of disorder or trait is involved, he or she can determine the likelihood a particular person will possess the trait or pass it on to his or her children. (Sometimes, the disorder is unidentified, such as when a person has a family history of “heart trouble” but doesn’t have a precise diagnosis.) Genetic counselors use the following terms to describe the individuals in a pedigree:

- ✓ **Affected:** Any person having a given disorder.
- ✓ **Heterozygote:** Any person possessing one copy of the gene coding for a disorder (an allele; see Chapter 2 for details). An unaffected heterozygote is called a *carrier*.
- ✓ **Homozygote:** Any person possessing two copies of the allele for a disorder. This person can also be described as *homozygous*.

The particular way in which most human genetic disorders are passed down to later generations — the *mode of inheritance* — is well established. After a genetic counselor determines which family members are affected or likely to be carriers, it’s relatively easy for them to determine the probability of another person being a carrier or inheriting the disorder.

In the following sections, I explore the modes of inheritance for human genetic disorders, how genetic counselors map these modes, and how you (and your

counselor) can figure out the probability of passing these traits on to offspring. For additional background on each of these modes of inheritance and the subject of inheritance in general, see Chapters 3 through 5.

Autosomal dominant traits

A *dominant* trait or disorder is one that's expressed (or manifested) in anyone who inherits the gene for the trait. *Autosomal dominant* means that the gene is carried on a chromosome other than a sex chromosome (meaning not on an X or a Y; see Chapter 3 for more details). In human pedigrees, autosomal dominant traits have some typical characteristics:

- ✓ Both males and females are affected with equal frequency.
- ✓ The trait doesn't skip generations.
- ✓ Affected children are born to an affected parent.
- ✓ If neither parent is affected, usually no child is affected.

Figure 12-2 shows the pedigree of a family with an autosomal dominant trait. In the figure, affected persons are shaded, and you can see clearly how only affected parents have affected children. The trait can be passed to a child from either the mother or the father. Generally, affected parents have a 50-percent chance of passing an autosomal dominant trait or disorder on to their children.

Some common autosomal dominant disorders are:

- ✓ Achondroplasia, a form of dwarfism
- ✓ Polydactyly, extra fingers and toes
- ✓ Marfan, a disorder affecting connective tissue (tendons, ligaments, and cartilage)
- ✓ Huntington disease, a progressive and fatal disease affecting the brain and nervous system

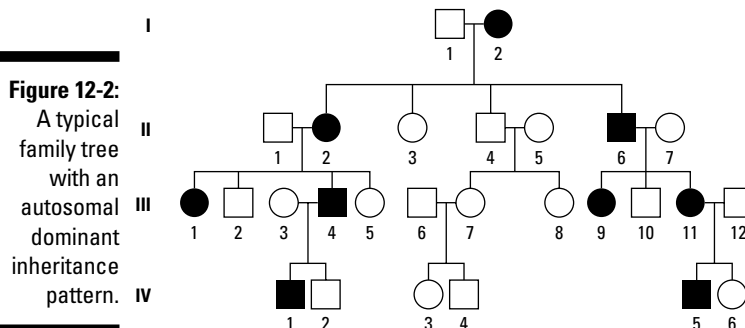

There are two exceptions to the normal pattern of autosomal dominant inheritance:

- ✔ **Reduced penetrance:** *Penetrance* is the percentage of individuals having a particular gene (genotype) that actually displays the physical characteristics dictated by the gene (or express the gene as phenotype, scientifically speaking; see Chapter 3 for a full rundown of genetics terms). Many autosomal dominant traits have complete penetrance, meaning that every person inheriting the gene shows the trait. But some traits have *reduced penetrance*, meaning only a certain percentage of individuals inheriting the gene show the phenotype. When an autosomal dominant disorder shows reduced penetrance, the phenotype skips generations. Check out Chapter 3 for more details on reduced penetrance.
- ✔ **New mutations:** In the case of new mutations that are autosomal dominant, the trait appears for the first time in a particular generation and appears in every generation thereafter. You can flip ahead to Chapter 13 to learn more details about mutations — how they occur and how they are passed on.

Autosomal recessive traits

Recessive disorders are expressed only when an individual inherits two identical copies of the gene causing the disorder. It's then said that the individual is *homozygous* for the gene causing the disorder (see Chapter 3 for more details on inheritance). Like autosomal dominant disorders, autosomal recessive disorders are coded in genes found on chromosomes other than sex chromosomes. In pedigrees, such as the one pictured in Figure 12-3, autosomal recessive disorders have the following characteristics:

- ✔ Males and females are affected equally.
- ✔ The disorder or trait skips one or more generations.
- ✔ Affected children are born to unaffected parents.
- ✔ Children born to parents who share common ancestry (such as ethnic or religious background) are more likely to be affected than those of parents with different backgrounds.

The probability of inheriting an autosomal recessive disorder varies depending on which alleles parents carry (see Chapter 3 for all the details on how the odds of inheritance are calculated):

- ✔ **When both parents are carriers**, every child born to the couple has a 25-percent chance of being affected.
- ✔ **When one parent is a carrier and the other isn't**, every child has a 50 percent chance of being a carrier. No child will be affected.

- ✔ **When one parent is a carrier and the other is affected**, each child has a 50 percent chance of being affected. All unaffected children from the union will be carriers.
- ✔ **When one parent is affected and the other is unaffected (and not a carrier)**, all children born to the couple will be carriers. No children will be affected.

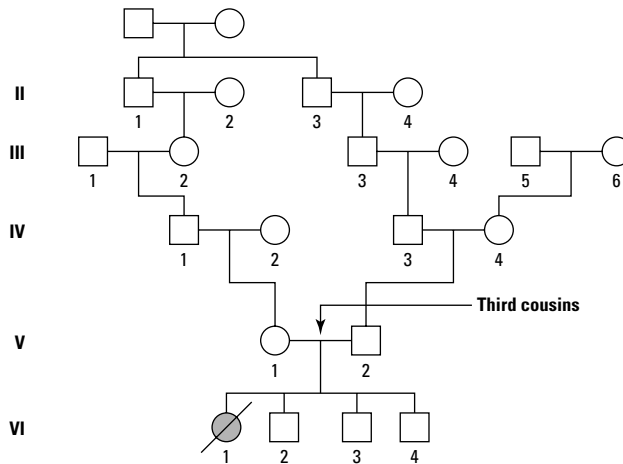

Figure 12-3:

A typical autosomal recessive disorder in a family tree.



Cystic fibrosis is an autosomal recessive disorder that causes severe lung problems in affected persons. As with all autosomal recessive disorders, if both members of a couple are carriers for cystic fibrosis, they have a 25 percent chance of producing at least one child that has the disease. That's because both the man and the woman are heterozygous for the allele that codes for cystic fibrosis, and each has a 50 percent probability of contributing the CF allele. The probability of *both* members of the couple contributing CF alleles in one fertilization event is calculated by multiplying the probability of each event happening independently. The probability the father contributes his CF allele is 50 percent or 0.5; the probability the mother contributes her CF allele is 50 percent or 0.5. The probability he contributes his allele *and* she contributes her allele is $0.5 \times 0.5 = 0.25$ or 25 percent. For more details on how probabilities of inheritance are calculated, flip back to Chapters 3 and 4.

Some autosomal recessive disorders are more common among people of certain religious or ethnic groups because people belonging to those groups tend to marry within the group. After many generations, everyone within the group shares common ancestry. When cousins or other close relatives marry, such relationships are referred to as *consanguineous* (meaning “same blood”). Generally, people who are more distantly related than fourth cousins aren't

considered “related,” but in fact, those persons still share alleles from a common ancestor. When populations are founded by rather small groups of people, those groups often have higher rates of particular genetic disorders than the general population; for more details, take a look at the sidebar “Genetic disorders in small populations.” In these cases, autosomal recessive disorders may no longer skip generations because so many persons are heterozygous and thus carriers of the disorder.

X-linked recessive traits

Males are XY and therefore have only one copy of the X-chromosome; they don’t have a second X to offset the expression of a mutant allele on the affected X. Thus, similar to autosomal dominant disorders, X-linked recessive disorders express the trait fully in males, even though not homozygous. Females rarely show X-linked recessive disorders because being homozygous for the disorder is very rare. In pedigrees, X-linked recessive disorders have the following characteristics:

- ✓ Far more males than females are affected.
- ✓ The disorder skips one or more generations.
- ✓ Affected sons are born to unaffected mothers.
- ✓ The trait is *never* passed from father to son.

Genetic disorders in small populations

The Pennsylvania Amish don’t have electricity in their homes, don’t drive cars, and don’t use e-mail or cellphones. They live simply in the modern world as a religious way of life. Because Amish people marry within their faith, certain genetic disorders are common. Amish families come by horse and buggy to the Clinic for Special Children in Strasburg, Pennsylvania, for genetic testing. By partnering with an ultra-high-tech company, the clinic provides rapid, inexpensive genetic testing. For example, the Old Order Amish of southeastern Pennsylvania suffer from a devastating form of Sudden Infant Death Syndrome (SIDS).

Altogether, the Bellville Amish Community has mourned the loss of over 21 babies (one family lost six infants to the disorder). Researchers at the Translational Genomics Research Institute in Phoenix, Arizona, were able to locate the mutated gene that causes the SIDS using microarray technology (see Chapter 23). Sadly, no treatment yet exists for this type of SIDS, but gene therapy (which I cover in Chapter 16) may offer hope for small populations such as the Amish.

Unaffected parents can have unaffected daughters and one or more affected sons. Women who are carriers frequently have brothers with the disease, but if families are small, a carrier may have no affected immediate family members. Sons of affected fathers are never affected, but affected fathers' daughters are always carriers because daughters must inherit one of their X-chromosomes from their fathers. In this case, that X-chromosome will always carry the allele for the disorder. The pedigree in Figure 12-4 is a classic example of a well-researched family possessing many carriers for the X-linked disorder hemophilia, a devastating disorder that prevents normal clotting of the blood. For more on the royal families whose history is pictured in Figure 12-4, see the sidebar “A royal pain in the genes.”



The probability of inheritance of X-linked disorders depends on gender. Female carriers have a 50 percent likelihood of passing the gene on to each child. Males determine the gender of their offspring, making the chance of any particular child being a boy is 50 percent. Therefore, the likelihood of a carrier mom having an affected son is 25 percent (chance of having a son = 0.5; chance of a son inheriting the affected X = 0.5; therefore, $0.5 \times 0.5 = 0.25$ or 25 percent).

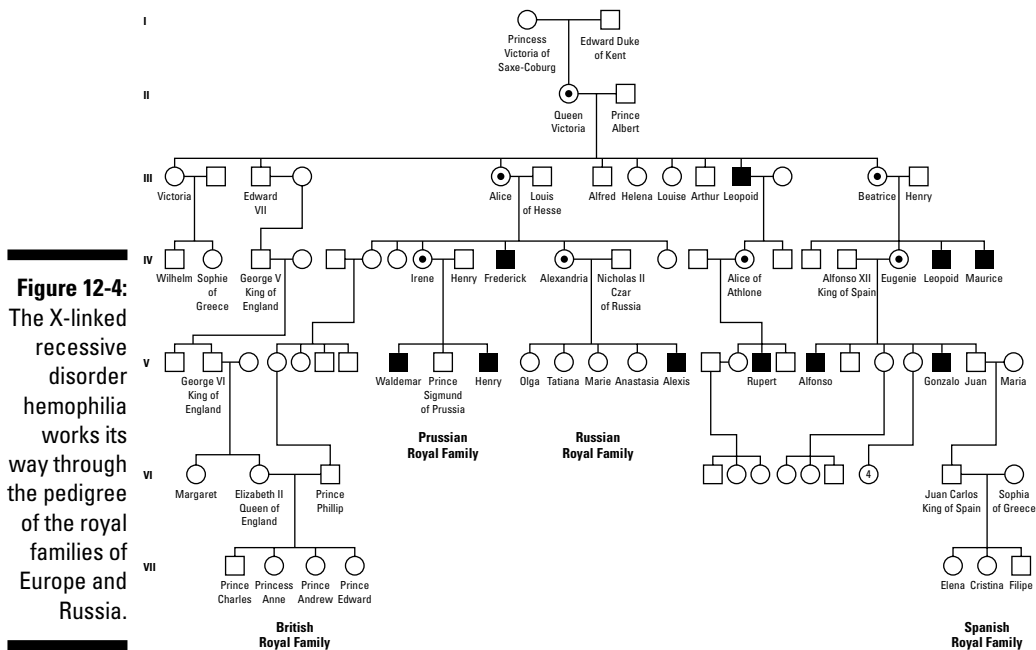



A royal pain in the genes

One of the most famous examples of an X-linked family pedigree is found in the royal families of Europe and Russia, which you can see in Figure 12-4. Queen Victoria of England had one son affected with hemophilia. It's not clear who Queen Victoria inherited the allele from; she may have been the victim of spontaneous gene mutation. In any event, two of her daughters were carriers, and she had one affected son, Leopold. Queen Victoria's granddaughter Alexandra was also a carrier. Alexandra married Nicholas Romanov, who became Czar of Russia, and together they had five children: four daughters and one son. The son, Alexis, suffered from hemophilia.

The role Alexis's disease played in his family's ultimate fate is debatable. Clearly, however, one of the men who influenced the downfall of Russia's royal family was linked to the family as Alexis's "doctor." Gregory Rasputin was a self-proclaimed faith healer; in photographs, he appears wild-eyed and deeply intense. He's generally perceived to have been a fraud, but at the time, he

had a reputation for miraculous healings, including helping little Alexis recover from a bleeding crisis. Despite Rasputin's talent for healing, Alexis didn't live to see adulthood. Shortly after the Russian Revolution broke out, the entire Russian royal family was murdered. (Rasputin himself had been murdered some two years earlier.)

In a bizarre final twist to the Romanov tale, a road repair crew discovered the family's bodies in 1979. Oddly, two of the family members were missing. Eleven people were supposedly killed by firing squad on the night of July 16, 1918: the Russian royal family (Alexandra, Nicholas, and their five children) along with three servants and the family doctor. However, the bodies of Alexis and his little sister, Anastasia, have never been found. Using DNA fingerprinting, researchers confirmed the identities of Alexandra and her children by matching their mitochondrial DNA to that of one of Queen Victoria's living descendants, Prince Philip of England. (To find out more about the forensic uses of DNA, flip to Chapter 18.)

X-linked dominant traits

Like autosomal dominant disorders, X-linked dominant traits don't skip generations. Every person inheriting the allele expresses the disorder. The family tree pictured in Figure 12-5 shows many of the hallmarks of X-linked dominant disorders:

- ✔ Both males and females are affected.
- ✔ The trait doesn't skip generations.
- ✔ Affected mothers have both affected sons and daughters.
- ✔ All daughters of affected fathers are affected.

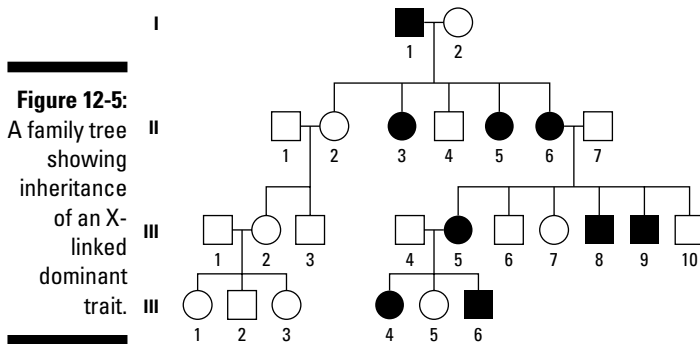

X-linked dominant traits show up more often in females than males because females can inherit an affected X from either parent. Affected females have a 50 percent chance of having an affected child of either sex. Males never pass their affected X to sons; therefore, sons of affected fathers and unaffected mothers have *no* chance of being affected in contrast to daughters, who are always affected. The probability of an affected man having an affected child is 50 percent (that is, equal to the likelihood of having a daughter).

Y-linked traits

The Y-chromosome is passed strictly from father to son. By definition, Y-chromosome traits are considered *hemizygous*, meaning there's only one copy of the chromosome, not two (see Chapter 5). Y-chromosome traits are expressed as if they were dominant because there's only one copy of the allele per male with no other allele to offset the effect of the gene. Y-linked traits are easy to recognize when seen in a pedigree, such as Figure 12-6, because they have the following characteristics:

- ✓ Affected men pass the trait to all their sons.
- ✓ No women are ever effected.
- ✓ The trait doesn't skip generations.

Because the Y-chromosome is tiny and has relatively few genes, Y-linked traits are very rare. Most of the genes involved control male-only traits such as sperm production and testis formation. If you're female and your dad has hairy ears, you can relax — hairy ears is also considered a Y-linked trait.

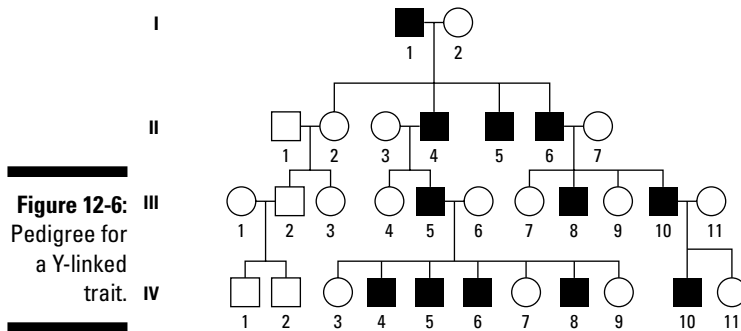

Staying Ahead of the Game: Genetic Testing

With the advent of many new technologies (many of which grew out of the Human Genome Project, which I explain in Chapter 11), genetic testing is easier and cheaper than ever. Genetic testing and genetic counseling often go hand in hand. The genetic counselor works to identify which disorders occur in the family, and testing then examines the DNA directly to determine if the disorder-causing gene is present. Your physician may refer you or a family member for genetic testing for a variety of reasons, particularly if you

- ✓ Are a healthy person with a family history of a recessive disorder, and you're thinking about having a child.
- ✓ Are a pregnant woman over 35 years of age.
- ✓ Are an affected person and need to confirm a diagnosis.
- ✓ Are a healthy person concerned about certain heritable disorders in your family such as breast cancer or Huntington chorea.
- ✓ Have an infant who's at risk (because his or her parents are known or suspected carriers).

General testing

Every person the world over carries one or more alleles that cause genetic disease. Most of us never know which alleles or how many we carry. If you have a family member who's affected with a rare genetic disorder, particularly an autosomal dominant disorder with incomplete penetrance or delayed onset, you may be vitally concerned about which allele(s) you carry. Persons currently

unaffected with certain disorders can seek genetic testing to learn if they're carriers. Most tests involve a blood sample, but some are done with a simple cheek swab to capture a few skin cells.

Prenatal testing

Prenatal diagnosis is commonly used for unborn children of women over 35 years of age because such women are much more likely than younger women to have children with chromosomal disorders (see Chapter 15). Prenatal testing is designed to allow couples time to make decisions about treatments to be administered either during pregnancy or after delivery of an affected infant.

Amniocentesis and chorionic villus sampling

For definitive diagnosis of a genetic disorder, testing requires tissue of the affected person. Two common prenatal tests used to obtain fetal tissue for testing are *chorionic villus sampling* (CVS) and *amniocentesis*. Both tests require ultrasound to accurately guide the instruments used to obtain the samples (see the following section for more info on ultrasound).

- ✓ **CVS** is usually done late in the first trimester of pregnancy (weeks 8 to 12). A catheter is inserted vaginally and guided to the outer layer of the placenta, called the *chorion*. Gentle suction is used to collect a small sample of chorionic tissue. The placental tissue arises from the fetus, not the mother, so the cells collected give an accurate picture of the fetus's chromosome number and genetic profile. The advantages of CVS are that it can be done earlier than most other prenatal tests; it's extremely accurate; and because a relatively large sample is obtained, results are rapidly produced. CVS is associated with a slightly higher rate of miscarriage, however, and rarely, infants subjected to CVS have limb deformities.
- ✓ **Amniocentesis** is usually done early in the second trimester of pregnancy (weeks 12 to 16). Amniocentesis is used to obtain a sample of the amniotic fluid that surrounds the growing fetus because amniotic fluid contains fetal cells (skin cells that have sloughed off) that can be examined for prenatal testing. The fluid is drawn directly from the uterus using a needle inserted through the abdomen. Because fetal cells in the fluid are at a very low concentration, the cells must be grown in a lab to provide enough tissue for testing, making results slow to come (about one to two weeks). When they're obtained, however, results are accurate, and complications following the procedure (such as miscarriage) are rare.

Ultrasound

Ultrasound technology allows physicians to visually examine a growing fetus along with its spinal cord, brain, and all its organs. Ultrasound directs extremely high frequency sound waves through the abdominal wall of the

mother. The sound waves bounce off the fetus and return to a receiver that then converts the sound wave “picture” into a visual image. New ultrasound technologies include powerful computers that put together a three-dimensional image, giving amazingly crisp pictures of facial features and body parts. Ultrasound is generally used to diagnose genetic disorders that are associated with physical features or deformities. However, some chromosomal disorders, such as Down syndrome, may also be provisionally diagnosed using ultrasound. Ultrasound can be used at any time during pregnancy and is completely non-invasive, with little or no risk to mother or baby.

Newborn screening

Some genetic disorders are highly treatable using dietary restrictions. Therefore, all newborns in the United States are tested for two common, highly treatable genetic disorders: *phenylketonuria* and *galactosemia*. Both of these disorders are autosomal recessive.

- ✓ **Phenylketonuria** causes mental retardation due to the build up of *phenylalanine* (an amino acid that’s part of a normal diet) in the brain of affected persons. A diet low in phenylalanine allows such persons to live symptom-free lives. (This disorder and the potential to control it are the reasons certain diet colas contain warning labels regarding phenylalanine content.) Phenylketonuria occurs once in every 10,000 to 20,000 births.
- ✓ **Galactosemia** is a disorder similar to phenylketonuria that results from an inability to break down one of the products of lactose (milk sugar). A lactose-free diet allows affected persons to live symptom-free lives. If untreated, galactosemia results in brain damage, kidney and liver failure, and often, death. Galactosemia occurs once in every 45,000 births.



Testing for these two disorders isn’t actually genetic testing; rather, the tests are designed to look for the presence of abnormal amounts of either phenylalanine or galactose — the phenotypes of the disorders.

Chapter 13

Mutation and Inherited Diseases

In This Chapter

- ▶ Getting to the root of mutation
- ▶ Grasping how mutations occur
- ▶ Realizing the consequences of mutation

Despite what you may think, mutation is good thing. *Mutation*, which is simply genetic change, is responsible for all phenotypic variation. Variation in flower colors and plant height, the flavor of different varieties of apples, the differences among dog breeds, you name it — the natural process that created all those different phenotypes was mutation. Mutation occurs all the time, spontaneously and pretty much randomly. But like many good things, mutation can also be bad. It can disrupt normal gene activity and cause disease such as cancer (flip to Chapter 14 for details) and birth defects (see Chapter 15). In this chapter, you discover what causes mutations, how DNA can repair itself in the face of mutation, and the consequences when repair attempts fail.

Starting Off with Types of Mutations



Mutations fall into two major categories, and the distinction between the two is important to keep in mind:

- ✓ **Somatic mutations:** Mutations in body cells that don't make eggs or sperm. Mutations that occur in the somatic cells aren't *heritable* — that is, the changes can't be passed from parent to offspring — but they do affect the person with the mutation.
- ✓ **Germ-cell mutations:** Mutations in the sex cells (germ cells like eggs and sperm; see Chapter 2 for the scoop on cell types) that lead to embryo formation. Unlike somatic mutations, germ-cell mutations often don't affect the parent. Instead, they affect the offspring of the person with the mutation and are heritable from then on.



Some disorders have elements of both somatic and germ-cell (heritable) mutations. Many cancers that run in families arise as a result of somatic mutations in persons who are already susceptible to the disease because of mutations inherited from one or both parents. (You can find out more about heritable cancers in Chapter 14.)

Both somatic and germ-cell mutations usually come about, in a general sense, because of

✔ **Substitutions of one base for another:** Substitutions are sometimes called *point mutations*. Usually only one mistaken base is involved, although sometimes both the base and its complement are changed (for a review of the chemistry of DNA, turn back to Chapter 6). This type of mutation breaks down further into two categories:

- **Transition mutation:** When a purine base is substituted for the other purine or one pyrimidine is substituted for the other pyrimidine. Transition mutations are the most common form of substitution errors.
- **Transversion mutation:** When a purine replaces a pyrimidine (or vice versa).

✔ **Insertions and deletions of one or more bases:** When an extra base is added to a strand, the error is called an *insertion*. Dropping a base is considered a *deletion*. Insertions and deletions are the most common forms of mutation.

When the change happens within a gene, both insertions and deletions lead to a change in the way the genetic code is read during translation (flip to Chapter 9 for a translation review). Translation involves reading the genetic code in three-letter batches, so when one or two bases are added or deleted, the reading frame is shifted. This *frameshift mutation* results in a completely different interpretation of what the code says and produces an entirely different amino acid strand. As you can imagine, these effects have disastrous consequences because the expected gene product isn't produced. If three bases are added or deleted, the reading frame isn't affected. The result of a three-base insertion or deletion, called an *in-frame mutation*, is that one amino acid is either added (insertion) or lost (deletion). In-frame mutations can be just as bad as frameshift mutations. The consequences of these sorts of mutations are covered in the section "Facing the Consequences of Mutation" later in this chapter.

Uncovering Causes of Mutation

Mutations can occur for a whole suite of reasons. In general, though, the causes of mutations are either random or due to exposure to outside agents such as chemicals or radiation. In the sections that follow, I delve into each of these causes.

Spontaneous mutations



Spontaneous mutation occurs randomly and without any urging from some external cause. It's a natural, normal occurrence. Because the vast majority of your DNA doesn't code for anything, most spontaneous mutation goes unnoticed (check out Chapter 11 for more details about your noncoding "junk" DNA). But when mutation occurs within a gene, the function of the gene can be changed or disrupted. Those changes can then result in unwanted side effects (such as cancer, which I address in Chapter 14).

Scientists are all about counting, sorting, and quantifying, and it's no different with mutations. Spontaneous mutations are measured in the following ways:

- ✓ **Frequency:** Mutations are sometimes measured by the frequency of occurrence. *Frequency* is the number of times some event occurs within a group of individuals. When you hear that one in some number of persons has a particular disease-causing allele, the number being expressed is a frequency. For example, the X-linked disease hemophilia is estimated by one study to have a frequency of 13 cases for every 100,000 males.
- ✓ **Rate:** Another way of looking at mutations is in the framework of a rate, like the number of mutations occurring per round of cell division or mutations per gamete or per generation. Mutation rates appear to vary a lot from organism to organism. Even within a species, mutation rates vary depending upon the part of the genome being examined. Some convincing studies show that mutation rate even varies by sex and that mutation rates are higher in males than females (check out the sidebar "Dad's age matters, too" for more on this topic). Regardless of how it's viewed, spontaneous mutation occurs at a steady but very low rate (like around one per million gametes).



Most spontaneous mutations occur as a result of mistakes made during replication (all the details of how DNA replicates itself are in Chapter 7). There are three main sources of error during replication:

- ✓ Mismatched bases that are overlooked during proofreading
- ✓ Strand slipups that lead to deletions or insertions
- ✓ Spontaneous but natural chemical changes that cause bases to be misread during replication, resulting in substitutions or deletions

Mismatches during replication

Usually, mistakes made during replication are caught and fixed by DNA polymerase. DNA polymerase has the job of reading the template, adding the appropriate complementary base to the new strand, and then proofreading the new base before moving to the next base on the template. DNA polymerase can snip out erroneous bases and replace them, but occasionally, a wrong

base escapes detection. Such an error is possible because non-complementary bases can form hydrogen bonds through what's called *wobble pairing*. As you can see in Figure 13-1, wobble pairing can occur

- ✔ **Between thymine and guanine** without any modifications to either base (because these non-complementary bases can sometimes form bonds in odd spots).
- ✔ **Between cytosine and adenine** only when adenine acquires an additional hydrogen atom (called *protonation*).

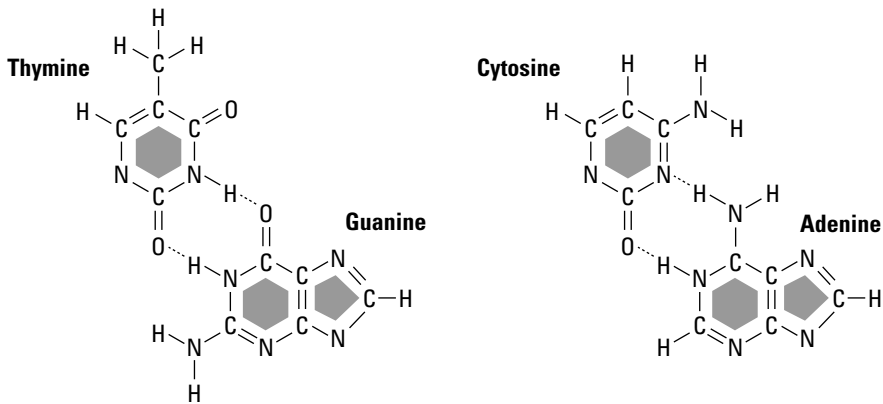
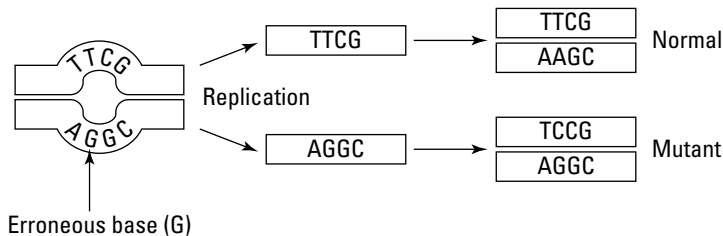

Figure 13-1:
Wobble base pairing allows mismatched bases to form bonds.

If DNA repair crews don't catch the error and fix it (see the section "Evaluating Options for DNA Repair" in this chapter) and the mismatched base remains in place, the mistake is perpetuated after the next round of replication, apparent in Figure 13-2. The mistaken base is read as part of the template strand, and its complement is added to the newly replicated strand opposite. Thus, the mutation is permanently added to the structure of the DNA in question.

Figure 13-2:

A mismatched base pair creates a permanent change in the DNA with one round of replication.



Dad's age matters, too

The relationship between maternal age and an increased incidence of birth defects, particularly Down syndrome, is very well known. Nondisjunction events, or the failure of chromosomes to separate normally during meiosis, in developing eggs are thought to be a consequence of aging in women. Very few similar genetic problems appear to arise in men, who, unlike women, produce new *gametes* (reproductive cells), in the form of sperm, throughout their lifetimes. However, older men are susceptible to germ-cell mutations that can cause heritable disorders in their children.

The pattern of spontaneous mutation in germ cells of older men was first noticed by a German physician during the early part of the 20th century. Wilhelm Weinberg is best known for his contribution to population genetics, commemorated by the Hardy-Weinberg equilibrium equation (jump to Chapter 17 for the scoop). Weinberg published many papers on genetics, including the genetics of *achondroplasia*, an autosomal dominant form of dwarfism that's typified by shortened limbs and an enlarged head. Weinberg noticed that children

with achondroplasia were more common among older fathers with no family history of the disorder than younger fathers with no family history. Weinberg boldly stated that this contrast was due to mutation. Forty years later, a geneticist confirmed the accuracy of Weinberg's supposition.

The reason that older men are more susceptible to spontaneous germ-cell mutations is the same reason they're less likely to have nondisjunctions — males produce sperm throughout their lives. This continued sperm production means that a 50-year-old man's germ cells have replicated over 800 times. As DNA ages, replication gets less accurate, and repair mechanisms become faulty. Thus, older fathers have an increased risk (although it's still only slight) of fathering children with genetic disorders. Achondroplasia isn't the only disorder associated with spontaneous mutation in aging men; several other disorders, including Marfan (a disorder of skeletal and muscle tissue that causes heart problems) and progeria (a disease that causes rapid aging in children) are also associated with older fathers.

Strand slipups

Both strands of DNA are copied more or less at the same time during replication. Occasionally, a portion of one strand (either the template or the newly synthesized strand) can form a loop in a process called *strand slippage*. In Figure 13-3, you can see that strand slippage in the new strand results in an insertion, and slippage in the template strand, results in a deletion.



Strand slippage is associated with repeating bases. When one base is repeated more than five times in row (AAAAAA, for example) or when any number of bases are repeated over and over (such as AGTAGTAGT), strand slippage during replication is far more likely to occur. In some cases, the mistakes produce lots of variation in noncoding, junk DNA, and the variation's useful for determining individual identity; this is the basis for DNA fingerprinting (see Chapter 18 for that discussion). When repeat sequences occur within genes, the addition of new repeats leads to a stronger effect of the gene. This strengthening effect, called *anticipation*, occurs in genetic disorders such as Huntington disease. (You can find out more about anticipation in Chapter 4.)

Another problem generated by repeated bases is unequal crossing-over. During meiosis, homologous chromosomes are supposed to align exactly so that exchanges of information are equal and don't disrupt genes (turn to Chapter 2 for meiosis review). Unequal crossing-over occurs when the exchange between chromosomes results in uneven amounts of material being swapped. Repeated sequences cause unequal crossovers because there are so many similar bases that match. The identical bases can align in multiple, matching ways that result in mismatches elsewhere along the chromosome. Unequal crossover events lead to large-scale chromosome changes (like those described in Chapter 15). Chromosomes in cells affected by cancer are also vulnerable to crossing-over errors (see Chapter 14 for details).

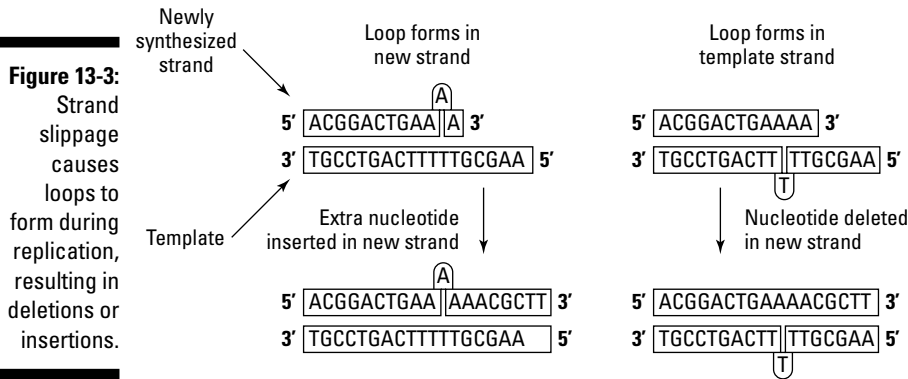

Spontaneous chemical changes

DNA can undergo spontaneous changes in its chemistry that result in both deletions and substitutions. DNA naturally loses purine bases at times in a process called *apurination*. Most often, a purine is lost when the bond between adenine and the sugar, deoxyribose, is broken. (See Chapter 6 for a reminder of what a nucleotide looks like.) When a purine is lost, replication treats the spot occupied by the orphaned sugar as if it never contained a base at all, resulting in a deletion.

Deamination is another chemical change that occurs naturally in DNA. It's what happens when an amino group (composed of a nitrogen atom and two hydrogens, NH_2) is lost from a base. Figure 13-4 shows the before and after stages of deamination. When cytosine loses its amino group, it's converted to uracil. Uracil normally isn't found in DNA at all because it's a component of RNA. If uracil appears in a DNA strand, replication replaces the uracil with a thymine, creating a substitution error. Until it's snipped out and replaced during repair (see "Evaluating Options for DNA Repair" later in this chapter), uracil acts as a template during replication and pairs with adenine. Ultimately, what was a C-G pair transitions into an A-T pair instead.

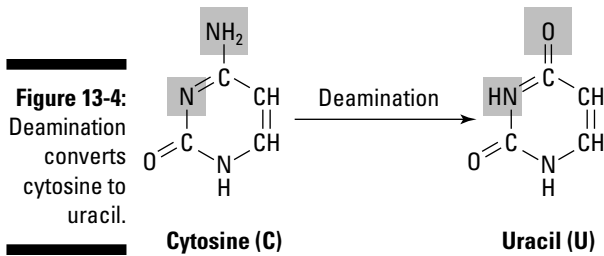

Induced mutations



Induced mutations result from exposure to some outside agent such as chemicals or radiation. It probably comes as no surprise to you to find out that many chemicals can cause DNA to mutate. *Carcinogens* (chemicals that cause cancers) aren't uncommon; the chemicals in cigarette smoke are probably the biggest offenders. In addition to chemicals that cause mutations, sources of radiation, from X-rays to sunlight, are also mutagenic. A *mutagen* is any factor that causes an increase in mutation rate. Mutagens may or may not have phenotypic effects — it depends on what part of the DNA is affected. The following sections cover two major categories of mutagens: chemicals and radiation. Each causes different damage to DNA.

Chemical mutagens

The ability of chemicals to cause permanent changes in the DNA of organisms was discovered by Charlotte Auerbach in the 1940s (see the sidebar “The chemistry of mutation” for the full story). There are many types of mutagenic chemicals; the following sections address four of the most common.

Base analogs

Base analogs are chemicals that are structurally very similar to the bases normally found in DNA. Base analogs can get incorporated into DNA during replication because of their structural similarity to normal bases. One base analog, 5-Bromouracil, is almost identical to the base thymine. Most often, 5-bromouracil (also known as 5BU), which is pictured in Figure 13-5, gets incorporated as a substitute for thymine and as such is paired with adenine. The problem arises when DNA replicates again with 5-bromouracil as part of the template strand; 5BU's mistaken for a cytosine and gets mispaired with guanine. The series of events looks like this: 5-bromouracil is incorporated where thymine used to be, so T-A becomes 5BU-A. After one round of replication, the pair is 5BU-G because 5BU is prone to chemical changes that make it a mimic of cytosine, the base normally paired with guanine. After a second of replication, the pair ends up as C-G because 5BU isn't found in normal DNA. Thus, an A-T ends up as a C-G pair.

Another class of base analog chemicals that foul up normal base pairing is *deaminators*. Deamination is a normal process that causes spontaneous mutation; however, problems arise because deamination can get speeded up when cells are exposed to chemicals that selectively knock out amino groups converting cytosines to uracils.

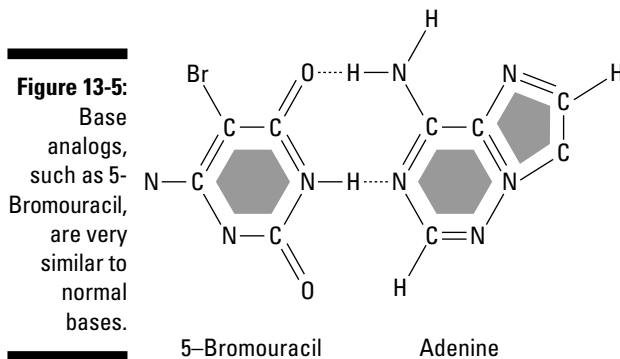

Alkylating agents

Like base analogs, *alkylating agents* induce mispairings between bases. Alkylating agents, such as the chemical weapon mustard gas, add chemical groups to the existing bases that make up DNA. As a consequence, the altered bases pair with the wrong complement, thus introducing the mutation. Surprisingly, alkylating agents are often used to fight cancer as part of chemotherapy; therapeutic versions of alkylating agents may inhibit cancer growth by interfering with the replication of DNA in rapidly dividing cancer cells.

Unusually reactive forms of oxygen

Some forms of oxygen, called *free radicals*, are unusually reactive, meaning they react readily with other chemicals. These oxygens can damage DNA directly (by causing strand breaks) or can convert bases into new unwanted chemicals that, like most other chemical mutagens, then cause mispairing during replication. Free radicals of oxygen occur normally in your body as a product of metabolism, but most of the time, they don't cause any problems. Certain activities, such as cigarette smoking and high exposure to radiation, pollution, and weed killers, increase the number of free radicals in your system to dangerous levels.

Intercalating agents

Many different kinds of chemicals wedge themselves between the stacks of bases that form the double helix itself, disrupting the shape of the double helix. Chemicals with flat ring structures, such as dyes, are prone to fitting themselves between bases in a process called *intercalation*. Figure 13-6 shows

intercalating agents at work. Intercalating agents create bulges in the double helix that often result in insertions or deletions during replication, which in turn cause frameshift mutations.

Figure 13-6: Intercalating agents fit between the stacks of bases to disfigure the double helix.

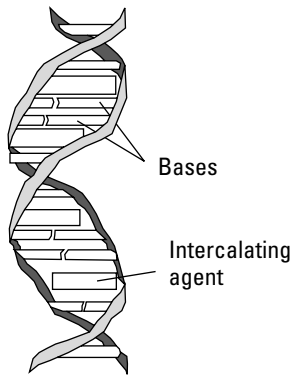

Radiation

Radiation damages DNA in a couple of different ways. First, radiation can break the strands of the double helix by knocking out bonds between sugars and phosphates (see Chapter 6 for a review of how the strands are put together). If only one strand is broken, the damage is easily repaired. But when two strands are broken, large parts of the chromosome can be lost; these kinds of losses can affect cancer cells (see Chapter 14) and cause birth defects (see Chapter 15).

Second, radiation causes mutation through the formation of *dimers*. Dimers (*di-* meaning two, *mer* meaning thing) are unwanted bonds between two bases stacked on top of each other (on the same side of the helix rather than on opposite sides). They're most often formed when two thymines in a DNA sequence bind together, which you can see in Figure 13-7.

Figure 13-7: Adjacent thymines can bond together to form dimers, which damage the double helix.

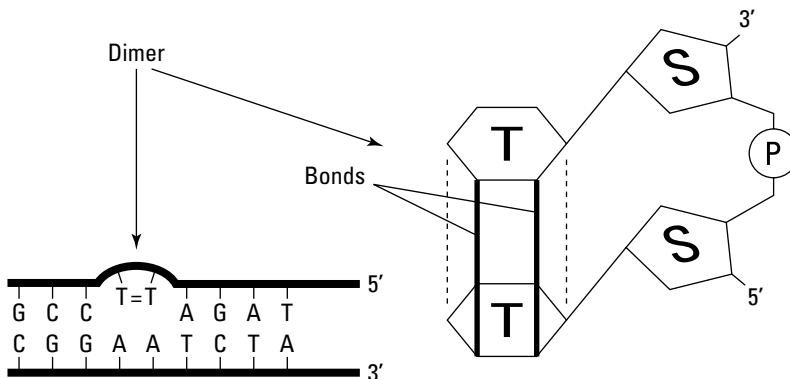



The chemistry of mutation

If ever anyone had an excuse to give up, it's Charlotte Auerbach. Born in Germany in 1899, Auerbach was part of a lively and highly educated Jewish family. In spite of her deep interest in biology, she became a teacher, convinced that higher education would be closed to her because of her religious heritage. As anti-Jewish sentiment in Germany grew, Auerbach lost her teaching job in 1933 when every Jewish secondary-school teacher in the country was fired. As a result, she emigrated to Britain where she earned her PhD in genetics in 1935.

Charlotte Auerbach didn't enjoy the respect her degree and abilities deserved. She was treated as a lab technician and instructed to clean the cages of experimental animals. All that changed when she met Herman Muller in 1938. Like Auerbach, Muller was interested in how genes worked; his approach to the problem was to induce mutations using radiation and then

examine the effects produced by the defective genes. Inspired by Muller, Auerbach began work on chemical mutagens. She focused her efforts on mustard gas, a horrifically effective chemical weapon used extensively during World War I. Her research involved heating liquid mustard gas and exposing fruit flies to the fumes. It's a wonder her experiments didn't kill her.

What Charlotte's experiments did do was show that mustard gas was an alkylating agent, a mutagen that causes substitution mutations. Shortly after the end of World War II and after persevering through burns caused by hot mustard gas, Auerbach published her findings. At last, she received the recognition and respect her work warranted. Charlotte Auerbach went on to have a long and highly successful career in genetics. She stopped working only after old age robbed her of her sight. She died in Edinburgh, Scotland, in 1994 at the age of 95.

Thymine dimers can be repaired, but if damage is extensive, the cell dies (see Chapter 14 for how cells are programmed to die). When dimers aren't repaired, the machinery of DNA replication assumes that two thymines are present and puts in two adenines. Unfortunately, cytosine and thymine can also form dimers, so the default repair strategy sometimes introduces a mutation instead.

Facing the Consequences of Mutation

When a gene mutates and that mutation is passed along to the next generation, the new, mutated version of the gene is considered a new allele. *Alleles* are simply alternative forms of genes. For most genes, many alleles exist. The effects of mutations that create new alleles are compared with the mutation's physical (*phenotypic*) effects. If the mutation has no effect, it's considered *silent*. Most silent mutations result from the redundancy of the genetic code. The code is redundant in the sense that multiple combinations of bases have identical meanings (see Chapter 9 for more about the redundancy of genetic code).

Sometimes, mutations cause a completely different amino acid to be put in during translation. Mutations that actually alter the code are called *missense mutations*. A *nonsense mutation* occurs when a message to stop translation (called a stop codon) is introduced into the middle of the sequence (see Chapter 9 for more on translation). The introduction of the stop codon usually means the gene stops functioning altogether.

Mutations are often divided into two types:

- ✔ **Neutral:** When the amino acid produced from the mutated gene still creates a fully functional, normal protein (via translation; see Chapter 9).
- ✔ **Functional change:** When a new protein is created, representing a change in function of the gene. Changes in function caused by mutations can be either gains or losses. A *gain-of-function mutation* creates an entirely new trait or phenotype. Sometimes, the new trait is harmless, like a new eye color. In other cases, the gain is decidedly harmful and usually autosomal dominant (flip to Chapter 12 for more on autosomal dominant traits) because the gene is producing a new protein that actually does something (the gain-of-function part). Even though there's only one copy of the new allele, its effect is noticeable and thus considered dominant over the original, unmutated allele.

If a mutation causes the gene to stop functioning altogether or vastly alters normal function, it's considered a *loss-of-function mutation*. All nonsense mutations are loss-of-function mutations, but not all loss-of-function mutations are the result of nonsense mutations. The usefulness of the protein made from a particular gene can be lost even when no stop codon has been added prematurely. Insertions and deletions are often loss-of-function mutations because they cause frameshifts (Chapter 9 explains how the genetic code is read in frames). Frameshifts cause an entirely new set of amino acids to be put together from the new set of instructions. Most of the time, these new proteins are useless and nonfunctional. Loss-of-function mutations are usually recessive because the normal, unmutated allele is still producing product, usually enough to compensate for the mutated allele. Loss-of-function mutations are only detected when a person is homozygous for the mutation and is making no functional gene product at all.

Evaluating Options for DNA Repair

Mutations in your DNA can be repaired in four major ways:

- ✔ **Mismatch repair:** Incorrect bases are found, removed, and replaced with the correct, complementary base. Most of the time, DNA polymerase, the enzyme that helps make new DNA, immediately detects mismatched bases put in by mistake during replication. DNA polymerase can back up and correct the error without missing a beat. But if a mismatched base

gets put in some other way (through strand slippups, for example), a set of enzymes that are constantly scrutinizing the double strand to detect bulges or constrictions signal a mismatched base pair. The mismatch repair enzymes can detect any differences between the template and the newly synthesized strand, so they clip out the wrong base and, using the template strand as a guide, insert the correct base.

- ✔ **Direct repair:** Bases that are modified in some way (like when oxidation converts a base to some new form) are converted back to their original states. Direct repair enzymes look for bases that have been converted to some new chemical, usually by the addition of some unwanted group of atoms. Instead of using a cut-and-paste mechanism, the enzymes clip off the atoms that don't belong, converting the base back to its original form.
- ✔ **Base-excision repairs:** Base-excisions and nucleotide-excisions (check out the next bullet) work in much the same way. *Base-excisions* occur when an unwanted base (such as uracil; see the section “Spontaneous chemical changes” earlier in this chapter) is found. Specialized enzymes recognize the damage, and the base is snipped out and replaced with the correct one.
- ✔ **Nucleotide-excision repair:** *Nucleotide-excision* means that the entire nucleotide (and sometimes several surrounding nucleotides as well) gets removed all at once. When intercalating agents or dimers distort the double helix, nucleotide-excision repair mechanisms step in to snip part of the strand, remove the damage, and synthesize fresh DNA to replace the damaged section.

As with base excision, specialized enzymes recognize the damaged section of the DNA. The damaged section is removed, and newly synthesized DNA is laid down to replace it. In nucleotide-excision, the double helix is opened up, much like it is during replication (which I cover in Chapter 7). The sugar-phosphate backbone of the damaged strand is broken in two places to allow removal of that entire portion of the strand. DNA polymerase synthesizes a new section, and DNA ligase seals the breaks in the strand to complete the repair process.

Examining Common Inherited Diseases



Even though mutation is a common occurrence, most inherited diseases are comfortingly rare. Inherited disorders are often recessive and show up only when an individual is homozygous for the trait. Inherited diseases aren't nonexistent, though. The following sections provide details on three relatively common inherited diseases. You can find out more about inheritance patterns in Chapter 12.

Cystic fibrosis

The most common inherited disorder among Caucasians in the United States is cystic fibrosis (CF); this autosomal recessive disorder occurs in roughly one in every 3,000 births (autosomal recessive means the gene isn't on a sex chromosome and a person must have two copies of the allele to get the disease; see Chapter 3). The mutations (there can be several) that cause CF occur in a gene located on chromosome 7. Persons affected with CF produce thick, sticky mucus in their lungs, intestines, and pancreas.

The gene implicated in CF, called the *cystic fibrosis transmembrane conductance regulator gene* (or CFTR for short), normally controls the passage of salt across cell membranes. Water naturally moves to areas where salt is more concentrated, so the movement of salt from one place to another has an effect on how much water is present in parts of the body. In persons with CF, the removal of salt from the body (via sweat) is abnormally high. As a result, the lungs, pancreas, and digestive system can't retain enough water to dilute the mucus normally found in those systems, so the mucus produced by persons affected by CF is unusually thick. The buildup of thick mucus blocks breathing passages and makes waste elimination difficult, causing severe breathing and digestive difficulties and a high susceptibility to respiratory illnesses.

CF is diagnosed in two ways:

- ✓ Persons who may be carriers for the mutated allele can be tested genetically (Chapter 12 covers genetic testing).
- ✓ Children possibly affected by the disease are diagnosed by a “sweat test.” Their sweat is tested for salt content, and abnormally high amounts of salt indicate that the child has the disease.

CF is a target of gene therapy (see Chapter 16), but it resists a cure. Most afflicted persons must endure a lifetime of therapy that includes having someone pound on their chests so that they can remove the mucus from their lungs by coughing. The prognosis for CF has improved dramatically, yet most persons affected by the disease don't live far beyond their 30s.



For additional information on cystic fibrosis and to find contacts in your area, contact the Cystic Fibrosis Foundation at 1-800-344-4823 (www.cff.org) or the Canadian Cystic Fibrosis Foundation at 1-800-378-2233 (www.cysticfibrosis.ca).

Sickle cell anemia

Sickle cell anemia is the most common genetic disorder among African Americans in the United States — roughly one in every 400 births are affected by this autosomal recessive disorder. The mutation responsible for sickle cell

is found in chromosome 11, the gene responsible for making one part of the protein complex that composes hemoglobin (check out Chapter 9 for how complex proteins are formed). In the case of sickle cell, one base is mutated from adenine to thymine (a *transversion*). The mistake changes one amino acid added during translation from glutamic acid to valine, producing a protein that folds improperly and can't carry oxygen effectively.

The red blood cells of persons affected by sickle cell take on the disease's characteristic crescent shape when oxygen levels in the body are lower than usual (often as the result of aerobic exercise). The sickling event has the side effect of causing blood clots to form in the smaller blood vessels (capillaries) throughout the body. Clot formation is extremely painful and also causes damage to tissues that are sensitive to oxygen deprivation. Persons with sickle cell are vulnerable to kidney failure, yet with good medical care, most affected persons are expected to live into middle adulthood (40–50 years of age).



For more information on sickle cell anemia, you can contact the American Sickle Cell Anemia Association at 1-216-229-8600 (www.ascaa.org).

Tay-Sachs

An autosomal recessive disorder, Tay-Sachs is a progressive, fatal disease of the nervous system and is unusually common among persons of Ashkenazi (Eastern European) Jewish ancestry. One in every 30 to 40 persons of Jewish ancestry is a carrier of Tay-Sachs. French Canadians and persons of Cajun (south Louisiana) descent are also often carriers of the mutated allele.

The mutation that causes Tay-Sachs is found in the gene that codes for the enzyme hexosaminidase A (HEXA). Normally, your body breaks down a class of fats called gangliosides. When HEXA is mutated, the normal metabolism of gangliosides stops, and the fats build up in the brain, causing damage. Children inheriting two copies of the affected allele are normal at birth, but as the fats build up in their brains over time, these children become blind, deaf, mentally impaired and ultimately paralyzed. Most children with Tay-Sachs don't survive beyond the age of 4. Unlike some metabolic disorders, such as phenylketonuria (see Chapter 12), changes in diet don't prevent the buildup of the unwanted chemical in the body.

Chapter 14

The Genetics of Cancer

In This Chapter

- ▶ Defining cancer
 - ▶ Understanding the genetic basis of cancer
 - ▶ Delving into different types of cancer
-

If you've had personal experience with cancer, you're not alone. I've lost family members, co-workers, students, and friends to this insidious disease — it's highly likely that you have, too. Second only to heart disease, cancer causes the deaths of around 500,000 persons a year in the United States alone, and roughly 1.3 million Americans will be diagnosed with cancer in 2005. Cancer is a genetic disorder that involves how cells grow and divide. Your likelihood of getting cancer is influenced by your genes (the genes you inherited from your parents) and your exposure to certain chemicals and radiation. Sometimes, cancers occur from random, spontaneous mutations — events that defy explanation and have no apparent cause. In this chapter, you find out what cancer is, the genetic basis of cancers, and some details about the most common types of cancer.

If you skipped over Chapter 2 on cells, you may want to backtrack before delving into this chapter — cell information will help you understand what you read here. All cancers arise from mutations; you can discover how and why mutations occur in Chapter 13. Cancer treatments in the form of gene therapy are covered in Chapter 16.

Defining Cancer

Cancer is, in essence, cell division running out of control. As I explain in Chapter 2, the cell cycle is normally a carefully regulated process. Cells grow and divide on a schedule that's determined by the type of cell involved. Skin cells grow and divide continuously because replacing dead skin cells is a never-ending job. Some cells retire from the cell cycle: The cells in your brain and nervous system don't take part in the cell cycle; no growth and no cell division occur there during adulthood. Cancer cells, on the other hand, don't obey the rules and have their own, often frightening, agendas and schedules. Table 14-1 lists the six most common cancers in the U.S.

Table 14-1 **Average Estimated New Cases
of the Six Most Common Cancers
in the U.S. (2001–2005)**

<i>Type of Cancer</i>	<i>New Cases Per Year</i>
Prostate	214,040
Breast	208,334
Colon and rectum	145,418
Skin	59,770
Oral	28,866



In the following sections, I outline the two basic categories of cancers — benign and malignant. *Benign cancers* grow out of control but don't invade surrounding tissues. *Malignant cancers* are invasive and have a disturbing tendency to travel and show up in new sites around the body.

Benign growths

When a cancer is said to be *benign*, the cells are dividing at an abnormally high rate but are expected to remain in the same location. Benign cancers tend to grow rather slowly, and they create trouble because of tumor formation. In general, a *tumor* is any mass of abnormal cells. Tumors cause problems because they take up space and compress nearby organs. For example, a tumor that grows near a blood vessel can eventually cut off blood flow just by virtue of its bulk. Benign growths can sometimes also interfere with normal body function and even affect genes by altering hormone production (see Chapter 10 for how hormones control genes).

Generally, benign growths are characterized by their lack of invasiveness. A benign tumor is usually well defined from surrounding tissue, pushes other tissues aside, and can be easily moved about. The cells of benign tumors usually bear a strong resemblance to the tissues they start from. For example, under a microscope, a cell from a benign skin cancer looks similar to a normal skin cell.

A different sort of benign cell growth is called a *dysplasia*, a cell with an abnormal appearance. Dysplasias aren't cancerous (that is, they don't divide out of control) but are worrisome because they have the potential to go through changes that lead to malignant cancers. When examined under the microscope, dysplasias often have enlarged cell nuclei and a "disorderly" appearance. In other words, they have irregular shapes and sizes relative to other cells of the same type. Cancer cells sometimes start as one cell type (benign) but, if left untreated, can give rise to more invasive types as time goes on.

Treatment of benign growths (including dysplasias) varies widely depending upon the size of the tumor, its potential for growth, the location of the growth, and the probability that cell change may lead to malignancy (invasive forms of cancer; see the following section). Some benign growths shrink and disappear on their own, and others require surgical removal. Some organs and tissues are more likely to have benign growths.

- ✔ The prostate gland, a ring-shaped gland that surrounds the urethra at the base of a man's bladder, tends to enlarge in older men.
- ✔ The lining cells of a woman's cervix, the opening to the uterus, often display dysplasia long before cancer develops.
- ✔ Benign tumors may form in breast tissue and in the uterus.



The best defense against benign tumors (and any sort of cancer) is early detection:

- ✔ Men should undergo yearly prostate checkups beginning at age 50.
- ✔ All women over age 20 should do breast self-exams every month.
- ✔ All women should get yearly mammograms starting at age 40.
- ✔ A test to assess the cells of a woman's cervix, called a Pap smear, should be done every one to three years depending upon a woman's age and the results of her previous exams.

Malignancies

Probably one of the most frightening words a doctor can utter is “malignant.” *Malignancy* is characterized by cancer cells' rapid growth, invasion into neighboring tissues, and the tendency to metastasize. *Metastasis* occurs when cancer cells begin to grow in other parts of the body besides the original tumor site; cancers tend to metastasize to the bones, liver, lungs, and brain. Like benign growths, malignancies form tumors, but malignant tumors are poorly defined from the surrounding tissue — in other words, it's difficult to tell where the tumor ends and normal tissue begins. (See the section “Metastasis: Cancer on the go” later in this chapter for more info on the process.)

Malignant cells tend to look very different from the cells they arise from (Figure 14-1 shows the differences). The cells of malignant tumors often look more like tissues from embryos or stem cells than normal “mature” cells. Malignant cells tend to have large nuclei, and the cells themselves are usually larger than normal. The more abnormal the cells appear, the more likely it is that the tumor may be invasive and able to metastasize.

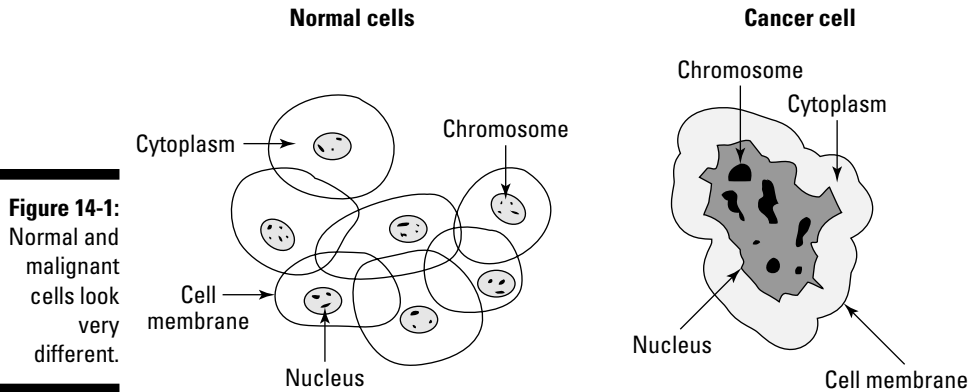

Figure 14-1:
Normal and malignant cells look very different.

Malignancies fall into one of five categories based on the tissue type they arise from:

- ✔ **Carcinomas** are associated with skin, nervous system, gut, and respiratory tract tissue.
- ✔ **Sarcomas** are associated with connective tissue (such as muscle) and bone.
- ✔ **Leukemias** (related to sarcomas) are cancers of the blood.
- ✔ **Lymphomas** develop in glands that fight infection (lymph nodes and glands scattered throughout the body).
- ✔ **Myelomas** start in the bone marrow.

Cancer can occur in essentially any cell of the body. The human body has 300 or so different cell types, and doctors have identified 200 forms of cancer.

Treatment of malignancy varies depending upon the location of the tumor, the degree of invasion, the potential for metastasis, and a host of other factors. Treatment may include surgical removal of the tumor, surrounding tissues, and lymph nodes (little knots of immune tissue found in scattered locations around the body). Chemotherapy (administering of anticancer drugs) and radiation may also be used to combat the growth of invasive cancers. Some forms of gene therapy, which I address in Chapter 16, may also prove helpful.

Metastasis: Cancer on the go

Cells in your body stay in their normal places because of physical barriers to cell growth. One such barrier is called the *basal lamina*. The basal lamina (or basement membrane) is a thin sheet of proteins that's sandwiched

between layers of cells. Metastatic cells produce enzymes that destroy the basal lamina and other barriers between cell types. Essentially, metastatic cells eat their way out by literally digesting the membranes designed to keep cells from invading each other's space. Sometimes, these invasions allow metastatic cells to enter the bloodstream, which transports the cells to new sites where they can set up shop to begin a new cycle of growth and invasion.

Another consequence of breaking down the basal lamina is that the action allows tumors to set up their own blood supply in a process called *angiogenesis*. Angiogenesis is the formation of new blood vessels to supply the tumor cells with oxygen and nutrients. Tumors may even secrete their own growth factors to encourage the process of angiogenesis. Oddly, primary tumors (the first site of tumor growth in the body) seem to restrain angiogenesis in metastasized tissue. When the primary tumor is removed, this control is released, and angiogenesis in the metastasized tumors speeds up. Increased angiogenesis means that the metastasized tumors may start to grow more rapidly, launching a new round of treatment.



A study of breast cancer in 2003 showed that cells that plant the seeds for metastasis depart the original tumor sites without the mutations that are thought to create metastasis in the first place. The wandering cells acquire mutations later, after they've settled in new locations. This discovery means that the old view (still found in most textbooks) of how metastasis develops — a step-wise, one mutation at a time process that happens in the primary tumor cells — is probably wrong.

Recognizing Cancer as a DNA Disease

Normally, the cell cycle is regulated by a host of genes. Thus, at its root, cancer is a disease of the DNA. DNA becomes damaged by mutation, and mutations can ultimately take the phenotype (physical trait) of cancer. The good news is it takes more than one mutation to give a cell the potential to become cancerous. The transformation from normal cell to cancer cell is thought to require certain genetic changes. These mutations can happen in any order — it's not a 1-2-3 process.

- ✓ A mutation occurs that starts cells on an abnormally high rate of cell division.
- ✓ A mutation in one (or more) rapidly dividing cells confers the ability to invade surrounding tissue.
- ✓ Additional mutations accumulate to confer more invasive properties or the ability to metastasize.



Most cancers arise from two or more mutations that occur in the DNA of *one* cell. Tumors result from many cell divisions. The original cell containing the mutations divides, and that cell's “offspring” divide over and over to form a tumor (see Figure 14-2).

Figure 14-2:
Tumors start out as mutations in the DNA of one cell.

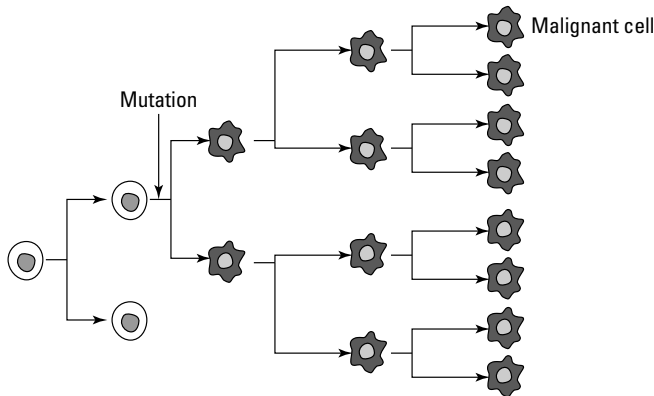

Exploring the cell cycle and cancer

The cell cycle and division (called mitosis; covered in Chapter 2) is tightly regulated in normal cells. Cells must pass through checkpoints, or stages of the cell cycle, in order to proceed to the next stage. If DNA synthesis isn't complete or damage to the DNA hasn't been repaired, the checkpoints prevent the cell from moving into another stage of division. These checkpoints protect the integrity of the cell and the DNA inside it. Figure 14-3 shows the cell cycle and the checkpoints that occur throughout.



Chapter 2 explains two checkpoints of the cell cycle. There are actually a total of four major conditions — basically, quality control points — that must be met for cells to divide:

- ✓ DNA must be undamaged (no mismatches, bulges, or strand breaks like those described in Chapter 13) for the cell to pass from G1 of interphase into S (DNA synthesis).
- ✓ All the chromosomes must complete replication for the cell to pass out of S.
- ✓ DNA must be undamaged to start prophase of mitosis.
- ✓ Spindles required to separate chromosomes must form properly for mitosis to be completed.

If any of these conditions are not met, the cell is “arrested” and not allowed to continue to the next phase of division. Many genes and the proteins they produce are responsible for making sure that cells meet all the necessary conditions for cell division.

Figure 14-3:
Quality control points in the cell cycle protect your cells from mutations that can cause cancer.

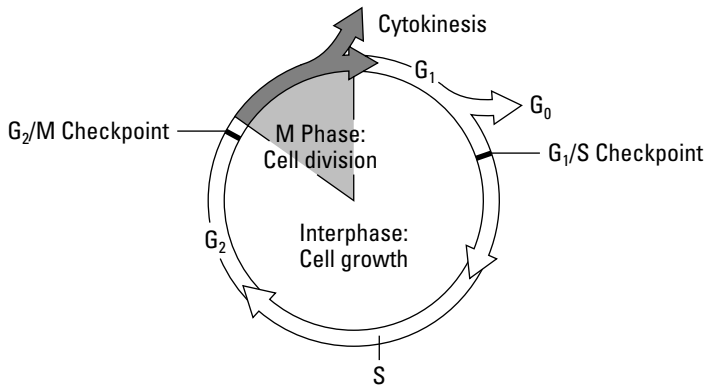

When it comes to cancer and how things go wrong with the cell cycle, two types of genes are especially important:

- ✓ **Proto-oncogenes**, which stimulate the cell to grow and divide, basically acting to push the cell through the checkpoints.
- ✓ **Tumor-suppressor genes**, which act to stop cell growth and tell cells when their normal lifespans have ended.

Basically, two things go on in the cell: One set of genes (and their products) acts like an accelerator to tell cells to grow and divide, and a second set of genes puts on the brakes, telling cells when to stop growing, when not to divide, and even when to die.



The mutations that cause cancer either turn proto-oncogenes into *oncogenes* (turning the accelerator permanently “on”) or damage tumor-suppressor genes (removing the brakes).

Genes gone wrong: Oncogenes

You can think of oncogenes as “on” genes because that’s essentially what these genes do: They keep cell division turned on. Many genes, when mutated, can become oncogenes. All oncogenes have several things in common:

- ✓ Their mutations usually represent a gain of function (see Chapter 13).
- ✓ They’re dominant in their actions.
- ✓ Their effects cause excessive numbers of cells to be produced.



Oncogenes were the first genes identified to play a role in cancer. In 1910, Peyton Rous identified a virus that caused cancer in chickens. It took 60 years for scientists to identify the gene carried by the virus, the first known oncogene. It turns out that many viruses can cause cancer in animals and humans; for more on how these viruses do their dirty work, see the sidebar “Exploring the link between viruses and cancer.”

Exploring the link between viruses and cancer

It's becoming more and more clear that viruses play a significant role in the appearance of cancer in humans. Second only to the risk factor of cigarette smoking, viruses are responsible for at least 15 percent of all malignancies. Numerous viruses are implicated in the formation of tumors, and some of these viruses turn out to have familiar names like herpes, hepatitis, and Epstein-Barr (the virus responsible for mononucleosis, a common infection of adolescence that sometimes goes by the affectionate name of the "kissing disease"). How these viruses change from causing infection to causing cancer is the subject of intense research.

One class of viruses implicated in cancer is *retroviruses*. One familiar retrovirus that makes significant assaults on human health is HIV (Human Immunodeficiency Virus), which causes AIDS (Acquired Immunodeficiency Syndrome). And if you have a cat, you may be familiar with feline leukemia, which is also caused by a retrovirus (humans are immune to this cat virus). Most retroviruses use RNA as their genetic material. Viruses aren't really alive, so to replicate their genes, they have to hijack a living cell. Retroviruses use the host cell's machinery to synthesize DNA copies of their RNA chromosomes. The viral DNA then gets inserted into the host cell's chromosome where the virus genes can be active and wreak havoc with the cell and, in turn, the entire organism. Retroviruses that cause cancer copy their oncogenes into the host cell. The oncogenes team up with additional mutations to cause cancer.

If you've ever had a wart, then you're already acquainted with the harmless version of a virus

whose relatives can cause cancer. Human papilloma virus (HPV) causes genital warts and is linked to cervical cancer in women. Infection with the HPV associated with cervical cancer usually starts with dysplasia (the formation of abnormal but noncancerous cells). It usually takes many years for cervical cancer to develop, which it does only rarely. Nevertheless, over 10,000 women in the United States alone are likely to be diagnosed with cervical cancer in 2005. Early screening, in the form of Pap smears, for cervical cancer has improved detection and saved the lives of countless women.

Another virus has recently been discovered to be linked with an aggressive form of breast cancer. Mouse mammary tumor virus (MMTV) has long been known to cause breast cancer in mice. Recent research shows that humans may also be vulnerable to MMTV. Certain kinds of breast cancers are more common in regions (such as the Middle East and Northern Africa) where a particular species of mouse (House Mouse, *Mus domesticus*) that carries MMTV is also common. These cancers tend to be very invasive and aggressive and are often accompanied by swelling and infection-like symptoms. Researchers examined breast tissue from affected women for the presence of genes similar to those of the virus. They found that North African women often carried a MMTV-like gene; many women from this region also showed other signs of having been infected with the virus. Although the link between the virus MMTV and human breast cancer is still not certain, this and other research suggests that viruses may play significant roles in many human cancers.

You have at least 70 naturally occurring proto-oncogenes in your DNA. Normally, these genes carry out regulatory jobs necessary for normal functioning. It's only when these genes gain mutations and become oncogenes that they switch from good genes to cancer-causers. Cancer cells tend to

have multiple copies of oncogenes because the genes somehow duplicate themselves in a process called *amplification*. This duplication allows those genes to have much stronger effects than they normally would.



A group of geneticists think they've figured out how cancer genes go about copying themselves. The first step in the process is formation of a *palindrome* — a DNA sequence that reads the same way forwards and backwards. In this case, the palindrome is created when a sequence gets clipped out of the DNA, flipped around, duplicated, and then inserted into the DNA (it's called an *inverted repeat*). The DNA of tumor cells has unusual numbers of palindromes. Palindromes seem to encourage more cut-and-paste duplications in the DNA around them, leading to amplification of nearby genes, like oncogenes.

The first oncogene identified in humans resides on chromosome 11. The scientists responsible for its discovery were looking for the gene responsible for bladder cancer. They took cancerous cells and isolated their DNA; then they introduced small parts of the cancer cell's DNA into a bacteria and allowed the bacteria to infect normal cells growing in test tubes. The scientists were looking for the part of the DNA present in cancer cells that would transform the normal cells into cancerous ones. The gene they found, now called HRAS1, was very similar to a virus oncogene that had been found in rats. The mutation that makes HRAS1 into an oncogene affects only three bases of the genetic code (called a codon; see Chapter 9). This tiny change causes HRAS1 to constantly send the signal "divide" to affected cells.

Since the discovery of HRAS1, a whole group of oncogenes has been found; they're known collectively as the *ras* genes. All the *ras* genes work much the same way and, when mutated, turn the cell cycle permanently "on." In spite of their dominant activities, a single mutated oncogene usually isn't enough to cause cancer all by itself. That's because tumor-suppressor genes (see the next section) are still acting to put on the brakes and keep cell growth from getting out of control.

Oncogenes aren't usually implicated in inherited forms of cancer. Most oncogenes show up as somatic mutations that can't be passed on from parent to child.

The good guys: Tumor-suppressor genes

Tumor-suppressor genes are the cell cycle's brakes. Normally, these genes work to slow or stop cell growth and to put a halt to the cell cycle. When these genes fail, cells can divide out of control, meaning that mutations in tumor-suppressor genes are loss-of-function mutations (covered in Chapter 13). Loss-of-function mutations generally only show up as phenotype when two bad copies are present — therefore, the loss of tumor-suppression means that two events have occurred to make the cells homozygous for the mutation.

The first gene recognized as a tumor suppressor is associated with cancer of the eye, called *retinoblastoma*. Retinoblastoma often runs in families and shows up in very young children. In 1971, geneticist Alfred Knudson suggested that one mutated allele of the gene was being passed from parent to child and that a mutation event in the child was required for the cancer to occur. The gene responsible, called RB, was mapped to chromosome 13 and is implicated in other forms of cancer such as breast, prostate, and bone (osteosarcoma). RB turns out to be a very important gene. If both copies are mutated in embryos, the mutations are lethal, suggesting that normal RB function is required for survival.

RB regulates the cell cycle by interacting with transcription factors (transcription factors are discussed in greater detail in Chapters 8 and 10). These particular transcription factors control the expression of genes that push the cell through the checkpoint at the end of G1, just before DNA synthesis. When the proteins that RB codes for (called *pRB*) are attached to the transcription factors, the genes that turn on the cell cycle aren't allowed to function. Normally, pRB and the transcription factors go through periods of being attached and coming apart, turning the cell cycle on and off. If both copies of RB are mutated, then this important brake system goes missing. As a result, affected cells move through the cell cycle faster than normal and divide without stopping. RB not only interacts with transcription factors to control the cell cycle; it's also thought to play a role in replication, DNA repair, and *apoptosis* (programmed cell death).

One of the most important tumor-suppressor genes identified to date is *TP53*. TP53, found on chromosome 17, codes for the cell-cycle regulating protein p53. Mutations that lead to loss of p53 function are implicated in a wide variety of cancers. The most important of p53's roles may be in regulating when cells die, a process known as *apoptosis*:

- ✓ When DNA has been damaged, the cell cycle is stopped to allow repairs to be carried out.
- ✓ If repair isn't possible, the cell receives the signal to die (apoptosis).

If you've ever had a bad sunburn, then you have first-hand experience with apoptosis. Apoptosis, also known by the gloomy moniker "programmed cell suicide," occurs when the DNA of a cell is too damaged to be repaired. Rather than allow the damage to go through replication and become cemented into the DNA as mutation, the cell voluntarily dies. In the case of your severe sunburn, the DNA of the exposed skin cells was damaged by the sun's radiation. In many cases, the DNA strands were broken, probably in many different places. Those skin cells killed themselves off, resulting in the unpleasant skin peeling that you suffered. When your DNA gets damaged from too much sun exposure or because of any other mutagen (see Chapter 13 for examples), a protein called *p21* stops the cell cycle. Coded by a gene on the X chromosome, p21 is produced when the cell is stressed. The presence of p21 stops the cell

from dividing and allows repair mechanisms to heal the damaged DNA. If the damage is beyond repair, the cell may skip p21 altogether. Instead, the tumor-suppressor protein p53 signals the cell to kill itself.

When the cell gets the message that says, “Die!” a gene called BAX swings into action. BAX sends the cell off to its destruction by signaling the mitochondria — those energy powerhouses of the cell — which release a wrecking-crew of proteins that go about breaking up the chromosomes and killing the cell from the inside. When your cells die due to injury (like a burn or infection), the process is a messy one: The cells explode, causing surrounding cells to react in the form of inflammation. Not so in apoptosis. The cells killed by the actions of apoptosis are neatly packaged so that surrounding tissues don’t react. Cells that specialize in garbage collection and disposal, called phagocytes (meaning cells that eat), do the rest.

Drugs used to fight cancer often try to take advantage of the apoptosis pathway to cell death. The drugs turn on the signals for apoptosis to trick the cancer cells into killing themselves. Radiation therapy, also used to treat cancer by introducing double-strand breaks (see Chapter 13 for more on this kind of DNA damage), relies on the cells knowing when to commit suicide. Unfortunately, some of the mutations that create cancer in the first place, such as damage to the p53 protein-signaling network, make cancer cells resistant to apoptosis. In other words, in addition to growing and dividing without restriction, cancer cells don’t know when to die.

Demystifying chromosome abnormalities

Large-scale chromosome changes — the kinds that are visible when karyotyping (chromosome examination; see Chapter 15 for details) is done — are associated with some cancers. These chromosome changes (like losses of chromosomes) often occur after cancer develops and occur because the DNA in cancer cells is really unstable and prone to lots of breakage. Normally, damaged DNA is detected by proteins that keep tabs on the cell cycle. When breaks are found, either the cell cycle is stopped and repairs are initiated or the cell dies. Because the root of cancer is the loss of genetic quality control functions provided by proto-oncogenes and tumor-suppressor genes, it’s no surprise that breaks in the cancer-cell DNA lead to losses and rearrangements of big chunks of chromosomes as the cell cycle rolls on without interruption. One of the biggest problems with all this genetic instability in cancer cells is that a tumor is likely to have several different genotypes amongst its many cells, which makes treatment difficult. Chemotherapy that’s effective at treating cells with one sort of mutation may not be useful for another.

Three types of damage — deletions, inversions, and translocations — can interrupt tumor-suppressor genes, rendering them nonfunctional. Translocations and inversions may change the positions of certain genes so that

the gene gets regulated in a new way (see Chapter 10 for more about how gene expression is regulated by location). Chronic myeloid leukemia, for example, is caused by a translocation event between chromosomes 9 and 22. This form of leukemia is a cancer of the blood that affects the bone marrow.

Translocations generally result from double-strand breaks (radiation and cigarette smoking are risk factors). In the case of chronic myeloid leukemia, the translocation event makes chromosome 22 unusually short. (This shortened version of the chromosome is called the Philadelphia chromosome because geneticists working in that city discovered it.) The translocation event causes two genes, one from each chromosome, to become fused together. The new gene product acts as a powerful oncogene, leading to out-of-control cell division and eventually leukemia.

Certain cancers seem prone to losing particular chromosomes altogether, resulting in monosomies (similar to those described in Chapter 15). For instance, one copy of chromosome 10 often goes missing in the cells of glioblastomas, a deadly form of brain cancer. Cancer cells are also prone to nondisjunction leading to localized trisomies. It appears that mutations in the p53 gene, which can stop the cell cycle for DNA repair and signal apoptosis, are linked to these localized changes in chromosome number.

Breaking Down the Types of Cancers

Around 200 different cancers occur in humans. Many are site specific, meaning the tumor is associated with a particular part of the body. Some cancers seem to appear just about anywhere, in any organ system. This section isn't meant to provide an exhaustive list of cancers; instead, it touches on the genetics of some of the more common cancers.



For more information on all types of cancers, visit the American Cancer Society (www.cancer.org) and the National Cancer Institute (www.cancer.gov) online.

Hereditary cancers



Hereditary cancers are those that tend to run in families. No one ever inherits cancer; what's inherited is the predisposition to certain sorts of cancer. What this means is that certain cancers tend to run in families because one or more mutations are being passed on from parent to child. Most geneticists agree that additional mutations are required to trigger the actual disease. Just because you have a family history of a particular cancer doesn't mean you'll get it. The opposite is also true: Just because you don't have a family history doesn't mean you won't get cancer.

Prostate cancer

The most common cancer in the United States is prostate cancer. The prostate is a walnut-sized gland found at the base of a man's urinary bladder. The urethra, the tube that carries urine outside the body, runs through the center of the prostate gland. The prostate generates seminal fluid, important for the production of sperm. On average, over 200,000 men are likely to be diagnosed with prostate cancer each year. The highest rates of prostate cancer occur among African American men, likely because of lack of screening and delayed treatment.

Many mutations are associated with family history of prostate cancer, but the number-one risk factor associated with prostate cancer is age. Older men are far more likely to develop this disease.

For most men, the first clue of changes in the prostate gland is difficulty in urination and decreased urine flow. Many older men experience swelling of the prostate, and those changes are often benign. The best screening tests for prostate cancer are a blood test, called PSA (for prostate-specific antigen), and a manual examination by a physician. Men should start getting screened for prostate cancer at age 50. Men with a family history of the disease (father, brother, or son) should start earlier — the American Cancer Society suggests that screening begin at age 45.

Numerous genes are implicated in prostate cancer. One gene, PRCA1 on chromosome 1, is designated “the” hereditary prostate cancer gene. But less than 10 percent of all cases of prostate cancers are thought to originate with mutations at PRCA1. Online Mendelian Inheritance in Man (see Chapter 24) lists at least 16 genes associated with prostate cancer, including p53 and RB; it's likely that several genes interact to cause the cell cycle of the prostate gland to spiral out of control. There also seems to be a link between prostate cancer and the two BRCA genes implicated in breast cancer. Thus, men and women with family histories of either disease may be susceptible to developing cancer.

Breast cancer

Breast cancer is the second most common cancer in America (see Table 14-1). Sadly, over 40,000 people, mostly women, are likely to die of the disease each year. Different sorts of breast cancer are distinguished by the part of the breast that develops the tumor. Regardless of the type of breast cancer, though, the number one risk factor appears to be a family history of the disease. Family history of breast cancer is usually defined as having one of the following:

- ✔ A mother or sister diagnosed with breast or ovarian cancer before age 50
- ✔ Two “first-degree” relatives (mother, sister, daughter) with breast cancer at any age
- ✔ A male relative diagnosed with breast cancer

Generally, the first symptom of breast cancer is a lump in the breast tissue. The lump may be painless or sore, hard (like a firm knot) or soft; the edges of the lump may not be easy to detect, but in some cases they're very easy to feel. Other symptoms include swelling, changes in the skin of the breast, nipple pain or unexpected discharge, and a swelling in the armpit.

Researchers have identified two breast cancer genes: BRCA1 and BRCA2 (for BRCAst CAnCER genes one and two). These genes account for slightly less than 25 percent of inherited breast cancers, however. Mutations on the gene for p53, along with numerous other genes, are also associated with hereditary forms of breast cancer (see “The good guys: Tumor-suppressor genes” for more on p53). Breast cancers associated with mutations of BRCA1 and/or BRCA2 seem to be inherited as autosomal dominant disorders (genetic disorders resulting from one bad copy of a gene; see Chapter 12 for more on inheritance patterns).

When it comes to breast cancer, penetrance is roughly 50 percent, meaning 50 percent of the people inheriting a mutation in one of the breast cancer genes will develop cancer. (This penetrance value is based on a lifespan of 85 years, by the way, so people living 85 years have a 50 percent chance of expressing the phenotype of cancer.)



Other cancers are also associated with mutations in BRCA1 and BRCA2, including ovarian, prostate, and male breast cancer.

Both BRCA genes are tumor-suppressor genes. The roles these genes play in the cell cycle aren't especially well defined. BRCA1 has a role in regulating when cells pass through the critical G1-S checkpoint, but exactly how BRCA1 does its job isn't clear. As for BRCA2, it apparently has some cell cycle duties and also plays a role in DNA repair, especially of double-strand breaks.

Early detection of breast cancer is the best defense against the disease. Women with family histories of breast cancer should be screened by a physician at least once a year (some doctors recommend screenings every six months). Genetic tests are available to confirm the presence of mutations that produce breast cancer, but at present, these tests are very expensive and don't yield any information about the true likelihood of getting the disease. After breast cancer is diagnosed, treatment options vary based on the kind of cancer. Breast cancer is considered very treatable, and the prognosis for recovery is very good for most patients.

Colon cancer

One hereditary cancer that's considered highly treatable (when detected early) is colon cancer. Your colon is defined by the large intestine, the bulky tube that carries waste products to your rectum for defecation. Over 100,000 people are likely to be diagnosed with colon cancer each year. Numerous risk factors are associated with colon cancer, including:

- ✓ Family history of the disease (meaning parent, child, or sibling)
- ✓ Age; persons over 50 are at greater risk
- ✓ High-fat diet
- ✓ Obesity
- ✓ History of alcohol abuse
- ✓ Smoking

Almost all colon cancers start as benign growths called *polyps*. These polyps are tiny wart-like protrusions on the wall of the colon. If colon polyps are left untreated, a ras oncogene often becomes active in the cells of one or more of the polyps, causing the affected polyps to increase in size (see the “Genes gone wrong: Oncogenes” section earlier in the chapter for more on how oncogenes work). When the tumors get big enough, they change status and are called *adenomas*. Adenomas are benign cancers but are susceptible to mutation, often of the tumor-suppressor gene that controls p53. When p53 is lost through mutation, the adenoma becomes a *carcinoma* — a malignant and invasive tumor.

Early detection and treatment is critical to prevent colon polyps from becoming cancerous. If large numbers of polyps develop, the likelihood that at least one will become malignant is very high. The good news is that the changes in the colon usually accumulate slowly, over the course of several years. The American Cancer Society recommends that all persons over 50 years of age be screened for colon cancer. Two tests are generally done: a test to detect blood in the feces and a visual inspection, called a *colonoscopy*, of the inside of the colon using a flexible scope. The test kit to detect blood in the feces is available over the counter at most drug stores. Positive results are nothing to panic over — just see your physician. Colonoscopy is carried out under light anesthesia and gives your physician the most accurate means of diagnosing the presence of polyps and grabbing samples of cells for testing.

Preventable cancers

Preventable cancers are cancers associated with particular risk factors that can be controlled and avoided. No one ever chooses to get cancer, but the lifestyle choices that people make leave them more likely to develop certain kinds of cancer in their lifetimes. Three of the most avoidable kinds of cancer associated with lifestyle choices are lung cancer, mouth cancers, and skin cancer.

Lung cancer

More people die from lung cancer every year than any other kind of cancer. Nearly 175,000 Americans are likely to be diagnosed with lung cancer in 2005, and it's estimated that over 160,000 people in the United States will die of the

disease in that year. Ninety percent of people who get lung cancer do so because of cigarette smoking. Let me repeat that: *90 percent* of lung cancer is associated with cigarette smoking. This statistic makes lung cancer the most preventable cancer of all.

The average age for lung cancer diagnosis is age 60. Sadly, after a patient's diagnosed with lung cancer, the prognosis is generally poor. Survival estimates vary depending upon the type of lung cancer, but in general, only 20 percent of people afflicted survive longer than one year after diagnosis. That's the bad news. The good news is that if you stop smoking at any age, your lungs heal, and your risk of developing cancer goes down.

There are two main types of lung cancer, both of which are associated with tobacco use.

- ✔ **Small-cell lung cancers**, which comprise roughly 25 percent of all lung cancers, are the worst type. Named for the small, round cells that comprise these tumors, they're invasive, highly prone to metastasis, and very hard to treat.
- ✔ **Non-small cell lung cancers** are more amenable to treatment, especially when diagnosed early.



Both types of lung cancer have similar primary symptoms: weight loss, hoarseness, a cough that won't go away, and difficulty breathing. Another symptom that's often overlooked is finger clubbing. Finger clubbing is a condition in which the tips of the fingers get wider than normal. It's a common sign of lung disease and an indication that small blood vessels aren't getting enough oxygen.

Many mutations are associated with lung cancers. Both oncogenes and tumor-suppressor genes are implicated. Almost all lung cancers involve mutations of the p53 gene — the tumor-suppressor gene that controls, among other things, programmed cell death. A ras oncogene, *Kras*, is frequently mutated in certain kinds of lung cancers. Finally, large-scale deletions of chromosomes, most often chromosome 3, are associated with virtually all small-cell lung cancers (see the section “Demystifying chromosome abnormalities” for more details).

Cancers of the mouth

The use of smokeless tobacco (snuff and chewing tobacco) is associated with cancers of the mouth. Roughly 7,000 persons each year die of preventable mouth cancers; men are twice as likely to get mouth cancer as women. Like lung cancer, the prognosis for persons diagnosed with mouth cancer is poor. Only slightly more than 50 percent of persons survive beyond five years after diagnosis.

The reason the prognosis for mouth cancer is so poor is that early stages of the disease show no symptoms. Therefore, most people are unaware of the problem until the disease is more advanced. Symptoms of mouth cancer include sores on the gums, tongue, or the roof of the mouth that don't heal; lumps in the mouth; thickening of the cheek lining; and persistent mouth pain. Regular dental care helps increase early detection, improving the chance of survival.

Mutations associated with mouth cancers are often large-scale chromosome abnormalities. Cells of the mouth appear especially vulnerable to mutational losses of parts of chromosomes 3, 9, and 11 — all of which are recognized fragile sites (similar to the one that causes Fragile X; see Chapter 15). Oncogenes in the ras family and the p53 gene are also implicated in most forms of mouth cancer.

Skin cancer

Each year, nearly 60,000 people in the United States are diagnosed with *melanoma*, a form of skin cancer. Although the predisposition to skin cancer is likely to be inherited, the number one risk factor for skin cancer is exposure to ultraviolet light. Ultraviolet light sources include the sun and tanning booths. People with pale skin, light-colored eyes (blue or green), and fair hair are most vulnerable to ultraviolet light and thus skin cancer. If you burn easily and don't tan readily, you're at higher risk. The best way to prevent skin cancer is to stay out of the sun. If you must be exposed to the sun, *always* use sunblock with an SPF (Sun Protection Factor) higher than 30.

Sunburn is strongly associated with the development of skin cancer at a later time because radiation tends to cause double-strand DNA breaks and also glues adjacent bases in the DNA together, forming spots called dimers (see Chapter 13 for more details on these sorts of DNA damage). Damage to DNA is often so great after severe sun exposure that large numbers of skin cells die. Take a look at the section on tumor-suppressor genes earlier in this chapter to find out about the process of "programmed cell suicide." But some damaged DNA may escape the repair or cell death process, yielding dangerous mutations. Regular screening, the key to early detection of skin cancer, is as simple as inspecting your skin using a mirror. Look closely at all moles and freckles; asymmetrical, blotchy, or large (bigger than a pencil eraser) growths should be pointed out to your physician.

Chapter 15

Chromosome Disorders

In This Chapter

- ▶ Studying chromosomes to figure out numbers and sets
 - ▶ Understanding how things go wrong with chromosomes
-

The study of chromosomes is, in part, the study of cells. Geneticists who specialize in *cytogenetics*, the genetics of the cell, often examine chromosomes as the cell divides because that's when the chromosomes are easiest to see. Cell division is one of the most important activities that cells undergo; it's required for normal life, and a special sort of cell division prepares sex cells for the job of reproduction. Chromosomes are copied and divided up during cell division, and getting the right number of chromosomes in each cell as it divides is critical. Most chromosome disorders (such as Down syndrome) occur because of mistakes during meiosis (the cell division that makes sex cells; see Chapter 2).

This chapter helps you understand how and why chromosome disorders occur. You find out how geneticists study the chromosome content of cells. Knowing chromosome numbers allows scientists to decode the mysteries of inheritance, especially when the number of chromosomes (called *ploidy*) gets complicated. Counting chromosomes also allows doctors to determine the origin of physical abnormalities caused by the presence of too many or too few chromosomes. If you skipped over Chapter 2, you may want to flip back to it before reading this chapter to get a handle on the basics of chromosomes and how cells divide.

Studying Chromosomes

A cytogeneticist counts chromosomes with the aid of microscopes and special dyes to see the chromosomes during metaphase — the one time during the cell cycle when the chromosomes take on the fat, easy-to-see, sausage shape. (Jump back to Chapter 2 to review the cell cycle.) Here's how the process of examining chromosomes works.

1. A sample of cells is obtained. Almost any sort of dividing cell works as a sample, including root cells from plants, blood cells, or skin cells.
2. The cells are *cultured* — given the proper nutrients and conditions for growth — to stimulate cell division.
3. Some cells are removed from the culture and treated to stop mitosis during metaphase.
4. Dyes are added to make the chromosomes easy to see.
5. The cells are inspected under a microscope. The chromosomes are sorted, examined for obvious abnormalities, and counted.

This process of chromosome examination is called *karyotyping*. A karyotype reveals exactly how many chromosomes are present in a cell along with some details about the structure of the chromosomes. Scientists can only see these details by staining the chromosomes with special dyes.



The word chromosome is Greek for “colored body” — so-called because the chromosomes stain with dye so easily. Modern geneticists employ all kinds of colored dyes depending on the chromosome aspect they’re studying. Most of the chromosome pictures you see show the chromosomes as having stripes; these stripes are the result of chromosome staining. Most chromosome studies for diagnosis of *aneuploidy* (missing or having extra chromosomes) use a method called *G-banding*. G-bands (named after the scientist that developed the method, Gustav Giemsa) allow the geneticist to identify each individual chromosome and permit the diagnosis of obvious, large-scale deletions or abnormalities (such as fragile sites; see “Fragile X” later in this chapter). Check out the chromosome karyotype in Chapter 2; it contains a full set of human chromosomes stained to show the G-bands.

When examining a karyotype, the geneticist looks at each individual chromosome. Every chromosome has a typical size and shape; the location of the centromere and the length of the chromosome arms (the parts on either side of the centromere) are what define each chromosome’s physical appearance (refer back to Chapter 2 to see what some chromosomes look like up close). The chromosome arms are

- ✓ **p arm:** The shorter of the two arms (from the word *petite*, French for “small”)
- ✓ **q arm:** The longer arm (because q follows p alphabetically)

In some disorders, one of the chromosome arms is misplaced or missing. Therefore, geneticists often refer to the chromosome number along with the letters *p* or *q* to communicate which part of the chromosome is affected.

Counting Up Chromosomes

Ploidy sounds like some bizarre, extraterrestrial science fiction creature, but the word actually refers to the number of chromosomes a particular organism has. Two sorts of “ploidy” are commonly bandied about in genetics:

- ✓ **Aneuploid** refers to an imbalance in the number of chromosomes. Situations involving aneuploidy are often given the suffix *-somy* to communicate whether chromosomes are missing (monosomy) or extra (trisomy).
- ✓ **Euploid** (and the related term, polyploid) refers to the number of *sets* of chromosomes an organism has. Thus, *diploid* tells you that the organism in question has two sets of chromosomes (often written as $2n$, with n being the haploid number of chromosomes in the set; see Chapter 2 for more on how chromosomes are counted up). When an organism is euploid, its total number of chromosomes is an exact multiple of its haploid number (n).

Aneuploidy: Extra or missing chromosomes

Shortly after Thomas Hunt Morgan discovered that certain traits are linked to the X chromosome (see Chapter 5 for the full story), his student Calvin Bridges discovered that chromosomes don't always play by the rules. The laws of Mendelian inheritance depend on the segregation of chromosomes — an event that takes place during the first phase of meiosis (see Chapter 2 for meiosis coverage). But sometimes chromosomes don't segregate; two or more copies of the same chromosome are sent to one *gamete* (sperm or egg), leaving another gamete without a copy of one chromosome. Through his study of fruit flies, Bridges discovered the phenomenon of *nondisjunction*, the failure of chromosomes to segregate properly. Figure 15-1 shows nondisjunction at various stages of meiotic division. (For more on how Morgan and Bridges made their discoveries, check out the sidebar “Flies!”)

While studying eye color in flies (flip back to Chapter 5 for more about this X-linked trait), Bridges crossed white-eyed female flies with red-eyed males. He expected to get all white-eyed sons and all red-eyed daughters from this sort of monohybrid cross. (Chapter 3 explains monohybrid crosses.) But every so often, he got red-eyed sons and white-eyed daughters. Bridges already knew that females get two copies of the X chromosome and males get only one and that eye color was linked with X. He also knew that eye color was a recessive trait; the only way females could have white eyes was to have two copies of X that both had the allele for white. So how could the odd combinations of sex and eye color Bridges saw occur?

Bridges realized that the X chromosomes of some of his female parent flies must not be obeying the rules of segregation. During the first round of meiosis, the homologous pairs of chromosomes should separate. If that doesn't happen, some eggs get two copies of the mother's X chromosome (see Figure 15-1). In Bridges' research, both copies of the mother's X carried the allele for white eyes. When a red-eyed male fertilized a two-X egg, two results were possible, as you can see in Figure 15-2. An XXX zygote resulted in a red-eyed daughter (which usually died). An XXY zygote turned out to be a white-eyed female (check out Chapter 5 for how sex is determined in fruit flies). Fertilized eggs that had no X chromosome resulted in a red-eyed male (with genotype X). Eggs that didn't get an X chromosome and receive a Y from the father were never viable at all.



Flies!

Some of the greatest scientific discoveries have been made in the humblest of settings. Take Thomas Hunt Morgan's laboratory, affectionately known as the Fly Room. The Fly Room was a mere 368 square feet. It was crammed with eight students, their desks, and hundreds of glass milk bottles. Every milk bottle was full of fruit flies, and large bunches of bananas hung from the ceiling as food for the fruit flies. The room reeked of rotting bananas, literally buzzed with escapee flies, and had more than its fair share of cockroaches. Yet from 1910 to 1930, this cramped and unappetizing setting was home to some of the most important scientific discoveries of its time, discoveries that still apply to the understanding of genetics today.

Calvin Bridges and Alfred Sturtevant were both undergraduates at Columbia University in New York City in 1909. After hearing a lecture presented by Morgan, both Bridges and Sturtevant landed desk space in the Fly Room. (An element of luck was involved — Morgan's talk in 1909 was the only opening lecture he gave for beginning zoology students, ever.) Mendel's work had only just been rediscovered, so it was an exciting time for genetics. Fruit flies made perfect study organisms to test all the latest ideas, so the men of the Fly Room (collaborator Nettie Stevens was

at the Carnegie Institution) spent hours discussing the latest publications and their own research findings. After one such discussion, Sturtevant rushed home to work up his latest idea: a map of the genes on the X chromosome. (He later admitted that he neglected his homework to pull off the feat!) Sturtevant's chromosome map — still accurate to this day — was created when he was just 20 years old and still an undergraduate. Bridges, at the ripe old age of 24, went on to discover nondisjunction of fly chromosomes — definitive proof that Morgan's theory of chromosomal inheritance was correct.

By the mid-1920s, the Fly Room's heyday had passed. In his 1965 work *A History of Genetics*, Sturtevant is nostalgic not for the Fly Room itself but for the flow of ideas it fostered, the "give-and-take" of collaborative science. In the highly competitive world of genetics today, ownership of ideas can be an extremely contentious subject — friendships are sometimes destroyed over the authorship of important scientific papers. The atmosphere of the Fly Room, however, must have been an obvious exception and a wonderful place to do research. If science ever develops a time machine, put me down for a trip to the Fly Room, say 1910 or so.

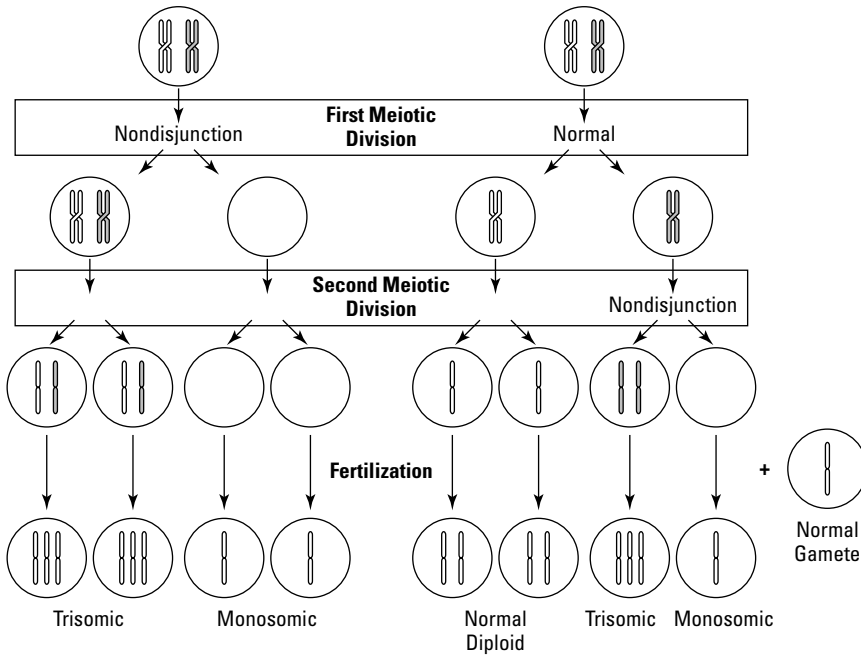

Figure 15-1:
The results of nondisjunction during meiosis.

Many human chromosomal disorders arise from a sort of nondisjunction similar to that of fruit flies. For more information on these human disorders, take a look at the section “Chromosome Disorders” later in this chapter.

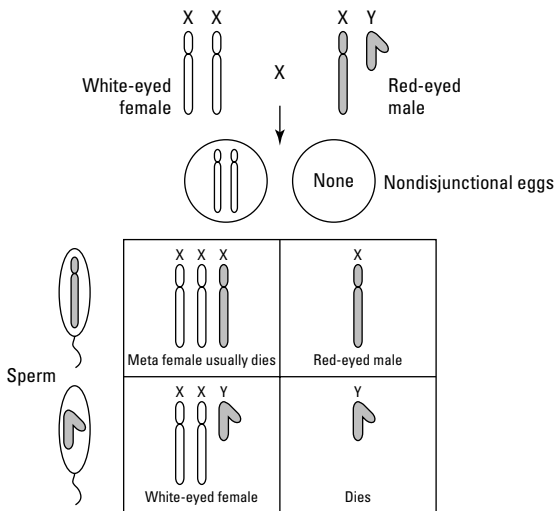

Figure 15-2:
How nondisjunction of the X chromosomes works in fruit flies.

Euploidy: Numbers of chromosomes

Every species has a typical number of chromosomes revealed by its karyotype. For example, humans have 46 total chromosomes (humans are diploid, $2n$, and $n = 23$). Your dog, if you have one, is also diploid and has 78 total chromosomes, and house cats have $2n = 38$. Chromosome number isn't very consistent, even among very closely related organisms. For example, despite their similar appearance, two species of Asian deer (called muntjacs) are both diploid but have very different chromosome numbers: One species has 23 chromosomes, and the other has six.

Many organisms have more than two sets of chromosomes (a single set of chromosomes referred to by the n is the haploid number) and are therefore considered *polyploid*. Polyploidy is rare in animals but not unknown (salmon, for example, have four sets of chromosomes). Plants, on the other hand, are frequently polyploid. The reason that polyploidy is rare is sexual reproduction. Most animals reproduce sexually, meaning each individual produces eggs or sperm that unite to form zygotes that grow into offspring. An equal number of chromosomes must be allotted to each gamete for fertilization and normal life processes to occur. When an individual, such as a plant, is polyploidy (particularly odd numbers like $3n$), most of its gametes wind up with an unusual number of chromosomes. This imbalance in the number of chromosomes results, functionally, in sterility (see the sidebar “Stubborn chromosomes” for more details).



Plants sometimes get around the problem of polyploidy (and its corresponding sterility) through a process called *apomixis*. Part of meiosis, apomixis results in an egg with a full complement of chromosomes. Eggs produced via apomixis can form seeds without being fertilized and therefore can produce new plants from seed. Dandelions, those hardy, persistent weeds known to all gardeners, reproduce using apomixis. Dandelions have $n = 8$ chromosomes which can come in sets of two ($2n = 16$), three ($3n = 24$), or four ($4n = 32$).

Many commercial plants are polyploid because plant breeders discovered that polyploids often are much larger than their wild counterparts. Wild-strawberries, for instance, are diploid, tiny, and very tart. The large, sweet strawberries you buy in the grocery store are actually octaploid, meaning they have eight sets of chromosomes (that is, they're $8n$). Cotton is tetraploid ($4n$), and coffee can have as many as eight sets of chromosomes, while bananas are often triploid ($3n$). Many of these polyploids came about naturally and, after being discovered by plant breeders, were cultivated from cuttings (and other nonsexual plant propagation methods).

Not all polyploids are sterile. Those that result from crosses of two different species (called *hybridization*) are often fertile. The chromosomes of hybrids may have less trouble sorting themselves out during meiosis, allowing for normal gamete formation to take place. One famous animal example of a rarely fertile hybrid is a horse-donkey cross that results in a mule. Take a look at the “Stubborn chromosomes” sidebar for more information.

Stubborn chromosomes

Horses are diploid and have 64 chromosomes. Donkeys, which are also diploid, are closely related to horses but have only 62 chromosomes. When a horse mates with a donkey, the result is a mule. These horse-donkey hybrids are larger versions of horses and have big ears and a famously stubborn disposition. Mules are highly prized for their strength and reliable nature, though — just ask any mule owner (or a cadet at the U.S. Military Academy at West Point).

Mules are usually sterile because the ploidies of horses and mules (or of donkeys and mules) are a poor match. Genetically, mules have 32 horse chromosomes and 31 donkey chromosomes, giving them a total of 63 chromosomes altogether and the odd chromosome number of $2n = 63$ — that's diploid but not euploid. When meiosis takes place, the homologous chromosomes should pair up and then segregate. During meiosis in mules, however, chromosomes often come together in groups of three, five, or six. As a result, mule gametes don't get

a full complement of chromosomes and aren't viable to be fertilized. So how can any mule be a parent?

That's what the owners of a mule named Krause must have wondered in 1984 when she unexpectedly produced a foal, named Blue Moon because of the rarity of mule parenthood. Krause cohabitated with a male donkey, but genetic analysis revealed that Blue Moon had a mule genotype: 63 chromosomes that were half horse and half donkey. Apparently, when Krause's cells underwent meiosis, her horse chromosomes all segregated together. This is an outrageously improbable outcome — on the order of one in 4 billion! Even more amazingly, Krause had a second foal with the same horse-donkey genotype, meaning she produced a second egg with all horse chromosomes.

The only other way a mule can be a "parent" is via cloning, which I cover in Chapter 20. Idaho Gem, the first mule clone, was born in 2003.

Chromosome Disorders

Chromosomal abnormalities, in the form of aneuploidy (see "Aneuploidy: Extra or missing chromosomes"), are very common among humans. Roughly 8 percent of all conceptions are aneuploid, and it's estimated that up to half of all miscarriages are due to some form of chromosome disorder. Sex chromosome disorders are the most commonly observed type of aneuploidy in humans (flip to Chapter 5 for more on sex chromosomes) because X-chromosome inactivation allows individuals with more than two X chromosomes to compensate for the extra "doses" and survive the condition.

Four common categories of aneuploidy crop up in humans:

- ✔ **Nullisomy:** Occurs when a chromosome is missing altogether. Generally, embryos that are nullisomic don't survive to be born.
- ✔ **Monosomy:** Occurs when one chromosome lacks its homolog.

- ✓ **Trisomy:** Occurs when one extra copy of a chromosome is present.
- ✓ **Tetrasomy:** Occurs when four total copies of a chromosome are present. Tetrasomy is extremely rare.

Most chromosome conditions are referred to by category of aneuploidy followed by the number of the affected chromosome. For example, trisomy 13 means that three copies of chromosome 13 are present.

When chromosomes are left out

Monosomy (when one chromosome lacks its homolog) in humans is very rare. The majority of embryos with monosomies don't survive to be born. For live-born infants, the only autosomal monosomy reported in humans is monosomy 21. Signs and symptoms of monosomy 21 are similar to those of Down syndrome (covered later in this section). Infants with monosomy 21 often have numerous birth defects and rarely survive for longer than a few days or weeks. The other monosomy commonly seen in children is monosomy of the X chromosome. Children with this condition are always female and usually lead normal lives. For more on monosomy X (also known as Turner syndrome), see Chapter 5. Both monosomy 21 and monosomy 13 are the result of non-disjunction during meiosis (see the section "Aneuploidy: Extra or missing chromosomes" earlier in this chapter).

Many monosomies are partial losses of chromosomes, meaning that part (or all) of the missing chromosome is attached to another chromosome. Movements of parts of chromosomes to other, nonhomologous chromosomes are the result of *translocations*. Translocations are covered in more detail in the section "Translocations," later in this chapter.

Finally, monosomies can occur in cells as a result of mistakes that occur during cell division (mitosis). Many of these monosomies are associated with chemical exposure and various sorts of cancers. Chapter 14 covers cell monosomies and cancer in detail.

When too many chromosomes are left in



Trisomies (when one extra copy of a chromosome is present) are the most common sorts of chromosomal abnormalities observed in humans. The most common trisomy is Down syndrome, or trisomy 21. Other less common trisomies include trisomy 18 (Edward syndrome), trisomy 13 (Patau syndrome), and trisomy 8. All these trisomies are usually the result of nondisjunction during meiosis.

Down syndrome

Trisomy of chromosome 21, commonly called *Down syndrome*, affects between 1 in 600 to 1 in 800 infants. People with Down syndrome have some rather stereotyped physical characteristics, including distinct facial features, altered body shape, and short stature. Individuals with Down syndrome are usually mentally retarded and often have heart defects. Nevertheless, they often lead fulfilling and active lives well into adulthood.



One of the most striking features of Down syndrome (and trisomies, in general) is the precipitous increase in the number of Down syndrome babies born to mothers over 35 years of age (see Figure 15-3). Women between the ages of 18 and 25 have a very low risk of having a baby with trisomy 21 (roughly 1 in 2,000). The risk increases slightly but steadily for women between the ages of 25 and 35 (about 1 in 900 for women 30 years old) and then jumps dramatically. By the time a woman is 40 years old, the probability of having a child with Down syndrome is one in 100. By the age of 50, the probability of conceiving a Down syndrome child is 1 in 12. Why does the risk of Down syndrome increase in the children of older women?

Figure 15-3:
Risk of a
Down
syndrome
pregnancy
as a
function of
maternal
age.

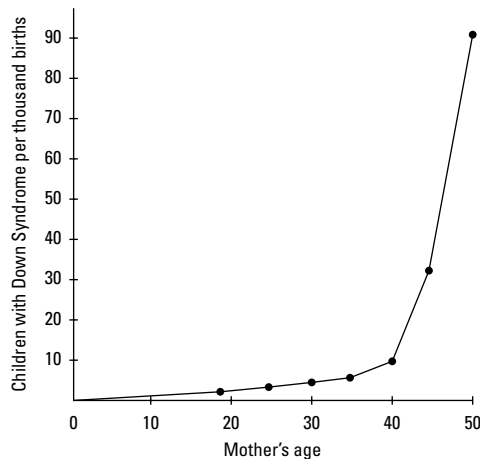

The majority of Down syndrome cases seem to arise from nondisjunction during meiosis. The reason behind this failure of chromosomes to segregate normally in older women is unclear. In females, meiosis actually begins in the fetus (flip back to Chapter 2 for a review of gametogenesis in humans). All developing eggs go through the first round of prophase, including recombination. Meiosis in future egg cells then stops in a stage called *diplotene*, the stage of crossing-over where homologous chromosomes are hooked together and are in the process of exchanging parts of their DNA. Meiosis doesn't start back up again until a particular developing egg is going through the process

of ovulation. At that point, the egg completes the first round of meiosis and then halts again. When sperm and egg unite, the nucleus of the egg cell finishes meiosis just before the nuclei of the sperm and egg fuse to complete the process of fertilization. (In human males, meiosis begins in puberty, is ongoing and continues without pauses like those that occur in females.)

Roughly 75 percent of the nondisjunctions responsible for Down syndrome occur during the first phase of meiosis. Oddly, most of the chromosomes that fail to segregate seem also to have failed to undergo crossing-over, suggesting that the events leading up to nondisjunction begin early in life. Scientists have proposed a number of explanations for the cause of nondisjunction and its associated lack of crossing-over, but no agreement has been reached about what actually happens in the cell to prevent the chromosomes from segregating properly.



Every pregnancy is an independent genetic event. So although age is a factor in calculating risk of trisomy 21, Down syndrome with previous pregnancies doesn't necessarily increase a woman's risk of having another child affected by the disorder.

Some environmental factors have been implicated in Down syndrome that may increase the risk for younger women (less than 30 years of age). Scientists think that women who smoke while on oral contraceptives (birth control pills) may have a higher risk of decreased blood flow to their ovaries. When egg cells are starved for oxygen, they're less likely to develop normally, and nondisjunction may be more likely to occur.

Familial Down syndrome

A second form of Down syndrome, *Familial Down syndrome*, is unrelated to maternal age. This disorder occurs as a result of the fusion of chromosome 21 to another autosome (often chromosome 14). This fusion is usually the result of a *translocation*, what happens when non-homologous chromosomes exchange parts. In this case, the exchange involves the long arm of chromosome 21 and the short arm of chromosome 14. This sort of translocation is called a *Robertsonian translocation*. The leftover parts of chromosomes 14 and 21 also fuse together but are usually lost to cell division and aren't inherited. When a Robertsonian translocation occurs, affected persons can end up with several sorts of chromosome combinations in their gametes, as shown in Figure 15-4.

For Familial Down syndrome, a translocation carrier has one normal copy of chromosome 21, one normal copy of chromosome 14, and one fused translocation chromosome. Carriers aren't affected by Down syndrome because their fused chromosome acts as a second copy of the normal chromosome. When a carrier's cells undergo meiosis, some of their gametes have one translocated chromosome or get the normal complement that includes one copy of each chromosome. Fertilizations of gametes with a translocated chromosome

produce the phenotype of Down syndrome. Roughly 10 percent of the liveborn children of carriers have trisomy 21. Carriers have a greater chance than normal of miscarriage due to monosomy (of either 21 or 14) and trisomy 14.

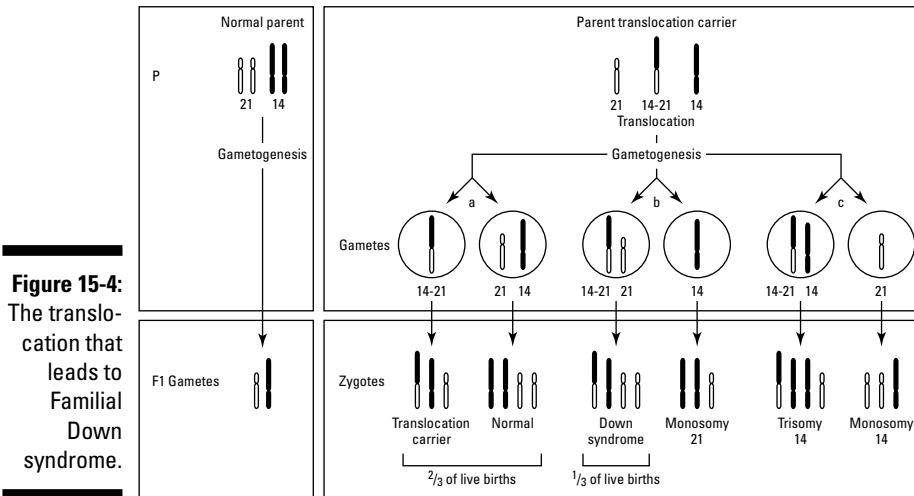

Other trisomies

Trisomy 18, also called Edward syndrome, also results from nondisjunction. About 1 in 6,000 newborns has trisomy 18, making it the second most common trisomy observed in humans. The disorder is characterized by severe birth defects including severe heart defects and brain abnormalities. Other defects associated with trisomy 18 include a small jaw relative to the face, clenched fingers, rigid muscles, and foot defects. Most affected infants with trisomy 18 don't live past their first birthdays. Like trisomy 21, trisomy 18 is associated with women who become pregnant over 35 years of age.

The third most common trisomy in humans is trisomy 13, or Patau syndrome. About 1 in 12,000 live births are affected by trisomy 13; many embryos with this condition miscarry early in pregnancy. Babies born with trisomy 13 have a very short life expectancy — most die before the age of 6 months. However, some may survive until 2 or 3 years of age; records show that two children with Patau syndrome lived well into childhood (one died at age 11 and the other at age 19). Babies affected by trisomy 13 have extremely severe brain defects along with many facial structure defects. Absent or very small eyes and other defects of the eye, cleft lips, cleft palates, heart defects, and polydactyly (extra fingers and toes) are common among these children.

Another type of trisomy, trisomy 8, occurs very rarely (1 in 25,000 to 50,000 births). Children born with trisomy 8 have a normal life expectancy but often are affected by mental retardation and physical defects such as contracted fingers and toes.

Other things that go wrong with chromosomes

In addition to monosomies and trisomies, numerous other chromosomal disorders can occur in humans. Whole sets of chromosomes can be added, or chromosomes can be broken or rearranged. This section covers some of these other sorts of chromosome disorders.

Polyploidy

Polyploidy, the occurrence of more than two sets of chromosomes, is extremely rare in humans. Two reported conditions of polyploidy are triploid (three full chromosome sets) and tetraploid (four sets). Most polyploid pregnancies result in miscarriage or stillbirth. All liveborn infants with triploidy have severe, untreatable birth defects, and most don't survive longer than a few days.

Mosaicism

Mosaicism is a form of aneuploidy that creates patches of cells with variable numbers of chromosomes. Early in embryo development, a nondisjunction similar to the one shown in Figure 15-1 can create two cells that are aneuploid (most often one cell is trisomic, with one extra chromosome copy, and the other monosomic, with a chromosome missing its homolog). A cell can also lose a chromosome, leading to a monosomy without an accompanying trisomy. All the cells that descend from the aneuploid cells created during mitosis are also aneuploid. The magnitude of the effects of mosaicism depends on when the error occurs: If the error happens very early, then most of the individual's cells are affected.

Most mosaicisms are lethal except when the mosaic cell line is confined to the placenta. Many embryos with placenta mosaics develop normally and suffer no ill effects. Sex chromosome mosaics are the most common in humans; XO-XXX and XO-XXY are common mosaic genotypes. Trisomy 21 also appears as a mosaic with normal diploid cells. In general, individuals with mosaicism are affected in the same ways as persons who are entirely aneuploid.

Fragile X

Many chromosomes have fragile sites, parts of the chromosome that show breaks when the cells are exposed to certain drugs or chemicals. Eighty such fragile sites are common to all humans, but other sites appear due to rare mutations. One such site, Fragile X on the X chromosome, causes the most common inherited form of mental retardation.

Fragile X results from a mutation in a gene called FMR1 (for Fragile Mental Retardation gene 1). Like many X-linked mutations, Fragile X is recessive. Therefore, women are usually mutation carriers, and men are most often affected by the disorder. Males with Fragile X usually have some form of mental retardation that can vary in severity from mild behavioral or learning disabilities all the way to severe intellectual disabilities and autism. Men and boys with Fragile X often have prominent ears and long faces with large jaws.

Fragile X often shows *genetic anticipation* — that is, the disorder gets more severe from one generation to the next. Within FMR1, there is a series of three bases that are repeated over and over (see Chapter 6 for details about how DNA is put together). When the DNA's replicated (or copied; see Chapter 7), it's easy for repeats to be added by mistake, making the repeat sequence longer. In persons with Fragile X, the three bases can be repeated hundreds of times (instead of the normal 60). As the gene gets longer, the effects of the mutation become more severe, with subsequent offspring suffering stronger effects of the disorder. You can find out more about anticipation in Chapter 4.

Rearrangements

Large-scale chromosome changes are called *chromosomal rearrangements*. Four kinds of chromosomal rearrangements, shown in Figure 15-5, are possible:

- ✔ **Duplication:** Large parts of the chromosome are copied more than once, making the chromosome substantially longer.
- ✔ **Inversion:** A section of the chromosome gets turned around, reversing the sequence of genes.
- ✔ **Deletion:** Large parts of the chromosome are lost.
- ✔ **Translocation:** Parts are exchanged between non-homologous chromosomes.

Duplication

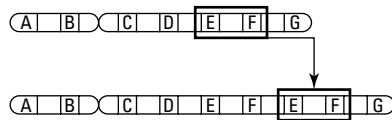

Inversion

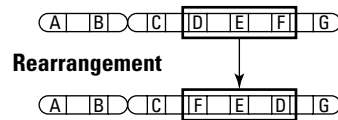

Deletion

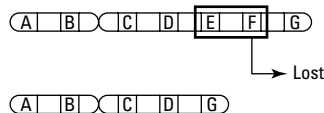

Translocation

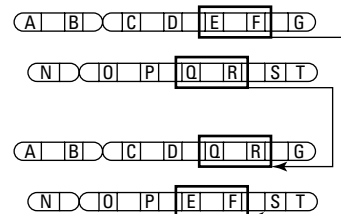

Figure 15-5:
The four kinds of chromosomal rearrangements.



All chromosomal rearrangements are mutations. Normally, mutations are very small changes within the DNA (that often have very big impacts). Mutations that involve only a few bases can't be detected by staining the chromosomes and examining the karyotype (see "Studying Chromosomes" for more on karyotypes). However, large-scale chromosomal changes can be diagnosed from the karyotype because they involve huge sections of the DNA. In humans, deletions and duplications are common causes of mental retardation and physical defects.

Duplications

Duplications (in this case, large unwanted copies of portions of the chromosome) most often arise from unequal crossing-over (see "Deletions" later in this chapter). Most disorders arising from duplications are considered partial trisomies because large portions of one chromosome are usually present in triplicate.

Duplication of part of chromosome 15 is implicated in one form of autism. Autistic persons typically have severe speech impairment, don't readily interact or respond to other persons, and exhibit ritualized and repetitive behaviors. Mental retardation may or may not be present. Persons with autism are difficult to assess because of their impaired ability to communicate. Other chromosomal rearrangements, including large-scale deletions and translocations, have also been identified in cases of autism.

Inversions

If a chromosome break occurs, sometimes DNA repair mechanisms (explained in Chapter 13) can repair the strands. If two breaks occur, part of the chromosome may be reversed before the breaks are repaired. When a large part of the chromosome is reversed and the order of the genes is changed, the event is called an *inversion*. When inversions involve the centromere, they're called *pericentric*; inversions that don't include the centromere are called *paracentric*.

Hemophilia type A may be due, in some cases, to an inversion within the X chromosome. Patients with hemophilia have impaired blood clot formation; as a result, they bruise easily and bleed freely from even very small cuts. Very mild injuries can result in extremely severe blood loss. Like most X-linked disorders, hemophilia is more common in males than females. In this case, two genes coding for the clotting factors are interrupted by the inversion, rendering both genes nonfunctional.

Deletions

Deletion, or loss, of a large section of a chromosome usually occurs in one of two ways.

- ✓ The chromosome breaks during interphase of the cell cycle (see Chapter 2 for cell cycle details), and the broken piece is lost when the cell divides.
- ✓ Parts of chromosomes are lost due to unequal crossing-over during meiosis.

Normally, when chromosomes start meiosis, they evenly align end to end with no overhanging parts. If chromosomes align incorrectly, crossing-over can create a deletion in one chromosome and an insertion of extra DNA in the other, as shown in Figure 15-6. Unequal crossover events are more likely to occur where many repeats are present in the DNA sequence (see Chapter 11 for more on DNA sequences).

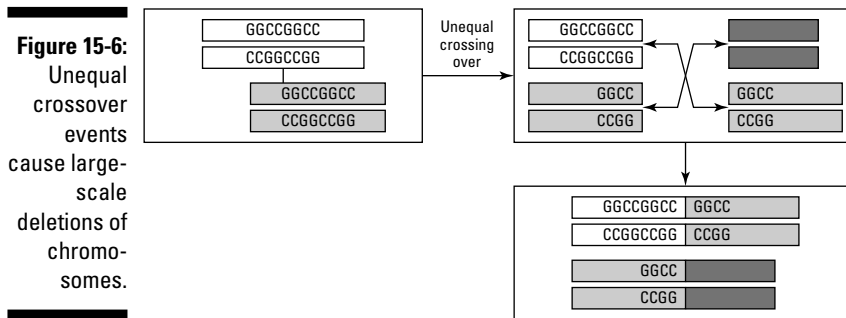

Cri-du-chat syndrome is a deletion disorder caused by the loss of the short arm of chromosome 5 (varying amounts of chromosome 5 can be lost, up to 60 percent of the arm). *Cri-du-chat* is French for “cry of the cat” and refers to the characteristic meowing sound that infants affected by the syndrome make. *Cri-du-chat* acts as an autosomal dominant; affected persons are almost always heterozygous for the mutation. Children with *Cri-du-chat* have unusually small heads, round faces, wide-set eyes, and intellectual disabilities. *Cri-du-chat* is one of the most common chromosomal rearrangement deletions and occurs in about 1 in 20,000 births. Most persons with *Cri-du-chat* don’t survive into adulthood. Because the majority of these deletions are new mutations, there’s usually no family history of *Cri-du-chat*.

Deletion of part of the long arm of chromosome 15 results in *Prader-Willi syndrome*. This particular deletion is almost always in the father’s chromosome, and the tendency to pass on the deletion appears to be heritable. Women with pregnancies affected by *Prader-Willi* usually notice that their babies start moving in the womb later and move less than unaffected babies. Affected infants are less active and have decreased muscle tone, which sometimes causes breathing problems. These infants have trouble feeding and usually

don't grow at a normal rate. Children with Prader-Willi syndrome are mentally retarded, but their intellectual disabilities usually aren't very severe. Feeding problems early in life often give way to obesity later on, but persons with Prader-Willi are almost always of unusually small stature. Like Cri-du-chat, Prader-Willi is often the result of spontaneous mutation but can be inherited as an autosomal dominant disorder (see Chapter 12 for more on genetic disorders).

Translocations

Translocations involve the exchange of large portions of chromosomes. They occur between nonhomologous chromosomes and come in two types:

- ✔ **Reciprocal translocation:** An equal (balanced) exchange in which each chromosome winds up with part of the other. This is the most common form of translocation.
- ✔ **Nonreciprocal translocation:** An uneven exchange in which one chromosome gains a section but the other chromosome does not, resulting in a deletion.

Like inversions, translocations can result from broken chromosomes that get mismatched before the repair process is complete. When two chromosomes are broken, they can exchange pieces (reciprocal or balanced translocation), gain pieces (nonreciprocal translocation), or lose pieces (deletion). When the breaks interrupt one or more genes, those genes are rendered nonfunctional.

One disorder in humans that sometimes involves a balanced translocation event is bipolar disorder. Bipolar disorder may result when chromosomes 9 and 11 exchange parts, interrupting a gene on chromosome 11. This gene, called DIBD 1 (for Disrupted in Bipolar Disorder gene 1) has also been implicated in other psychiatric disorders such as schizophrenia.

Chromosomes 11 and 22 are often involved in balanced translocation events that cause birth defects (such as cleft palate, heart defects, and mental retardation) and a hereditary form of breast cancer. Chromosome 11 seems particularly prone to breakage in an area of the chromosome with many repeated sequences (where two bases, A and T, are repeated many times sequentially). Most repeated sequences like this one are considered junk DNA (see Chapter 11 for an explanation of junk DNA). Because both chromosome 11 and chromosome 22 contain similar repeat sequences, the repeats may allow crossover events to occur by mistake, resulting in balanced translocations.

In many cases, a translocation event occurs spontaneously in one parent, who then passes the disrupted chromosomes on to his or her offspring, resulting in partial trisomies and partial deletions. In these cases, the carrier parents may be unaffected by the disorder.

Chapter 16

No Couch Needed: Gene Therapy

In This Chapter

- ▶ Delivering healthy genes to treat or cure disease
 - ▶ Finding the genes needed for gene therapy
 - ▶ Charting progress on the road to gene cures
-

The completion of the Human Genome Project in 2004, along with the sequencing of nonhuman genomes, has spawned an incredible revolution in the understanding of genetics. Simultaneously, geneticists have raced to develop medicines to treat and cure diseases caused by genes gone awry. *Gene therapy*, treatment that gets at the direct cause of genetic disorders, is sometimes touted as the magic bullet, the cure-all for inherited diseases (see Chapter 13 for a partial list) and cancer (see Chapter 14). Gene therapy may even provide a way to block the genes of pathogens such as the virus that causes AIDS, providing reliable treatments for illnesses that currently have none.

Unfortunately, the shining promise of gene therapy has been hampered by a host of factors including finding the right way to supply the medicine to patients without causing new or worse problems than the ones being treated. In this chapter, you examine the progress and perils of gene therapy.

Curing Genetic Disease

Take a glance back through Part III of this book for proof that your health and genetics are inextricably linked. Not only do mutations cause disorders that are passed from generation to generation, but mutations acquired during your lifetime can have unwanted consequences such as cancer. And your own genes aren't the only ones that cause complications — the genes carried by bacteria, parasites, and viruses lend a hand in spreading disease and dismay worldwide.

So wouldn't it be great if you could just turn those pesky bad genes off? Just think: A mutation causes a loss of function in a tumor suppressor gene, and you get a shot to turn that gene back on. A virus giving you trouble? Just take

a pill that blocks the function of viral genes. Some geneticists see the implementation of these genetic solutions to health problems as only a matter of time. Therefore, the development of gene therapy has focused on two major courses of action:

- ✓ Supplying genes to provide desired functions that have been lost or are missing
- ✓ Blocking genes from producing unwanted products

Finding Vehicles to Get Genes to Work

The first step in successful gene therapy is designing the right delivery system to introduce a new gene or shut down an unwanted one. The delivery system for gene therapy is called a *vector*. A perfect vector

- ✓ Must be innocuous so that the recipient's immune system doesn't reject or fight the vector.
- ✓ Must be easy to manufacture in large quantities. Just one treatment may require over 10 billion copies of the vector because you need one delivery vehicle for each and every cell in the affected organ.
- ✓ Must be targeted for a specific tissue. Gene expression is tissue-specific (see Chapter 10 for details), so the vector has to be tissue-specific, too.
- ✓ Must be capable of integrating its genetic payload into each cell of the target organ so that new copies of each cell generated later on by mitosis contain the gene therapy payload.



Currently, viruses are the favored vector. Most gene therapies aim to put a new gene into the patient's genome, so it's pretty easy to understand why viruses are appealing candidates for vectorhood — this gene-sharing action is almost precisely what viruses do naturally.

When a virus latches onto a cell that isn't somehow protected from the virus, the virus hijacks all that cell's activities for the sole purpose of making more viruses. Viruses reproduce this way because they aren't really alive and have no moving parts of their own to accomplish reproduction. Part of the virus's attack strategy involves integrating virus DNA into the host genome in order to execute viral gene expression. The problem is that when a virus is good at attacking a cell, it causes an infection that the patient's immune system fights. So the trick to using a virus as a vector is taming it.

Gentling a virus for use as a vector usually involves deleting most of its genes. These deletions effectively rob the virus of almost all its own DNA, leaving only a few bits. These remaining pieces are primarily the parts normally used by the virus for getting its DNA into the host. Using DNA manipulation techniques like

those described in the “Inserting Healthy Genes into the Picture” section of this chapter, the scientist splices a healthy gene sequence into the virus to replace the deleted parts of the viral genome. Like the delivery truck drivers that bring packages to your doorstep, a helper is needed to move the payload from the virus to the recipient cell. The scientist sets up another virus particle with some of the deleted genes from the vector. This second virus, called a *helper*, makes sure that the vector DNA replicates properly.

Geneticists conducting gene therapy have several viruses to choose from as possible delivery vehicles (vectors). These viruses fall into one of two classes:

- ✓ Those that integrate their DNA directly into the host’s genome
- ✓ Those that climb into the cell nucleus to become permanent but separate residents (called *episomes*)

Within these two categories, three types of viruses — oncoretroviruses, lentiviruses, and adenoviruses — are popular choices for gene therapy.

Viruses that join right in

Two popular viruses for gene therapy integrate their DNA directly into the host’s genome. *Oncoretroviruses* and *lentiviruses* are retroviruses that transfer their genes into the host genome; when the retrovirus genes are in place, they’re replicated right along with all the other host DNA. Retroviruses use RNA instead of DNA to code their genes; these viruses use a process called reverse transcription (described in Chapter 10) to convert their RNA into DNA, which is then inserted into a host cell’s genome.

Oncoretroviruses, the first vectors developed for gene therapy, get their name from *oncogenes*, which turn the cell cycle permanently on — one of the precursors to development of full-blown cancer. Most of the oncoretrovirus vectors in use for gene therapy trace their history back to a virus that causes leukemia in monkeys (it’s called Moloney murine leukemia virus, or MLV). MLV has proven an effective vector, but it’s not without problems; MLV’s propensity to cause cancer has been difficult to keep in check. Oncoretroviruses work well as vectors only if they’re used to treat cells that are actively dividing.

Lentiviruses, on the other hand, can be used to treat cells that aren’t dividing. You’re probably already familiar with a famous lentivirus: HIV. Vectors for gene therapy were developed directly from the HIV virus itself. Although the gutted virus vectors contain only 5 percent of their original DNA, rendering them harmless, lentiviruses have the potential to regain the deleted genes if they come in contact with untamed HIV virus particles (that is, the ones that infect people with AIDS). Lentiviruses are also a bit dicey because they tend to put genes right in the middle of host genes, leading to loss-of-function mutations (this and other mutations are detailed in Chapter 13). Nonetheless,

HIV lentivirus vectors are used to combat AIDS. The vector virus carries a genetic message that gets stored in the patient's immune cells. When HIV attacks these immune cells, the vector DNA blocks the attacking virus from replicating itself, effectively protecting the patient from further infection. So far, this treatment seems to work and substantially reduces the amount of virus carried by affected persons.

Viruses that are a little standoffish

Adenoviruses are excellent vectors because they pop their genes into cells regardless of whether cell division is occurring. Adenoviruses have been both promising and problematic. On the one hand, these viruses are really good at getting into host cells. On the other hand, adenoviruses tend to excite a strong immune response — the patient's body senses the virus as a foreign particle and fights it. To combat the immune reaction, researchers have worked to delete the genes that make adenoviruses easy for the host to recognize.

Adenoviruses don't put their DNA directly into the host genome. Instead, they exist separately as episomes, so they aren't as likely to cause mutations as lentiviruses. The drawback is that the episomes aren't always replicated and passed on to daughter cells when the host cell divides. Nonetheless, adenovirus vectors have been used with notable success — and failure. (See "Making Slow Progress on the Gene Therapy Front" at the end of the chapter for the details.)

Inserting Healthy Genes into the Picture

Finding the right delivery system is a necessary step in mastering gene therapy, but to nab genes and put them to work as therapists, geneticists must also find the right ones. Because finding healthy genes isn't simple, gene mapping is still a major obstacle in the road to implementing gene therapy. Imagine you're handed a man's photograph and told to find him in New York City — no name, no address, no phone number. The task of finding that man includes figuring out his identity (maybe by finding out who his friends are), figuring out what he does for a living, narrowing your search to the borough he lives in, and identifying his street, block, and, finally, his address. This wild-goose chase is almost exactly like the gargantuan task of finding genes.

Your DNA has roughly 25,000 genes tucked away amongst around 3 billion base pairs of DNA. (Flip back to Chapter 6 for how DNA is sized up in base pairs.) Because most genes are pretty small, relatively speaking (often less than 5,000 base pairs long; see Chapter 8), finding just one gene in the midst of

all the genetic clutter may sound like a nearly impossible task. Until recently, the only tool geneticists had in the search for genes was the observation of patterns of inheritance (like those shown in Chapter 12) and the subsequent comparisons of how various groups of traits were inherited. This method, called *linkage analysis*, is used to construct gene maps (see Chapter 4). With the advent of DNA sequencing (see Chapter 11), however, the search for names and addresses of genes has reached a whole new level (but the search still isn't over; see the sidebar "The role of the Human Genome Project"). Now, geneticists hook up with a giant network of people to nail down the exact locations of genes:

1. Physicians identify a disorder by observing a phenotype caused by mutation. Essentially, this is the face of the gene.
2. Genetic counselors work with patients and their families to gather complete medical histories (see Chapter 12). Analysis of family trees may uncover other traits that associate with the disorder.
3. Cell biologists look at the karyotypes of many affected people and link traits to obvious chromosomal abnormalities. These large-scale changes in chromosomes often provide hints about where genes reside. (Chapter 15 examines methods of karyotyping.)
4. Population geneticists analyze the DNA of large groups of people with and without the disease to narrow down which chromosomes and which genes are involved with the disease.
5. Biochemists study the chemical processes in the affected organs of people with the disease to identify the physiology of the disorder. Often, they're able to nab the precise protein-gone-wrong.
6. With the protein in hand, geneticists use the genetic code (profiled in Chapter 9) to work backwards from the building blocks of that protein, the specific amino acids, to discern what the mRNA instructions were.

Identifying the right protein and backtracking to the mRNA pattern is extremely helpful, but it still doesn't divulge the identity of the gene. (Problems include the fact that mRNAs are often heavily edited before they're translated into proteins [see Chapter 9] and the fact that the code is degenerate, meaning that more than one codon can be used to get a particular amino acid). The protein provides a general idea of what the gene address is, but it's not precise enough. To close in on the right address, the gene hunter has to sort through the DNA itself.

The entire gene-hunting safari depends on vast computer databases that are easily accessed by the entire scientific community. These databases allow investigators to search professional journals to keep up with new discoveries by other scientists. Researchers are also constantly adding new pieces of the puzzle, such as newly identified proteins, to storehouses of data. You can take

a peek into the genetic data warehouse by visiting www.ncbi.nlm.nih.gov/entrez/query.fcgi?db=OMIM. The NCBI link in the upper left part of the page leads you to the homepage of the National Center of Biotechnology Information. From there, you can explore anything from DNA to protein data compiled by scientists from around the world.



Recombinant DNA technology is the catchall phrase that covers most of the methods geneticists use to examine DNA in the lab. The word *recombinant* is used because DNA from the organism being studied is often popped into a virus or bacteria (that is, it's recombined with DNA from a different source) to allow further study. Recombinant DNA is also used for a vast number of other applications, including creating genetically engineered organisms (see Chapter 19) and cloning (see Chapter 20). In the case of gene therapy, recombinant DNA is used to

- ✓ Locate the gene (or genes) that's involved in a particular disorder or disease.
- ✓ Cut the desired gene out of the surrounding DNA.
- ✓ Pop the gene into a vector (delivery vehicle) for transfer into the cells where treatment is needed.

The role of the Human Genome Project

Can't geneticists just look up the genes they need from all the sequencing data collected by the Human Genome Project, or HGP? Someday the answer will be yes, but we're not there yet. By 2005, 99 percent of the gene-rich part of the genome (called the *euchromatin*) is fully sequenced. That's the good news. The bad news for gene hunters is that a whopping 20 percent of the noncoding regions of the genome still aren't sequenced.

The noncoding part of the genome that's mostly junk DNA (the heterochromatin) has been tough to work with because it's made up of repetitive sequences. All that repetition makes putting the sequences into their proper order extremely difficult. Some scientists think it may be another five years before the Human Genome Project is truly complete in the sense that the entire sequence of the whole human genome is known. Even a complete HGP leaves much left to learn; for example, researchers still don't know how many

total genes there are (probably around 25,000 but possibly more or fewer). And many genes are yet to be discovered; what they control and where they're located are still unknown.

Unfortunately, the maps constructed by the HGP of the entire humane genome are drawn at the wrong scale to be useful for pinpointing the locations of genes. To get an idea of how scale can be a problem, think about looking at a road map. A low-resolution highway map can help you find your way from one city to another, but it can't guide you to a very specific street address in a particular city.

What it comes down to is that geneticists have only just started to explore the billions of base pairs that contain the genetic instructions that make humans tick. That's why the gene hunt is likely to go on for a long time to come. (For full coverage of the HGP, flip to Chapter 11.)

Checking out a DNA library

One of the most popular methods for tracking down a specific gene is creating a *DNA library*. That's just what it sounds like: a library filled with chunks of DNA instead of books. Geneticists can paw through the library to nail down the piece of DNA containing the gene of interest. One popular version of the genetic library method is called a *cDNA library* — a collection of genetic instruction manuals that are actually in use in a specific cell (the *c* stands for *complementary* because the whole process actually starts by copying mRNA messages into complementary DNA format).



The idea behind a cDNA library is to harvest all the mRNAs found in a cell that's involved in some genetic disease (you can find out more about RNA in Chapter 8). Because gene expression is tissue-specific (see Chapter 10), the mRNAs in any given cell represent only the genes that are at work there. So instead of plowing through all 25,000 genes of the human genome to find the one that's in trouble, geneticists can narrow the target to only the few hundred that are found in a particular cell.

Harvesting and converting mRNA

The first step in creating a cDNA library is harvesting mRNAs, and the fastest way to nab mRNAs is to grab their tails. When an mRNA is getting dressed for its trip out of the nucleus and into the cytoplasm for translation, a long string of adenine ribonucleotides gets hitched on the mRNA's back. This string, called a *poly-A tail*, helps protect the mRNA from decomposing before it finishes its job. To find the mRNAs being produced by a cell's genes, geneticists use chemicals to break open cells, and then they strain out the mRNAs by exposing their tails to long strings of thymine nucleotides. The As (adenines) in the tails naturally hook up with the complementary Ts (thymines) because of the bases' natural affinities for each other.

Undergoing reverse transcription

After scientists harvest the mRNAs of a cell, they convert the mRNAs' messages back to DNA by reversing the process of transcription. *Reverse transcription* works a lot like DNA replication (see Chapter 7). The primer used for reverse transcription is a long string of Ts (thymines) complementary to the mRNA's poly-A tail. A special enzyme called *reverse transcriptase*, which is isolated from a virus, tacks dNTPs onto the primer to create a DNA copy of the mRNA.

After the DNA copy of the mRNA is made, the order of the bases — the As, Gs, Cs, and Ts — on the 5' end of the DNA sequence is determined (flip back to Chapter 6 for how DNA's ends are numbered) using DNA sequencing (see Chapter 11). This partial DNA sequence (about 500 bases or so) is referred to as an *expressed sequence tag* (EST). It's *expressed* because only the exons are present in the DNA sequence, and *tag* comes from the fact that only part of the entire gene sequence is obtained (and therefore "tagged").

Screening the library

With ESTs created (see the preceding section), gene hunters examine every “book” in the cDNA library to find the particular gene that causes the disease. This process is called *screening* the library. The idea here is to spread out all the ESTs and sort through them to find the precise EST that came from the gene scientists are looking for. The difficulty of screening the library depends on what’s already known about the gene. For example, knowing what the protein-gone-wrong is can provide enough genetic information to give scientists a head start in their search. Sometimes, geneticists even look at what’s known about genes with similar functions in other organisms and start there.

Regardless of the clues available to the gene hunter, screening involves making thousands of identical copies, or *clones*, of each EST by popping it into a bacteria or virus. Because ESTs are so tiny (DNA-wise), it’s impossible to manipulate only one copy at a time. The cloning process separates the ESTs into neat little identical stacks, each composed of thousands of copies of only one EST.

One method used to clone ESTs is called *bacteriophage cloning*. Bacteriophages (phages, for short) are handy little viruses that make a living by injecting their DNA directly into bacterial cells.



To infect bacterial cells, the bacteriophages hop onto the outer cell wall and inject their DNA into the bacterium, where the phage DNA integrates directly into the bacterium’s own DNA. The viral genes get replicated, transcribed, and ultimately translated using the machinery of the bacterial cells. Eventually, the phage genes set off a new phase that breaks up the bacterial DNA and frees the phage genome. The phage DNA gets replicated many times within the bacterial cells, and new phage protein shells are also produced. The bacterial cells eventually burst open, freeing the newly completed phages to infect other cells.

Here’s how these funky-looking viruses get harnessed to make copies of ESTs:

1. Geneticists take a mixture of ESTs and splice them into the DNA of thousands of bacteriophages.

To splice the ESTs into the phages, the phage DNA (which is circular) is cut open using a *restriction enzyme*. Restriction enzymes cut DNA at sites called palindromes, where the complementary sequence of bases reads the same way backwards and forwards (like 5’-GATC-3’ whose complement is 3’-CTAG-5’). The restriction enzyme always cuts between the same two bases, like between the G and the A, on both strands. When pulled apart, the resulting pair of cuts leave overhanging, single-stranded ends on one long piece of phage DNA. The ESTs are treated with enzymes to give them *sticky ends*, overhanging bits complementary to the ends left in the phage DNA. When mixed together, the phage DNA and the ESTs match their sticky ends together, completing the circle of phage DNA except that each copy of the phage now contains an EST along with its own DNA.

2. The EST-carrying phages are mixed with their favorite victims, bacteria, and poured into Petri dishes.
3. After the viruses spread out and do their jobs (about 24 hours after the mixing with bacteria), the result is little pits in an otherwise uniform layer of bacteria growing in the Petri dish. Each little pit, called a *plaque*, represents infection caused by one phage that's reproduced and, by a chain reaction of infections, caused many bacterial cells to die and pop open. Each individual infection site represents many thousands of copies of one EST.

With thousands of ESTs and their copies, the only task that remains is finding the EST that's associated with the gene being hunted. Using the protein-gone-wrong as a guide, scientists can make a guess at what the EST may look like. After they decide what kind of DNA sequence may complement the EST, they order a special kit of DNA, called a *probe*, custom-made to match the sequence they want. A probe is complementary to all or part of the EST in question, and it's marked with dye so scientists can find it after it bonds with the EST. Each EST is treated to make it single-stranded, and the ESTs are exposed to the probe. The probe forms a double-stranded molecule only with the EST that it matches; the matched set is found with special equipment that allows the dye to glow brightly.

Scientists can also use an EST to search among chromosomes to nail down the general location of a gene. The geneticist makes a karyotype — a collection of all the chromosomes that can be examined under the microscope (see Chapter 15). The chromosomes are treated to allow the fluorescent-dyed EST to bind with its complement on the intact chromosomes. The dyed EST sticks to the nontemplate strand from which its mRNA counterpart came. Scientists can see the results of this process with the help of a special microscope: The region where the EST attaches to its complement (the attachment process is referred to as *hybridization*) reflects brightly under ultraviolet light. This entire procedure, called *fluorescent in situ hybridization* (or FISH, for short) allows researchers to target a region of a particular chromosome for their gene hunt but isn't very specific because of the way DNA is packaged (see Chapter 6). In essence, FISH narrows the target to a few million base pairs for scrutiny. But this isn't the last piece of the puzzle: With only part of the address (provided by the right EST) and the street name (the chromosome), gene hunters need to make a high-resolution map to complete their search successfully.

Mapping the gene

Thanks to the progress of the Human Genome Project, scientists have maps for each of the chromosomes, and each map has many landmarks, called STSs for *sequence tagged sites*. Sequence tagged sites are short stretches of unique combinations of bases scattered around the chromosome. No two STSs are alike, so they provide unique landmarks wherever they occur. A complete STS map reveals the total distance from one end of the chromosome

to the other (in base pairs) along with the landmarks along the way. An STS map is a bit like knowing the locations of Times Square, the Empire State Building, and Central Park relative to the entire island of Manhattan. You may know that a street you're looking for is between Central Park and the Empire State Building, but there are hundreds of little blocks to choose from in an area that size. STSs and other landmarks in the genome are a lot like that — scientists may know that an EST is between two STSs, but the STSs themselves may be 20,000 bases apart!

Using the EST nabbed as a starting point, geneticists sequence the DNA of the chromosome in both directions in a process called *chromosome walking*. Basically, they have to compile enough sequence information to run across at least two STS landmarks on the map, one in each direction. To continue with the city analogy, chromosome walking is like laying maps of neighborhoods together end to end until two major landmarks are connected. Chromosome walking provides the last two vital pieces in the puzzle: the exact location of the gene relative to the rest of the chromosome and (finally!) the entire gene sequence associated with the EST.



With the completion of the Human Genome Project, mapping genes is getting easier and easier. Scientists can take their own EST sequence information and check the database to see if their sequence falls out on a preexisting map. Chromosome walking is still necessary to get the precise location of the gene relative to everything around it, however.

After a gene is precisely mapped, the gene sequences of many people (both with and without the disease) are compared to determine exactly what the mutation is (that is, how the gene differs between affected and unaffected people). (All this information eventually winds up in the database Mendelian Inheritance in Man; see Chapter 24 to get a peek.)

After the gene's located, many thousands of precise replicas of a healthier version of the gene can be made through a *polymerase chain reaction*, the process used for DNA fingerprinting (see Chapter 18). The copies of the healthy gene are popped into the vector used for gene therapy with the same methods that were used to make the cDNA library described here.

Making Slow Progress on the Gene Therapy Front

As the Human Genome Project started fulfilling the dreams of geneticists worldwide, realizing gene therapy's promises seemed very much in reach. In fact, the first trials conducted in 1990 were a resounding success.

In those first attempts at gene therapy, two patients suffering from the same immunodeficiency disorder received infusions of cells carrying genes coding for their missing enzymes. The disorder being treated was a form of Severe Combined Immunodeficiency (SCID); this particular brand of SCID results from the loss of one enzyme: adenosine deaminase (ADA). SCID is so severe that affected persons must live in completely sterilized environments with no contact to the outside world because even the slightest infection is likely to prove deadly. Because only one gene is involved, SCID is a natural candidate for treatment with gene therapy. Retroviruses armed with a healthy ADA gene were infused into the two affected children with dramatic results: Both children were essentially cured of the disease and now lead normal lives.

The greatest success of gene therapy thus far, however, may ultimately be a failure as well. At least 15 children (as of October 2004) have been treated for an X-linked version of SCID. These children also received a retrovirus loaded with a healthy gene and were apparently cured. However, three of the children have since been diagnosed with a cancer of the blood, leukemia. The virus that delivered the gene also plopped its DNA right into a proto-oncogene, switching it on (flip back to Chapter 14 for more about the actions of oncogenes).

The most famous failure of gene therapy occurred in 1999 when 18-year-old Jesse Gelsinger volunteered for a study aimed at curing a genetic disorder called ornithine transcarbamylase (OTC) deficiency. With this disorder, Jesse occasionally suffered a huge buildup of ammonia in his body because his liver lacked enough of the OTC enzyme to keep up with processing all the nitrogen waste products in his blood. Jesse's disease was controlled medically — with drugs and diet — but other affected children often die of the disease. Jesse volunteered to help test a newly developed gene therapy aimed at curing the disorder. Researchers used an adenovirus to deliver a normal OTC gene directly into Jesse's liver. (See "Viruses that are a little standoffish" for the scoop on adenoviruses.) The virus escaped into Jesse's bloodstream and accumulated in his other organs. His body went into high gear to fight what seemed like a massive infection, and four days after receiving the treatment that was meant to cure him, Jesse died. Oddly, another volunteer in the same experimental trial received the same dose of virus that Jesse did and suffered no ill effects at all.

Despite these setbacks, experimental trials for gene therapies continue. (Most are focused on cancers.) Although they're unruly, viruses still seem to be the best delivery trucks to cart good genes in to foil bad ones. The biggest problem that remains is rendering the viruses truly harmless to avoid large-scale immune responses like the one that killed Jesse Gelsinger. Researchers are also working to engineer vectors that are more tissue-specific. The promise of gene therapy may ultimately be realized, but it looks like a long, difficult, and dangerous road ahead.

Part IV

Genetics and Your World

The 5th Wave

By Rich Tennant



“The body’s been contaminated, Lieutenant. Apparently all the King’s men tried putting it back together, and— get this— some of the horses got in on the action.”

In this part . . .

Genetics makes the world go around and may affect your life more now than ever before. The technology surrounding genetics and its consequences can seem bewildering, so this part aims to make understanding all the possibilities less daunting.

In this part, I summarize how you can trace human history using genetics and how human activities affect the genetics of populations of animals and plants around the world. If you've ever marveled at the crime solving power of forensics, you get all the details of DNA's contributions to the war on crime here. With the same technology used in forensics, humans can move genes from one organism to another for all sorts of reasons; I explain the perils and progress in genetic engineering and cloning in this part. And finally, because genetics knowledge opens up a lot of choices, I cover the ups and downs of ethics and genetics.

Chapter 17

Tracing Human History and the Future of the Planet

In This Chapter

- ▶ Relating the genetics of individuals to the genetics of groups
 - ▶ Describing genetic diversity
 - ▶ Using genetics to protect endangered species
-

It's impossible to overestimate the influence of genetics on our planet. Every living thing depends on DNA for its life, and all living things, including humans, share DNA sequences. The amazing similarities between your DNA and the DNA of other living things suggest that all living things trace their history back to a single source. In a very real sense, all creatures great and small are related somehow.

The genetic underpinnings of life can be examined in all sorts of ways. One powerful method for understanding the patterns hidden in your DNA is to compare the DNA of many individuals as a group. This specialty, called *population genetics*, is a powerful tool. Geneticists not only study human populations this way, but they also apply it to animal populations to understand how to protect endangered species, for example. In this chapter, you find out how scientists analyze the genetics of many individuals all at once to understand where we came from and where we're going.

Genetic Variation Is Everywhere

The next time you find yourself channel surfing on the TV, pause a moment on one of the channels devoted to science or animals. The diversity of life on earth is truly amazing. In fact, scientists still haven't discovered all the species living on our planet; the vast rainforests of South America, the deep-sea vents of the ocean, and even volcanoes hold undiscovered species. (Check out the sidebar "What's a species? And why does it matter?" to see how scientists define what's what.)



The interconnectedness of all living things, from a scientific perspective, can't be overstated. The sum total of all the life on earth is referred to as *biodiversity*. Biodiversity is self-sustaining and is life itself. Together, the living things of this planet provide oxygen for you (and everything else) to breathe, carbon dioxide to keep plants alive and regulate the temperature and weather, rainwater for you and your food supply, nutrient cycling to nourish every single creature on earth, and countless other functions.

Biodiversity provides so many essential functions for human life that these services have been valued at \$33 trillion a year (yes, that's trillion with a "t"). (In case you're wondering, researchers manage to put dollar values on functions that the earth performs naturally, like rainfall, oxygen production, nutrient cycles, soil formation, and pollination, to name a few.)

Underlying the world's biodiversity is *genetic variation*. When you look around at the people you know, you see enormous variation in height, hair and eye color, skin tone, body shape, you name it. That phenotypic (physical) variation implies that each person differs genetically, too. Likewise, the individuals in all populations of other sexually reproducing organisms vary in phenotype and genotype as well. Scientists describe the genetic variation in *populations* (defined as groups of interbreeding organisms that exist together in both time and space) in two ways:

- ✓ **Allele frequencies:** How often do various alleles (alternate versions of a particular section of DNA) show up in a population?
- ✓ **Genotype frequencies:** What proportion of a population has a certain genotype?

Allele frequencies and genotype frequencies are both ways of measuring the contents of the gene pool. The *gene pool* refers to all the possible alleles of all the various genes that, collectively, all the individuals of any particular organism have. Genes get passed around in the form of alleles that are carried from parent to child as the result of sexual reproduction. (Of course, there are other ways to pass genes around without sex — viruses leave their genes all over the place. Take a look at Chapter 14 for one way in which viruses leave their genetic legacies.)

Allele frequencies

Alleles are various versions of a particular section of DNA (like alleles for eye color; flip to Chapter 3 for a review of terms used in genetics). Most genes have many different alleles. Geneticists use DNA sequencing (which I explain in Chapter 11) to examine genes and determine how many alleles may exist. To count alleles, they examine the DNA of many different individuals and look for

differences among base pairs — the A's, G's, T's, and C's — that comprise DNA. For the purposes of population genetics, scientists also look for individual differences in junk DNA (DNA that doesn't code for phenotype; see Chapter 18 for more about how these junk DNA is used to provide DNA fingerprints).

What's a species? And why does it matter?

Probably since the dawn of time (or at least the dawn of humankind, anyhow), humans have been classifying and naming the creatures around them. The formalized species naming system, what scientists call *taxonomic classification*, has long relied on physical differences and similarities between organisms as a means of sorting things out. For example, elephants from Asia and elephants from Africa are obviously both elephants, but they're so different in their physical characteristics, among other things, that they're considered separate species. Over the past 50 years or so, the way in which species are classified has changed as scientists have gained more genetic information about various organisms.

One way of classifying species is the *biological species concept*, which bases its classification on reproductive compatibility. Organisms that can successfully reproduce together are considered to be of the same species, and those that can't reproduce together are a different species. This definition leaves a lot to be desired because many closely related organisms can interbreed yet are clearly different enough to be separate species.

Another method of classification, one that works a bit better, says that species are groups of organisms that maintain unique identities — genetically, physically, and geographically — over time and space. A good example of this definition of species is dogs and wolves. Both dogs and wolves are in the same pigeonhole, so to speak — they're both in the genus, *Canis*. (Sharing a genus name tells you that organisms are quite similar and very closely related.) But their species names are different. Dogs are always *Canis familiaris*, but there are many

species of wolves, all beginning with *Canis* but ending with a variety of species names to accurately describe how different they are from each other (such as gray wolves, *Canis lupus*, and red wolves, *Canis rufus*). Genetically, dogs and wolves are very distinct, but they aren't so different that they can't interbreed. Dogs and wolves occasionally mate and produce offspring, but left to their own devices, they don't interbreed. So, if organisms sort themselves out naturally, why do species definitions matter?

In part, how humans classify other organisms influences a species' survival — laws to protect biodiversity usually depend on defining biodiversity one organism at a time, usually by species. As human populations grow, we create a wave of species extinctions that rivals the events that killed off the dinosaurs. (*Extinction* means the permanent and complete loss of a species.) Scientists can't finish discovering all the world's species fast enough to understand what's being lost. That's bad because a species that's essential to our own survival may disappear before its value is recognized and protected. Knowing what's what and the role each organism plays in the world is important to human well-being. Humans depend on a vast, interconnected network of organisms other than ourselves. For example, all plants take in carbon dioxide and convert it to oxygen. Trees pull water from the ground and return it to the atmosphere where it can fall again, as rain (some species of trees are better at this than others). Insects and microorganisms, such as bacteria and fungi, interact with plants and animals in ways that provide food for other organisms, including humans.



To see an example of the alleles listed for one particular gene in humans, visit the Online Mendelian Inheritance in Man Web site, www.ncbi.nlm.nih.gov/entrez/query.fcgi?db=OMIM, and type in the keyword “hemoglobin.” The first entry, beta-hemoglobin (that is, “+141900”), provides an exhaustive list of “allelic variants,” all the different forms — that is, alleles — of the beta-hemoglobin gene that have been described.

Some alleles are very common, and others are rare. To identify and describe patterns of commonness and rarity, population geneticists calculate allele frequencies. What geneticists want to know is what proportion of a population has a particular allele. This information can be vitally important for human health. For example, geneticists have discovered that some people carry an allele that makes them immune to HIV infection, the virus that causes AIDS. Check out the sidebar “Plagues affect population genetics” for more details.

CASE STUDY



Plagues affect population genetics

Around 900 years ago, a new immigrant arrived in Europe. This traveler, a highly infectious disease called the Black Plague, swept through the human population with deadly efficiency. Estimates suggest that up to one-third of the population of western Europe died of the disease. Stories of whole villages succumbing to the disease continue to this day. It seems that the Black Plague was likely caused by a virus — a filovirus similar to the one that causes Ebola, another deadly infectious disease that lurks in Africa — and not the bacterium that scientists have blamed for over a 100 years. Regardless of its cause, the Black Plague may have left behind an interesting legacy: immunity to the virus that causes AIDS.

Among people of European descent are individuals carrying unusual alleles of the gene producing CCR-5 — a component of a soldier of your immune system called a *macrophage*. Macrophages eat invading viruses and bacteria to protect you from infection. Normally, when exposed to the AIDS virus, the CCR-5-producing macrophage gets hijacked by the virus and used against the host to propagate infection. But that’s not what happens in people carrying a mutated

version of the CCR-5 gene; these hardier versions of CCR-5 shrug off the virus and devour it. Thus, people homozygous for the mutation are immune to AIDS. (Heterozygotes have limited protection from the disease, and people without a copy of the unmutated allele have no protection from the disease.)

A group of scientists examined fossilized human bones to determine when and where the protective mutation may have come from. Ancient DNA found in bones recovered in Denmark indicates that people living there 4,500 years ago already had the mutation that makes CCR-5-producing macrophages resist HIV. When the Black Death swept through Europe much later, people lacking the mutated CCR5 gene died, making the allele more common. How common is the protective allele today? It depends on where your ancestors lived. People in Sweden have the highest allele frequency (13 percent of people examined carried one or two copies). Roughly 11 percent of people from eastern European countries like Poland, along with British, Irish, and Australian descendants, had the allele. Of western Europeans surveyed, Italians had the lowest allele frequency (5 percent).

An allele's frequency — how often the allele shows up in a population — is pretty easy to calculate: Simply divide the number of copies of a particular allele by the number of copies of all the alleles represented in the population for that particular gene.



If you know the number of homozygotes (individuals having two identical copies of a particular allele) and heterozygotes (individuals having two different alleles of a gene), you can set the problem up using these two equations: $p + q = 1$ or $q = 1 - p$. In a two-allele system, a lowercase letter p is usually used to represent one allele frequency, and q is used for the other. Always, $p + q$ must equal 1 (or 100 percent). For example, say you want to know the frequency for the dominant allele (R) for round peas in a population of plants like the ones Mendel studied (see Chapter 3 for all the details about Mendel's experiments). You know that there are 60 RR plants, 50 Rr plants, and 20 rr plants. To determine the allele frequency for R (referred to as p), you multiply the number of RR plants by two (because each plant has two R alleles) and add that value to the number of Rr plants: $60 \times 2 = 120 + 50 = 170$. Divide the sum, 170, by two times the total plants in the population (because each plant as two alleles), or $2(60 + 50 + 20) = 260$. The result is 0.55, meaning that 55 percent of the population of peas have the allele R. To get the frequency of r (that is, q), simply subtract 0.55 from 1.



The situation gets pretty complicated, mathematically speaking, when several alleles are present, but the take-home message of allele frequency is still the same: All allele frequencies are the proportion of the population carrying at least one copy of the allele. And all the allele frequencies in a given population must add to one (which can be expressed as 100 percent, if you prefer).

Genotype frequencies

Most organisms have two copies of every gene (that is, they're *diploid*). Because the two copies don't necessarily have to be identical, individuals can be either heterozygous or homozygous for any given gene. Like alleles, genotypes can vary in frequency. Genotypic frequencies tell you what proportion of individuals in a population are homozygous and, by extension, what proportion are heterozygous. Depending on how many alleles are present in a population, many different genotypes can exist. Regardless, the sum total of all the genotype frequencies for a particular locus (location on a particular chromosome; see Chapter 2 for details) must equal 1 (or 100 percent if you work in percentage instead of proportion).

To calculate a genotypic frequency, you need to know the total number of individuals who have a particular genotype. For example, suppose you're dealing with a population of 100 individuals; 25 individuals are homozygous

recessive (zz), and 30 are heterozygous (Zz). The frequency of the three genotypes (assuming there are only two alleles, Z and z) is shown in the following, where the total population is represented by N .

$$\text{Frequency of } AA = \frac{\text{Number of } AA \text{ individuals}}{N}$$

$$\text{Frequency of } Aa = \frac{\text{Number of } Aa \text{ individuals}}{N}$$

$$\text{Frequency of } aa = \frac{\text{Number of } aa \text{ individuals}}{N}$$



Allele frequency and genotype frequency are very closely related concepts because genotypes are derived from combinations of alleles. It's easy to see from Mendelian inheritance (see Chapter 3) and pedigree analysis (see Chapter 12) that if an allele is very common, homozygosity is going to be high. It turns out that the relationship between allele frequency and homozygosity is quite predictable. Most of the time, you can use allele frequencies to estimate genotypic frequencies using a genetic relationship called the Hardy-Weinberg law of population genetics.

Breaking Down the Hardy-Weinberg Law of Population Genetics



Godfrey Hardy and Wilhelm Weinberg never met, yet their names are forever linked in the annals of genetics. In 1908, both men, completely independent of each other, came up with the equation that describes how genotypic frequencies are related to allele frequencies. Their set of simple and elegant equations accurately describes the genetics of populations for most organisms. What Hardy and Weinberg realized was that in a two-allele system, all things being equal, homozygosity and heterozygosity balance out. Figure 17-1 shows how the Hardy-Weinberg equilibrium, as this genetic balancing act is known, looks in a graph.

Relating alleles to genotypes



An *equilibrium* occurs when something is in a state of balance. Genetically, an equilibrium means that certain values remain unchanged over the course of time. The Hardy-Weinberg principle says that allele and genotype frequencies will remain unchanged, generation after generation, as long as certain conditions are met. In order for a population's genetics to follow Hardy-Weinberg's relationships:

- ✔ **The organism must reproduce sexually and be diploid.** Sex provides the opportunity to achieve different combinations of alleles, and the whole affair (pardon the pun) depends on having alleles in pairs (but many alleles can be used; you're not limited to two at a time).
- ✔ **The allele frequencies must be the same in both sexes.** If alleles depend entirely on maleness or femaleness, the relationships don't fall into place because not all offspring have an equal chance to inherit the alleles — alleles on the Y-chromosome (see Chapter 5) violate Hardy-Weinberg rules.
- ✔ **The loci must segregate independently.** Independent segregation of loci is the heart of Mendelian genetics, and Hardy-Weinberg is directly derived from Mendel's laws.
- ✔ **Mating must be random with respect to genotype.** Matings between individuals have to be random, meaning that organisms don't sort themselves out based on the genotype being examined.

Figure 17-1:
The Hardy-Weinberg graph describes the relationship between allele and genotype frequencies.

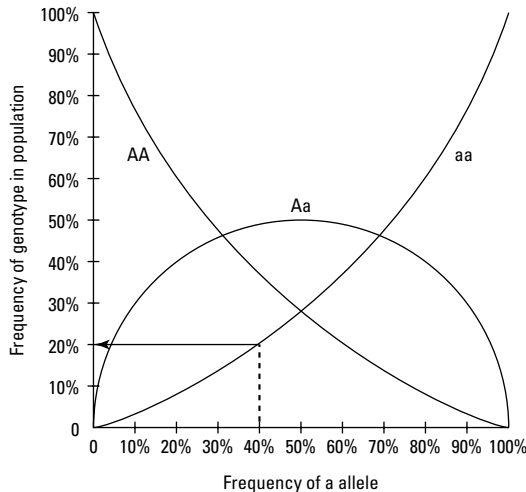

Hardy-Weinberg makes other assumptions about the populations it describes, but the relationship is pretty tolerant of violations of those expectations. Not so with the four listed above. When one of the four major assumptions of Hardy-Weinberg isn't met, the relationship between allele frequency and genotype frequency usually starts to fall apart.

The Hardy-Weinberg equilibrium relationship is often illustrated graphically (Figure 17-1 shows you what the relationships between allele and genotype frequencies look like). The Hardy-Weinberg graph is fairly easy to interpret. On the left side of the graph (Figure 17-1) is the genotypic frequency (as a percentage of the total population going from 0 at the bottom to 100 percent at the top). Across the bottom of the graph is the frequency of the recessive

allele, a (going 0 to 100 percent, left to right). To find the relationship between genotype frequency and allele frequency according to Hardy-Weinberg, just follow a straight line up from the bottom and then read the value off the left side of the graph. For example, if you want to know what proportion of the population is homozygous aa when the allele frequency of a is 40 percent, start at the 40 percent mark along the bottom of the graph and follow a path straight up (shown in Figure 17-1 with a dashed line) until you get to the line marked aa (which describes the genotype frequency for aa). Take a horizontal path (indicated by the arrow) to the left and read the genotypic frequency. In this example, 20 percent of the population is expected to be aa when 40 percent of the population carries the a allele.

It makes sense that when the allele a is very rare, homozygotes aa are rare, too. As allele a becomes more common, the frequency of homozygotes slowly increases. The frequency of the homozygous dominant genotype, AA , behaves the same way but as a mirror image of aa (the genotype frequency for aa) because of the relationship of the alleles A to a in terms of their own frequency: $p + q$ must equal 1. If p is large, q must be small and visa versa.

Check out the humped line in the middle of Figure 17-1. This is the frequency of heterozygotes, Aa . The highest proportion of the population that can be heterozygous is 50 percent. You may guess that's the case just by playing around with monohybrid crosses like those described in Chapter 3. No matter what combination of matings you try (AA with aa , Aa with Aa , Aa with aa , and so on), the largest proportion of Aa offspring you can ever get is 50 percent. Thus, when 50 percent of the population is heterozygous, the Hardy-Weinberg equilibrium predicts that 25 percent of the population will be homozygous for the A allele, and 25 percent will be homozygous for the a allele. This situation occurs only when p is equal to q — in other words, p equals q equals 50 percent.



The relationship between allele frequencies and genotype frequencies is described by the equation $p^2 + 2pq + q^2$. Thus, the line marked aa in Figure 17-1 is described by the equation p^2 . $2pq$ describes the frequency of heterozygotes (Aa), and q^2 describes the frequency of AA in the population.

Many loci obey the rules of the Hardy-Weinberg law in spite of the fact that the assumptions required for the relationship aren't met. One of the major assumptions that's often violated amongst humans is random mating. People tend to marry each other based on their similarities, such as religious background, skin color, and ethnic characteristics. For example, people of similar socioeconomic background tend to marry each other more often than chance would predict. Nevertheless, many human genes are still in Hardy-Weinberg equilibrium. That's because matings may be dependent on some characteristics but are still independent with respect to the genes. The gene that confers immunity to HIV (featured in the sidebar "Plagues affect population genetics") is a good example of a locus in humans that obeys the Hardy-Weinberg law despite the fact that its frequency was shaped by a deadly disease.

Violating the law

There are several ways that populations can wind up out of Hardy-Weinberg equilibrium. One of the most common departures from Hardy-Weinberg occurs as a result of *inbreeding*. Put simply, inbreeding happens when closely related individuals mate and produce offspring. Purebred dog owners are often faced with this problem because certain male dogs sire many puppies, and a generation or two later, descendants of the same male are mated to each other. (In fact, selective inbreeding is what created the various dog breeds to begin with.)

Inbreeding tends to foul up Hardy-Weinberg because some alleles start to show up more and more often than others. In addition, homozygotes get more common, meaning fewer and fewer heterozygotes are produced. Ultimately, the appearance of recessive phenotypes becomes more likely. For example, the appearance of hereditary problems in some breeds of animals, such as deafness among Dalmatian dogs, is a result of generations of inbreeding.

CASE STUDY



Genetics and the modern ark

As human populations grow and expand, natural populations of plants and animals start getting squeezed out of the picture. One of the greatest challenges of modern biology is figuring out a way to secure the fate of worldwide biodiversity. Preserving biodiversity often takes two routes: establishment of protected areas and captive breeding.

Protected areas such as parks set aside areas of land or sea to protect all the creatures (animals and plants) that reside within its borders. Some of the finest examples of such efforts are found among America's national parks. But although protecting special areas helps preserve biodiversity, these islands of biodiversity also allow populations to become isolated. With isolation, smaller populations start to inbreed, resulting in genetic disease and vulnerability to extinction. Sometimes, it's necessary for conservation geneticists to step in and lend a hand to rescue these isolation populations from genetic peril. For example, greater prairie chickens were common in the Midwest at one time. By 1990, their populations were tiny and isolated. Isolation contributed to inbreeding, causing their eggs to fail

to hatch. In order to help rebuild a healthy population, biologists brought in more birds from populations elsewhere to increase genetic diversity. The strategy worked — the prairie chickens' eggs now hatch with healthy chicks that are hoped to bring the population back from the brink of extinction.

Captive breeding efforts by zoos, wildlife parks, and botanical gardens are also credited with preserving species. Twenty-five animal species that are completely extinct in the wild still survive in zoos thanks to captive breeding programs. Most programs are designed to provide not only insurance against extinction but also breeding stock for eventual reintroduction into the wild. Unfortunately, zoo populations often descend from very small founder populations, causing considerable problems with inbreeding. Inbreeding leads to fertility problems and the death of offspring shortly after birth. In the last 20 years, zoos and similar facilities have worked to combat inbreeding by keeping track of pedigrees (like the ones that appear in Chapter 12) and swapping animals around to minimize sexual contact between related animals.

The high incidence of particular genetic disorders among certain groups of people, such as Amish communities (see Chapter 12), is also a result of inbreeding. Even if people in a group aren't all that closely related any more, if a small number of people started the group, everyone in the group is related somehow. (Relatedness shows up genetically even within large human populations; take a look at the section "Mapping the Gene Pool" in this chapter to find out how.)



Loss of heterozygosity is thought to signal a population in peril. Populations with low levels of heterozygosity are more vulnerable to disease and stress, and that vulnerability increases the probability of extinction. Much of what's known about loss of heterozygosity and resulting problems with health of individuals — a situation ironically called *inbreeding depression* — comes from observations of captive animals, like those in zoos. Many animals in zoos are descended from captive populations, populations that had very few founders to begin with. For example, all captive snow leopards are reportedly descended from a mere seven animals.

Not just captive animals are at risk. As habitats for animals become more and more altered by human activity, natural populations get chopped up, isolated, and dwindle in size. Conservation geneticists, like yours truly, work to understand how human activities affect natural populations of birds and animals. Take a look at the sidebar "Genetics and the modern ark" for more about how zoos and conservation geneticists work to protect animals from inbreeding depression and rescue species from extinction.

Mapping the Gene Pool

When the exchange of alleles, or *gene flow* (see Figure 17-2), between groups is limited, populations take on unique genetic signatures. In general, unique alleles are created through mutations (see Chapter 13). If groups of organisms are geographically separated and rarely exchange mates (like the population on the left in Figure 17-2), mutant alleles become common within populations. What this amounts to is that some alleles are found in only certain groups, giving each group a unique genetic identity. (After some time, these alleles usually conform to a Hardy-Weinberg equilibrium within each population; see the section "Breaking Down the Hardy-Weinberg Law of Population Genetics" for details.) Geneticists identify genetic signatures of unique alleles by looking for distinct patterns within genes and certain sections of junk DNA (see Chapter 18 for how junk DNA conceals genetic information).



Mutant alleles that show up outside the population they're usually associated with suggest that one or more individuals have moved or dispersed between populations. Geneticists use these genetic hints to trace the movements of animals, plants, and even people around the world. In the sections that follow, I cover some of the latest efforts to do just that.

Figure 17-2:
Genes travel
when
individuals
of a species
move from
one
population
to another.

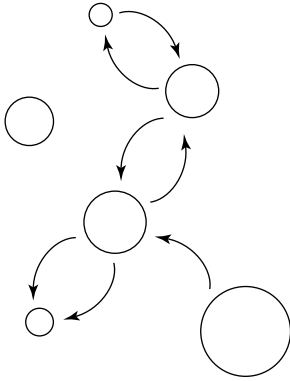

One big happy family

With the contributions of the Human Genome Project (covered in Chapter 11), human population geneticists have a treasure trove of information to sift through. Using new technologies, researchers are learning more than ever before about what makes various human populations distinct. One such effort is the HapMap Project. Hap stands for *haplotype*, which is another way of saying an inventory of human alleles. The alleles being studied for the HapMap aren't necessarily alleles from specific genes; many are alleles within the junk DNA. The HapMap takes advantage of single base pair changes, called SNPs (see Chapter 18), in the DNA; SNPs are the results of thousands of substitution mutations. Most of these tiny changes have no effect on phenotype, but collectively they vary enough from one population to another to allow geneticists to discern each population's genetic signature.

After geneticists understand how much diversity exists among haplotypes, they work to create genetic maps that relate SNP alleles to geographic locations. Essentially, all humans tend to divide up genetically into the three continents of Africa, Asia, and Europe. This isn't too surprising — humans have been in North and South America for only 10,000 years or so. When the genetic uniqueness of the Old World's people was described, geneticists examined populations in North America and other immigrant populations to see if genetics could predict where people came from. For example, genetic analyses of a group of immigrants in Los Angeles accurately determined which continent these people originally lived on. Some geneticists believe that the genetic maps can be even more specific and may point people to countries, and maybe even cities, where their ancestors once lived. The ultimate goal of the HapMap Project is to link haplotypes to populations along with information about the environment, family histories, and medical conditions to development tailor-made treatments for diseases.

Because humans love to travel, geneticists have also compared rates of movements between men and women. Common wisdom suggests that, historically, men tended to move around more than women did (think Christopher Columbus or Leif Ericson). However, DNA evidence suggests that the men aren't as prone to wander as previously believed. Geneticists compared mitochondrial (passed from mother to child) with Y-chromosome DNA (passed from father to son). It seems that women have migrated from one continent to another eight times more frequently than males. The tradition of women leaving their own families to join their husbands may have contributed to the pattern, but another possible explanation exists: A pattern of *polygyny*, men fathering children by more than one woman. So, back to that bit about men wandering. . . .



For additional information on population genetics and a number of interactive applications, visit www.bbc.co.uk/science/genes/dna_detectives/index.shtml. This Web site, sponsored by the BBC (British Broadcasting Corporation), is a gateway to learning about how DNA can be used to trace people's ancestry. The site tells the story of the award-winning documentary "Motherland: A Genetic Journey." The study profiled in the documentary allowed British citizens of African ancestry to learn about their family histories — even to track down and meet relatives still living on the African continent! Individual case studies are featured on the site along with explanations about how the process of linking people with their distant relatives works.

Uncovering the secret social lives of animals

Gene flow can have an enormous impact on threatened and endangered species. For example, scientists in Scandinavia were studying an isolated population of gray wolves not long ago. Genetically, the population was very inbred; all the animals descended from the same pair of wolves. Heterozygosity was low and, as a consequence, so were birth rates. When the population suddenly started to grow, the scientists were shocked. Apparently, a male wolf migrated over 500 miles to join the pack and father wolf pups. Just one animal brought enough new genes to rescue the population from extinction.

Mating patterns of animals often provide biologists with surprises. Because humans like to form monogamous pairs, scientists have compared birds to humankind by pointing to our apparently similar mating habits. As it turns out, birds aren't so monogamous after all. In most species of perching birds (the group that includes pigeons and sparrows, to name two widespread types), 20 percent of all offspring are fathered by some male other than the one with whom the female spends all her time. By spreading paternity among several males, a female bird makes sure that her offspring are genetically diverse. And genetic diversity is incredibly important to help fend off stress and disease.

Genetics reveals that some birds are really frisky. For example, Fairy Wrens, tiny, brilliant blue songbirds, live in Australia in big groups; one female is attended by several males who help her raise her young. But none of the males attending the nest actually father any of the kids — female Fairy Wrens slip off to mate with males in distant territories. Other birds form family groups. Florida scrub jays, beautiful aquamarine natives of central Florida, stay home and help mom and dad raise younger brothers and sisters. Eventually, older kids inherit their parents' territory. Another Australian species, White-winged Choughs, put a whole different twist on gathering a labor force for raising their kids. Chough families (pronounced chuff) kidnap their neighbors' kids and put them to work raising offspring.

It turns out that humans aren't the only ones who live in close association with their parents, brothers, or sisters for their entire lives. Some species of whales live in groups called *Pods*. Every pod represents one family: moms, sisters, brothers, aunts, and cousins, but not dads. Different pods meet up to find mates — as in the son/brother of one pod may mate with the daughter/sister of another pod. Males father offspring in different pods but stay with their own families for their entire lives. Sadly, geneticists learned about whale family structures and mating habits by taking meat from whales that had been killed by people. Like so many of the world's creatures, whales are killed by hunters. Hopefully, though, the information that scientists gather when whales are harvested will contribute to their conservation, allowing the planet's amazing biodiversity to persist for generations to come.

Chapter 18

Forensic Genetics: Solving Mysteries Using DNA

In This Chapter

- ▶ Generating DNA fingerprints
 - ▶ Matching criminals to crimes
 - ▶ Identifying persons using DNA from family members
-

Forensics pops up in every cop drama and murder mystery on television these days, but what is forensics used for in the real world? Generally, *forensics* is thought of as the science used to capture and convict criminals; it includes everything from determining the source of carpet fibers and hairs to paternity testing. Technically, forensics is the application of scientific methods for legal purposes. Thus, *forensic genetics* is the exploration of DNA evidence — who is it, who did it, and who's your daddy.

Just as each person has his or her own unique fingerprint, each and every human (with the exception of identical twins) is genetically unique. *DNA fingerprinting*, also known as *DNA profiling*, is the process of uncovering the patterns within DNA. DNA fingerprinting is at the heart of forensic genetics and is often used to

- ✔ Confirm that a person was present at a particular location
- ✔ Determine identity (including gender)
- ✔ Assign paternity

In this chapter, you go inside the DNA lab to discover how scientists solve forensic mysteries by identifying individuals and family relationships using genetics.



The knowledge that each and every human's fingerprints are unique is probably as old as humanity itself. But Edward Henry was the first police officer to apply the patterns of loops, arches, and whorls from people's fingertips to identify individual people and match criminal to crime way back in 1899.

Rooting through Your Junk (DNA, That Is) to Find Your Identity

It's obvious just from looking at the people around you that each one of us is unique. But getting at the genotype (genetic traits) behind the phenotype (physical traits) is tricky business because almost all your DNA is exactly like every other human's DNA. Much of what your DNA does is provide the information to run all your body functions. Most of those functions, like making your heart beat and exchanging oxygen with carbon dioxide in your cells, are exactly the same from one human to another. If you were to compare your roughly 3 billion base pairs of DNA (see Chapter 6 for how DNA is put together) with your next-door neighbor's DNA, you'd find that 99.999 percent of your DNA is exactly the same.

So what makes you look so different from the guy next door, or even from your mom and dad? Your genetic uniqueness is the result of sexual reproduction. (For more on how sexual reproduction works to make you unique, turn to Chapter 2.) Until the human genome was sequenced (see Chapter 11), the tiny differences produced by recombination and meiosis that make you genetically unique were very hard to isolate. But in 1985, a team of scientists in Britain figured out how to profile a tiny bit of DNA uniqueness into a DNA fingerprint. Surprisingly, DNA fingerprinting doesn't use the information contained in your genes that make you look unique. Instead, the process takes advantage of part of the genome that doesn't seem to do anything at all: junk DNA.



Less than 2 percent of the human genome codes for actual physical traits, meaning all your body parts and the ways they function (see Chapter 11). That's pretty astounding considering that your genome is so huge — So what's all that extra DNA doing in there? Scientists are still trying to figure that part out, but what they do know is that some junk DNA is very useful for identifying individual people.

Even within junk DNA, one human looks much like another. But there are short stretches of junk DNA that vary a lot from person to person. *Short tandem repeats* (STRs) are sections of DNA arranged in back-to-back repetition (a simple sequence is repeated several times in a row). A naturally occurring junk DNA sequence may look something like the example below. (The spaces in these examples allow you to read the sequences more easily. Real DNA doesn't have spaces between the bases.)

TGCT AGTC AAAG TCTT CGGT TCAT

A short STR may look like this:

TCAT TCAT TCAT TCAT TCAT TCAT

The number of repeats found in pairs of STRs varies from one person to another. The variations are referred to as *alleles* (see Chapter 3 to learn more about alleles). Using two chromosome pairs from different suspects, Figure 18-1 shows how the same STRs can have different alleles. Chromosome one has two loci (in reality, this chromosome may have hundreds of loci, but we're only looking at two in this example). For the first suspect, the marker at STR Locus A is the same length on both chromosomes, meaning that Suspect One is homozygous for Locus A (*homozygous* means the two alleles at a particular locus are identical; see Chapter 3). At Locus B, Suspect One has alleles that are different lengths, meaning he's heterozygous at that locus (*heterozygous* means the two alleles differ). Now look at Suspect Two's STR DNA profile. It shows the same two loci, but the patterns are different. At Locus A, Suspect Two is heterozygous and has one allele that's different from Suspect One's. At Locus B, Suspect Two is homozygous for a completely different allele than the ones Suspect One carries.

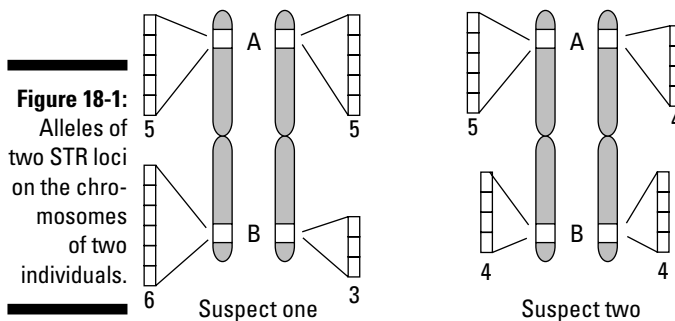

The variation in STR alleles is called *polymorphism* (poly- meaning “many” and morph- meaning “shape or type”). Polymorphism arises from mistakes made during the DNA copying process (called *replication*; see Chapter 7). Normally, DNA is copied mistake-free during replication. But when the enzyme copying the DNA reaches an STR, it often gets confused by all the repeats and winds up leaving out one repeat — like one of the TCATs in the example above — or putting an extra one in by mistake. As a result, the sequences of DNA before and after the STR are exactly the same from one person to the next, but the number of repeats *within* the STR varies. In the case of junk DNA, the mutations in the STRs create lots of variation in how many repeats appear (mutations in other genes can produce harmful and severe consequences; see Chapter 13 for details).

The specific STRs used in forensics are referred to as *loci* or *markers*. Loci is the plural form of *locus*, which is Latin for “place.” (Genes are also referred to as loci; see Chapter 3.) You have hundreds of STR markers on every one of your chromosomes. These loci are named using numbers and letters, such as D5S818 or VWA.



Your STR DNA fingerprint is completely different from everyone else's on earth (except your identical twin, if you have one). The probability of anyone else having identical alleles as you at each and every one of his or her loci is outrageously small.

Lots of other organisms have STR DNA and, in turn, their own DNA fingerprints. Dogs, cats, horses, fish, plants, in fact just about all eukaryotes have lots of STR DNA. (*Eukaryotes* are organisms whose cells have nuclei.) That makes STR DNA fingerprinting an extremely powerful tool to answer all kinds of biological questions. (See Chapter 17 for more about how DNA fingerprinting is used to solve other kinds of biological mysteries.)

Investigating the Scene: Where's the DNA?

When a crime occurs, several things have to happen before the forensic geneticist can get to work to examine the DNA evidence. *Evidence* falls into several different categories:

- ✓ **Trace evidence:** Paint, glass, fibers, hair, soil, plant parts, body fluids, and cosmetics
- ✓ **Fingerprint evidence:** Individually unique patterns left behind when fingers come in contact with surfaces
- ✓ **Impressions:** Most commonly shoe or tire prints
- ✓ **Firearm and tool marks:** Bullet holes, fired bullets, and signs of forced entry
- ✓ **Chemical evidence:** Drugs or poisons
- ✓ **Biological evidence:** Blood, saliva, semen, and hair



The forensic geneticist and crime scene investigator are interested in the biological evidence because cells in biological evidence contain DNA.

Collecting biological evidence

Anything that started out as part of a living thing may provide useful DNA for analysis. In addition to human biological evidence (blood, saliva, semen, and hair), plant parts like seeds, leaves, and pollen as well as hair and blood from pets can help link a suspect and victim. (See the sidebar “Pets and plants play detective for more on how non-human DNA is used to investigate crimes.”)

CASE STUDY



Pets and plants play detective

DNA evidence from almost any source may provide a link between criminal and crime. For example, a particularly brutal murder in Seattle was solved entirely on the basis of DNA provided by the victim's dog. After two people and their dog were shot in their home, two suspects were arrested in the case, and blood-spattered clothing was found in their possession. The only blood on the clothing was of canine origin, and the dog's blood turned out to be the only evidence linking the suspects to the crime scene. Using markers originally designed for canine paternity analysis, investigators generated a DNA fingerprint from the dog's blood and compared it with DNA tests from the bloodstained clothing. A perfect match resulted in a conviction.

If you have a cat or dog, you can testify to the fact that pet hair clings to everything. This annoying pet hair problem provided an important piece of evidence in a murder case in Canada. A woman was reported missing after her car, stained with her blood, was found abandoned. Shortly thereafter, a man's jacket was recovered from a nearby wooded area; the jacket was spattered

with blood and sported white cat hair. The main suspect in the case was the victim's common-law husband. However, at the time of the murder, the suspect was living with his parents and their white cat, Snowball. DNA fingerprinting showed that the blood on the jacket belonged to the murder victim, and the cat hair was a perfect DNA match with Snowball. The result was a conviction for the prosecution.

Even plants have a space in the DNA evidence game. The very first time DNA evidence from plants was used was in an Arizona court case in 1992. A murder victim was found near a desert tree called Paloverde. Seeds from that type of tree were found in the bed of a pickup truck that belonged to a suspect in the case, but the suspect denied ever having been in the area. The seeds found in the truck were matched to the exact tree where the victim was found using DNA fingerprinting. The seeds couldn't prove the suspect's presence, but they provided a link between his truck and the tree where the body was found. The DNA evidence was convincing enough to obtain a conviction in the case.

To properly collect evidence for DNA testing, the investigator must be very, very careful because his or her own DNA can get mixed up with DNA from the scene. Investigators wear gloves, avoid sneezing and coughing, and cover their hair (I'm not kidding — dandruff has DNA, too).

To conduct a thorough investigation, the investigator needs to collect everything at the scene (or from the suspect) that may provide evidence. DNA has been gathered from bones, teeth, hair, urine, feces, chewing gum, cigarette butts, toothbrushes, and even earwax! Blood is the most powerful evidence because even the tiniest drop of blood contains about 80,000 white blood cells, and the nucleus of every white blood cell contains a copy of the donor's entire genome and more than enough information to determine identity using a DNA fingerprint. But even one skin cell has enough DNA to make a fingerprint (see "Outlining the powerful PCR process"). That means that skin cells clinging to a cigarette butt or an envelope flap may provide the evidence needed to place a suspect at the scene.

Decomposing DNA

DNA, like all biological molecules, can decompose; that process is called *degradation*. A particular class of enzymes, called *exonucleases*, whose whole function is to eat DNA carries out degradation of DNA. Exonucleases are practically everywhere: on your skin, on the surfaces you touch, and in bacteria. Any time DNA is exposed to exonuclease attack, its quality rapidly deteriorates because the DNA molecule starts to get broken into smaller and smaller pieces. Degradation is bad news for evidence

because DNA begins to degrade as soon as cells (like skin or blood) are separated from the living organism. To prevent DNA evidence from further degradation after it's collected, it's stored in a sterile (that is, bacteria-free) container and kept dry. As long as the sample isn't exposed to high temperatures, moisture, or strong light, DNA evidence can remain usable for more than 100 years. (Even under all the "wrong" conditions, DNA can sometimes last for centuries; see Chapter 6.)

In order to draw information and conclusions from the DNA evidence, the investigator needs to collect samples from the victim or victims, suspects, and witnesses for comparison. Investigators collect samples from houseplants, pets, or other living things nearby to compare those DNA fingerprints to the DNA evidence. After the investigator gets these samples, it's time to head to the lab.

Moving to the lab

Biological samples contain lots of substances besides DNA. Therefore, when the investigator gets the evidence to the lab, the first thing to do is extract the DNA from the sample. (For a mini-DNA extraction experiment using a strawberry, see Chapter 6.) There are different methods to extract DNA, but they generally follow these three basic steps:

1. Break open the cells to free the DNA from the nucleus (this is called *cell lysis*).
2. Remove the proteins (which make up most of the biological sample) by digesting them with an enzyme.
3. Remove the DNA from the solution by adding alcohol.

After the DNA from the sample is isolated, it's analyzed in a process called *polymerase chain reaction*, or PCR.

Outlining the powerful PCR process

The goal of the PCR process is to make thousands of copies of specific parts of the DNA molecule — in the case of forensic genetics, several target STR loci that will be used to construct a DNA fingerprint. (Copying the entire DNA

molecule would be useless because the uniqueness of each individual person is hidden amongst all that DNA.) Many copies of several target sequences are necessary for two reasons.

- ✓ Current technology used in DNA fingerprinting can't detect the DNA unless large amounts are present, and to get large amounts of DNA, you have to make copies.
- ✓ Matches must be exact when it comes to DNA fingerprinting and forensic genetics; after all, people's lives are on the line. To avoid misidentifications, many STR loci from each sample must be examined.

In the United States, 13 standard markers are used for matching human samples, plus one additional marker that allows determination of gender (that is, whether the sample came from a male or a female). These markers are part of CODIS, the Combined DNA Index System, which is the U.S database of DNA fingerprints.

The PCR process takes advantage of the double-stranded structure of DNA (see Chapter 6) and the natural process of DNA replication (see Chapter 7). (DNA sequencing works much the same way as PCR; see Chapter 11 for the details.)

Here's how PCR works, as shown in Figure 18-2:

1. To replicate DNA using PCR, you have to separate the double-stranded DNA molecule (called the *template*) into single strands. This process is called *denaturing*. When DNA is double-stranded, the bases are protected by the phosphate sugar backbone of the double helix (see Chapter 6). DNA's complementary bases, where all the information is stored, are locked away, so to speak. To pick the lock, get at the code, and build a DNA copy, the double helix must be opened up. The hydrogen bonds that hold the two DNA strands together are very strong, but they can be broken by heating the molecule up to a temperature just short of boiling (212 degrees Fahrenheit). When heated, the two strands slowly come apart as the hydrogen bonds melt. DNA's sugar-phosphate backbone isn't damaged by heat, so the single strands stay together with the bases still in their original order.
2. When denaturing is complete, the mix is cooled slightly. Cooling allows small, complementary pieces of DNA called *primers* to attach themselves to the template DNA. The primers match up with their complements on the template strands in a process called *annealing*. Primers only attach to the template strand when the match is perfect; if no exact match is found, the next step in the PCR process doesn't occur because primers are required to start the copying process (see Chapter 7 for more on why primers are necessary to build strands of DNA from scratch). The primers used in PCR are marked with dyes that glow when exposed to the right wavelength of light (think fluorescent paint under a black light). STRs of similar lengths (even though they may actually be on entirely

different chromosomes, as in Figure 18-1) are labeled with different colors so that when the fingerprint is read, each locus shows up as a different color (see “Constructing the DNA fingerprint” later in this chapter).

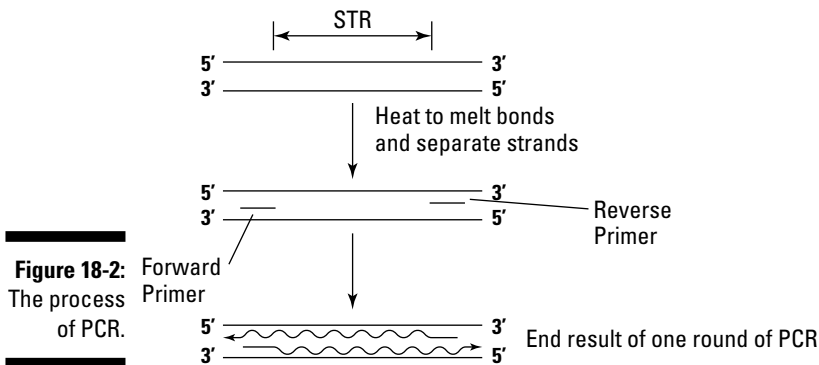

3. After the primers find their matches on the template strands, *Taq polymerase*, begins to do its work. Polymerases act to put things together (see Chapter 7). In this case, the thing getting put together is a DNA molecule.

Taq polymerase starts adding bases — this stage is called *extension* — onto the 3'-ends of the primers by reading the template DNA strand to determine which base belongs next (see Chapter 6 for details on DNA strands' numbered ends). Meanwhile, on the opposite template stand at the end of the reverse primer, *Taq* rapidly adds complementary bases using the template as a guide. (The newly replicated DNA remains double-stranded throughout this process is going on because the mixture isn't hot enough to melt the newly formed hydrogen bonds between the complementary bases.)

One complete round of PCR produces two identical copies of the desired STR. But two copies aren't enough to be detected by the lasers used to read the DNA fingerprints (see “Constructing the DNA fingerprint”). You need hundreds of thousands of copies of each STR. So the PCR process — denaturing, annealing, and extending — repeats over and over.

Figure 18-3 shows you how fast this copying reaction adds up — after 5 cycles, you have 32 copies of the STR. Typically, a PCR reaction is repeated for 30 cycles, so with just one template strand of DNA, you end up with 1,073,741,824 copies of the target STR (the primers and the sequence between them). Usually evidence samples consist of more than one cell, so it's likely that you start with 80,000 or so template strands instead of just one. With 30 rounds of PCR, this would yield . . . I'll wait while you do the math . . . okay, so it's a lot of DNA, as in trillions of copies of the target STR. That's the power of PCR. Even the tiniest drop of blood or a single hair can yield a fingerprint that may free the innocent or convict the guilty.



The invention of PCR revolutionized the study of DNA. Basically, PCR is like a copier for DNA but with one big difference: A photocopier makes facsimiles; PCR makes real DNA. Before PCR came along, scientists needed large amounts of DNA directly from the evidence to make a DNA fingerprint. But DNA evidence is often found and collected in very tiny amounts. Often, the evidence that links a criminal to a crime scene is the DNA contained in a single hair! One of the biggest advantages to PCR is that a very tiny amount of DNA — even one cell's worth! — can be used to generate many exact copies of the STRs used to create a DNA fingerprint (see the section “Rooting through Your Junk (DNA, That Is) to Find Your Identity” earlier in this chapter for a full explanation of STR). Chapter 22 looks at the discovery of PCR in more detail.

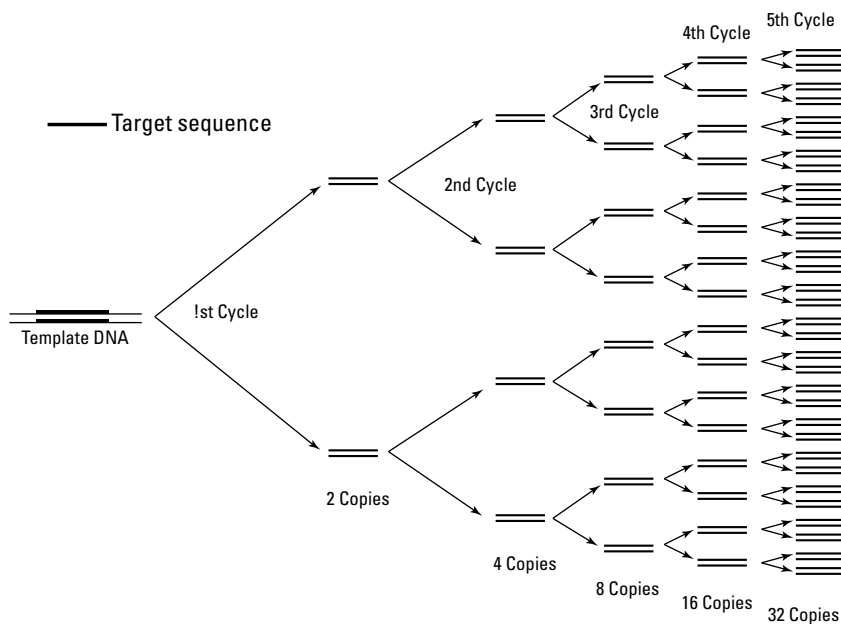

Figure 18-3:
The number
of STR
copies
made by five
cycles of
PCR.

Constructing the DNA fingerprint

For each DNA sample taken as forensic evidence and put through the process of PCR, several loci are examined. (“Several” often means 13 because of the CODIS database; see “Outlining the powerful PCR process” earlier.) This study yields a unique pattern of colors and sizes of STRs — this is the DNA fingerprint of the individual from whom the sample came.

DNA fingerprints are “read” using a process called *electrophoresis*. Electrophoresis takes advantage of the fact that DNA is negatively charged. As I cover in Chapter 11, an electrical current is passed through a jelly-like substance (such as a gel), and the completed PCR is injected into the gel. By electrical attraction, the DNA moves toward the positive pole (electrophoresis). Small STR fragments move faster than larger ones, so the STRs sort themselves according to

size (see Figure 18-4). Because the fragments are tagged with dye, a computer-driven machine with a laser is used to “see” the fragments by their colors. The STR fragments show up as peaks like those shown in Figure 18-4. The results are stored in the computer for later analysis of the resulting pattern.

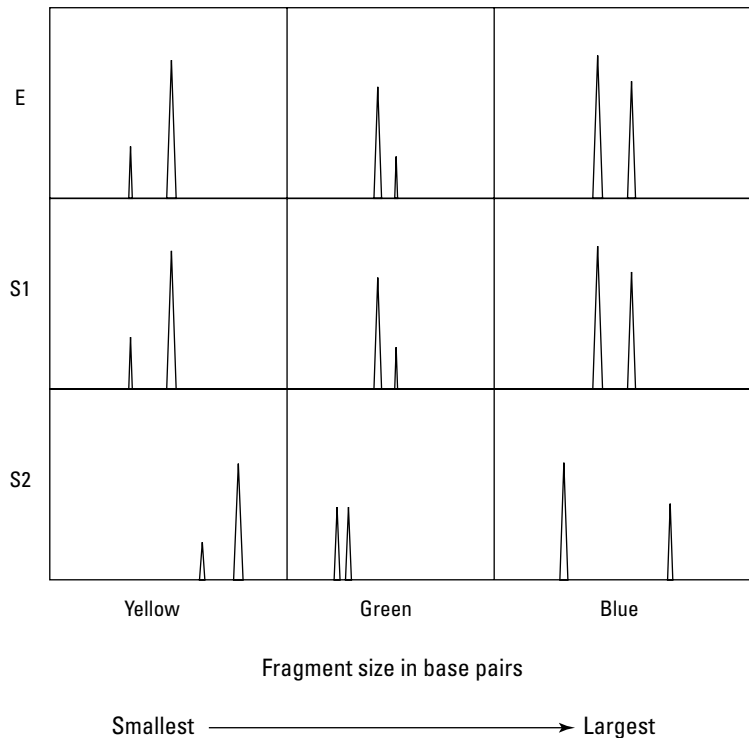

Figure 18-4:
The DNA fingerprints of two suspects are compared with an evidence sample.

The technology used in DNA fingerprinting now allows the entire process, from extracting the DNA to reading the fingerprint, to be done very rapidly. If everything goes right, it takes less than 24 hours to generate one complete DNA fingerprint.



The first cases to use DNA fingerprinting appeared in the courts in 1986. Generally, legal evidence must adhere to what experts call the *Frye* standard. *Frye* is short for *Frye v. United States*, a court case decided in 1923. Put simply, *Frye* says that scientific evidence can only be used when most scientists agree that the methods and theory used to generate the evidence are well established. Following its development, DNA fingerprinting rapidly gained acceptance by the courts, and it's now considered routine. The tests used to generate DNA fingerprints have changed over the years, and STRs are now the gold standard. The U.S. Federal Bureau of Investigation (FBI) converted its entire lab to STR testing in 2000, and other labs followed suit.

Catching Criminals (and Freeing the Innocent)

After the forensic geneticist generates DNA fingerprints from different samples, the next step is to compare the results. When it comes to getting the most information out of the fingerprints, the basic idea is to look for matches between the:

- ✓ Suspect's DNA and DNA on the victim, the victim's clothing or possessions, or the location where the victim was known to have been.
- ✓ Victim's DNA and DNA on the suspect's body, clothing, or other possessions, or a location linked to the suspect.

Matching the evidence to the bad guy

In Figure 18-4, you can see how the DNA fingerprint matching process works. Exact matches stand out like a sore thumb. But when you find a match between a suspect and your evidence, how do you know that no one else shares the same DNA fingerprint as that particular suspect?

With DNA fingerprints, you can't know for sure that a suspect is the culprit you're looking for, but you can calculate the odds of another person having the same pattern. Because this book isn't *Statistical Genetics For Dummies*, I'll skip the details of exactly how to calculate these odds. Instead, I'll just tell you that, in Figure 18-4, the odds of another person having the same pattern as Suspect Two is 1 in 45 for locus one, 1 in 70 for locus two, and 1 in 50 for locus three. To calculate the total odds of a match, you multiply the three probabilities: $\frac{1}{70} \times \frac{1}{45} \times \frac{1}{50} = \frac{1}{157,500}$. Based on your test using just three loci, the probability of another person having the same DNA pattern as Suspect Two is 1 in 157,500.



When all 13 CODIS loci are used, the odds of finding two unrelated persons with the same DNA fingerprints are 1 in 53,000,000,000,000,000 (that's 53 quintillion for those of you scoring at home). To put this figure in perspective, there are only 6 billion people on the entire planet. To say the least, your lifetime odds of getting hit by lightning (1 in 3,000) are a lot better than this!

Of course, real life is a lot more complicated than the example in Figure 18-4. Biological evidence samples are often mixed and contain more than one person's DNA. Because humans are diploid (having chromosomes in pairs; see Chapter 2), mixed samples (called *admixtures* for you *CSI* fans) are easy to spot — they have three or more alleles in a single locus. By comparing samples, forensic geneticists can parse out whose DNA is whose and even determine how much DNA in a sample was contributed by each person.

To find a criminal using DNA

The FBI's CODIS system works because it contains hundreds of thousands of cataloged samples for comparison. All 50 U.S. states require DNA samples to be collected from persons convicted of sex offenses and murder. Laws vary from state to state on what other convictions require DNA sampling, but so far, CODIS has cataloged over 300,000 offender samples with at least that many more awaiting analysis. But what if no sample has been collected from the guilty party? What happens then?

Some law enforcement agencies have conducted mass collection efforts to obtain DNA samples for comparison. The most famous of these collection efforts occurred in Great Britain in the mid-1980s. After two teenaged girls were murdered, every male in the entire neighborhood around the crime scene was asked to donate a sample for comparison. In all, nearly 4,000 men complied with the request to donate their DNA. The actual murderer, a man named Colin Pitchfork (no, I'm not making this

up!), was captured after he bragged about how he had gotten someone else to volunteer a sample for him.

DNA evidence is also sometimes used to extend the *statute of limitations* on crimes when no arrest has been made. The statute of limitations is the amount of time prosecutors have to bring charges against a suspect. For example, a district attorney in the state of Vermont has six years to charge someone with burglary. If no suspect is charged, then the crime "expires," and no suspect can ever be convicted for that particular crime. Crimes involving murder have no statute of limitations, but most states have a statute of limitations on other crimes such as rape. To allow prosecution of such crimes, DNA evidence can be used to file an arrest warrant or make an indictment against "John Doe" — the unknown person possessing the DNA fingerprint of the perpetrator. The arrest warrant extends the statute of limitations indefinitely until a suspect is captured.

But what if the evidence and the suspect's DNA don't match? The good news is that an innocent person is off the hook. The bad news is that the guilty party is still roaming free. At this point, investigators turn back to the CODIS system because it was designed not only to standardize which loci get used in DNA fingerprinting but also to provide a library of DNA fingerprints to help identify criminals and solve crimes. The FBI established the DNA fingerprint database in 1998 based on the fact that repeat offenders commit most crimes. When a person is convicted of a crime (laws vary on what convictions require DNA sampling; see the sidebar "To find a criminal using DNA"), his or her DNA is sampled — often by using a cotton swab to collect a few skin cells from the inside of the mouth. As of September 2004, the CODIS database had provided over 17,000 matches and assisted in over 20,000 investigations. If no match is found in CODIS, the evidence is added to the database. If the perpetrator is ever found, then a match can be made to other crimes he or she may have committed (see the sidebar "To find a criminal using DNA").

Taking a second look at guilty verdicts

Not all persons convicted of crimes are guilty. One study estimates that roughly 7,500 persons are wrongfully convicted each year in the United States alone. The reasons behind wrongful conviction are varied, but the fact remains that innocent persons shouldn't be jailed for crimes they didn't commit.

In 1992, Barry Scheck and Peter Neufeld founded the Innocence Project in an effort to exonerate innocent men and women. The project relies on DNA evidence, and services are free of charge to all who qualify.

Walter D. Smith is one of the 153 persons exonerated by DNA evidence with the aid of the Innocence Project as of December 2004. In 1985, Mr. Smith was wrongfully accused of raping three women. Despite his claims of innocence, eyewitness testimony brought about a conviction, and Mr. Smith received a sentence of 78 to 190 years in prison. During his 11 years of incarceration, Mr. Smith earned a degree in business and conquered drug addiction. In 1996, the Innocence Project conducted DNA testing that ultimately proved his innocence and set him free.

It's unclear how many criminal cases have been subjected to post-conviction DNA testing, and the success rates for such cases are unreported. Surprisingly, many states have opposed post-conviction testing, but laws are being passed to allow or require such testing when circumstances warrant it.

It's All Relative: Finding Family

Family relationships are important in forensic genetics when it comes to paternity for court cases or determining the identities of persons killed in mass disasters. Individuals who are related to one another have copies of their DNA in common because each parent passes on half of his or her chromosomes to each offspring (see Chapter 5). Within a family tree, the amount of genetic relatedness, or *kinship*, among individuals is very predictable. Assuming that mom and dad are unrelated to each other, full siblings have roughly half their DNA in common because they each inherit all their DNA from the same parents.

Paternity testing

Surprisingly (or maybe not, depending upon how many daytime talk shows you watch), roughly 15 percent of children are fathered by someone other than the father listed on the birth certificate. Therefore, tests to determine

what male fathered what child are of considerable interest. Paternity testing is used in divorce and custody cases, determination of rightful inheritance, and a variety of other legal and social situations.

Paternity testing using STR techniques has become very common and relatively (pardon the pun) inexpensive. The methods are exactly the same as those used in evidence testing (see “Outlining the powerful PCR process” earlier). The only difference is the way the matches are interpreted. Because the STR alleles are on chromosomes (see “Rooting through Your junk (DNA, That Is) to Find Your Identity” earlier), a mother contributes half the STR alleles possessed by a child, and the father contributes the other half. Figure 18-5 shows what these contributions may look like in a DNA fingerprint. Alleles are depicted here as peaks, and arrows indicate the maternal alleles. Assuming that mother and father are unrelated, half the child’s alleles came from F2, indicating that F2 is likely the father.

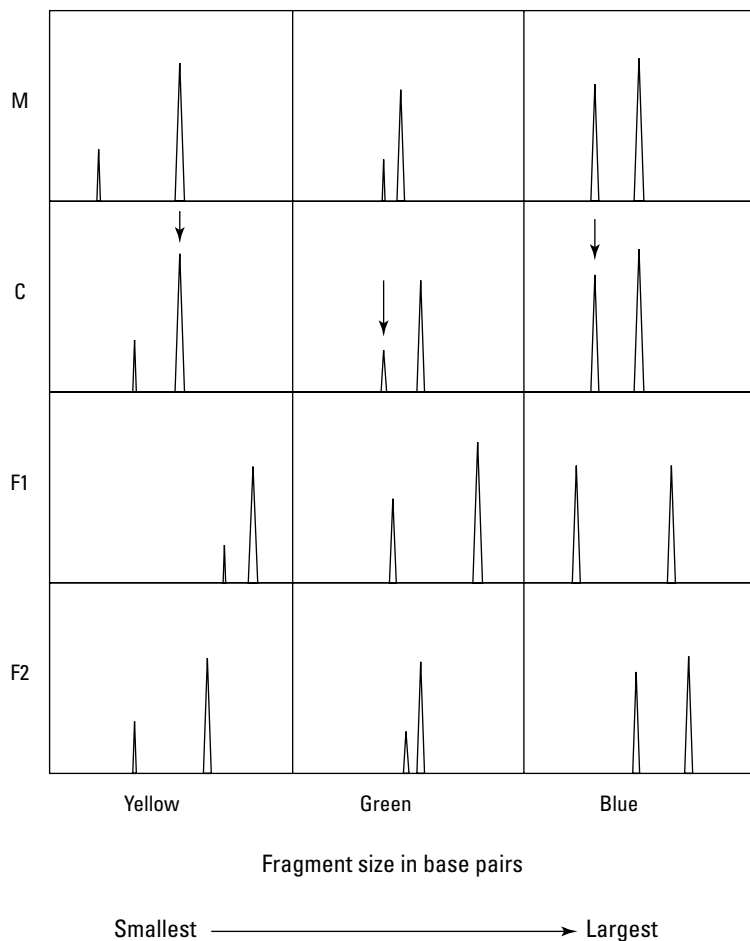

Figure 18-5:
Paternity
testing
using STR
loci.

CASE STUDY



Thomas Jefferson's son

Male children receive their one and only Y-chromosome from their fathers (see Chapter 5). Thus, paternity of male children can be resolved by using DNA markers on the Y-chromosome. The discovery of this testing option led to the unusual resolution of a long-term mystery involving the second president of the United States, Thomas Jefferson.

In 1802, Jefferson was accused of fathering a son by one of his slaves, Sally Hemings. Jefferson's only acknowledged offspring to survive into adulthood were daughters, but Jefferson's paternal uncle has surviving male relatives that are descended in an unbroken male line. Thus, the Y-chromosome DNA from these Jefferson family members was expected to be essentially identical to the Y-chromosome DNA that Jefferson inherited from his paternal grandfather — DNA he would have contributed to a son. Five men known to have descended from Jefferson's uncle agreed to contribute

DNA samples for comparison with the only remaining male descendent of Sally Hemings's youngest son. In all, 19 samples were examined. These samples included descendants of other potential fathers along with unrelated persons for comparison. A total of 19 markers found only on the Y-chromosome were used. (None of the CODIS markers are on the Y-chromosome; they'd be useless for females if they were.) The Jefferson and Hemings descendants matched at all 19 markers. Since the publication of the genetic analysis, historical records were examined to provide additional evidence that Jefferson fathered Sally Hemings's son, Eston. For example, Jefferson was the only male of his family present at the time Eston would have been conceived. Interestingly, examination of the historical records seems to indicate that Jefferson is likely the father of all of Sally Hemings's six children; however, this conclusion remains controversial.

Two values are often reported in paternity tests conducted with DNA fingerprinting:

- ✔ **Paternity index:** A value that indicates the weight of the evidence. The higher the paternity index value, the more likely it is that the alleged father is the actual genetic father. The paternity index is a more accurate estimate than probability of paternity.
- ✔ **Probability of paternity:** The probability that a particular person could have contributed the same pattern shown by the DNA fingerprint. The odds calculations for probability of paternity are more complicated than multiplying simple probabilities (see “Matching the evidence to the bad guy”) because an individual who's heterozygous at a particular locus has an equal probability of contributing either allele. The probability of a particular male being the father also depends on how often the various alleles at a locus show up in the population at large (which is also true for the estimates of odds shown in “Matching the evidence to the bad guy;” see Chapter 17 for the lowdown on how population genetics works).



The results of paternity tests are often expressed in terms of “proof” of paternity or lack thereof. Unfortunately, this terminology is inaccurate. Genetic paternity testing doesn’t *prove* anything. It only indicates a high likelihood that a given interpretation of the data is correct.

Relatedness testing

Paternity analysis isn’t the only time that DNA fingerprinting is used to determine family relationships. Historical investigations (like the Jefferson-Hemings case explained in the sidebar “Thomas Jefferson’s son”) may also use patterns inherited within the DNA to show how closely related people are and to identify remains. Mass fatality incidents such as plane crashes and the World Trade Center disaster of September 11, 2001, rely on DNA technologies to identify deceased persons. Several methods are used under such circumstances, including STR DNA fingerprinting, mitochondrial DNA analysis (see Chapter 6 for the details on mitochondrial DNA), and Y-chromosome analysis (similar to the method described in the sidebar “Thomas Jefferson’s son”).

Several conditions complicate DNA identification of victims of mass fatality incidents. Bodies are often badly mutilated and fragmented, and decomposition damages what DNA remains in the tissues. Furthermore, reference samples of the deceased person’s DNA often don’t exist, making it necessary to make inferences from persons closely related to the deceased.

Reconstructing individual genotypes

Much of what forensic geneticists know about identifying victims of mass fatalities comes from airplane crashes. In 1998, Swissair Flight 111 crashed into the Atlantic Ocean just off the coast of Halifax, Nova Scotia, Canada. This disaster sparked an unusually comprehensive DNA typing effort that now serves as the model for forensic scientists the world over dealing with similar cases.

In all, 1,200 samples from 229 persons were recovered from Swissair Flight 111. Only one body could be identified by appearance alone, so investigators obtained 397 reference samples either from personal items belonging to victims (like toothbrushes) or from family members. Because most reference samples from the victims themselves were lost in the crash, 93 percent of identifications depended on samples from parents, children, and siblings of the deceased. The number of alleles shared by family members is fairly predictable, allowing investigators to conduct parentage analysis based on the expected rate of matching alleles. In the Swissair case, 43 family groups (including six families of both parents and some or all of their children) were among the victims, so the analyses were complicated by kinship among the victims.

The initial DNA fingerprinting of remains revealed 228 unique genotypes (including one pair of twins). The 13 CODIS loci were tested using PCR (the methods were identical to those described in “Catching Criminals (and Freeing the Innocent)” earlier in this chapter). All the data from DNA fingerprinting was entered into a computer program specifically designed to compare large numbers of DNA fingerprints. The program searched for several kinds of matches:

- ✔ A perfect match between a victim and a reference sample from a personal item
- ✔ Matches between victims that would identify family groups (parents and children, and siblings)
- ✔ Matches between samples from living family members

The computer then generated reports for all matches within given samples. Two investigators independently reviewed every report and only declared identifications when the probability of a correct identification was greater than 1 million to 1. Altogether, over 180,000 comparisons were made to determine the identities of the 229 victims.

Forty-seven persons were identified based on matches with personal items. The remaining 182 persons were identified by comparing victims’ genotypes with those of living family members. The power of PCR, combined with many loci and computer software, led to rapid comparisons and the positive identification of all the victims.

Bringing closure in times of tragedy

On September 11, 2001, two jetliners crashed into the twin towers of the World Trade Center (WTC) in New York City. The enormous fires resulting from the crashes caused both buildings to collapse. Roughly 2,700 persons died in the disaster. Over 20,000 body parts were recovered from the rubble; therefore, the task of forensic geneticists was two-fold: determine the identity of each deceased person and collect the remains of particular individuals for interment. Unlike Swissair Flight 111, few victims of the WTC tragedy were related to each other. However, other issues complicated the task of identifying the victims. Many bodies were subjected to extreme heat, and others were recovered weeks after the disaster, as rubble was removed. Thus, many victim samples had very little remaining DNA for analysis.

DNA reference samples from missing persons were collected from personal effects such as toothbrushes, razors, and hairbrushes. Skin cells clinging to toothbrushes account for almost 80 percent of the reference samples obtained for comparison. These samples were DNA fingerprinted using PCR with the standard 13 CODIS loci described in “Catching Criminals (and Freeing the Innocent)” earlier in this chapter. By July 2002, roughly 300 identifications

were made using these direct reference samples. An additional 200 identifications were made by comparing victim samples to samples from living relatives using the methods described for the Swissair crash (see “Reconstructing individual genotypes”).

By July 2004, a total of 1,500 victims had been positively identified, but subsequent progress was slow. The remaining samples were so damaged that the DNA is in very short pieces, too short to support STR analysis. Two avenues for additional identifications remained:

✔ **Mitochondrial DNA (mtDNA)**, which is useful for two reasons:

- It’s multicopy DNA, meaning that each cell has many mitochondria, and each mitochondrion has its own molecule of mtDNA.
- It’s circular, making it somewhat more resistant to decomposition because the nucleases that destroy DNA often start at the end of the molecule (see “Collecting biological evidence” earlier), and a circle has no end, so to speak.

mtDNA is inherited directly from mother to child; therefore, only maternal relatives can provide matching DNA. Unlike STR markers, mtDNA is usually analyzed by comparing the sequences of nucleotides from various samples (see Chapter 11 to find out how DNA sequences are generated and analyzed). Because sequence comparison is more complicated than STR marker comparison, the analyses take longer to perform but provide very accurate matches.

✔ **Single nucleotide polymorphism (SNP analysis)** (pronounced snip), which relies on the fact that DNA tolerates some kinds of mutation without harming the organism (see Chapter 13 for more about mutation). SNPs occur when one base replaces another in what’s called a *point mutation*. Generally, T replaces A and G replaces C or *visa versa* (see Chapter 6 for more about the bases that make up DNA). These tiny changes occur often (some estimates are as high as about one in every 100 bases), and when many SNPs are compared, the changes can create a unique DNA profile similar to a DNA fingerprint.

The downside to SNP analysis is that the point mutations don’t create obvious size differences that can be detected by traditional DNA fingerprinting. Therefore, sequencing or gene chips (see Chapter 23 for more on gene chips) must be used to detect the SNP profile of various individuals. Because SNP analysis can be conducted on very small fragments of DNA, it allowed investigators to make more identifications than were possible otherwise. Even so, many persons were not identified, and identification efforts were halted in February 2005.

Chapter 19

Genetic Makeovers: Fitting New Genes into Plants and Animals

In This Chapter

- ▶ Introducing old genes in new places
 - ▶ Modifying the genes of plants and animals
-

One of the most controversial applications of genetics technology (besides cloning, which I cover in Chapter 20) is the mechanical transfer of genes from one organism to another. This process is popularly known as *genetic modification* (GM). More properly called *transgenics*, transferring genes simplifies the production of some medications, creates herbicide-resistant plants, and has even been used to create glow-in-the-dark pets (I'm not kidding — check out the sidebar “Transgenic pets: Not all fun and games” for the details). In this chapter, you discover how scientists move DNA around to endow plants, animals, bacteria, and insects with new combinations of genes and traits.

Seeing Genetically Modified Organisms Everywhere



News items about genetically modified this, that, and the other crop up practically every day, and most of this news seems to revolve around protests, bans, and lawsuits. Despite all the brouhaha, genetically modified “stuff” is neither rare nor wholly dangerous. In fact, most processed foods that you eat are likely to contain one or more transgenic ingredients.

If that revelation worries you, go to your local health food store and peer at the labels on organic (and some non-organic) foods. (Organic foods are generally defined as those produced without chemicals such as insecticides, herbicides, or artificial ingredients.) You'll see proclamations of “No GMO,” which is meant

to reassure you that no *transgenes* — genes that have been artificially introduced using recombinant DNA methods (described in Chapter 16) — were present in the plants or animals used to make the product in question.

In truth, there's no avoiding genetically modified organisms in your everyday life. Genetic modification by humans, via artificial selection and, on occasion, induced mutation, created every single domesticated plant and animal species on earth. Furthermore, the ability to move genes from one species to another isn't new — viruses and bacteria do it all the time. It's a bit of a mystery as to why transgenesis is less acceptable than induced mutagenesis and artificial selection, but no matter what you call it, it's all genetic modification.



The acronyms GM (genetically modified) and GMO (genetically modified organism) are used all the time, but not in this chapter. Instead, I refer to specifically to *transgenic organisms* because humans have been genetically modifying organisms in a variety of ways for a long time.

Making modifications down on the farm

Humans started domesticating plants and animals many centuries ago (take a look at the sidebar “Amazing maize” for how corn made the transition from grass to gracing your table). Historically, farmers preferentially grew certain types of plants to increase the frequency of desirable traits, such as sweeter grapes and more kernels per stalk of wheat. Many, if not all, of the cereal grains humans depend on, such as wheat, rice, and barley, are the result of selective hybridization events that created polyploids (multiple chromosome sets; see Chapter 15). When plants become polyploid, their fruits get substantially larger. Fruits from polyploids are more commercially valuable (and better tasting, too. Try a wild strawberry if you're not convinced).

When it comes to animals, humans purposefully inbreed various animals to increase the prevalence of traits such as high milk production in cows or retrieving ability (make that obsession) in certain breeds of dogs. (Inbreeding can also cause substantial problems; see Chapters 13 and 17 for details.)

Relying on radiation and chemicals

In addition to domestication and selective breeding, humans have taken another path to genetically modify organisms. For over 70 years, new plant breeds have been created by purposefully induced, albeit random, mutations. In essence, plants are exposed to radiation (such as X-rays, gamma rays, and neutrons) and chemicals to produce mutant alleles aimed at producing

desired traits (see Chapter 13 for how radiation damages DNA to cause mutation). Plants that commonly receive radiation and chemical treatment include:

- ✔ **Food crops:** Fruits, vegetables, and grains are mutated to produce disease resistance and size and flavor variations as well as to change the timing of fruiting. Over 2,000 different types of plants are genetically modified in this fashion. Believe it or not, you eat these varieties all the time. Ever had Rio Red grapefruit? If so, you enjoyed a mutated plant variety that acquired its deep red color from a neutron-induced mutation.
- ✔ **Ornamentals:** Many of the unusual ornamental plants you enjoy are the result of induced mutation. Roses, tulips, and chrysanthemums are all zapped to produce new flower colors.

CASE STUDY



Amazing maize

Plants depend on a variety of helpers to spread their seeds around: The wind, birds, animals, and waterways all carry seeds from one place to another. Most plants get along just fine without humans. Not so with corn. Corn depends *entirely* on humans to spread its seeds; archeological evidence confirms that corn traveled only where humans took it. What's striking about this story is that modern geneticists have pinpointed the mutations that humans took advantage of to create one of the world's most widely used crops.

Primitive corn (called *maize*) put in its first appearance around 9,000 years ago. The predecessor of maize is a grass called *teosinte*. You need a good imagination to see an ear of corn when you look at the seed heads of teosinte; there's only a vague resemblance, and unlike corn, teosinte is only barely edible — it has a few rock hard kernels per stalk. Yet corn and teosinte (going by the scientific name of *Zea mays*) are the same species.

The five mutations that turned teosinte into maize popped up naturally and changed several things about teosinte to make it a more palatable food source:

- ✔ One gene controls where cobs appear on the plant stalk: Maize has its cobs along the entire stem instead of on long branches like teosinte.
- ✔ Three genes control sugar and starch storage in the kernels: Maize is easier to digest and better tasting than teosinte.
- ✔ One gene controls the size and position of kernels on the cob: Unlike teosinte, maize has an appearance normally associated with modern corn.

Humans apparently used teosinte for food before it acquired its mutational makeover, so it's likely that people caught on quickly to the change that developed. The mutations of the five genes mentioned above were cemented into the genome by selective harvest and planting of the new variety. People grew the mutated plants on purpose, and the only reason corn is so common now is because humans made it that way. The first true maize crops were planted in Mexico 6,250 years ago, and, as a popular addition to the diets of people in the area, its cultivation spread rapidly. Archeological sites in the United States bear evidence of maize cultivation as early as 3,200 years ago. By the time Europeans arrived, most native peoples in the New World grew maize to supplement their diets.

Introducing unintentional modifications

Humans mutate plants on purpose, but we also constantly make unintentional genetic modifications on natural populations, such as mosquitoes and bacteria:

- ✓ **Mosquitoes:** Overzealous pesticide use has made most mosquito populations DDT-resistant.
- ✓ **Bacteria:** Many common antibiotics are rapidly being rendered ineffective because susceptible bacteria are wiped out, leaving only resistant strains.

These changes in bacteria and mosquito populations are due to induced changes in allele frequencies (see Chapter 17); essentially, humans set up selective breeding by changing the environment.

Another unintentional modification occurs when transgenes escape from controlled crops to wild plants — which they're likely to do with great frequency and efficiency. The wild plants are then genetically modified. These new, unintentional recipients of biotechnology are no less genetically modified than the crop plants (see the “Escaped transgenes” section later in the chapter).

Putting Old Genes in New Places

If genetic modification is so ubiquitous, what's the problem with transgenic organisms? After all, humans have been at this whole genetic modification thing for centuries, right? Not exactly. Historically, humans have modified organisms by controlling matings between animals and plants with preexisting genetic compatibility.



Transgenics are often endowed with genes from very different species. (The bacterial gene that's been popped into corn to make it resistant to attack by herbivores — plant-eating insects — is a good example.) Therefore, transgenic organisms wind up with genes that never could have moved from one organism to another without considerable help (or massive luck; see the “Traveling genes” sidebar for more about natural gene transfer events).

After these “foreign” genes get into an organism, they don't necessarily stay put. One of the biggest issues with transgenic plants, for example, is uncontrolled gene transfer to other, unintended species. Another controversial aspect of transgenic organisms has to do with gene expression; many people worry that transgenes will be expressed in agricultural products in unwanted or unexpected ways, making foods toxic or carcinogenic.

Traveling genes

In a scenario that mixes equal doses of plagues, conspiracy theory, and bioterrorism, a recent British TV drama called *Fields of Gold* tells a tale of genetic engineering gone dreadfully wrong. The plot involves a farmer who somehow genetically engineers an antibiotic-resistant gene into his wheat crop (I guess he did this in his state-of-the-art lab out in the barn). The fictional transgene jumps ship and winds up in nasty, infectious bacteria, setting off a wave of terror, mayhem, and illness. It doesn't sound like the feel-good hit of the year, does it? For Britons, the program probably seemed more like a documentary given the hysteria in Western Europe over all things bioengineered (see the "Weighing points of contention" section in this chapter). Scientists bashed the show as unrealistic and entirely impossible, but the creators defended their story as plausible (yet fictitious), based on a natural phenomenon called *horizontal gene transfer*.

Movement of genes from one organism to another usually occurs through mitosis or meiosis, the normal mechanisms of inheritance. With horizontal gene transfer, genes can move from one species to another without mating or cell

division. Bacteria and viruses accomplish this task with ease; they can slip their genes into the genomes of their hosts to alter the functions of host genes or supply the hosts with new, sometimes unwanted ones. This movement of genes isn't merely scientific fiction or a rare event, either. The appearance of antibiotic-resistant genes in various species of bacteria is due to horizontal gene transfers. Horizontal transfer also occurs in multicellular organisms (various species of fruit flies have shared their genes this way). One group of researchers has even shown that horizontal gene transfer may occur as a result of *eating* DNA. Yes, you read that correctly. The scientists fed mice a mixture that included DNA sequences not found anywhere in the mouse genome. The scientists found the experimentally introduced DNA circulating in the bloodstreams of their mice, strongly suggesting that horizontal transfer had actually occurred. Indeed, your own genome may owe some of its size and genetic complexity to genes acquired from bacteria. So, although *Fields of Gold* is fictional, the possibility of genes turning up in unexpected places is real.



To understand the promises and pitfalls of transgenics, you first need to know how transgenes are transferred and why. *Recombinant DNA technology* is the set of methods used for all transgenic applications. The process used to find genes, snip them out of their original locations, and pop them into new locations (like the virus vectors used in gene therapy) is covered in Chapter 16. The set of techniques used specifically to create transgenic organisms often goes by the title *genetic engineering*. Genetic engineering refers to the directed manipulation of genes to alter phenotype in a particular way. Thus, genetic engineering is also used in gene therapy to bring in healthy genes to counteract the effects of mutations.

Puttering with Transgenic Plants



Plants are really different from animals, but not in the way you may think. Plant cells are *totipotent*, meaning that practically any plant cell can eventually give rise to every sort of plant tissue: roots, leaves, and seeds. When animal cells differentiate during embryo development, they lose their totipotency forever (but the DNA in every cell retains the potential to be totipotent; see Chapter 20). For genetic engineers, the totipotency of plant cells reveals vast possibilities for genetic manipulation.

Much of the transgenic revolution in plants has focused on moving genes to plants from bacteria, other plants, and even animals, to achieve various ends, including nutritionally enhancing certain foods, such as rice. The strongest efforts are directed at altering crops to resist either herbicides used against unwanted competitor plants or the attack of plant-eating insects.

Following the transgenesis process in plants

In general, developing transgenic plants for commercial uses involves three major steps:

1. Find (or alter) the gene that controls desired traits such as herbicide resistance.
2. Slip the transgene into an appropriate delivery vehicle (a *vector*).
3. Create fully transgenic plants that pass on the new gene along with their seeds.

Pinpointing the right gene

The process of finding and mapping genes is pretty similar from one organism to another (see Chapter 16 for some of the details). After scientists identify the gene they want to transfer, they must alter the gene so that it works properly outside the original organism. All genes must have *promoter sequences*, the genetic landmarks that identify the start of a gene, to allow transcription to occur (for the scoop on transcription, flip to Chapter 8). When it comes to creating a transgenic plant, the promoter sequence in the original organism may not be very useful in the new plant host; as a result, a new promoter sequence is needed to make sure the gene gets turned on when and where it's wanted.

Modifying the gene to reside in its new home

To date, the promoter sequences that genetic engineers use in transgenic plants are set to be always on. Therefore, the transgene's products show up in all the tissues and cell types of the entire plant in which the transgene's inserted. The all-purpose promoter often used for transgenes in plants comes from a pathogen called *cauliflower mosaic virus* (CaMV). CaMV seems to work well just about everywhere it's used and is a reliable on-switch for the transgenes with which it's paired. When more precise regulation is needed, genetic engineers can use promoters that respond to conditions in the environment (see Chapter 10 for more about how cues in the environment can control genes).

In addition to the promoter, genetic engineers must also find a good companion gene — called a *marker gene* — to accompany the transgene. The marker gene provides a strong and reliable signal indicating that the whole unit (marker and transgene) is in place and working. Common markers include genes that convey resistance to antibiotics. With these kinds of markers, geneticists grow transgenic plant cells in medium that contains the antibiotic. Only the plants that have resistance (conveyed by the marker gene) survive, providing a quick and easy way to tell which cells have the transgene (alive) and which don't (dead).

Getting new genes into the plant

Genetic engineers use two main methods to put new genes into plants:

✓ **Use a vector system from a common soil bacterium called *Agrobacterium*.**

Agrobacterium is a plant pathogen that causes *galls*, big, ugly, tumor-like growths, to form on infected plants. In Figure 19-1, you can see what a gall looks like. Gall formation results from integration of bacterial genes directly into the infected plant's chromosomes. The bacteria enters the plant from a wound such as a break in the plant's stem that allows bacteria to get past the woody defense cells that protect the plant from pathogens (just as your skin protects you). The bacterial cells move into the plant cells (scientists aren't sure exactly how they pull off this trick), and once inside, DNA from the bacteria's *plasmids*, circular DNAs that are separate from the bacterial chromosome, integrate into the host plant's DNA. The bacterial DNA pops itself in more or less randomly and then hijacks the plant cell to allow it to replicate.

Like the geneticists using virus vectors for gene therapy (see Chapter 16), genetic engineers snip out gall-forming genes from the *Agrobacterium* plasmids and replace them with transgenes. Host plant cells are grown in the lab and infected with the *Agrobacterium*. Because these cells are totipotent, they can be used to grow an entire plant — roots, leaves, and all — and every cell contains the transgene. When the plant forms seeds, those contain the transgene, too, ensuring that the transgene is passed to the offspring.

- ✔ Shoot plants with a *gene gun* so that microscopic particles of gold or other metals carry the transgene unit into the plant nucleus by brute force.

Gene guns are a bit less dependable than *Agrobacterium* as a method for getting transgenes into plant cells. However, some plants are resistant to *Agrobacterium*, thus making the gene gun a viable alternative. With gene guns, the idea is to coat microscopic pellets with many copies of a transgene and by brute force (provided by compressed air) shove the pellets directly into the cell nuclei. By chance, some of the transgenes are inserted into the plant chromosomes.

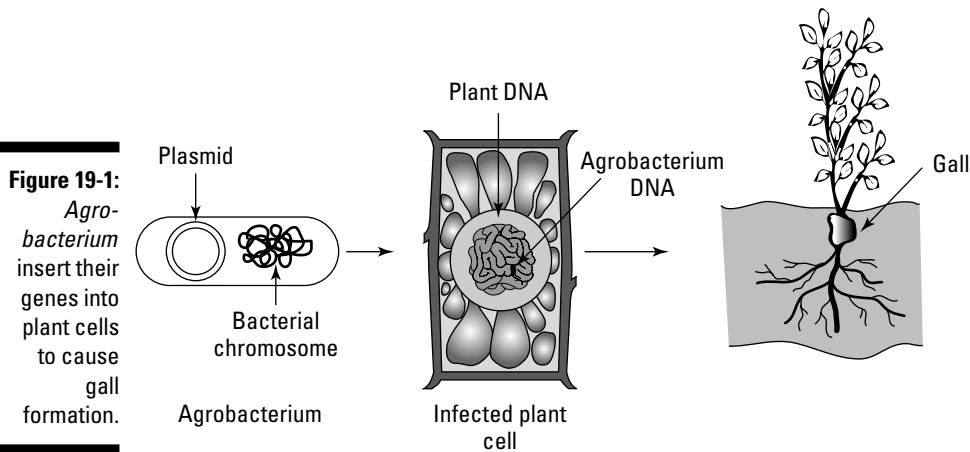

Exploring commercial applications

Transgenic plants have made quite a splash in the world of agriculture. So far, the main applications of this technology have addressed two primary threats to crops:

- ✔ **Weeds:** The addition of herbicide-resistant genes make crop plants immune to the effects of weed-killing chemicals, allowing farmers to spread herbicides over their entire fields without worrying about killing their crops. Weeds compete with crop plants for water and nutrients, reducing yields considerably. Soybeans, cotton, and canola (a seed that produces cooking oil) are only a few of the crop plants that have been genetically altered to tolerate certain herbicides.

A couple of different chemical companies have gotten into the transgenic plant business with the idea of producing crop plants that aren't susceptible to herbicides the company makes. The companies then market their crop plants along with their chemicals.

✓ **Bugs:** The addition of transgenes that confer pest-killing properties to plants effectively reduces crop losses to plant-eating bugs. Geneticists provide pest-protection traits using the genes from *Bacillus thuringiensis* (otherwise known as Bt). Organic gardeners discovered the pesticide qualities of Bt, a soil bacterium, years ago. Bt produces a protein called *Cry*. When an insect eats the soil bacteria, digestion of *Cry* releases a toxin that kills the insect shortly after its meal. Transgenic corn and cotton carry the Bt *Cry* gene; there's a potato version, too, but its cultivation has been discontinued because fast-food restaurants and potato chip makers have refused to purchase the transgenic potatoes.

Weighing points of contention

Few genetic issues have excited the almost hysterical response met by transgenic crop plants. European efforts over the past ten years to implement the use of transgenics have been particularly contentious. Opposition to transgenic plants generally falls into four basic categories, which I cover in this section.

Food safety issues

Normally, gene expression is highly regulated and tissue-specific, meaning that proteins produced in a plant's leaves, for example, don't necessarily show up in its fruits. Because of the way transgenes are inserted, however, their expression isn't under tight control (because the genes are always "on;" see "Following the transgenesis process in plants" earlier in this chapter). Opponents to transgenics worry that proteins produced by transgenes may prove toxic, making foods produced by those crop plants unsafe to eat. Researchers usually evaluate the effects of chemicals and drugs by dosing animals (usually rats and mice) with ever-increasing amounts of the chemical until they observe effects. Food products are more complicated to test, though, because test animals get not only the protein produced by the transgene but the food as well, making it hard to parse out the effects of one ingredient over another. Instead of going the megadose route with animal testing, safety evaluations of transgenic crops rely on a concept called substantial equivalence.

Substantial equivalence is a detailed comparison of transgenic crop products with their non-transgenic equivalents. This comparison involves chemical and nutritional analyses, including tests for toxic substances. If the transgenic product has some detectable difference, that trait is targeted for further evaluation. Thus, substantial equivalence is based on the assumptions that any ingredient or component of the nontransgenic product is already deemed safe and that only new differences found in the transgenic version are worth investigating. For example, in the case of transgenic potatoes, unmodified potatoes are thought to be safe, so only Bt is slated for further

tests. In spite of comparison testing, researchers have had difficulty documenting any unwanted side effects from food produced with transgenic crops. Millions of persons each year consume food produced with these crops, and no ill effects have been documented thus far.



One research report published in 1999 documented the possibly hazardous nature of transgenic food. In short, the study reported evidence that rats' immune systems and organs were damaged by consuming transgenic potatoes. Upon its release, the study generated a great deal of controversy, in part because one of the authors of the study announced his findings before the paper was accepted for publication in any scientific journal. That may not sound like a big deal, but it means that experts in the field hadn't evaluated the work before it was made public. Evaluation of research results as part of the publication process is called *peer review*. Peer review is meant to prevent erroneous or bogus findings from being reported as fact. In the case of the transgenic potato uproar, the talkative author was severely castigated by the scientific community for announcing his results as valid when no evaluations other than his own had occurred. The work was eventually published, but its conclusions haven't been easy to replicate, suggesting that the result may not be valid.

Escaped transgenes

The escape of transgenes into other hosts is a widely reported fear of transgenic opponents. Canola, a common oil-seed crop, provides one good example of how quickly transgenes can get around. Herbicide-resistant canola was marketed in Canada in 1996 or so. By 1998, wild canola plants in fields where no transgenic crop had ever been grown already had not one but *two* different transgenes for herbicide resistance. This finding was quite a surprise because no commercially available transgenic canola came equipped with both transgenes. It's likely that the accidental transgenic acquired its new genes via pollination.

In 2002, several companies in the United States failed to take adequate precautions mandated by law to prevent the escape of corn transgenes via pollination or the accidental germination of untended transgenic seeds. These lapses resulted in fines — and the release of transgenes into unintended crops.

Actual transgene escape isn't widely documented yet, but containment of transgenes is virtually impossible. *Introgression*, the transfer of transgenes from one plant to another, has the potential to occur relatively frequently. Canola, sunflowers, wheat, sugar beets, alfalfa, and sorghum readily share genes with related plants. Most of these plants are wind-pollinated, meaning that mature plants easily spread their genes over very broad regions every time the breeze blows. For example, one transgenic grass used on golf courses passed its transgene for herbicide resistance on to a wild relative that was a whopping 12 miles away!

Movements of transgenes for pest and herbicide resistance may pale in the face of the newest wave of transgenic plants: pharmaceuticals. The goal of this movement is to use plants to produce proteins that were previously difficult or prohibitively costly to manufacture. Drugs to treat disease, edible vaccines, and industrial chemicals are just a few of the possibilities. As of this writing, actual field trials for some of these transgenic plants are already underway. The consequences for transgene escape from these sorts of crops could be dire — and frankly, containment failures of other transgenic crops don't bode well for future containment prospects. And unlike Bt and herbicide-ready transgenics, the compounds produced by pharmaceuticals are truly biologically active in humans, making them truly dangerous to human health.

Developing resistance

The third major point of opposition to transgenics — the development of resistance to transgene effects — is connected to the widespread movement of transgenes. The point of developing most of these transgenic crops is to make controlling weeds or insect pests easier. Additionally, transgenic crops (particularly transgenic cotton) have the potential to significantly reduce chemical use, which is a huge environmental plus. However, when weeds or insects acquire resistance to transgene effects, the chemicals that transgenics are designed to replace are rendered obsolete.

Full-blown resistance development depends on artificial selection supplied by the herbicide or the plant itself. Resistance develops and spreads when insects that are susceptible to the pesticide transgene being used are all killed. The only insects that survive and reproduce are, you guessed it, able to tolerate the pesticide transgene. Insects produce hundreds of thousands of offspring, so it doesn't take long to replace susceptible populations with resistant ones. To counter the threat of resistance development, users of transgenic crops advocate nontransgenic refuges — places where nontransgenic crops are grown to support populations of susceptible bugs. The idea is that inheritance of the transgene resistance is diluted by the genes of susceptible bugs. So far, the implementation of refuges has seen limited success; in all likelihood, refuges may only slow the spread of resistance, not prevent it altogether.

Damaging unintended targets

The argument against transgenic plants is that nontarget organisms may suffer ill effects. For example, when Bt corn was introduced (see “Exploring commercial applications”), controversy arose surrounding the corn's toxicity to beneficial insects (that is, bugs that eat other bugs) and desirable creatures like butterflies. Indeed, Bt is toxic to some of these insects, but it's unclear how much damage these natural populations sustain from Bt plants. The biggest threat to migratory monarch butterflies is likely habitat destruction in their overwintering sites in Mexico, not Bt corn.

Assessing outcomes



Transgenic plants appear to help reduce the amount of pesticides used, but only by a small margin (between 1 and 3 percent). Since the development of transgenic plants, herbicide use has actually increased, presumably because the chemicals can be freely broadcast onto herbicide-ready crops. However, the impact of herbicide-resistant crops on *no-till*, a farming method that significantly reduces erosion and soil loss, is positive; more farmers have turned to *no-till* as they've adopted transgenic crops. But if weeds acquire the transgenes, this improvement will be promptly reversed. In fact, transgenic crops don't seem to have increased yields very much. Despite the relatively scant advantages and extremely strong opposition (especially in Europe), advocates of transgenic crops remain optimistic and hopeful for an agricultural revolution.

Toying with Transgenic Animals

Mice were the organisms of choice in the development of transgenic methods. Scientists discovered that genes could be inserted into a mouse's genome during the process of fertilization. When a sperm enters an egg, there's a brief period before the two sets of DNA (maternal and paternal) fuse to become one. The two sets of DNA existing during this intermission are called *pronuclei*. Geneticists discovered that by injecting many copies of the transgene (with its promoter and sometimes with a marker gene, too; see "Modifying the gene to reside in its new home") directly into the paternal pronucleus (see Figure 19-2), the transgene was sometimes integrated into the embryo's chromosomes. (Eggs can be injected with transgenes after the pronuclei fuse, but uptake of the transgene is somewhat less efficient.)

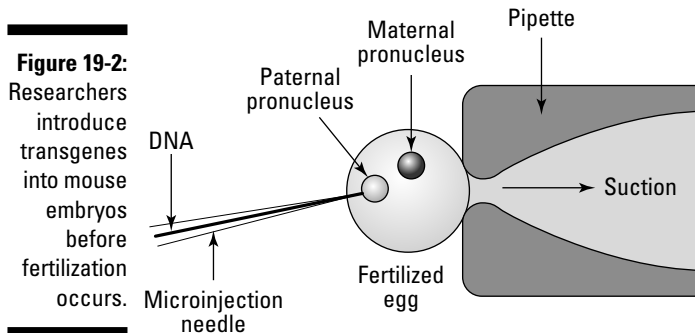

Not all of the embryo's cells contain the transgene, however, because the uptake of the transgene takes place during cell division; sometimes, several rounds of division occur before the transgene gets scooped up. The cells that do have the transgene often have multiple copies (oddly, these end up together in a head-to-tail arrangement), and the transgenes are inserted into the mouse's chromosomes at random. The resulting, partly transgenic mouse is called a *chimera*, or a *mosaic*. Mosaicism is the expression of genes in some but not all cells of a given individual, making gene expression somewhat patchy. To get a fully transgenic animal, many chimeras are mated in the hope that homozygous transgenic offspring will be produced from one or more matings. After researchers obtain homozygotes, they isolate the transgene line so that no heterozygotes are formed by mating transgenic animals with nontransgenic animals.

One of the first applications of the highly successful mouse transgenesis method used growth hormone genes. Rat, human, and bovine growth hormone genes produced much larger mice than normal. The result encouraged the idea that growth hormone genes engineered into meat animals such as the following would allow faster production of larger, leaner, animals:

- ✓ **Pigs and cows:** Transgenic pigs haven't fared very well; in studies, they grew faster than their nontransgenic counterparts but only when fed large amounts of protein. And female transgenic pigs turned out to be sterile. All pigs showed muscle weakness, and many developed arthritis and ulcers. Cows haven't done any better. So far, no commercially viable transgenic cows or pigs engineered for growth have been produced.
- ✓ **Fish:** Unlike pigs and cows, fish do swimmingly with transgenes (see the sidebar "Transgenic pets: Not all fun and games" for one application of transgenics in fish). Transgenic salmon grow six times faster than their nontransgenic cousins and convert their food to body weight much more efficiently, meaning that less food makes a bigger fish. So far, Atlantic salmon are targeted for the growth-enhancing gene, but none are commercially available yet. Transgenic fish would be raised in pens situated in larger bodies of water, making escape of transgenics into wild populations a certainty. Plus, natural salmon populations are severely depleted due to overharvest. Farmed fish tend to be highly aggressive and are feared to out compete their wild relatives. Thus, farm-raised salmon pose a threat to natural populations of both their own and other fish species as well.

Primates have also been targeted for transgenesis as a way to study human disorders including aging, neurological diseases, and immune disorders. The first transgenic monkey was born in 2000. This Rhesus monkey was endowed with a simple marker gene because the purpose of the study was simply to determine whether transgenesis in monkeys was possible. The marker gene used was the one that produces green fluorescence in jellyfish. This gene has been successfully inserted into plants, frogs, and mice, but those recipients rarely glow green. The monkey recipient is no exception: Her chromosomes

bear the gene, but no functional fluorescent protein is produced — yet. Twin monkeys produced in the same project died before birth, but both had fluorescent fingernails and hair follicles. Because some transgenic animals display delayed onset of the gene function, the surviving monkey may yet glow. Even with this modest success, monkeys' reproductive cycles aren't easy to manipulate, so progress with transgenic primates is slow.

CASE STUDY



Transgenic pets: Not all fun and games

Ever have one of those groovy posters that glows under a black light? Well, move that black light over to the aquarium — there's a new fish in town. Originally derived from zebrafish, a tiny, black-and-white-striped native of India's Ganges River, these glowing versions bear a gene that makes them fluorescent. The little, red, glow-in-the-dark wonders (one report calls them "Frankenfish") are the first commercially available transgenic pets.

Zebrafish are tried-and-true laboratory veterans — they even have their own scientific journal! Developmental biologists love zebrafish because their transparent eggs make it simple to observe development. Geneticists use zebrafish to study the functions of all sorts of genes, many of which have direct counterparts in other organisms, including humans. And genetic engineers have taken advantage of these easy-to-keep fish, too; scientists in Singapore saw the potential to use zebrafish as little pollution indicators. The Singapore geneticists use a gene from jellyfish to make their zebrafish glow in the dark. The action of the fluorescent gene is set up to respond to cues in the environment (like hormones, toxins, or temperature; see Chapter 10 for how environmental cues turn on your genes). The transgenic zebrafish then provide a quick and easy to read signal: If they glow, a pollutant is present.

Of course, glowing fish are so unique that some enterprising soul couldn't let lab scientists have all the fun. Thus, these made-over zebrafish have hit pet stores. Many scientists don't see the humor in making transgenic fish available to

the public, however. The state of California has banned their sale outright, and at least one major pet store chain refuses to sell them. The main objection so far seems to be an ethical one — opponents object to genetic engineering used for "trivial" purposes (see Chapter 21 for details about ethics and genetics). The U.S. FDA (Food and Drug Administration), however, has deemed glowing zebrafish safe (they're nontoxic, and no, you won't glow if you eat one).

A more serious and biologically relevant argument against glowing exotic fish may be the threat of invasive species. Invasive species present all kinds of nasty problems for the environment. For example, the reason you don't enjoy homegrown chestnuts in the United States any more is because an introduced plant disease literally wiped out every single tree. Introduced insects, plants, and animals represent an enormous and expensive threat to agriculture worldwide. Regular zebrafish already live in Florida's warm waters along with a dizzying number of other nonnative fish that collectively threaten to destroy the native fish community entirely. Glowing fish may be only the beginning, by the way. Reports suggest that glow-in-the-dark lawn grasses and grasses in unusual colors are in the works. And remarkable glowing colors are only one possibility. One company has announced plans to make hypoallergenic cats! (But don't hold your breath; animals don't respond well to the random insertion of genes into their chromosomes, so the production of sneeze-free kitties is a distant dream.)

Trifling with Transgenic Insects

A number of uses for transgenic insects appear to be on the horizon. Malaria and other mosquito-borne diseases are a major health problem worldwide, but the use of pesticides to combat mosquito populations is problematic because resistant populations rapidly replace susceptible ones. And, in fact, the problem is not really the mosquitoes themselves (despite what you may think when you're being buzzed and bitten). The problem is the parasites and viruses the mosquitoes carry and transmit through their bites. In response to these problems, researchers are developing transgenic mosquitoes unable to carry parasites or viruses, rendering their bites itchy but otherwise harmless. Unfortunately, it's not clear how or if transgenic mosquitoes could replace populations of bugs that carry diseases.

Other attempts at biological control of insects have met with limited success. They usually involve the release of millions of sterile bugs that attract the mating attentions of fertile ones. The matings result in infertile eggs, reducing the reproduction of the target insect population. Part of the downside of this environmentally friendly approach to pest control is that sterility is induced using radiation, and irradiated insects lack the vigor needed to aggressively pursue sex. Transgenic infertility may solve the problem. The general process is the same, but the transgenically infertile insects still have the energy needed to pursue mates, resulting in a more effective pest control strategy. This is an especially appealing idea when used to combat invasive species that can sweep through crops with economically devastating results.

The whole transgenic pesticide-resistance affair may be used to enhance natural control of pest populations by using insects that make a living eating other bugs. The idea is to create beneficial insects that bear the transgene that confers pesticide resistance. The farmers can then put out pesticides to kill susceptible insects and release beneficial bug predators to do the rest. Such a strategy may reduce pesticide use dramatically and eliminate the need for transgenic, insect-resistant crops.

Another transgenic insect project in the works uses silkworms. The silkworms are equipped with a gene used to make human skin protein. The intention is to mass-produce the protein for use in human skin grafts needed after burns and to aid with wound healing.

Fiddling with Transgenic Bacteria

Bacteria are extremely amenable to transgenesis. Unlike other transgenic organisms, genes can be inserted into bacteria with great precision, making expression far easier to control. As a result, many products can be produced using bacteria, which can be grown under highly controlled conditions,

essentially eliminating the danger of transgene escape. (The techniques used to slip genes into bacteria chromosomes are identical to those used in gene therapy, which I describe in Chapter 16.)

Many important drugs are produced by recombinant bacteria, such as insulin for treatment of diabetes, clotting factors for the treatment of hemophilia, and human growth hormone for the treatment of some forms of dwarfism. These sorts of medical advances can have important side benefits, as well:

- ✓ Transgenic bacteria can produce much greater volumes of proteins than traditional methods.
- ✓ Transgenic bacteria are safer than animal substitutes, such as pig insulin, which are slightly different from the human version and therefore may cause allergic reactions.
- ✓ Transgenic bacteria are much less controversial than other organisms and thus are well received for the production of medications.

Transgenic bacteria are also used for applications down on the farm. Bovine somatotropin, better known as bovine growth hormone, increases milk production in cows. Transgenic bacteria are used to produce large quantities of the hormone (called rbGH for recombinant bovine growth hormone), which is injected into dairy cows to boost milk production. Despite outcries to the contrary, studies show that rbGH isn't active in humans, meaning that humans don't respond to bovine growth hormone even when it's injected in their bodies. Furthermore, milk produced by cows injected with rbGH is chemically indistinguishable from milk produced by cows injected with the actual hormone. The advantage of rbGH is that it allows fewer cows to produce more milk — a good thing because dairies represent a significant source of fecal pollution in rivers and streams, and fewer cows means less pollution. The downside is that cows treated with rbGH are more vulnerable to infection, requiring treatment with antibiotics and thus increasing the risk of developing antibiotic-resistant bacteria.

Recent advances in biotechnology may produce other gains in protecting the environment. For example, work is underway to take advantage of the production of biodegradable plastics using bacteria-produced chemicals called polyhydroxyalkanoates (PHAs). PHAs are molecules that are used like fats to store energy. They're also very similar to the plastics made from petroleum that you see all the time. Researchers have taken the gene that makes PHA and popped it into *E. coli* to produce enough PHA to manufacture products with. It's likely that PHAs will find their way into the marketplace as a viable alternative to traditional plastics.

Chapter 20

Cloning: There'll Never Be Another You

In This Chapter

- ▶ Defining cloning
 - ▶ Investigating how cloning animals works
 - ▶ Sorting out the arguments for and against cloning
-

It sounds like science fiction: Harvest your genetic information, implant that information into an egg cell, and after nine months, welcome a new baby into the world. A new baby with a difference — it's a clone.

Depending upon your point of view, cloning organisms may sound like a nightmare or a dream come true. Whatever your opinion, cloning is most definitely not science fiction; decisions about experimental cloning are being made right now, every day. This chapter covers cloning: what it is, how it's done, and what its impact is from a biological point of view. Cloning (like just about everything else in science) isn't as simple as the media makes it sound. In this chapter, you get to know the problems inherent in clones along with the arguments for and against cloning (not just of humans — of animals and plants, too). Get ready for an interesting story. Remember, it ain't fiction!

Attack of the Clones



A *clone* is simply an identical copy. The word is used as both a verb, as in “to clone” (make one) and a noun, as in “a clone” (have one or be one). Genetically, the word *clone* can have two meanings. When geneticists talk about cloning, they're most often talking about copying some part of the DNA (usually a gene). Geneticists clone DNA in the lab every day — the technology is simple, routine, and unremarkable. Cloning genes is a vital part of

- ✓ DNA sequencing (see Chapter 11)
- ✓ The study of gene functions (see Chapter 10)

- ✓ The creation of recombinant organisms (see Chapter 16)
- ✓ The development of gene therapy (see Chapter 16)

The other use of the word *cloning* means to make a copy of an entire organism as a reproductive strategy. When referring to a whole creature as opposed to DNA, a clone is an organism that's created via asexual reproduction, meaning offspring are produced without the parent having sex first. Cloning occurs naturally all the time in bacteria, plants, insects, fish, and lizards. For example, one type of asexual reproduction is *parthenogenesis*, which occurs when a female makes eggs that develop into offspring without being fertilized by a male (for some of you female readers, I'm sure this sounds very appealing). So if reproduction by cloning is a natural, normal biological process, what's the big deal with cloning organisms using technology?

Like No Udder

Cloning animals hit the news big time in 1997 with the birth of Dolly, an unremarkable looking Finn Dorset lamb. (In case you're wondering, Finn Dorset sheep are all white with small ears.) Named after the well-endowed country singer Dolly Parton, Dolly the sheep was a clone of one of her mother's udder cells. (If you didn't grow up on a farm, udders are the part of the animal that produces milk — in other words, breasts. And, hence the name of everyone's favorite clone.) I use the term “mother” rather loosely when it comes to Dolly; the cells came from one animal, the egg was derived from a second animal, and yet a third female was the birth mom.

Dolly's name was intended as a bit of a joke, but the fact that an animal had been cloned meant many people weren't laughing. Images of a future filled with mass-produced human beings began to fill the minds of many. Clones aren't unique individuals and, in Dolly's case, are produced via technology. Therefore, human rights advocates and religious leaders often object to cloning on moral or ethical grounds (see “Arguments against cloning” later in this chapter).



Despite her ordinary appearance, Dolly was unique in that no other mammal had been reproduced successfully using a somatic (body) cell via cloning (see the “Discovering why Dolly is really something to bah about” section later in the chapter). But Dolly wasn't the first organism to be cloned.

Cloning before Dolly: Working with sex cells

Experimental cloning started in the 1950s. In 1952, researchers transplanted the nucleus from a frog embryo into a frog egg. This and subsequent experiments were designed not to clone frogs but to discover the basis of *totipotents*.

Totipotent cells are capable of becoming any sort of cell and are the basis for all multicellular organisms. Totipotency lies at the heart of developmental genetics.

For most organisms, after an egg is fertilized, the zygote begins developing by cell division, which I walk you through in Chapter 2. Division proceeds through two, four, eight, and sixteen cells. When the zygote reaches the 16-cell stage, the cells wind up in a hollow ball arrangement called a *blastocyst*. Figure 20-1 shows the stages of development from two cells to blastocyst.

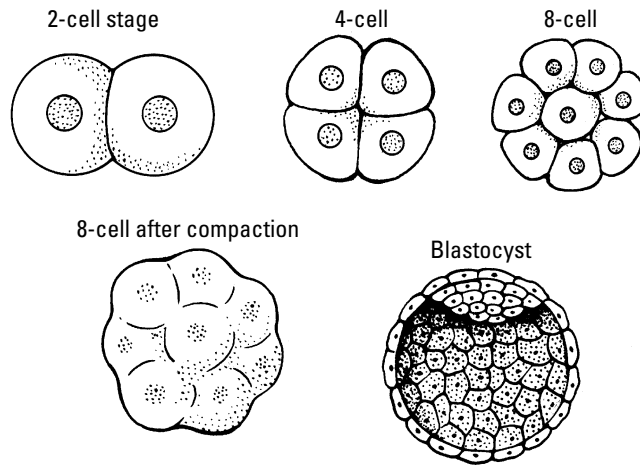

Figure 20-1:

The development of a mammalian egg from two cells to blastocyst.



Zygote development in mammals is unique because the cells don't all divide at the same time or in the same order. Instead of proceeding neatly from two to four to eight, the cells often wind up in odd numbers. Mammal zygotes have a unique stage of development, called *compaction*, when the cells go from being separate little balls into being a single, multicellular unit (see Figure 20-1). Compaction occurs after the third round of cell division. After compaction, the cells divide again (up to roughly 16), the inner cell mass forms (this will become the fetus), and fluid accumulates in the center of the ball of cells to form the blastocyst.

After a few more divisions, the cells rearrange into a three-layered ball called a *gastrula*. The innermost layer of the gastrula is *endoderm* (literally “inner skin”), the middle is *mesoderm* (“middle skin”), and the outermost is *ectoderm* (“outer skin”). Each layer is composed of a batch of cells, so from the gastrula stage onward, what cells turn into depends on which layer they start out in. In other words, the cells are no longer totipotent; they have specific functions.

Aclone in the universe?

When a human clone was reportedly born in December 2002, the news wasn't wholly unexpected. A company called Clonaid made the announcement and, purportedly, the clone; the company claimed that one cloned child had been born and numerous clone babies were on the way. The question is: On their way from where? As it turns out, Clonaid was founded by a group called the Raelians. While being entertained by sexy robots on board an alien spacecraft, Rael, the group's founder, reportedly learned that all humans are descended from clones created 25,000 years ago by space aliens. Clonaid's

claims (all of them, including the sexy robot thing) are unsubstantiated. Shortly after the initial announcement of cloning success, Clonaid was invited to submit samples for genetic testing to support its claim. Ultimately, Clonaid refused genetic tests as an infringement on the right to privacy by the cloned child's parents. There's no word on how many parents the cloned child might have (with the egg mother, womb mother, and cell donor, it could be as many as three different people!). So have we a clone in the universe? I'll let you decide.



So why is totipotency important? The entire body plan of an organism is coded in its DNA. Practically every cell gets a copy of the entire body plan (in the cell nucleus; see Chapter 6 for more on DNA and cells). Yet, despite having access to the entire genome, eye cells produce only eye cells, not blood cells or muscle cells. All cells arise from totipotent cells but end up *nullipotent* — able to produce only cells like themselves. Totipotents hold the key to gene expression and what turns genes on and off (covered in detail in Chapter 10). Understanding what controls totipotency also has broad implications for curing diseases such as cancer (see Chapter 14), treating spinal cord injuries via totipotent stem cells (see Chapter 23), and curing inherited disorders (see Chapter 15).

Discovering why Dolly is really something to bah about

The scientific breakthrough that Dolly the sheep signifies isn't cloning. The real breakthrough is that Dolly started off as a nullipotent cell nucleus. For many years, scientists couldn't be certain that loss of totipotency didn't involve some change at the genetic level. In other words, researchers wondered if the DNA itself got altered during the process of going from totipotent to nullipotent. Dolly convincingly demonstrated that nuclear DNA is nuclear DNA regardless of what sort of cell it comes from. (See Chapter 6 for more about nuclear DNA.) Theoretically, *any* cell nucleus is capable of returning to totipotency. That may turn out to be very good news.

The promise of *therapeutic cloning* is that someday doctors will be able to harvest your cells, use your DNA to make totipotent cells, and then use those cells to cure your life-threatening disease or restore your damaged spinal cord to full working order. Creating totipotent cells from nullipotent cells to treat injury or disease is difficult and triggers significant ethical debates (see “Weighing Both Sides of the Cloning Debate” later in this chapter). Realizing the potential of therapeutic cloning may be a very long way off. Meanwhile, *reproductive cloning* — the process of creating offspring asexually — is already causing quite a stir. For a taste of some of the excitement, see the sidebar “Aclone in the universe?”.

Clone It Yourself!

Despite the fact that rats, mice, goats, cows, horses, pigs, and cats have all been cloned, cloning isn't easy or routine. Cloning efficiency (the number of live offspring per cloning attempt) is generally very low. Dolly, for example, was the only live offspring out of 277 tries. All sorts of other biological problems also arise from cloning, but to understand them, you first need to understand how clones are created. (I return to the subjects of challenges and problems in the aptly titled “Confronting Problems with Clones” section later in the chapter.)

Making twins

One simple way to make a clone is to take advantage of the natural process of twinning. Identical twins normally arise from a single fertilized egg, called a zygote (see the “Cloning before Dolly: Working with sex cells” section earlier in the chapter). The zygote goes through a few rounds of cell division, and then the cells separate into two groups, each going on to form one offspring.

Artificial twinning is relatively simple and was first done successfully (in sheep) in 1979. A single fertilized egg was used, meaning that the resulting offspring was the result of sexual reproduction. Zygotes from normally fertilized (sexually produced) eggs were harvested from ewes (female sheep). The zygote was allowed to divide up to the 16-cell stage (see the “Cloning before Dolly: Working with sex cells” section earlier in the chapter). The 16 cells were then divided into two groups. The separate groups of cells went right on dividing, and after they were implanted into the reproductive tract of the ewe, they resulted in twins. The twins were genetically identical to each other because they were produced from the same fertilized egg.

In cows, about 25 percent of artificial embryo splits result in twin births; 75 percent result in only one calf. Nonetheless, the procedure is successful enough to increase the number of calves by about 50 percent over conventional fertilizations. By the year 2000, roughly 50,000 calves had been produced

using embryo splitting. This sort of cloning is relatively routine in agricultural settings and has received surprisingly little attention in the debate over cloning. The fact that the clones arise from a fertilized egg may have dampened the furor somewhat.

Using a somatic cell nucleus to make a clone

Somatic cells are body cells. Typically, body cells are *nullipotent*, meaning they only make more of the same kind of cell by mitosis (see Chapter 2 for all the details on mitosis). For example, your bone cells only make more bone cells, your blood cells only make more blood cells, and so on. Most somatic cells have nuclei that contain all the information needed to make an entire organism — in the case of cloning, a clone of the cell’s owner (sometimes referred to a donor).

Harvesting the donor cell

The choice of cell type used for cloning is not trivial. The cells must grow well *in vitro* (literally “in glass,” as in a test tube), and those from the female reproductive tract (mammary, uterine, and ovarian cells) seem to work best. Sorry, guys, but so far very few clones are male.

Because body cells are often in the process of dividing (mitosis), the donor’s cell must be treated to stop cell division and leave the cell in the G₀ stage of mitosis. In this state, the chromosomes are “relaxed” and the DNA isn’t undergoing replication. When the cell is made inactive, the nucleus of the donor cell along with all the chromosomes inside it are harvested. This harvest is usually accomplished by gently drawing the cell nucleus out with a needle attached to a syringe-like tool called a *pipette* (see Figure 20-2 to see what this looks like). The process of removing a cell nucleus is called *enucleation*, and the resulting cell is *enucleated* (that is, lacking a nucleus).

Harvesting the egg cell

To complete the process of making a clone using the somatic cell method, another cell is needed; this time, an egg cell. Egg cells are generally the largest cells in the body. In fact, a mature mammalian egg cell is visible to the naked eye; it’s about the size of a very small speck of dust, like what you might see floating in the air when a shaft of sunlight pierces an otherwise dark room.

To harvest an egg cell, the female animal (here, called the egg mother) is treated with a hormone to stimulate ovulation. When the egg mother produces eggs, she first makes an *oocyte*, or immature egg (see Chapter 2 for a full rundown of egg production as part of gametogenesis). At the oocyte stage, the egg has completed the first round of meiosis (meiosis I) but isn't ready to be fertilized. The oocyte is harvested, and all the chromosomes are removed (oocytes don't really have nuclei to contain chromosomes) using the same method as was used for the somatic cell, leaving only the cytoplasm behind (take a peek at Figure 20-2). Also remaining in the oocyte's cytoplasm are mitochondria, which each contain a copy of the egg mother's mitochondrial DNA (see Chapter 6). After the clone is formed, the egg mother's mitochondrial DNA and the donor cell's nuclear DNA may interact and have unexpected consequences (see "Confronting Problems with Clones" later in this chapter).

As it turns out, some egg cells are really versatile. Rabbit egg cells have been used to clone cats, for example. Generally, though, staying within a species works best — that is, cat egg cells work best with cat somatic cell nuclei. See the sidebar "Clone, Spot, clone!" for more about cloned kitties.

Putting it all together

With both donor cell and the egg cell in hand, the nucleus from the donor cell is injected into the enucleated oocyte (see Figure 20-2). The donor nucleus is fused with the oocyte using a brief electrical shock. This little jump-start plays the part of fertilization: The oocyte starts dividing and begins developing into an embryo. After cell division is well established, the dividing cells are implanted into a female (the birth or gestation mother) for the remainder of the pregnancy. Dolly the sheep clone was born after 148 days gestation, which is about five days longer than average for a Finn Dorset sheep.

Clone, Spot, clone!

Yes, folks, it's possible to clone your kitty or duplicate your doggie. That's the promise of a company called Genetic Savings and Clone, which offers tissue preservation services and yes, cloning. The first cloned cat, named CC for Copy Cat, was produced by researchers at Texas A&M University in 2002. (It's the ultimate revenge for all those Aggie jokes, I guess.) The work, funded by billionaire John Sperling, was originally meant for canine cloning. Mr. Sperling wants to clone his own beloved dog, Missy, who died in 2002. Like most cloning efforts, success

rates are low; only one in 87 attempts produce a live kitten. But as it turns out, that old phrase "copy cat" has a deeper meaning — cats are a lot easier to clone than dogs for a number of reasons. Dogs' reproductive biology isn't very amenable to the forced ovulation required for oocyte harvesting. In the meantime, Genetic Savings and Clone can bank some of your dog's cells in supercold freezers until the technological problems are solved. Gives a whole new meaning to the command "stay," doesn't it?

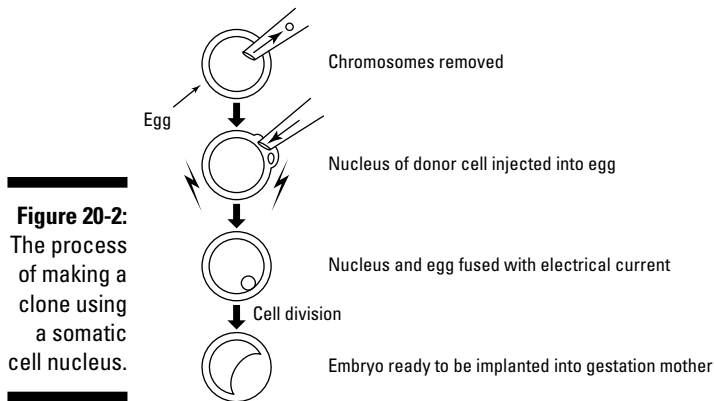

Confronting Problems with Clones

At birth, Dolly seemed normal in every way. She grew to adulthood, was mated to a ram, and gave birth to her own lambs (a total of six over her lifetime). However, Dolly lived only six years; normally, Finn Dorsets live 11 or 12 years. Dolly became ill with a lung disease, and to relieve her suffering, she was *ethanized* (painlessly put to death). The first hint that Dolly wasn't completely normal was arthritis. She developed painful inflammation in her joints when she was only 4 years old. Arthritis isn't unusual in sheep, but it usually only occurs in very old animals.



As it turns out, a number of abnormalities are common among clones. Clones suffer from a variety of physical ailments, including heart malformations, high blood pressure, kidney defects, impaired immunity to diseases, liver disorders, malformed body parts, diabetes, and obesity. The following sections examine the most common physical problems clones face.

Faster aging

Before somatic cells divide during mitosis, the DNA in each cell must replicate (see Chapter 7 for replication information). Each entire chromosome is copied except for the ends of the chromosomes, called *telomeres*, which aren't fully replicated. As a result, telomeres shorten as the cell goes through repeated rounds of mitosis. Shortening of telomeres is associated with aging because it happens over time (see the sidebar "Your aging DNA" for more). Telomere shortening may mean problems for clones created through somatic nucleus transfer because, in essence, such clones start out with "aged" DNA.

Your aging DNA

As you get older, your body changes: You get wrinkles, parts start to sag, and your hair goes gray. Eventually, the chromosomes in some of your cells get so short that they can no longer function properly, and the cells die. This progressive cell death is thought to cause the unwelcome signs of aging you're familiar with. In fact, the shortening of telomeres in most animals is so predictable that it can be used to determine how old an animal is.

All your cells have the genes to make telomerase (see Chapter 7). But telomerase genes are turned on only in certain kinds of cells: germ cells (those that make eggs and sperm), bone marrow cells, skin cells, hair follicle cells, and the cells that line the intestinal walls (in other words, cells that divide a lot). Cancer cells also have telomerase activity, a fact that allows the unregulated growth of tumors that's sometimes fatal (see Chapter 14 for more on genetics and cancer).

In experiments, mice without a functioning telomerase gene aged faster than normal mice. This finding led some researchers to believe that telomerase may be used (eventually) to reverse or prevent aging in humans. Recently, however, research shows that telomere length is only part of the story. Telomeres interact with proteins that cover them and act as caps. When those protein caps are missing, the cell cycle gets disrupted and may stop altogether, causing premature cell death. Finally, stress may play a significant role in how fast telomeres shorten. A study of mothers with chronically ill children showed that signs of aging were accelerated in the moms of ill children compared to moms of the same age with healthy children. The stressed moms had shortened telomeres and from a cellular point of view were up to 10 years older than their actual ages. Although telomerase may someday be part of treating stress and aging, research indicates that your best bet may be lowering stress levels the old-fashioned way: rest and relaxation.

Dolly had abnormally short telomeres, giving rise to the worry that perhaps all clones may suffer from degenerative diseases due to premature aging. Research with other clones has provided conflicting results. Some clones, like Dolly, have shortened telomeres. Surprisingly, some clones seem to have reversed the effects of aging; specifically, their telomeres are repaired and end up longer than those of the donor. What this reversal suggests is that embryonic cells have *telomerase*, the enzyme that builds new telomeres using an RNA template during DNA replication (see Chapter 7 for more about telomerase and its role in replication). In the end, the possibility of premature aging in clones is a real one, but not all clones seem to be susceptible to it.

Bigger offspring

Clones tend to be physically large; at birth, they have higher than average weights and larger than normal body sizes. Many clones, such as cows and sheep, must be delivered by cesarean section because they're too large to be

born naturally. In part, the large birth size of clones is due to the fact they stay in the womb longer than usual. Dolly the cloned sheep, for example, was born about five days after her birth mother's "due date." Offspring not born shortly after the normal due date (in humans, about two weeks late) are at great risk for stillbirth and complications, such as difficulty breathing. Clones tend to have very large placentas (the organ that links fetus to mother for oxygen and nutrition), which may contribute to their larger size, but the exact reason for the longer gestation periods is unclear.

The problem with oversize clones is so pervasive that it's been dubbed *large offspring syndrome*, or LOS. Many offspring, including humans, produced using *in vitro fertilization* (so-called test tube babies) also suffer from LOS, suggesting that it's not necessarily a problem associated with cloning. Instead, LOS seems to result from manipulation of the embryo. These manipulations cause changes in the way genes for growth are expressed (see Chapter 10 for more about gene expression). *Genomic imprinting* occurs when genes are expressed based on which parent they come from. (For more on genomic imprinting, jump to the sidebar "It takes two to make a baby.") In the case of LOS, what seems to happen is that the genes derived from the most recent male ancestor tell the fetus to grow faster and bigger than normal. Normally, genomic imprinting affects less than 1,000 genes (out of 25,000 total genes found in humans; see Chapter 11). How these "paternal" genes get turned on is anybody's guess, but the interaction of sperm with egg during fertilization is likely part of the answer. The end result of LOS is large offspring that often suffer from a variety of birth defects and are at risk for certain kinds of cancer. Estimates of LOS in human children born as a result of *in vitro* fertilization are about 5 percent. (Normally, LOS occurs in less than 1 percent of children produced through natural fertilization.)

It takes two to make a baby

Needing a mom and a dad to make a baby sounds like common sense, but the wonders of genetic engineering suggest otherwise (after all, Dolly had three mothers and no father). Maternal and paternal DNA *are* required for successful reproduction — at least by mammals — because of genomic imprinting. Genomic imprinting was first discovered in studies with mice. Researchers created mouse embryos with DNA from either female or male mice, but not both. Only embryos with paternal *and* maternal DNA developed normally, indicating that both male and female DNA are required for successful development. In other

studies, mice were engineered to have certain genes (see Chapter 19 for more on transgenic animals). The expression of the genes in offspring of the transgenic mice depended on which parents transmitted the genes. All offspring inherited the genes, but the genes were expressed only when the fathers transmitted them. Likewise, certain genes were expressed only when transmitted by the mothers. Thus, the growth and development of offspring is regulated by genes turned on simply because they come from mom or dad. Those genes then act in concert to regulate normal development of the embryo.

Developmental disasters



The percentage of cloning attempts that result in live births is extremely low. Generally, hundreds of cell transfers are carried out for every one offspring produced. Most clones perish immediately because they never implant into the uterus of the gestation mother. Of the embryos that do implant and begin development, more than half die before birth. In many cases, the placenta is malformed, preventing the growing fetus from obtaining proper nutrition and oxygen.

In most cloning attempts, two females are involved. The egg comes from one female and gets implanted into another female for gestation. Therefore, another cause of early death may be that the gestation mother rejects the clone as foreign. In these cases, the gestation mother's immune system doesn't recognize the embryo as her own (because it's not) and secretes *antibodies* to destroy it. Antibodies are chemicals produced by the body that interact with bacteria, viruses, and foreign tissues to fight disease.

Some of the problems suffered by clones may result from the mismatch between mitochondrial and nuclear DNA. When an oocyte is harvested from a different female than the somatic cell (see "Using a somatic cell nucleus to make a clone"), the egg contains roughly 100,000 copies of the egg mother's mitochondrial DNA. Unless the donor cell comes from the egg mother's sister, the somatic cell nucleus comes from a cell with a different mitochondrial genome. This mismatch means that the clone isn't a true clone — its DNA differs slightly from the donor. Cloned mice with mismatched mitochondrial and nuclear DNA tend to have decreased growth rates when compared to cloned mice with matched mitochondrial and nuclear genomes.

The type of donor cell used in cloning also makes a difference in the health of the resulting clone. When introduced into the oocyte, the donor cell nucleus gets "reprogrammed" somehow to go from nullipotent to totipotent. Some cell nuclei seem to be better at resetting to totipotent than others. Almost all clones whose genomes don't get reprogrammed perish.

Effects of the environment

Clones are *never* truly exact copies of the donor organism because genes interact with the environment in unique ways to form phenotype, or physical qualities. If you've ever known a set of identical twins, you know twins are very different from each other. Monozygotic twins have different fingerprints, develop at different rates, have different preferences, and die at different times. Being genetically identical doesn't mean they're truly, 100 percent identical.

The environment's role in development is perhaps best illustrated by experiments using plants. Suppose shoots from a single plant are rooted and grown at different locations on a mountainside. In essence, the plants are clones of

the parent plant. If genetic control were perfect, we'd expect identical plants to perform in identical ways, regardless of environmental conditions. However, the plants in our experiment grow at very different rates depending upon their locations. In other words, identical plants perform differently under different conditions. Likewise, genetically identical mice raised under exactly the same conditions don't respond in identical ways to exactly the same doses of medications.

All organisms respond to their environments in unique and unpredictable ways. From the very beginning, animals experience unique conditions inside the womb. Hormonal exposure during pregnancy can have profound effects on developing organisms. For example, female piglets sandwiched between brothers while in the womb are more aggressive as adults than females that were situated between sisters. This is because male piglets secrete testosterone — a hormone that increases aggressive behavior.

Attempts to replicate organisms exactly are doomed to failure. Genetics doesn't control destiny because genes aren't expressed in predictable ways. Persons carrying mutations for certain diseases don't have a 100-percent probability of developing those diseases (see Chapter 13). Likewise, clones will not express their genes in precisely the same way as the donor organism. Add the differences in mitochondrial DNA, in utero conditions (clones usually develop in a different womb), and time periods to the huge differences already present, and the only conclusion is that no clone will ever experience the world in precisely the same way as the donor organism did.

Weighing Both Sides of the Cloning Debate

The arguments for and against cloning are numerous. In the sections that follow, I review some of the main points in both the pro and con corners. As you read, understand that these aren't *my* opinions and arguments; I only summarize what others have argued before me. I try to be balanced and fair because before you can responsibly take a position on cloning, you need to know both sides of this controversial topic. And for more information on ethical considerations in genetics, see Chapter 21.

Arguments for cloning

Like every other scientific discovery, cloning can be used to do a lot of good. Cloning for medical and therapeutic purposes gives enormous hope that paralyzed persons will walk again and that people suffering from previously incurable conditions such as muscular dystrophy and diabetes will be cured.

Cloning has provided scientists with some important answers about how genetics works. Prior to these discoveries, the changes that occur from embryo to adult were believed to cause permanent changes to the organism's DNA. Now we know that's not true. Because all DNA has the potential to return to totipotency, doctors have the unparalleled opportunity to correct genetic defects and provide treatment for devastating progressive diseases.

Another plus in the pro-cloning camp is that it may provide genetically matched organisms that will streamline research into the causes and treatments of diseases such as cancer. Because matched comparisons are scientifically more powerful, fewer animals are needed to conduct experiments. Such changes are an important advance over current research methods and will improve conditions for experimental animals.

Advancing knowledge of genetics can provide dramatic benefits not only to humans, but also to the planet as a whole. Cloning may represent the last hope for some rare and endangered species. When only a few individuals remain, cloning may provide additional individuals to allow the population to survive. Given that the earth is experiencing its largest wave of species extinctions since ancient times, cloning may be a very significant advance for conservation biology.

Arguments against cloning

Although cloning represents an enormous opportunity, it's opportunity fraught with danger. For the first time in history, humans possess the technology to create genetically modified organisms. That capability extends not just to animals and plants but to humans as well. Furthermore, the genetic diversity that gives the natural world its rich texture is endangered by a unique threat — that of creating organisms that are genetically identical.

As I discuss in Chapter 17, genetic diversity is extremely important to establishing and maintaining the health and well-being of populations of organisms. Research shows that genetically diverse populations are more resilient to environmental stress and better at resisting disease. Thus, creating populations of genetically similar organisms exposes all organisms to greater threats of disease. Lack of genetic diversity in populations of other organisms may ultimately expose humans to threats as well. For example, genetically identical crops could all fall prey to the same disease and consequently seriously endanger food supplies — this isn't as far-fetched as it sounds. In fact, efforts to archive genetically diverse strains of plants are already underway lest unique genetic characteristics, like disease resistance, are lost.

Furthermore, cloning is fraught with problems for which no good alternatives exist. For now, all cloning requires oocytes from female organisms. Those oocytes are obtained by first treating females with large doses of fertility drugs to stimulate ovulation. Such drugs stress the female's system enormously and

increase the rate of cell turnover in her ovaries. Some studies indicate that the drugs used for stimulating ovulation expose females to increased risk of ovarian cancer. And the risk doesn't end there. When eggs are produced, they must be surgically removed under anesthesia. Regardless of the precautions, the female organism can and does experience pain. Animals can't give or withhold consent, so they're subjected to these procedures whether they like it or not.

After eggs are harvested and donor cells are fused with them, development of an embryo begins. The vast majority of cloning attempts, regardless of their ultimate purpose, result in death of the embryo. Granted, these embryos have no nerve cells and no consciousness that scientists know of, but nevertheless, living organisms are produced with little or no hope of survival.

If clones are successfully created, their quality of life may be poor. Clones suffer from a myriad of disorders for which causes are unknown. They may age prematurely and are likely at risk for disorders that are yet unrecognized consequences of the methods used in the cloning process. Like the experimental animals used for egg production, cloned animals can't withhold their consent and withdraw from study.

The most contentious issue posed by cloning technology is the production of human clones. As with animals, most cloned human embryos would have no hope of survival. Women must consent to painful and potentially dangerous procedures to produce eggs, and some woman must consent to carry the developing child and risk the emotional trauma of miscarriage or stillbirth. From an emotional standpoint, children created this way would be genetically identical to some other person, whether that person is living or dead. The pressure to be like someone else would undoubtedly be enormous. Further, because of the genetic similarities to some other individual, parents may have unrealistic expectations of their cloned offspring. Do individual humans have a right to genetic uniqueness? It's a difficult question, but it's one we need to answer soon, before human cloning becomes true reality.

Chapter 21

Ethics: The Good, the Bad, and the Ugly

In This Chapter

- ▶ Examining the dark side of genetics
 - ▶ Pushing the envelope of informed consent
 - ▶ Mapping genetic patterns worldwide
-

The field of genetics grows and changes constantly. If you follow the news, you're likely to hear about several new discoveries every week. When it comes to genetics, the amount of information is bewildering, and the possibilities are endless. If you've already read many of the chapters in this book, you have a taste of the many choices and debates created by the burgeoning technology surrounding our genes.

With such a fast growing and far-reaching field as genetics, ethical questions and issues arise around every corner and are interconnected with the applications and procedures. Throughout this book, I've highlighted this interconnectedness. I cover animal welfare issues (in the context of cloning) in Chapter 20. Conservation of the environment and endangered species is a key part of the discussion of population genetics in Chapter 17. Chapter 19 touches on the potential dangers — to the environment and to humans — of genetic engineering. Genetic counseling, including some of the issues surrounding prenatal testing, is the subject of Chapter 12. And Chapter 16 discusses gene therapy as an experimental and unpredictable form of treatment.

But I couldn't end the discussion of genetics and your world without some final comments on the ethical issues genetic advancements raise. In this chapter, you find out how genetics has been misunderstood, misinterpreted, and misused to cause people harm based on their racial, ethnic, or socioeconomic status. The rapidly growing field of genetics is contributing to ideas about how modern humans can mold the future of their offspring, so this chapter dispels the myth of the designer baby. You discover how information you give out and receive can be used for and against you. Finally, you gain a better understanding of the next generation of studies based on the Human Genome Project and the ethical issues that mapping human genetic diversity will bring up.

Going to Extremes with Genetic Racism

One of the biggest hot button issues of all time has to be *eugenics*. In a nutshell, eugenics is the idea that humans should practice selective reproduction in an effort to “improve” the species. If you read Chapter 19, which explains how organisms can be genetically engineered, you probably already have some idea of what eugenics in the modern age might entail (transgenic made-to-order babies, perhaps?). Historically, the most blatant examples of eugenics are genocidal activities the world over. (Perhaps the most infamous example occurred in Nazi Germany during the 1930s and 1940s.)



The story of eugenics begins with the otherwise laudable Francis Galton, who coined the term in 1883. (Galton is best remembered for his contribution to law enforcement: He invented the process used to identify persons by their fingerprints. Check out Chapter 18 for more on the genetic version of fingerprinting.) In direct and vocal opposition to the United States Constitution, Galton was quite sure that all men were *not* created equal (I emphasize here that he was particularly fixated on men; women were of no consequence in his day). Instead, Galton believed that some men were quite superior to others. To this end, he attempted to prove that “genius” is inherited. The view that superior intelligence is heritable is still widely held despite abundant evidence to the contrary. For example, twin studies conducted as far back as the 1930s show that genetically identical persons are not intellectually identical.

Galton gave eugenics its name, but his ideas weren’t unique or revolutionary. During the early 20th century, as understanding of Mendelian genetics (see Chapter 3) gathered steam, many people viewed eugenics as a highly admirable field of study. Charles Davenport was one such person. Davenport holds dubious distinction as the father of the American eugenics movement (one of his eugenics texts is subtitled, “The science of human improvement by better breeding”). The basis of Davenport’s idea is that “degenerate” people shouldn’t reproduce. This notion arose from something called *degeneracy theory* (not to be confused with the degeneracy of the genetic code, which is something else altogether; see Chapter 9). Degeneracy theory posits that “unfit” humans acquire certain undesirable traits because of “bad environments” and then pass on these traits genetically. To these eugenicists, unfit included “shiftlessness,” “feeble-mindedness,” and poverty, among other things.

While the British, including Galton, advocated perpetuating good breeding (along with wealth and privilege), many American eugenicists focused their attention on preventing *cacogenics*, which is the erosion of genetic quality. Therefore, they advocated forcibly sterilizing people judged undesirable or merely inconvenient. Shockingly, the forcible sterilization laws of this era have never been overturned, and until the 1970s, it was still common practice to sterilize mentally ill persons without their consent — an estimated 60,000

people in the United States suffered this atrocity. Some societies have taken this sick idea a step further and *murdered* the “unfit” in an effort to remove them and their genes permanently.

Sadly, violent forms of eugenics, such as genocide, rape, and forced sterilization, are still advocated and practiced all over the world. But not all forms of eugenics are as easy to recognize as these extreme examples. To some degree, eugenics lies at the heart of most of the other ethical quandaries addressed in this chapter. In addition, it only requires a little imagination to see how gene therapy (Chapter 16), gene transfer (Chapter 19), or DNA fingerprinting (Chapter 18) can be abused to advance the cause of eugenics.

Taking Steps to Create Designer Babies

One of the more contentious issues with a root in eugenics stems from a combination of prenatal diagnosis and the fantasy of the perfect child to create a truly extreme makeover — designer babies. In theory, a designer baby may be made-to-order according to a parent’s desire for a particular sex, hair and eye color, and maybe even athletic ability.

The myth of designer babies

The term *designer baby* gets tossed around quite a bit these days. In essence, the term is associated with genetically made-to-order offspring. As of this writing, neither the technology nor sufficient knowledge of the human genome exist to make the designer baby a reality.



The fantasy of the designer baby, like cloning (see Chapter 20), rests on the fallacy of *biological determinism* (which, by the way, is what eugenics bases some of its lies on, too; jump back to “Going to Extremes with Genetic Racism” to find out about eugenics). Biological determinism assumes that genes are expressed in precise, repeatable ways — in other words, genetics is identity is genetics. However, this assumption isn’t true. Gene expression is highly dependent upon environment, among other things (see Chapter 10 for more details about how gene expression works).

Furthermore, the *in vitro* fertilization process that plays a role in current-day applications of the science in question (see the next section) is a very dicey and difficult process at best — just ask any couple who’s gone through it in an effort to get pregnant. *In vitro* procedures are extremely expensive, invasive, and painful, and women must take large quantities of strong and potentially dangerous fertility medications to produce a sufficient number of eggs. And in the end, the vast majority of fertilizations don’t result in pregnancies.

The reality of the science: Prenatal diagnosis

So where does the myth of designer babies come from? Using procedures similar to those leading up to cloning (covered in Chapter 20), *preimplantation genetic diagnosis*, or PGD, is performed before a fertilized egg implants in the womb. Although it's true that PGD opens the remote possibility of creating transgenic humans using the same technology used to create transgenic animals (see Chapter 19 for details), the likelihood of PGD becoming commonplace is extremely remote.

The process of PGD is technologically complicated. First, unfertilized eggs are harvested from a female donor. *In vitro fertilization* (the process to produce the so-called test-tube baby) is performed, and then the fertilized eggs are screened for mutations and other genetic disorders. In a few rare cases, desperate parents have created embryos this way specifically to look for genetic compatibility with preexisting offspring — the plan being to conceive a sibling who can provide stem cells or bone marrow to save the life of a living sibling suffering from an otherwise untreatable disease. Saving the lives of living children undoubtedly is a laudable goal; the problem arises with what's done with the fertilized eggs that don't meet the desired criteria (if, for example, they don't have the desired tissue match). Even if inserted into the mother's uterus, the vast majority of these fertilized eggs would never implant and thus not survive. Although lack of implantation is also true when conception occurs naturally, it's still a very tough call to decide the fate of extra embryos. Options include donation to other couples, donation for research purposes, or destruction.

PGD and other forms of prenatal diagnoses allow parents the choice to prevent, alleviate, or reduce suffering (their own or someone else's). But like deciding the fate of extra embryos, this is very deep water. Without getting too philosophical, suffering is a highly personal experience; that is, what constitutes suffering to one person may look relatively okay to someone else. One example of relative suffering that comes up a lot is hereditary deafness. If a deaf couple chooses prenatal diagnosis, what's the most desirable outcome? On one hand, a deaf child shares the worldview of his or her parents. On the other hand, a hearing child fits into the world of non-deaf people more easily. By now, you see how complex the issues surrounding prenatal diagnosis are. It seems clear that right answers, if there are any, will be very hard to come by.

Toying with Informed Consent

Informed consent is a sticky ethical and legal issue. Basically, the idea is that a person can only truly make a decision about having a procedure when he or she is fully apprised of all the facts, risks, and rewards. Informed consent

can only be given by the person receiving the procedure or by that person's legal guardian. Generally, guardianship is established in cases where the recipient of the procedure is too young to make decisions for him or herself or is mentally incapacitated in some way; presumably, guardians have the best interests of their wards at heart.

Three major issues exist in the debate over informed consent:

- ✓ Genetic testing can be carried out on embryos, the deceased, and samples obtained from anyone during the simplest of medical procedures.
- ✓ Experimental genetic treatments (that is, gene therapies; see Chapter 16) have, by their very nature, unpredictable outcomes, making risk difficult to quantify to prospective participants.
- ✓ After tissue samples are obtained and genetic profiling is done, information storage and privacy assurance are problematic.

Placing restrictions on genetic testing



Genetic testing in the forms of DNA fingerprinting, SNP analysis (see Chapter 18), and sequencing (see Chapter 11) are now routine, fast, and relatively cheap. Massive amounts of information — from an individual's sex to his or her racial and ethnic makeup — can be gleaned from even a very tiny sample of tissue. The presence of mutations for inherited disorders can also be detected. Given that your DNA has so much personal information stored in it, shouldn't you have complete control over whether or not you're tested? The answer to this question is becoming more and more contentious as the definitions of, and limits to, informed consent are explored. The rights of persons both living and dead are at stake.

Consider the case of Abraham Lincoln. Lincoln was, as you probably already know, president of the United States from 1861 until his assassination in 1865. When he died, an autopsy was performed, and his hair, bone samples, and even blood samples were carefully preserved. (In the past, doctors embedded such samples in paraffin wax, which serves as a remarkably safe storage vault. Wax-stored lung tissue from flu victims of the 1918 epidemic still contains viable DNA, for example.) Lincoln was notably very tall and thin, a body type shared by persons with Marfan syndrome. Marfan is a hereditary disorder that affects the skeletal and cardiovascular systems; affected persons are generally very tall and often suffer significant and sometimes fatal heart abnormalities. Given Lincoln's stature, arthritis, and deep depressions, many experts wonder if he had Marfan. Given that his tissue samples are available, testing would be an easy way to clear things up once and for all. Except that Lincoln's dead and has no direct descendents who can give consent. Is the academic need-to-know sufficient? What are the rights of the deceased?

The descendents of Thomas Jefferson consented to genetic testing in 1998 to settle a long-standing controversy about Jefferson's relationship with one of his slaves, Sally Hemings (see Chapter 18 for the full story). In the Jefferson case, though, the matter was more than just academic curiosity because the right to burial in the family cemetery at Monticello was at stake.

The issue of informed consent, or lack thereof, is complicated by the ability to store tissue for long periods of time. In some cases, informed consent was given by patients or their guardians for certain tests but didn't include tests that hadn't yet been developed. Some institutions routinely practice long-term tissue storage, making informed consent a frequent point of contention. For example, a children's hospital in Britain was recently taken to task over storage of organs that were obtained during autopsies but weren't returned for internment with the rest of the body. Parents of the affected deceased had given consent for the autopsies but not the retention of tissues.

Biologists also use stored tissue to create *cell-lines*. Cell-lines are living tissues that are growing in culture tubes for research purposes. The original cell donors are often dead, usually of the disease under study. Cell-lines aren't that hard to make and maintain (if you know what you're doing), but the creation of cell-lines raises the question of whether the original donor has ownership rights to cells descended from his or her tissue. Cell-lines sometimes result in patents for lucrative treatments; should donors or their heirs get a royalty? (A court decision in California said "No.")

Practicing safe genetic treatment

If you've ever had to sign a consent for treatment form, you know it can be a sobering experience. Almost all such forms include some phrase that communicates the possibility of death. With a gulp, most of us sign off and hope for the best. For routine procedures and treatments, our faith is usually repaid with survival. Experimental treatments are harder to gauge, though, and fully informing someone about possible outcomes is very difficult.

The 1999 case of Jesse Gelsinger (covered in Chapter 16) brought the problem of informed consent and experimental treatment into a glaring, harsh light. Jesse died after receiving an experimental treatment for a hereditary disorder that, by itself, wasn't likely to kill him. His treatment took place to provide clinical trials of the particular therapy on relatively healthy patients and work out any difficulties before initiating treatments on patients for whom the disease would, without a doubt, be fatal (in this case, infants homozygous for the disorder). What researchers knew about all the possible outcomes and what the Gelsinger family was told before treatment began is debatable.

Almost every article on gene therapy published since the Gelsinger case makes mention of it. In fact, most researchers in the field divide the development of gene therapies into two categories: before and after Gelsinger. Sadly, Gelsinger's death probably contributed very little to the broader understanding of gene therapy. Instead, the impacts of the Gelsinger case are that clinical trials are now harder to initiate, criteria for patient inclusion and exclusion are heightened, and disclosure and reporting requirements are far more stringent. These changes are basically a double-edged sword: New regulations protect patients' rights and simultaneously decrease the likelihood that treatments will be developed to help those who desperately need them. Like so many ethical issues, a safe and effective solution may prove elusive.

Doling out information access

Another issue in the informed consent debate relates to privacy. When genetic tests are conducted, the data recorded often includes detailed medical histories and other personal information, all of which aids researchers or physicians in the interpretation of the genetic data obtained. So far, so good. But what happens to all that information? Who sees it? Where's it stored? And for how long?

Privacy is a big deal, particularly in American culture. Laws exist to protect one's private medical information, financial status, and juvenile criminal records (if any). Individuals are protected from unwarranted searches and surveillance, and they have the right to exclude unwanted persons from their private property. Genetic information is likely to fall under existing medical privacy laws, but there's one twist: Genetic information contains an element of the future, not just the past.



When you carry a mutation for susceptibility to breast cancer, you have a greater likelihood of developing breast cancer than someone who doesn't have the allele (see Chapter 14). A breast cancer allele doesn't guarantee you'll develop the cancer, though; it just increases the probability. If you were to be tested for the breast cancer allele and found to have it, that information would become part of your medical record. Besides your doctor and appropriate medical personnel, who might learn about your condition? Your insurance company, that's who. So far, situations such as this haven't presented a big problem because few people have had genetic tests. Genetic tests are expensive and aren't part of routine healthcare, but as technology advances and gets cheaper (like microarrays; see Chapter 23), genetic testing is likely to become more common. And that shift may be both a blessing and a curse.

As a patient, knowing that you have a genetic mutation is a really good thing because the condition may be treatable or early detection screening may help you prevent more serious developments. For example, cancers that are

caught early have far better prognoses than those diagnosed in later stages. However, knowing about a genetic mutation may give insurance companies and other healthcare providers the chance to issue or cancel policies, thus unfairly limiting your access to healthcare or employment. Sadly, at least one employer has been caught attempting to test workers for genetic predispositions to certain injuries (in this case, carpal tunnel syndrome, a repetitive stress injury to the hands and arms) without the employees' knowledge — clearly, a violation of informed consent.

Genetic privacy issues also feed into the controversies surrounding the Human Genome Project and efforts to characterize human population genetics. Critics fear that if certain mutations or health problems are genetically linked to groups of people, discrimination and bias will result. Lawmakers take these fears seriously, but as yet, no federal laws exist to specifically protect your genetic privacy.

Genetic Property Rights

According to U.S. law, a patent gives the patent owner exclusive rights to manufacture and sell his or her invention for a certain length of time (usually 20 years). That may not sound like a big deal, but what makes patents scary is that companies are patenting *genes* — DNA sequences that hold the instructions for life. And it's not just any genes, either. They're patenting *your* genes.

Patents are granted to *inventors*, but the people (or companies) holding gene patents didn't invent the genes that naturally occur in living organisms. According to most legal experts, genes are “unpatentable products of nature.” Yet so far, American and European patenting authorities have viewed genes in the same legal light as manmade chemicals. Generally, patent-holding companies sequence the genes and convert them to another form called cDNA (*c* means complementary; see Chapter 16 for coverage of translation). Then a patent is sought on the cDNA rather than the gene itself. Another approach to the patenting process is that the company discovers a gene (or a disease-associated version of it) and then invents products such as diagnostic tests that have something to do with the gene.

Just how a company can own and exercise exclusive rights over your genes is a little hard to understand. An example of how gene patenting works comes from the invention of the process of PCR (see Chapter 22 for the whole tale). The process uses an enzyme that's produced by a very special sort of bacteria. The gene that codes for that enzyme (called *Taq* polymerase, pronounced tack) is easily moved into other bacteria, such as *E. coli*, using recombinant DNA techniques (explained in Chapter 16). This means that *E. coli* can produce the enzyme that can then be used to run PCR. But if any other geneticist uses that gene to make *Taq* polymerase, a royalty must be paid to the company that patented it. Not surprisingly, this company is now the biggest manufacturer of *Taq* in the world, raking in profits in the billions of dollars.

Here are examples of how ugly the gene-patenting game can get:

- ✔ In 2001, an American company got a European patent for BRCA1, the breast cancer gene (see Chapter 14 for a full description of this mutation). This gene causes cancer, and presumably no one would want to purchase a case of breast cancer. So why patent it? Because the company holding the patent can charge large sums to test people to determine whether or not they carry the mutation.
- ✔ A large drug company holds a patent on a gene test that can determine whether the company's product will work for certain persons. The company refuses to actually develop the test or let anyone else have a crack at it because doing so may reduce sales of the medication in question.
- ✔ Companies patent disease-causing bacteria and viral genes for the same reasons — to block diagnosis and treatment — until a hefty licensing fee has been paid.

Such use of genetic patents impedes both research to combat disease as well as access to healthcare. Because of these kinds of manipulations, gene patents are beginning to meet with strong and vocal opposition.

Gene-patenting policies may endanger your health in other ways as well.

- ✔ When commercial outfits get genetic information, they treat it as their personal property. Gene sequences and experiment results therefore aren't always reported in the appropriate scientific literature (and thus, aren't subjected to review and verification by experts in the field). In order to market their products, these companies must go through the regulatory process mandated by the government to ensure consumer safety, but that regulatory review process has suffered noticeable shortcomings of late — particularly when products are allowed to pass muster while some conflict of interest is at work (think stock options, as was the case in shake-ups at the U.S. National Institutes of Health in 2005).
- ✔ Sadly, universities have gotten in on the act. In one instance, the search for the gene responsible for autism was held up because several universities refused to share information with, of all people, the parents of autistic children. Each university wanted to be the first to (you guessed it) patent the autism gene. As a result, an independent foundation was established to create a public repository for genetic information about autism because such actions are a direct assault on the openness of the scientific research itself.

The laws governing gene patents may change (and, perhaps, the sooner the better), but the current state of things makes me wonder if you or I will get hauled to court for patent infringement when it's discovered that one of our genes makes some potentially profitable enzyme.

Part V

The Part of Tens

The 5th Wave

By Rich Tennant

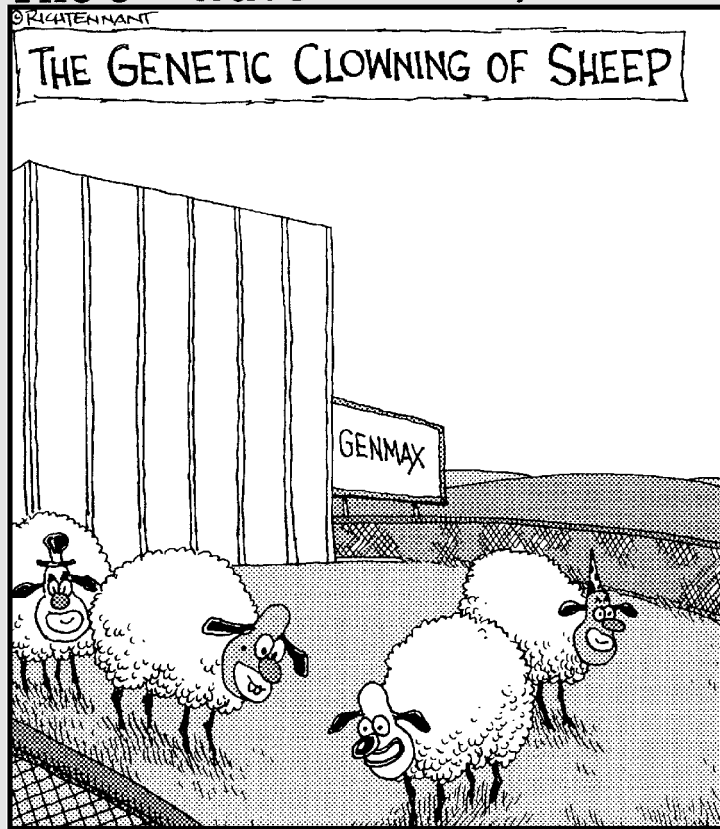

In this part . . .

Genetics is equal parts great history and amazing future. The discoveries of the past depended on the genius of many individuals. Likewise, the marvels of the future are shaped by teams of researchers and entrepreneurs.

This part exposes you to genetics' past and allows you to glimpse its future as well. I introduce you to the ten most important people and events that shaped what genetics is today, and I explain the next big things (or ten of them, at least) on the genetics horizon. Finally, I hook you up with some of the best Web sites the Internet has to offer to make your study of genetics that much easier.

Chapter 22

Ten Defining Events in Genetics

In This Chapter

- ▶ Appreciating the history of genetics
 - ▶ Highlighting the people behind great discoveries
-

Many milestones define the history of genetics. This chapter focuses on nine that aren't covered in other chapters of the book, plus one that is (the Human Genome Project is so important that it gets covered in Chapter 11 and here, too). The events listed here appear roughly in order of historical occurrence.

The Publication of Darwin's Origin of Species

Earthquakes have aftershocks, little mini-earthquakes that rattle around after the main quake. Events in history sometimes cause aftershocks, too. The publication of one man's life's work is one such event. From the moment it hit the shelves in 1856, Charles Darwin's *Origin of Species* was deeply controversial (and still is).

Darwin arrived at his conclusions after years of studying plants and animals all over the world. The concept of evolution is elegantly simple: Individual organisms vary in their ability to survive and reproduce. For example, a sudden cold snap occurs, and most individuals of a certain bird species die because they can't tolerate the rapid drop in temperature. But individuals of the same species that can tolerate the unexpected freeze survive and reproduce. As long as the ability to deal with rapid temperature drops is heritable, the trait is passed to future generations, and more and more individuals inherit the trait. When groups of individuals are isolated from each other, they wind up being subjected to different sorts of events (such as weather patterns). After many, many years, stepwise changes in the sorts of traits that are inherited based on events like a sudden freeze accumulate to the point that populations with common ancestors become separate species. Darwin concluded that all life on earth is related by inheritance in this fashion and thus has a common origin.

What Darwin lacked was a convincing explanation for how advantageous traits are inherited. Yet, the explanation was literally at his fingertips. Mendel figured out the laws of inheritance at about the same time that Darwin was working on his book (see Chapter 3). Apparently, Darwin failed to read Mendel's paper — he scrawled notes on the papers immediately preceding and following Mendel's paper but left Mendel's unmarked. There's no evidence from Darwin's copious notes that he was even aware of Mendel's work.

Even without knowledge of how inheritance works, Darwin accurately summarized three principles that are confirmed by genetics:

- ✔ **Variation is random and unpredictable.** This principle is confirmed by studies of mutation (see Chapter 13).
- ✔ **Variation is *heritable* (can be passed on from one generation to the next).** Mendel's own research — and thousands of studies over the past century — confirms heritability. With DNA fingerprinting, heritable genetic variation can be traced directly from parent to offspring (see Chapter 18 for how paternity tests use heritable genetic markers to determine which male fathered which child).
- ✔ **Variation changes in frequency over the course of time.** Hardy's and Weinberg's principle formalized this concept in the form of population genetics in the early 1900s (see Chapter 17). Since the 1970s, genetic studies using DNA sequencing (along with other methods) have confirmed that genetic variation within populations changes due to mutation, accidents, and geographic isolation, to name only a few causes.

Regardless of how you view it, the publication of Darwin's *Origin of Species* is pivotal in the history of genetics — and vice versa. Variation is the heart and soul of both disciplines. If no genetic variation existed, all life on earth would be precisely identical; variation gives the world its rich texture and complexity. And it's what makes you wonderfully unique.

The Rediscovery of Mendel's Work

In 1866, Gregor Mendel wrote a summary of the results of his gardening experiments with peas (detailed in Chapter 3). His work was published in the scientific journal, *Versuche Pflanzen Hybriden*, where it gathered dust for nearly 40 years. Although Mendel wasn't big on self-promotion, he sent copies of his paper to two well-known scientists of his time. One copy remains missing; the other was found in what amounts to an unopened envelope — the pages were never cut. (Old printing practices resulted in pages being folded together; the only way to read the paper was to cut the pages apart.) Thus, despite the fact that his findings were published and

distributed (though limitedly), no one grasped the magnitude of Mendel's discovery (not even Darwin read it!). Mendel's work went unnoticed until three botanists, Hugo de Vries, Erich von Tschermak, and Carl Correns, all re-invented Mendel's wheel, so to speak.

These three men conducted experiments that were very similar to Mendel's. Their conclusions were identical — all three “discovered” the laws of heredity. Hugo de Vries found Mendel's work referenced in a paper published in 1881. (De Vries coined the term *mutation*, by the way.) The author of the 1881 paper, a man by the unfortunate name of Focke, summarized Mendel's findings but didn't have a clue as to what they meant. De Vries correctly interpreted Mendel's work and cited it in his own paper, which was published in 1900. Shortly thereafter, Tschermak and Correns also discovered Mendel's publication through De Vries's published works and indicated that their own independent findings confirmed Mendel's conclusions as well.

William Bateson is perhaps the great hero of this story. He was already incredibly influential by the time he read De Vries's paper citing Mendel, and unlike many around him, he recognized that Mendel's laws of inheritance were revolutionary and absolutely correct. Bateson became an ardent voice spreading the word. He coined the terms *genetics*, *allele* (shortened from the original *allelomorph*), *homozygote*, and *heterozygote*. Bateson was also responsible for the discovery of linkage (see Chapter 4), which was experimentally confirmed later by Morgan and Bridges.

The Transforming Principle

Frederick Griffith wasn't working to discover DNA. The year was 1928, and the memory of the deadly flu epidemic of 1918 was still fresh in everyone's minds. Griffith was studying pneumonia in an effort to prevent future epidemics. He was particularly interested in why some strains of bacteria caused illness and other seemingly identical strains did not. To get to the bottom of the issue, he conducted a series of experiments using two strains of the same species of bacteria, *Streptococcus pneumoniae*. The two strains looked very different when grown in a Petri dish because one was smooth and the other lumpy (he called it “rough”). When Griffith injected smooth bacteria into mice, they died; rough bacteria, on the other hand, was harmless.

To figure out why one strain of bacteria was deadly and the other harmless, Griffith conducted a series of experiments. He injected some mice with heat-killed smooth bacteria (which turned out to be harmless) and others with heat-killed smooth in combination with living rough bacteria. This combo proved deadly to the mice. Griffith quickly figured out that something in the smooth bacteria *transformed* rough bacteria into a killer. But what? For lack of anything better, he called the responsible factor the *transforming principle* (which now sounds like a good title for a diet book).

Oswald Avery, Maclyn McCarty, and Colin MacLeod teamed up in the 1940s to discover that Griffith's transforming principle was actually DNA. This trio made the discovery by a dogged process of elimination. They showed that fats and proteins didn't do the trick; only the DNA of smooth bacteria provided live rough bacteria with the needed ingredient to get nasty. Their results were published in 1944, and like Mendel's work nearly a century before, were largely rejected. It wasn't until Erwin Chargaff came along that the transforming principle started to get the appreciation it deserved. Chargaff was so impressed that he changed his entire research focus to DNA. Chargaff eventually determined the ratios of bases in DNA that helped lead to Watson and Crick's momentous discovery of DNA's double helix structure (flip back to Chapter 6 for all the details).

The Discovery of Jumping Genes

By all accounts, Barbara McClintock was both brilliant and a little odd. She lived and worked alone for most of her life. Her career began in the early 1930s and took her into a man's world — very few women worked in the sciences in her day. McClintock was unorthodox in both her research and her outlook; a friend once described her as “not fooled or foolable.”

In 1931, McClintock worked with another woman, Harriet Creighton, to demonstrate that genes are located on chromosomes. This fact sounds so self-evident now, but back then, it was a revolutionary idea. Creighton and McClintock showed that corn chromosomes recombined during meiosis (see Chapter 2 for the scoop on meiosis). By tracking the inheritance of various traits, they figured out which genes were getting moved during translocation events (see Chapter 15). Translocations hook up chunks of chromosomes in places where they don't belong. Chromosomes with translocations look very different from normal chromosomes, making it easy to track their inheritance. By linking physical traits to certain parts of one odd-looking chromosome, Creighton and McClintock demonstrated that crossover events between chromosomes moved genes from one chromosome to another.

McClintock's contribution to genetics goes beyond locating genes on chromosomes, though. She also discovered traveling bits of DNA, sometimes known as jumping genes (see Chapter 10 for more). In 1948, McClintock, working independently, published her results demonstrating that certain genes of corn could hop around from one chromosome to another *without* translocation. Her announcement triggered little reaction at first. It's not that people thought McClintock was wrong, she was just so far ahead of the curve that her fellow geneticists couldn't understand her findings. Alfred Sturtevant (who was responsible for the discovery of gene mapping) once said, “I didn't understand one word she said, but if she says it is so, it must be so!” It took

nearly 40 years before the genetics world caught up with Barbara McClintock and awarded her the Nobel Prize for Medicine in 1983. By then, jumping genes had been discovered in many organisms (including humans). Feisty to the end, this grand dame of genetics passed away in 1992 at the age of 90.

The Birth of DNA Sequencing

So many events in the history of genetics lay a foundation for other events to follow. Federick Sanger's invention of chain-reaction DNA sequencing (explained in Chapter 11) is one of those foundational events. In 1980, Sanger shared his second Nobel Prize (in Chemistry) with Walter Gilbert for their work on DNA. Sanger had already earned a Nobel Prize in Chemistry in 1958 for his pioneering work on the structure of the protein insulin. (Insulin is produced by your pancreas and regulates blood sugar; its absence is the cause of diabetes.)

Sanger figured out the entire process used for DNA sequencing. Every single genetics project that has anything to do with DNA uses Sanger's method. *Chain-reaction sequencing*, as Sanger's method is called, uses the same mechanics as replication in your cells (see Chapter 7 for a rundown of replication). Sanger figured out that he could control the DNA building process by snipping off one oxygen molecule from the building blocks of DNA. The resulting method allows identification of every base, in order, along a DNA strand, sparking a revolution in the understanding of how your genes work. This process is responsible for the Human Genome Project, DNA fingerprinting (see Chapter 18), genetic engineering (see Chapter 19), and gene therapy (see Chapter 16).

The Invention of PCR

In 1985, while driving along a California highway in the middle of the night, Kary Mullis had a brainstorm about how to carry out DNA replication in a tube (see Chapter 7 for the scoop on replication). His idea led to the invention of *polymerase chain reaction* (PCR), a pivotal point in the history of genetics.

The entire process of how PCR is used in DNA fingerprinting is detailed in Chapter 18. In essence, PCR acts like a copier for DNA. Even the tiniest snippet of DNA can be copied. This concept is important because, so far, technology isn't sophisticated enough to examine one DNA molecule at a time. Many copies of the same molecule are needed before enough is present to be detected and studied. Without PCR, large amounts of DNA are needed to generate a DNA fingerprint, but at many crime scenes, only tiny amounts of DNA are present. PCR is the powerful tool now used in every crime lab in the country to detect the DNA left behind at crime scenes and to generate DNA fingerprints.

Mullis's bright idea turned into a billion dollar industry. Although he reportedly was paid a paltry \$10,000 for his invention, he received the Nobel Prize for Chemistry in 1993 (a sort of consolation prize).

The Development of Recombinant DNA Technology

In 1970, Hamilton O. Smith discovered *restriction enzymes*, which act as chemical cleavers to chop DNA into pieces at very specific points. As part of other research, Smith put bacteria and a bacteria-attacking virus together. The bacteria didn't go down without a fight — instead, it produced an enzyme that chopped the viral DNA into pieces, effectively destroying the invading virus altogether. Smith determined that the enzyme, now known as Hind II (named for the bacteria *Haemophilus influenzae Rd*), cuts DNA every time it finds certain bases all in a row and cuts between the same two bases every time.

This fortuitous (and completely accidental!) discovery was just what was needed to spark a revolution in the study of DNA. Some restriction enzymes make offset cuts in DNA, leaving single-stranded ends. The single-strand bits of DNA allow geneticists to “cut-and-paste” pieces of DNA together in novel ways, forming the entire basis of what is now known as *recombinant DNA technology*. Gene therapy (see Chapter 16), the creation of genetically engineered organisms (see Chapter 19), and practically every other advance in the field of genetics these days all depend on the ability to cut DNA into pieces without disabling the genes and then put the genes into new places — a feat made possible thanks to restriction enzymes.

Today, about 3,000 restriction enzymes are being used to help map genes on chromosomes, determine the function of genes, and manipulate DNA for diagnosis and treatment of disease. Smith shared the Nobel Prize in Physiology or Medicine in 1978 with two other geneticists, Dan Nathans and Werner Arber, for their joint contributions to the discovery of restriction enzymes.

The Invention of DNA Fingerprinting

Sir Alec Jeffreys has put thousands of wrongdoers behind bars. Almost single-handedly, he's also set hundreds of innocent people free from prison. Not bad for a guy who spends most of his time in the genetics lab. Jeffreys invented DNA fingerprinting in 1985. By examining the patterns made by human DNA after it was diced up by restriction enzymes, Jeffreys realized that every person's DNA produces a slightly different number of various sized fragments (which number in the thousands).

Jeffreys's invention has seen a number of refinements since its inception. PCR and the use of STRs (short tandem repeats; see Chapter 18) have replaced the use of restriction enzymes. Modern methods of DNA fingerprinting are highly repeatable and extremely accurate, meaning that a DNA fingerprint can be stored much like a fingerprint impression from your fingertip can. More than 100 laboratories in the United States alone now make use of the methods pioneered by Jeffreys. The information generated by these labs is housed in a huge database hosted by the FBI, granting any police department quick access to information that can help match criminals to crimes.

In 1994, Queen Elizabeth II knighted Jeffreys for his contributions to law enforcement and his accomplishments in genetics.

The Explanation of Developmental Genetics

As I explain in Chapter 11, every cell in your body has a full set of genetic instructions to make all of you. The master plan of how an entire organism is built from genetic instructions remained a mystery until 1980, when Christiane Nüsslein-Volhard and Eric Wieschaus identified the genes that control the whole body plan during fly development.

Fruit flies and other insects are constructed of interlocking pieces, or segments. A group of genes (collectively called *segmentation genes*) tell the cells which body segments go where. These genes, along with others, give directions like top and bottom and front and back as well as the order of body regions in between. Nüsslein-Volhard and Wieschaus made their discovery by mutating genes and looking for the effects of the “broken” genes. When segmentation genes get mutated, the fly ends up lacking whole sections of important body parts or certain pairs of organs.

A whole different set of genes (called *homeotic genes*) control the placement of all the fly's organs and appendages, such as wings, legs, eyes, and so on. One such gene is *eyeless*. Contrary to what would seem logical, *eyeless* actually codes for normal eye development. Using the same recombinant DNA techniques made possible by restriction enzymes (see the section “The Development of Recombinant DNA Technology” earlier in this chapter), Nüsslein-Volhard and Wieschaus moved *eyeless* to different chromosomes where it could be turned on in cells in which it was normally turned off. The resulting flies grew eyes in all sorts of strange locations — on their wings, legs, butts, you name it. This research showed that, working together, segmentation and homeotic genes put all the parts in all the right places. Humans have versions of these genes, too; your body-plan genes were discovered by comparing fruit fly genes to human DNA (see Chapter 11 for how the genomes of organisms affect you).

The Work of Francis Collins and the Human Genome Project

In 1989, Francis Collins and Lap-Chee Tsui identified the single gene responsible for cystic fibrosis. The very next year, the Human Genome Project (HGP) officially got underway. A double-doctor (that is, a doc with an MD and PhD), Collins later replaced James Watson as the head the National Human Genome Research Institute in the United States and supervised the race to sequence the entire human genome from start to finish.

Collins is one of the true heroes of modern genetics. He kept the HGP ahead of schedule and under budget. He continues to champion the right to free access to all the HGP data, making him a courageous opponent of gene patents and other practices that restrict access to discovery and healthcare, and he's a staunch defender of genetic privacy (see Chapter 21 for more on these subjects). Although the human genome is still bits and pieces away from being fully and completely sequenced, the project wouldn't have been a success without the tireless work of Dr. Collins. Still an active gene hunter, his lab is now searching out the genes responsible for adult-onset diabetes.

Chapter 23

Ten of the Hottest Issues in Genetics

In This Chapter

- ▶ Following changes in genetics
 - ▶ Keeping an eye out for the next big things
-

Genetics is a field that grows and changes with every passing day. The hottest journals in the field (*Nature* and *Science*) are full of new discoveries each and every week. This chapter shines the spotlight on ten of the hottest topics and next big things in this ever-changing scientific landscape.

Pharmacogenomics

The fourth biggest cause of death in the United States is adverse reactions to medications. Up to 100,000 people die each year from something that's meant to help them. Why? The tool being used to answer that question is *pharmacogenomics*, the analysis of the human genome and heredity to determine how drugs work in individual people. The idea is that the reason certain people have adverse reactions and others don't lies somewhere in their DNA. If a simple test could be developed to detect these DNA differences, the wrong drugs would never be prescribed in the first place. (Oddly, this idea sometimes doesn't go over well with drug companies; for more on the connection between the two, check out Chapter 21.) The overarching goal of pharmacogenomics is a new brand of highly personalized medicine that can be designed to fit the unique genetic makeup of each individual patient.

That's the good news. The bad news is that nobody knows how many genes are involved in drug reactions, and most of the genes that *are* involved haven't even been discovered yet. And there are some ticklish privacy issues that have to be addressed, too (flip back to Chapter 21). So, pharmacogenomics may get a lot of attention, but tailor-made meds are still a long way off.

Stem Cell Research

Stem cells may hold the key to curing brain and spinal cord injuries. They may be part of the cure for cancer. These little wonders may be *the* magic bullet to solving all sorts of medical problems, but they're at the center of controversies so big that their potential remains untested. Stem cells are hot research topics because they're *totipotent*. Totipotence means that stem cells can turn into any kind of tissue, from brain to muscle to bone, just to name a few. Not too surprisingly, stem cells are what undifferentiated embryos are made of; that is, a fertilized egg, shortly after it starts dividing, is composed entirely of stem cells. At a certain point during development, all the cells get their assignments ("You, you're going to be an eye!"), and totipotence is long gone (except for DNA, which retains surprising flexibility — DNA's totipotence is what allows cloning to work; see Chapter 20).

You've probably guessed (or already knew) that the source of stem cells for research is embryonic tissue — and therein lies the rub. As of this writing, researchers haven't found a way to harvest stem cells without sacrificing the embryo in the process. Stem cells can be collected from adults (these stem cells are found in various places, including your blood), but adult stem cells lack some of the totipotent potential of embryonic cells and are present in very low numbers. The lack of totipotence and low copy numbers make using adult stem cells problematic. Nonetheless, adult stem cells may work better than embryonic ones for therapeutic purposes because they can be harvested from the patient in question, modified, and returned to the patient, eliminating the chance of tissue rejection. (For the lowdown on gene therapy, see Chapter 16.) A potential compromise may come from collecting the cells from an umbilical cord after a child is born; these cells are better than adult stem cells. Stem cells in one form or another may find their way into modern medicine, but for now, moral and ethical opposition to the use of embryonic cells stymies stem cell research because most of it depends on the use of embryonic tissues.

Genetics of Aging

Aging is not for the timid. Skin sags, hair turns gray, joints hurt. Sounds like fun, doesn't it? The effects may be obvious, but the process of *senescence* (the fancy term for aging) is still quite a mystery. Scientists know that the ends of your chromosomes (known as telomeres) sometimes get shorter as you get older (see Chapter 7), but they aren't sure that those changes are what make old folks old. What is known is that when telomeres get too short, cells die, and cell death is clearly part of the aging process.

The enzyme that can prevent telomeres from shortening, telomerase (see Chapter 7 for telomerase's role in preserving chromosome length during replication), seems an obvious target for anti-aging research. Cells that have active telomerase don't die because of shortened telomeres. For instance, cancer cells often have active telomerase when normal cells don't; telomerase activity contributes to the unwanted longevity that cancer cells enjoy (flip back to Chapter 14 for the details). If geneticists can get a handle on telomerase — turning it on where it's wanted without causing cancer — aging may become controllable.

In addition, geneticists have learned that old cells perk up when put in the company of younger cells. This finding indicates that cells have plenty of capacity to regenerate themselves — they just need a little incentive. Another recent study suggests that calorie restriction in a person's diet also helps defer the effects of aging. Researchers found that when mice were put on a calorie-restricted diet, a gene kicked in to slow programmed cell death (called *apoptosis*, see Chapter 14).

There's a very high demand for new information on how to prevent aging. If keeping young turns out to be as simple as spending time with younger people and eating less, aging may be a lot more fun than it seems.

Proteomics

Genomics, the study of whole genomes, will soon have to make room for the next big thing: *proteomics*, the study of all the proteins an organism makes. Proteins do all the work of your body. They carry out all the functions that genes encode, so when a gene mutation occurs, the protein is what winds up being altered (or goes missing altogether). Given the link between genes and proteins, the study of proteins may end up telling researchers more about genes than the genes themselves!

Proteins are three-dimensional (see Chapter 9 for an explanation). Not only do proteins get folded into complex shapes, but also they get hooked up with other proteins and decorated with other elements such as metals. (Take a look at Chapter 9 for more about how proteins get modified from plain amino acid chains to get gussied up to do their jobs.) Currently, scientists can't just look at a protein and tell what its function is. When it's finally possible to decode them, though, proteins will be a big deal in the fields of medical drugs and treatments because medications act upon the proteins in your system.

Cataloging all the proteins in your proteome isn't going to be easy because every tissue has to be sampled to find them all, but microarray systems (see "Gene Chips" later in this chapter) to detect proteins are on the way to speed

up the proteome inventory process. Nonetheless, the rewards in discovery of new drugs and treatments for previously untreatable diseases will make the effort worthwhile.

Bioinformatics

You live in the information age, with practically everything you need at your fingertips. But where genetics is concerned, it's the information overflow age — thousands and thousands of DNA sequences, gobs of proteins, tons of data. It's hard to know where to start or how to sort through the mountains of chatter to get to the real messages. Never fear! *Bioinformatics For Dummies* is here! (I'm not kidding. It's a real *For Dummies* title. For specifics, check out www.dummies.com.)



Bioinformatics is the process of using a computer to sort through massive biological databases. Anyone with an Internet connection can access these databases with the click of a mouse (surf to www.ncbi.nlm.nih.gov to reach the National Center for Biotechnology Information). Hop online, and you can search all the results of the entire Human Genome Project for yourself, check out the latest gene maps, and look up anything about any disease that has a genetic basis (see Chapter 24 for info on the Mendelian Inheritance in Man for genetic diseases in humans).

Not only that, but bioinformatics gives you ready access to powerful analysis tools — the kind the pros use. Gene hunters use these tools to compare their human DNA sequences with those found in other animals (see Chapter 11 for a rundown of critters whose DNA has been sequenced). As one of the next big things in genetics, bioinformatics provides the tools needed to catalog, keep track of, and analyze all the data generated by geneticists the world over. This data is then used for all the applications covered in this book — from genetic counseling to cloning and beyond.

Nanotechnology

I have to admit that nanotechnology sounds like science fiction to me. It's the high-tech development of the super tiny, like tinier than microscopic . . . atomic tiny. One proposed use for this technology is rapid screening of your genes for mutations that may cause cancer or for prenatal diagnosis of genetic disorders. Here's how it could work: A bar code would be etched on nanoparticles of gold. The gold particles would then be attached to bits of DNA that hook up with, say, mRNAs (messenger RNAs; see Chapter 9 for details) that were harvested from your cells. A lab tech would then pass a bar code reader, albeit a really

fancy one (not like the one at your local grocery store) over the mix, and the test would be done. Faulty mRNAs transcribed from mutated genes would register on the bar code reader while unmutated genes would pass unnoticed. Another nanotechnology idea in the works is an amazing new cancer treatment. In the treatment, cancer-fighting nanoparticles are delivered by injection and work their ways into cancer cells. After the particles are in the cells, a magnet is scanned over the tumor site. The nanoparticles inside the cancer cells heat up in response to the magnet and effectively cook the tumor from the inside out.

Nanotechnology isn't without its critics or problems. One recent study found that nanoparticles caused brain damage in some fish, and some of the materials used for nanoparticles are toxic. However, nanotechnology faces another, less high-tech challenge: Patent applications are bogged down because the industry has outpaced the patent office's ability to evaluate it. Tiny or not, nanotechnology is worth paying attention to.

Gene Chips

One of the most useful new developments in genetics is the gene chip. Also known as *microarrays*, gene chips allow researchers to determine quickly which genes are at work (that is, being expressed) in a given cell (see Chapter 10 for a full rundown on how your genes do their jobs). Gene expression depends on messenger RNA (mRNA), which is produced through transcription (see Chapter 8). The mRNAs get tidied up and sent out into the cell cytoplasm to be translated into proteins (see Chapter 9 for how translation works to make proteins). The various mRNAs present in each cell tell how many and exactly which of the thousands of genes are at work at any given moment. In addition, the number of copies of each mRNA conveys an index of the strength of gene expression (see Chapter 10 for more on gene expression). The more copies of a particular mRNA, the stronger the action of the gene that produced it.

Gene chips are grids composed of bits of DNA that are complementary to the mRNAs the geneticist expects to find in a cell (the method used to detect the mRNAs in the first place is explained in Chapter 16). The bits of DNA are glued to a glass slide. All the mRNAs from a cell are passed over the gene chip, and the mRNAs bind to their DNA complements on the slide. Geneticists measure how many copies of a given mRNA attach themselves to any given spot on the slide to determine not only which genes are active but also the strength of their activities. Gene chips are relatively inexpensive to make and can each test hundreds of different mRNAs, making them a valuable tool for gene discovery and mapping. Microarrays are also being used to rapidly screen thousands of genes to pick up on mutations that cause diseases. One way this screening is done is by comparing mRNAs from normal cells to those from

diseased cells (such as cancer). By comparing the genes that are turned on or off in the two cell types, geneticists can determine what's gone wrong and how the disease might be treated.

Evolution of Antibiotic Resistance

Unfortunately, not all “next big things” are good. Antibiotics are used to fight diseases caused by bacteria. When penicillin (a common antibiotic) was developed, it was a wonder drug that saved thousands and thousands of lives. However, many antibiotics are nearly useless now due to the evolution of antibiotic resistance. Bacteria don't have sex, but they still pass their genes around. They achieve this feat by passing around little circular bits of DNA called *plasmids*. Almost any species of bacteria can pass its plasmids on to any other species. Thus, when bacteria resistant to a particular antibiotic run into bacteria that aren't resistant, the exchange of plasmids endows the formerly susceptible bacteria with antibiotic resistance. Antibacterial soaps and the misuse of antibiotics make the situation worse by killing off all the non-resistant bacteria, leaving only the resistant kind behind.

Not only are antibiotic-resistant bacteria showing up in hospitals, they're popping up in natural environments as well. Farmers, in an effort to keep their animals free from disease, pump them full of antibiotics. Thus, antibiotic-resistant bacteria abound in farm sewage; eventually the run-off ends up in lakes, streams, and rivers that provide drinking water for humans. Many of those bacteria cause human diseases, and because they start off as antibiotic-resistant bacteria, treating illnesses caused by them is difficult. Meanwhile, scientists work to develop new, more powerful antibiotics in an effort to stay one step ahead of the bacteria.

Genetics of Infectious Disease

I'm guessing that you're too young to remember the flu epidemic of 1918 (I certainly am!). My aunt, who was a schoolteacher in 1918, told me that half the students at her tiny, rural Louisiana school died along with the school's other teacher. All told, 20 million people worldwide died of the flu in that horrific epidemic. The virus was so deadly that people caught it in the morning and died the same day! It's still not known what made that influenza so very nasty, but one thing is clear: It started as a bird flu.

The phrase “bird flu” may sound familiar to you because a particularly nasty variety of it lurks in Southeast Asia and surfaces occasionally. Bird flu doesn't appear to bother the chickens that carry it. Humans who contract it, on the other hand, get very ill and may even die of the disease. The difference in human and chicken susceptibility may come from a protein that the virus

makes on its outside surface. In humans, the viral proteins make the virus stick to your cells like a burr, giving it access to the inside of your cells and thus the ability to cause rapid infection. Chicken cells just shrug the virus off.

People catch bird flu by living in very close contact with domestic fowl — a common practice in many parts of the world. The 1918 flu spread from Europe to other countries when ill but symptom-free people traveled from between countries. With modern air travel, someone with the bird flu can show up just about anywhere, bringing the potentially deadly disease with him.

Scientists are racing to understand the genetics of highly virulent diseases like bird flu in order to combat their effects. In the case of bird flu, vaccines for birds are in the works, but significant roadblocks exist; most countries in Asia have no vaccination programs, and others refuse to import vaccinated birds. Not only that, but chickens and ducks number in the millions, and vaccinating them all (not to mention finding them all) is a daunting prospect. The World Health Organization released warnings in early 2005 that a world pandemic of the bird flu (think epidemic but much worse) may be imminent. Coupled with a shortage of human flu vaccine in the fall of 2004, the risk of another scary epidemic is very real.

Bioterrorism

After September 11, 2001, terrorism moved to the forefront of many people's minds. Hot on the heels of the disaster in New York City was another threat in the form of anthrax-laced letters. (Anthrax is a disease caused by a soil bacteria that's very deadly to humans.) Opening junk mail in the United States went from merely annoying to potentially threatening. Anthrax and other infectious organisms are potential weapons that could be used by terrorists — a form of warfare called *bioterror*. Suddenly, the researchers working on anthrax genetics, people who had toiled away in underfunded obscurity, were national treasures. U.S. government spending on efforts to counter the bioterror threat shot up and has stayed high. Proponents say that nearly \$5 billion will be spent on the development of new vaccines and drugs to treat potential biological weapons in 2006. At least some of the money is earmarked to complete genome sequencing for pathogens like Ebola. The insights gained from this research will spill over, advocates say, to other diseases.

Critics counter the push for anti-bioterror research with arguments that overfunding biodefense means that many important and more immediate problems go unsolved. Furthermore, the bad guys may not even have the technology needed to make the sophisticated biological weapons that big money is spent to counter. Meanwhile, new regulations make research harder to conduct. Scientists can no longer easily exchange biological samples, meaning that the experts can't get the research materials they need to do their work.

Chapter 24

Ten Terrific Genetics Web Sites

In This Chapter

- ▶ Exploring genetics using the Internet
-

The Internet is an unparalleled source of information about genetics. With just a few mouse clicks, you can find the latest discoveries and attend the best courses ever offered on the subject. This chapter provides you with a sample of the best Web sites available on the subject of genetics. (There's just so much information out there that I had to throw in an extra site.)

Cell Division

www.pbs.org/wgbh/nova/miracle/divide.html

The basic cell biology of mitosis and meiosis is an essential part of how genes are inherited as part of chromosomes (flip to Chapter 2 for the full scoop). This Web site from the PBS (Public Broadcasting Service) series *Nova* provides a very cool and very clear comparison of the two processes. You see mitosis and meiosis occurring side-by-side as animated chromosomes sort themselves out along the equator of each cell. If you backtrack a bit from this material to the main site for the *Nova* program, "Life's Greatest Miracle" (www.pbs.org/wgbh/nova/miracle), which traces human development from embryo to birth, you can actually watch the broadcast online and find information on prenatal tests, sex determination, and stem-cell research.

Mendelian Genetics

www.biology.arizona.edu

The Biology Project Web site provides you with many opportunities to build your knowledge of genetics. The Mendelian material here provides valuable

assistance with solving basic genetics problems. The site includes excellent material on cell biology, biochemistry, human biology, and molecular genetics as well. One of this site's greatest strengths is that it's multi-lingual — Spanish, Italian, and Portuguese translations are offered for several links.

General Genetics Education

gslc.genetics.utah.edu

This site is aimed at kids and covers a wide variety of topics, including genetic counseling (see Chapter 12), gene therapy (which I cover in Chapter 16), and cloning (see Chapter 20). Although some of the site's animations are a bit on the juvenile side, the explanations are clear and accurate.

The Human Genome Project and Beyond

www.doegenomes.org

This Web site, maintained by the U.S. Department of Energy (DOE), profiles the Human Genome Project. The recently completed Human Genome Project allowed geneticists to learn the order of the four bases (C, G, A, and T) that make up human DNA. The order of bases is important because it's the key to the building plans (otherwise known as the genes) written within your DNA. The DOE human genome Web site provides an in-depth history of the project and its milestones, goals, and results. (Flip to Chapter 11 for full coverage of this topic.) The Genomics Primer is especially informative and is packed with summaries of the project's results to date.

Genes We Share with Other Organisms

www.hhmi.org/genesweshare

This award-winning Web site hosted by the Howard Hughes Medical Institute highlights the findings of some of the various sequencing projects I profile in Chapter 11. On this site, you can explore the genetic secrets of several model organisms including fruit flies, roundworms, yeast, and mice.

The Latest News

www.genomenewsnetwork.com

The Genome News Network provides smart and extremely well-written coverage of all the latest findings in the world of genetics. The search engine at this address can lead you to specific topics of interest, but this is a site that supports a lot of surfing. For example, skimming the list of Genomes of the World allows you to find out about every single organism whose genome has been sequenced thus far. The GNN news articles are truly outstanding. And be sure to check out the section Weird Science; the coolest findings in the world of genetics can be found here. For instance, contrary to the notion that black cats are bad luck, the mutation that gives cats black fur may also confer immunity to some diseases! This site is sponsored by the J. Craig Venter Institute; Craig Venter was one of the scientists responsible for the successful completion of the Human Genome Project. (See Chapter 11 for more on this project.)

Genetic Disorders in Humans

www.ncbi.nlm.nih.gov/entrez/query.fcgi?db=OMIM

The Online Mendelian Inheritance in Man site provides a powerful search engine to help you locate information on every single genetic disorder and trait documented in humans. For example, if you type “eye color” in the Search OMIM box, you get an exhaustive list of links to further explanations of every gene identified with anything to do with the inheritance of eye color. By following the Map Locus link on each information page, you can see a schematic of the exact location of each gene on a chromosome map. For example, brown eyes and brown hair are mapped to the same gene on human chromosome number 15. This site is a particularly valuable resource for following up on any disorder caused by mutation (see Chapter 13).

Careers in Genetics

www.kumc.edu/gec/geneinfo.html

The University of Kansas Medical Center provides this very comprehensive list of clinical, research, and educational resources for genetic counselors, clinical geneticists, and medical geneticists. A dizzying array of links is presented

including career opportunities in human genetics and a long list of forensic genetics resources (follow the Education Center link). While touted as a resource for professionals, this site has something for everyone; it's an amazing, exhaustive gateway to genetic resources on the Web.

Pet Genetics

www.workingdogs.com/genetics.htm

www.cat-world.com.au/Genetics.htm

I had a really tough time choosing just one site on dog genetics, but the one listed here is good because it leads you to so much more information on the topic. When you get to the Working Dogs page, follow the link to the Canine Diversity Project for Dr. John Armstrong's outstanding explanation about the need for genetic diversity in canine breeding programs. Also useful, the link to the University of California-Davis Veterinary Genetics Program provides a gateway to information on a variety of species including cats, and from the UC-Davis page, if you follow the Companion Animal Research and Development link, you can find out more about the program's outstanding dog genetics research group.

When it comes to cats and genetics, the Aussie link given here provides access to all things feline, not just the kitties in the land down under. This site covers every imaginable feature of cats including coat and eye color, behavior, and various sex-linked disorders peculiar to cats. Bottom line: It's an excellent resource for anyone curious about cats and their genetics.

The Latest Discoveries

www.nature.com/news/index.html

Each week, the journal *Nature* publishes the most recent and most important research findings from laboratories all over the world. A companion site hosted by Nature Publishing Group, called News @ Nature, covers all things scientific, not just genetics, in everyday language. Follow the Stories by Subject link to find all the genetics information in one place. The section In Focus features in-depth coverage of recent events or findings along with links to related articles. Most of the content on this Web site is free, but some information is available by subscription only.

Glossary

adenine: *Purine base* found in *DNA* and *RNA*.

allele: Alternative form of a *gene*.

amino acid: Unit composed of an amino group, a carboxyl group, and a radical group; amino acids link together in chains to form *polypeptides*.

anaphase: Stage of cell division in *mitosis* when replicated *chromosomes* (as *chromatids*) separate. In *meiosis*, *homologous chromosomes* separate during anaphase I, and replicated chromosomes (as chromatids) separate during anaphase II.

aneuploidy: Increase or decrease in the number of *chromosomes*; a deviation from an exact multiple of the *haploid* number of chromosomes.

anticipation: Increasing severity or decreasing age of onset of a genetic trait or disorder with succeeding generations.

anticodon: The three *nucleotides* in a tRNA (transfer RNA) *complementary* to a corresponding *codon* of mRNA.

antiparallel: Parallel but running in opposite directions; orientation of two *complementary* strands of *DNA*.

apoptosis: The normal process of regulated cell death.

autosome: A nonsex *chromosome*.

backcross: Cross between an individual with an *F1 genotype* and an individual with one of the parental (*P*) genotypes.

bacteriophage: A virus that infects bacterial cells.

base: One of the three components of a *nucleotide*. Four bases are found in *DNA* and *RNA*.

cell cycle: The repeated process of cell growth, *DNA replication*, *mitosis*, and *cytokinesis*.

centromere: The region at the center of a *chromosome* that appears pinched during *metaphase*; where spindle fibers attach during *mitosis* and *meiosis*.

chromatid: One half of a replicated *chromosome*.

chromosome: Linear or circular strand of *DNA* that contains *genes*.

codominance: When *heterozygotes* express both *alleles* equally.

codon: Combination of three *nucleotides* in an mRNA that correspond to an *amino acid*.

complementary: Specific matching of base pairs in *DNA* or *RNA*.

consanguineous: Mating by related individuals.

crossing-over: Equal exchange of *DNA* between *homologous chromosomes* during *meiosis*.

cytokinesis: Cell division.

cytosine: A *pyrimidine* base found in *DNA* and *RNA*.

DNA: Deoxyribonucleic acid; the molecule that carries genetic information.

dNTP: Deoxyribonucleotide; the basic building block of *DNA* used during DNA *replication* consisting of a deoxyribose sugar, three phosphate molecules, and one of four nitrogenous bases.

ddNTP: Dideoxyribonucleotide; identical to

dNTP but lacking an oxygen at the 3' site. Used in DNA sequencing.

deamination: When a *base* loses an *amino group*.

degenerate: A property of the genetic code whereby some *amino acids* are encoded by more than one *codon*.

deletion: Mutation resulting in the loss of one or more *nucleotides* from a *DNA* sequence.

denaturation: Melting bonds between *DNA* strands, thereby separating the double helix into single strands.

depurination: When a *nucleotide* loses a *purine base*.

dihybrid cross: Cross between two individuals who differ at two traits or *loci*.

diploid: Possessing two copies of each *chromosome*.

dominant: A *phenotype* or *allele* that completely masks another allele. The phenotype exhibited by both *homozygotes* and *heterozygotes* carrying a dominant allele.

epistasis: *Gene* interaction in which one gene hides the action of another.

eukaryote: An organism with a complex cell structure and a cell nucleus.

euploid: An organism possessing an exact multiple of the **haploid** number of **chromosomes**.

exon: The coding part of a **gene**.

expressivity: Variation in the strength of traits.

F1 generation: The first generation offspring of a specific cross.

F2 generation: Offspring of the F1 generation.

gamete: Reproductive cell; sperm or egg cell.

gene: Fundamental unit of heredity. A specific section of **DNA** within a **chromosome**.

genome: A full set of **chromosomes** carried by a particular organism.

genotype: The genetic makeup of an individual. The **allele(s)** possessed at a given **locus**.

guanine: **Purine base** found in **DNA** and **RNA**.

gyrase: Enzyme that acts during **DNA replication** to prevent tangles from forming in the DNA strand.

haploid: Possessing one copy of each **chromosome**.

helicase: Enzyme that acts during **DNA replication** to open the double helix.

heterozygote: Individual with two different **alleles** of a given **gene** or **locus**.

homologous chromosomes: Two **chromosomes** that are identical in shape and structure and carry the same **genes**. **Diploid** organisms inherit one homologous chromosome from each parent.

homozygote: Individual with two identical **alleles** of a given **gene** or **locus**.

insertion: Mutation resulting in the addition of one or more **nucleotides** to a **DNA** sequence.

interphase: Period of cell growth between divisions.

intron: The noncoding part of a **gene**. Intervening sequences that interrupt **exons**.

ligase: Enzyme that acts during **replication** to seal gaps created by lagging synthesis.

linkage: Inheriting **genes** located close together on **chromosomes** as a unit.

locus: A specific location on a **chromosome**.

meiosis: Cell division in sexually reproducing

organisms that reduces amount of genetic information by half.

metaphase: Stage of cell division when **chromosomes** align along the equator of the dividing cell.

mitosis: Simple cell division without a reduction in **chromosome** number.

nucleotide: Building block of **DNA**; composed of a deoxyribose sugar, a phosphate, and one of four nitrogenous bases.

P generation: Parental generation in a genetic cross.

penetrance: Percentage of individuals with a particular **genotype** that express the trait.

phenotype: Physical characteristics of an individual.

polypeptide: Chain of **amino acids** that form a protein.

prokaryote: An organism with a simple cell structure and no cell nucleus.

prophase: Stage of cell division when **chromosomes** contract and become visible and nuclear membrane begins to break down. In **meiosis**, **crossing-over** takes place during prophase.

purine: Compound composed of two rings.

pyrimidine: Chemicals that have a single six-sided ring structure.

RNA: Ribonucleic acid; the single-stranded molecule that transfers information carried by **DNA** to the protein-manufacturing part of the cell.

recessive: A **phenotype** or **allele** exhibited only by **homozygotes**.

replication: The process of making an exact copy of a **DNA** molecule.

telomere: Tip of a **chromosome**.

telophase: Stage of cell division when **chromosomes** relax and the nuclear membrane re-forms.

thymine: **Pyrimidine base** found in **DNA** but not **RNA**.

totipotent: Describes a cell that can develop into any type of cell.

uracil: **Pyrimidine base** found in **RNA** but not **DNA**.

zygote: Fertilized egg resulting from the fusion of a sperm and egg cell.

Index

• A •

- acceptor arm, 134
- achondroplasia, 179, 193
- addition rule of probability, 46–47
- adenine
 - adding to mRNA, 126–127
 - defined, 345
 - in DNA, 83–85
 - wobble pairing and, 192
- adenosine triphosphate (ATP), 21, 85–86
- adenoviruses, gene therapy and, 240
- admixtures, DNA fingerprinting and, 275
- age, birth defects and, 193, 229–230
- aging
 - clones and, 306–307
 - DNA, 307
 - genetics of, 334–335
- agrobacterium, transgenics and, 289–290
- AIDS, mutated immunity to, 254
- alkylating agents, inducing mutations, 196
- allele frequencies, 252–255, 256–258
- alleles. *See also* genes
 - codominance and, 52–53
 - crossing over of, 34
 - defined, 345
 - dominance and, 41–43
 - finding unknown, 45–46
 - incomplete dominance and, 52
 - incomplete penetrance and, 53–54
 - interacting, 56–57
 - lethal, 56
 - masking, 57–59
 - multiple with multiple loci, 54–56
 - overview, 25–26
 - phenotypes and, 40
 - segregation of, 43–45
- alternative splicing, 128
- Alu* elements, 128, 151
- amino acids
 - codons specifying, 131–132
 - connecting with tRNA, 134–135
 - defined, 345
 - in polypeptide chains, 140–141
 - translation and, 133
 - tRNA and, 134–135
- aminoacyl-tRNA synthetases, 135
- amniocentesis, 187
- amplification, 211
- anabolic steroids, gene expression and, 152
- anaphase, 30, 34, 35, 345
- aneuploidy
 - defined, 345
 - G-banding and, 222
 - mosaicism, 232
 - overview, 223–225
- angiogenesis, cancer growth and, 207
- animals. *See also specific animals*
 - cloning, 300, 305
 - domestication of, 284
 - pet Web sites, 344
 - providing biological evidence, 269
 - transgenic experiments with, 294–296
- annealing, PCR process and, 271
- antibiotic resistance, concerns about, 338
- anticipation
 - defined, 345
 - Fragile X syndrome and, 233
 - overview, 63
 - strand slippage and, 193
- anticodon, 134, 345
- antiparallel, 89, 90, 345
- apoptosis, 212–213, 345
- apurination, mutation and, 194
- aromatase enzyme, sex determination and, 72
- ATP (adenosine triphosphate), 21, 85–86
- Auerbach, Charlotte (chemical mutagen studies), 195
- autism, 234
- automated DNA sequencing, 174
- autosomal dominant traits, 179–180
- autosomal recessive traits, 180–182
- autosome, 23, 345
- Avery, Oswald (transforming principle studies), 94, 328

• B •

backcross, 345
 bacteria
 as prokaryotes, 20–21
 transgenics and, 297–298
 unintentional mutations of, 286
 bacterial DNA, mtDNA and, 92
 bacteriophage, 94, 345
 bacteriophage cloning, 244
 basal lamina, cell growth and, 206–207
 base, 345
 base analogs, inducing mutations, 195–196
 base-excision repairs, 200
 Bateson, William (Mendelian genetics studies), 327
 Beadle, George (one gene–one polypeptide hypothesis), 138
 benign growths, 204–205
 biodiversity, 252, 253, 259
 Bioinformatics, 336
 biological determinism, fallacy of, 315
 biological evidence
 collecting, 268–270
 defined, 268
 extracting DNA from, 270–273
 Biology Project Web site, 341–342
 bioterrorism, 339
 bipolar disorder, 236
 bird flu, genetics of, 338–339
 birds
 mating habits of, 262–263
 sex determination of, 70–71
 birth defects. *See also specific birth defects*
 father's age and, 193
 mother's age and, 229–230
 blastocyst, 301
 blood type, codominance and, 53
 bonellia worms, sex determination in, 71
 boundary elements, transcription and, 149
 breast cancer
 incomplete penetrance and, 54
 metastasis of, 207
 mouse mammary tumor virus and, 210
 overview, 215–216
 brewers yeast, DNA sequencing of, 165
 Bridges, Calvin (aneuploidy studies), 223–224

• C •

cacogenics, 314–315
 CaMV (cauliflower mosaic virus)
 transgenics and, 289
 cancer
 anabolic steroids and, 152
 benign, 204–205
 breast, 54, 207, 210, 215–216
 cell cycle and, 208–213
 chromosomal abnormalities and, 213
 colon, 216–217
 dioxins and, 151
 as DNA disease, 207–208
 lung, 217–218
 malignant, 205–206
 metastasis of, 205, 206–207
 mouth, 218–219
 overview, 203–204
 prostate, 215
 proto-oncogenes and, 209–211
 six most common US (2001–2005), 204
 skin, 219
 tumor-suppressor genes and,
 209, 211–213
 viruses and, 209–210
 cap, adding to mRNA, 126–127
 captive breeding, biodiversity and, 259
 carcinomas, 206
 careers
 college/university professors, 17–18
 genetics counselors, 18
 graduate students and post-docs, 16
 lab technicians, 15–16
 research scientists, 17
 Web site for, 343–344
 carriers, 178, 230–231
 cats, color determination, 74
 cauliflower mosaic virus (CaMV),
 transgenics and, 289
 cell cycle
 cancer and, 208–213
 defined, 345
 example of, 27
 interphase of, 27–28
 mitosis, 29–30
 mitosis and, 26
 replication in, 101

- cell division, 208, 341. *See also* meiosis; mitosis
- cell wall, 21
- cell-lines, ethics issues of, 318
- cell-pollination, 39
- cells
- with nucleus, 21–22
 - regulating death of, 212–213
 - with versus without nucleus, 19–20
 - without nucleus, 20–21
- Central Dogma of Genetics, 138
- centromeres, 24, 25, 345
- CF (cystic fibrosis), 181, 201
- chaperones, proteins structure and, 142
- Chargaff, Erwin (DNA studies), 94–95, 328
- Chargaff's rules, 89, 94–95
- Chase, Alfred (DNA studies), 94
- cheetahs, genetics diversity of, 12
- chemical components
- of DNA, 83–87
 - of RNA, 115
- chemical evidence, 268
- chemically induced mutations, 195–197
- chemicals, genetical modifications with, 284–285
- chemistry, studying genes, 11–12
- chickens, DNA sequencing of, 166–167
- chloroplast DNA, 93
- chloroplasts, 21
- chorionic villus sampling (CVS), 187
- chromatids
- defined, 346
 - during meiosis, 34–36
 - sister, 28, 30
- chromatin, gene expression and, 147
- chromatin-remodeling complexes, 148
- chromosomal rearrangements, 233–236
- chromosome arms, identifying, 222
- chromosome disorders
- aneuploidy, 227–228
 - chromosomal rearrangements, 233–234
 - duplications, 234
 - Fragile X syndrome, 232–233
 - monosomy, 228
 - mosaicism, 232
 - polyploidy, 232
 - trisomy, 228–231
- chromosome walking, 246
- chromosomes. *See also* X chromosomes; Y chromosomes
- abnormalities of, cancer and, 213
 - anatomy of, 24–26
 - counting organism, 226
 - counting/pairing, 23–24
 - defined, 346
 - DNA and, 82
 - extra or missing, 223–225
 - in gametes, 36
 - genome size and, 163
 - meiosis and, 31–34
 - mitosis and, 27, 29–30
 - nondisjunction of, 73
 - overview, 22
 - in prokaryotes, 21
 - studying, 221–222
- circular DNA, replication of, 113–114
- CJD (Cruetzfeldt-Jakob disease), 157
- classical genetics. *See* Mendelian genetics
- Clonaid, cloning of humans and, 302
- cloning
- arguments in favor of, 310–311
 - arguments opposed to, 311–312
 - defined, 299
 - developmental problems with, 309
 - DNA, 299–300
 - Dolly the sheep, 300
 - environment affecting, 309–310
 - faster aging and, 306–307
 - LOS and, 307–308
 - with somatic cell nucleus, 304–305
 - totipotency and, 300–302
 - twinning process and, 303–304
- codominance, 52–53, 346
- codons
- amino acid spellings and, 131–132
 - defined, 130, 346
 - reading, 132
- college professors, career of, 17–18
- Collins, Dr. Francis (HGP director), 332
- colon cancer, 216–217
- compaction, zygote development and, 301
- complementary pairing, 89–90, 118, 346
- complete penetrance, 53
- consanguineous relationships, 181–182, 346
- conservative replication, 99

corn, mutations of, 285
 Crick, Francis (DNA structure discoveries), 95–96
 Cri-du-chat syndrome, 235
 crossing, Mendel's experiments with, 38–39
 crossing-over, 346. *See also* recombination
 Cruetzfeldt-Jakob disease (CJD), 157
 CVS (chorionic villus sampling), 187
 cyclins, cell cycle and, 28
 cystic fibrosis (CF), 181, 201
 cytogeneticist, role of, 221–222
 cytokinesis, 31, 346
 cytoplasm, in prokaryotes, 21
 cytosine
 defined, 346
 in DNA, 83–85
 wobble pairing and, 192

● D ●

Darwin, Charles (*Origin of Species*), 325–326
 Davenport, Charles (father of American eugenics movement), 314
 ddNTPs (di-deoxyribonucleoside triphosphates), 169–172, 346
 de Vries, Hugo (Mendelian studies), 327
 deamination, 194, 346
 degeneracy theory, eugenics and, 314
 degenerate, 130, 346
 degradation of DNA, 270
 deletion, 233, 234–236, 346
 denaturation, 170, 271, 346
 deoxyribonucleic acid (DNA). *See* DNA (deoxyribonucleic acid)
 deoxyribonucleoside triphosphates (dNTPs). *See* dNTPs (deoxyribonucleoside triphosphates)
 deoxyribose, 85–87, 116–117
 depurination, 346
 designer babies, myth of, 315
 developmental genetics, 331
 di-deoxyribonucleoside triphosphates (ddNTPs), 169–172, 346
 dihybrid cross
 deciphering, 49–50
 defined, 346
 linkage analysis of, 60–62
 dimers, mutation and, 197–198
 dioecy, 66
 dioxins, controlling gene expression, 151
 diploid, 24, 36, 346
 direct repair, 200
 disasters, identifying victims of, 280–282
 D-loop replication, 114
 DNA (deoxyribonucleic acid). *See also* replication
 aging and, 307
 bacterial versus mitochondrial, 92
 cancer as disease of, 207–208
 chemical components of, 83
 chloroplast, 93
 circular, replication of, 113–114
 cloning, 299–300
 decay and, 86
 deconstructing, 82–83
 defined, 346
 degradation of, 270
 deoxyribose and phosphates and, 85–87
 discovery of, 93–94
 extracting from biological evidence, 270–273
 home experiment extracting, 84
 junk, 111, 163
 mitochondrial, 92–93
 molecular genetics and, 11–12
 nitrogen-rich bases in, 83–85
 nuclear, 91
 overview, 81
 packaging of, 147–148
 repair options for, 199
 repetitive sequences of, 163
 strands, transcription and, 121–122
 structure of, 87–91
 on telomeres, 24
 transcription of, 120–126
 valuable trivia about, 91
 versus RNA, 115
 in viruses, 82
 DNA fingerprinting
 extracting DNA for, 270–273
 invention of, 330–331
 junk DNA and, 266–268
 matching, 275–276
 overview, 265
 paternity testing, 277–280
 reading, 273–274
 relatedness testing, 280–282
 reviewing old crimes with, 277

DNA libraries, creating, 243–245
DNA polymerase
 in eukaryotic replication, 110
 proofreading replication, 109–110
 replication and, 104, 106, 109
 replication mutations and, 191–192
DNA profiling. *See* DNA fingerprinting
DNA sequencing
 automated, 174
 of brewers yeast, 165
 of chickens, 166–167
 discovery of, 329
 elements of, 169–170
 of human, 167–169
 palindrome, 211
 process, 170–172
 reading, 172–173
 of roundworms, 166
 scientific milestones and, 164–165
 shotgun, 173
 Web site for, 342
DNA template
 creation of, 105–106
 replication and, 102
 semiconservative replication and, 98
DNase I enzyme, DNA packaging and,
 147–148
dNTPs (deoxyribonucleoside
 triphosphates)
 defined, 346
 DNA sequencing and, 169–172
 replication and, 102–103
Dolly the sheep (clone), 300, 306
dominance
 co-, 52–53
 defined, 43, 346
 incomplete, 52
 incomplete penetrance and, 53–54
dominant epistasis, 58
donor cells (cloning), 304, 309
dosage compensation, 73
Down syndrome, 193, 230–231
Down Syndrome Cell Adhesion Molecule
 (Dscam), genetic coding potential of,
 153–154
drugs, correcting reactions to, 333
duplication, 233, 234
dysplasia, cancer and, 204–205

• E •

ectoderm, of gastrula, 301
Edward syndrome, 231
egg cells, 36, 304–305
eggplants, incomplete dominance in, 52
electrophoresis, 172–173
elongation, 124–125, 137
embryos
 artificially splitting, 303–304
 indifferent stage, 68
endoderm, of gastrula, 301
enhancer genes, 148–149
enhancers, transcription and, 124
enucleation, 304
environment
 Down syndrome and, 230
 effect on phenotypes, 64
 effects on cloning, 309–310
enzymes
 mismatch repair of replication and, 109
 replication and, 103–105
 transcription and, 122–123
epistasis, 57–59, 346
equilibrium, allele-genotype frequencies,
 256–258
EST (express sequence tag), 243–245
ethics
 designer baby myth, 315
 eugenics and, 314–315
 genetic property rights and, 320–321
 informed consent issues, 316–320
 overview, 313
 preimplantation genetic diagnosis
 and, 316
 privacy issues, 319–320
eugenics, 314–315
eukaryotes
 chromosomes in, 22
 chromosomes numbers in, 23–24
 defined, 19, 347
 example of, 20
 gene control in, 146–147
 introns and, 125
 nuclei in, 83
 overview, 21–22
 replication and, 110–113
 termination factor in, 126
euploidy, 223, 226, 347

evidence
 collecting biological, 268–270
 extracting DNA from, 270–273
 types of, 268

exons
 defined, 125, 347
 editing of, 153
 pulling together, 127–128

exonucleases, DNA degradation and, 270

express sequence tag (EST), 243–245

expressivity
 anticipation and, 63
 defined, 54, 347
 of Y-linked traits, 78

extension stage, of PCR process, 272

• F •

F1 generation, 347

F2 generation, 347

Familial Down syndrome, 230–231

family tree
 with autosomal traits, 179–182
 building/analyzing, 176–179
 kinship in, 277
 with X-linked traits, 182–185
 with Y-linked traits, 185–186

fathers
 age of, birth defects and, 193
 Prader-Willi syndrome and, 235

FBI CODIS system, 276

fingerprinting evidence, 268

firearm marks (evidence), 268

fish
 sex determination in, 71
 transgenics and, 295, 296

Fisher, Ronald A. (British scientist), on Mendel's experiments, 59

flu, genetics of, 338–339

Fly Room, 224

food crops, genetically modifying.
See plants

forensic genetics
 collecting biological evidence, 268–270
 constructing DNA fingerprints, 273–274
 DNA fingerprinting, 266–268
 evidence, types of, 268
 extracting DNA from evidence, 270–273
 matching DNA, 275–276

overview, 265–266
 paternity testing, 277–280
 population genetics and, 12
 relatedness testing, 280–282
 reviewing old crimes with, 277

Fragile X syndrome, 232–233

Franklin, Rosalind (DNA structure discovery), 95–96

free radicals, inducing mutations, 196

frequency, measuring mutations by, 191

Frye standard, DNA fingerprinting and, 274

functional change mutation, 199

• G •

G1 phase, of cell cycle, 27–28

G2 phase, of cell cycle, 28

gain-of-function mutation, 199

galactosemia, newborn screening for, 188

galls, creating transgenic plants and, 289

Galton, Francis (eugenics theories), 314

gametes, 35, 36, 347

gametogenesis, process of, 35

Gap 2 phase, cell cycle and, 28

gastrula, 301

G-banding, 222

Gelsinger, Jesse (gene therapy case), 247, 318–319

gender. *See* sex

gene chips, 337–338

gene expression
 anabolic steroids and, 152
 defined, 143
 dioxins and, 151
 DNA packaging and, 147
 genes managing transcription, 148–149
 hormones and, 151–153
 modifying protein shapes and, 157
 regulating timing of translation and, 156–157
 regulating translation location of, 156
 TEs controlling, 149–151
 tissue-specific nature of, 144–145
 transcription and, 146–147

gene flow, 260, 262–263

gene gun, transgenics and, 290

gene mapping, gene therapy and, 240–242, 245–246

- gene therapy
 - creating DNA libraries and, 243–245
 - experiments in, 246–247
 - gene mapping and, 240, 245–246
 - overview, 237–238
 - using viruses with, 238–240
 - general genetics education Web site, 342
 - genes. *See also* alleles
 - breast cancer, 216
 - colon cancer, 217
 - controlling multiple phenotypes, 62
 - defined, 25, 347
 - duplication of cancer, 211
 - homeotic, 331
 - jumping, 149–151
 - linked, 59–62
 - linking with function, 118
 - lung cancer, 218
 - managing transcription, 148–149
 - overview, 39–40
 - prostate cancer, 215
 - segmentation, 331
 - sequences for transcription, 120–121
 - skin cancer, 219
 - studying chemistry of, 11–12
 - on X chromosome, 67–68
 - on Y chromosome, 68–69
 - genetic code
 - codons of, 131–132
 - degenerate, 130
 - translation and, 133
 - universality of, 133
 - genetic counselors
 - analyzing autosomal traits, 179–182
 - analyzing X-linked traits, 182–185
 - analyzing Y-linked dominant traits, 185–186
 - building and analyzing family trees, 176–179
 - career of, 18
 - overview, 175–176
 - use of probability, 47
 - genetic disorders, 182, 343. *See also specific genetic disorders*
 - genetic engineering, 287
 - genetic modification (GM). *See* transgenic organisms; transgenics
 - genetic privacy issues, 319–320
 - genetic property rights, ethics of, 320–321
 - Genetic Savings and Clone (cloning pets), 305
 - genetic testing
 - general, 186–187
 - informed consent issues and, 317–318
 - newborn screening, 188
 - overview, 186
 - prenatal, 187–188
 - genetic treatment, ethics of, 318–319
 - genetic variation, 251–252
 - genetics lab, 13–15
 - genetics problems
 - approach to deciphering, 48
 - deciphering dihybrid cross, 49–50
 - deciphering monohybrid cross, 48–49
 - Genome News Network Web site, 343
 - genomes. *See also* DNA sequencing
 - defined, 161, 347
 - differences among organisms, 161–163
 - sequencing, 165–169
 - genomic imprinting, 63, 308
 - genotype frequencies, 255–258
 - genotypes, 40, 280–281, 347
 - germ-cell mutations, 189, 190. *See also* mutations
 - GM (genetic modification). *See* transgenic organisms; transgenics
 - graduate students, career of, 16
 - Griffith, Frederick (transforming principle), 94, 327
 - groups, studying genetics of, 12
 - guanine, 83–85, 192, 347
 - gyrase, 104, 105, 347
- H •**
- haploid, 347
 - haploid organisms, 24
 - haplotypes, mapping, 261–262
 - HapMap Project, 261–262
 - Hardy, Godfrey (Hardy-Weinberg Law of Population Genetics), 256
 - Hardy-Weinberg graph, 257
 - Hardy-Weinberg Law of Population Genetics, 256–258, 259–260
 - helicase, 104, 105, 347
 - helix
 - DNA structure and, 87–91
 - replication splitting, 98, 105

- Hemmings, Sally (Jefferson slave), 279
- hemoglobin, gene expression and, 144–145
- hemoglobin proteins, structure of, 142
- hemophilia, 77, 234
- Henking, Herman (X chromosome studies), 66
- Henry, Edward (fingerprinting), 265
- Herrick, Dr. James (discovery of sickle cell anemia), 140
- Hershey, Martha (DNA studies), 94
- heterogametic, 70
- heterozygosity, 256–258, 259–260
- heterozygote, 40, 178, 347
- heterozygous, 40
- heterozygous locus, 40
- HEXA (hexosaminidase A), Tay-Sachs and, 202
- HGP (Human Genome Project). *See* Human Genome Project (HGP)
- histones, in DNA, 82
- history
of genetics, 9
tracing with Y chromosome, 69
- A History of Genetics* (Sturtevant), 224
- HIV, mutated immunity to, 254
- home experiment, extracting DNA, 84
- homeotic genes, 331
- homogametic, 70
- homologous chromosomes, 24, 33–34, 347
- homozygosity, 256–258
- homozygote, 40, 178, 347
- homozygous locus, 40
- horizontal gene transfer, 287
- hormone response elements (HREs), 153
- hormones, gene expression and, 151–153
- horses, epistasis in, 57–59
- Howard Hughes Medical Institute, sequencing projects Web site, 342
- HPV (human papilloma virus), cervical cancer and, 210
- HREs (hormone response elements), 153
- Hughes, Walter (replication studies), 99–101
- Human Genome Project (HGP)
automated sequencing and, 174
Dr. Collins and, 332
identifying genes and, 242
overview, 167–169
shotgun sequencing and, 173
Web site, 342
- human papilloma virus (HPV), cervical cancer and, 210
- humans
cloning of, 302
DNA sequencing of, 167–169
sex determination in, 67–69
sex-determination disorders in, 73–75
sex-influenced traits and, 78
X-linked recessive disorders in, 77
- Huntington disease, 56, 179–180
- hybridization, selective, 284
- **I** ●
- immunity, to AIDS/HIV, 254
- impressions (evidence), 268
- in vitro fertilization
cloning and, 304
LOS and, 308
preimplantation genetic diagnosis and, 316
unreliability of, 315
- inbreeding, 259–260, 284
- inbreeding depression, 260
- incomplete dominance, 52
- incomplete penetrance, 53–54
- independent assortment, law of, 45
- indifferent stage, of embryo, 68
- induced mutations, 195
- infectious disease, genetics of, 338–339
- information access, ethics and, 319–320
- informed consent, ethics issues with, 316–319
- inheritance. *See also* mode of inheritance
anticipation and, 63
common diseases of, 200–202
detecting patterns of, 177–179
dominance and, 41–43
independent, of traits, 45
intelligence and, 314–315
of mutations, 189–190
probabilities, 46–47
segregation of alleles and, 43–45
sex-linked, 76–78
simple, 40–41
- initiation, 124, 134–137
- initiators, replication and, 105
- Innocence Project, using DNA evidence, 277

insects
beneficial, damaged by transgenics, 293
discovery of XX-XY sex determination
in, 66
sex determination of, 70
transgenics and, 297
X-linked traits in, 76–77
insertion
defined, 347
mutations, 190, 193, 197, 199
insulator genes, managing transcrip-
tion, 149
intelligence, heritability of, 314–315
intercalating agent, inducing mutations,
196–197
interkinesis, of meiosis, 34
interphase
of cell cycle, 27–28
defined, 347
replication in, 101
introgression, concerns about, 292–293
introns
defined, 125, 347
removing, 127–128, 153
inversion, 233, 234
Irons, Dr. Ernest (discovery of sickle cell
anemia), 140
isoaccepting tRNAs, 134

• J •

J. Craig Venter Institute Genome News
Network Web site, 343
Jefferson, President Thomas, genetic
testing and, 279, 318
Jeffreys, Sir Alec (DNA fingerprinting
inventor), 330–331
jumping genes, 149–151, 328–329
junk DNA
DNA fingerprinting and, 266–268
function of, 163
replication and, 111

• K •

karyotyping, 221–222
kinases, cell cycle and, 28
kinship, predictability of, 277
Klinefelter syndrome, 75

Knudson, Alfred (retinoblastoma studies),
212

• L •

lab equipment, 14
lab technicians, career of, 15–16
laboratories, 13–15
lagging strands, 108
large offspring syndrome (LOS), 307–308
law of independent assortment, 45
laws of inheritance, 37
leading strands, 108
lentiviruses, gene therapy and, 239–240
lethal alleles, 56
lethal phenotypes, 56
leukemias, 206
ligase, 104, 109, 347
Lincoln, President Abraham, genetic
testing and, 317
linkage, 347
linkage analysis, 59–62, 241
location-dependent sex determination, 71
loci
chromosome, 26
defined, 347
DNA fingerprinting and, 267–268
multiple with multiple alleles, 54–56
phenotypes and, 40
LOS (large offspring syndrome), 307–308
loss-of-function mutations, 199, 211
lung cancer, 217–218
lymphomas, 206

• M •

MacLeod, Colin (transforming principle
studies), 328
macrophage, 254
mad cow disease, 157
maize, mutations of, 285
malignancies, 205–206
mapping
gene, 240–242, 245–246
gene pools, 260–263
Marfan syndrome, 179
marker gene, transgenics and, 289
markers, DNA fingerprinting and, 267–268

- McCarty, Maclyn (transforming principle studies), 328
- McClintock, Barbara (jumping genes discoverer), 150, 328–329
- McClung, Clarence (sex determination chromosome studies), 66, 70
- medications, correcting reactions to, 333
- meiosis
 - chromosome activities during, 32, 33
 - defined, 347–348
 - Down syndrome occurrence and, 229–230
 - independent inheritance of traits and, 45
 - overview, 31–33
 - part I, 33–34
 - part II, 35
 - Y chromosome during, 68–69
- melanoma, 219
- Mendel, Gregor (father of Mendelian genetics)
 - discovering dominant versus recessive traits, 41–43
 - finding unknown alleles, 45–46
 - as founder of genetics, 10
 - law of independent assortment, 45
 - pea plants experiments, 38–39
 - rediscovery of work of, 326–327
 - segregation of alleles and, 43–45
 - studying simple inheritance, 40–41
- Mendelian genetics
 - defined, 10
 - overview, 10–11
 - population genetics and, 12
 - Web site for, 341–342
- mesoderm, of gastrula, 301
- messenger RNA (mRNA). *See* mRNA (messenger RNA)
- metaphase, 30, 35, 348
- metastasis, 205, 206–207
- microarrays, 337–338
- Miescher, Johann Friedrich (DNA studies), 93
- mismatch repair, 109, 199–200
- missense mutations, 199
- mitochondria, 21
- mitochondrial DNA (mtDNA), 92–93, 282
- mitosis
 - defined, 348
 - overview, 26–27
 - process of, 29–30
- MMTV (mouse mammary tumor virus), breast cancer and, 210
- mode of inheritance
 - analyzing family tree and, 178
 - of autosomal traits, 179–182
 - of X-linked traits, 182–185
 - of Y-linked traits, 185–186
- molecular genetics, 10, 11–12
- Mono hybrid crosses, simple inheritance and, 42
- monoecy, 66
- monohybrid crosses, 41, 48–49
- monosomy, 227, 228
- Monosomy X syndrome, 75
- Morgan, Thomas H. (X-linked inheritance studies), 76–77, 224
- mosaicism, 232, 295
- mosquitoes, mutations of, 286
- mothers, age of, Down syndrome and, 229–230
- mouse mammary tumor virus (MMTV), breast cancer and, 210
- mouth cancer, 218–219
- mRNA (messenger RNA). *See also* RNA
 - adding cap and tail to, 126–127
 - creating DNA libraries and, 243
 - function of, 120
 - lifespan of, 155–156
 - post-transcription editing of, 127–128
 - regulating timing of translation, 156–157
 - silencing, 154, 155
 - transcription and, 120–126
- mtDNA (mitochondrial DNA), 92–93, 282
- mules, reproducing, 227
- Mullis, Kary (PCR studies), 329–330
- multiplication rule of probability, 46–47
- mutations
 - autosomal dominant, 180
 - breast cancer, 216
 - cancer and, 207–208
 - chemically induced, 195–197
 - chromosomal rearrangements, 233–236
 - colon cancer, 217
 - father's age and, 193
 - immunity to HIV/AIDS, 254
 - induced, 195
 - mouth cancer, 219
 - occurring during replication, 191–192
 - prostate cancer, 215
 - radiation induced, 197–198
 - reasons for, 190
 - repair of, 199–200

scientists introducing, 154
 skin cancer, 219
 spontaneous, 191
 spontaneous chemical changes and, 194
 strand slippage and, 193–194
 tracing, 260
 types of, 189, 198–199
 unintentional, 286
 myeloma, 206

• N •

nanotechnology, 336–337
Nature Web site, 344
 Neufeld, Peter (Innocence Project), 277
 neutral mutation, 199
 nitrogen-rich bases
 complementary pairing of, 89–90, 118
 in DNA, 83–85
 in RNA, 117–118
 nondisjunction, 73, 223–225, 229–230
 nonreciprocal translocation, 236
 nonsense mutations, 199
 non-small cell lung cancers, 218
 no-till farming, transgenic crops and, 294
 nuclear DNA, 91
 nuclear envelope, 19
 nucleosomes, 82, 112–113
 nucleotide-excision repair, 200
 nucleotides
 chemical components of, 83–87
 defined, 348
 DNA structure and, 87–91
 replication and, 102–103
 nucleus
 cells with, 21–22
 cells without, 20–21
 defined, 19
 in eukaryotic cells, 83
 returning to totipotency, 302–303
 nullisomy, 227
 Nüsslein-Volhard, Christiane
 (developmental genetics studies), 331

• O •

Okazaki fragments, 108
 oncoretroviruses, gene therapy and,
 239–240

one gene–one polypeptide hypothesis, 138
 Online Mendelian Inheritance in Man Web
 site, 343
 organelles, 21
Origin of Species (Darwin), 325–326
 origins, replication and, 105
 ornithine transcarbamylase (OTC)
 deficiency, gene therapy for, 247
 out-crossing, 39

• P •

P generation, 348
 palindrome DNA sequence, cancer and, 211
 paracentric inversion, 234
 Patau syndrome, 231
 patents, ethics of, 320–321
 paternity index, 279
 paternity testing, 277–280
 PBS (Public Broadcasting Service) *Nova*
 Web site, 341
 PCR (polymerase chain reaction) process,
 270–273, 329–330
 pea plants
 Mendel's experiments with, 38–39
 segregation of alleles and, 43–45
 studying simple inheritance of, 40–41
 pedigree. *See* family tree
 penetrance
 of breast cancer, 216
 defined, 348
 reduced, 180
 sex-limited traits and, 77
 Pennsylvania Amish, genetic disorders
 and, 182
 peppers, genes interacting in, 56–57
 pericentric inversion, 234
 PGD (preimplantation genetic diag-
 nosis), 316
 pharmaceuticals, transgenics and, 293
 pharmacogenomics, 333
 phenotypes
 alleles and, 40
 anticipation and, 63
 autosomal dominant, 179–180
 autosomal recessive, 180–182
 codominance and, 52–53
 dominant versus recessive, 41–43
 environmental effects and, 64

- phenotypes (*continued*)
 - genes controlling multiple, 62
 - genomic imprinting and, 63
 - incomplete dominance and, 52
 - incomplete penetrance and, 53–54
 - independent inheritance of, 45
 - lethal, 56
 - multiple alleles and loci and, 54–56
 - proteins and, 130
 - sex, 66
 - sex-influenced, 78
 - sex-limited, 77–78
 - study of, 10
 - studying transmission of, 10–11
 - transmission of, 37
 - X-linked recessive, 182–183
- phenylketonuria (PKU), 62, 188
- phosphates, in DNA, 85–87
- phosphodiester bond, DNA structure and, 88
- photosynthesis, chloroplast DNA and, 93
- plagues, population genetics and, 254
- plants
 - chloroplasts and, 21
 - commercial applications for transgenic, 290–291
 - developing transgenic for commercial use, 288–290
 - domestication of, 284
 - escaped transgenes and, 292–293
 - food safety issues of transgenic, 291–292
 - genetically modifying, 284–285
 - polyploid, 226
 - providing biological evidence, 269
 - reproducing, 39
- plasma membrane, 21
- platypus, sex determination in, 72
- pleiotropic genes, 62
- ploidy, 24, 223
- point mutation, SNP analysis and, 282
- polar bodies, egg cells and, 36
- pollination, 39
- poly-A tail, 127, 155–156
- polyacrylamide, DNA sequencing and, 172
- polydactyly, 53–54, 179–180
- polygyny, mapping gene pools and, 262
- polymerase. *See* DNA polymerase; RNA polymerase; Taq polymerase
- polymerase chain reaction (PCR) process
 - discovery of, 329–330
 - extracting DNA with, 270–273
- polymorphism, in STRs, 267
- polypeptide chains, 139, 142
- polypeptides
 - cell cycle transitions and, 28
 - Cruetzfeldt-Jakob disease and, 157
 - defined, 129, 348
 - one gene–one polypeptide hypothesis and, 138
 - overview, 129–130
 - shape of, gene expression and, 157
 - structure of, 142
 - study of, 335–336
 - transcription activator, 148
 - transcription and, 122–123
- polyploidy, 226, 232
- Poly-X syndrome, 74
- population genetics
 - allele frequencies and, 254–255
 - allele-genotype frequencies equilibrium and, 256–258
 - defined, 10, 251
 - genotype frequencies and, 255–256
 - inbreeding and, 259–260
 - mapping gene pools and, 260–263
 - overview, 12
 - plagues and, 254
 - tracing mutations and, 260
- post-docs, career of, 16
- Prader-Willi syndrome, 235–236
- precocious puberty, 78
- preimplantation genetic diagnosis (PGD), 316
- prenatal genetic testing, 187–188
- primary structure, of polypeptide chains, 142
- primase, 104, 106
- primates, transgenics and, 295–296
- primers
 - DNA sequencing and, 169
 - PCR process and, 271
 - removing, 109
 - replication and, 106–108
- prion, Cruetzfeldt-Jakob disease and, 157
- privacy, information access and, 319–320
- probability
 - computing inheritance with, 46–47
 - inheritance and, 46–47
 - of paternity, 279
- proband, building family trees and, 176–177

- prokaryotes
 chromosomes in, 22
 defined, 19, 348
 example of, 20
 introns and, 125
 overview, 20–21
 terminator sequences in, 126
promoter sequences, transgenics and, 288–289
promoter, transcription and, 121
pronuclei, transgenics and, 294
property rights, genetic, 320–321
prophase, 29, 33, 348
prostate cancer, 215
proteins. *See* polypeptides
proteomics, 335–336
protonation, 192
proto-oncogenes, cancer and, 209–211
Public Broadcasting Service (PBS) *Nova*
 Web site, 341
purine, 84–85, 348
pyrimidines, 84–85, 348
- *Q* •
- QTL analysis, quantitative genetics and, 13
quantitative genetics, 10, 13
quaternary structure, of polypeptide chains, 142
Queen Victoria, hemophilia link, 77, 184
- *R* •
- rabbits, coat color alleles of, 55–56
radiation, genetically modifying plants with, 284–285
radiation-induced mutations, 197–198
Rasputin, Gregory (Russian monk/healer), 184
rate, measuring mutations by, 191
reading frame, 132
recessive, 348
recessive epistasis, 58
reciprocal translocation, 236
recombinant DNA technology
 development of, 330
 overview, 242
 transgenics and, 287
recombination
 defined, 19
 of homologous chromosomes, 33–34
 linkage analysis and, 16
 meiosis and, 31, 32
 unequal, mutations and, 194
 Y chromosome and, 68–69
reduced penetrance, autosomal dominant inheritance and, 180
relatedness testing, 280–282
replication
 activating, 106–108
 of circular DNAs, 113–114
 conservative, 99
 defined, 19, 348
 of DNA, 91
 enzymes and, 103–105
 in eukaryotes, 110–113
 helix splitting and, 105–106
 importance of, 97
 joining strands, 108–109
 nucleotides and, 102–103
 overview, 101
 proofreading, 109–110
 semiconservative, 98–99
 spontaneous mutation and, 191–192
 studies, 99–101
 template DNA and, 102
 replication fork, 106
repressors, transcription and, 147
reptiles, sex determination of, 71–72
research scientists, career of, 17
resistance
 to antibiotics, 338
 to transgenes effects, 293
restriction enzymes, 244
retinoblastoma, 212
retrotransposons, controlling gene expression, 150–151
retroviruses, 210, 239–240
reverse transcription, 243
ribonucleic acid (RNA). *See* RNA (ribonucleic acid)
ribonucleotides, 122–123
ribose, in RNA versus DNA, 116–117
ribosomes
 starting translation, 136–137
 translation and, 133
RNA interference (RNAi), 118, 154, 155

- RNA polymerase, transcription and, 123, 124–125
- RNA (ribonucleic acid)
 defined, 348
 functions of, 119
 molecular genetics and, 11–12
 overview, 115
 reading codons and, 131–132
 retrotransposons and, 150–151
 structure of, 119
 transcription and, 120–126
- Robertsonian translocation, Familial Down syndrome and, 230–231
- rolling circle replication, 114
- Romanov family, hemophilia link and, 184
- roundworm, DNA sequencing of, 166
- Rous, Peyton (cancer virus studies), 209
- S ●
- S phase, of cell cycle, 28
- Sanger, Frederick (DNA sequencing studies), 329
- sarcomas, 206
- Scheck, Barry (Innocence Project), 277
- schizophrenia, 63
- SCID (Severe Combined Immunodeficiency), 247
- screening, DNA libraries, 244
- secondary spermatocytes, 36
- secondary structure, of polypeptide chains, 142
- segmentation genes, 331
- segregation, 43–45
- selective hybridization, 284
- semiconservative replication, 98–99
- senescence (aging), genetics of, 334–335
- sequence tag site (STS), 245–246
- Severe Combined Immunodeficiency (SCID), 247
- sex
 determination of in birds, 70–71
 determination of in humans, 67–69
 determination of in insects, 70
 determination of in reptiles, 71–72
 genomic imprinting and, 63
 location-dependent determination, 71
 phenotypes of, 66
 sex cells, 22, 304–305
 sex chromosomes, 23
 sex-influenced traits, 78
 sex-limited traits, 77–78
 sex-linked inheritance, 76–78
 sexual reproduction, 22
 short tandem repeats (STRs)
 extracting/copying, 270–273
 forensic genetics using, 266–268
 paternity testing using, 277–280
 relatedness testing using, 280–282
 shotgun sequencing, 173
 sickle cell anemia, 140, 201–202
 SIDS (Sudden Infant Death Syndrome), in Pennsylvania Amish communities, 182
 signal transduction, hormones and, 153
 silencer genes, managing transcription, 149
 silent mutations, 198
 simple inheritance, 40–41
 single nucleotide polymorphism (SNP)
 analysis, DNA fingerprinting and, 282
 single-stranded-binding (SSB) proteins,
 replication and, 105
 sister chromatids, 28, 30
 site-directed mutagenesis, 154
 skin cancer, 219
 slipper limpets, location-dependent sex
 determination in, 71
 small populations, genetic disorders in, 182
 small-cell lung cancers, 218
 Smith, Hamilton O. (restrictive enzymes
 discoverer), 330
 Smith, Walter D. (exonerated criminal), 277
 SNP (single nucleotide polymorphism)
 analysis, DNA fingerprinting and, 282
 somatic cells, 22, 304–305
 somatic mutations, 189, 190. *See also*
 mutations
 species, 253, 262–263
 Sperling, John (clone funding), 305
 spermatogonia, 36
 spliceosome, 127–128, 154
 splicing, 128, 153–154
 SSB (single-stranded-binding) proteins,
 replication and, 105
 statute of limitations, DNA evidence
 extending, 276
 stem cell research, 334
 Stevens, Nettie (Y chromosome
 studies), 65

strand slippage, mutations from, 193–194
stress, aging and, 307
STRs (short tandem repeats). *See* short tandem repeats (STRs)
STS (sequence tag site), gene mapping and, 245–246
Sturtevant, Alfred (*A History of Genetics*), 224
Sudden Infant Death Syndrome (SIDS), in Pennsylvania Amish communities, 182
sugars. *See* deoxyribose; ribose, in RNA versus DNA
supercoiling, DNA, 82

• T •

tail

adding to mRNA, 126–127
mRNA lifespan and, 155–156

Taq polymerase

DNA sequencing and, 169, 170–172
PCR process and, 272

TATA box, 121, 122

Tatum, Edward (one gene–one polypeptide hypothesis), 138

taxonomic classification, 253

Taylor, J. Herbert (replication studies), 99–101

Tay-Sachs, 202

telomerase

aging process and, 335
replication and, 104, 111–112

telomeres

aging and, 307
aging process and, 334–335
cloning problems with, 306–307
defined, 24, 348
replication and, 110–112

telophase, 30, 34, 35, 348

teosinte, mutating into corn, 285

terminator, in transcription, 121, 126

TEs (transposable elements), 149–151, 328–329

testcross, 45–46, 60–62

tetrasomy, 228

Theta replication, 113

thymine

defined, 348
in DNA, 83–85

uracil and, 117–118

wobble pairing and, 192

tool marks (evidence), 268

totipotent

cloning experiments and, 300–302
defined, 144, 348
state, cell nucleus returning to, 302–303
stem cell research and, 334

trace evidence, 268

traits. *See* phenotypes

transcription

controlling gene expression and, 146–147
DNA strand functions and, 121–122
elements needed for, 122–123
elongation phase, 124–125
genes managing, 148–149
initiation phase, 124
locating gene sequence for, 120–121
overview, 119–120
reverse, creating DNA libraries and, 243
termination of, 126

transcription activator proteins, 148

transcription bubble, 124

transcription unit, 121

transfer RNA (tRNA). *See* tRNA (transfer RNA)

transforming principle, 327–328

transgenes, escaped, 292–293

transgenic organisms

controversy of, 286–287
creating, 154

transgenics

animal experiments, 294–296
bacteria experiments, 297–298
commercial applications for, 290–291
damaging unintended targets, 293
food safety issues of, 291–292
horizontal gene transfer, 287
insect experiments, 297
introgression concerns, 292–293
no-till farming and, 294
overview, 283–284
plans for commercial use of, 288–290
plants and, 284–285
resistance to transgene effects, 293

translation

elements of, 133
elongation, 137
process of, 133–134

translation (*continued*)
 regulating location of, 156
 regulating timing of, 156–157
 termination, 138–139
 tRNA-amino acid connection, 134–135
 translocation, 230–231, 233, 236
 transmission genetics. *See* Mendelian genetics
 transposable elements (TEs), 149–151, 328–329
 triplet code, 130
 trisomy
 Down syndrome, 229–230
 Familial Down syndrome, 230–231
 overview, 228
 tRNA (transfer RNA)
 connecting with amino acids, 134–135
 terminating translation and, 138
 translation and, 133
 tumors
 benign, 204–205
 malignant, 205–206
 viruses and, 210
 tumor-suppressor genes, cancer and, 209, 211–213
 Turner syndrome, 75
 twinning process, 303–304

• U •

ultrasound, prenatal genetic testing and, 187–188
 ultraviolet light, skin cancer and, 219
 unequal crossing-over, 194
 University of Kansas Medical Center
 genetics careers Web site, 343–344
 university professors, career of, 17–18
 uracil, 117–118, 348
 US Department of Energy Human Genome Project Web site, 342

• V •

variation, Darwin's principles of, 326
 vectors
 creating transgenic plants with, 289
 defined, 238
 using viruses as, 238–240

victims, identifying, 280–282
 viruses
 cancer and, 209, 210
 DNA in, 82
 using in gene therapy, 238–240

• W •

Watson, James (DNA structure discovery), 95–96, 167
 Weinberg, Wilhelm (Hardy-Weinberg Law of Population Genetics), 193, 256
 whales, mating habits of, 263
 Wilkins, Maurice (DNA studies), 95
 Wilson, Edmund (sex determination in insect studies), 66
 wobble, 132
 wobble pairing, spontaneous mutations and, 191–192
 wolves, population studies of, 262
 Woods, Philip (replication studies), 99–101

• X •

X chromosomes
 discovery of, 66
 disorders of, 74–75
 overview, 67–68
 X inactivation, 73–74
 X-linked disorders, 76–77
 X-linked dominant traits, 182–185
 X-linked recessive traits, 182–183

• Y •

Y chromosomes
 discovery of, 65, 66
 disorders with extra, 75
 overview, 68–69
 Y-linked traits, 78, 185–186

• Z •

zygotes
 defined, 35, 348
 development of, 301

BUSINESS, CAREERS & PERSONAL FINANCE

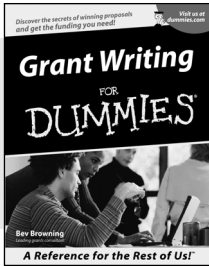

0-7645-5307-0

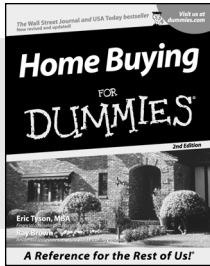

0-7645-5331-3 *†

Also available:

- ✓ Accounting For Dummies †
0-7645-5314-3
- ✓ Business Plans Kit For Dummies †
0-7645-5365-8
- ✓ Cover Letters For Dummies
0-7645-5224-4
- ✓ Frugal Living For Dummies
0-7645-5403-4
- ✓ Leadership For Dummies
0-7645-5176-0
- ✓ Managing For Dummies
0-7645-1771-6

- ✓ Marketing For Dummies
0-7645-5600-2
- ✓ Personal Finance For Dummies *
0-7645-2590-5
- ✓ Project Management For Dummies
0-7645-5283-X
- ✓ Resumes For Dummies †
0-7645-5471-9
- ✓ Selling For Dummies
0-7645-5363-1
- ✓ Small Business Kit For Dummies *†
0-7645-5093-4

HOME & BUSINESS COMPUTER BASICS

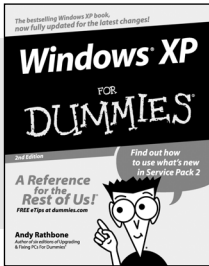

0-7645-4074-2

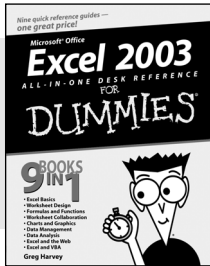

0-7645-3758-X

Also available:

- ✓ ACT! 6 For Dummies
0-7645-2645-6
- ✓ iLife '04 All-in-One Desk Reference For Dummies
0-7645-7347-0
- ✓ iPAQ For Dummies
0-7645-6769-1
- ✓ Mac OS X Panther Timesaving Techniques For Dummies
0-7645-5812-9
- ✓ Macs For Dummies
0-7645-5656-8

- ✓ Microsoft Money 2004 For Dummies
0-7645-4195-1
- ✓ Office 2003 All-in-One Desk Reference For Dummies
0-7645-3883-7
- ✓ Outlook 2003 For Dummies
0-7645-3759-8
- ✓ PCs For Dummies
0-7645-4074-2
- ✓ TiVo For Dummies
0-7645-6923-6
- ✓ Upgrading and Fixing PCs For Dummies
0-7645-1665-5
- ✓ Windows XP Timesaving Techniques For Dummies
0-7645-3748-2

FOOD, HOME, GARDEN, HOBBIES, MUSIC & PETS

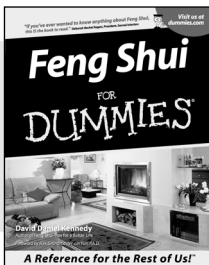

0-7645-5295-3

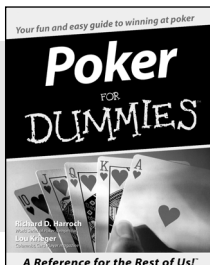

0-7645-5232-5

Also available:

- ✓ Bass Guitar For Dummies
0-7645-2487-9
- ✓ Diabetes Cookbook For Dummies
0-7645-5230-9
- ✓ Gardening For Dummies *
0-7645-5130-2
- ✓ Guitar For Dummies
0-7645-5106-X
- ✓ Holiday Decorating For Dummies
0-7645-2570-0
- ✓ Home Improvement All-in-One For Dummies
0-7645-5680-0

- ✓ Knitting For Dummies
0-7645-5395-X
- ✓ Piano For Dummies
0-7645-5105-1
- ✓ Puppies For Dummies
0-7645-5255-4
- ✓ Scrapbooking For Dummies
0-7645-7208-3
- ✓ Senior Dogs For Dummies
0-7645-5818-8
- ✓ Singing For Dummies
0-7645-2475-5
- ✓ 30-Minute Meals For Dummies
0-7645-2589-1

INTERNET & DIGITAL MEDIA

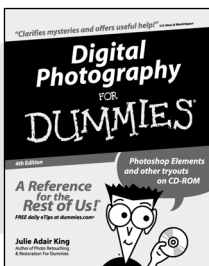

0-7645-1664-7

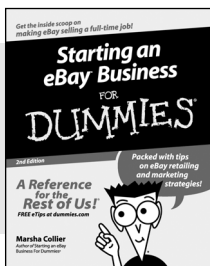

0-7645-6924-4

Also available:

- ✓ 2005 Online Shopping Directory For Dummies
0-7645-7495-7
- ✓ CD & DVD Recording For Dummies
0-7645-5956-7
- ✓ eBay For Dummies
0-7645-5654-1
- ✓ Fighting Spam For Dummies
0-7645-5965-6
- ✓ Genealogy Online For Dummies
0-7645-5964-8
- ✓ Google For Dummies
0-7645-4420-9

- ✓ Home Recording For Musicians For Dummies
0-7645-1634-5
- ✓ The Internet For Dummies
0-7645-4173-0
- ✓ iPod & iTunes For Dummies
0-7645-7772-7
- ✓ Preventing Identity Theft For Dummies
0-7645-7336-5
- ✓ Pro Tools All-in-One Desk Reference For Dummies
0-7645-5714-9
- ✓ Roxio Easy Media Creator For Dummies
0-7645-7131-1

* Separate Canadian edition also available

† Separate U.K. edition also available

Available wherever books are sold. For more information or to order direct: U.S. customers visit www.dummies.com or call 1-877-762-2974. U.K. customers visit www.wiley.com or call 0800 243407. Canadian customers visit www.wiley.ca or call 1-800-567-4797.



SPORTS, FITNESS, PARENTING, RELIGION & SPIRITUALITY

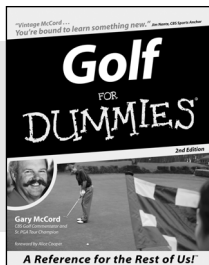

0-7645-5146-9

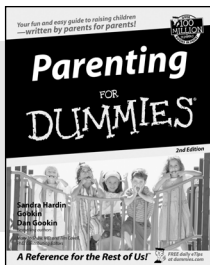

0-7645-5418-2

Also available:

- ✓ Adoption For Dummies 0-7645-5488-3
- ✓ Basketball For Dummies 0-7645-5248-1
- ✓ The Bible For Dummies 0-7645-5296-1
- ✓ Buddhism For Dummies 0-7645-5359-3
- ✓ Catholicism For Dummies 0-7645-5391-7
- ✓ Hockey For Dummies 0-7645-5228-7

- ✓ Judaism For Dummies 0-7645-5299-6
- ✓ Martial Arts For Dummies 0-7645-5358-5
- ✓ Pilates For Dummies 0-7645-5397-6
- ✓ Religion For Dummies 0-7645-5264-3
- ✓ Teaching Kids to Read For Dummies 0-7645-4043-2
- ✓ Weight Training For Dummies 0-7645-5168-X
- ✓ Yoga For Dummies 0-7645-5117-5

TRAVEL

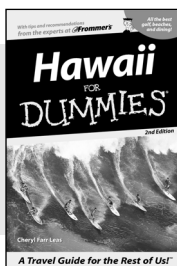

0-7645-5438-7

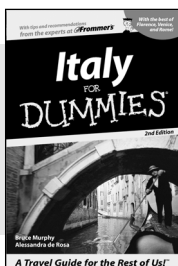

0-7645-5453-0

Also available:

- ✓ Alaska For Dummies 0-7645-1761-9
- ✓ Arizona For Dummies 0-7645-6938-4
- ✓ Cancún and the Yucatán For Dummies 0-7645-2437-2
- ✓ Cruise Vacations For Dummies 0-7645-6941-4
- ✓ Europe For Dummies 0-7645-5456-5
- ✓ Ireland For Dummies 0-7645-5455-7

- ✓ Las Vegas For Dummies 0-7645-5448-4
- ✓ London For Dummies 0-7645-4277-X
- ✓ New York City For Dummies 0-7645-6945-7
- ✓ Paris For Dummies 0-7645-5494-8
- ✓ RV Vacations For Dummies 0-7645-5443-3
- ✓ Walt Disney World & Orlando For Dummies 0-7645-6943-0

GRAPHICS, DESIGN & WEB DEVELOPMENT

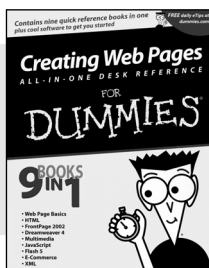

0-7645-4345-8

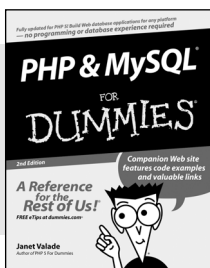

0-7645-5589-8

Also available:

- ✓ Adobe Acrobat 6 PDF For Dummies 0-7645-3760-1
- ✓ Building a Web Site For Dummies 0-7645-7144-3
- ✓ Dreamweaver MX 2004 For Dummies 0-7645-4342-3
- ✓ FrontPage 2003 For Dummies 0-7645-3882-9
- ✓ HTML 4 For Dummies 0-7645-1995-6
- ✓ Illustrator cs For Dummies 0-7645-4084-X

- ✓ Macromedia Flash MX 2004 For Dummies 0-7645-4358-X
- ✓ Photoshop 7 All-in-One Desk Reference For Dummies 0-7645-1667-1
- ✓ Photoshop cs Timesaving Techniques For Dummies 0-7645-6782-9
- ✓ PHP 5 For Dummies 0-7645-4166-8
- ✓ PowerPoint 2003 For Dummies 0-7645-3908-6
- ✓ QuarkXPress 6 For Dummies 0-7645-2593-X

NETWORKING, SECURITY, PROGRAMMING & DATABASES

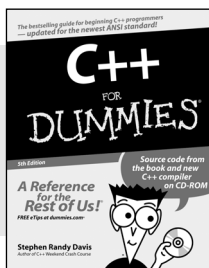

0-7645-6852-3

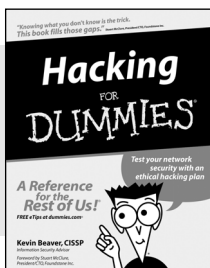

0-7645-5784-X

Also available:

- ✓ A+ Certification For Dummies 0-7645-4187-0
- ✓ Access 2003 All-in-One Desk Reference For Dummies 0-7645-3988-4
- ✓ Beginning Programming For Dummies 0-7645-4997-9
- ✓ C For Dummies 0-7645-7068-4
- ✓ Firewalls For Dummies 0-7645-4048-3
- ✓ Home Networking For Dummies 0-7645-42796

- ✓ Network Security For Dummies 0-7645-1679-5
- ✓ Networking For Dummies 0-7645-1677-9
- ✓ TCP/IP For Dummies 0-7645-1760-0
- ✓ VBA For Dummies 0-7645-3989-2
- ✓ Wireless All In-One Desk Reference For Dummies 0-7645-7496-5
- ✓ Wireless Home Networking For Dummies 0-7645-3910-8