

THE MYSTERY METHOD

How TO PUT BEAUTIFUL WOMEN UNDER YOUR SPELL

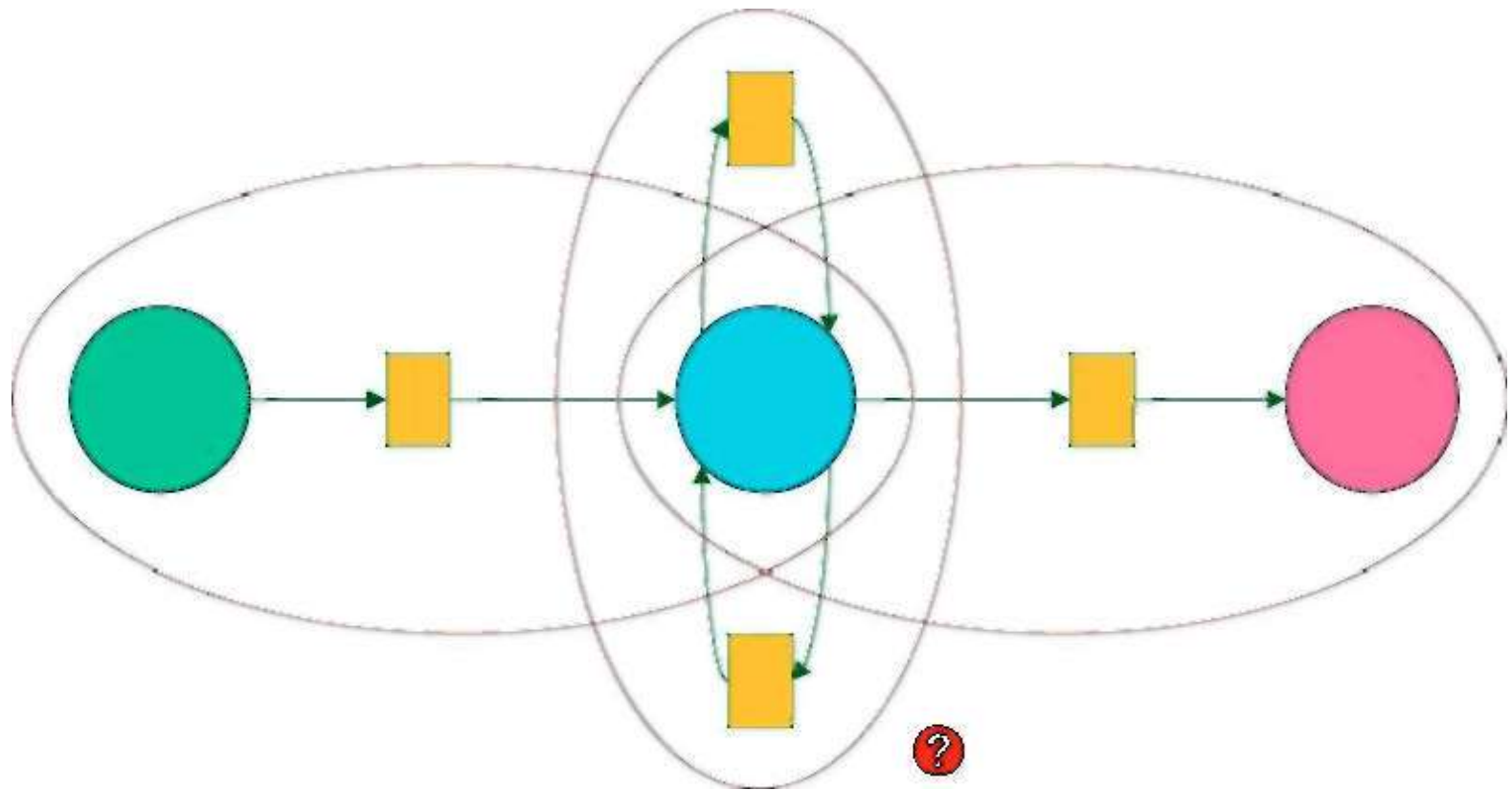

THE VENUSIAN ARTS HANDBOOK

2ND EDITION

PRESS AND TESTIMONIALS

"The World's Greatest Pickup Artist."

— Saturday Night Magazine

"...has single-handedly invented much of the jargon and tactics that men around the world are using to meet women."

— The New York Times

"Desmond Morris, the British zoologist and sexuality expert, admits that the Method is a shrewd compression of the phases of love. 'One of the great mistakes men make is not playing all the stages of courtship,' he says. 'It has to be done stage by stage if it's going to work.'"

- Elle Magazine

"Mystery's disciplinal Don Juans often describe the benefits of the Mystery Method as augmenting not only their romantic pursuits but also their lives in general. They find they become happier, more confident people. Even Neil Strauss, the New York Times' music columnist and author of an article on Mystery, has become one of the method's most devoted followers. 'It's revolutionized my life,' he says."

- Utne Magazine

"What is miraculous is that it works. In four hours, I watch Mystery work his way into five separate groups of people in the nightclub, and target a beautiful woman who wraps her limbs around him in less time than it takes to say impressive. It also worked for his former students..."

- Marie Claire Magazine

"He's like a MAD GENIUS. He sucks women into his reality. It's LITERALLY one of the most @%^ED UP phenomenons I've seen in my ENTIRE LIFE. It's worth it just to SEE IT, let alone what it does to your game. And the cool part is, it's all LEARNABLE."*

- Tyler D

"I was absolutely amazed. My jaw dropped with surprise by how well The Mystery Method works and allows you to easily maneuver through sets to isolate a hot babe and flow quickly from one set to the next."

—Papa

"I did something I thought would be IMPOSSIBLE to do. I approached a set of 6 guys and 1 girl. Played it by the book. The guys even bought me drinks. I was then able to isolate and attract the hot babe without any issues. I instantly dated her immediately. Then, we went to her place. That was my BEST pick-up ever. I never would have dared approach a set like that. Now I can."

~ MTL_PUA

"I have never seen such a display of Alpha-ness in my life. Mystery had the whole VIP lounge eating out of his hand. Guys were high-fiving him and girls were coming up kissing him and getting their pictures taken with him. It was amazing."

- Thundercat

"Saturday night I went clubbing with two other guys, and opened up lots of groups — in fact, I was the leader of our group of three guys, and felt myself generating social proof with every group I opened. I can honestly say that I'm now 500% more comfortable in bars than I was before. Thanks."

- Trevor L.

"I took your workshop in LA two weeks ago.. Last night, I ran the tightest set. I followed your game plan EXACTLY. I went in with intriguing opener, picked the target, got the group to love me, negged/ignored her. I was the center of attention of the entire mixed 6 set. Later, I isolated her, qualified, demonstrated vulnerability, I always knew all tin's stuff should work, but tonight I actually SAW it work in its entirety for the first time. It was amazing that everyone in the group acted according to the plan (group, HB, specific obstacles). Thanks Mystery. Tins took my game to the next level. "

- Ryan C.

"Is it worth the money? Absolutely. Tin's was probably the single weekend with the most impact on my life, ever. Life changing!"

—Veroxii

"Mystery had his students initiating sets with women all over St. Laurent Boulevard and some over at the Jazz Festival which is being held currently in town. There were massive improvements made with several of the students who showed great changes in their skillset and personal appearance in response to Mystery's suggestions about dress, presentation and peacocking. There is a clever method to the madness and it was clear that results were being achieved as the students got familiar with Mystery Method. Mystery demonstrated his mastery Saturday evening when he approached two women (10's) who completely and totally froze him out on his approach. They gave him a reaction as cold and disinterested as any I have ever seen. Mystery left them, waited a minute or so, went back into the set, left, went back again, and again, and within 5 minutes tops these two women were in rapt attention, fawning over him, the target with her arm draped around his. It was completely masterful to watch."

- Cliff

"I sincerely wanted to thank you for some of the keen insight and guidance that you've provided me over the last few weeks (especially tin's past weekend)...I frequently find myself laughing with pure delight at your genius. It's awesome!!"

-Alec

"Fantastic weekend, I'm still assimilating the tilings you taught... you've totally changed my game for the better. I can't possibly imagine how much time and research you had to put in to tin's stuff."

-Mad Dash

"You totally rock. I can't tell you how much the weekend exceeded my expectations. I really learned a lot more than I imagined I could, even if most of it was from watching you guys inadvertently steal all my girls ;-) I have to admit I was very skeptical about paying the money for the workshop - mostly because I had heard about most of the material before and had tried it without REALLY understanding it at all. Now I KNOW it works, and am starting to understand how working and internalizing a few key understandings and techniques will really take my game to an entirely new level. I'm looking forward to applying tin's understanding to the 100+ sets a month I expect to continue to work!"

- Lance

"Mystery was very inspirational and I saw his method work right in front of my eyes when he was kissing a girl (complete stranger) within 10 minutes of entering a bar. His method of approaching women (and groups of people in particular) has to be seen to be believed. And I would recommend anyone who is flunking of doing his workshops to do so . . . fast. My skills and confidence has lifted up to a whole new level after the last workshop with him. Not only do I now have the skills to approach groups of girls, but also mixed groups (guys and girls) which I would not have done before. His practical encouragement and methods are so easy to learn that anyone who is serious about having LOTS of choice with women must do his workshop. The best thing about Mystery's workshops is the small numbers they accept and the very specific one-on-one feedback he gives you right on the spot to correct any mistakes. Since coming back home, I have had so many amazing experiences with beautiful women that it is almost like a dream. It's as if Mystery gave me the wings to soar above all the other AFCs and take my pick of all the beautiful women out there, swoop down and carry them off at my leisure. It's so easy for me now..."

- Pierre

"I attended the Mystery Sex Magic workshop in Sydney. The first day he arrived at our pre-arranged meeting place, Mystery. . . stood out from the moment he entered the room. Mystery KNOWS his stuff. This guy is as good as anyone say he is. He was able to have HOT girls BEG him to take his number. I have NEVER seen a girl beg someone to take a guy's number after knowing the guy for 20 minutes! He was able to consistently attract the honest girls in the largest group (with some intimidating guys in the group) in the club. I could see myself improved DRAMATICALLY. I was able to run full routines on girls (chickened out on kiss-closes because I didn't have the particular routine to go on with - damn!) and ended up with two meet-closes. I met one yesterday (something I wasn't able to do before the AIM workshop) and will be meeting one on the weekend. So all in all, it was worth the money spent. My game has improved dramatically, and will continue to improve once I implement Mystery's suggestions to my game. The very least is the realization that the 20 minute PU is possible. I have seen it with my own eyes."

-Jeff C.

The Venusian Arts Handbook

A personal note from Mystery:

This book represents the culmination of my life's work, which is my only source of income. It has taken over twelve long years to develop the theories described inside, many of which I have previously posted for free on the internet. Over the years, those posts have revolutionized pickup and seduction theory, and have changed thousands of lives. The pickup community has been enriched by my ideas and my teachings — that has been my gift to you. *So to those with the capability and inclination to pirate this book, I ask that you please do not.* This much respect I believe I have earned and am due. Thank you again for your interest and maybe we'll meet someday in the field.

Love,
Mystery

Copyright © 2005, Mystery Method Corporation

"Mystery Method" and "Venusian Arts" are trademarks used by The Mystery Method Corporation LLC, all rights reserved. This book may not be reproduced in whole or in part without express prior consent. All violations will be prosecuted to the fullest extent of the law.

Each book is individually numbered and coded and can be individually identified. This individualized coding includes the buyer's name, credit card number, billing address, expiry date, and cvv number. Each book contains at least one deliberate typographical error - automatically generated in each book sale - and small variations in wording that are unique. Any book, or segment thereof, can be traced back to its original owner. Through the security software you are using, once we have identified a copy that is not being used by its original owner, that "invisible" biographical information can be made visible. Pirates are much more interested in identity theft and credit card fraud than they are in ebooks.

We have retained the Agency Security Group, Inc. to actively search file-sharing programs and sites to track those down who participate in intellectual property theft. We have also set up a reward system for former students to identify illegal activity by offering to trade or buy books.

By opening this file, you agree that you will be held liable for civil damages including, but not limited to, lost sales and enforcement costs, if you share this book or any portion thereof with anyone else. We will also do everything in our power to make that these civil proceedings (and the nature of the book) as public as possible.

If you do not agree with these terms of use, please return this unopened file for a full refund within 24 hours of purchase to legal@mysterymethod.com

THE VENUSIAN ARTS HANDBOOK

THE MYSTERY METHOD

This book contains a basic and complete description of the Mystery Method. It is intended to serve as a standard text and handbook for the practicing venusian artist.

Contributions

- **Mystery** conceived the ideas and concepts in this book. It is ultimately a product of his genius.
- Substantial portions of the book are also written by Mystery's own hand.
- Lovedrop (bookcomments@mysterymethod.com) produced, co-wrote, and edited the book.
- Style contributed various articles found throughout.
- Content has also been included from Sinn (on compliance momentum), Wilder (on storytelling), and Toecutter (on winging).

www.MysteryMethod.com

This PDF created in 2005

*I have dedicated my life to
exploring and understanding
humanity.*

*The Mystery Method is my humble
yet ambitious attempt to solve the
greatest mystery in the universe:
Women.*

*This work is compassionately
dedicated to four much loved
women:*

Christa, Martina, Shalyn & Kaitlyn.

Table of Contents

<i>Introduction</i>	<i>iv</i>	<i>Structure and the Game</i>	<i>37</i>
<i>Who is Mystery?</i>	<i>vi</i>	<i>The Game is played in the Field</i>	<i>37</i>
<i>Forward</i>	<i>viii</i>	<i>The Mystery Method Newbie Drill</i>	<i>35</i>
<i>The Ultimate Purpose of Life</i>	<i>1</i>	<i>Calibration and Internalization</i>	<i>35</i>
<i>The Penultimate Purpose of Life</i>	<i>2</i>	<i>Process over Outcome</i>	<i>39</i>
<i>Your Purpose in this Life</i>	<i>3</i>	<i>The Sexual Relationship</i>	<i>40</i>
<i>Dynamic Social Homeostasis</i>	<i>9</i>	<i>Courtship</i>	<i>41</i>
<i>A Biological Machine</i>	<i>10</i>	<i>Attraction</i>	<i>42</i>
<i>Survival and Replication Value</i>	<i>11</i>	<i>The M3 Model</i>	<i>48</i>
<i>Alignment</i>	<i>11</i>	<i>The Four M3 Sequencing Mistakes</i>	<i>50</i>
<i>Pair Bonding</i>	<i>12</i>	<i>Gaming Locations</i>	<i>63</i>
<i>Rejection and Approach Anxiety</i>	<i>13</i>	<i>Location Changes</i>	<i>64</i>
<i>Maslow's Hierarchy of Needs</i>	<i>14</i>	<i>The Nine Phases of the M3 Model</i>	<i>65</i>
<i>Social Status and Behavioral Circuitry</i>	<i>21</i>	<i>Putting It All Together</i>	<i>67</i>
<i>Women select for survival and replication value</i>	<i>22</i>	<i>A1: The Approach</i>	<i>69</i>
<i>Identity</i>	<i>24</i>	<i>The Meeting Location</i>	<i>69</i>
<i>Image</i>	<i>24</i>	<i>Proximity</i>	<i>71</i>
<i>Peacocking</i>	<i>25</i>	<i>The 3-Second Rule</i>	<i>72</i>
<i>Creatures of Sentiment</i>	<i>26</i>	<i>Social Proof</i>	<i>73</i>
<i>Social Awareness</i>	<i>27</i>	<i>Tips in the Venue</i>	<i>74</i>
<i>Intuition over Analysis</i>	<i>29</i>	<i>The Protection Shield</i>	<i>75</i>
<i>Congruence Tests</i>	<i>30</i>	<i>Canned Material</i>	<i>77</i>
<i>Investment</i>	<i>31</i>	<i>Proper Delivery of Material</i>	<i>78</i>
<i>Discomfort and Confrontation</i>	<i>32</i>	<i>Opinion Openers</i>	<i>79</i>
<i>Fun and Stimulation</i>	<i>32</i>	<i>False Time Constraints</i>	<i>86</i>
<i>Women are Dangerous Creatures</i>	<i>33</i>	<i>How to Open Seated Sets</i>	<i>87</i>
<i>Rating Women</i>	<i>33</i>	<i>How to Open Moving Sets</i>	<i>89</i>
<i>Cat Theory</i>	<i>34</i>	<i>What most people do wrong when approaching</i>	<i>90</i>
<i>Boyfriends</i>	<i>35</i>		

A2: Female-to-Male Interest	93	C1: Comfort and Conversation	159
<i>Indicators of Interest (IOIs)</i>	93	<i>The Freeze-Out</i>	160
<i>Neg Theory</i>	97	<i>Comfort Building Locations</i>	162
<i>Demonstration of Higher Value (DHV)</i>	104	<i>The Five Location Types for Gaming</i>	164
<i>Group Theory</i>	105	<i>The C1 Location</i>	165
<i>Multiple Conversational Threads</i>	107	<i>Moving to C1</i>	166
<i>Winging</i>	112	<i>Conversational Rapport</i>	168
<i>Storytelling</i>	115	<i>Commonality</i>	171
<i>Locking-In</i>	119	<i>Conspiracy</i>	172
<i>Role-Playing</i>	121	<i>Vulnerability</i>	173
<i>False Disqualifiers</i>	121	<i>Punishment / Reward</i>	174
<i>Various Group Scenarios</i>	124	<i>Jealousy Plotlines</i>	175
<i>Pawning</i>	127	<i>Grounding</i>	179
A3: Male-to-Female Interest	131	Mid-Game and End-Game	185
<i>Frame Control</i>	132	<i>The Seven Hour Rule</i>	185
<i>Hoop Theory</i>	134	<i>Kissing</i>	187
<i>Role-Reversal</i>	136	<i>The C2 Location</i>	190
<i>Having Standards</i>	138	<i>The Bounce</i>	191
<i>Screening</i>	139	<i>The Time Bridge</i>	192
<i>Intermittence</i>	140	<i>Phone Game</i>	195
<i>Kino Escalation</i>	141	<i>Dating</i>	197
<i>Takeaways</i>	145	<i>The C3 Location</i>	200
<i>Compliance</i>	146	<i>The Sex Location</i>	201
<i>Token Resistance</i>	151	<i>Moving from C3 to SI</i>	202
<i>Qualifiers</i>	152	<i>S2: Last-Minute Resistance</i>	203
<i>Compliments</i>	153	<i>S3: Sex</i>	205
<i>Bait - Hook - Reel - Release</i>	154	<i>Waypoints</i>	206
		<i>Sticking Points</i>	206



"Mystery, one of the most admired men in the world of seduction."

~ **The New York Times**

Who is Mystery?

Mystery is the alter-ego of entertainer Erik von Markovik. He is the world's foremost expert in the art and science of social dynamics. His exploits have been covered by publications such as Elle, The Montreal Gazette, Las Vegas Life, Saturday Night, Marie Claire, and The New York Times.

Exploding onto the seduction community in the late 90s, Mystery quickly gained underground fame for his groundbreaking contributions to the art. Mystery was the first to pioneer and offer live, in-field instruction, and he has trained thousands of students all over the world, including a **Who's Who** of the most respected pickup artists in the community.

*"If you can't attract a woman,
you are, by dictionary
definition, sterile."*

~ Mystery

Forward

Nature will unapologetically weed your genes out of existence if you don't take action and learn how to attract women now.

Do I have your attention?

Good, because attracting women is a serious matter. You feel this to be true or you wouldn't take the effort as you are now to read this book in its entirety. Of course this doesn't mean the process of attracting women can't at times be super fun!

If you want to be a multi-millionaire and have wealth mastery, you need a proven wealth building game plan right? If you want the body of your dreams and have health mastery, you need a proven body building game plan too. Well, what if you want to have beautiful women in your life and have relationship mastery? The Mystery Method, or MM, is your proven game plan for building a lifestyle rich with choice, and if you'll allow me, I'll be your personal mentor to see that you learn it thoroughly.

It's no secret I've dated some of the most beautiful women in the world, and I make no apologies for this. Beauty is but one of many qualities I look for in a female companion. Now, I never identified with being a pickup artist in real life, nor should you, but it was always flattering to have friends ask how I got such stunning girlfriends. So I began to informally teach them my secret of attraction. With this knowledge, soon they too had beautiful girlfriends.

*"May the venusian arts enrich
your life; not define it. "*

~ Mystery

Over the years these informal discussions with friends developed into info-packed seminars and action-packed in-field workshops where I literally brought men into night clubs and other social gatherings to systematically train them to approach and attract women. Between my magic shows, I've conducted literally dozens upon dozens of them all over the world and have personally helped hundreds of men learn what their dad never taught them.

I am privileged to share over ten years of experience with the science of social dynamics and the art of the cold approach pickup so that I may dramatically accelerate your learning curve and save you years of painful frustration and loneliness.

Love,

Mystery

(a.k.a.: Erik von Markovik)

mvstery@mysterymethod.com

The Ultimate Purpose of Life



Without survival, there is no life.

All life on Earth has been designed by evolutionary processes to replicate. This is nature's long-established *engine of survival*.

The Penultimate Purpose of Life

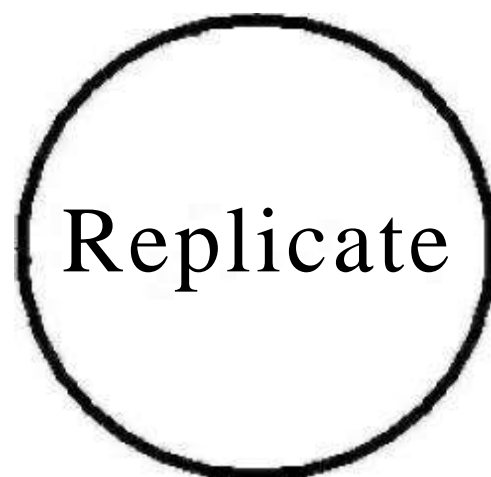

While the primary purpose of your life is to survive, your secondary purpose is to replicate.

In humans, natural selection has favored a method of replication **which** allows for genetic variation. Just as a superior basketball player limited by lousy team-mates must escape and join a better team if he is to **win**, so too must a superior gene *escape* from its inferior *gene-mates* and be given a chance to join a better *genetic team* for its continued survival. This method of *escape* is called crossbreeding.

Over successive generations, crossbreeding has allowed you — that is, your genes — to *anticipate* changes in a dynamic physical and social environment, thereby increasing your chances for survival.

Put simply, replication is a means of *continued survival*

Your Purpose in this Life

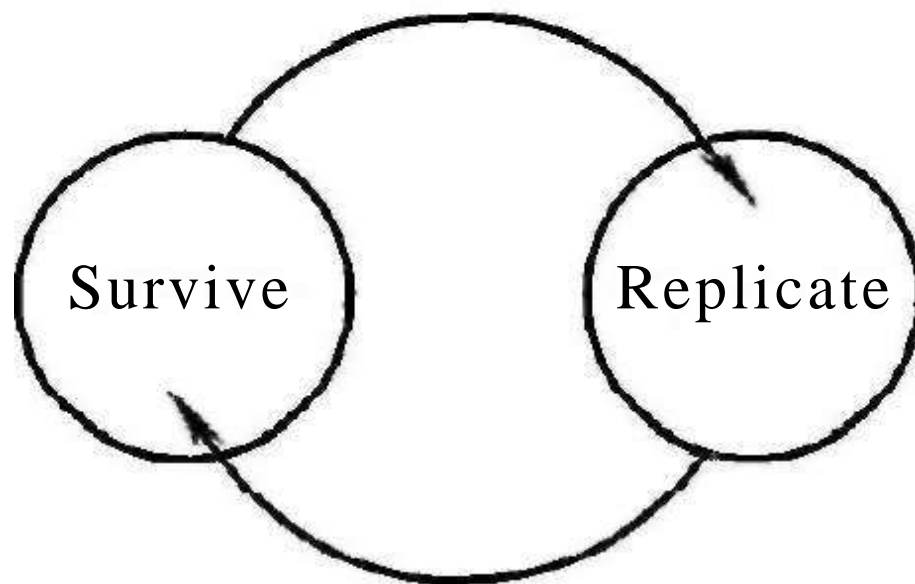

You are a biological machine.

Your motives in this life are simple, but not simplistic: To live and love.

In order to successfully crossbreed, you must acknowledge that, without revolutionary technological advancements, you will some day die.

Question:

*Without calculating, just by feeling,
how many DAYS do you feel the
average American lives?*

(A) Tens of thousands of days?

(B) Hundreds of thousands of days?

(C) Millions of days?

(D) Billions of days?

DO NOT turn the page until you have chosen A, B, C, or D.

Answer:

(A) Tens of thousands of days.

In fact, it is only 28,251.

You have, on average, 28,251- days to live out your life. This assumes you are smart enough to *survive* this long. Even if you live to be a hundred, that is still only 36,500 days.

Your Human Life Timeline

Age in Days	Stage	Years
0 to 5,000	Childhood	Birth to 13 ¹ / ₂
5,000 to 6,750	Adolescence	13 ¹ / ₂ to 18
6,750 to 10,000	To Adulthood	18 to 27
10,000 to 15,000	To Middle Age	41
15,000 to 23,725	To Old Age	65
23,725 to 28,251	To Current Life Expectancy	77.4
28,251 to 36,500	To Becoming a Century Old	100

The universe requires only two things from you: that you survive and replicate. Your challenge is to do so before your limited life-span naturally expires. The most logical course of action is simple:

- Acknowledge the need to accelerate the learning curve through disciplined focus.
- Obtain useful survival and replication strategies from others.
- Through practice and training, internalize this knowledge into our automated motor response for practical real-life application.

According to the National Center for Health Statistics in 2002.

There are many ways to help you survive. One such way is to learn the martial arts. There are also many ways to help you replicate. One such way is to learn the venusian arts.

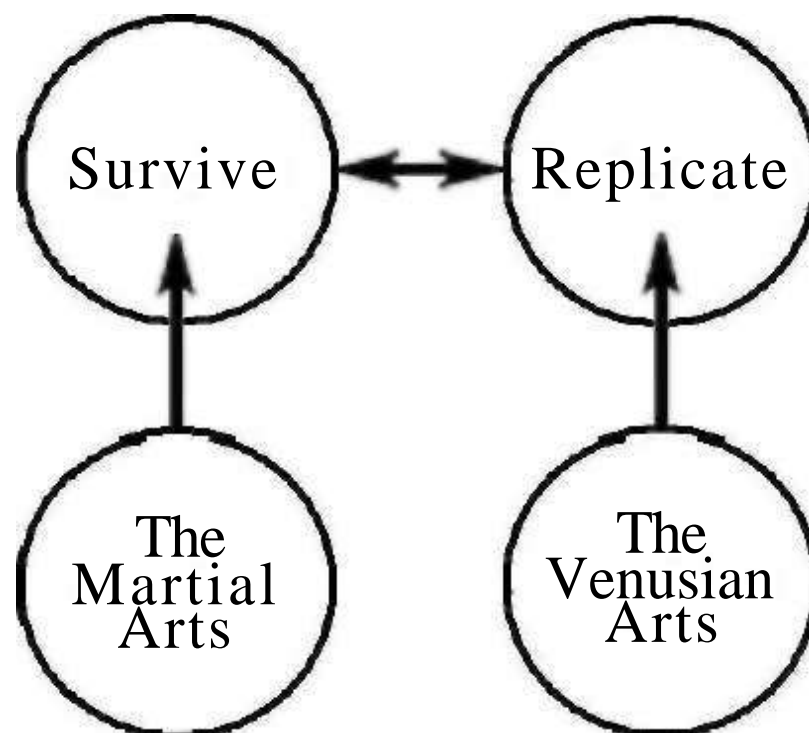

The Martial Arts (The Art of War) is the art of self-defense. It is a discipline **which** aids *survival*.

- **MARTIAL:**

*[Roman god of war] Of, relating to, or suited for war or a **warrior***

The Venusian Arts (The Art of Love) is the art of successfully beginning an ultimate relationship with another person whom you have not previously met. It is a discipline which aids *replication*.

- **VENUSIAN:**

Of or relating to the planet Venus, Roman goddess of love and beauty

Training for Survival, or Replication?



There is more to winning a fight than simply punching first, and as any martial artist knows, the stronger man does not always win. Preparation and training can mean the difference between *surviving* and dying.

Similarly, there is more to successfully beginning a sexual relationship than simply being good looking enough. A good game plan expertly executed can mean the difference between *replicating* and having your genes unapologetically weeded out of existence.

The martial arts and the venusian arts possess many parallels.

- Both are disciplines in dynamic social interaction, and each is for many, a way of life.
- Both rank proficiency; colored belts for martial artists and colored charms hung on black cords for venusian artists.
- Each also embodies a comprehensive mental element **which** is expressed through physicality.

However, in the martial arts it is sometimes best to not engage in a given social interaction. In the venusian arts, the only way to succeed is to have one.

Bruce Lee's fighting style *Jeet Kune Do* (Way of the Intercepting Fist) is a martial arts style. Similarly, Mystery's *MM* (The Mystery Method) is a venusian arts style

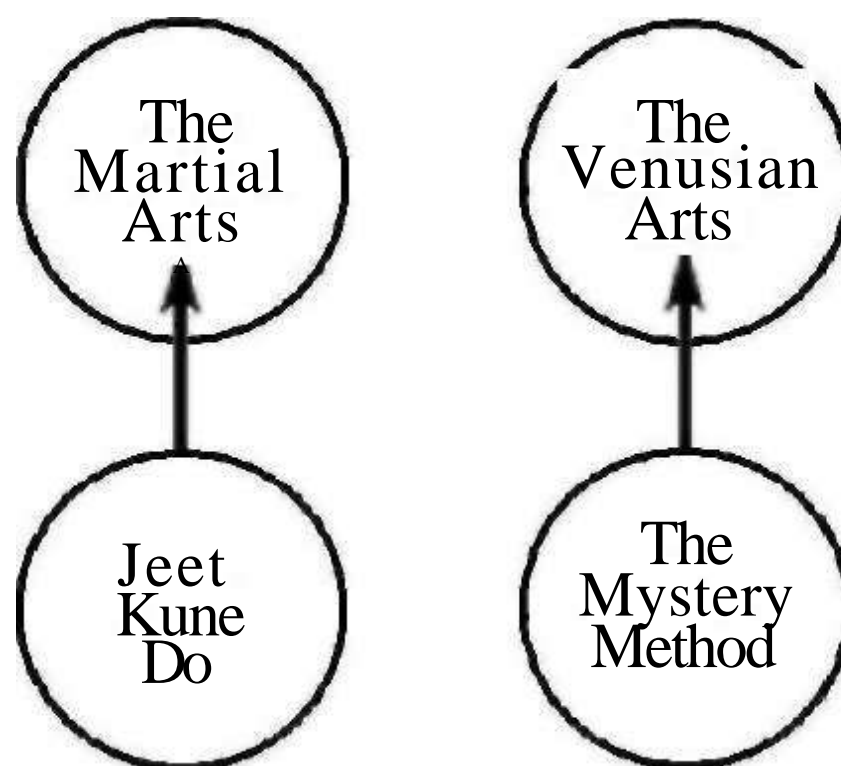

Bruce Lee was a legendary martial artist. Yet his life's accomplishments reveal that being a martial artist was only one-half of a greater whole. It's no secret Bruce also identified with other — socially rewarding — pursuits. He was a great actor and a celebrity. He was a great leader and role-model. He was a great teacher and a great father. He was defined by more than *a martial artist*. Defined by his more social roles, he was also *a venusian artist...* and a good one.

Like Bruce Lee, all people live under constant pressure to balance between protecting themselves *from* others and aligning themselves *with* others. This balance is called *dynamic social homeostasis*.

Dynamic Social Homeostasis



There would be no replication if men or women over-protected themselves by never leaving their homes. Yet there would also be no need for the venusian arts if men or women remained completely naive and did not worry about protecting themselves and their loved ones when they met new people. You can neither have too much nor too little of either. If you do not have *dynamic social homeostasis*, you compromise your probabilities of successfully surviving or replicating.

Your mind has been *designed* by natural selection to powerfully emote in ways that contribute to both your survival and replication. Your emotions carry out an evolutionarily stable strategy that aims to keep you in *dynamic social homeostasis*.

A Biological Machine

You are a biological machine. While unimaginably sophisticated, you are however literally an out-of-date model.

Nature has simply not *designed you* for the world in which you currently live. This is because the world, as it is today, has never existed before.

Certainly our physical environment has changed little over the past 100,000 years. Trees, sky, and rain remain the same. It is our social environment that has undergone a dramatic change. We live in the midst of an unprecedented population explosion. Never in Earth's history have there been so many similarly designed human machines existing at any one time.

As of writing there are an estimated 6.45 billion people living on our planet today. It is predicted that in only thirty years there will be close to 10 billion people.

When Mystery was born in the 1970's there were 4 billion people living on the planet. Around the time of Casanova in the mid 1700's., there were only 750 million people. 10,000 years ago, there were only 30 million people. Looking further back in time to around 120,000 years ago, there were only 10,000 to 40,000 humans living on the planet.

Our struggle for survival and replication comes from a dynamically changing social environment. Ever since humanity came into existence, we have been faced with the challenge of trying to keep up with and adapt to a constant increase in our population.

Life in a small town is very different than life in a big city. Consider the differences between living your entire life in a small tribe of fifty to sixty people, and living in a city of twelve million. Nature has not yet had a chance to adapt your design to the new social environment.

+ According to the population division of the US Census Bureau in 2004.

Life's adaptations always lag behind changes in the environment. First the environment changes, and only then can humanity slowly adapt to those changes.

Your body — and more importantly to your replication — your emotional circuitry, has not yet had the chance to adapt to today's social environment and the new challenges it brings.

You are an out-dated machine, a prisoner in time, designed for an ancient environment which no longer exists. You are instead best adapted for an ancient environment and tribal social order that once existed sometime between 40,000 and 60,000 years ago.

Survival and Replication Value

People are designed to select in favor of higher survival and replication value. When a woman observes two men, her circuitry will quickly assess the survival value and replication value of each man. She will then *emotionally perceive* the result of this calculation. She will naturally be attracted to the man with the highest value. The healthiest man, the most intelligent man, the most socially-connected man, the most financially independent man, the most sexually pre — selected man — these sorts of traits will attract the woman because such a man provides survival and replication value to her, as well as to her offspring.

Alignment

People tend to form social alignments with one another, wherever such alignments benefit their chances of survival and replication. For example, a primitive tribe is a form of social alignment. Those within the tribe have improved chances of survival they wouldn't normally have if they were alone.

Another example of alignment is a modern-day celebrity entourage. Entourage members enjoy increased access to sex. Even though the entourage member is not a celebrity, he has still improved his survival and replication value through his association with the celebrity.

Pair Bonding

A pair bond is an emotional bond associated with a sexual alignment; beginning prior to pregnancy and continuing up through child-rearing. (From an evolutionary perspective — and thus from an emotional perspective — pregnancy and pair bonding are the same thing, since effective birth control has only recently been invented.)

Pair bonding has been described as a compromise between the competing sexual strategies of the man and the woman. Also known as a "romance," it occasionally lasts a lifetime, though in our modern society most pair bonds average only several years or months in length-

It is worth noting that, from an emotional perspective, the woman places her survival itself in great danger by having sex. Evolutionarily speaking, if a man impregnates her, she is dependent upon her pair bond with him to protect her and provide for her during this vulnerable time. If he is not pair bonded with her, he is likely to move on and she will not have access to his resources. Worse, her reputation as a "slut" will also lower her status within her social network, further jeopardizing her survival and replication prospects.

The man faces no such physical or social repercussions for engaging in sex, and thus men often do it quite indiscriminately. Sex represents a much greater risk to a woman than it does to a man.

Sex also represents a much larger *investment* for a woman than it does for a man. Her reproductive years are fewer than his and her time spent producing each child is much greater as well — ten minutes of sex for him, nine months of pregnancy for her.

The result of this is that women are considerably choosier than men, and it is also much more important to a woman that a pair bond exists before she will engage in sex. For this reason, due to natural selection, women often experience anxiety just before having sex the first time with a new lover. It's not her fault — this *last-minute resistance* is a pre-programmed emotional response. Her emotions are only trying to do what's best for her.

Rejection and Approach Anxiety

Logically, rejection causes us no harm. But emotionally, rejection can be a punishing experience. To understand this, we must look at the ancient environment for which we were designed.

In a tribal group, there will be some small number of available women of breeding age. When a man approaches one, he risks rejection, and if that happens, all the other women will know, which will diminish his value in their eyes — maybe to the point where none of the women will mate with him. This is called *preselection* — women look for social validation of their choices. A suitor who is *preselected* will be more attractive, whereas a man who has been rejected will be less so.

Another factor regarding approach anxiety is the possibility that she may already be taken, in which case there is a component of real, physical danger to any male who approaches her.

For all these reasons and more, men are naturally selected to experience approach anxiety. Logically, of course, modern society fixes these problems. If I am rejected, I can simply go to another part of the bar, or leave the bar entirely. I will probably never see any of those people again. But my emotions don't know that. My emotions are trying to do what's best for me.

So how can you avoid rejection?

The answer is: you can't. It isn't the solution to avoid being vulnerable. Rather, the solution is to embrace your vulnerability, to embrace rejection, and let the Field show you what is good and what is bad. Most approach anxiety is a result of imagined rejections, not real ones. Eventually, time in the Field will desensitize you to the emotion of rejection. In a game where you might play five or ten sets every night, losing a few of them here and there never really seems like a big deal.

And remember, if you don't make it happen, Nature will unapologetically weed your genes out of existence.

Maslow's Hierarchy of Needs

Bound by the human condition, you have a *hierarchy of needs* and *everything* you do is directly or indirectly a result of emotions that do nothing less than *demand* you meet them.

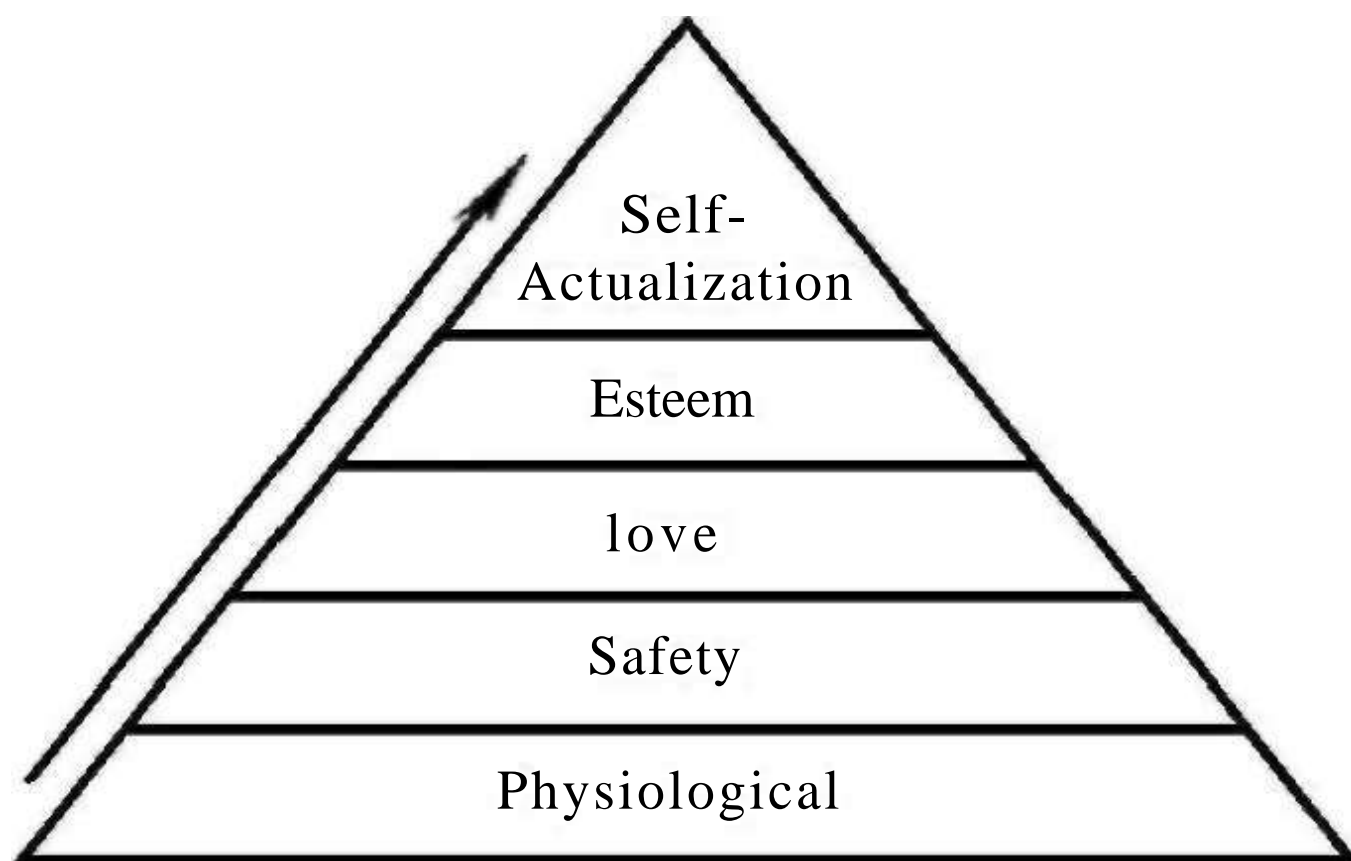

Established by psychologist Abraham Maslow, this theory states that human beings are motivated by unsatisfied needs, and that certain lower needs must be satisfied before higher needs can be.

For example, if you were choking right now, the need to breathe would be stronger than your need to be loved. Let's face it; you won't be if nobody loves you.

P h y s i o l o g i c a l : These needs include very basic needs such as air, water, food, warmth, sleep, and sex.

S a f e t y : These needs have to do with establishing stability and consistency in a chaotic world and are mostly psychological in nature.

L o v e : People desire to be loved and accepted by others. We need to belong-.

E s t e e m : There are two types. Self-esteem results from competence or mastery of a task, while attention, recognition and social status comes from others.

Self-Actualization: We desire to become everything that we are capable of becoming. People who have all lower needs met can maximize their potential.

More information on *Maslow's hierarchy of needs* may be found online.

To meet every need on *Maslows hierarchy of needs* and satisfy the function of your highly evolved emotional system, thereby fulfilling your purpose in life, there are three vital areas you must focus on. Every time you have marked success in any of these areas, your mind rewards you with a feeling of *happiness*.

Vital Areas of Focus

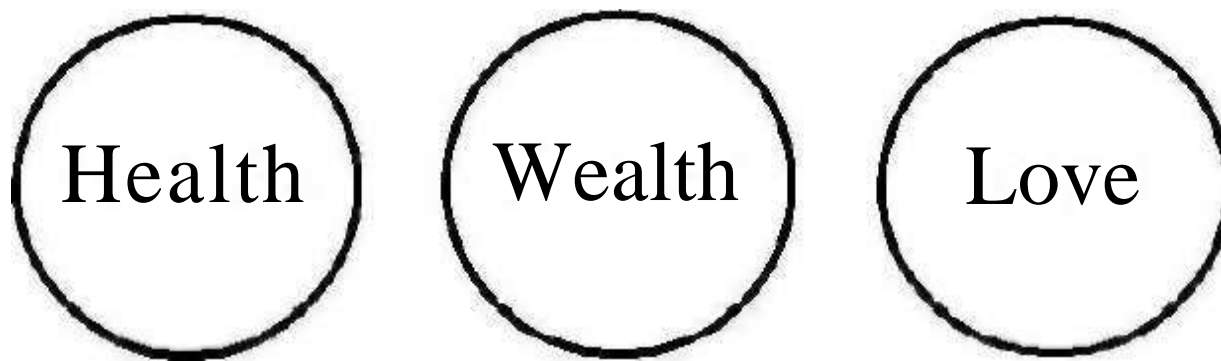

This simple model is as old as the Kabbalah, and success in the three areas of *health, wealth, and love* will ensure your survival and replication.

H e a l t h : Health refers to both the physical and the mental — body *and* mind. You need a proven method or *game-plan* to maintain your health.

W e a l t h : Wealth helps you to maintain your health and your relationships. You need a roof over your head, clothes on your back and food in your stomach. Additional creature comforts assist in your survival and replication. An apartment may keep you warm and dry, but also provides a private location for sex. A vehicle not only enables you to make money, but also improves your romantic options by increasing your effective range. You need a proven wealth building game-plan to have financial independence and to *fund your game* for romantic pursuits. It also costs money to have a gym membership, dress well, and socialize at a nightclub or restaurant

LOVE (Relationships): This refers mainly to your loving relationships, but may also extend to friendships, family members, and business relationships. If you want to have loving relationship success, you must study relationships *and* in particular how to begin one.

You may *maintain* an area, *improve it* or *neglect it* If you rate your success in any area from 1 to 10, a 10 requires you to only maintain it. If the rating is below 10, you will need to devise a way to improve your success in that area. If you neglect an area too long then the quality of your life will decline.

Each *vital area of focus* is bound to the two other areas in countless ways.

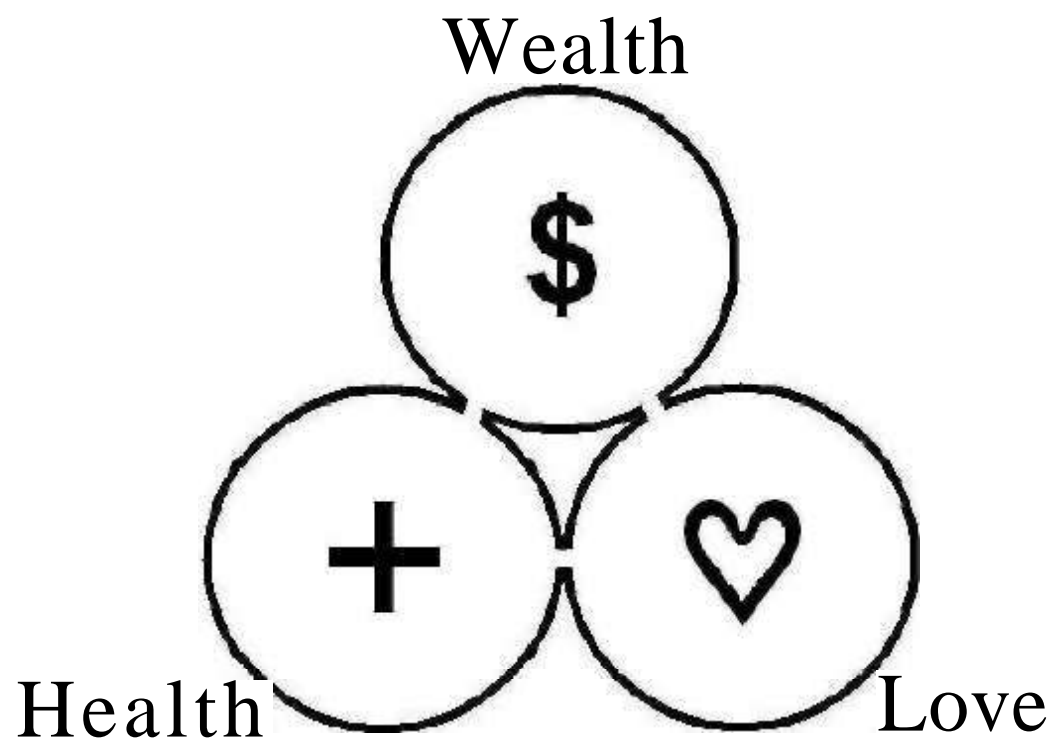

Success in any one vital area will positively affect the other two, while neglecting to maintain any one area will negatively affect the other two. When you neglect an area for far too long the effects can quickly infect a second area. The second area's negative effects can then cascade into a third area, and so on. This runaway chain reaction is called *spiraling* and if left unbridled can undermine your life's prime directives. Rationing your time equally among all three vital areas is crucial in preventing a downward spiral which can lead to a *great collapse* (sickness, poverty, and loneliness).

Sometimes, to improve in a certain area you must first focus on and improve another area. For example, you can increase your success in love by maintaining or improving your health or your wealth.

Healthy wealthy and *love* share an intimate relationship with each other.

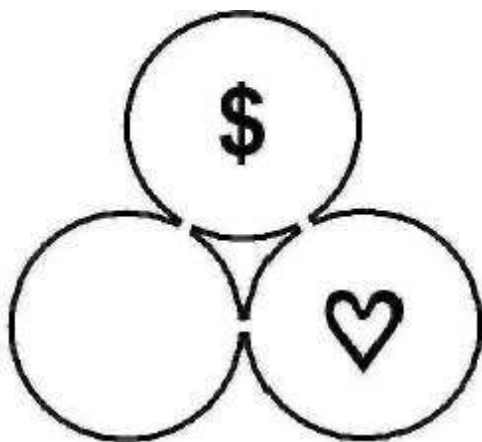

Health Neglect: If you have *wealth* and success in *love* (relationships) but are lacking in *health* (mental or physical), you'll have decreased success in the area of wealth with lowered productivity and energy levels, as well as in the area of relationships. People who don't respect themselves are seldom respected by others. Unhealthy people are simply not attractive.

Wealth Neglect: If you have *health* and relationship success (*love*), but fail in the area of *wealthy* you won't have the resources to pursue *love* (unable to pay cover charges for instance) nor have the means to maintain *health* (proper food, healthy physical environment, and exercise equipment). A big bed in your own condo not only allows you to sleep better than on your parent's couch (*health*), but also rewards you with a place to bring a woman (*love*).

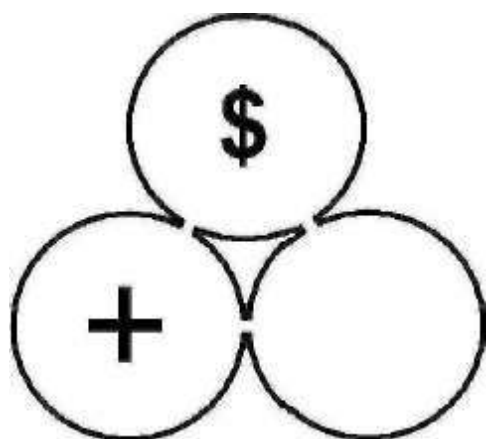
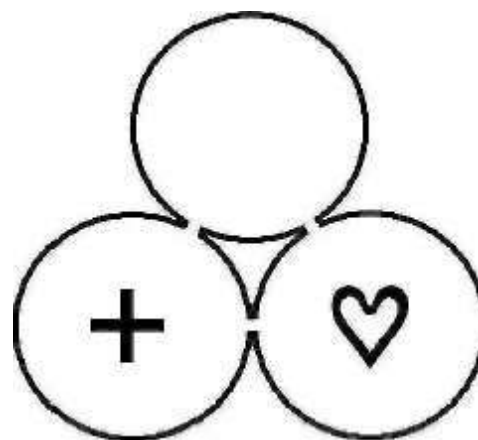

Love (Relationship) Neglect: If you are *healthy* and *wealthy*, but you don't have success in your relationships, this failure will make you feel lonely and compromise your self-esteem (*mental health*). It will also undermine your wealth building plans. For business relationships, you'll have a tough time making new contacts, networking, and you'll appear less together which will affect your *wealth* building potential.

You must maintain or improve all three vital areas of your life with balance. If you aren't getting the results you want while practicing your game, it might be useful to examine your social life in general, your health and fitness, and your career.

Chapter One Review

- The ultimate purpose of life is survival.
- The penultimate purpose of life is replication. Someday you will die. Before that time comes, you must pass on your genes.
- The average person lives for just 28.251 days. The logical course of action is to determine the most effective way to survive and replicate, and practice this until it becomes an automatic response.
- The Martial Arts consist of practiced routines that, once internalized, improve your survival chances. The Venusian Arts consist of practiced routines that, once internalized, improve your replication chances.
- *Dynamic Social Homeostasis* is the balance between the drive to protect ourselves from others and the drive to align ourselves with others.
- Our emotional circuitry is designed to best suit our survival and replication needs, based on an ancient environment and tribal social order that once existed tens of thousands of years ago.
- People make sexual decisions largely based on this emotional circuitry.
- People tend to form *social alignments* with one another, wherever such alignments most benefit their chances of survival and replication.
- *A pair bond* is an emotional bond associated with a sexual alignment, beginning prior to pregnancy and continuing up through child rearing several years later.

Women take a much larger risk, evolutionarily speaking, when they have sex. Sex is also a much larger investment for them than it is for men. For this reason, women have emotional circuitry designed to take this into account. For example, women tend to experience much more anxiety just prior to sex with a new lover.

Men take a larger risk than women when first approaching. In ancient times, this posed a legitimate safety concern and thus men still experience *approach anxiety*.

Women tend to look for social validation of their choices. For example, a woman will find a man more attractive if he has already been *preselected* by other women.

Bound by the human condition, everyone has a hierarchy of needs that must be met, including physiological needs, safety needs, social needs, and so on.

Our emotions are designed to motivate us to get these needs met.

There are three vital areas of life we must focus on: Health, Wealth, and Love. Deficiencies in any one of these categories will cause problems to surface in the other two.

Social Status and Behavioral Circuitry

Emotions are circuits in the brain that judge value and create motivation. They are designed to keep you alive and to replicate your genes. It is interesting to note that the various emotions don't have to be in agreement with each other. You can be happy about something but simultaneously disappointed about it as well. You can enjoy someone's company but also find them completely unattractive sexually. You can yearn for something but then be unhappy when you get it. It isn't necessary for these emotions (and the behavior they generate) to be logically consistent — it is only necessary that they keep your genes alive.

What do women want? Their various drives and motivations are often in conflict. She may desire a strong, alpha man. But when she acquires one, she may set about turning him into a beta male, bit-by-bit, as a natural nesting instinct. If she succeeds and he is tamed, then she will feel reassured in her feminine power but simultaneously she will find him less attractive as a result.



Can she ever truly be happy? It doesn't matter. In the grand scheme of things, her emotions don't *have* to keep her happy. All they have to do is keep her alive. (And get her pair bonded and pregnant with the right man.)

It's true that sometimes it can be frustrating that her behavior is governed by her emotions. But there is power to be had because of this. Through experimentation, we can discover the mechanisms behind her behavior and through practice we can consistently control them.

Practicing the game is not unlike the movie *Groundhog Day*, where Bill Murray re-lives the same day over and over again for what seems like years. Each day he tries to pick up the same girl, and her responses are different as he tries new tactics from day to day. Over time his skills improve and he gets closer and closer to his goal.

If the right switches are flipped, she will feel attraction and she won't really have a choice about this. Similarly, if the wrong switches are flipped, she will lose attraction and she won't have a choice about that either. She may even feel disappointed that it happened.

This means that her responses have absolutely nothing to do with who you are as a person. It's not about who you are — it's just a response generated by your tactic, your delivery, and other factors. It's just a game. So it is that in the game metaphor we completely separate our ego from the responses that we get.

Often people can be unaware of the subtleties in their own behavior that generate these responses. Sometimes by random chance, the right things happen, the right responses are generated, and even a chump gets laid. He says to himself, "I got lucky." How right he is.

Let's examine in more detail some of the motivations behind women's behavior, and some of the ways we can take advantage of this.

Women select for survival and replication value

So what are some characteristics that convey S and R value?

- Looks and height. All other factors being the same, women will generally be more attracted to taller or better-looking men. However, if you are short or ugly, that is absolutely no excuse to feel sorry for yourself. There are plenty of successful venusian aristos who aren't very tall or classically attractive. Looks and height are real factors, and should be taken into account — but they aren't dealbreakers.
- Being healthy and in shape. Although it's possible to eat wrong, avoid the gym, and still pick up girls, men who stay fit are simply more attractive to women. This really has a big effect on results; people who work out not only look better, but they also give off a better energy in social interactions.

- Hygiene and grooming. These are essential. Stay clean and well-groomed, and keep your breath smelling fresh. Don't be a scrub.
- Fashion sense. People who don't know how to dress are completely oblivious to how bad their clothes look in the eyes of people who *do* know how to dress (most of whom are women.) Dressing poorly also conveys a lack of social intelligence, which is a demonstration of lower value. Anyone who isn't being regularly complimented on his clothes should get a fashion consultant to help fix this problem.
- Being comfortable. It's often stressed that one should be confident. But the truth is that the most important state of mind in pickup is one of comfort. Your body language should reflect this. Relax, and take up space in a comfortable way. Lean back and make yourself at home.
- Smiling and having a sense of humor. Men who don't get laid usually don't smile. There are a lot of guys walking around who don't look happy. Be the guy who is having a good time and who makes other people feel good. Don't take yourself too seriously.
- Not being needy. A typical man with high survival and replication value is probably doing fine with his finances. He probably has access to sex. He is probably comfortable in terms of his health and physical needs. Thus, he is not a needy person. It's important to convey this sense of abundance and to really feel it. When you lust after an outcome, women will pick up on this and perceive you as a low value guy — and women are not programmed to have sex with desperate, low value guys.
- Being unaffected. In keeping with the above line of thought, don't be reactive or try to impress people. The person trying to impress is perceived to be the one with lower status. Similarly, don't make excuses for yourself, and don't come across as someone seeking a reaction, or seeking attention, validation or understanding.
- Having a life. Be ambitious and stay in shape. Have a strong identity and purpose in your life. Have friends and tend to your social circle.
- There are many other ways to convey value — through your game, your body language, your pre-suppositions, your social interactions, and so on. The rest of this book will describe all of these things.

Identity



Who am I?

Such a complicated question but with a simple answer: You are **what** you convey. Think for a moment what your first choice of career would be if you had no chance of failure. In other words, are you really pursuing your dreams, or have you grown complacent?

Women are attracted to passionate, purposeful men. A quick perusal of women's personal ads will often reveal some combination of the phrases, "passionate," "ambitious," "knows what he **wants** and knows how to get it," etc.

She doesn't really care so much *what* you are passionate about, just that you are passionate about *something*. It's attractive. This is because, for whatever reason, women in ancient times who successfully passed on their genes tended to be attracted to these sorts of men. Are you this sort of man?

What if you were to choose an identity that carried the stereotype of being a leader of men, being pre-selected by women, or being the supporter and protector of those close to your To whatever degree you convey these characteristics, higher value is demonstrated — thus triggering attraction.

Image



Is your *image* congruent with your *identity*?

There is a big difference between dressing well, and dressing in a way that is congruent to your identity. How does a rock star dress? How does a basketball player dress? How do you dress? Does it convey a distinct identity? What is the first impression that people will have when they see you?

Some of these questions are not easily answered, and in fact one should never stop asking them. The process is continual.

Peacocking



Peacocking is the use of attention-getting clothes to amplify your responses in the field. If you are peacocked, girls will look at you more often, and guys will make sniggering comments. This means that there will be more *social pressure* on you than you would normally experience.

It is a demonstration of higher value when people perceive that you are accustomed to this social pressure and otherwise unaffected by it. (In other words, when people see that you are congruent with your image.)

This congruence is the critical point. A man with a top hat and a feather boa, with two women on his arms and surrounded by laughing friends, looks like *the man*. Everyone in the room will notice him and women will whisper to one another that they want to be introduced to him. But the same man sitting by himself in the corner could end up looking like a social reject.

Try wearing at least one item that is *cool* and *attention-getting*. It may be used as a *lock-in prop* (chapter 5) as well as allow women to make a comment, good or bad, if they wish to open or sustain a conversation with you.

For example, one thing she might do if you are talking to her and she senses that the conversation is winding down, she may suddenly say, "Oh that's a cool necklace." This is her way of continuing the interaction in a perfectly reasonable way, while reserving some element of plausible deniability.



On more than one occasion Mystery has had women walk up to him and tell him that they hate his goggles. He would reply, "*No you don't, you're attracted to me.*"

This is why it's important that the prop be *genuinely cool*. Otherwise she would look like a try-hard for commenting on it and she'll lose the courage to do so. (Incidentally you also look like a try-hard every time you tell a girl how cool her necklace looks.)

Creatures of Sentiment

Logic and reason can be used to determine a course of action, but often they are instead used to rationalize the action after the fact. This is true of both men and women — we are motivated by our emotions and then we *backwards rationalize* our actions.

Emotions, to women, are even much more profound and all-encompassing than they are to men. Thus, they are also a more powerful and consistent motivator. In fact, when a woman explains something, she will often use emotions as legitimate reasons unto themselves.

Don't convince

Don't bother trying to convince her, argue with her, or engage her in any other way on a logical level. Logic should never be used as a motivator in the field, because what a woman thinks she likes, or says she likes, is not necessarily what she responds to emotionally and sexually.

Stimulate her emotions

The venusian artist uses *emotional stimulation* instead of rational discourse. As long as it *feels* right, your romantic interest will invent her own reasons for what is happening. In other words, when you can give her the right feelings, her *rationalization process* starts to work in your favor instead of against it.

A woman knows how susceptible she can be when she is in an emotional state. Often her solution to this is to avoid becoming emotionally engaged in an interaction where she doesn't feel trust or safety, or where the man gaming her doesn't seem to have enough S and R value. When this happens she will seem *non-responsive*. Thus, if you can engage a woman on an emotional level, even if it's a "bad" emotion such as frustration or jealousy, this is much preferable to her remaining non-responsive.

Also, instead of only trying to give her "good" emotions or avoid "bad" emotions, stimulate her with a *range of emotions* such as curiosity, fascination, fear of loss, connection, indignation, validation and devalidation, humor, embarrassment, happiness, sadness, and so on. The more she is stimulated, the more compelling the experience will be for her. Chapter 5 describes various techniques for this.

Social Awareness

The various aspects of social networking are of great interest to people and especially women, including status, reputation, competition, and alignments and pair bonds.

Discretion is a virtue

When she says, "not here," you say, "I understand."

A woman's reputation directly influences her social status. This is why women are easier to get into bed when they are on vacation — they are more likely to indulge in an adventure for which they trust there are no social consequences. This is also why women are appreciative of men who understand and practice *discretion*.

A venusian artist will never brag about his sexual conquests. If you do, not only will it eventually get back to her, but any other woman who hears it will also be on notice that sexual relations with you carry social consequences. So, for example, when you obtain a phone number from a woman, don't walk straight over to your friends and be seen high-fiving them enthusiastically.

Anti-Slut Defense

The word 'Slut' is a weapon that women use against other women

Women have a powerful interruption mechanism known as *anti-slut defense*, or *ASD*. Not only does she prefer to avoid having others *perceive* her as a slut, which would pose dire consequences to her social status, but also she wants to avoid the discomfort of *feeling* like a slut. Thus she has the *ASD* interrupt mechanism to help her avoid this fate.

ASD is what makes a girl blurt out 'I *have a boyfriend*' (whether she actually does or not) — because you escalated faster than she was comfortable with.

Time in the field will eventually improve your calibration to the point where you can escalate without activating her *ASD*. Chapter 6 describes how to escalate smoothly through the use of *false disqualifiers*.

Plausible deniability

She will never do anything during the pickup that makes her feel responsible for what is going down. To whatever degree she feels responsible, her ASD will be activated.

Thus she has a need for *plausible deniability*. For example, if you were to say to her, "Hey, let's go back to my place and have sex," she will have to say no, even though she wants to say yes, *because saying yes would make her responsible for what is happening*—which she can never do.

But if instead YOU were to say, "Hey, let's stop by my place on the way to that party — I have to show you my tropical fish." Well, she now has an excuse and plausible deniability to stop by your place and then — *oopsie*— have sex with you. "*One thing led to another...*"

This is why serendipity is so romantic. After all, if it was *meant to be*, then how can it be her fault? Who is she to deny Fate?

Act with moxie

Moxie means *inventive courage*. The venusian artist must *always be leading* the interaction to where he wants it to go. This is partly due to the fact that he has no choice, since the woman won't take any responsibility for what is happening.

For example, it is necessary to keep things interesting during the opening phase of the game. If you don't make the conversation interesting, then she will raise boring topics — and then she will feel bored and blame it on you.

It's not fair, right? This pattern of behavior can be maddening. But the truth is, if she feels bored around you but excited around other guys, then why should she waste her time on you?

Make tilings happen. Take full responsibility for your shared experience with her. It is your job to act with moxie — to move from phase to phase, to meet the objectives of each phase, to escalate, to venue change, and so on. The rest of this book will explain exactly how to do these tilings.

Persistence

Persistence is another way to alleviate her of any responsibility for **what** is happening. Of course, don't confuse persistence **with** begging, arguing, or being pushy, needy, or creepy. All it means is, *don't give up too easily*. Girls will test you to find out how easily you give up — they want to see how confident you are in yourself. Just assume that she is giving a little token resistance, and continue.

Token resistance

Women *will* give *token resistance* — expect it. If she didn't resist at least a little bit, she would feel like a slut — and **that's** not going to happen.

This can be tricky — an overly aggressive man might misinterpret **all** resistance as being merely token resistance, and could eventually find himself facing a rape charge. Whereas a man who isn't persistent enough will acquiesce every time she resists, when in many cases she was secretly hoping that he would be a little more **forceful**

Intuition over Analysis

Women follow their intuition, so believe your own bullshit. For example, if she wants to determine whether or not you are being real with her, she won't logically analyze what you said for inconsistency. Instead, she'll look *to you* to see if you seem congruent **with** what you are saying. (Are you?)

Another example of female intuition

Women often look for the "real meaning" behind what you say. For example, if you tell a story about your "friend-" she will usually assume that you are actually talking about yourself. This can be useful when the story demonstrates **higher** value. For example, if you don't want to look like a braggart, you could say, "*My friend hooked up with this amazing girl and they had wild sex all weekend...*"

On the flipside, if you want her to believe that the story really is about someone else (like if it demonstrates lower value) then use a specific name. For example, "*My friend Craig woke up last weekend with a condom in his ass and...*"

She'll assume you really are talking about someone else if you give him a name.

Congruence Tests

A woman's number one emotional **priority** is safety and **security**. Above all, she wants a man who makes her feel safe and protected.

It would be convenient if she could simply ask each man in order to determine **whether** or not he will be able to adequately support and protect her and her offspring. But of course he would then lie in order to obtain sex — so she must test.

It's important to remember that often she is not deliberately testing you. It's not necessarily something that she is consciously aware of. She just gets a feeling to behave a certain way, and so she does. Based on how you react to this, she then feels either *more* or *less* attracted as a result. This is known as a *congruence test*.

If she views you as a contender, then she *will test* you. A woman often won't even bother to test losers — instead she'll just become non-responsive and then leave as soon as she can. Thus, a test can be considered an indicator of interest, of sorts.

Congruence tests are a double-edged sword; if you respond the right way, she will be noticeably more attracted to you after the test. But if you fail, then she will be noticeably less attracted. (Chapter 6 explains how to maintain control of the frame and pass her tests.)

Appeasement is futile

Women are like children in this respect...they *have* to know where the boundaries are. They will keep pushing and testing until they find those boundaries. When a woman pushes, and feels that resistance, it allows her to *feel secure with* you. This is what she's looking for. But if she doesn't feel that resistance, then she will keep pushing until she walks all over you.

Of course, she'll be unable to respect a man if she can walk all over him. It'll be mildly disappointing to her, but she'll also feel reassured about her feminine power — which feels good — and she may even reward his submission with positive reinforcement. Good doggy.

The moral is, just because she likes something doesn't mean it will bring you any closer to sex. A girl enjoys the ego boost when men cat-call at her — but she'll never have sex with those men.

Investment

Although you may be an attractive guy with relatively high S and R value, another guy just like you could easily come along tomorrow.

In the moment, when she is intoxicated with the emotions of flirting with you and she gives you her phone number, she may have every intention of following up with you in the future. But once you are separated, memories slowly fade and new flirtations arise.

Thus, it's not enough for her to be attracted to you. She must become *invested* in her interaction with you. The more she is invested in her interaction with you, the more she will be motivated to get a return on that investment.

Thus, the more time she spends with you, the more money she spends on you, the more effort she exerts to get your attention or validation, the more she is emotionally and physically engaged with you, the likelier it becomes that you will eventually begin a sexual relationship with her.

What are some forms of investment?

- Emotional investment. Women are reluctant to allow themselves to become emotionally vulnerable around men of dubious intent or low S and R value. A woman knows that once she gets emotional, it becomes much more difficult to extract herself from the situation.
- Physical investment. Kissing is a bigger investment than walking arm-in-arm. Sex is the biggest investment of all.
- Time. The more time you spend together, the more invested she becomes. It takes an average of four to ten hours before sex.
- Effort. Is she chasing? People don't value that which comes too easily. The more effort she puts in, the more invested she has become.
- Money. Did you buy her a drink, or did she buy one for your

Many of the tactics in the game are not designed to attract her, but rather to use that attraction as bait in order to get her more *invested* in her interaction with you. (See chapter 6 for these tactics.)

Discomfort and Confrontation

Women tend to avoid discomfort and confrontation. This may seem rather common-sense, but these points are critical to achieving success in the game:

- Have a positive, open attitude. Don't be judgmental or jealous.
- Don't act as if things are a *big deal*. They aren't.
- Don't complain or be emotionally punishing. If you call her on her shit while talking on the phone, she will just avoid talking to you on the phone. Instead of being the whiny or emotionally abusive boyfriend whenever she pulls a fast one, be the guy who has plenty of options.
- If she flakes on you, don't confront her about it next time you see her. Are you the guy who sat around and got upset? Or are you the guy who called over another girl and then forgot all about it?

Fun and Stimulation

Just as she tends to avoid discomfort, so she is also attracted to fun and stimulation. (Once her safety has been secured, of course.) Attractive women are often found on boats or dance floors, in parties or nice cars, and around bad boys and rich men. These things are much more compelling than being a *nice guy*.

- Be a fun and playful person. This is preferable to appearing *tough* or '*deep*.'
- Be challenging to women. They love this.
- Be slightly unpredictable. Familiarity breeds contempt.
- Embrace your passions and be involved in activities. (See chapter 7 for more info on building a strong identity.)
- Develop your social circle. Put time and energy into this.

Keeping a woman around is an active process. After you win her over, you can't just put her in a box and pull her out like a toy when you feel like playing with her. She needs constant attention, stimulation, a firm hand, and several trillion other things. She will never be completely content, but it *is* possible to keep her coming back for more and get her "*in love*" with you.

Women are Dangerous Creatures

Women are not angels of purity and morality, fit for placing on a pedestal. They are human just like the rest of us.

Often in the field you may notice women lying or using other manipulation. They may act jealous, try to make *you* jealous, use their sexuality to gain power, stir up trouble, and often will not hesitate to ditch you for something shinier — someone with more status, more testosterone, more cocaine.

And as empathetic as women are deemed to be, she will not later wallow in pathos with a solitary tear on her cheek, full of regret for ditching you. Don't take it personally; it's just part of the game. Incidentally, now would be a good time to admit that the same is true of yourself. *We are all human.*

Rating Women

A woman's S and R value can be rated almost purely based on her looks. That is a terrible thing to say. But it's not denigration — it's a statement of fact. Men are programmed to inseminate as many pretty women as possible. Thus a woman's sexual value to a man can be easily determined by her physical appearance.

Men often employ a decimal rating system, ranging from 1 to 10, with a 7 being a cute girl and a 10 being a supermodel. It may seem uncouth to refer to a woman as a number, such as a 5 or a 9. But the truth is that women of different ratings *do* behave differently, to a great degree. And furthermore, men *and* women will also *respond* differently to other people based on perception of their relative difference in social status. This prejudice is a fundamental human behavior — it's hardwired.

Here is one example of responding based on social status: Seeking rapport is often an easy way to open a conversation with a set of 5s, but will only get you blown out with a set of 10s. Whereas being cocky and challenging, which 9s and 10s absolutely love, will often cause a 4 or 5 to react in a nasty way.

The Mystery Method, with its emphasis on *negs*, *group theory*, and *pre-selection*, is geared towards attracting 10s. In fact, you may have to tone down these aspects of your game if you are dealing with a lesser-caliber woman, otherwise she may reject you in order to protect her own ego. It's easier for her to take the immediate ego boost of shooting down a guy, rather than risk being rejected by one whom she doesn't feel qualified for in the first place.

Cat Theory



*"Why do you suppose we only feel compelled to chase the ones **who** run away?"*

~ Vicomte De Valmont, Les liaisons Dangereuses

Cats don't take orders, but they can be tempted to chase. If you tie a feather to the end of a string, *and use it properly*, YOU can get a cat to perform acrobatics. But isn't it interesting that if you put the feather down in front of the cat, she will turn up her noser

Cats are always curious, especially about shiny new tilings such as the ball on a rubber cord, the catnip, the treats, the feather on a string, etc. She can be easily distracted but once she is invested in tiling to catch something, it can become her single-minded focus.

There is a lot to learn from cats. If you push a cat off of you, she jumps back into your lap. If you want to hold her, then she wants you to put her down. If she is feeling nasty she might bite or scratch. She craves attention and she gets jealous of other cats. Sometimes she'll just rub against you and purr with contentment — you can really tell when a cat likes someone.

*A cat sees the feather from across the room, but continues about her business. Then the feather slightly moves and her gaze is **drawn**. When the feather jumps once or twice more, she starts to steadily creep in its direction. Jerk the string at just the right time, and the cat suddenly goes crazy, running circles **around the** worn, flying over furniture to catch that feather.*

As the venusian artists proceeds with a pickup, he keeps validation and attention just *slightly* out of her reach. If he is too easily acquired, then she will quickly grow bored and lose interest. But likewise if he is completely unattainable, then she will also lose interest and give up.

Therefore, keep the bait just barely out of her reach and then continually entice her in small increments.

Boyfriends



When a woman says the words, "*I have a boyfriend,*" nine times out of ten what she is really saying is, '*You just telegraphed too much interest.*'"

It has nothing to do with whether she actually has a boyfriend. In fact, if she is attracted to you, she will often deliberately hide the boyfriend from you until after you have had sex with her.

Whether she mentions him or not in no way proves that he actually exists — only that she had a motive to mention him.

Some reasons why women might say they have a boyfriend:

- 1) She doesn't have a boyfriend, she's just saying that because she's not attracted to you.
- 2) She *does* have a boyfriend and given her current options, she has chosen to stick with that relationship.
- 3) She *does* have a boyfriend, but she *is* willing to sleep with you: and she just wants to make sure that you understand her situation first. She wants *discretion* and *understanding*. And though she might be available to you for sex, she's *not* immediately available for any more of a commitment.
- 4) She *does* have a boyfriend, she *is* willing to cheat on him (they usually are if your game is tight), but she doesn't want to feel guilty about it. This is her *rationalization process* at work. As long as she mentions the boyfriend *before* sleeping with you, she can rationalize to herself that it was "*your fault.*" Sure, she might regret it later but that won't stop her from cheating.
- 5) She *doesn't have* a boyfriend, she *is* attracted to you; she just doesn't want to look like a loser who can't get a man. Most hot women have *orbiters* anyway: nice guys who pose as her friend but secretly want to sleep with her. Since the word "boyfriend" can have so many different meanings, she is thinking of one of her orbiters as a "place-keeper" when she makes this statement.

The bottom line is, don't ask about her boyfriend, and don't be fazed if she mentions him. Just take it as a hint that you probably telegraphed too much interest too soon, and then continue gaming as normal.

Chapter Two Review

Emotions are circuits in the brain that judge value and create motivation. They are designed to keep you alive and to replicate your genes.

People seek alignments and pair bonds based on survival and replication value.

Part of being a man of value is pursuing your dreams, having a *strong identity*, and living a passionate life.

Your *image* should congruently convey your *identity*.

Peacocking is the use of attention-getting clothes to amplify your responses in the field. Try wearing at least one item that is cool and attracts attention.

People are likely to act based on their emotions and then *backwards rationalize*. Because women are more emotional, they are especially susceptible to this.

What a woman likes, or says she likes, is not necessarily what she responds to emotionally (and thus sexually.)

To get results with women, stimulate their emotions. They will follow their emotions and then backwards rationalize whatever happens.

If a woman remains *non-responsive*, that means she is deliberately cutting you off from gaming her. A woman will not allow herself to become emotionally vulnerable around you if you haven't demonstrated enough value, or if she doesn't feel safe enough.

Don't bother trying to convince her, argue with her, or otherwise engage her on a logical level

Don't act as if tilings are a *big deal*. Just repeat the words *no problem* in your head until you really believe it. No matter what happens, it's no *biff deal*.

A woman's *reputation* is very important to her, and thus she is much more likely to indulge sexually when she trusts that there will be no *social consequences*.

All women have a powerful interruption mechanism known as *anti-slut defense*, or *ASD*. When you play solid game, you will be able to escalate smoothly without triggering her *ASD*.

A woman won't do anything that makes her feel responsible for the escalation — she needs *plausible deniability*. The venusian artist must take responsibility to make tilings happen and act with *moxie*,

She will use *congruence tests* to provoke a reaction from you. Then her intuition tells her whether you seem congruent. She tests in this way so that she can find your boundaries, which allows her to feel secure. This behavior is instinctive and allows her to more accurately determine what sort of man you really are.

Most women view men as an abundant resource. Thus it's not enough to attract her — she must become *invested* in the interaction.

She will seek out fun and stimulation, and avoid confrontation and discomfort.

The *decimal scale* is used for rating women based on their looks, from 1 to 10.

As you proceed with the pickup, keep her just inside that window between validation and rejection. She must be baited to chase in *small increments*, just like a cat with a string.

Don't ask about her boyfriend, and don't be fazed if she mentions him. Just take it as a hint that you telegraphed too much interest too soon, and then continue gaming as normal.

Structure and the Game

The M3 model and the proper mindset for learning the Game

The Mystery Method consists of several aspects. First, the *M3 model* describes the courtship process between a man and a woman from the time they meet until the beginning of the sexual relationship. Second, *group theory* describes the application of social dynamics and the M3 model to groups of people found in public settings. (*This is important because high-caliber women are often found in this social context.*) Third, the Mystery Method is a methodology for practicing the game in the field, and fourth, it includes a set of field-proven techniques that have arisen from this methodology, such as the *Neg* and the *False Time Constraint*, which are described in the subsequent chapters of this book.

The Game is played in the Field

The Game is not played on a computer or the Internet. It's not played in a book. It's played in the real world, with real people and real situations. Only through repeated practice in the field can we gain intuition and skill. Over time, these methods become habitual. Once internalized over a few disciplined weeks, it is in fact easier to keep doing them than to stop.

- Focus on building your skill, not on getting laid or meeting your new girlfriend. Think of it like you are learning a new video game.
- Don't obsess over a particular woman. Forget about that girl you have been pining over for the past three months.
- Don't bother getting good at fixing things in the damage zone. It's easier to attract a new woman than it is to fix things when they go wrong with your existing target. (When things go right, attraction is created in seconds or minutes, and sex occurs in four to ten hours.)

The Mystery Method Newbie Drill

- Go out gaming four nights per week for four hours each night.
- Make three approaches per hour. This schedule allows for twenty minutes per approach.

That adds up to twelve approaches per night — which is **forty-eight** per week and two hundred per month. (Chapter 4 covers the art of approaching.) Within a year you will have approached over two thousand women.

How many women have you approached in the past year?

Calibration and Internalization

After the first week or two in the field, approaches start to become a blur. Patterns emerge over time. Formerly puzzling social **behavior** comes clearly into focus. Situations and reactions can be easily predicted before they occur. This powerful social intuition, derived from time in the field, is known as *calibration*.

A skilled venusian artist will anticipate, and have a prepared response for, nearly any common social challenge. He has already encountered this particular challenge before. He has experimented with a variety of different responses, and he has compared notes with all of his friends on the subject as well. He has found an effective answer, and he has already field-tested it and practiced it to **mastery**.

So **when** the **challenge** arises, the answer comes forth — automatically delivered into action by his unconscious mind. In the same way that all practiced behaviors become automatic, so does the skill set of the Mystery Method. This process is known as *internalization*.

Women are more socially savvy because they tend to be involved in more approaches

For a man to be in the Game, he must actively approach women. If he stops doing this, he has taken himself out of the Game. But women cannot so easily make this choice. If she is attractive, men will approach her anyway. She needn't do anything but simply be there — she can't help it. For this reason, women usually have more calibration and social skill than men do. They've had more practice.



Process over Outcome

A venusian artist goes into the field night after night primarily to *improve his calibration* and to *internalize his skill-set*. He's not trying to 'get this one girl,' or to 'get laid tonight.' Rather, he's practicing with the long-term goal of having a powerful social skill-set

You cannot allow the outcome of any given approach to carry much significance. It's like playing a video game: if your man dies, just hit the button and play again. If the outcome of any specific approach becomes important to you, it'll have subtle, insidious effects on your game and cause you to lose the set. You really do have to *not care*. Just like fishing or golfing, the process of playing the Game itself has to be its own reward.

Everything comes full circle. After some months of practice, when your game becomes tight, your skills will enable you to enjoy women in whatever way that you please. And then you really won't care about approach anxiety, rejection, or outcome - you'll just enjoy the ride. Ironically it is this very attitude that gets results.

There is a certain Zen to pickup...the one who releases all attachment to a desired outcome is ironically the one most likely to realize that outcome.

The Sexual Relationship

Every long-term (sexually intimate) relationship has a beginning, middle, and an ending:



Where...

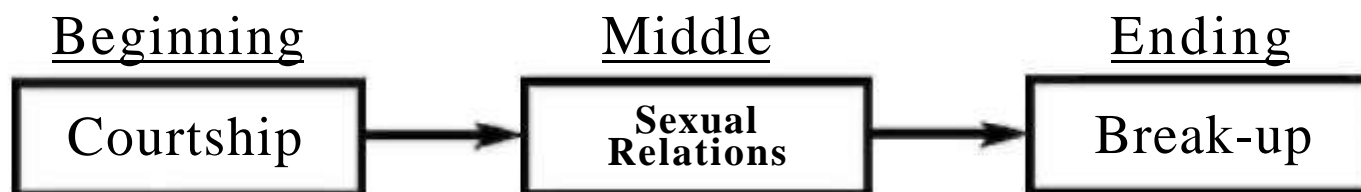
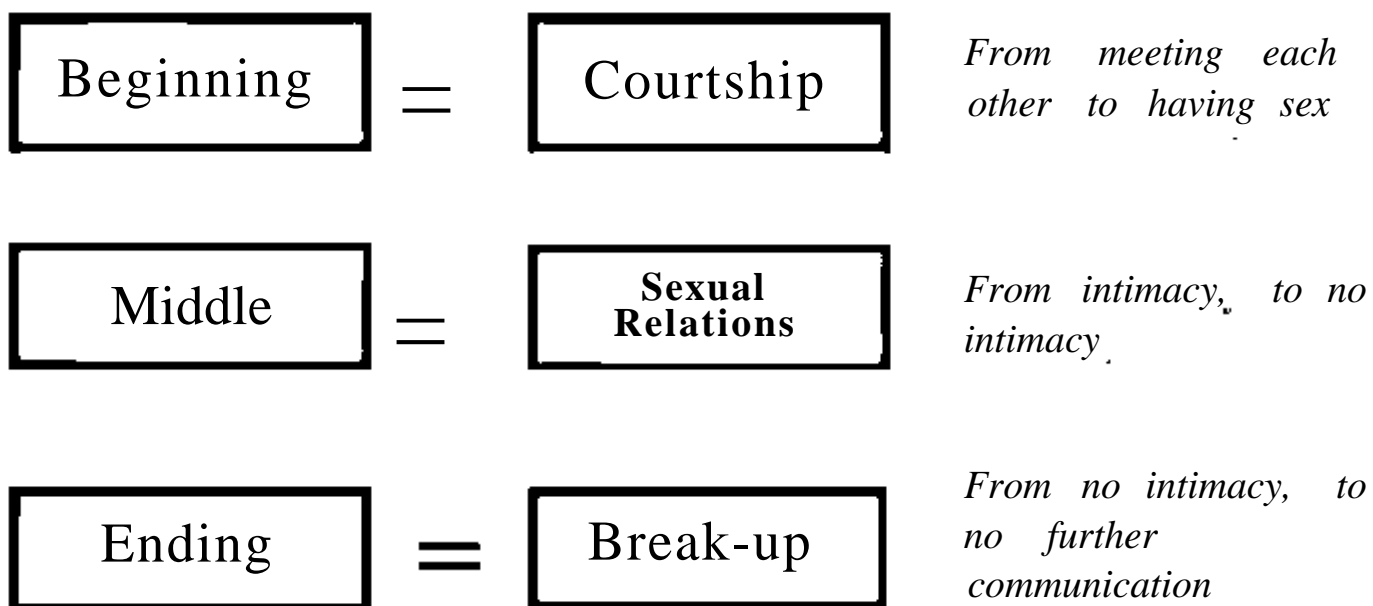

Courtship

Further, every courtship, from meeting each other to having sex, has a beginning, middle, and an ending to it.



Mystery Method focuses on only these three stages. Mystery has named these three courtship stages...

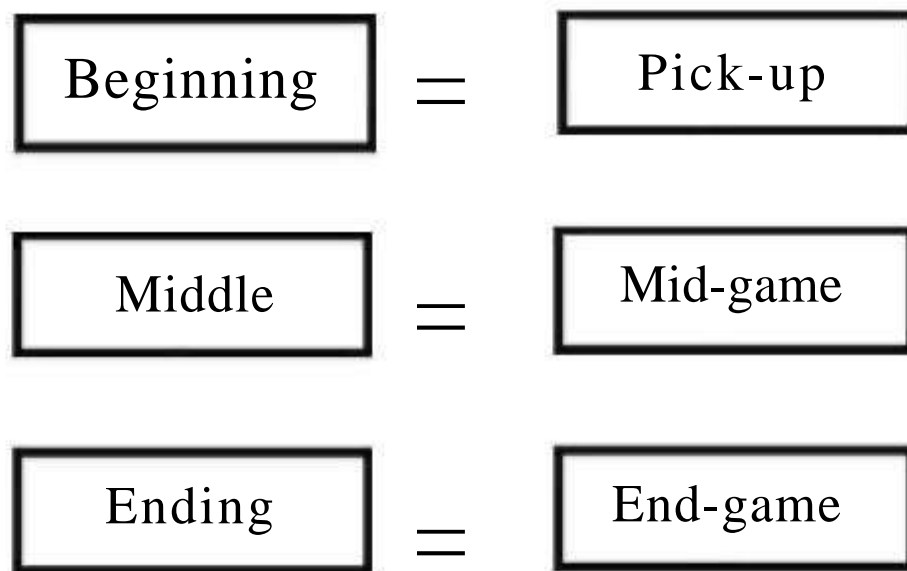

Attraction

Attract

The first focus of The Mystery Method is not seduction, but rather, attraction.

- **AT TRACT:**

transitive senses : to cause to approach or adhere: as a : to pull to or draw toward oneself or itself <a magnet attracts iron> b : to draw by appeal to natural or excited interest, emotion, or aesthetic sense: ENTICE <attract attention>

intransitive senses: to exercise attraction

Etymology: Middle English, from Latin attractus, past participle of attrahere. from ad- + trahere to pull, draw

- **SEDUCE:**

1 : to persuade to disobedience or disloyalty

2: to lead astray usually by persuasion or false promises

3 : to carry out the physical seduction of: entice to sexual intercourse

Etymology: Middle English, from Late Latin seducere, from Latin. to lead away, from se- apart + ducere - to lead

Mystery's proteges focus on attraction first, not seduction. Ethically, they are therefore attractors, not seducers.

Mystery Method Statement of Ethics

"Attraction is not a choice. "

— David DeAngelo

The Secret of Attraction

There are a quantified number of fundamental attraction switches* that are hard-wired into the sexual selection mechanism of every man and woman on Earth.



In the same way that we feel an automatic overwhelming attraction towards any Sports Illustrated swimsuit model because she turns on all our attraction switches, it is possible to make women feel the exact same way towards *us* if we could only devise a clever method for systematically turning on all attraction switches.

Let's try a simple thought experiment to illustrate...

* The attraction switch metaphor is of course just that: a metaphor.

Thought Experiment: Landi vs. Maude



Landi Swanepoel



Bea Arthur

Part A: Imagine that Guess? supermodel Landi Swanepoel stepped into the room and began to indicate her interest in you, perhaps by sitting on your lap. Visualize it for 15 seconds.

How do you feel?

Part B: Now imagine Maude (Bea Arthur from *The Golden Girls*) strutted in and sat on your lap. Visualize it for 15 seconds.

How do you feel *now*?

If you are a typical healthy male, many more attraction switches likely turned on looking at Landi than Bea.#

No disrespect to Bea. Mystery thinks she's just marvelous.

Results

As you can *feel*, certain switches turn on in the presence of legitimate replication value. Certain ones may also turn off in the presence of indicators which point to a replication value in the negative. Mating **with** a young fit girl will improve your genes chances of successfully replicating over doing so with a woman in menopause.

Our switches are wired to respond to qualities such as specific hip to waist ratios, breast shape and size, facial and body symmetry, and other youth and health indicators.

If a woman possesses and can demonstrate a certain **quality** that one of your sexual selection switches is programmed (evolutionarily adapted) to respond to, you'll feel immediate attraction for her, without the need to even think about it. In fact, **you** won't even have **a choice** about it.

It is interesting to note that...

- 80% of a man's attraction switches are set to respond to a woman's replication value. Only 20% respond to her **survival** value.
- Only 20% of **a** woman's switches **are** set to respond to a man's replication value, while 80% respond to his **survival** value.

Even if a woman has fake breasts, you will feel greater attraction for her than **if** she was small-breasted. So many women wouldn't go through such extremes if it didn't work to trigger attraction after all.

So then, what qualities in a man are a woman's attraction switches set to respond to, and how do we systematically turn them on in rapid succession and in a practical manner in-field?

Previously we have discussed basic qualities such as looks and height, health and fitness, being comfortable and smiling, and so on. Now let's examine an attraction switch that is an order of magnitude greater in power...

Pre-selection



This attraction switch exists not only in the sexual selection mechanisms of people, but also in many animals. A male grouse (a type of bird) will be hard-pressed to attract a female if he is alone. Place a stuffed female grouse beside him and other females will soon enter his territory and mate with him.

Similarly, if a woman considers a man to be sexually attractive to other women, she will instantly feel an attraction towards him. Stand by yourself at the bar and you will not appear nearly as attractive as you would if you had two women hanging off your arms.

Demonstrating that you have women interested in you, in this direct manner, is only one of many ways to trigger the same sexual selection switch. There are other ways. You can also wear female perfume. When a woman asks what you are wearing say, "Nothing." Smell your collar and then remembering say, "Ah," and smile to yourself.

Another way to flip her pre-selection switch is to have a lipstick kiss on your cheek. In the same way you feel greater attraction for a woman if she has an appealing hip to waist ratio, a woman will feel the exact same way towards you because of that all-important lipstick kiss.

There are a good many more ways to flip the pre-selection switch, and there are many more switches to be flipped. The secret of attraction, which is utilized in the attraction stage of The Mystery Method, is to know what these switches are, and then endeavor to systematically switch *all* of them *on!* There is no quicker or more powerful attraction than this.

Chapters 5 and 6 examine the subject of attraction in depth, as well as the various tactics used for generating and using it.

M3



The M3 Model

Only after you attract can seduction take place. However, before a woman who is attracted to you will be seduced, there is one additional crucial stage: *you must build comfort*. (Chapters 7 and 8 of this book describe the comfort and seduction phases of the Mystery Method.)



We now have the main focus for each stage in M3:

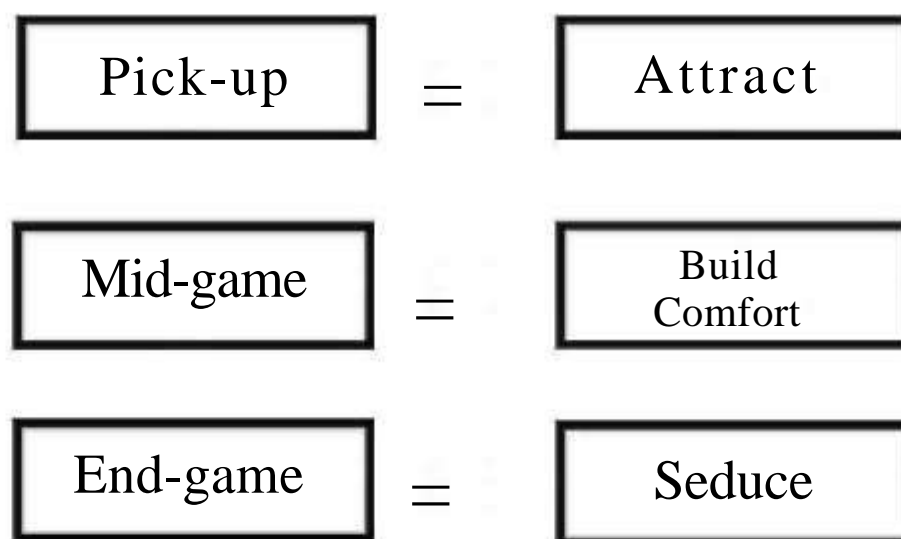

Seduction is Mutual

If during the mid-game stage, you can build enough comfort with a woman for her to be alone in a room with you, then she will readily agree to have sex **with** you in the end-game stage. **In fact, she may very well try to seduce you.**

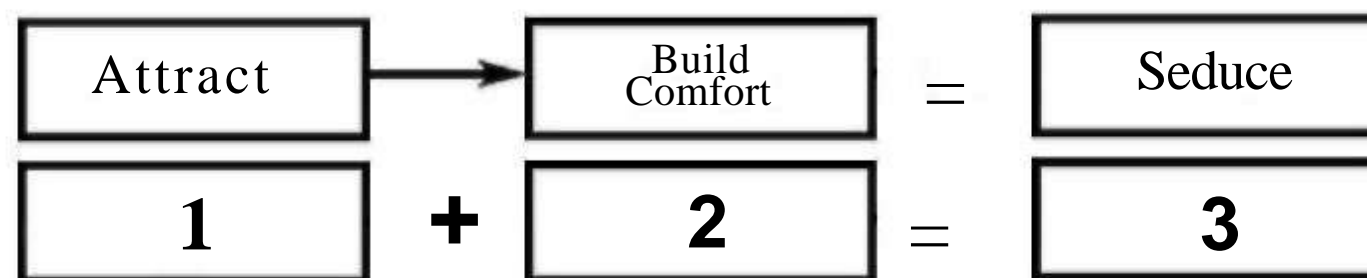

Therefore, if you only work to structure a convenient **opportunity** for her to seduce you, there will otherwise be little reason to focus on seduction directly.

Not So Fast

Unfortunately, none of this is possible without attraction. She will certainly not be seeking comfort with you if there's no attraction. And be warned: if you seek comfort prematurely, it will only make you less attractive to her. Or worse — you'll get stuck in the *friendship zone*.

Once there is attraction, she will probably seek comfort with *you*. **This should be interpreted as the indicator of interest that it is.**

To recap, the three main objectives in The Mystery Method are:

Pick-up

To attract a woman

Mid-game

To establish comfort, trust, and connection

End-game

To structure an opportunity to be seduced

The Elusive Obvious

Illustrated thus simply, the linear relationship between attraction, comfort, and seduction seems intuitive and self-evident. Yet venusian artists the world over have repeatedly struggled with problems that arise from improper M3 sequencing.

The Four *M3* Sequencing Mistakes

1. SEDUCTION FIRST — *to start at the end.*
2. COMFORT FIRST — *to start in the middle.*
3. ATTRACTION BUT NO COMFORT - *to start at the beginning but skip the middle and go straight to the end.*
4. ATTRACTION AND COMFORT ONLY — *to start at the beginning but get stuck in the middle.*

M3 Sequencing Mistake # 1: *To Start at The End*

Ending

Seduce

The Seducer

The most common error that beginners make is to focus on seducing a woman first instead of attracting her. This is like putting the cart before the horse. Often, to beautiful women in particular, seduction first is little more than the equivalent of saying, "You don't know me but will you sleep with me?" There is a time (and a place) to begin the seduction stage, but it's not until you first have attraction and comfort - as well as privacy.

Seducers mistakenly begin at the end. Just like any typical guy, they often blatantly disregard a woman's comfort levels entirely. Even if there is a level of attraction based on the seducer's appearance alone, this is superseded by her discomfort in having to deal with aggressive sexual advances from someone she doesn't know nor trust. It is best to not prematurely telegraph strong sexual interest until end-game.

Fool's Mate

In the game of chess, it is possible to win in only four moves. This gambit is called *fool's mate*. Winning with speed via fool's mate does not however make you a chess champion. If anything, it only demonstrates your opponent's inexperience. An experienced chess player will not even attempt a fast fool's mate for, if the opponent doesn't take the bait, he leaves the player in a weak position. Similarly, while it is possible to seduce with speed, it is much less probable on a woman who is socially experienced. In the venusian arts, we refer to 'seduction first' tactics as fool's mate for its metaphorical similarity. Instead, both chess champions and venusian artists prefer to play a *solid game*.

Fool's mate can work in some situations that may be acceptable to you, such as on drunk girls and those who have a propensity towards having one night stands. Just don't let it be your only "winning move."

M3 Sequencing Mistake # 2: *To Start in The Middle*

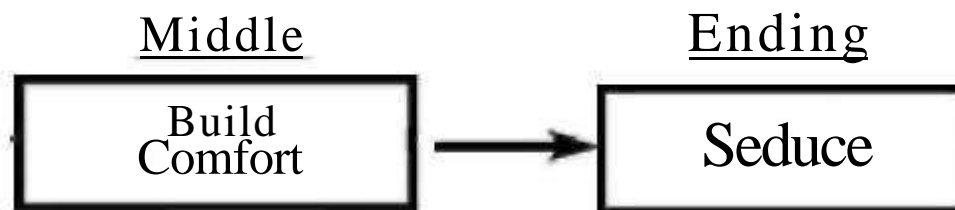

The Nice Guy

Many men understand and appreciate that *seduction first* makes women feel uncomfortable. What they do instead is focus on comfort first.

What these men don't realize is that women of beauty get bombarded by these nice guys every day, and it can grow quite tiresome. While not as offensive as the seducer, the nice guy is no less a bother. There are simply too many nice guys approaching them in a day to indulge in the same old lengthy dialogue time after time. Without attraction first, simply saying "Hi, I'm Joe. What's your name?" will smack of every nice guy before you. Why would a woman who isn't attracted to you care what your name is or bother to even remember it? Why would she divulge personal information just because you asked?

The Protection Shield Metaphor

If a woman is not attracted to you, any comfort building attempt will bore her. Trying to tell her about you, get her to talk about herself, or complimenting her before she deserves it are all comfort building attempts. If you've ever been trapped in a conversation with someone you were not interested in talking to, you'll understand how uncomfortable it can be.

Imagine this happening to you several times a day, almost every* day, for many years. Wouldn't you recognize the need to shut these people down before they even got **started**? Over time, as a woman interacts with ever more nice guys, she begins to evolve simple yet effective strategies for countering this barrage of bore. Collectively these strategies make up what is metaphorically called her *protection shield*.

'Comfort first' telegraphs sexual interest

Simply by approaching her and being nice, women of beauty assume you want something from them. If she doesn't think you are selling something (or begging for change), she'll reason it's because you want to win her sexual favor. Even if you aren't interested in her sexually, she'll assume you are, just because you approached her in the same manner as the last half-a-dozen nice guys did that night.

Him; *Nice boots*

Her; *I have a boyfriend*

Most men mistake these short-term defenses for long-term personality flaws. This quite often turns men off and it is for this very reason that these strategies work. From them, it's better to allow a bunch of men she doesn't have attraction for to think she is a bitch than to have to sit there and listen to them all.

Him: *What's your name?*

Her: *Get lost*

Some woman may tolerate mildly entertaining nice guy dialogue, but once the conversation begins to grow mundane, she'll excuse herself. Persistent nice guys will meet greater resistance as she becomes weary of his prolonged presence. Although playing a bitch can become a form of entertainment for some, most women with protection shields use them for good reason and are otherwise very nice people.

Him; *Hi, how are you?*

Her: *Look, I'm not going to have sex with you.*

If you don't take the time to attract a woman first, you won't give her a reason for her to want to even have a conversation with you. This will force her to raise her shields. Keep comfort building to mid-game, and don't prematurely begin in the middle.

M3 Sequencing Mistake # 3: To Start at the Beginning but Skip the Middle

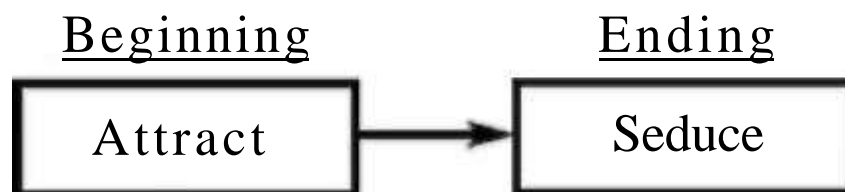

Every beginning and ending has a middle, and in M3, that middle is comfort. There is a time to seduce a girl (or be seduced), but it's not until after you have built comfort.

The Player

A player is a venusian artist who begins at the beginning and successfully attracts a girl but fails to avoid the three *player traps*. The first is a failure to justify his attraction for reasons that go beyond her looks. He has revealed his growing attraction too quickly. The second is a failure to appreciate the importance of mid-game before end-game. The third is a failure to stop yourself (and the woman) from going too far too soon.

Every venusian artist must be aware of these *player traps*.

The Three Player Traps:

1. NOT JUSTIFYING A MUTUAL ATTRACTION.
2. DISREGARDING COMFORT.
3. BUYER'S REMORSE

Player Trap #1: Not Justifying a Mutual Attraction

Justifiably *to men*, a woman's beauty can be so intoxicating to us that this alone qualifies her as girlfriend material. We cannot let her know we choose her based on her looks because it doesn't seem genuine and makes us appear like other typical men.

A woman's indicators of interest, or IOIs, notify when to go from the attract stage to the comfort stage, but you must not do so until she has legitimately earned *your* IOIs as well! Getting IOIs from a woman is simply not enough reason to begin returning them. If you are too easy, she will mark you as another notch in her belt and move on in search of more challenging conquests.

Some IOI Examples:

- *She touches you. When you say, "Hands off the merchandise", she touches you again.*
- *When you grab her hands and hold them, she holds back.*
- *She laughs at all your humorous remarks, and the ones that aren't funny.*
- *When you ask her to bite your neck, she does.*
- *She asks you for your name.*

You must first encourage her to demonstrate qualities that can substantiate your attraction. If you don't, she may suspect that you only played with her emotions, callously attracting her in a game to win another score. She will feel uncomfortable being attracted to you and she will lose this attraction for you quickly. Your attraction stage dialogue will in fact be viewed as conniving and she will perceive you as emotionally manipulative. In this light, a player is simply a seducer with good opening game.

Having successfully negotiated beyond the first *player trap*, the venusian artist moves onto comfort building.

Player Trap #2: Disregarding Comfort

If you seduce a woman before building enough comfort, her attraction for you will turn off. To keep this from happening, we must build enough comfort so our seduction won't make her feel uncomfortable. Do not cross the line from comfort to seduction until you have enough comfort.

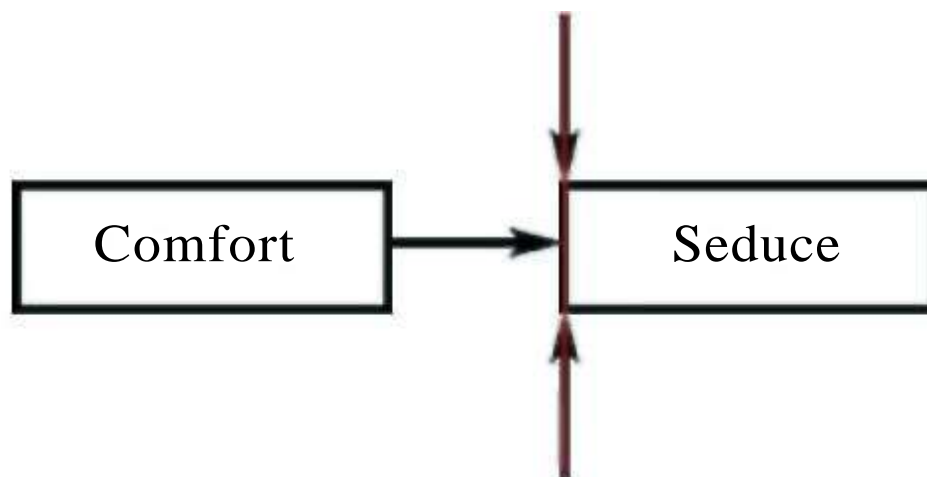

When do you know you have *enough comfort* to begin seduction?

The Seven Hour Rule

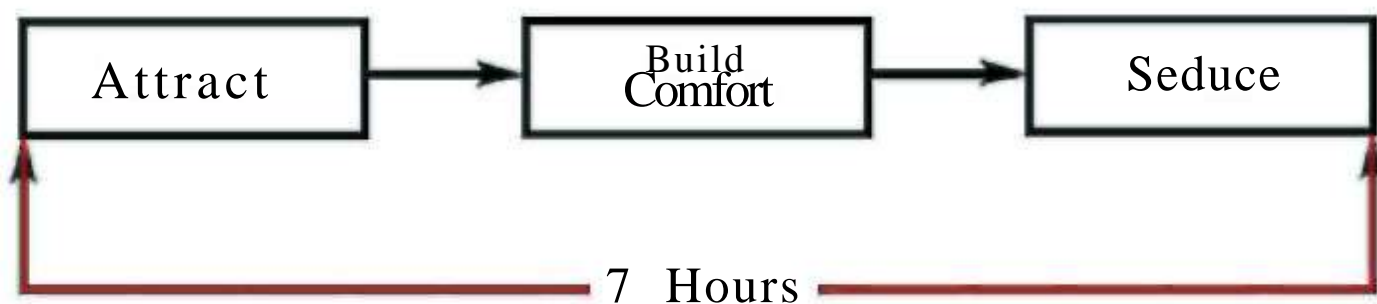

It usually takes an average of four to ten cumulative hours of comfort building before she is ready for seduction. (Not counting Fool's Mate.) There is no black-and-white rule for determining when the time has come — only your calibration can tell you that. (More on the Seven Hour Rule later.)

Player Trap #3: Buyer's Remorse

Buyer's remorse occurs when a person buys something on an emotional whim, only to later regret the purchase. Similarly, women who are attracted to you may be pushed or go too far too soon. While in the moment she may indulge in her attraction or sexual arousal, only to regret her feelings or actions later. For its metaphorical similarity, venusian artists call these situations *buyer's remorse*.

A Case Study: Joe Meets Janine

The Man's Point of View

Joe meets a beautiful woman named Janine and they build attraction for each other. Joe soon finds himself making out with her that night. Unable to take her somewhere private at that time. Joe gets her number and they agree to see each other another night. He excitedly tells his buddies he met his next girlfriend.

Joe calls Janine the next evening, but she is cold and unresponsive on the phone. He tries to convince her to see him as they agreed but she's now 'busy'. Leaving several messages. Janine never returns a single call. Weeks pass and Joe and Janine never get together again. He is left confused, frustrated, and alone. He repeats this pattern over and over.

This scenario is typical of how an otherwise great guy succumbs to the buyer's remorse trap. Many have fallen into it again and again and lost many opportunities at love.

What went wrong?

Here's what happened.

The Woman's Point of View

While Janine did enjoy making out with Joe, he did not take it upon himself to slow down the sexual escalation and remain in the comfort building stage. She truly did wish see him again, but only in the moment. When Joe called the next day, Janine wasn't in the same aroused emotional state as the night before. Due to cultural programming she felt a little guilty for doing what she did with someone she didn't really know. She knew the only reason Joe even called was to continue what was now making her feel uncomfortable just thinking about. If she did see him again, she didn't know how he would behave. Would he grope her and make her feel even more uncomfortable? She just didn't know him well enough to trust his future actions. Being one to indulge in her emotions, she allowed her emotions to once again make her decisions. Uncomfortable even talking to him on the phone, Janine is cold to him and lies, saying she's too busy to talk

When the confused Joe tried to change her mind, Janine took this as an attempt to manipulate her. She just didn't want to be pressured into having sex with someone she didn't feel comfortable and safe with, especially when she was not even aroused.

Joe was hard-pressed to change her emotional state on the phone. For all he knew at the time, with so many elements out of his control. Janine may have just had a fight with her room mate or just changed the kitty litter box. Over the next week or two, every time he left a message, her feelings of discomfort grew. She has no intention of ever seeing this guy again.

Joe shouldn't blame Janine for her *stringing him along* After all, it was he who ultimately designed this situation by not staying in the comfort stage for an appropriate length of time.

As hand holding escalates to kissing (more on how to perform *Mystery's kiss tactic* later), you will quickly approach a point of no return in which buyer's remorse is likely.

Beware:

The Buyer's Remorse Point of No Return

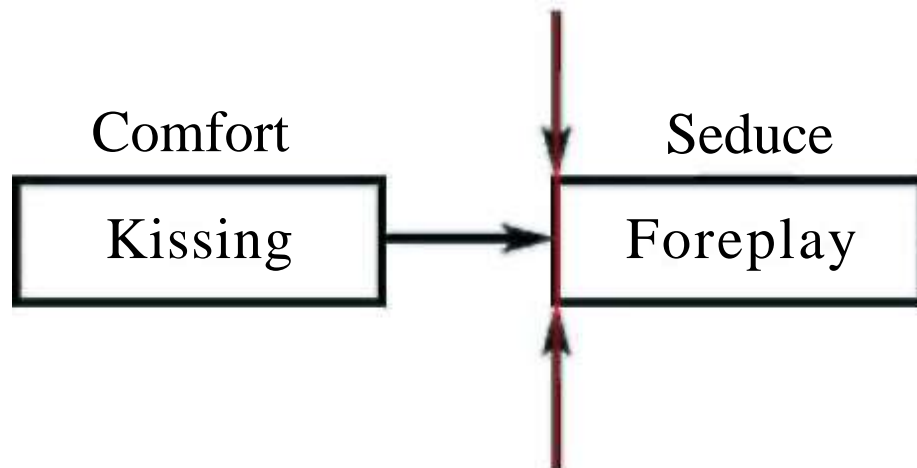

This point of no **return** exists where kissing **turns** into foreplay without enough comfort

- **KISS:**

To touch or caress with the lips as a mark of affection (or greeting)

Etymology: Middle English, from Old English cyssan; akin to Old High

German kussen to kiss

Date: before 12th century

- **FOREPLAY:**

Mutual sexual stimulation preceding intercourse

Date: 1929

Note how a choice you make at one time will determine the outcome of a situation a day or more later. Beware! Once you cross the point of no return, unless you have enough comfort established so you can get her to a **nearby** private location to have sex with her (before her arousal wanes), you will later get buyer's remorse.

It is only a seducer who considers the option of taking her to a nearby bathroom stall. Further consider that if your girlfriend of two years wouldn't feel comfortable having sex with you in a public bathroom, don't expect someone you met just twenty minutes ago to, no matter how aroused. This is a *foots mate fantasy* and not solid game. You may lose an otherwise great opportunity if you push for seduction too soon. (Although on the rare occasion that the two of you are willing, enjoy yourself.)

Non-sexual intimate kissing is a welcomed comfort stage action. *In fact, if you wait too long to kiss her, she will at some point become disinterested and you will lose the opportunity to lass her in the future.*

Generally, this type of "comfort kissing" lasts less than 30 seconds and does not include tongue. Kissing expresses and builds a sense of connection.

Foreplay on the other hand belongs in the seduction stage only. Generally, this consists of French-kissing which leads to sexual touching. It sexually arouses each other in preparation for sex. As kissing prematurely turns to foreplay, it's time to push her off of you.

Its best not to begin foreplay until you have the comfort and privacy necessary to transition naturally to sex. When pushing her off you, let her know that it's neither the right time nor place to be getting too hot and heavy. Agreeably, this is very tough and it is at this point that most men fail.

To help you pass this trial, you may ask yourself this very serious question:

*"Do I want one night of petting,
or countless nights of sex?"*

To know whether you are nearing the point of no return, ask yourself:

"Is this foreplay?"

If the answer is yes, stop! Push her away. Build comfort, not arousal. It takes a real man with reserve to say this:

"Whoa, we better stop. Come on, let's rejoin our friends."

Notice how *"our friends"* are really *"her friends."* With this winning move you build trust by demonstrating you want get to know her for more than her mere sexual favor. Since you now know she is sexually attracted to you, you may feel secure in that fact when you have established enough comfort to get her into a private seduction location (like your bedroom.) You may then sexually arouse her and allow nature to take its course *unimpeded.*

You may build intimacy and get close to the point of no return several times, so long as you are the first to push her away each time you've reached it.

M3 Sequencing Mistake # 4: Starting at the Beginning but Getting Stuck in the Middle

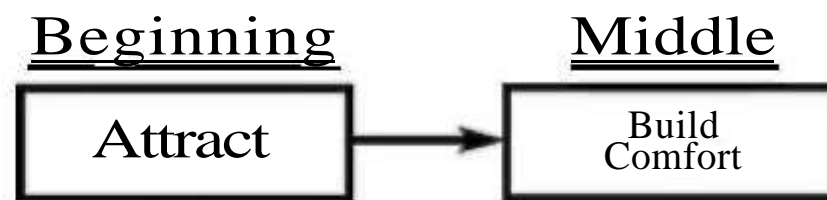

The Friend

The friend is someone who fears expressing his romantic intent to a woman he has spent time attracting and getting to know. He becomes entrapped in the comfort stage, circling around endlessly. He fails to seize the opportunity and develop the relationships potential by not completing the comfort stage to move on to the seduction stage.

The Friendship Zone

It during the comfort stage you do not convey to a woman that you are a potential romantic interest to her, she may not be intuitive enough to see that you are. By not holding her hands, smelling her neck, or kissing her during the comfort stage you trap yourself there, unable to proceed further. A woman may grow so comfortable with your non-sexual nature that she will prefer you stay that way. When you finally attempt to move into the seduction stage with a woman and you hear her say, "Let's just be friends," you know you have fallen into *the friendship zone*.

You cannot begin seduction until you end the comfort stage, but you cannot do that until you have built enough comfort. She must be comfortable with your sexuality too. This occurs when kissing her does not make her feel uncomfortable. When you are alone with her and you begin the seduction stage, you don't want her to be shocked by your *sudden sexual interest*.

Know that it is neither wrongful nor a sin to structure an opportunity for mutual seduction. After all, building a sexual relationship benefits her too.



To recap, the problems associated with improper M3 sequencing are:

1. Starting at the end —*fool's mate* problems
2. Starting at the middle —*protection shield* problems
3. Starting at the beginning but skipping the middle = *buyer's remorse* problems
4. Starting at the beginning but getting stuck in the middle = *friendship zone* problems



Gaming Locations

A solid game courtship that ends in sex will rarely *if ever* take place in its entirety in only one physical location. It is highly improbable that a woman you have never met before will knock on your bedroom door and invite herself in. Nature demands that you leave your bedroom and travel to a different location where meeting her is much more probable. This is where many lonely men fail miserably.

There are in fact three separate location types you and your romantic interest will likely visit:

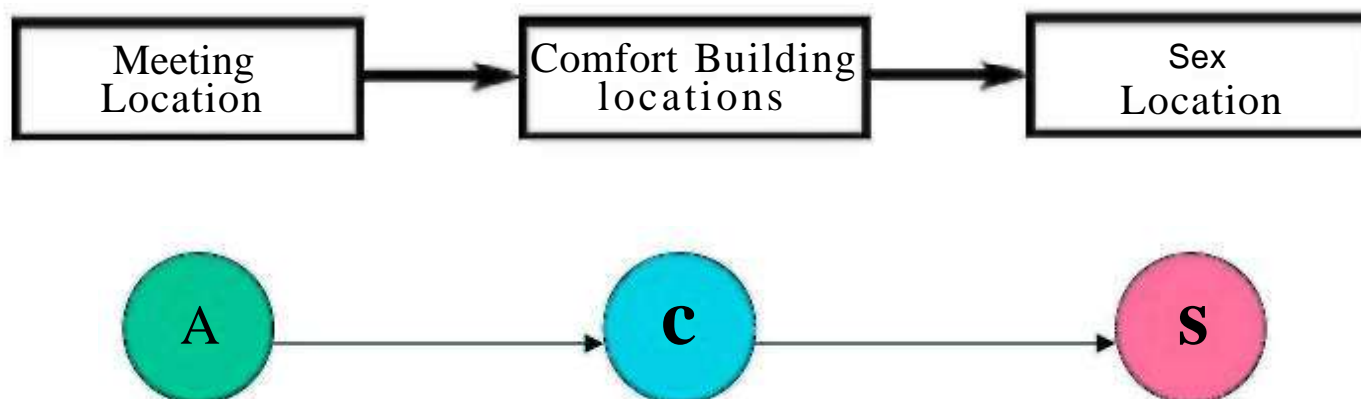

Location Changes

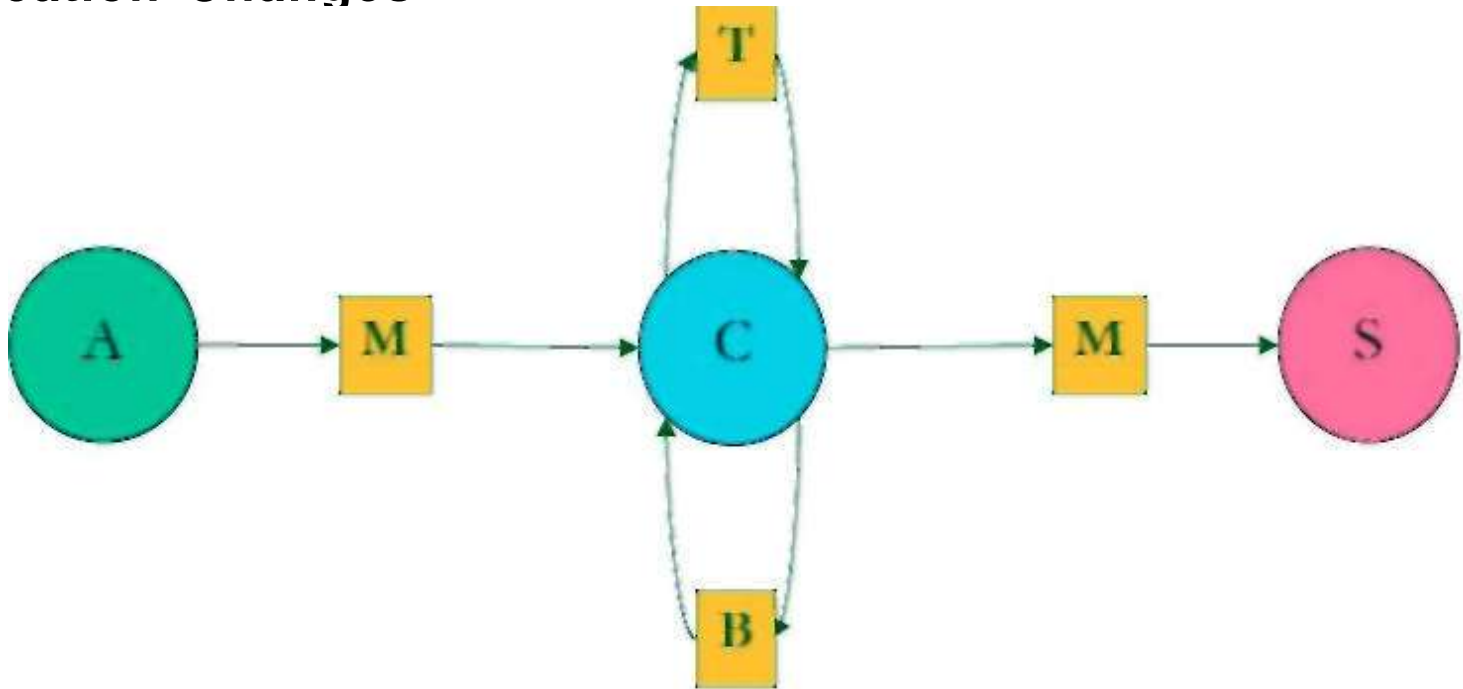

There are three types of location changes that commonly occur while gaming. They are the *Move*, the *Bounce*, and the *Time Bridge*. Briefly described here, these location changes are covered in greater detail in the subsequent chapters of this book.

M - MOVE

MOVE

Move the girl to a different area of the current venue.

B - BOUNCE

BOUNCE

You and the girl exit the current venue together, and go to a different venue together.

T - TIME BRIDGE

TIME BRIDGE

Sometimes it is not possible to escalate. Perhaps some outside factor requires you to **exchange contact information and continue gaming the girl at a later time and place**. This is called a **Time Bridge**.

The Nine Phases of the M3 Model

The three steps of the M3 Model - Attract, Comfort, and Seduce - are in turn broken down into three phases each. Though they are briefly described here, the nine phases of the M3 Model are covered in much greater detail in the subsequent chapters of this book.

A1 - OPEN	C1--CONVERSATION	S1--FOREPLAY
A2 - FEMALE-TO-MALE INTEREST	C2 -CONNECTION	S2 -LMR
A3 - MALE-TO-FEMALE INTEREST	C3 -INTIMACY	S3 -SEX

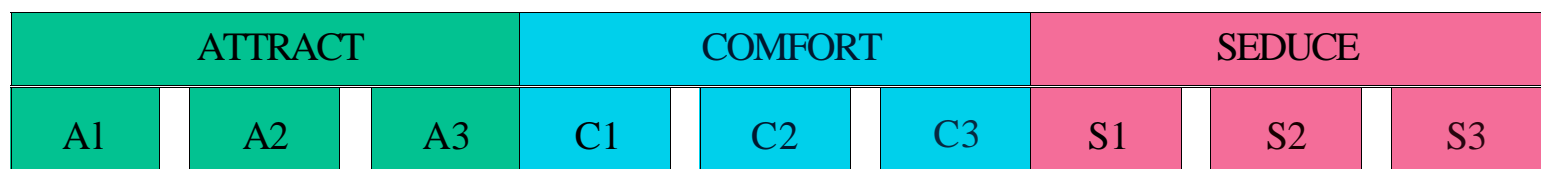

A1-OPEN

The man approaches a set, runs an opener, and reaches the Social Hook Point.

A2 — FEMALE-TO-MALE INTEREST

The man demonstrates higher value, while simultaneously showing disinterest in the target. She responds by giving indicators of interest.

A3 — MALE-TO-FEMALE INTEREST

The man baits the woman to become more invested in the interaction, and then he rewards her efforts with indicators of interest.

C1 — CONVERSATION

The couple begins a conversation and grows from a sense of comfort **and** rapport into a feeling of connection.

C2 — CONNECTION

Both parties feel a vibe that "it is on." Kissing occurs. This phase may last over the course of several dates.

C3 — INTIMACY

Now at a seduction location, heavy making-out ensues and the couple moves into the bedroom.

S1 — FOREPLAY

The couple begins the physical escalation towards sex. If tills happens too soon it can cause buyer's remorse.

S2 -LMR

Last-Minute Resistance. This is the point of no return before sex occurs. It's often a freak-out moment for the woman.

S3-SEX

Sexual intercourse. It is necessary to do this several times in order to begin the sexual relationship.

Diagram A

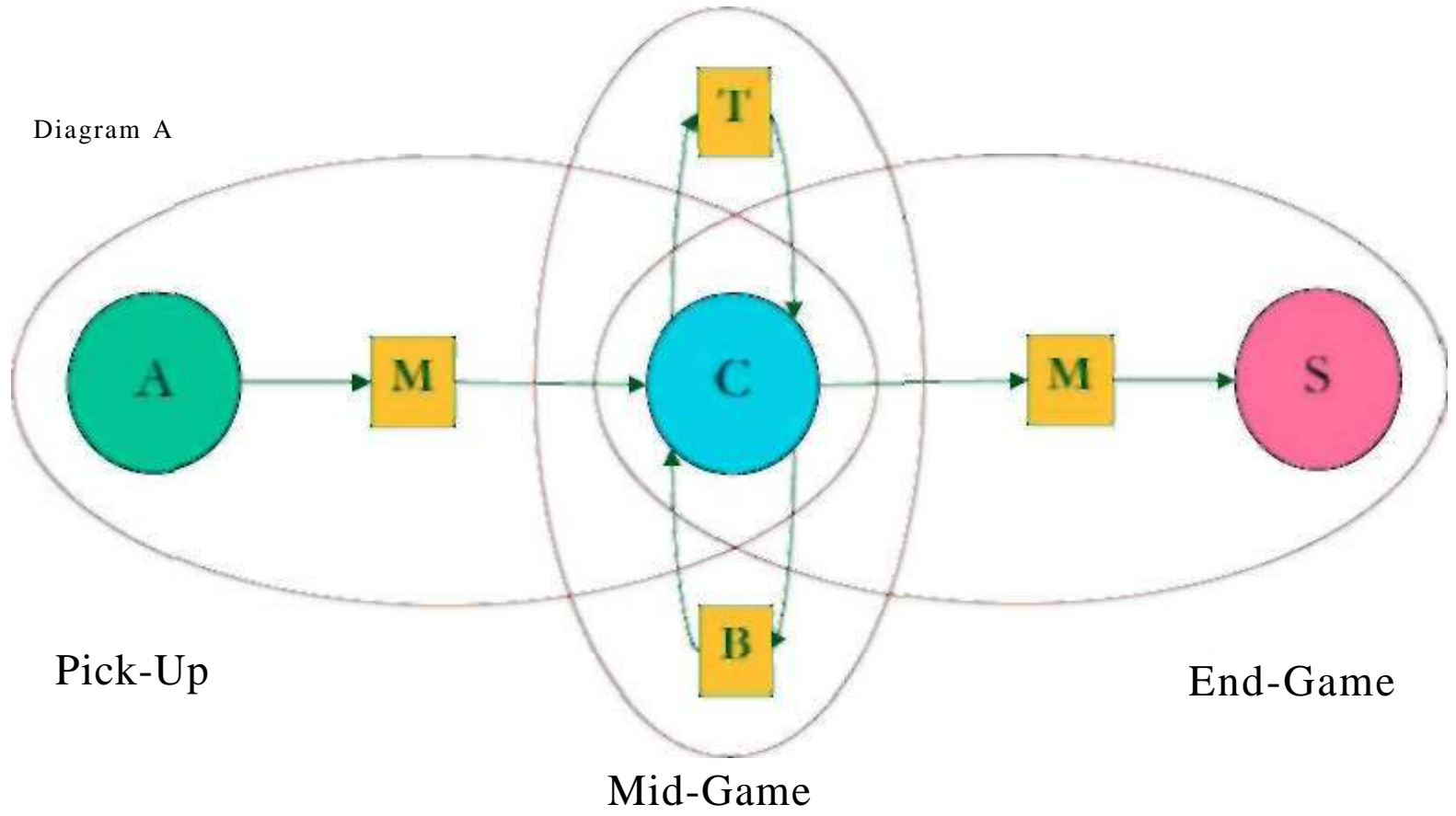
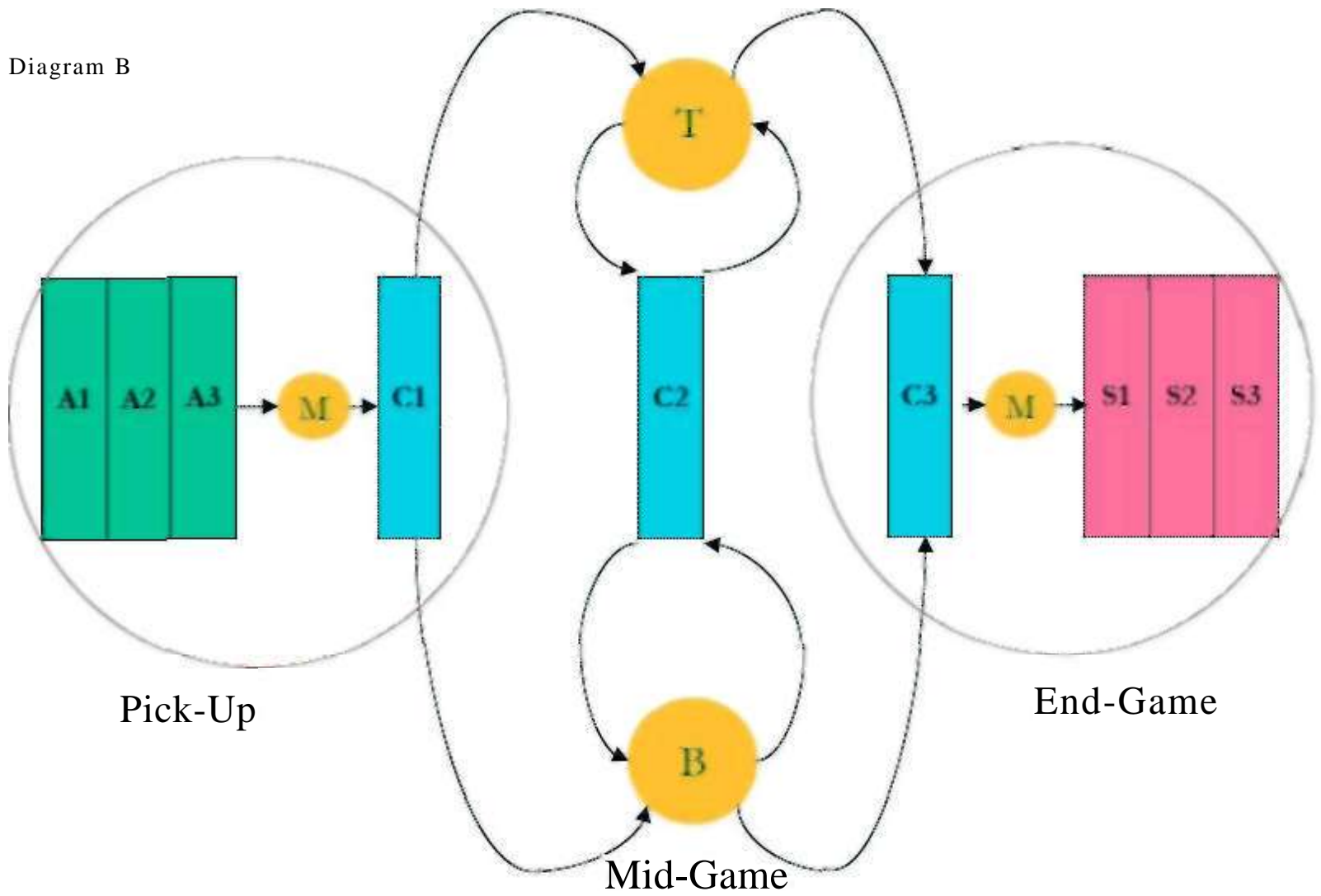
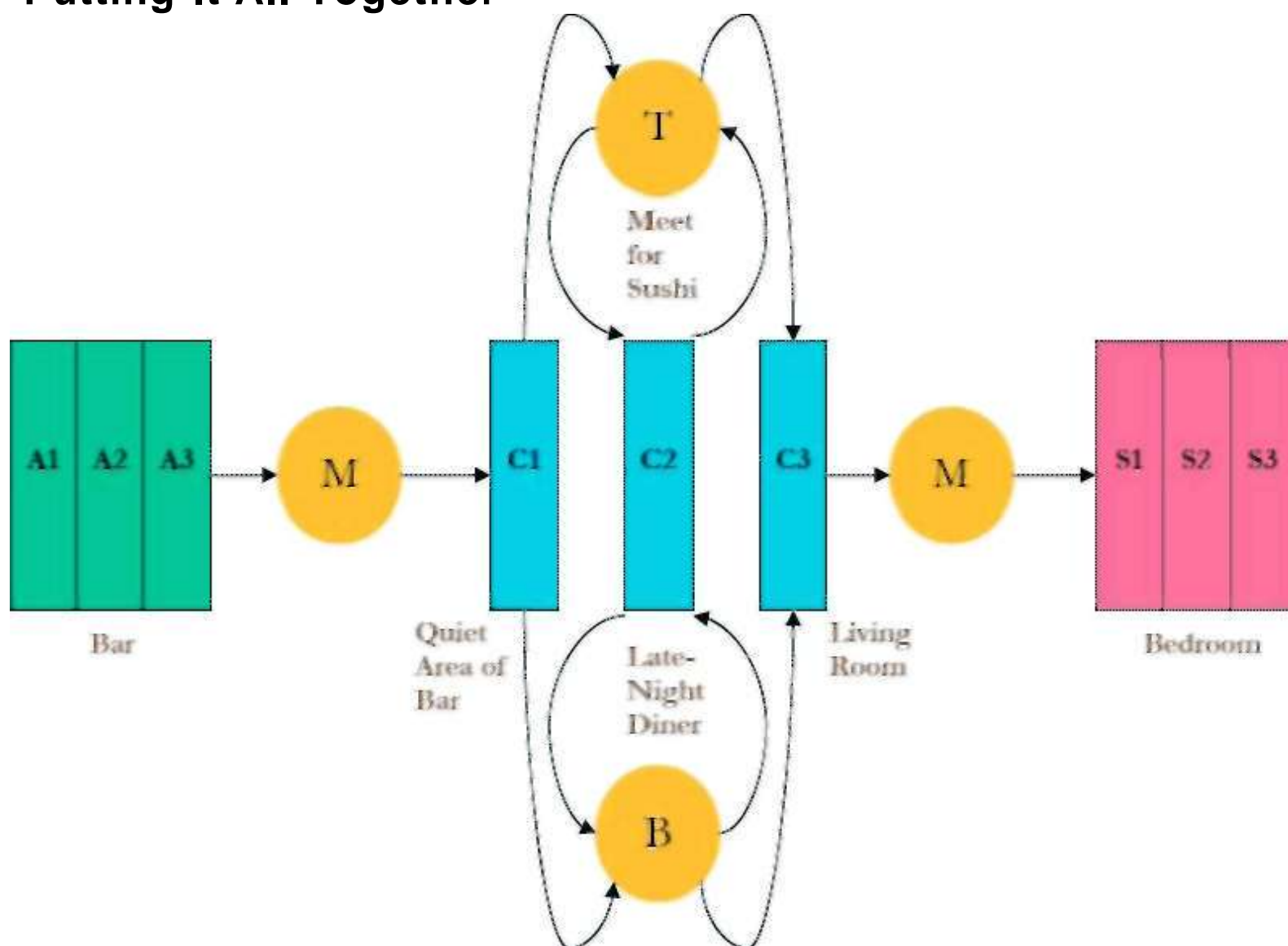

Diagram B



Putting It All Together



A1. A venusian artist with tight game approaches a set of people in a bar, using an indirect opener. He doesn't seem needy or interested in the target, and in fact comes across as though he's just leaving. He then demonstrates higher value to the set and crosses the Social Hook Point.

A2. He continues to convey his personality using stories, humor, patterns, games, routines, palm reading, poetry, etc. This, combined with his apparent disinterest in the target, raises his social value relative to hers and intensifies her emotional state. She begins to give him indicators of interest.

A3, C1. He uses this to bait her into chasing after him to earn his affections. As she becomes more invested in the interaction, he rewards her **with** indicators of interest. Then he moves her to a quiet area of the bar to begin building comfort.

C2, C3. With a bounce to Mel's Diner and a time bridge for sushi the next day, he builds comfort, connection, and trust over a cumulative seven hour period. At some point early during this phase they will begin kissing. They eventually bounce to his apartment.

S1, S2, S3. Finally, he moves her into his bedroom, begins foreplay, overcomes any last-minute resistance, and has sex with her.

Chapter Three Review

- The Game is played in the Field. Get out more.
- The Mystery Method Newbie Drill
 - Go out gaming four nights per week for four hours each night.
 - Make three approaches per hour.
- Gaming is like golfing or fishing. You must enjoy the process and release expectation from outcome in order to get the best results in the long term.
- Every sexual relationship has a beginning, middle, and ending. The beginning is known as the *courtship*.
- The courtship has **three** stages, known as the *pick-up*, *mid-game*, and *end-game*.
- Mystery Method focuses on attraction first, not seduction. Ethically, practitioners of the Mystery **Method** are attractors, not seducers.
- There are certain hardwired attraction switches in every woman's mind. Attraction is not a conscious choice that people make. Rather, it's a response that they feel automatically as a result of these switches being flipped.
- One example of this is *preselection*. This switch gets triggered when a woman sees that you have already been **pre-approved** by other women.
- The M3 Model describes the structure of the courtship as occurring in three steps: *Attract*, *Build Comfort*, and *Seduce*. It is necessary to build comfort **before** you can seduce a woman, and it is necessary to build attraction before she will bother to build comfort with you.
- The phenomenon where you occasionally get sex even when you haven't built enough comfort is known as *Fool's Mate*.
- There are three types of location changes: *the Move*, *the Bounce*, and *the Time Bridge*.
- Women have certain strategies; built-up over time, that enable them to avoid constant approaches from men. This is known as the *protection shield*. Even though she is probably a nice person, she can sometimes appear bitchy as a result of this. It's not who she really is.
- While comfort building, it is important to convey to her that you are a sexual man and a potential romantic interest. Otherwise you can get trapped in the *friendship zone*.
- The three steps of the M3 Model are broken down into three phases each: A1 — The Approach. A2 — Female-to-Male Interest. A3 — Male-to-Female Interest C1 — Conversation. C2 — Connection. C3 — Intimacy. S1 — Foreplay. S2 — Last-Minute Resistance. S3 — Sex.
- There are three types of locations: the Meeting location, the Comfort-building locations, and the Seduction location.
- The *pick-up* occurs at the *meeting location* and covers the phases A1, A2, A3, and C1. It usually includes at least one move and ends with a bounce or time bridge.
- The next stage, called *mid-game*, occurs in one or several *comfort-building locations* and covers the C2 phase. Various bounces and time bridges may occur here. When this stage is over, you will be with her in the seduction location and you've already been somewhat intimate with her (kissing, etc.)
- The final stage, called *end-game*, begins in C3 but soon shifts into S1 (foreplay.) Often *last-minute resistance* (S2) will come up, **which** is normal, followed by sex (S3.) If you initiate foreplay before enough comfort has been built, it will cause *buyer's remorse*.
- It is necessary to have sex several times before the sexual relationship actually begins. During and even after this point she will continue testing you for congruence.

A1: The Approach

Opening a set and crossing the Social Hook Point without conveying neediness

Once you begin talking to a set of girls, the immediate goal is to reach the *Social Hook Point*. A moment comes when the set decides that they enjoy talking to you, and that they want to continue talking to you. When this happens, you have successfully opened the set and finished A1. It's easy to tell when this happens because there will be *indicators of interest*.

The Meeting Location

Any location in which there is a high probability of meeting women is called a *meeting location*. While it is *possible* to meet a beautiful woman virtually anywhere, even on the street, it is more *probable* to meet her in a public gathering.

Meeting
location

Meeting locations are gatherings in which people self-organize into small groups of usually two to five friends each.

Examples:

- *Restaurants and busy cafes*
- *Pubs, bars and nightclubs*
- *Busy stores, malls and outdoor festivals*
- *Parties and get-togethers*

The unconscious replication agenda

People often publicly assemble to drink, mingle, dance, shop, or eat. While some know they are out specifically to seek a mate, many are unaware that their unconscious mind has imposed a hidden replication agenda upon them. Even though women know these gatherings are chalk-full of pestering nice guys, most are unconscious of the fact that nonetheless, their, emotional circuitry has a replication agenda compelling them to actively socialize, such as when women go out "*just to dance*." This is a perfect example of *rationalization* at work.

Attractive women are found in groups

Seldom will you see women of beauty alone in such locations. Many have grown accustomed to the constant threat of nice guys that plague these gatherings. They learn to band together **with** trusted friends to help protect them from these everyday public nuisances.

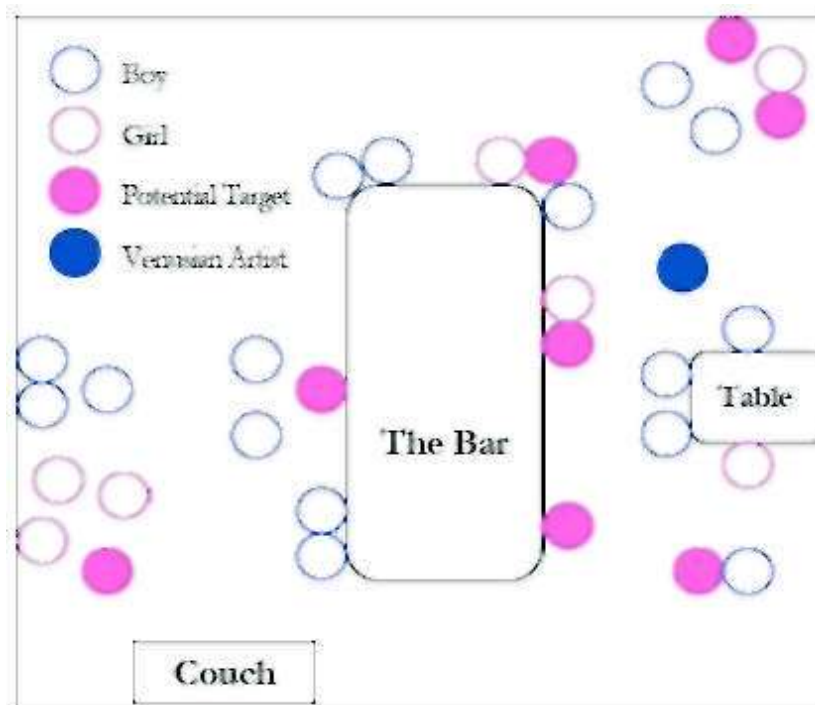

A meeting location is said to be *target rich* if it offers multiple approach opportunities with attractive women in short succession; whereas a location **with** few such opportunities is said to be *target poor*. Target rich environments not only improve **your** chances of finding and attracting a beautiful woman, they also **substantially** accelerate your learning curve by providing more chances to practice your social skills in less time. Proactively choose to go to the very best meeting locations ahead of time.

Hired Guns

You may thank the managers of many meeting locations for hiring attractive women because they have performed the difficult task of finding these women for you. These *hired guns* include seating hostesses, shooter girls, bartenders, go-go dancers, and promotional models. Most are chosen primarily for their physical looks. The Mystery Method incorporates specific attraction tactics for hired guns, including exotic dancers. (These *hired gun tactics* are not written in this book.)

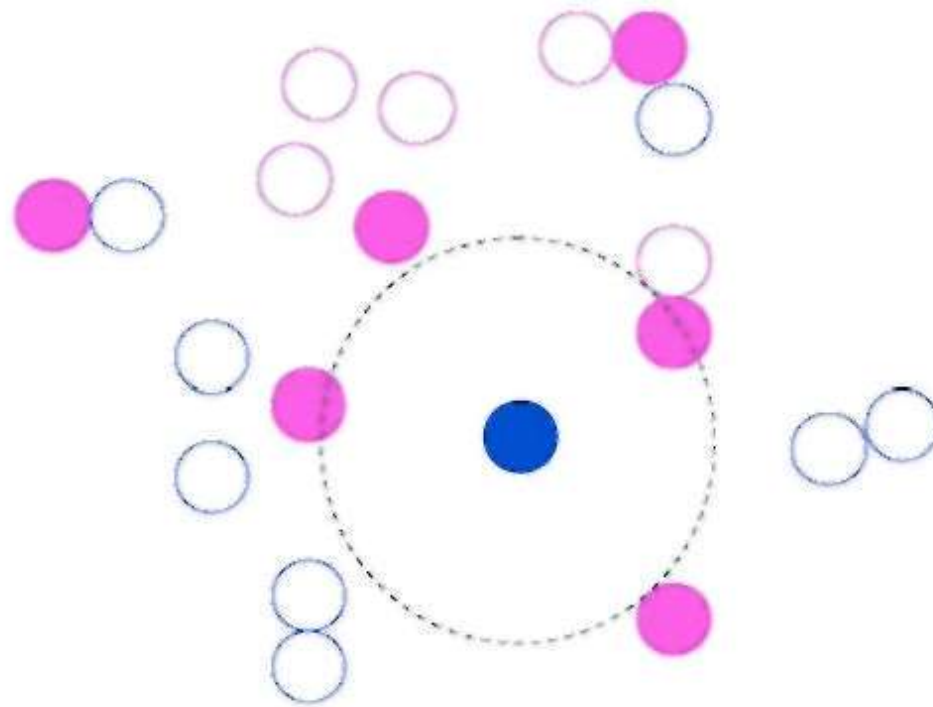

Proximity

When you are in the field, a shy woman, reluctant to even make eye contact with you, may find you visually appealing and on a conscious or unconscious level reveal her interest through her proximity.

Typically if a girl is giving you proximity, she will be standing five or six feet away and she won't be facing your direction. Dynamic social homeostasis brings her to the perimeter, but prevents her from coming too close.

If you open her, she will open receptively.

Have you ever walked into a nightclub and found yourself standing near a woman you were attracted to, if only to be near her and check her out more? Maybe instead of approaching her, you ordered a drink at the bar right next to her. Have you ever been in a store shopping where it seemed that a woman you had seen earlier stood near you several times over a short period of time?

Her repeated proximity indicates a potential interest. She may be putting herself near you on purpose hoping that you might start something. *It's also quite possible that her replication circuitry is placing her near you, even though she is not consciously aware of what her body is doing.* She will still open receptively.

These opportunities occur with more frequency than you may have previously noticed, so pay attention.



The 3-Second Rule

You want to be in a set within three seconds of entering the venue. Just walk right up to the first set of people that you see and open them. This is called the *3-second rule*. Remember, you are not only working the set, but the entire room-

No one else knows whether you are already acquainted with these people. It certainly seems as if you know them — you entered the venue, walked right up to them, and now they are having a fun conversation with you. You must be a social guy with lots of friends!

Then you move on to the next set, and the positive perception of you continues to grow. You are becoming *socially proofed* in this venue. Notice the magical ease **with which** sets will open up to you when you have this level of social proof. For this reason, it is important not to be too selective in choosing your sets. It's better to be in a set **than** to get picky and end up alone when you should be working the room.

Another interpretation of the three-second rule states: Within three seconds of spotting a set that you want to open, you must open that set.

This really adds a natural spontaneity to the approach. The difference in your state of mind is noticeable. A woman can usually tell when a man is working up the courage to approach her, which can lower her perception of his value. But if you follow the three second rule, she will have a feeling like you just popped up out of nowhere. A very nice energy is added to the interaction when following this rule.

Social Proof

Some players can be seen walking around the venue, eyeballing all the women and looking for a good one to approach. This behavior looks predatory, and is quite transparent to the people in the crowd-

Similarly, some guys may be seen standing in a group, peering around at the field. If they don't look like they are having a great time together, if they aren't hanging out with girls, if they aren't running a set ...then they will start to lose social status. When one of them finally does open a set, he may discover that opening is more difficult in environments where he has *negative social proof*.

Whereas a venusian artist, rolling in with his wing, is not going to be looking around at the people in the crowd. Rather, he's going to be talking to his wing, and it will appear as if they are two high-value guys having a great time together.

If he *were* looking around the venue, especially with a serious expression on his face, it would telegraph that he is looking for something more fun and of more value than the spot where he already is. But he isn't. He believes that the most fun and valuable spot in the field is his own spot, his own reality - and he is congruent with that.

Women are searching for a man whose reality is more fun and more valuable than their own. You must be **congruent** with the value that you have to offer, and it must be apparent to the room. Follow the three-second rule, and you will be in set much more often, resulting in higher social proof

It's interesting that whenever you have more social proof, you will get noticeably more occurrences of **proximity**. Girls will also give you other *approach invitations*, such as making eye contact. Remember that it's not necessary (nor is it necessarily desirable) to wait around for *AI (approach invitations)*, because with practice, a venusian artist can consistently open sets even without *AI*.

Tips in the Venue

Bars and clubs are probably not the venues where you plan to find your future wife. Nevertheless, these are *target rich* environments and thus are perfect for practicing game. Here are some tips:

- As a general rule — but not a dogmatic one — don't offer to buy drinks for girls. If she asks you to buy her a drink, **turn** her down. Although you can break this rule, it's preferable to get your game so tight that *she* will be buying you drinks.
- Be willing to crash and burn on every set for the entire night. Do it for fun with your wing.
- Give your wing \$200. Then he gives you \$20 every time you approach a set. This game is very effective.
- Be willing to go out alone if you have to.
- Don't hold your drink in front of your chest like a security blanket. Hold it low to your hip.
- Don't try to look '*cool*' or '*tough*,' or you will just look boring. Instead, be comfortable and friendly.
- Enthusiasm is contagious.
- Smile as you walk around the venue. Guys who don't get laid, don't smile.
- Once you open a set, stop smiling so much. You don't want to appear *try-hard*.
- You ran your opener, but the set didn't hook? Run another one. Stack your material if for no other reason than to get practice. Stacking routines is a useful skill in-and-of-itself.
- It usually takes three *warm-up approaches* to really get in the groove.
- Avoid noisy areas. If you can't talk, you can't run game. Find the quiet areas of the club. And avoid the dance floor — it's a trap.

- Arrive early and be friendly with the staff. At midnight, bounce to another club. This keeps the crowd fresh and gives you somewhere to take girls that you've been gaming.
- Don't drink. Or at least cut back. If you go out gaming without alcohol, you will really notice an improvement in your abilities.
- Male competition. Yes there are other guys — but they don't count. They don't smile; they don't surround themselves with talking and laughing people, they don't walk around with a smile on their face. Instead they hold a beer to their chest and try to *look cool'* These guys are not really competition at all.
- Befriend the social guys, and practice gaming them. One of the attraction switches in women is the *lender of men* switch. *When you lead the men, the women will follow.*
- Be the *observed*. There are constantly little events going on in the Field: A flash goes off as a group of people pose for a picture. A man teaches a woman a little dance move. A group of people bust up laughing. A girl gasps at an impressive routine, and people nearby look over to see what is going on. Are you the *observer* when these things happen, or the *observed*?

The Protection Shield

There are many shielding strategies women use. Here are some of them:

- A ring-
- Saving she has a boyfriend
- Surrounding herself with friends.
- Sitting in a place where it is hard to approach her.
- Being bitchy; using insults.
- Negative body language.
- No eye contact.
- Disinterest.
- Being bubbly and wanting to dance.
- No sense of humor.
- Being defensive.

The opening phase is the time that it takes you to get past the shield and reach the hook point. You might try pushing through the shield with persistence, despite the fact that the woman is treating you poorly, but this is foolish and diminishes your value.

What if you can trick her into lowering her shield? This means making the woman believe you are not here to steal her eggs. She must think that you aren't even considering seducing her.

One way to do this is to say things that an interested man would never say. These are called *Negs*, and they are described in the next chapter.

Another way is to enter her set with a *pawn*. A pawn is a girl that you have gamed previously for the express purpose of bringing her into your next set, so that it will open easier.

Another way to get through the shield is through the use of *disinterested body language* and *false time constraints*. These techniques are described in detail in this chapter.

Notice that all of these tactics have one thing in common: *they convey disinterest*. In other words, women aren't so shielded against men who have a *willingness to walk*. Women feel safe around those men.

Whatever happens, it's crucial that you *not be affected* by her shielding behavior, no matter how unacceptable such behavior may be. If she is able to shake your internal sense of reality, your value will drop in her eyes. Never get angry — just stay in a good mood and be unaffected. *It's no big deal*.

As you demonstrate value, and an utter lack of neediness, she will start to open up to you. How will you know that you have disarmed her shield?

- When she laughs at your jokes.
- When she turns to face you, gives you eye contact, and is responsive to you.
- When she touches you - usually a soft grab of your arm or leg, or your necklace or hair.
- When she asks you your name.

Canned Material

The Mystery Method makes use of *canned material*. If a **particular value-demonstrating routine** has been internalized, and is ready for use in set, then that routine is said to be *in the can*.

A venusian artist who can deliver canned material **properly** will be able to generate consistent, **powerful** responses while he is in set. It is a potent tool. Of course, no single tool should ever become a crutch — it's also vitally important for the open-minded venusian artist to practice spontaneous, **natural** conversations. There is something to be said for basic social skills! Nevertheless, your skill set is incomplete without the ability to **congruently** deliver canned material.

It is recommended that you create a *routine stack* of canned material that you can practice in the field. That is, an opener, a few routines, a few negs, and so on.

While practicing your routine stack, approaches start to become a blur. Patterns emerge over time. Situations and reactions become easily predictable before they occur. Social challenges are discovered and solved. The rest of the world is riving by at hyper-speed.

Once you have performed a **particular** routine hundreds or thousands of times, you don't even have to think about what you are saying. Your mind is free for other tasks, such as planning logistics. The target is consciously considering her responses, but you have already had this conversation a thousand times before. You have already fully explored all the conversational threads that could possibly arise from this piece of material. It's almost like seeing the future.

Creating your own material

Although certain stock routines are included in this book - and many more are traded online - it is recommended that in the long term you develop all of your own material. This will save you the embarrassment of running a routine on a set who has already heard it before, which is a possibility in this day and age.

Usually the best material is delivered from the heart. In the long run your *personality-conveying routines* will be the most **congruent** if they come from your own life. (That having been said, the ability to congruently deliver someone else's material is still an important skill.)

Proper Delivery of Material

It is an under-appreciated fact that the delivery of canned material is often more important than the content. Women have a finely-toned intuition for the subtle behaviors of a man with high S and R value — his eye contact, tone of voice, body language, and so on.

The use of canned material allows you to somewhat automate the verbal aspects of the interaction, so that you have more of an opportunity to practice the delivery. Once this improved delivery has been internalized, even your natural, spontaneous conversations will benefit. *Your delivery itself will become a demonstration of higher value.*

Expressiveness

Many beginners are not as expressive as they need to be with their facial expressions and vocal tonality. Due to this, if they were to increase their level of expressiveness to where it actually needs to be, it would *feel* as if it's too much. This feeling can be deceptive.

It's better to be more expressive in the beginning, even when it feels like too much. You can always calibrate your energy back down later, over weeks or months of practice.

More on Energy Levels

Gaming with a higher energy level makes it easier to hook sets. In fact, beginners can become addicted to the powerful responses they can generate by running game with emotionally expressive vocal tonality and facial expressions. Of course, a well-rounded venusian artist should be capable of hooking sets at lower energy levels as well.

When first opening a set, it's important to come in at an energy level slightly higher than that of the set. If you come in at lower energy than is already in the set, you are only going into their set to bring them down. This is not what they are interested in.

If your energy is too low, sets will not hook. If your energy is too high, sets will easily hook but closing will be more difficult, and girls will more often accuse you of being gay. But when you open with the right energy level, sets will hook and lead to solid closes much more consistently. Only time in the field will give you the calibration to know exactly how much energy is appropriate for each set.

Opinion Openers

The main purpose of the opener is to get her attention and raise her interest in a chat. It is not a time to hit on her. It is not a time to introduce yourself. It is not a time to compliment her or spend money on her.

Although there are many different kinds of effective openers, the Mystery Method tends to focus on *indirect openers*.

One form of indirect opener is the *opinion opener*, credited to Style. Possibly the most commonly used form of opener; it is easy and effective. Without further ado, here is the most popular opinion opener of all time:

The *Jealous Girlfriend Opener*

by Style

"Hey guys, we're doing a poll...Would you date someone that's still friends with his ex-girlfriend?"

—(Girls talk for a bit, then you cut them off.)

"Ok I've only got a minute...actually this is a two-part question....My friend Dave has been dating this girl for a couple months, but he's still friends with his girlfriend from college. What do you guys think about that?"

—(Girls ask how close they still are, then you cut them off.)

"Well he still talks to her on the phone, and he's still got this shoebox with letters.. .pictures.. .what do you guys think about that?"

---(Girls talk for a bit, then you cut them off.)

"Well **get this**, she told him that he needs to stop talking to the girl, **and** he needs to **burn the box..**"

----(Girls talk excitedly about topic.)

"Oh my god, listen to you guys, this is just like watching *The View*."

—(Transition into your next routine.)

The first interesting thing about this opener is that he isn't seeking rapport with the girls or trying to impress them. He's not being needy, or rude or overly nice. He's completely neutral and *indirect*. He's just taking a poll with his friends. He could have asked anyone — *it just happened to be her*. He doesn't even see the girls as sexual beings, referring to them as *guys* instead of *girls* or *ladies*.

Next, he adds value to the conversation by giving them a piece of juicy drama on which to opine. They find this interesting and give him their attention as they chatter about the situation laid out in the opener. Their girly-girl reaction gives him an opportunity to tease them.

Finally, the opener reveals a communication cycle where he *takes control, adds value, and then uses that value as bait to get the girls invested in the interaction — then the cycle repeats*. The girls' specific input is not necessary at all to run the opener; what's important is the illusion that's created that they are participating. He then cuts the girls off and re-asserts control of the conversation so that he can lead it to the next morsel of value, baiting the girls into further illusory participation, and so the process repeats. *This "lead, bait and chase"⁹ cycle is also an illustration of the entire Attract phase of the Mystery Method.*

The Cologne Opener by Style

Style: "Hey guys, I want your opinion on something. See, I have two different colognes on my wrists, and I want to see which one you like better."

(Let them smell the cologne. Be cocky and funny, neg the target, etc.)

Style: "The reason is, I have so many colognes from my ex-girlfriends on my shelf, and I want to give some of them away and keep the best ones."

Variation #1:

After she picks one, you pull out **a pen** and make a mark on your wrist, next to five or ten others...

Variation #2:

Her: "So what are they?"

Style: This one is hemlock, this one is chloroform."

Variation #3:

Style: "Thanks. I have all these old colognes around the house, so I'm having a face off. This one has won ten days in a row!"

Tonality and Pacing

The quality of **your** voice is extremely important. Although no problem is insurmountable, certain vocal qualities are preferable to others. Some important points:

- **Have a deep, powerful voice that comes from your diaphragm.** If you have any issues with an accent that is considered unattractive, (you know who you are) get a voice coach and have the problem fixed.
- **Be emotionally expressive with your voice.** It may be useful to take classes on acting and improvisational comedy.
- **Speak slowly and clearly.** Eliminate 'uh,' 'like,' and 'you know' from your vocabulary.
- **Speak. With plenty. Of pausing.** Create...a certain rhythm...to the way...that you speak. This will rivet attention to your words.
- **Speak loudly.** Women are programmed to automatically respond to a man with a louder voice. This doesn't mean that you should lack social discretion and talk loudly all the time - but recognize that it is a useful tool at your disposal, especially in louder venues. This will make you come across as "more alpha."

These are all very easy to field-test. Open ten sets with a loud voice, using plenty of pausing, and then open ten sets with a quiet voice and no pausing. The difference in response is striking. *The field does not lie,*

The Picture Opener by Mystery

"Hi. Could you do me a favor?"

—**Wait for her to respond. They will usually think you are hitting on them at which point you pull out your digital camera and say:**

"Could you take a picture of my friend and I?"

—**This is a good, subtle neg. As you hand her the camera, give her a playful additional neg by saying:**

"You of course *do* know how to use a camera ... yes?"

Body language

When you first run your opener, don't face the set with your body. In other words, your head may be turned towards the set as you address them, but the rest of your body should not be.

You can tell a lot just by where someone's feet are pointing. If one came across as *report-seeking* during the opener, the set would perceive it as a low-value behavior. They would then treat him like a low-value guy and blow him out of the set.

Field-testing has shown us that the percentage of sets that open successfully is drastically affected by this one factor.

There are two common opening scenarios worth mentioning at this time. In the first, you are simply walking by the set *"on your way back to your friends."* As you pass the target set, you stop, turn your head towards them, and run your opener. As the opener hooks, you can then turn the rest of your body towards the set and continue.

In the second scenario, you are already in a set, adjacent to the target group. This gives you social proof. At the right time, simply lean back towards the target group and, over your shoulder, run an opener. As before, when they start to hook, you can turn your body towards them.

Calibrate!

Usually a girl will turn her body in to face you as she hooks to your material. When she does this, you should then turn your body towards her as well. (Reward her for good behavior.) If you do this prematurely, you will come across as needy or over-eager. Feel the calibration *flow*.

Within the first thirty to sixty seconds of running the opener, your body should be facing the set — and they should be facing you. You can't run the set over your shoulder, but you should open it that way.

Lean Back

The next time you are in a social situation, look around the room and take stock of the various conversations that are ongoing. In a given conversation, notice how one person may be leaning in, while the other person is leaning back. See how clearly it seems that the person leaning back has more power, and the person leaning in has less.

when you lean in, you are conveying to her that she is more important to you than you are to her. Again, this tells her that you are lower value than she is. A subtlety like this is often the critical factor in losing a set.

Many beginners engage in *pecking*, which is the act of leaning in every time you say something. Do not do this! Her emotional circuitry will inform her that you are not a man of high survival and replication value, and she will stop responding to you.

The 'Who Lies More' Opener by Mad Dash

"Hey guys, quick question...Who lies more...men or women?"

---(Girls talk for a bit, then you cut them off.)

"Ok, I can only stay a sec, my friends are waiting, but who *cheats* more, guys or girls?"

—(Girls talk for a bit, then you cut them off.)

"I was waiting to get a haircut a few weeks ago, reading one of those women's magazines, and it says that girls lie more *and* cheat more...is that true??"

---(Girls talk about topic. Go into your next routine.)

Incongruence

Have you ever tried to use another person's personality-conveying routine, only to have it come out of your mouth like a bad script? When what you say and how you say it don't match up in a natural manner, you have what we call *incongruence*.

To get a woman interested in you, you must be interesting. That is why venusian artists share stories and routines. *What one man can do, another man can do*. Some have suggested that you should "just be yourself" and not use interesting, field-tested and proven material. But this material creates the opportunity to get valuable practice in the field, building calibration, while having something interesting to say.

Like a comedian, a pickup artist is also a performing artist. A pickup artist's task is to captivate a small group of people long enough to convey specific personality characteristics which ultimately make him interesting to the one woman in the group that he has his eye on.

The material he runs is like a vehicle that he uses to convey his personality to the group — and obliquely, to her. When a comedian tells a joke, people say, "That's a good joke." But when he strings several good jokes together, people say "he's hilarious." It is no longer the material that takes the acclaim, but the comedian himself.

Picture this. An amateur comedian is hanging out with friends and accidentally tells a funny joke during conversation, generating a great response. He thinks to himself, "Man, that was funny; I'm going to put that in my comedy act." So a few days later, he does - only the comedy routine falls flat. He thinks to himself, "When I said it to my friends, they really cracked up. It must be the audience."

So the next week he throws the joke into his act again, and again it fails to make the audience laugh. He thinks, "Hmm, why didn't this work? Is it the material, or the audience that's to blame?"

He decides to try the material out one more time the following week and again, the routine fails to make people laugh. He's had enough — he drops the routine entirely.

Now let's look at what a professional comedian does. You see, it is the professional who knows that reciting a joke only three times in front of an audience is simply not enough. He knows he must practice telling the joke again and again in front of a live audience to systematically build back the natural timing that the joke had the first time he told it to his friends.

The bad news is that every new routine that you learn must go through this *naturalization phase*. It may take a good two dozen times until the scripted routine comes out congruently. The good news is, when you're doing a dozen approaches a night, you'll have a totally natural routine *in the can* in only two nights.

If you add a new routine to your game on a weekly basis, you'll soon have a whole list of routines *in the can* when you really need them. There will come a time in your near future that you will be given an opportunity to attract a woman of particular quality. Are you ready for the challenge? Do you have enough material naturalized and ready to go, so you can attract her with congruence?

The Problem with the 'Who Lies More' Opener

by Style

Whenever I'm winging workshops, and I go around the room and ask guys what opener they use, half of them say, "Who lies more, men or women?" And then I see them go out and use it that night, and half the women usually respond by either by asking, "Why are you asking us this?" or "Are you taking a survey or something." Or by just giving them bad body language and trying to end the conversation as soon as possible, then laughing at them behind their back.

I remember the opener suddenly appearing in the community like a year and a half ago, and can't remember who made it up, though I think it was a workshop student. And it is a great opener to learn, because it's so short.

The problem is, it's imperfect and incomplete. There's a subtlety to any opinion opener: *There must be a reason **why** you're asking it*

In other words, you can't just walk up to a group and ask a random question for no purpose. It's weird. You need to *root* it in the time and place. For example, when I use the *jealous girlfriend* opener, I mention that I'm asking because I just got a phone call from my brother about it or "we were trying to give my friend over there advice." When I do the *spells* routine, I say it's about "my friend Will, who isn't out with us tonight because he's with this girl." You must root your opener to make it a valid reason to approach a group.

Maybe some people who use *Who Lies More* actually give it a context, but no one I've heard. So if you are going to continue to use this opener, you *must* modify it, or find a new one. Examples of roots for the *Who Lies More* opener include:

"I was reading Esquire today and they did this study, and guess what the results were? My friends and I have been debating about it all day. We disagree." OR, "My friend over there just broke up with his girlfriend because she kept lying to him about little things. And we thought it was funny, because guys are the ones who have the reputation for lying. But now he thinks women are worse. So we're trying to save him from being bitter about women for the rest of his life. Only you can help save him from ending up a lonely, miserable old man, eating dog food in a studio apartment downtown."

These are just random roots I've put into the opener, off the top of my head. I'll field test them and, in the meantime, if anyone field tests a rooted version of *Who Lies More* and it works as solidly as everything else, please let me know. Let's complete this opener so that everyone can start using it correctly and effectively.

False Time Constraints

When you first open a set, you haven't yet had much time to build value, and thus you are nearly indistinguishable from every other loser guy. A girl might think, *Oh great, how long is this guy going to be here? Am I going to have to go dance, or go to the bathroom, or go buy a drink, so that I can get rid of this guy?*

This is not a useful frame of mind for her to be in. But it is possible to inoculate her mind against such thoughts. You can create the illusion in her mind that you are just leaving anyway. She should always have this feeling like you are about to leave.

One way of creating this impression is to use *false time constraints*. This technique was first popularized by Style. A few examples:

- * "You know what...if I didn't have to go right now—which I do...I would..."
- * "I can only stay a sec, I'm here with friends, so check this out..."
- * "I've only got a minute, so I've got to tell you about..."

After you deliver the first few words of your opener, use a false time constraint. Then once you reach the Hook Point, try delivering *another false* time constraint. Why? Because the set has now decided that they want you to stay. A false time constraint at this moment will create a *fear of loss*. Thus begins the cycle of baiting the target to chase.

Body Rocking

Body rocking is the use of physical movement to create the impression that you are just leaving. In other words, it's a non-verbal false time constraint.

This is one of those tilings that can be difficult to describe in text, but easy to teach in seminar. Suffice to say that if the set continually feels like you are about to leave, based purely on your body language, then you are probably doing it **right**

It's not good to have a lot of extra motion while you are in set. Some beginners have a problem **with** bouncing around or fidgeting while in set. Beware: usually this sort of motion is unconscious, and is an expression of nervous energy. Without a **faithful** wing to point this out, you may not even realize you are doing it. Movement like this can wreck an otherwise perfectly good set.

The person who moves the least (i.e. the person who reacts the least) will often be perceived as the one with more social status. If you are not moving for a calculated reason, such as for performing body rocking, then it is better to stay in one spot with comfortable body language. *Avoid fidgeting at all costs.*

How to Open Seated Sets

Upon first opening a seated set, everything seems fine. The venusian artist stands near the set running material that is apparently well-received. But as time passes, he begins to lose their attention. Where did he go wrong?

In standing, while the rest of the set is seated, he has less physical comfort than they do. This betrays a subtext that the set is more important to him than he is to them. Thus, as time passes they will perceive him as having lower and lower value. A high-value male doesn't put himself in uncomfortable situations so that he can seek rapport with others.

The problem is, you cannot simply approach a seated set and join them at their table. To do so would be *try-hard*. So what is a field-tested method for opening a seated set?

- 1) Open the set **with** an *opinion opener* (as you would for a standing set.)
- 2) Part of the way into the opener, use a *false time constraint*
- 3) Continue the opener as you grab a chair and sit down with the set.
It's important to be talking at the same time that you sit down.
- 4) Run another false time constraint and then go into another routine.
- 5) Continue the set as normal.

Keep in mind that simply knowing the steps is not enough. It takes repetitive practice in the field to tighten up your calibration. *Often **it isn't** the techniques themselves, but the natural manner in which they are executed that gets the results.*

Alternate wording for the '*Jealous Girlfriend*' Opener:

Style: Hey guys, let me get your opinion on something. I'm trying to give my friend over there advice, but we're just a bunch of guys and not qualified to comment on these matters.

Girls: What?

Style: Okay, I've only got a sec. See *Wing* over there? Well, he has been dating a girl for three months. And she just moved in with him. Now, this is a two part question. So, imagine you've been dating someone for three months. And he is still friends with his old girlfriend from college. How do you feel about that?

Girls: blah blah blah are they just friends blah blah blah

Style: Yes, they're *just* friends. There's nothing else going on. They talk like once a week at most.

Girls: I think its fine / I don't think they should be talking /whatever

(At this point, Style has been body rocking out of the set. Now he rocks back in to continue the opener.)

Style: Okay, now let's say that he has a drawer in his apartment. And in that drawer he keeps all of his old photographs and letters. Now, some of those letters happen to be from ex's and some of the photographs happen to be with ex's.

Girls: blah blah blah concerned comment blah blah question

Style: It's not like he ever looks at them. They are just there, like old souvenirs and memories of his past.

Girls: I think its fine / I think he should put them away in a closet / He should destroy them / whatever

Style: Okay, the reason I'm asking is because *Wing's* girlfriend says she doesn't want him to talk to his ex from college at all. She wants him to cut it off completely. And she wants him to destroy all of his old photos and letters from ex's. She says it's just holding onto the past, and he should let go of it now. Personally, I thought it was extreme and a bit insecure. But what do I know. I'm a guy. And, as we all know, guys think differently from girls...

The 'Two Girls Fighting Outside' Opener

Mystery: Oh my god did you guys see that girl fight outside?

Girls: (whatever - **Cut them off after they talk for a bit**)

Mystery: They were totally fighting over this funny guy. Have you guys ever fought over a guy?"

Girls: (whatever - **Cut them off**)

Mystery: It was a short little guy named George. Sort of **white** trash, in a wife beater.. .These girls were pulling each others hair.. .one was pounding the others head into the ground.. .One of her boobs popped out___Normally I'm all for seeing boobs, but this was a gross, **white-trash boob.**"

(Make a grossed-out facial expression and transition to your next routine.)

How to Open Moving Sets

Some girls are walking through the venue. Is your game strong enough to stop them with your opener?

It is extremely **difficult** to consistently open moving sets. The most important principle to remember is that the girls should never perceive that you are chasing after them. If they do, then you will come across as having lower value, and they will leave. One way to avoid this is to remain firmly rooted to the ground when opening.

Alternately, consider that *an object in motion tends to remain in motion*. Here is the Mystery Method technique for opening moving sets:

- 1) You must be walking along the same trajectory as the set, *slightly in front of them*.
- 2) Turn your head back towards the set and run an opener.
- 3) Continue walking beside the set, and continue gaming the set as normal.

What most people do wrong when approaching

by Style

When I went out the first night on Mystery's workshop, I tried an experiment. I approached a set, opened, and then DHV'd. [*Demonstration of higher value.*] And not a *single* set stuck. I didn't reach the hook point. Everything seemed sort of flat, until I finally just excused myself.

This happened because I had dropped two important pieces out of my game. If you know what they are already, then you are obviously already successful in the field.

The next day, I did the exact same thing, except I added *Negs* and *Time Constraints* to the approach. Everything flew open. I was pulling girls off of guys left and right.

So, if you are approaching, but not having success getting *in* with the set, go out tonight and add negs and time constraints to the first three minutes of your approach. It makes a huge difference.

For those who don't have this material, here's an example:

TIME CONSTRAINT: I can only stay for a minute, because I have to rejoin my friends over there.

NEG: Oh my God, is she always like that? How do you roll with her?

And, a third point, which I've made often. In order for an approach to work in a bar or club, you must enter the set with an energy/fun level *equal to or slightly greater* than its current energy level. If you walk in not smiling, talking softly, and with bad body language, you're going to get blown out, no matter what you say right.

Hope this helps some people...

Style

Chapter Four Review

- AI begins when you run an opener.
- AI is complete when you reach the *Social Hook Point*. This is the moment when the set ceases to wonder when you will leave, and instead hopes that you will stay.
- The *meeting location* is a *target rich* environment where the venusian artist visits in order to practice his game. This is also known as a *field*.
- Women will often use *proximity* to signal their receptiveness to an approach. They may not be consciously aware that they are doing this.
- Although *proximity* and other *approach invitations* are opportunities to be capitalized on, a skilled pickup-artist can consistently open sets without waiting for these signals.
- The *3-Second Rule* states that upon entering the field, you must open a set within three seconds. Also, if you are later not in a set, and you see one, you must open it within three seconds. Following this rule will give you more *Social Proof*, which affects how people respond to you.
- You can create negative social proof with certain behaviors. Such as: standing against the wall with your drink against your chest, standing in a group of guys, circling the venue in a predatory fashion, looking around the venue with a serious expression on your face, etc.
- Don't try to look 'cool' or 'tough'. It's better to be comfortable and friendly.
- Don't drink.
- It's normal to need two or three *warm-up approaches* at the beginning of the night.
- Try to approach sets that have men, and practice gaming them as well. *Women have a 'leader of men' attraction switch*.
- Women have various *Protection Shield Strategies*, which they use to screen out men. But a venusian artist can coax a woman into **lowering** her shield by *conveying disinterest* while **demonstrating** value.
- The Mystery Method makes use of *canned material*, which can generate consistent responses. You should create a *routine stack* in order to practice this skill.
- The natural delivery of the material, including body language, facial expressions, and vocal tonality, is more important than the content itself.
- The Mystery Method makes use of *indirect openers* because they do not telegraph interest, and are proven in the field to open consistently. Other types of openers can also be quite effective, such as direct openers. Experiment and field-test your ideas.
- The use of new material in the field can feel clumsy and *incongruent*. Only through a couple days of in-field practice can the new material become naturalized.
- An opener must have a *root*, which is anything that gives it situational relevance.
- A *false time constraint* allows the venusian artist to create the illusion that he is just leaving. This is a powerful tool for opening consistently.
- *Body rocking* is the use of body language to deliver a false time constraint.
- When opening a seated set, it is important to sit with them soon after starting the opener. *Use a false-time constraint and then continue talking as you sit down*.
- When opening a moving set, it is important that they not perceive you as chasing after them in any way.

A2: Female-to-Male Interest

Demonstrating value, Indicators of interest, and Group Theory

Now that the set is open, it's time to create attraction. First, you must pick a target **from** the set. Maybe there are several pretty girls and your decision is somewhat arbitrary, but you still must choose one so that you can *neg* her.

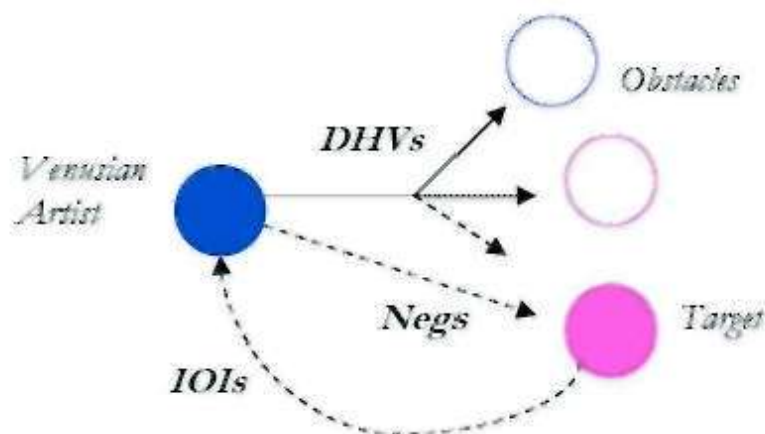

As you *demonstrate higher value (DHV)* to the set, and *neg* the target, attraction is created. She will respond with *indicators of interest (IOIs)*, which will help you to gauge your progress. This is the essence of the A2 phase.

Indicators of Interest (IOIs)

When a girl becomes attracted to someone, she will begin to give *indicators of interest*. These can be fairly easy to spot, and are useful as a gauge of her internal state. Although sometimes the girl is deliberately trying to give you a hint, many times when she gives IOIs, she is not even consciously aware of what she is doing.

It is useful to note that we often give IOIs unconsciously as well. But with practice, we become desensitized to the presence of beautiful women, and avoid this problem.

Here are some *IOI's*. Notice that some of these require more attraction than others. For example, she might be attracted enough to ask you your name, but not enough to leave the venue with you and bounce.

- She reinitiates conversation when you stop talking
- She giggles
- She touches you
- She looks back and glances at you repeatedly every minute or so
- She tosses her hair (to see if you will look)
- If eye contact happens from a distance, she holds it for a second
- She smiles at you
- She stands nearby (proximity)
- She interrupts your conversation from nearby, or laughs at something you said
- While walking by, she turns her body towards you or brushes against you
- She says something to her friend then they both giggle
- She asks you for a light, or the time, or in any way initiates a conversation
- While you're talking to her group, she is particularly talkative (to get your attention)
- She asks you for your name
- She asks you your age [make her guess]
- She compliments you
- She is playful and tries to challenge you
- She's disagreeing but laughing
- She's punching your arm but laughing
- She uses nicknames for you
- She plays with her hair while talking to you
- When sitting next to you her leg touches yours
- She repeatedly touches you in any way
- She asks if you have a girlfriend
- She mentions your girlfriend without knowing if you actually have one
- When she has to go to the bathroom, she comes back
- She holds eye contact when she speaks with you for longer periods of time
- She avoids mentioning her boyfriend
- If it comes up that you like something, she mentions that she likes it too or needs someone to show her how
- When she says or does something, she looks at you to see your reaction
- She looks at you from the side, to hide the fact that she's looking
- She introduces you to friends
- She buys you a drink
- She calls you a player or a heartbreaker
- On her way out, she re-approaches to tell you that she is leaving [get her number]
- On your way out, she asks you where you are going [invite her]
- She returns your calls
- She invents reasons to be near you, interact with you, or have isolation with you

The most important IOIs are:

- *She laughs while talking to you*
- *She reinitiates conversation when you stop talking*
- *She touches you*
- *She tries to get rapport and build comfort with you*

Sometimes an IOI isn't when she *does* something, but rather when she *doesn't do* something. These are called *Passive IOIs*. Passive IOIs are very important because often they are the only IOIs you will get. Here are a few examples:

- Her friend goes to the bathroom, but she stays
- Her friends go to the bar, or the dance floor — but she stays
- She waits for you if you go to the bathroom
- She doesn't flinch or pull back if you happen to move too close
- She doesn't resist when you escalate physically (or she gives token resistance to avoid feeling like a slut.)

Fake IOIs

Be warned that girls will occasionally use IOIs to 'lie' to you. For example, a girl might give you IOIs while she is asking you to buy her a drink. She's not attracted to you, but merely manipulating you. And of course, if you are easily manipulated, she will find you less attractive. She might give you IOIs just to keep you around as free entertainment.

A girl might give you IOIs when she is ditching you. For example, when she says "We have to go to the bathroom now," some tiny part of her knows that she is really ditching you, so she might touch you on the arm as she says good-bye, to give you some validation.

A girl will also give IOIs sometimes just to see if she can get you to return them. If you return her IOIs too easily, without making her work for it, you have just become another notch on her belt. Don't jump on her and start humping her leg like a horny little puppy dog.

Indicators of Disinterest (IODs)

Similarly, there are *Indicators of Disinterest*, also known as IODs. Here are a few examples of these:

- Avoidance- She avoids eye contact. She avoids your calls. She avoids you in general. She walks away or looks away. She leans away, turns her back, or talks to someone else.
- If she can pretend that she didn't hear what you just said, she will. She is non-responsive, or she repetitively says "uh-huh" instead of giving you a real response.
- She won't contribute to the conversation. She won't move with you, even two feet away. She won't invest.
- She gets impatient easily.

Practicing A1 mid A2 will give you the skill set to turn those IODs into IOIs. The answer is not to tell her that she is hot, or offer to buy her a drink, or be really persistent, or ask her lots of questions. Instead, practice A1 — being indirect and not-needy, and practice A2 — negging and demonstrating higher value. Voila! IOIs.

For those who have seen the movie *The Tao of Steve*, A1 and A2 happen to correspond to the first two rules in the movie: *be desire/ess*, and *be excellent*. And speaking of being excellent, here is an excellent DHV:

Name Mnemonics

By Style

Girl: What's your name?

Style: I'm Style.

Girl: I'm Janet. This is Donna. And that's Tony.

Style: Okay...Janet, Donna, Tony. You know, I used to be really bad with names.

Girls: Omigod, I'm so bad with names.

Style: But you don't have to be anymore. Here, I'll show you in two seconds. All I do when I'm introduced to you is make a picture in my head. So if you're Janet, I picture you with the head of Janet from Three's Company. No offense. And for Donna, I just picture like the dawn, and the sun rising over your head. And for Tony, I see you on the front of a box of Frosted Flakes. Now I'll never forget your names.

Neg Theory

[From Mystery's Lounge — Mystery's classic Neg Theory article.]

A hot girl is there, surrounded by her friends. She has put on this *bitch* act. But is she really a bitch? Unlikely. All my girlfriends were wonderful human beings. Beautiful people have it easier because they are beautiful and often times have better upbringings because of it.

But - she needs to have a standard when all these loser guys approach her. So her values are very honed and understood. When a man walks up and says, "Can I buy you a beer" this *will* annoy her. While the guy thinks he's doing something nice for her, she gets this constantly and is desensitized to it. You are the eighth guy today!

So she is very good at brushing all these guys off. She *has* to be... she isn't going to sleep with all of them! So she may say 'no,' act annoyed, or use some other shielding mechanism, and then the poor guy thinks she's a bitch and he walks off angry and feeling like a failure. And that seems to work. Sometimes when the girl is particularly feeling powerful (like when she's in a club) she will accept the beer and then flake the guy off. Hey, the guys are stupid enough to buy her one; she might as well take it.

When she accepts a beer from you, the girl is really saying, "I don't know you and I don't care about you. You are just another one of those typical guys and since I don't respect you, I'll take the beer from you before I snub you."

Since hot girls are so good at snubbing your approach, snubbing *them* is important. You cannot *insult* them, because they are accustomed to all the hurt guys insulting them ("You are nothing but a bitch!") so this rolls off their back like water off a muskrats ass.

How do you snub them without *insulting* them? Well, let's say she has long nails, which are most likely

fake. Now why do women dress so *fine* if they don't want the attention? Sometimes they *love* the feeling of control. They are in a club with friends and they want to be the leader of their social circle and get all the attention. The guys come and buy drinks for them and she gets a kick out of knocking the guys down. It's all in a days play. So, she is wearing fake nails to look even *better!* Most guys will say, "Wow you are so beautiful!" *Boring*, typical and in her mind by now, **true** (after years of this.)

Imagine now, a guy comes along and says "Nice nails. Are they real?" She will have to concede, "No, acrylic." And he says (like he didn't notice it was a put down), "Oh. (pause) well I guess they still *look* good." Then he turns his back to her.

What does this do to her? Well, he didn't treat her like shit and *insult* her. Instead, he complimented her, but the result was to target her insecurity. She thinks, "I'm hot I'm beautiful" - (especially in her current emotional state of control) - "but I didn't win this guy over. *I'm so good at this...* I'll just fix that little smear on my image that he has of me."

Then you continue to show disinterest in her looks as you give her a neutral topic like the Elvis bit. During this time, her intention is to get you to become like all the other guys so she can feel in control and snub you. Then you give her another **Neg** like this: "Is that a hair piece? Well, it's neat... what do you call this hairstyle? The waffle?" Smile and look at her to show her you are sincerely being funny and not insulting. You are pleasant but disinterested in her beauty. This will intrigue her because she *knows* guys. And this isn't normal. You must have really high taste, or be used to girls, or be married or something. These questions make her *curious*. So this keeps happening and is known as *flirting*. She gives you little negs and these tests are qualifiers. You pass them by negging her back. After all, you aren't like the others showing interest. But... why not?

To get control again, she says, "Will you buy me a drink?" Notice how she is trying to get you now! But, she only wants to sucker you in enough so she can snub you. That is all she is about - this strategy is all she knows and it's not working on you so she is trying to do damage control on the situation. But at the same time she doesn't quite understand *why* you don't think she's "all that." After all, her nails are fake.

You say, "Ah, that's so funny ... your nose wiggles when you speak ..." - (pointing and being cute) - "look there it goes again ... it's so ... quaint ... hheeee look." She'll say, "Ann, stoppp!" :) *blush*. Now she is self-conscious and this is where you want her. You have, with three negs, successfully created interest (curiosity) and removed her from her pedestal (removed her protection shield.) You were humorous, you had a smile, you dress well, you are confident and everything she would want in a man.

You didn't take her shit. Oh... and when she asked you for a beer, you said, "No. I don't buy girls drinks. But you can buy *me* one." You are qualifying *her* now. If she buys you a beer, this is symbolic of her *respect* for you.

If not, you say, "Pleasure meeting you" [*not sarcastically*] and turn your back to her again. Don't walk away, just turn your back. You are negging her again just when she thought she was negging you. You are teasing each other. It's flirting - this is all textbook psychology.

A **neg** is a qualifier. The girl is failing to meet your high expectations. It's not an insult, just a judgment call on your part. You're not even trying to make her feel bad (so it seems.) It's the same as if you pulled out a tissue and blew your nose. There's nothing insulting about blowing your nose. You haven't explicitly rejected her. But at the same time, she will sincerely believe that you aren't trying to impress her. This creates curiosity and makes you a challenge.

The better looking the girl, the more aggressive you must be with using negs. A 10 can get three negs up front, while an 8 gets only one or two over a longer time. You *can* go overboard if she thinks you are better than her (which happens more often than you'd think.) You can drop the self-esteem right out from under her, just like most 10s do to guys, and this isn't good. **You** have to get as close to the breaking point as you can without crossing the line. Once you have gotten her *right there*, you can start appreciating things about her (not her looks.) There is a mutual respect now - something most guys never get from the girl.

This is how you remove a protection shield. Three negs ought to do it within two of three minutes of neutral chat. Once it is removed, you can, from a place of mutual respect, seduce her.

Sample Negs

- YOU: "I don't think we should get to know each other."
HER: "Why not?"
YOU: "I think you are just too much of a *nice girl* for me."
- If your target says something even slightly rude you say, "You don't get out much do you?"
- If a girl isn't into anything active, use that as an opportunity to neg her by saying, "Get with the program. I'm into living *life*. Don't you care about staying fit? just cause you are thin doesn't mean you are toned you know. You have to consciously *plan* activities. That's it... I'm your success coach ... and we are going roller-blading (or rock climbing) this week."
- If your target interrupts you, say, "Hello, I'm talking, geez" or, "Excuse me... may I finish my sentence first?" You then say to others in the group, "Is she always like that?"
- If you are asking a question to two women and the target answers you say, "I didn't ask you. silly."

If you pull out your photos for the *photo routine*, first show them to the obstacle. When the target tries to see them, say, "Excuse me! I'm showing *her* the pictures not *you*. Wait your turn geez."

If a girl kisses you on the cheek and goes to kiss your other cheek, tell her, "Only one ... don't be greedy."

If she says, "Yes, but I'm French", you reply, "Are all French girls as greedy as you?"

"That's a nice hairstyle ... it that your real hair?"
Smile and look at her to show her you are sincerely being funny and not insulting.

HER: "Oh, I'm a model."

YOU: "What, like a hand model or something?"

"Ewww, your palms are sweaty ... ewwww!!!! Where have your hands *been*? No. don't tell me, I do *not* want to *know*!"

"You've got something in your ear."

YOU: "Ooh, check this out.... watch this. Here, pull my finger. This is good."

[Your target pulls your finger.]

YOU: [Make a fart sound with your lips.] "*Oh man!!!* You actually pulled my finger! haaa! No, no just kidding, here, really, pull on my ringer. No honest this is good trust me." [She pulls it - Fart sound again.] "*Oh man!!!* That's *TWICE!!!* I can't believe you! My *niece* is six and doesn't fall for that anymore! man haaa!"

You may decide to say, "I'm just kidding. Here *really*. I'll show you some magic. Look at this. My hand is empty right? Ok, really pull my finger. No really, I promise I won't fart again. Serious. I swear to you. Magician's honour! No, swear. I promise I won't." She pulls your finger. [Fart Sound.] "Oh my God you can get talked into *anything*!"

"I like that dress. I remember seeing you at a club before and you were wearing the same [dress.It is nice though.](#)" :-)

"My you come on strong. That isn't 'til later in the relationship."

"You need to wash that dress already!"

"Very good. That is a little test I do to see if you have any free thought of your own or just believe everything you hear."

"Wow. You really wrecked a moment! Your past boyfriends must have really hated that about you."

HER: "I'm a model."

YOU: "Do a lot of people ask you if you are a model?"

HER: "Yes, all the time."

YOU: "I think they were just being polite."

"I just noticed.. your nose moves when you speak... haaaa, it's so cute." (Pointing and being cute.) "Look there it goes again ... it's so ... quaint... heee looky"

YOU take a gum out and offer it to the target.

HER: "No thanks. I'm drinking beer."

YOU: "I know. Take the gum."

If She's Older

If your target says, "You are so young", this is an IOI. Don't excuse yourself for being young like chumps do — only someone trying to get the girl would do that. Simply reply cynically, "Yeah I noticed ... poor you." Remember to convey your playful teasing attitude.

"Take a quiet moment to get over this age thing. I'll wait."

Types of Negs

The first sort of neg is the *shotgun neg*, which is an innocuous statement that would only be uttered by a sincerely disinterested person. It's an *indicator of disinterest*. Of course, it's not that you *dislike* her; not at all. It's just that you hadn't considered her a potential romantic or sexual partner. This IOD diminishes her sexual power and disarms her peer group. The power of the shotgun neg is in its apparent *sincerity*. She'll honestly believe that you aren't trying to impress her. *Then she wonders why...*

The simplest example of this is pulling out a tissue and blowing your nose. She'll sincerely believe that you aren't trying to impress her; (otherwise you would never blow your nose in front of her.) It won't even occur to her that it's really just a ruse. Shotgun negs are useful for conveying a *not-needy* attitude — which is a demonstration of higher value. Thus in one stroke you indicate disinterest, disarm obstacles, and create attraction. "*Nice nails, are they real?*"

Contrast this with the *tease neg*. Teasing conveys a *cocky, playful* attitude. It's not perceived as inadvertent, but rather as deliberate flirting (but done properly.) Examples of this are "*pull my finger,*" "*You can dress her up, but you can't take her anywhere,*" "*Don't make me come down there,*" etc.

When you call her a dork, your *cocky, playful, fun attitude* shows confidence, takes charge, and makes tilings fun. Teasing stimulates her emotions and is useful as a DHV during A2. She may *non-respond (IOD)* to this tactic if she is trying to freeze you out.

Another form of neg is the *sniper neg*. An example of this is hinting to her that she has a booger, eye crusties, a sweat} palm, or that she just spit on you. The idea is to make her honestly believe that she has performed a *demonstration of lower value (DLV)*. This makes her self-conscious and creates a situation where *she is* the one wondering whether or not you have a good impression of her.

You can follow this up by looking away, or dropping the conversation for a moment, or some other IOD. Why? *Her embarrassment makes her vulnerable*. By indicating even a slight disinterest using subtleties in your body language, you can create in her a powerful desire to win approval and validation. After using a sniper neg, try a *compliance test* such as a kiss or some other escalation, and notice how much easier it is to get compliance.

- Is that a wig? Oh...well it looks nice anyway.
- I think your hair would look better [up / down].
- What do you call that hairstyle, the waffle? *smile'

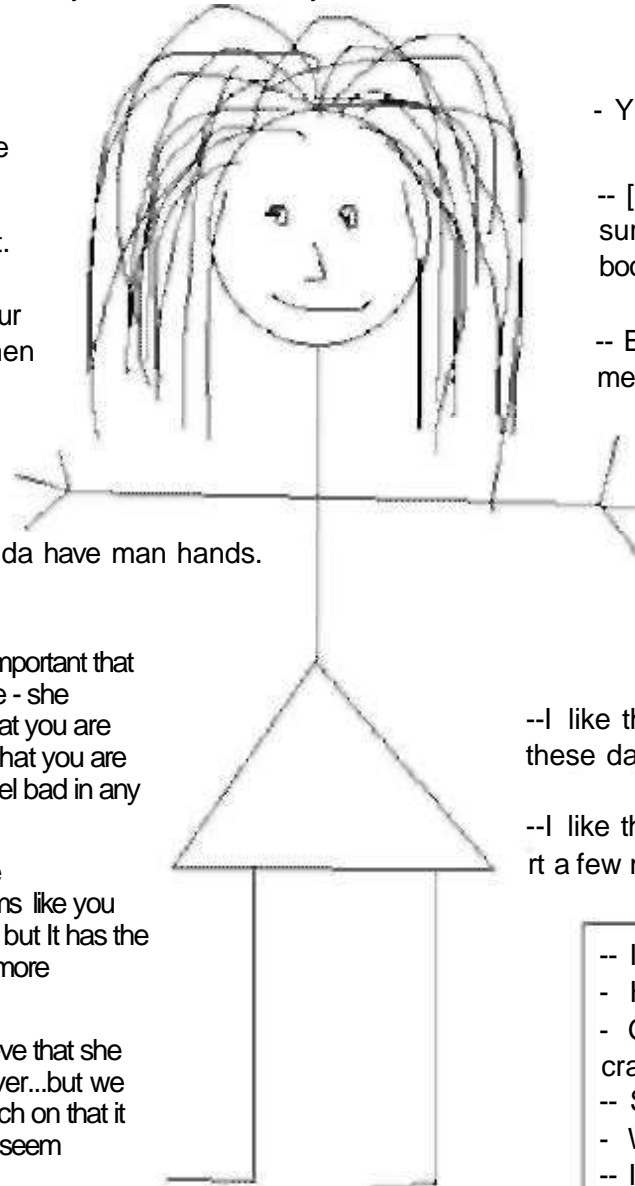

- You have eye crusties.
- You blink a lot.
- How cute! Your nose wiggles when you talk!

- You talk a lot.
- [Motion to her nose as if you are surreptitiously warning her that a booger is dangling from it.]
- Eww, you spit on me!

You kinda have man hands.

Nice nails...are they real?
Oh...well they look nice anyway.

When negging, it's important that you come off sincere - she shouldn't perceive that you are reaction-seeking or that you are trying to make her feel bad in any way.

Many negs resemble compliments. It seems like you are trying to be nice but it has the result of making her more self-conscious.

We want her to believe that she hasn't yet won us over...but we don't want her to catch on that it is deliberate. It must seem inadvertent.

--I like that skirt. Those are really popular these days.

--I like that skirt. I just saw a girl wearing it a few minutes ago.

- Is she always like this?
- How do you guys hang with this girl?
- Geez, you must have driven your parents crazy.
- Solipsistic ego queen!
- Where's your off button?
- I can already tell, you and I are NOT gonna get along.

Those shoes look really comfortable.

- 1 know you like I know a hole in the wall. Here's you. Here's a hole in the wall. Same thing.
- I'm not boyfriend material You need a guy who will buy you flowers and be really nice to you. That guy over there looks perfect for you.
- (Loudly) Lady, I'm not going to make out with you!

- Hello, I'm talking, geez.
- Hello, it's private, geez.
- Excuse me I'm showing HER the pictures not YOU geez.
- Excuse me, may I finish my sentence?
- Eww your palms are sweaty.
- You have some lint on your shirt.
- Uh, it's TOO EARLY in our relationship for you to be (whatever she's doing.)

- Is that your natural color? (yes) Huh...well it's not bad. (no) So you changed it to that?
- You remind me of my Aunt Minnie.
- You remind me of that movie star....Woody Allen
- You sort of remind me of that TV star.. Tori Spelling.
- I like your look. Beauty is common, but you seem like you have more character.

Demonstration of Higher Value (DHV)

Anything you can do that conveys higher survival and replication value is a *DHV*. For example, if you open a set and you already have two girls with you, you have demonstrated pre-selection, which is a DHV. When girls see that other girls have pre-selected you, they feel more attracted to you as a result.

If a woman discovers that you have a lot of money, it is a DHV. She will find you more attractive, all other factors being the same. But if she perceives that you are *trying to impress her* with your money, she will then *lose* attraction. This is because only lower-value people try to impress — such behavior is known as a *demonstration of LOWER value, or DLV*. If you are trying to impress, you must be of lower status and thus unattractive.

If a woman sees that you have a lot of social proof from gaming the room, *she will feel more attracted to you*, because social proof is a DHV. If, however, she sees that you are socially unaware and inept, then it is a *DLV*. When you DLV, it lowers her perception of your S and R value, which makes her feel emotionally less attracted.

Telling stories that are fun, interesting, and emotionally relevant, demonstrates social skill, which is a DHV. A story can also be structured to convey specific characteristics in the *subtext*, allowing you to surreptitiously flip attraction switches.

Negging is also a DHV, because only a high value guy would talk to her like that, and seem sincere. You must already have girls if you talk in such a way.

Some DHVs:

- o Pre-selection from other women
- o Leader of men
- o Supporter and protector of those close to you
- o Being not-needy
- o Being unaffected
- o Social intelligence
- o Negging her (*This IOD is a DHV also.*)
- o Having a strong frame
- o Being interesting and fun
- o Humor and other emotional stimulation.
- o Being socially "in demand" — other people are seeking your attention or validation; (alternately *they* are paying attention to what *you* are saying.)
- o Connecting conversationally

Group Theory

Women of quality tend to be found in groups; they are rarely if ever alone. When girls get together, they engage in a *group-think* mentality. This groupthink is due to the same psychological mechanism that causes pre — selection — girls look to each other to validate their choices and feelings. They will touch each other, hold hands, whisper tilings, move around the venue together, go to the bathroom together, rescue each other from aggressive guys or nice guy losers, and generally take care of each other.

Often the nice guy waits for the girl to leave her group so that he can catch her alone and hit on her. But in the Mystery Method, we approach the group itself. Women tend to be attracted to the highest value man in their social context. *Could it be possible to take over her group and become the highest-value man in it?*

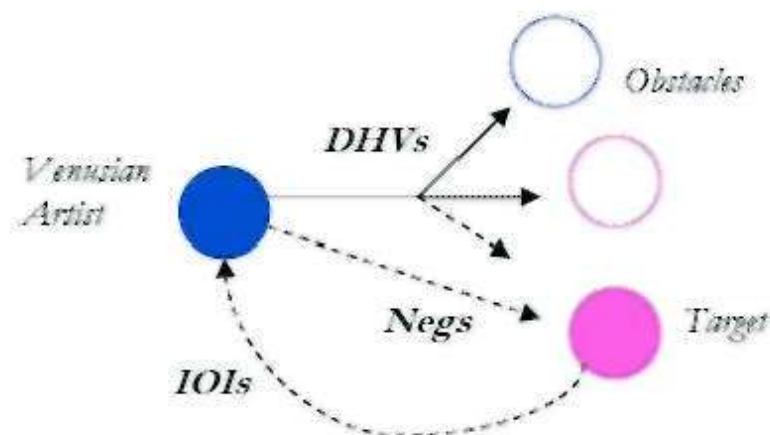

Once the set is open, you disarm the friends with stories, humor and other DHVs. You're interesting, fun, and emotionally relevant. In fact you even steal the spotlight away from the hottie (who is the target.)

You further disarm the friends by negging the target. All those other predatory guys tried to open by giving her IOIs and offering to buy her a drink — they are so transparent. But you negged her, turned your back, and continued telling your story. The friends don't perceive any threat — they're *disarmed*. But unbeknownst to them, the negs have introduced a sexual tension between you and the target.

Because her friends love you, her group think mentality now works in your favor. You have the social proof of her peer group. Her self-esteem is a little lowered from the negs, and she wants some more attention from you, the life of the party — the gay who sort-of pushed her out of the spotlight of her own circle of friends. She begins to give you IOIs, and she begins to work for your approval and validation. If you can consistently create reactions like this, you have mastered A2.

Basic group theory operates on a combination of two DHVs:

- 1) The Social Proof that is generated by taking over the group. Personality traits are also demonstrated to the group, and thus obliquely to the target.
- 2) The ability of the neg not only to convey higher value, but also to simultaneously disarm the obstacles, remove the target's sexual power, and motivate her to chase after you to get it back.

What are some interesting things to talk about in set?

- Talk about ESP and its impossibility
- Talk about how you met a bear while hiking
- Talk about how you were scared shitless rock climbing when your rope snapped
- Or the time you accompanied your friend to visit a girl and your buddy was almost beaten to death when the girl he visited had a boyfriend who came out and there was a twenty minute car chase through lights and you were looking for the cops but lost the crazed boyfriend before you found cops
- Or the time you were in the hospital and it changed the way food tastes
- The way birds sound clearer now
- Or the time you hacked into a bank but chickened out and put the money into a charity
- The time you lived with four girls and when they all had PMS there was a giant food fight
- Or talk about the famous person you met
- Does she believe in ghosts? Why?
- You like candles and incense. what does *she* like?
- The ant farm you bought for your niece and what you learned from the experience
- Talk about the time you were on stage.
- Talk about the time you bladed down a steep hill and survived

Multiple Conversational Threads

During a conversation, especially between people who are already acquainted with one another, various conversational threads will come up. We might talk about the weather, our families, what we did last night, various philosophical topics or current events, etc.. .as the conversation progresses, certain threads may be revisited or come up periodically.

But people who are not as well-acquainted often find comfort in a thread that has situational relevance, and end up stuck on that one thread until it eventually peters out. Imagine a guy is walking his dog in the park, and he meets a woman who is doing the same. They strike up a conversation:

Man: "Oh hello, is that a cocker spaniel?"

Woman: "No actually, he's a mutt. I got him from the pound a few years ago. How about yours?"

Man: "She's a black lab. I suppose they are getting on rather well then, aren't they?"

Woman: "Yes, yes they are, dogs are funny.

Man: "So have you had him for long.-"

Woman: "Oh I don't know, about three years."

Man: "So.. .so what sort of dog food do you feed him?"

Notice how the man is grasping for straws now? He was successfully interacting with the woman on this dog thread, but he couldn't think of another thread with situational relevance in order to continue the conversation. So he went back to the dog thread again and it started to become rather obvious that the conversation with the woman is important to him — he "doesn't want to screw this up." This is especially telegraphed by his over-use of questions during conversation.

By betraying the woman's importance to him, the man lowers his value in her eyes. She will find him less attractive and will behave accordingly. If he gets a lot of girls, he won't care if things work out with her. But he cares — therefore he must not get many girls. Therefore he must be a low-value guy. His DLV has sunk the set.

People who are well-acquainted with one another tend to use multiple conversational threads while talking, whereas people who aren't as well-acquainted can get stuck on a single thread, followed by a polite end to the conversation.

By introducing multiple conversational threads into your set, you can create a strong feeling of familiarity in the set, as if you are already all old friends.

In the early part of a set, when you haven't yet demonstrated much value, girls won't be eager to contribute much effort to continue the set. You must be able to contribute ninety percent of the conversation or it will die.

Over time as attraction is created, you can then use this attraction to bait the girl into more participation and investment. But even then you must be leading the interaction and keeping her stimulated. Thus it's extremely important that you be able to *talk talk talk*. Learn to always have something to talk about. Get into a talkative mood and practice talking to everyone, not just hot girls. Introduce several different routines and jump back and forth between them instead of running them linearly.

Notice how logistical problems seem to disappear when you keep the target's conscious mind occupied with your conversational threads. You've always got a thread to go back to. Whereas your set can sour quickly when there are too many uncomfortable pauses, or if it suddenly appears like you are grasping at straws to keep the interaction alive.

The Elvis Bit

"Oh, oh, get this! Did you know ... that Elvis Presley died his hair black? Guess what his real hair color was? Really, guess. No!!!! It was dirty blond! Isn't that weird?"

Cutting Threads

Sometimes a thread is not useful. A girl may start talking about something that makes her feel bored, or feel sad, or think about her boyfriend, etc. For whatever reason, it is more useful to you to cut the thread than it would be to continue talking about it. When this happens, simply *CUT the thread*.

Her: "Yeah so every time I hear about that team being in the playoffs, it makes me think of him."

You: "Let me see your hands." [Begin the *Kino Test*]

Just completely cut her thread and replace it with a new thread of your own. Of course this doesn't mean that you need to become Mister Interrupting Guy who is constantly interrupting or refusing to address the issue. Just recognize that when it is useful to you, you can cut a thread, introduce a new thread to replace it, and *this tactic will work*. In fact, not only will it work, but she will find you more attractive as a result, since it demonstrates that you have a *strong frame*.

Sometimes it can happen that one of your *own* threads is not useful anymore. For example, if one of her friends has just joined the set in the middle of your thread, this can be awkward. If you finish the story, the friend will be bored because she has no idea **what** you're talking about. But if you start over from the beginning, now the target is bored because she has already heard this before; and by the time you get to the end it has become anticlimactic.

Just cut your own thread and introduce a new one:

You: "...So I'm halfway back to the house, and there's only three minutes left, and I notice the can is starting to leak ..."

[Her friend arrives and the girls immediately face each other and start signaling each other.]

You: "Introduce me to your friend; it's the polite thing to do."

[Introductions occur. As you shake her hand, neg the target]

You: *[new thread addressed to the friend]* "So tell me, do you believe in spells? Get this, *[spells routine]*"

Oh, and don't try to go back to your **original** thread later. It's try-hard.

Often if you do not lead the conversation by actively cutting bad threads and introducing good threads, and if you instead delegate this responsibility to the girl, then she will allow the conversation to get boring and then she will blame you and think of you as a boring guy. So do it right and make it happen, because *she won't*.

"So how do you all know each other?"

The line "So how do you all know each other?" is a rather crucial one. (If the set is a boy/girl two-set, try asking "So how long have you guys been together?") Because this question is a piece that must occur in *every* set, it is said to be a *waypoint* in the game.

It's a harmless, reasonable, sociable question. It generates conversation *and* provides the venusian artist with oodles of useful information. For example, if the set consists of two girls, and you ask, "So how do you guys know each other?" It's possible that one of them will say, "Oh, she's my boyfriend's sister."

The important information isn't the existence of a boyfriend. If your game is tight, girls will cheat on their boyfriends at the drop of a hat. **Rather**, the important information is that she is probably not going to cheat on her boyfriend in front of his sister, who is standing right here.

"So how do you all know each other?" might also reveal that the group consists of co-workers, or that the guy you thought was a threat was actually your target's brother. (Lucky you were doing Mystery Method and befriended him in the first place.)

Throw negs like pebbles

As you weave the multiple threads of your conversation, occasionally the time will come to pop out a neg. When this happens, it's important that your target doesn't see you watching for her reaction. If you are trying to get a reaction out of her, *she won't perceive the neg as genuine and inadvertant, and thus it won't work*. Furthermore, reaction-seeking behavior is a DLV. And why would you want to do that?

So toss your neg like a pebble. Before it reaches its destination, you have already turned your head and continued the conversation. As far as she can tell, it's not something that you're still thinking about, or gave much thought to in the first place.

The Spells Routine
By Style

Hey guys, I want to get your opinion on something.

Do you think spells work?

I know, it's a strange question. But I have a reason for asking. Let me just get your opinions then I'll tell you.

Our friend, he's not out with us tonight, because he's with this girl...

We met her at a party last weekend, and she said she's a witch. So...they ended up going home together, and made out, but nothing more happened and he passed out on the couch. He said she wasn't really his type after all.

When he woke up, he found this tiny scroll of parchment tied with a leather string with a feather stuck in it. There were weird markings inside.

So we happened to be down at this esoteric shop the next day, cause I like to get candles, and we asked the proprietor what he thinks of this little scroll. You know, this is one of those guys with tattoos all over his face and stuff.

Anyway, he says, "Oh that's a love spell."

So the strangest thing is, ever since then, I never see my friend anymore. He's always hanging out with this girl, twenty-four seven. He says he's in love with her. So do you think it's magic or just psychology?

Winging

The Wing Rules

- 1) He **who opens the set, OWNS the set**. He gets first choice of target.
- 2) **The primary purpose of the wing is to help the player get his target**. If the wing can also game up his own target from the group, fine. But that is not his first priority.
- 3) **Don't ever steal the target**. Sometimes the player is ignoring or negging his target while working the group. It would be really easy to go into his set at this point and give attention to the target — don't do it!
- 4) **The wing should occupy the obstacles** so that the player gets more time one-on-one with his target.
- 5) **Always agree with your wing**. Never take the girls' side over him. He is always right.
- 6) **Your wing is a great guy, a cool guy**. That is why you hang out with him. After all, you have high standards.
- 7) **Your wing's feelings are important to you, even more important than the girl's feelings**. If he approaches your set, you will turn to face him. (Girls do the same with their friends.) If you disrespect your wing, it will lower *your* value to the girls! Never leave him standing around without acknowledging and/or introducing him.

Entering a Set as a Wing - Style's Method

The "Were you guys just talking about..." method

- The Player has opened a set and has had enough time to pass the social hook point. The Wing approaches the Player.
- Player faces Wing and greets him.
- Player then says, "Hey guys, this is my friend Wing."
- Wing says, "Oh, were you guys just talking about..."
- Player says, "...Yeah when that girl cast a spell on Aaron..."

Conversation continues from this point. Wing is now in the set.

Entering a Set as a Wing - Standard Method by Toecutter

The "Have you seen Michelle?" method

- The Player has opened a set and has had enough time to pass the social hook point. The Wing approaches the Player.
- Player faces Wing and greets him.
- Wing says, "Hey man, have you seen Michelle?"
- Player says, "Nope, sorry* man."
- Wing says, "I'm going to go find her."
- Wing turns to leave and starts walking away.
- Player interrupts, grabs Wing's arm and pulls him back into set.

Notice that at this point, the player has the option NOT to pull the wing back into the set. It's the player's choice what happens here.

- Player says, "Hey wait man, you should meet these girls. These girls are pretty cool."
- Wing says, "Cool, how do you guys know Player?"
- Girls say, "We just met him, just now."
- Wing says, "Cool. Get this. Last weekend," [*Wing goes into routine*]

At some point soon the player is talking to one girl while the wing is talking to the other girl. Now they have split the set and can go into A3.

Entering a Set as a Wing - Mystery's Take

The Accomplishment Intro

- The Player has opened a set and has had enough time to pass the social hook point. The Wing approaches the Player.
- Player faces Wing and greets him.
- Player then says, "Hey guys, this is my friend Wing, he's..."
 - "...a good friend of mine,"
 - "...a local musician here in town, the band is really good,"
 - "...one of the smartest guys I know."
- Wing says, "Nice to meet you guys."

Conversation continues from this point. Wing is now in the set.

THE ACCOMPLISHMENT INTRO

"He's the guy who <fill in blank>."

Get your wing to introduce you by name *and* **accomplishment**

EG: Style says, "This is Mystery, Erik von Markovik, the guy who levitated over Niagara Falls. He was on the Roseanne Show."

And if I have my autograph book with me, this is who I am.

EG: Mystery says, "I'd like to introduce you to Anando. He's the guy they wrote about who hacked into the power-grid and turned California **off** for 6 hours.

EG: Mad Dash says, "This is Chris Powles. He's the guy who sucked off six hundred men in one hour. I was one of 'em."

This is the *Accomplishment Introduction*. What's funny is, if *you* talk about yourself, its tooting your own horn. But if your *wing* does it, the girls believe it. All you need is some minor proof. An article photocopied to sign for them, a comp card **with** your picture on it to leave with them.

You don't have **to be what** you *do*. You just have to convey an *accomplishment*. Make it bigger than life. And if you don't want to lie, make it *true*.

"This is Chuck. He's a broker." Boring.

"This is Bender. He's the lead singer of this awesome band called **Razor**. They just got on the charts." Respect.

What is your great accomplishment? (Real or imagined.) You can have more than one and enjoy flipping from one to another. Again, *you* can't toot your own horn but your *wing* can. Write your *accomplishment intro* for your wing to use. It only makes *him* appear cool too to be hanging **with** a man of said accomplishment.

What would you do with your life if you had no chance of **failure**? What is your dream? What do you honestly want to become? Think big be big.

It's a powerful dynamic when you and your wing can run stories about each other.

The Gandhi Bit

Did you know Gandhi was a lawyer?
Did you know he was **from** England?
Did you know he was hung like a horse?

*A hint for telling stories:
The shorter it is, the
earlier you can use it*

Storytelling

When you tell a story, it doesn't have to be explicitly impressive. In fact, it's better if it's not some amazing story; you don't want the target to think you're trying to impress her. As long as the story is fun, interesting, and most **importantly captures** the attention of her group, then it is fine. These sorts of stories are most congruent if they are somewhat true and based on events from your own life.

When it is possible to convey traits that will flip attraction switches, without making it obvious that you are doing so deliberately, it is a DHV and generates attraction. For example, in a story, it is possible to flip the *leader of men* attraction switch by congruently adding something like: "...so I told him I have no choice, it's my little sister. So he jumps in the car, cause you know my friends are there for me one-hundred percent, and I'm the same way for them, that's just how we are..." Similarly, *the preselection* switch and other switches can be flipped in this manner also.

Describe in terms of sensation and emotion

When telling stories, men tend to focus on the facts at hand, whereas women look for the sensation and emotion caused by the experience. Structure your language to take this into account. Example:

Bad: This guy grabbed my ass, can you believe that? I looked like an idiot.

Good: Then I felt a strong hand caress my ass and grip it tightly. I turned around, and there was this man **with** a handlebar mustache smiling suggestively at me. All the girls started laughing. I have never.. .felt so surprised.. .and embarrassed.. .in my entire life!

Notice how the above story segment conveys the emotions of surprise and embarrassment — both of **which** are useful during a story. Three or four story segments like this put together can lead the listener through a little emotional journey. With skilled delivery, this *is* a DHV, even if it doesn't reveal some value-raising factoid about your life.

Story Theory

by Wilder of Pick-Up 101

Telling stories to a group of people is one of the best ways to generate attraction in pick-up **when** done correctly.

What follows are several things to consider when choosing and crafting stories for use in the field **during** attraction phases. They're more guidelines than hard and fast rules, as YOU can break most of them when you know what you're doing.

1. **Story material.** This is close to a no-brainer. Choose stories that are interesting, fun and *girl relevant!* Usually these stories are **funny**. Use stories you tell often to friends and new people that get big laughs. Avoid stories about distasteful subjects such as death, car accidents, bad breakups, etc.
2. **Be succinct.** Write your story out word for word and then gut it. Get rid of everything the listener doesn't need to know and doesn't care about. It's essential that you're ruthless here. Better to cut too much than too little. State the boring but necessary details as succinctly as possible.
3. **Lead in.** This is how you start the story. The lead in should be **congruent** with the story to follow. Communicate — using words, tonality and energy — the type of story to follow. Some examples are, "Oh my God, the *funniest / craziest / weirdest* thing **happened** to me the other day!" or "Did you guys ever notice *whatever?*" or "You'll never believe this, check it out."
4. **Initial hook.** An initial hook is something that makes people's ears perk up. It should be as close to the **beginning** of the story as possible and should be specifically chosen to make people lean in and pay attention. If your story is about something that happened to you at an S & M party, put that part up front!

Bad: My friend called me the other day and left me a message to call him back. So I called him and he went on and on about his **Mother's** operation before **finally** telling me about this party he wanted to go to. Turns out, it's an S & M party!

Good: So the other day I went to this S & M party!

5. **Unanswered questions.** Craft your story so that there will be unanswered questions in the listener's mind. You want them to ask you questions that give you the **opportunity** to **further** increase your value.

Example: So I was picking up my new car the other day and the salesman wouldn't stop asking me about my watch. The girl I was with finally told him we had to go so she could pick up her instrument for a concert she was doing that night.

Unanswered questions:

- *What kind of car did you just buy?*
- *What kind of watch were you wearing?*
- *Are you rich?*
- *Who was the girl you were with?*
- *What kind of performance did she have to get to ?*

6. Allude, don't state directly. In the examples above you're alluding. You're alluding to the fact that you have money, as you just bought a new car and have a cool watch. You're alluding to the fact that you hang out with cool girls. Stated directly, any of this information would sound like bragging, so you allude to it. Make them ask you about it: don't volunteer it.
7. Convey personality traits. In telling a story, you're telling someone a great deal about yourself. Know what personality traits you want to convey. Craft your stories to subtly tell someone that you're adventurous, rich, famous, creative, courageous, etc. It shouldn't be discernable that you are conveying these traits deliberately.
8. Delivery. Telling is hard to put in print, but vary your tonality as widely as possible. Talk slow, then fast, then low, then high and then higher! The same story can be told playfully, seductively or in a way that generates intrigue. Make transitions smoothly and tell the story in a way that sucks your listener right in. Along with this, act out parts of the story with your hands or your whole body. This doesn't mean get really excited and try-hard. It means use the expressiveness in your delivery to create an experience for the listener.
9. Have a punch line. A punch line is a line that sums up your story in a powerful way. It's a way of letting the listener know that the story is over. It doesn't have to be funny, though in many stories used in the field it will be.

Examples:

"That's the last time I take THAT dog to the beach!"

"From now on I'm asking to see girls' IDs!"

"That was the day I learned the true meaning of courage."

Burning Man Story

The Girls at Burning Alan are flacking *crazy!* So I met this girl at dinner and we really hit it off. We spent the whole evening together and she was great, but something seemed a little off. Anyway, she finally takes me back to her tent and it's really romantic and everything, then afterwards we fall asleep in each others' arms. In the morning I kissed her on her forehead, but she didn't wake up, So I left and went to my own tent, which was like twenty yards away, figuring I'd see her at breakfast.

But she's not at breakfast. And she's not at lunch. And she's not at dinner. Finally after dinner, I see her across the space and she comes right oyer to me with this weird look on her face. She puts her hand on my chest, looks deep into my eyes and says, "Oh my God. you're so hot, I *have* to meet you."

I looked at her and said, "Sarah, it's *me.*"

Then she gets this really weird look on her face and says, "How did you know my *name?!?*"

- i. Story material — Burning Man, Romance, Sex
2. Be succinct.
3. Lead in: "The Girls at Burning Man are tucking *crazy!*" I'd say this animated and playfully, to convey that there's a story coming
4. Initial hook: **Crazy** girls at Burning Man
5. Unanswered questions:
 - *What is Burning Man?*
 - *Whafs Burning Man like?*
 - *Are chicks always so attracted to you?*
 - *What's wrong with this girl?*
 - *What happened next with this girl?*
6. Allude, don't state directly. This story assumes that I am pre-selected by girls without bragging about it, which is much more effective **than** saying "Hey, chicks dig me."
7. Convey personality traits:
 - *I'm sexually open*
 - *I'm adventurous*
 - *I take things in stride*
 - *I'm cool with weird and unusual people and situations*
8. Delivery is key.
9. Punch line: "How did you know my *name?*"

Using a lock-in prop

Sometimes while running the set, you are in the middle of negging and ignoring the target — and she just leaves. To prevent this, lock her in using a prop. Put your feather boa on her, or your hat. Or hand her your photos (for your *photo routine*) and ask her to hold them for a second. Now you have her *locked in*. At some point in the future you'll be able to continue with her, even if she temporarily wanders off.

This also creates *trust*. By showing that you trust her **with** your prop, **which** she could steal, you also build her trust in you.

If she starts to get restless, dangle some bait. Say something like, "I have something really cool I *need* to show you in just a sec..."

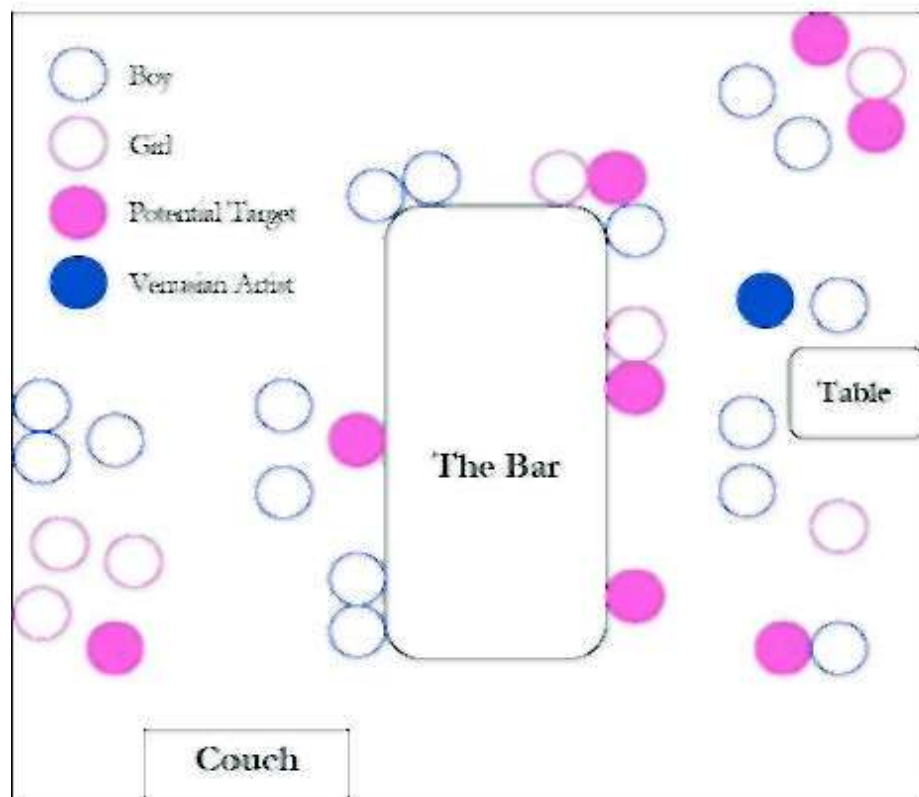

Locking-In

Imagine a two-set is at the bar. They're charting, surveying the room and sipping on their drinks. (It's not wise to open a set while they are waiting to order a drink, that's a recipe for a constant stream or interrupts in A1 and A2. Wait until the drinks are paid for and are being consumed.)

When YOU open this set, the girls will have their backs to the bar. They will see the entire room behind you, over your shoulder. But you will see nothing except the bar behind them. There is a slight power differential in your positions. As long as they are comfortable in their spot on the bar, and you are slightly less comfortable standing before them, giving them a superior line of sight, then there will be a leak of social power from YOU to the set.

You want to take their spot at the bar.

The Spin Maneuver, adapted to steal her spot

- 1) You tell one of the girls, "Go like this." And hold your hand out at chest level with the wrist bent. *This is a compliance test.*
- 2) If she defies the test and refuses to cooperate, you didn't have enough attraction. Do an IOD, then a DHV, then give her another compliance test. As you gain her **compliance** through this process you can **eventually** come back to this lock in' maneuver and continue from step 3:
- 3) If she complies, she will hold her hand out to match yours. Take her hand and say, "Now do a little spin." *This is another compliance test.*
- 4) If she complies, spin her around and during this process, move her body away from the bar, stepping into her former spot. Now you are leaning against the bar in the power position instead of her, and she is facing you with her back to the room.
- 5) With a cocky and playful attitude say, "Oh!" like you just tricked her and she totally fell for it. If you do it right, she'll be laughing and she'll punch your arm and call you a jerk. Both girls will also find you more attractive. Run another routine to keep their logical minds occupied and continue stimulating them (A2.)

Once you have locked yourself into the set, the perception in the room shifts 180°. Now the *girls* seem to be all up *on you*, instead of the other way around. Instead of merely talking to the girls, it looks like you *own* them. This psychology trick also affects the girls themselves. Soon you are leaning back against the bar comfortably and your target is standing between your legs while you run the kino test or read her palm.

Sometime during A2 you should be locked into your set. You want to be leaning back against something while the girls face you, with their backs to the room. The whole room should see you as the comfortable focal point of your group.

Role-Playing

Playful role-playing builds attraction. Just invent some crazy scenario in your head and describe it to her. Make sure it's fun and playful, not heavy.

Mystery: 'You know what I wanna do with you? ... You and I are gonna go to Greece ... and I'll dress you up in a toga and we'll sell hotdogs at the beach.'

Sometimes little bits of material like this are preferable to longer stories. Practice having normal conversations, but then peppering in little DHVs such as these. Not only is this useful as an attraction tool, but it's also useful in the comfort phase, where it's useful to create a feeling of shared conspiracy.

Style: 'You know what I wanna do with you? I want us to go to the beach together ... and you'll wear a nun outfit and I'll wear a priest outfit... and we'll hold hands and make out in front of everybody.'

False Disqualifies

Using false disqualifiers such as these has a disarming effect and also demonstrates value. In fact, they are identical to negs in this regard. These lines demonstrate confidence, fun, a lack of neediness, and a discriminating attitude that says *I'm the one controlling the frame, I'm the one who is the prize, and I'm the one who is screening; you to determine whether or not you qualify for my attention.*

With practice, these IODs can be deadly.

- "It would never work out between us."
- "I can already tell, you and I are *not* going to get along."
- "You're fired."
- "You're too much of a nice girl for me."
- "You're a dancer? OMG I can't even talk to you,"
- "I'm totally not boyfriend material. Hey, that guy over there looks *perfect* for you."
- "We are so broken up. I want my CD's back."
- "Your first impression sucked..."

The Peg System

The Peg System is a routine that enables you to demonstrate a **photographic** memory. You can also teach this routine to the girl — the act of teaching it is a routine in and of itself.

First, you must memorize the pegs. They are:

*One-Bun, Two-Shoe, Three-Tree, Four-Door, Five-Hive, Six-Sticks,
Seven-Heaven, Eight-Gate, Nine-Line, Ten-Hen*

Once you have these memorized, you are ready to perform this routine.

The effect:

Pull out your **trusty** notepad and pen, and write the numbers **1 through** 10 on the paper. Ask her to pick a random word to write down next to each number. For example, let's say she chose the words: 1. Dog, 2. Car, 3. Water, 4. Dancing, 5. Cocaine, 6. Outer Space, 7. Ugly, 8. Airplane, 9. Strait jacket, and 10. Backscratcher.

After briefly studying the paper, you claim to have all the words memorized and in order. You can list them forwards or backwards. If she calls out a number, you can instantly answer **with** the word associated **with** that number. Apparently you have a photographic memory.

The secret:

You memorize the words simply by *hanging them on the pegs in your memory*.

Remember the pegs: One-Bun, Two-Shoe, Three-Tree, Four-Door, Five-Hive, Six-Sticks, Seven-Heaven, Eight-Gate, Nine-Line, and Ten-Hen.

Word 1 is "Dog." The first peg is "Bun." Make a strange picture in your mind, of a **furry** dog on a bun, like a hot-dog bun only **with** a live dog. This is a weird **picture** that you won't easily forget. So when she calls out the number one, it's easy to make the connection in your mind: one-bun-hot dog **bun** with furry dog — the word is Dog!

Another example. The **fourth** word she chose was "Dancing." The fourth peg is "Door." So picture a ballroom full of dancing doors. Later when you are trying to remember the fourth word she chose, you'll remember Four-Door-Dancing Doors — the word is Dancing!

Using this same trick it is possible to go to twenty or **thirty** as well. For example, let's say she chooses ten more words, for a total of twenty:

The Pegs (Secret)	Chosen Words	Additional Words
One-Bun	1. Dog	11. Wind
Two-Shoe	2. Car	12. Sailboat
Three-Tree	3. Water	13. Computer
Four-Door	4. Dancing	14. Casino
Five-Hive	5. Cocaine	15. Guitar
Six-Sticks	6. Outer Space	16. Books
Seven-Heaven	7. Ugly	17. Horny
Eight-Gate	8. Airplane	18. Camera
Nine-Line	9. Straitjacket	19. Jogging
Ten-Hen	10. Backscratcher	20. Paper Clip

For one, you pictured a forty dog on a hot-dog bun. For eleven, picture the same thing, except now it is blowing around in the wind. A furry dog on a bun, blowing in the wind. Now you can remember that word one is *dog*, and word eleven is *wind*.

For word four, picture a ballroom full of dancing doors. For fourteen, picture the same thing, except add many casino tables such as blackjack and roulette.

In this manner, you can continue to add numbers ad-infinitum, in groups of ten. By simply memorizing the pegs once, you are now prepared to perform this routine on-the-fly **with** any new set of randomly chosen words, demonstrating that you apparently have a photographic memory.

Part two of this routine is to teach it to the girl.



Various Group Scenarios

"Lead the men and the women will follow."

Many group scenarios occur on a regular basis, so let's get acquainted with them.

Single Set

If the target alone?



These are simplest but have a danger of turning into another scenario type instantly if her friends come to her side. In fact, all possible scenario **types** may change abruptly at any time. This phenomenon is known as an *interrupt*. You must be dynamic enough to alter your approach when this happens.

A single scenario has no *obstacles*.

You approach her straight out. There she is. Don't wait for eye contact — too needy. Just approach her and **when** she looks up at YOU, look her in the eye and smile.

If you see the girl from a distance and you've assessed the scenario to be a single, then you can wait there for her to notice you and then *immediately* go over or you can just go right over without waiting. BUT: Do not get eye contact and then fail to approach, and think you can use that eye contact later to approach her. If you didn't approach her right **away** (the 3 Second Rule) then you *blew it* and while it's *possible* to still get her, you're now in damage control mode.

Nothing is perfect really, but you want to minimize the time between when the girl notices you and when you approach. Smile and enter, and use any opener you please. And remember, though you are opening her directly, it's from a screening frame, not a begging frame. You are curious about her and interested to find out more. The opening statement can be a remark to that effect followed by a conventional opener and false time constraint.

Two-Sets

Is the target with another girl?



Mark the friend as your *obstacle*.

Don't go straight for the target if she is not alone. The reason is that you will alienate her less attractive friend who will then act as a disgruntled guardian of the target and pull her away.

You must win the *obstacle* over first. You can use this opportunity to *not* make eye contact with the target. When the target begins to talk, you can immediately neg her, then go back to the obstacle. Doing this will make the obstacle laugh. It will also make the target feel a little self-conscious.

Lock-in the target using a *Lock-In Prop*. Continue talking to the obstacle (allowing the target to listen) until the target begins to attempt to fix her image with you from the negs. Then she will be chasing *you*. Neg her again. Then finally take time out to pay attention to her. Ask the obstacle if it's ok to talk to her friend. Because the obstacle likes you now, she will say yes. (Or "I guess.")

Don't spend too much time on the obstacle. Five to eight minutes is usually enough. If you spend too much time on her, the target will believe the obstacle really likes you and will disappear or try to get you two together. You have to make it clear once you see that the obstacle likes you that you switch your attention over to the target. Only time in the field will give you the calibration to do this properly.

Finally, you will show the target a sign that you like something about her by complimenting her — on her personality, not her anatomy. A good one is "I can tell you are a leader. I bet you're the leader of your friends. I like that."

It can be difficult to get a girl into isolation for comfort-building when she is in a two-set. The reason is that she will feel bad at the thought of leaving her friend alone. This is why it's useful to have a *wing* who can occupy the obstacle. In the ideal scenario, both girls will be potential targets. You and your wing then split the set, pull the girls and nail them both.

Three-Sets

If the target with two or more girls?



This is the same as the two-set but you must disarm both obstacles first. Again, you get the acceptance of these obstacles when you neg their friend (the target.) After you win the obstacles over and begin accepting the target's attention, you can ask the obstacles if it's all right to spend some time with the target. They will say yes because they like you. In fact, they may even leave you two alone.

- "Let's see what adventure awaits us in that room." (Put her on your arm, promenade-style.)
 - "Hey guys, I'm going to borrow your friend for a sec, we'll be right there on the couch."
 - "Hey guys, I've been ignoring your friend, I need to make it up to her. We'll be right back"
 - "Your friend and I like each other, are you cool **with** that?" ("Uh, I guess...')
 - "Is it ok if I borrow your friend for a second?" ("Uh I guess, if it's ok with her...")
 - "I like your friend. Is it alright if I talk to her for a minute/'
 - "We kinda like each other, is that ok **with** you?"
 - "I would very much like to see your friend again, is that alright with you?"
- > "Great then we'll be right back"
- > "Good then can you give us just a minute because I've got to get going"

Mixed Two-Sets

Is the target with a boyfriend?



Assume that if a girl is with a boy that they are just friends. Go in and approach the man. Befriend him. Once you have disarmed him, then you can ask "How do you know each other?" He will tell you. If he's the boyfriend, you just made a new bud and didn't even introduce yourself to the girl so you can't get in trouble. If he's not the boyfriend, then she is now fair game.

Remember to neg her politely in front of him. When she starts getting agitated or when she begins to try to get your attention, you can do a couple more negs and then finally pay attention to her. The guy will get out of the way and will watch you actually work the girl. You may be surprised how many times the guy just disappears altogether and is never heard from or mentioned again.

Mixed Sets

Is the target with two or more guys?



Same as above, but you have to disarm all the males and find what the relationships are before you pay any attention to her.

Pawning



For a woman of particular quality, it is necessary to demonstrate pre-selection in order to game her. Before you open the set **with** the nine, YOU must first open a set with a seven and attract her, and put her on your arm. She is now your *pawn*. With this demonstration of pre-selection firmly in place, open the set **with** the nine. It should open easily due to your value.

At some point when you are in A3 with the nine, when she is earning **your** affections, you will be able to "choose" her over the seven, who then disappears, never to be heard from or mentioned again.

A pawn can be paraded around the field to build social proof. She can be used to open sets — which will fly open **with** ease. She can be used to create drama or jealousy in later stages of the set.

Pawns are often unwitting participants in **your** game, although sometimes they are willing. For example:

Pivots

A pivot is a female friend that you bring to the field in order to build social proof, open sets, create jealousy, and distract obstacles. In return for her services, you show her a good time and help her to meet guys. At times, a well-trained pivot can be more useful than a good wing.

Forward and Backward Merging

As time passes in the field, practice merging sets. Be that social guy who introduces people around. There are two principal types of merging: *forward* and *backward*.

To *merge forward* means, to open a new set and merge your existing set into the new set. Pawning is often an example of forward merging.

To *merge backward* means to re-open a previous set and merge your existing set back into the previous set.

This can be useful. For example, if your target is in a two-set, you will have trouble isolating her because her friend would be stuck alone. But by merging them into another set, creating a larger set, you can now⁷ isolate your target. ("We're going to sit right over there and read her palm..")

Remember, you aren't just gaming the set, but the entire room. Is anyone else merging sets in this room? No? Then you must be the most sociable guy in here.

How to practice your game

- *Do the Mystery Method newbie drill* for at least a month or two. Open three sets per hour, four hours per night, four nights per week. Follow the 3-Second Rule.
- Have an *opener* memorized, as well as a *false time constraint*.
- Practice your *delivery*, including body language, body rocking, voice tone, comfortable attitude, and strong frame. Work on naturalizing your delivery.
- *Release all expectation of outcome* and just enjoy the process like a new hobby.
- Don't be picky about your sets — it's all just practice. Open mixed sets.
- Practice getting *locked-in* to your set as early as possible.
- Practice *multiple conversational threads* and *thread cutting*.
- *Every other night, add a new routine* to your routine stack. Make sure there are at least one or two good stories to start out with, as well as an accomplishment intro for your wing.
- Every couple of nights, add a new neg, false disqualifier, some role-playing, or some other canned material to your routine stack. Play around with it.
- Push each set as far as you can just for the practice. Use *kino escalation* and *compliance testing* as much as possible. (Chapter 6.

Feel free to go for phone numbers just for the practice. (They won't amount to anything — early on in your practice the numbers are all flakes. Call them anyway just for the practice.)

Chapter Five Review

- In the A2 phase, you *demonstrate higher value* to the set while simultaneously *negging* the target. She will respond with *indicators of interest* which can be used to gauge your progress.
- Some IOIs don't happen without a minimum amount of attraction. A girl may be attracted enough to sit down with you, but not to leave the venue together.
- The most important IOIs are: She laughs, she re-initiates conversation, she touches, and she tries to get rapport.
- *Passive IOIs* are sometimes the only IOIs that she will give. This is why it's important to use *compliance* tests while gaming.
- Girls will occasionally give *fake IOIs* when it suits their purposes, although most of the time people are not consciously aware of the IOIs they are giving off.
- There are also *indicators of disinterest, or IODs*. When a person gives an IOD, she conveys disinterest and an unwillingness to invest in the interaction.
- A *Neg* is an innocuous statement that only a disinterested party would say. Negs are actually a form of IOD.
- There are three types of Negs. The *shotgun neg*, which conveys disinterest and disarms the group, the *tease neg* which is cocky and playful and used for flirting, and the *sniper neg*, which causes the target to believe that she has done a DLV, when in fact she has not. This creates embarrassment.
- Anything you can do that conveys higher survival and replication value is a *DHV, or demonstration of higher value*.
- Correspondingly there is also a *DLV, or demonstration of lower value*.
- Using a combination of DHVs and Negs, the venusian artist disarms and befriends the obstacles. This enables him to harness the social proof of the target's peer group. At the same time, the negs cause her to crave validation from him. She responds by giving IOIs. This is A2.
- "So, how do you all know each other?" is a question that usually arises in every set, and it tends to yield very useful information.
- People who are well-acquainted with one another tend to use *multiple conversational threads* while talking, whereas people who are newly-acquainted tend to go from one complete thread to another in a more linear fashion. By using multiple conversational threads, you can create the feeling like you and the target are already old friends.
- When a certain thread is not useful to you, feel free to cut it and introduce a new thread to replace it. Sometimes this is necessary even when it is your own thread being cut.
- Stories should convey positive traits and personality) and lead the listener through a fun series of interesting thoughts or emotional waypoints. The story doesn't have to be amazing or overly impressive, just engaging and enjoyable. Shorter is better.
- Sometime during A2 you should be **locked-in** to your set. You want to be leaning back against something **while** the girls face you, with their backs to the room.
- While you are ignoring the target, lock her in using a *lock-in prop* to ensure she won't leave if she gets bored or distracted in the meantime.
- A *pawn* is a girl that you have gamed and put on your arm solely to exploit for social proof, to open sets, and to create jealousy with your real target.

A3: Male-to-Female Interest

She must be baited to invest herself in this interaction

As a result, she feels that she now represents a unique value

Once interest has been generated, the game is not over. If only it were that easy. In fact, it is not attraction that gets the girl. She must become *invested* in this interaction, and then comfort must be built. The attraction is useful — to bait her into investing. Other than that, attraction is but a vapor. She might be making out with you tonight but that doesn't mean she'll return your calls tomorrow.

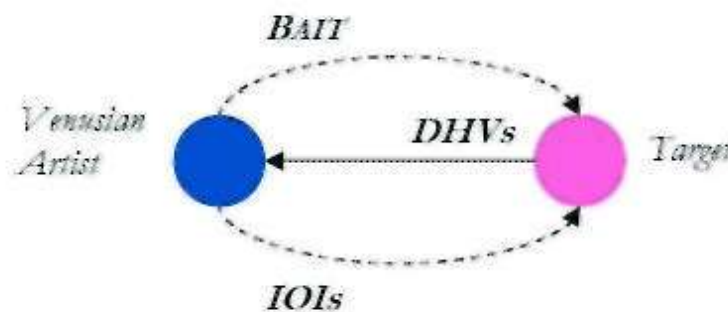

It could be said that *attraction is only a tool*. In A3 you will use her interest, combined with takeaways and screening, to bait the target into demonstrating value of her own. When she demonstrates value in an attempt to win you over, reward her with IOIs, then bait her again as the process repeats. In this way, her reward is tied to her investment. As she demonstrates value, she is rewarded yet baited to demonstrate more value.

This all comes back to pair bonding. A woman takes a much larger risk evolutionarily (and therefore emotionally) when she has sex. It's not enough that she is attracted to you — the pair bond must be there as well. She must have some

assurance that when she is pregnant back in the cave, you will stick around to bring her your fresh kills from the hunt. Otherwise you could impregnate her, move on to your next dalliance, and *she's screwed*.

Of course, we are speaking only of emotions. Is it really true that the pair bond "must" be there? Obviously not, one-night stands happen every day. What is the meaning then?

The meaning is that she still has this emotional circuitry and it is a factor in her behavior. Her emotions prefer a man of high value — high enough that it requires effort and investment in order to win him over. And her emotions *do* want to win him over — she wants to feel that he is pair bonding to her.

In other words, she wants to feel that she is important to him not just as an attractive woman, but as a specific woman. She needs to feel that it wasn't easy, she had to invest and there was some fear of loss, but now he is "falling" for her and she represents a unique value to him. This is all instinctive.

When you can bait a woman into working for your affections, and you can convey your resulting "growing pair bond" effectively, you have mastered A3 and are ready to move into comfort and trust.

Frame Control

The *frame* is the underlying meaning. It's the context, the implication — the unspoken assumption in everything you say.

If someone asks you, "Are the fish biting today?" then he is implying that you have been out fishing. He hasn't said so, but the listener will assume it is true — it's just part of the frame.

The frame supplies meaning to the content. For example, if someone says "Yeah that guy got off," what is the meaning of that statement? Depending on the context, it could mean that the 'guy' just got off of work. It could also mean that he beat a rap at the courthouse and was set free. It could also mean he had an orgasm. These are pretty different meanings. Whichever meaning becomes the accepted one is determined by the frame. *He who controls the frame controls the communication itself.*

For this reason, when interacting with other people, there are little *frame games* going on constantly. Through their behavioral cues and subtleties in what they say, people convey their assumptions. If this conveyance is **done** congruently enough, others will accept the frame as reality without even thinking about it.

If your frame is strong enough, you can get away with anything. This is the caveat for every piece of advice in this book. If you have the light frame, and it is strong enough, you can break every rule and **anything** will work. Your approach may be technically wrong, but she still responds. For a newbie, buying drinks for girls is a bad move, but everyone has a story where someone **bought** drinks and then got laid. So, which is the right way?

The field will give you the answers that you seek. Go, and be in the field, and listen to your intuition there. Over time you will calibrate.

Women will definitely test for congruence. If she can easily impose her frame over yours, this is a serious demonstration of lower value on your part. In fact, this DLV will most likely **wreck** any sexual chances you had with her. How can she rely on you to stand up to the big, bad world on her behalf, and on behalf of her offspring, if you cannot even stand up to her? The security she feels from being **with** a strong man is a primary factor in her unconscious sexual selection strategy.

Beware.. .some men in the field will also play frame games on you. If a guy can tool you in front of your set, then he can take your girls. She will almost always choose the man with tighter game and a stronger frame, and she will do it with little regard or loyalty to the fun little connection that she was previously enjoying with you. This is often true even if you are her boyfriend.

The only factor that counteracts this is her level of investment in you — it will be psychologically much more difficult for her to **jump** to the next man if she has already invested a lot of time and effort into you.

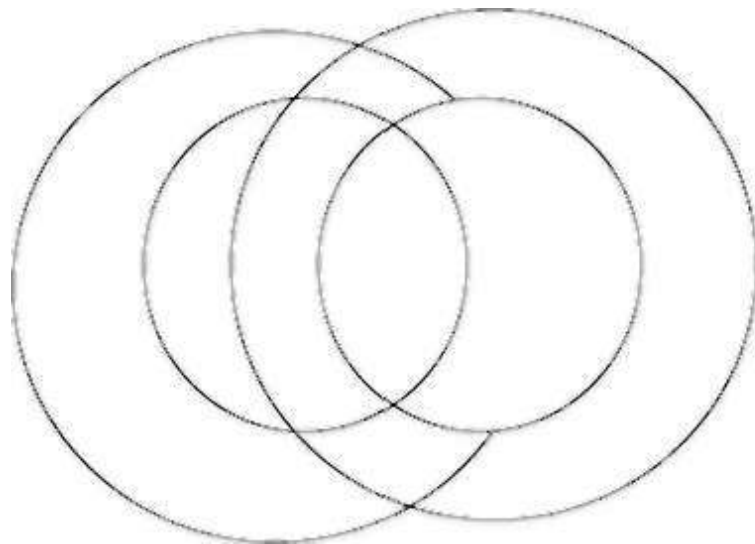

Hoop Theory

One frame game that people play is they will offer *hoops*, to see if they can get YOU to jump into their hoop. For example, a girl might try to get YOU to do something such as hold her purse or buy her a drink. Or...

- She gives you a fake IOI to see if you will start chasing her.
- She makes a comment to bait you into showing off to her.
- She gives a fake IOD to see if you get worried and react.
- She asks something to bait you into explaining yourself to her or apologizing to her.

These are all examples of hoops that girls will use to assert their feminine power. If you are doing things for her, chasing after her, showing off to her, reacting to her, apologizing to her and explaining yourself to her, those are all IOIs that she can measure and exploit.

If you jump into her hoops, two things will happen. One, she will feel really good about herself — some part of her will be reassured on a primal level. And two, she will lose attraction. Just because she likes something doesn't mean that it will get you any closer to having sex with her.

Be careful. On one hand, you don't want to be the chump who gets tooled. On the other hand, you also don't want to be the social robot that is always playing power games when he should be relaxing and confidently enjoying his interactions with women. People aren't always trying to fuck with you.

When a hoop does come along, the chump is *eager* to jump into her hoop. He thinks it shows her how much he cares. He thinks it is romantic and will win her over. He thinks any guy who does otherwise is a *jerk*. But you don't have to jump into her hoop. You can turn it back on her. Or you can create a new hoop just for her. Or you can ignore it entirely — silence is often the best reply.

Some examples:

Put up a new hoop:

Girl: Why are you talking to me?

You: Do you always wear your lipstick like that?

- O R -

You: [to her friends] is she always like this:' Get this, <*Start a routine*>

Ignore her comment:

Girl: What is with your shirt?

You:

--OR--

You: Hey guys, get this. Last weekend, my friend and I <*Start a routine*>

Grab her hoop:

Girl: Will you buy me a drink?

You: Buy *me* a drink and we will see

Every conversation has some give-and-take. If she gives you a hoop, it is actually ok to jump into it, provided that you *first get her to jump into one of your own*.

Some examples of this:

Example 1:

Girl: How old are you?

You: Guess

Girl: Hmm... .twenty-six?

You: Close, I'm actually twenty-eight.

In the first example, she asks your age. But instead of answering straight away, you make her guess first.

In the second example, she tries the same trick back on you — but your frame is too strong!

Example 2:

You: How old are you?

Girl: Guess

You: Do you want me to guess low, or guess high?

Girl: Guess low!

You: Ok then... I'd say you look about twenty-two.

An interesting thing about hoops: *the more obvious it is that it's a hoop, the less likely it becomes that someone will jump into it.*

For example, let's say that someone asked you, "Hey man, can you grab me a glass of water while you're up?" That's a pretty reasonable hoop and most people would have no problem with such a request.

But what if instead he said this: "Hey man, why don't you get up, go in the kitchen, and get me some Ricking water like the little bitch that you are."

Few indeed are the people who would jump into that hoop — it would be tantamount to accepting the frame that they are your bitch. So.. .what you want to do is start small. Bait the target into small, innocuous hoops. Over time, as she falls into your frame, those hoops can become larger and more frequent. This process is known as *compliance momentum*. Soon she'll be rubbing your back and cooking your dinner, but for now start small by making her guess your age.

Role-Reversal

In the previous chapter we discussed how attraction can be created through role-playing. A great role to play — probably the best one — is one where you have more social value than the target. In fact, this should be your reality, since she will otherwise find you less attractive.

Subtle cues in your behavior will betray your assumptions. It's important that the frame you convey in those assumptions is one where she wants you, she is chasing after you, you are the one with higher value, you are the one who decides if you want continue with her, and you are screening her to make sure she qualifies for you.

Notice that this is exactly what a woman will do. Through little tilings that she says, she sets a frame that she is the prize. You don't want to get sucked into that frame. Instead, you want to grab this hoop and use it yourself

For example, a few minutes into the pickup, when you have some light kino (physical contact) you can say, "You know, you're really good at this."

Without fail, she replies, "Good at what?" or "What exactly do you mean?"

You reply, "Well you've been talking to me for just a short while, and you've already got my hand on your waist. I've gotta watch out for you. I'm not easy you know."

Notice the unspoken assumption that you are the prize, that you are the one being chased, and that you are the one who decides whether or not this will go to the next level. If you will take any girl you can get, you must be a loser. But if you are picky, you must be a winner, and her emotional circuitry is designed to respond to winners.

Some examples of role-reversal lines:

- "Don't think you're going to get something just because you're buying me this drink."
- "Geez are you always this forward?"
- "I don't want to rush things."
- "I don't want to get hurt. I need lots of comfort and trust first."
- "I want to get to know you better first."
- "I don't do that on a first date."

- "Hey, hands off the merchandise, this isn't free you know."
- "I'll be the judge of that."
- "You just want me for my body."
- Take her hand, then as she reciprocates, pull back and say "Not so fast."
- "Are you always this fast?"
- "...yeah if you're lucky."
- "I'm not ready to be in a relationship right now."

- "I wore my old briefs tonight to make sure nothing happens."
- "I swear, all you girls do is think about one thing."
- "OMG are you groping me??"
- "You're a really nice girl."
- "That guy over there looks perfect for you."
- "I don't even know you."
- "Let's just be friends."

The above lines are examples of what someone with the right attitude might say. It's not the lines themselves that are important, but the internal strength of frame. When you have strong *inner game*, the right things will come out of your mouth automatically.

Also note that when you accuse her of being forward, or trying to get you into bed, this doesn't mean it is true. It's not — you are deliberately misinterpreting the situation. But if your frame is strong enough, she will get sucked in and respond as though it *is* true. Remember, she's programmed to respond to high-value guys.

Having Standards

Here is what it means if you have no standards when it comes to women:

- 1) I will take "whatever I can get (which is not much.)"
- 2) There is nothing special or unique about you, I settled for you, because I have no sexual choice. I'm grateful just to find someone who is willing to fuck a loser like me; apparently that someone is you.
- 3) Being with me makes you feel common and used.

Instead, if you demonstrate to a woman that you have standards, it conveys this:

- 1) I have a lot of choice when it comes to women. I am accustomed to success with women.
- 2) If I do take a liking to you, it is more than just for your looks. It is because you are a special and unique person who lives up to my high expectations.
- 3) I will only be with a quality woman and that's what you are.

Remember, women have antenna for this sort of thing. They can tell which way you lean and they will feel the resulting emotions.

The average guy approaches a woman assuming that she is selective and hoping to pass her test. He thinks, "*God you are so hot, do you have a boyfriend? Can I buy you a drink?*" Because of this attitude, subtle cues in his behavior will convey entirely the wrong frame. She will pick up on this and lose interest.

Correspondingly, the opposite is true if you *have standards*; subtle cues in your behavior will set the frame that you are a selective, high-value guy. She will pick up on this and gain interest. She expects that a guy with potential will be someone who is selective. Here are some standards worth considering:

- An attractive woman who takes care of herself
- A woman who is sociable and has friends
- A woman who has a real thirst for life.
- A woman who has a great energy and chemistry when the two of you are together
- A woman who is not a flake
- A woman who is in touch with her own sensuality. She's not a baby anymore
- A woman who can seek after her own fulfillment instead of waiting for approval from her friends
- A classy and smart woman with an education
- A woman who is adventurous and has a great imagination.

Screening

The idea is to get *her* hoping that *she's* good enough to qualify for *you*. After all, you are a high-value guy. Sure, you're curious about her, but you want to know more. Is she smart? Does she have a lot of friends? Does she have a good relationship with her family? Can she dance well? (You know what *that* means!) What's the most spontaneous thing she's done recently? Can she cook?

- "Is **there** more to you than meets the eye?"
- "What do you want to be when you grow up?"
- "There are lots of beautiful women here. But what's really important is the energy, the intelligence, the little tilings about a person that make her unique. What are some tilings about you that would make me want to get to know you better?"
- "If a magician came along and you could be *poof* anything you want to be...what would you choose? And don't say princess."
- "If you had to pick one thing that makes life worth living, what would it be?..." "-> [Style's EV routine.]
- "Who are you?"
- "Do you like animals?"
- "How old are you?" -> [Now disqualify: "OMG, you're just a baby."]
- "So tell me, what are your three best qualities?"
- "Did you go to school? Are you smart? Do you **have** lots of friends?"
- "Can you cook? Do you give good backrubs? Are you adventurous?"
- "Are you a passionate person?"
- "There are some people who...they think **they're** open-minded and adventurous. They make all these great plans...they talk about meeting new people, or going on a diet, or taking a cool trip. But they don't. They just sit around doing the same old boring shit, over and over again. Are you like that?"

You don't want it to be explicit that you are screening her. Be very subtle, and she will realize it on her own accord (instead of thinking that you are trying to make her feel screened.) Somewhere in her mind an attraction switch will flip and she'll think, "Hey, this guy is screening *me* to see if he wants to invest more."

She naturally assumes that the man she is looking for will be selective. It's a behavior that she's been expecting and thus is a powerful DHV. It sets the right frame, it's the signal she's been waiting for, and it baits her to invest.

So how can you convey to her that she is being screened." By asking screening questions, by giving IOIs and IODs at the right moments, and by actually having real standards about the kind of people you spend your time with. It has to be true for you in order to carry the necessary congruence.

Intermittence

It is well-known among animal trainers that intermittent rewarding is much more effective than consistent rewarding. The principle derived is that IOIs, given to the target as a reward, should not be delivered in a predictable manner. **Uncertainty** must be introduced to the equation, in order to make the experience more emotionally compelling, so that she can feel a broader range of hope, doubt, surprise, longing, fear of loss, and other drama.

So the idea that we reward her with IOIs is only the simplest interpretation. In **truth**, we reward her investment **with** an intermittent and unpredictable mix of IOIs and IODs. This hot/cold, push/pull dynamic is very emotionally stimulating. When she is being rewarded in this manner, she is more likely to chase and to comply with *compliance tests*.

The Hotseat Game

"What's your favorite color?"

"What did you think of high school?"

"What did you eat for dinner last night?"

And so on. Make sure she gives you an answer and if not then say, "Yes, but that's not an answer to my question." That'll show her gently that you are in charge. Now this isn't all of it but what you're doing here is showing a lot of interest. After all you are essentially giving her permission to talk about herself. They get over any self-consciousness pretty quickly by doing this, too. Plus, it gets them to open up and if they hit on something interesting then they'll maybe elaborate for you.

But as I said there is more to it After they relax after the first few questions, you start throwing in some more personal ones such as:

"Have you ever been to the hospital emergency room?"

"How old were you when you first got drunk?"

"Did you and your siblings keep secrets'?"

"Ever had a very rough breakup?"

"What's your favorite food / vacation / place to visit" (use your imagination)

Kino Escalation

Kino is an NLP term and is an abbreviation for *kinesthetic*, which refers to the sense of touch. When venusian artists (and NLP geeks) speak of *kino*, they are referring to physical touching of any kind.

An important principle in the game is that *nothing is ever a big deal*. The typical chump takes a girl out on a date and then hopes to get the kiss at the end of the night. He wants to show her how *respectful* he is. As the evening passes, he comes closer and closer to that awkward moment at the end of the night when he has to *make the big move* and go in for the kiss. This makes it a *Big Deal*.

If the moment of your first kiss is weird and awkward, it will probably also be your last kiss. Women are very unforgiving about this sort of thing. They have a fantasy about meeting the right guy, about how perfect it will be and how everything will happen so naturally and *so right*. And the truth is, with guys who have game (read: practice), that's exactly how it *does* happen.

When things go down the right way, there never is a "big moment" when you go in for the kiss and "make it happen." *Instead, there is a natural flow of kino from the very early stages of the set that leads all the way to sex.* It should be seamless — a series of small, naturally executed moments, none of which ever stick out in any remarkable way. She feels like it's just how the two of you are together.

Thus, the kino begins in the early stages of the set, and *escalates* from there.

Imagine two jellyfish right near each other. A few of their tentacles just *barely* brush against one another. Tendrils curl and touch, sliding off and then touching again. More tentacles join the dance spontaneously. Larger numbers brush against one another as a few begin to pull more strongly. There is energy between the two jellyfish; a powerful chemistry is building as they intertwine and draw closer.

That may be a strange picture. But the point is that there is no single moment when someone *makes a move*. Instead, there is this subtle, plausibly-accidental-yet-accelerating dance as the energy grows between them. It's this energy that's important. This vibe. This chemistry'.

The innuendo and the little hints and touches at first serve to add playfulness while creating plausible deniability. So do the touches create the vibe, or does the

vibe create the touches? It is all part of a snowballing and self-propelling system that feeds upon itself and sparks like a tire. Then it grows and becomes clear that it is *on* between them.

This energy is what's important, not the physical touches. The physical touches are not merely yards to be gained on a football field in order to get closer to the goal. Rather, they are one necessary piece to incorporate with various other tools to create a certain *chemistry* between you and the target. There should be anticipation and tension in the air.

Windows of Escalation

As you game a girl — as you demonstrate value and lack of neediness, stimulate emotions, take control of the frame, make a connection, and so on —periodically a window of opportunity will open for you to escalate. If you miss the hint, and that window closes, you have just demonstrated lower value — and her patience will wear thin. Enough missed opportunities and she'll decide that you're either too chicken to make a move, or you're incompetent in carrying it out, or you are lacking in social intelligence and thus incapable of leading the dance. Any of those are DLVs.

So, if she is standing there, talking to you, just continue escalating. Assume that it's on, always. Even if your assumption is wrong, it will still result in the highest possible number of lavs. It's also the best way to improve your calibration. And once your calibration is tight, all of your escalations will happen smoothly, and that is the long term goal anyway.

Some forms of kino are:

- Arm in arm
- Hands touching
- Embracing
- Embracing "from behind"
- Kissing lips
- Kissing or nibbling on neck
- Hand on knee
- Sitting on lap
- Arm around waist
- Touching face
- Smelling or pulling hair
- Hand on ass

Non-Standard Touching

When **touching** a girl's hand, you're *not* trying to set a frame that the two of you are explicitly hand-holding like a couple of teenagers marking **their territory**. Instead, you might be reading her palm or thumb-wrestling with her, or showing her some jive handshake, or taking her hand and spinning her around.

What's important is that she becomes accustomed to your hands touching — this act should seem natural and normal to her. It shouldn't seem like you're trying to *get somewhere with* her, like it usually does when some guy wants to hold her hand or put his arms around her. Instead, it's fun and feels right as you create this comfort with your touch.

Don't make excuses

Don't be tentative and wimpy about touching, be natural and confident. Touching (guys *and* girls) is one way that alpha males like you demonstrate their dominance.

Always be leading - one step at a time

Remember the principle that it is easier to condition people to jump into small, innocuous hoops. **Without** realizing it, they fall into your frame as your hoops become larger and more explicit over time.

For this reason, when you do the spin maneuver, you don't say, "Ok I'm going to spin you around in a circle, let me see your hand." This is much too large of a hoop. Unless you have demonstrated a lot of value, girls will probably give you some trouble on this hoop; it forces their egos to become involved. But instead you say, "Go like this" - [holding out your hand, then taking hers when she mimics you] — "now do a little spin" — [now spin her around.] See how each step is easy for her to follow, bit-by-bit?

In this way, lead her through the entire interaction.

One step forward, two steps back

While escalating, take one step forward (metaphorically). At any sign of hesitation or defiance, take two steps back. Then step forward once again. For example, if you take her hand, and you sense any hesitation, throw her hand away. Later when you take it again, she will comply more readily. The principle is that the "two steps back" creates *more discomfort* than the "one step forward." Thus, the target becomes more likely to comply with future forward steps.

You be the one to create the tension, and you be the one to push it away

"Baby, we've got to slow this down.."

Some people think that it's the man's job to escalate, and the woman's job is to resist. Instead, think of it as if it is the man's job to do *both*. If you are constantly trying to get more kino, like getting yards on a football field, it telegraphs far too much interest and deprives her of the hot/cold, push/pull energy that she finds so compelling.

When you pull in close to a girl, there's this tension in the air. At some point, if she feels too much discomfort, she will pull away. This isn't what you want — you don't want to condition her into a behavior of constantly pulling away from you. Rather, you want her conditioned to chase after you.

So, once that tension has been created, it's now time to push *her* away. This might be physically ("get off me, geez") or emotionally, such as using a backturn, false disqualifier or some other IOD. You might frame it as though you are the prize and *you're not going to let her get anywhere with you tonight 'cause you have work tomorrow*.

One effect of this is that it spikes attraction when you push her away. She will respond more playfully to you now. Another effect is that comfort is created. She doesn't feel like you're trying to *get something* if you're constantly pushing her away. This allows her *to feel safe* while having fun with you. She can allow the emotional stimulation to escalate instead of having to shut it off in self-defense. And the push makes it that much more stimulating for her when you do pull her back in.

For this reason, toss her hand away after thumb-wrestling or palm-reading. Devise a kino routine where you embrace her for a few seconds of role-playing, and then push her away. Mix signals.. .draw near to her saying that it would never work out between you, but stroke your finger down her cheek at the same time. Then turn away. Use body rocking in conjunction with IOIs, IODs, false-disqualifiers, role-playing, stonings, and so on.

Someone could easily spend weeks or months playing with these ideas in the field. There is so much to explore.

Kino Pinging

Kino pinging is an expression of growing attraction between two people. For example, if you push a girl's shoulder and she pushes yours back, the two of you are kino pinging. Soon, people will be telling the two of you to go find a room. It's an indicator as well as a generator of attraction. Usually this sort of thing starts with a little back-and-forth verbal jousting. It's very easy to ping a girl and see if she will ping back

Sometimes kino pinging is more fun when it's deliberately hidden from her group. This shows discretion, builds conspiracy, and adds excitement.

Takeaways

Practice timing your backturns and other indicators of disinterest to coincide with sparks of attraction. Just at the moment when she feels most emotionally stimulated or in need of validation, you turn away slightly, causing her to lean in a little more. "*Wait, what you were saying about that little dog?*" It takes practice to get the timing down. Remember, the attraction is only a tool to be used as bait.

When she pulls you back, you intermittently reward her with IOIs. Isn't it interesting that a takeaway is best done just after a DHV, when the target has just experienced a spike in attraction? That is the time that she is most likely to chase to get you back. Similarly, it's best to give an IOD just before escalating, since it makes it more likely that she will accept the escalation. For example, if you turn your back on her just before you kiss her, she will be more likely to accept the kiss. These sorts of tilings must be experimented with in the field in order to be properly calibrated. Incidentally, this takeaway aspect of A3 corresponds to the third law of the *Tao of Steve: Be gone*.

This is a useful time to use sniper negs such as "eye boogers," "you spit on me," "here's a napkin," etc. Remember, you don't get blamed for the eye booger, God does. You aren't *trying* to make her feel embarrassed, it *just happened*. It is at this time that she wants to regain your respect, and she wants to feel good again, so when you make your move, she won't get all cocky and pull away. She'll accept it because she felt embarrassed and got all quiet. Of course, you don't want to reward her for being a goof, because that would be incongruent. So you amp up her embarrassment by acting disinterested for a bit, then you play nice guy and say, "Don't be embarrassed for being human".. .then you stop being into the conversation for a bit. In that state of mind, she is extremely susceptible to escalation.

Compliance

One concept central to the Mystery Method is *compliance testing*. The basic idea is, you give her a kino-related hoop. If she complies with your move, several tilings are accomplished: (1) Similar to kino pinging, it is an IOI and also creates attraction. (2) You have escalated — she is now more comfortable with your touch. (3) Her frame has further been influenced and absorbed by your own.

So if she complies, reward her with an IOI. Or better yet, reward her intermittently. You might do a compliance test with her hands and then throw them away. But then her next compliance might be rewarded with a compliment or another touch, or by turning to face her more with a smile, etc. This might be followed by another IOD to create more sexual tension.

Compliance Test IOIs

- You take her hand and drop it... she grabs for it again
 - You squeeze her hand and she squeezes back
 - You touch her and she touches you back
 - Put her hand on your knee and see if she leaves it there
- Put her arm in yours and walk her around the venue. Does she comply?
 - Sit her on TOUT lap. She does?
 - When you are locked-in, take her hand and pull her in a little closer *as you are Talking at the same time*. Now she is standing **between** your legs as you run game on her.

The Kino Test Routine

Hold out your hands in front of you, with your palms facing up. The body language to her should communicate that you are expecting her to give you her hands. This is a compliance test.

If she gives you her hands, squeeze them, and see if she squeezes back. Then slowly lower them, and see if she follows the movement in order to continue contact.

- Try throwing her hands away after.
- Try telling her she passed or failed.
- Try explaining the routine as you perform it on her.
- Try it as merely subtext while talking about something else.
- Try using this routine on the target as a way of defeating a competing male who has invaded your set

If she defies your compliance test, give her an IOD, followed by a DHV and then another compliance test. For example, if you ask a girl to stand up, she may refuse to do so. She has refused your hoop. This doesn't look good; it's a DLV to the group. Don't blame her — maybe she's just not attracted enough yet, maybe the hoop was too big, too early. So just be unaffected, do another DHV, and try another, smaller compliance test: *"Show me your hand"* (Which can always be followed up by taking her hand and saying: *"Ok now stand up for a sec..."*)

Nearly everything is a compliance test. Putting her hand on your cock is a compliance test. Every escalation, every bounce or move, every touch, kissing, even sex itself. When you're wondering how things are going with your current target, ask yourself: *How much compliance do I have?*

The more value you have, the more she'll permit you to escalate your compliance testing. If you're a rock star, her rules will go right out the window.

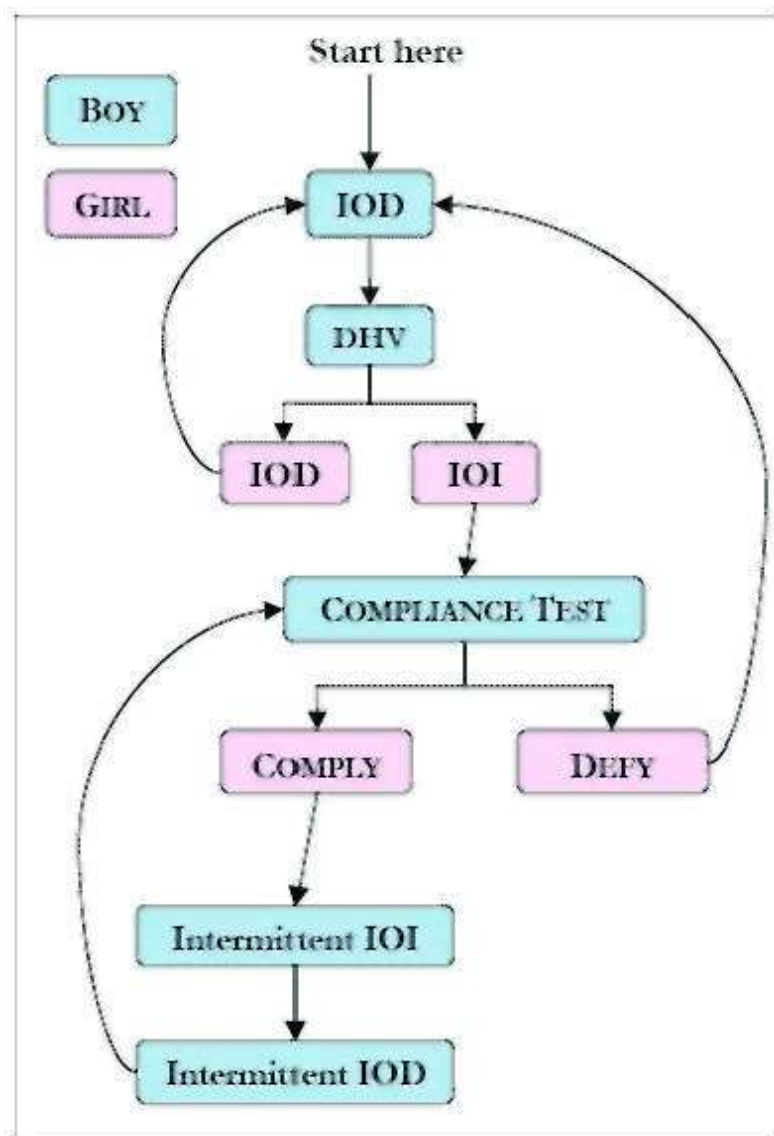

Compliance Momentum

There is a basic AIM model where people interact socially in five ways:

- DHV — Demonstration of higher value.
- DLV — Demonstration of lower value. (Other people do this, not you.)
- IOI — Indicator of interest.
- IOD — Indicator of disinterest.
- CT — Compliance test. Almost all interactions at some point come down to a test for compliance. Will you get compliance or defiance?

Following the illustration above, here is the way it goes after you open: you IOD (neg, etc.) and DHV, then wait for female IOIs. If she responds with IOIs, give her a compliance test. (If instead she gives an IOD, then just repeat the process.)

If she complies with your test, reward her with IOIs and then give her another compliance test. As this cycle repeats, *compliance momentum* is built

This continues until you reach sex, which is somewhere around 65% compliance. (Yes, there are deeper levels of compliance than sex — but they are not the subject of this book.)

Comfort is not only trust and time — it is also compliance.

If you ask a friend to do something for you, he is much more likely to do it than if you were to ask a random stranger. If you walk up to your girlfriend and kiss her, she will not only let you, she will pull you in and kiss you harder. Why? It's because you have a high level of compliance. However you have almost no chance of walking up to a stranger and doing this.

Why do we say that compliance has momentum? All compliance builds upon itself. Someone complying will continue to comply. Someone defying will continue to defy and resent, and take as attacks any attempt to force her to comply. But once we have reached compliance threshold, it takes very little effort to keep the compliance going.

Negative Compliance Momentum

10s will not usually want to talk to you right off the opener. In other words, they exhibit low compliance to your opener. So to establish compliance, IOD them, DHV, then try opening them to see if they will comply.

This may not be necessary if you already have compliance. For example, what happens when you open a set of 7s, and immediately the girls are into YOU, but then you neg them purely out of dogmatism? In an instant, the interaction goes sour.

Why?

It's because you have established *negative compliance momentum*. You punished them for good behavior.

The same phenomenon occurs when you reward — or fail to punish — bad behavior. Either way, negative compliance momentum gets built up and then works to your detriment.

Compliance Threshold

When choosing to align with people, we comply with their requests *to a certain threshold*. The more value that you represent to a woman, the more she wants to align with you — the more leeway you have when escalating. By using IODs to punish defiance, and IOIs to reward compliance, a venusian artist can quickly bring a woman to the compliance threshold.

The *compliance threshold* is the point of the interaction where she realizes that she has more fun if she complies! Once this happens, you have established control of the frame and she will follow **your** lead. This should happen in A2 or A3. *If in C1 you are still getting defiance, **then you are not really in C1 at all***

Do not be afraid to overestimate your value. If you waste time trying to build value that you already have, when you should instead be compliance testing, you could blow yourself out of the set by creating negative compliance.

One venusian artist used to have a problem with Southern girls, because they were so nice that he felt he wasn't sparking attraction, so he would over-neg to the point of obnoxiousness. Later he realized that those sets were already on, and all he was doing was creating resistance to his compliance tests by **punishing** inappropriately **when** he should have been escalating.

Give-and-Take

Mutual compliance occurs in C1. In A2, if she drops something, you bust on her for it. You do not give her any of your compliance yet. However in Comfort, if she drops something you will pick it up for her. It is here that you show that you will comply for her. This is attractive as she wants someone to take care of her. She just doesn't want it until mid-game.

Once in comfort, the venusian artist and his target should both comply for each other all the way to a mutual seduction. Having a girl undress you is better than you undressing her. If you get a girl to come over and bring a candle and then light it for you in her bedroom, tilings are going to happen — the compliance makes it clear.

It's also important to note that her willingness to comply will be directly affected by the congruence **with** which you deliver the compliance test. If you give her a

compliance request and any part of her senses that you cannot back it up, she will deny you. Do not look for her approval or even her being "ok with it." Just lead.

What are some other examples of gaining compliance?

- Getting her to invest. (She goes to retrieve a drink for you, she spends some money on you, etc.)
- Getting her to move with you or bounce to another location.
- Locking her in. The longer a girl wears an item of yours, the more compliance you have. If the girl removes your item, she is defying.
- Social pressure. Get one of her peer group to tell her to be nice to you, or to give you an accomplishment introduction, and you will immediately gain much more compliance from her.
- People generally comply if it results in more fun, or gaining some benefit. We are inherently selfish.
- People will also comply if there is a threat A man with a gun gets more compliance than one with a hose.

Of course the venusian artist will never actually pull out a gun. But there are ways to make her feel slightly threatened if she fails to comply.

For example:

- You can punish her with freeze-outs every time she defies. Basically any IOD will work. (When freezing her out, it's much better to seem like you are becoming *genuinely distracted* — you do *not* want her to think that you're deliberately punishing her. See chapter 7.)
- You can walk off in the middle of her defiance and start a jealousy plotline in an adjacent set then either wait for her to come over or just wander back after establishing how much fun you can be. (See chapter 7 for more on freeze-outs and jealousy plots.)
- In early A2, you can take all attention off of her and use active disinterest, then compliance test again and IOI her for complying.

Token Resistance

At higher levels of escalation, such as kissing, your hands will be moving much more freely around her body. (*This* is also a form of compliance testing.) Girls are programmed to give *Token resistance* to physical escalation; it's an emotional response to avoid feeling like a slut. She wants things to happen, but she wants it to feel right and she doesn't want it to be *her fault*. For example, if you put your hand on her leg and leave it there, she may remove it. This is undesirable because you are now using her *anti-slut defense* to condition her to push you away.

But instead if you stroke your finger up her thigh as part of a routine and then your touch is gone, you have ended clean. She may even feel slight disappointment that the touch is gone. Now she is more being conditioned to feel dismay when your touch is gone.

She is also more accustomed to your touch and accepting of it. This works because of the *consistency principle*. She didn't object because the touch was already gone. But by not objecting, some part of her has tacitly accepted that it's not objectionable. In the future she is more likely to be consistent with the behavior and frame that she is already accustomed to when interacting with you. After all, she's not a hypocrite.

Touching with Motion

Another interesting aspect of that example is the *motion* involved. Somehow moving your hand across her thigh is not as objectionable as putting your hand on her thigh and leaving it there.

Similarly, if you are ready to touch her breasts outside her shirt (which is *not* usually an early part of escalation but *will* eventually happen) then you will gain compliance much easier if instead of just grabbing her boob, you stroke your hand across it as part of a larger petting motion on her body, ending up somewhere else like her waist. This concept is much easier to demonstrate in seminar than to describe in text. It's just a way of escalating more smoothly, which she will appreciate. Make her feel good.

Qualifiers

Periodically the time comes to let a girl know she is qualifying for you. She has to feel like she is winning you over, otherwise she will get discouraged.

These lines are only examples. You could qualify her even with your body language. Try giving her an IOI. Turn to face her when she says something that you can misinterpret as being cool and worthy of an IOI.

Often, it's useful to follow an IOI with an IOD. Notice that each of these qualifiers has an optional disqualifier.

- "You are SO adorable...-> it's sickening."
- "You know, you can be pretty interesting sometimes."
- "You're awesome! ...Sort of"
- "It's weird.. I feel so good around you." [False disqualifier] "Too bad you're not my type."
- "You're pretty... -> but you're EVIL."
- "OMG you're French? That is so awesome. -> I can't even talk to you right now."
- "OMG you're a dancer? That is so awesome. -> I can't even talk to you right now."

Statements of Interest (SOI)

Similar to an indicator of interest, which is usually a subtle cue of some sort, a *statement of interest* is an explicit verbal statement that makes clear your growing interest in her. For example:

- "You know, your first impression was kind of so-so.. .but now that I get to know you, you are so incredible..."
- Buy her a drink.
- "When we met, you just seemed like another one of those California blonde girls. But since I get to know you, I actually feel nervous around you."
- "OMG, I can't believe this. Like. Can you believe we met at a bar?"
- "We're going to sit down over there, would you like to join us?"
- "You know what; you are actually pretty cool, I'm curious about you."
- "I have to hang out with you again sometime. -> Can you cook"

A well-timed SOI can work wonders.

Compliments

- No crap about "you are so hot," "You are my dream girl," etc. In other words, compliment from a screening frame, not a begging frame.
- Compliment her style, her energy, her poise, or something unique about her outfit that she chose. Her shoes, her hair, and ONLY if you really like it and think it deserves a compliment. This means don't be that guy who is constantly complimenting girls on their necklace. Learn to notice things.
- Try using constructive criticism after making the compliment. This is a powerful way to neg her and demonstrate value.
- DON'T MENTION HER LOOKS.

*Hint: Try **complimenting** a girl in a way that directs her to behave the way you want her to, and to play a role that's useful to you.*

An example of this: "You seem to be very connected with your emotions. You seem to really listen to your woman's intuition." Or if she's being rude, or if you want to misinterpret that she was rude, say, "You're too classy to act like this."

Just tell her how you "view" her, and she will become that person for you, but only if she agrees and it is flattering for her. You are building a character for her, and she will play the role because she likes the way that the role makes her feel. Here are some *examples* of compliments:

- "You seem like someone who really knows what she wants, I admire that."
- "You really care about your friends. I bet you will make a really good mother."
- "You have a good energy."
- "I notice you're the leader of your friends. Why is that?"
- "You're a great conversationalist."
- "You're a very classy girl. What are you doing in a place like this?"
- "Wow you seem so confident with your friends, like you're kinda the leader of your peer group. I just love your energy... -> Are you close with your family?" [Going into next routine.]
- "You have such an expressive personality ... That's a valuable thing in the entertainment industry. There are a million women who are beautiful; I just came back from Florida, but how many do you think have an outgoing personality like yourself? I'm telling you, that's a very attractive quality and a valuable asset."

Bait - Hook - Reel - Release

The "*Bait—Hook-Reel-Release*" metaphor is one that continually resurfaces in study of the game. One way to apply it is in A3. You want to give IOIs to the target, but you don't want to seem too easy. (Otherwise she won't appreciate your pair bond; instead she will enjoy your IOIs as a validation of her sexual power, but she will lose attraction for you.)

The idea is to make the *woman* demonstrate higher value to *you*. *Bait* her into telling you *interesting things* about herself (not "what do you *dot*") so when she replies (*the hook*) you can IOI her (*reel her in*) only to push her off again (*release* her from the pressure of being hit on.) This process repeats several times.

Here is an example for you to use in-field right away

You: [Bait] What nationality are you?

Her: [Hook] French.

You: [Reel] Seriously? No WAY!!! The girl I had the biggest crush on in high school was French! [Release] I can't even talk to you now.

Every time she gives you a demonstration of higher value, you indicate your interest to her. This way she will believe your IOIs, and when you fully SOI her, she will feel like she really deserves it. This allows your attraction for her to legitimately grow over several minutes instead of just IOIing her because she first IOI'd you.

An important aspect of the Mystery Method is to restructure routines to be in context with YOUR IDENTITY in particular. Take the time to write up some personalized routines with this in mind. Again, make yours congruent with your identity. You do not have to be a magician to do the Mystery Method, but you do need a strong identity

Here is an example of this, using Mystery's identity:

Mystery: "If you could be anything in the world with no chance of failure, what would you want to be? And don't say 'Princess' haa."

Girl: "Urn, an actress."

Mystery: "Really? When I was little I wanted to grow up and be a magician. And you know what I am now? A magician! So you want to be an actress. I'm living proof that our dreams can come true. It would be so cool if you were an actress. I love that! We need to figure out how to make that happen. I bet you'd be an amazing actress. But what if you get more attention than I? I can't even hang out with you now.'¹

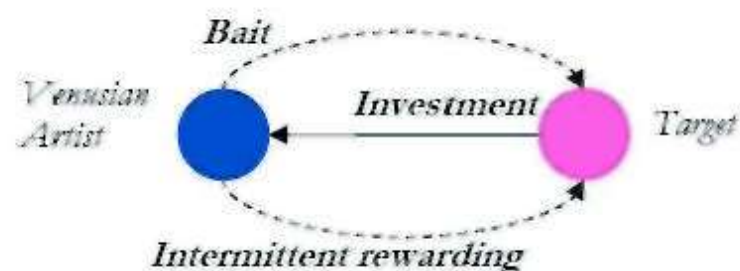

The *Bait—Hook—Reel—Release* metaphor perfectly matches the A3 process described in this chapter, whether applied to screening, hoops, kino escalation or compliance testing. Here are some examples of this:

Bait — Challenge her
Hook - She DHVs for you
Reel — Give her an SOI
Release — False disqualifier

Bait — Give her a compliance test
Hook - FAILURE; she defies
Release — Give her an IOD

Bait — DHV in some way
Hook — She gives IOIs
Reel — Kino escalation
Release — Throw her hand away

Bait — Give her a compliance test
Hook - SUCCESS; she complies
Reel — Kino escalation.
Release - Push her away

Bait — Ask her a screening question
Hook — She qualifies herself to you
Reel - Give her an IOI
Release — False time constraint

Bait - DHV, men takeaway
Hook - She chases, for example she quickly finds a way to prolong the conversation

Reel — Give her a qualifier
Release — Give her an IOD

Bait — Give her a hoop to jump into
Hook — She jumps into your hoop

Bait — Give her a compliance test
Hook — She complies
Reel - Compliment her
Release — Tease neg

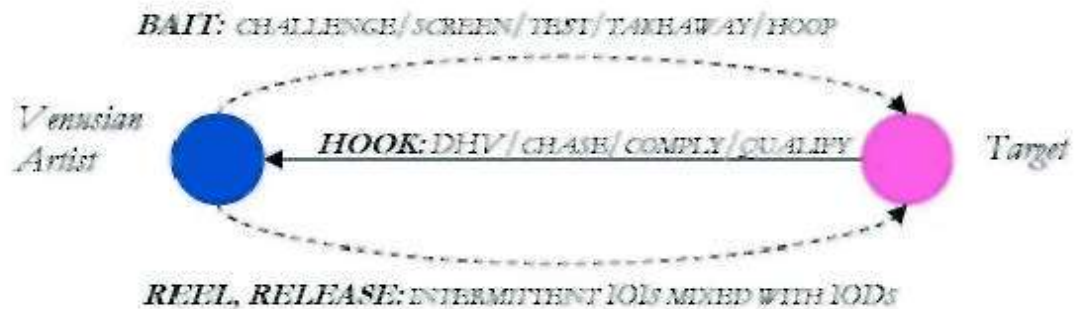

The bait can be a challenge, a screening question, a compliance test, a takeaway, a hoop, or so on. *THESE ARE ONLY EXAMPLES.* The truth is that bait can be *anything*. It can be a subtle cue in your body language. It can be an allusion to a tempting bounce, giving her an opportunity to show interest in joining you. Find what works for you using experimentation and field-testing.

You: "How old are you?"
 Her: "23, how about YOU?" (Hook!)
 You: (ignoring her question) "Hold out your hand."
 Her: (She complies — spin her.)
 You: "How graceful! I bet you were a ballet geek"
 You: (Hold out hands, expecting hers.)
 Her: (Complies and gives you her hands. Hook!)
 You: (While talking about unrelated material, do the kino test.)
 Her: (She squeezes back.)
 You: (Continue talking and throw her hands away.)
 You: what do you want to be when you grow up?"
 Her: "I want to be a teacher..I'm studying education at XYZ school" (Hook!)
 You: "Wow that's a good school This is funny, I thought you were like these other girls; I gave you way insufficient credit. I bet you'd be really good working with children; you'll probably make a great mother someday. Too bad you're totally not my type. You're a cool girl; we should find you someone tonight"

You: (Finishing a DHV)
 Her: "So what's your name?" (IOI)
 You: (ignoring her question) "Are you an intuitive person?"
 Her: "Yes very much so!" (Hook!)
 You: "Let me see your hand."
 Her: (She complies.)
 You: (Stroking your finger down her palm.)
 "Interesting..." (Throw her hand away.)
 Her: "Wait, what? Can you read palms?" (Chasing)
 You: (Taking her hand again.) "See this line? This is the retard line, it means you're a retard." (Hug her.)
 You: "So tell me, what are your three best qualities?"
 Her: "Well, I'm loyal, I'm smart..." (Hook!)
 You: (Interrupting) "Can you cook?"
 Her: "Oh yeah I can cook all kinds of stuff." (Hook!)
 You: (Smiling approvingly) "That's so cool, it seems like everyone eats TV dinners these days. I have to go in a minute, but I was wondering..." (Go into next routine.)
 You: (Finishing a DHV and body rocking away...)
 Her: "So wait a sec, what ever happened to that dog?" (Hook!)
 You: (Rocking back) "You know what, you're so adorable.. it's sickening!"

Her perception of the pickup in terms of social status



When you first open her set, you are just some guy. She has no reason to perceive you as having any more value than that. She sees herself as the *prize*.

A1



Except...hmm you are dressed well, and have good body language, not needy, and interesting...

A2



Now you are demonstrating value. Other girls are touching you and then you neg her! She starts to give IOIs, which you exploit

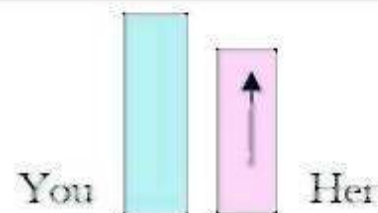

She DHVs to win **your** affections. You respond with intermittent IOIs, compliance tests, and hoops as she "wins you over."

A3

Now that she has indicated her interest in you (A2) and you have indicated your interest in her (A3), she is invested in this interaction and is probably trying to build comfort with you, or wishing you would make it happen.

C1



You now have mutual respect, investment, and attraction. Move her to a location where the two of you can be more isolated together, and build comfort with her.

Chapter Six Review

- In the A3 phase, you bait a woman into working for your affections. As she becomes invested in the interaction, you reward her and the cycle repeats.
- The *Frame* is the context, usually assumed and unspoken, that provides meaning to the content and the interaction. He who controls the frame controls the communication itself.
- *If your frame is strong enough, you can get away with anything.* You can use any opener, any line, any spontaneous attitude, and it will work — *but you must be congruent.*
- *The field will give you the answers that you seek. Go, and be in the field, and listen to your intuition there. Over time you will calibrate.*
- Women and men will play frame games on you and test you for congruence. Women are seeking a strong mate and men are testing for dominance. Often this is unconscious and instinctive behavior.
- There are all sorts of hoops that people will produce to see if you will jump into their hoop. Don't. Instead, bait them to jump into your hoops.
- Don't go off the deep end and respond to every social interaction like it's a power play for dominance and like you are so clever for recognizing it. You will turn into a *social robot* and will lose your ability to vibe naturally with people. Be relaxed and enjoy the process.
- Feel free to jump into someone's hoop if you can first make them jump into one of yours.
- The more obvious it is that it's a hoop, the less likely it becomes that someone will jump into it.
- A useful frame is where you are the person in the interaction with more value, not her. This isn't explicitly communicated, but you imply it with your assumptions, in a fun way.
- When using this sort of material, remember that what's really important is the *inner game*. With practice, your internal frame will become congruent and comfortable with spontaneous interaction as well as canned material.
- You must *have standards* about what sort of woman you want to be with. This will be communicated in your frame through many subtle cues in your body language and speech.
- One way to do this is to screen her by asking her certain questions. Calibrate gently — you don't want her to think this is a tactic to flip her attraction switch. (The standards must be real.)
- Intermittent rewarding is more effective than consistent rewarding. Use IODs to add a *hot/cold, push/pull* dynamic when you are stimulating and rewarding the target.
- There is a natural flow of kino from the very early stages of the set that leads all the way to sex. Nothing is ever a big deal, there is never any "big move" — it's just how the two of you are when you are together.
- Take aways, properly timed, will condition her to chase.
- Don't compliment a woman on her looks. Don't mention her looks.
- Almost all interactions at some point come down to a test for *compliance*. Will you get compliance or defiance?
- *Compliance momentum* can be built by rewarding "good" behavior using intermittent IOIs and punishing "bad" behavior using IODs. A venusian artist will continue compliance testing all the way up to sex.
- The *compliance threshold* is the point where she realizes that she benefits more if she complies.
- *Bait-Hook-Reel-Release* is a metaphor used to describe the application of compliance testing, screening, qualifiers, and other aspects of A3.

C1: Comfort and Conversation

A wide conversational rapport

A sense of comfort and trust

A sense that this interaction is real and genuine

A feeling of connection

There are several elements that *need* to be added to the mix at this point. Although you and your target have both indicated interest in each other, **YOU** have still only known each other for five or ten minutes. Your interest is based purely on the attraction switches flipped. By baiting her to invest **further**, you now have an opportunity to build comfort and trust with her. And that is what actually gets the girl — *the game is played in comfort*. **Everything** else was merely to get to this point.

If it has not already been demonstrated that the two of you can have a normal, fun, natural conversation together, this is the time to do so. In the **future**, when she is deciding whether or not to return your phone call, you don't want her thinking, *"Geez all we really had to talk about was dog food and petting our dogs, we didn't really connect on a conversational level. Plus I made out with him so I know he's going to want more of that, but I don't even know this guy.. .it was fun at the time but I just don't feel comfortable with this right now. There are a million guys; I'll meet another hot guy tonight when I'm out with my girlfriends."*

This is exactly why so many phone numbers are flakes — not enough comfort. Thus, it's important to have fun, natural conversations **with** girls, using wide rapport and multiple conversational threads. When she looks back on that conversation, she should be thinking about how she enjoys talking with you and looks forward to doing so again.

Also, there must be a sense that this interaction is real and genuine. Often this is the reason why women are distrustful of "nice guys." How does she know he isn't just pretending to be nice in order to get into her pants? Sure, he's buying

dinner and telling her she's pretty.. .but is that what he's really like? Or is that just what he's like when he wants something?

By demonstrating a willingness to walk, or to step up and call bullshit in a fun way, you demonstrate that you are being genuine with her, which creates *trust*, allowing her to *feel safe*. This is what girls mean when they say they want a man who can *keep it real*. She needs to feel that she is getting to know the *real you* —and that takes time.

When you first game a girl, she is being stimulated and having fun with you. If done in a competent manner, most women enjoy it at the time. But for her to consider dating you in the future, she must not only be invested, but she must feel that there is a real connection between YOU. She must see you as someone who could really become a part of her life — and more importantly, that she could become a part *of your* life. She wants someone who is similar to her in various ways. Someone who looks like a good counterpart, that other people would say, "Oh you look like such a great couple!" She wants someone that her friends like; someone she can show off on social occasions; someone that she understands and empathizes with.

When she remembers you, does she feel a genuine connection? Or are you just some guy she had a few laughs with while drinking at a bar one night?

The Freeze-Out

When YOU are in the *attract phase*, YOU can bust her balls when she busts yours. But once you reach comfort, if she busts on you, you can only *freeze-out* by withdrawing attention. She will say, "what's wrong?" You say, "Nothing." (*Not sulking! The delivery must be sincere, like it's really no big deal*)

Then, after she is punished by your silence for an awkward moment, return to comfort by finding something to IOI her for.

She learns quickly not to bust on you because, (1) you've already proven that you *can* bust back (in attract phase) and (2) she feels *discomfort* whenever she busts on YOU. This is your opportunity to show her YOU aren't always an asshole like you were in attract phase.

So *freeze-outs* are a way to *train* her. You can use discomfort sparingly to teach her that being nice to you means comfort and fun. When the time has come to

build comfort, it's counterproductive to continue being cocky and ball busting. The punish/reward dynamic must be used instead.

This phase is also your opportunity to demonstrate that you are capable of making uncomfortable situations comfortable again. The use of *sniper negs* is great here, like saying, "you have something on your nose" and handing her a tissue.

She feels uncomfortable but it's *not your* fault, it's God's. Right after this, she will feel *so small*. After she notices that you are freezing her out a bit (not as if you're being cruel, but rather as if you aren't interested in her), give her a *compliance rest* and then reward her compliance with an IOI. In this way you can continue rewarding her, but only for compliance and not misbehavior.

Style's Kiss Tactic

When sitting arm-in-arm with your target, lean in and smell her hair and say, "You smell so flacking good, Fin trying so hard not to kiss you right now..."

Then, push her off you and say, "Now get off of me." At this point, do a slight freeze out/IOD and wait for her to give you an IOI. If you did everything correctly up to this point, she will give you an IOI by re-initiating kino with you. After she does, lean in and kiss her.

You'll know that she is ready to be kissed after she IOIs you, because you verbalized that you wanted to kiss her, and her IOIing you is a way of accepting this verbalization.

The above routine is a very good example of many of the principles of MM (kino escalation, compliance, punishment/reward, etc.) working in conjunction with one another. See how the woman enjoys this process when it unfolds?

When you lean in to smell her hair, you are giving her an IOI, but you also do not want to make her uncomfortable by escalating too fast. Therefore, you push her off of you. This in turn makes her uncomfortable. She notices that she is more uncomfortable not having kino with you than she was when she had kino with you, so she re-initiates kino. Then when you lean in to kiss her, this is an IOI. Thus you are rewarding her good behavior (her kining you), and encouraging more such behavior as tilings progress.

This is how a venusian artist uses the one step forward two steps back principle to get the girl to chase him.

Comfort Building Locations

The location in **which** you first meet a woman is not necessarily favorable to building comfort. The music may be too loud for lengthy comfort building dialog. The crowd may be too congested. Your romantic interest's protective friends, current boyfriend, jealous ex-boyfriend or family members may be present. You or she may also lack the immediate time to spend 7 hours building enough comfort with each other.

If the meeting location does not allow you the time nor afford a comfortable setting to sit with her and build comfort, you must move her from the meeting location to a comfort location.

All comfort building locations are marked by more quiet and secluded (though often still public) settings where you, your romantic interest and her friends (as well as your friends) may share in lengthy dialogue.

There are three types of comfort building locations that you and your romantic interest will visit. Mystery has named these C1, C2, and C3.

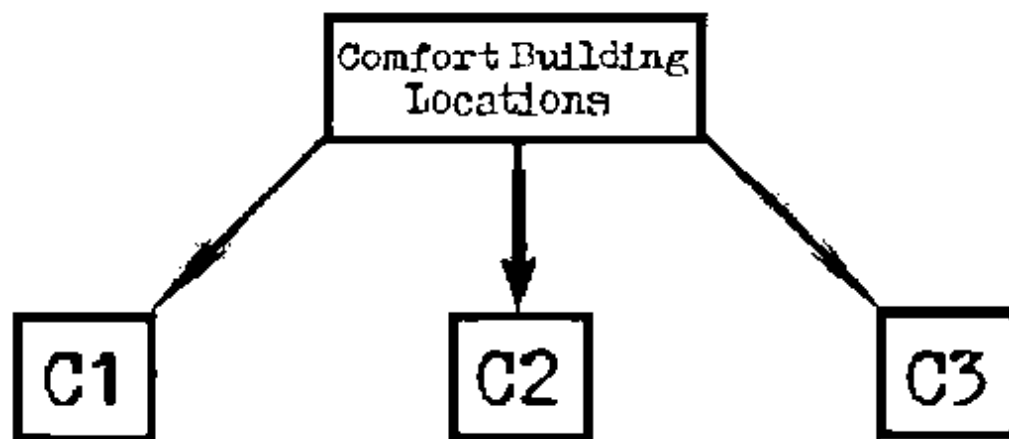

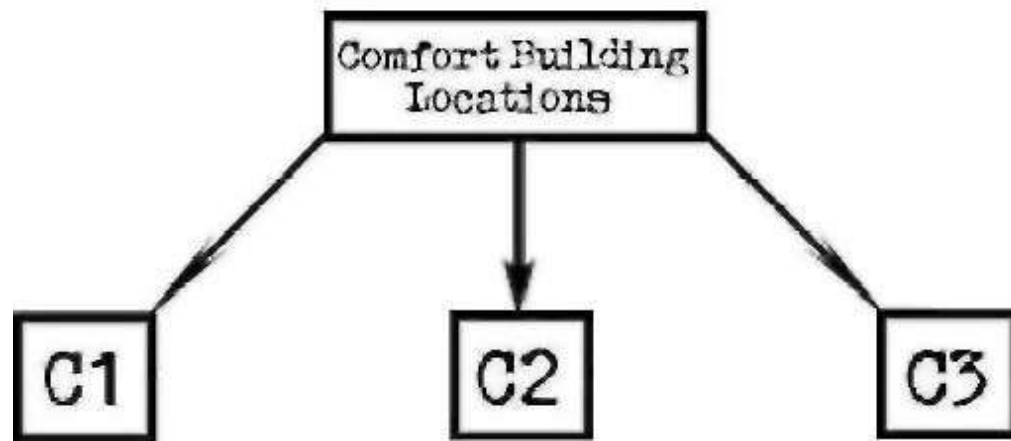

Three Comfort Building Locations Types

C1 = *Any comfort building location within the meeting location.*

C2 = *Any comfort building location separate from the meeting location and the sex location*

C3 = *Any comfort building location within the sex location.*

The Five Location Types for Gaming

The five locations are the Meeting Location, C1, C2, C3, and the Sex Location. The C1 location exists somewhere within the meeting location during the pickup stage, while the C3 location exists within the sex location during the seduction stage.

Here is one way to look at it:

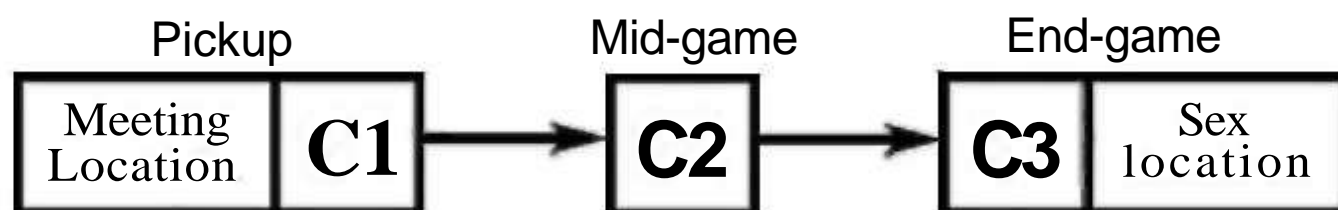

There are several reasons for this design structure:

- Moving only a few feet from the meeting location to the C1 location carries with it much less of a safety risk for a woman who has just met you and it thus helps keep her in social homeostasis.
- It is much less of a personal investment in getting to know you, a relative stranger, than jumping directly to a C2 location without establishing at least some comfort. *Because it's a smaller hoop, she's more likely to do it.*
- Moving to a C1 location allows you the opportunity to make her feel comfortable enough so you may successfully jump to a C2 location with her.
- Moving only a few feet from the C3 location to the sex location is much more practical than having her know in the C2 location that you are planning on taking her directly to a sex location with only one 'naughty thoughty' on your mind.



Going from the meeting location to a C1 location, or from the C3 location to the sex location is called *moving*. Going from C1 to C2, from C2 to another C2, or C2 to C3 is called *jumping*.

The C1 Location



Any comfort building location within the meeting location.

Unless your romantic interest is already sitting in a quiet area within the meeting location you will inevitably have to *move* from the meeting location to C1.

In fact, before you even approach a woman in a meeting location you must have a nearby C1 comfort building location pre-selected so you may be prepared to move to it.

C1 examples:

- *Leaning up against wall or bar with woman leaning in and facing you*
- *Sitting on stool by bar with woman standing between your legs*
- *Sitting in quiet area of club or coffee shop*

Unless your meeting location is already a good C1 location, every successful pickup will inevitably require you to *move* to a C1 location.

Moving to C1

To *move* means, to go from the meeting location to C1 with your romantic interest and her friends if necessary- (Moving also means going from the C3 location to the sex location, which we'll examine in a later chapter.) Moving is not only a logistical necessity, but is also a powerful comfort builder in-and-of itself.

Meet Location to C1 Move

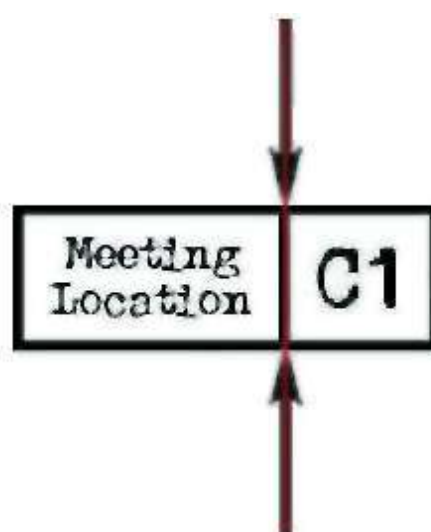

Example:

Mystery is speaking to a beautiful woman by the bar of a busy nightclub. Before even approaching the woman in this meeting location he had his game plan already in mind: moving her to the quiet smoking section; a good C1 location. He places his hat on her and says, "I'm going to show you some thing really neat. Come join me for a sec."

The woman replies, "Where are we going?"

"It's a special little place I like to call ... You'll See," he laughs, pointing towards the smoking section. "Just right there." He begins walking off a few feet.

While she is hesitant to leave her friends even for "a sec," she is more apt to join him because he has locked her in with his hat. Though she doesn't even smoke, she has to at least take a few steps forward to return his hat.

"What are you gonna show me?" she asks curiously as he grabs her hand and leads her through the crowd.

"Are you creative?" Mystery asks back, keeping her curious. While they move, he does a subtle *interest test* on her. He gauges her interest levels by loosening his grip as they walk. Does she hold his hand tightly still or let go of his hand:'

"I want to see how creative you are before I show you," he says as he pulls out a pad of paper and pen and hands them to her. Reaching the smoking section, they sit together and he places her hand on his knee and lets go. Does she leave it there? This is another subtle test.

He leans back and says, 'It's quieter out here. Ok, I need you think up a list of 10 random words, but they can't have any association with any other word you come up with.'

And so, with a successful move (and an isolation from her friends as well in this case) from the meeting location to C1, he is able to begin building comfort, in this case by demonstrating his photographic memory using *The Peg System* and then teaching it to her.

Some isolation lines:

- "Let's see what adventure awaits us in that room." (Put her on your arm, promenade-style.)
 - "Hey gays, I'm going to borrow your friend for a sec, we'll be right there on the couch."
 - "I'm going to show you something really neat, come with me."
 - "I want to introduce you to my friend, come with me."
 - "You have *got* to meet my friend."
 - "Let's go get a drink"
- "Ok stand up. Now give me your arm, promenade-style. Now come here for a sec..."
 - "Your friend and I kinda like each other, are you cool with that?" ("Uh, I guess...")
 - "Is it ok if I borrow your friend for a second?" ("Uh I guess; if it's ok with her...")
 - "I like your friend. Is it alright if I talk to her for a minute?" ("I guess; if it's ok with her...")
- > "Great then well be right back."

Conversational Rapport

- Be a talkative person. Talk to anybody, not just girls. Get into the zone.
- Don't explicitly try to impress or show off. Don't directly tell impressive facts about yourself. Don't seek attention, approval, or understanding from others. Hot women are already bothered enough by guys who are worried what she thinks. Try being the one guy who isn't.
- Don't talk about weird, creepy, or stupid topics. Most people who do this are seeking attention. *It's cool to get attention, but it's very uncool to be perceived as seeking it.* Thus, don't provoke people or show off to them in any way.
- Practice moving your target and getting her into isolation for comfort-building.
- Demonstrate *vulnerability* and establish *commonality and connection*.
- Practice stacks of canned material. This is a useful skill.
- Also practice natural, spontaneous conversations with no canned material.
- Practice using Multiple Conversational Threads.
- Continually escalate kino and use compliance testing.
- For those readers versed in NLP, this phase is a good time to practice your patterning.
- Cut boring threads, yours or hers. Lead the frame.
- Talk about fun, interesting, emotionally compelling topics.
- Don't ask a bunch of questions. They don't add value and they come off rapport-seeking. Instead of asking her where she's from, make a guess. She'll ask you why you guessed Arkansas, you'll give her a reason, and she'll giggle — whether you were right or not.
- (You *do* want her to contribute and invest *III* the conversation. But you want her to do so because she is attracted, not because you are forcing the conversation along with lots of questions. You must add value.)
- Be agreeable. You don't always have to be right. Don't take yourself too seriously. For example, don't use disagreement unless you need to enforce a frame. If you're arguing about something you probably care too much. Remember why you're here.
- *Rapport* doesn't mean *boring*. The vibe you created in the Attract stage should still be simmering just below the surface. If it isn't, then you probably made M3 Sequencing Mistake #2: *Comfort but with no Attraction*.
- Practice your *grounding routine*, which will be covered in this chapter.

The Question Game

"Have you ever played the question game? Well there are *rules*...

"Rule 1, you ask a question, then me, then you, and so on, back and forth.

"Rule 2, you have to tell the truth, the whole truth, and nothing but the truth. Like truth or dare but without the dare because I don't know how weird you really are." [Notice the neg.]

"Rule 3, you can't ask the same question that's already been asked.

"Rule 4, you have to ask questions that let skeletons out of the closet. Take advantage of our anonymity.

"Oh and.. .Rule 5, you go first."

She will say, "that's not fair."

So you then ask, "How many boyfriends have you had?"

From here on, the question game will escalate sexually until she is asking you how many times you masturbate. It's a fun routine. This is a comfort building routine that's also useful for screening. Another great thing about the question game is that it can last for a really long time. When you get into C1, use this routine as your default.

Fun question: "Tell me a secret."

Really - Be Talkative

It's vitally important to be talkative. It's easy to say it but actually try it for a few months of practice. If you have *so much* to talk about, and you bombard her (or her set) **with** lots of fun and interesting conversation, showing humor, opinion, and passion, then you get to convey your personality.

The talkative person just gets laid *way* more often. The secret is to put yourself in a talkative mood. Have you ever been in one? Close your eyes for a moment and remember what it was like at the time. Looking back on all the girls Mystery has been with, he just talked their ears off. Then after he saw positive body language and other IOIs he would come out of the blue and say, "Would you like to kiss me?"

That's it — he would just talk passionately about something.. .talk and talk. He wouldn't talk about her. He wouldn't ask questions. He wouldn't really expect her to say anything. If she wants to join in, great, but otherwise, who cares? He does it all.'

Talking is a Logistical Tool

There is another benefit to talking — it occupies the conscious mind. Imagine that you're talking to your friend. You both get into his car, continuing your conversation, and he drives you to the beach. From your perspective, you were having this conversation; sights were flying by, and *voila!* You're at the beach! It's like magic — the conversation was the opiate

The pickup should be the same way. She is talking to you; everything feels so fun, comfortable and natural. The conversation continues to flow — *voila!* She's having sex. Like magic! Her conscious mind should be constantly occupied by you.

Nothing ruins the mood like a long, quiet car ride back to the house...or a long quiet walk back to the car. Talking and keeping the flow is necessary to overcome logistical difficulties that inevitably will arise.

The Photo Routine

Preparation:

Take pictures of yourself in interesting situations. Active shots —you doing *fun* things. Goofing off at your workout place. You rock climbing. You partying with friends and girls. You in mid-air while roller-blading. The 'bear shit' from the bear you bumped into while hiking. Etc. The best photos will convey value as well as your identity. Also include a couple boring or out-of-focus pictures for realism.

Put these photos in a developing envelope, as though you just picked them up from the store today where they were developed, and you happen to have them with you.

Performance:

While in set, use the envelope as a *lock-in prop* on the target, while also demonstrating higher value to the set. If she tries to open the envelope, swat her hand and call her nosy. ("Geez is she always like this?" Etc.)

When the time comes to engage the target directly with A3 and C1, you can decide to "be nicer" to her and sit down with her to go through the pictures. For each picture, *tell a story*. During this time you can demonstrate pre-selection, social proof and other DHVs, build comfort, and you can also engage her in a fun dialogue where she contributes and invests. Your stories will remind her of her own stories and she will tell one to you. Practice your spontaneous conversations.

This way, you will always have a thread to go back to and a new story with each picture. I have it on good authority that Mystery himself swears the Photo Routine is the best routine ever made.

Commonality

The old saying *opposites attract* notwithstanding, people tend to be more attracted to those whom they consider to be similar to themselves in some way. The more that you both have in common with each other, the more her *serendipity chip* will be activated to let her know that this was *meant to be*.

She needs to be able to imagine you as a realistic addition to her everyday life. Sure she enjoyed being entertained by you at the club. But that is a fantasy world. In real life, would the two of you *fit*? Would your respective social circles be compatible?

Be careful: if it looks like you are fishing for commonalities in an effort to ingratiate yourself with her, it makes you look desperate. There are, however, ways to share commonalities that aren't try-hard. For example, this classic Mystery Method game:

The Music Game

This game is very simple: share with each other those things that you like. For example, name a band you enjoy, and then say "your turn."

She may not play along: "I don't really like that band."

You: "Just making conversation." (Turn away a bit.. .slight freeze-out.)

Her: "So.. .what else do you listen to?"

You proceed: "I like.. .Pearl Jam.. .it's my favourite band of the nineties. I really like that song 'Garden,' I remember making out with my high-school crush to that song.. .but I digress. Ok, now it's your turn."

Her: "Ok.. .I like.. .Ray Charles... I've always loved 'Georgia on my Mind.' Did you see that movie about him?"

You: "Yeah I just saw that the other night in fact. He has one of the most beautiful voices I've ever heard. Wow I'm kind of impressed; Ray Charles. I totally gave you insufficient credit. You have good taste in music."

Her: "Why, thank you."

You: "Ok my turn.. .I like.. .Tool."

Her: "I love Tool! I've been into them since their first CD."

You: "No way, you like Tool? Not too many girls are into them. You know, I remember when their last CD came out. I was..." (Tell a story.) "...So I never saw that girl again, but I still have that seashell she gave me when it rained. Ok... now it's **your turn**."

Conspiracy

Imagine that you're gaming a girl. The two of you are sitting on a couch, isolated from her friends who are now out on the dance floor. You suggest a bounce next door for a piece of pizza.

Here on the couch, you're someone she has just met and sat down to talk with for a few minutes. She's still here with her friends. But once the two of you step inside the pizza joint, you are there *together*. There is a powerful psychological effect.

Bouncing is covered in more detail in the next chapter. But what's interesting here is the shared frame. You and the girl are now in on something together. You have decided together to go on this journey together and now here you are together. Assuming you did your A3 properly, she has already been falling into your hoops, and a "we are together" frame is now strengthening between the two of you.

This *shared reality* is known as a *conspiracy*. You can usually tell when people have a conspiracy together by the looks they give one another, and by their use of *nicknames* and *inside jokes*. It goes without saying that you can also use these endearments to strengthen the conspiracy between you and your target. Be warned: this is exactly the sort of thing that would look try-hard if you were doing it too early in your set.

Tip: Have your pivot stop by and mention what a cute couple you and your target make.

One easy way to create a conspiracy is to play games that involve you and the target having a secret together against someone else — for example, girls love *people-watching*. Try this game:

Murder / Marry / Shag

As you put her on your arm, promenade -style, you say, "Ok, we're going to play a game called *murder/marry/shag*. I will point out three guys in the crowd. You have to tell me which one ^{3*011} would murder, which one you would marry, and which one you would shag — and then you have to tell me why."

After this happens, it is now her turn. Continue walking around the venue together as she picks out three girls. Which one would you murder, which one would you marry, and which one would you shag? ..And why?

Vulnerability

When people share vulnerabilities with each other, it demonstrates (and creates) an emotional connection between them. It's one of those tilings that, if done too soon, will come off like you are trying too hard to gain rapport with her — a DLV. So don't be Captain Sensitive when you first meet her. But used at the right time, sharing vulnerabilities is a powerful comfort builder.

Did she tell you something personal about herself? Did she tell you a secret? *The Question Game* is very useful for this sort of sharing. It's also possible to structure stones to make the reveal of vulnerability appear to be accidental.

Some examples of field-tested vulnerability stories:

- Tell all embarrassing story. Hint *Cosmo Confessions* is a treasure-trove of material
- First kiss experience (childhood regression)
- Your pet died because you were too small to take care of it
- Your little girl cousin fell down the stairs — "and I don't know what I would have done if things had gone bad that day, I love that little girl...so... much"
- The story of your father dying and maybe some long-simmering drama finally reaching closure

- Tell her about your childhood.
- Talk about the *cutest* little baby that you just saw and it reminded you of your little sister when you were a kid
- Reveal an insecurity and tell the story behind it
- Tell her a secret. She'll be more likely to share one of her own.
- Do not whine about your ex-girlfriend. And don't linger on sad emotions. Stimulate her sad strings and then move on to another one of your multiple threads

So much unattractive behavior comes from a desire to avoid vulnerability. The secret is to embrace your vulnerability and still be unaffected. It's ok to be wrong. It's ok to laugh at yourself sometimes. Think about it: if you're sensitive about her seeing that you're wrong, then it obviously matters to you what she thinks. But I thought you were unaffected? So the next time you tell the story of when you fought a lion with your bare hands, remember that it's more attractive - and interesting — to admit you were scared shitless than it is to play Mister Tough Guy.

Punishment / Reward

You can't do a freeze-out unless she wants your attention in the first place. Doing a takeaway on someone who cares less isn't a takeaway at all. It only works when you are of value to her and when she says or does something negative you then *remove* your attention, to make her feel lonely. She feels bad and knows she would prefer talking to you so that is why a freeze-out works.

Early in the set when she is bad, you tease her and frame control. But in C1 you don't want to go backwards in the set. So give a slight IOD. Perhaps you stop talking to her for a moment, or you turn away, or just barely shift your body language. It doesn't take much, women are very sensitive. Remember, you aren't communicating anger, merely a slight disinterest.

In this way, the 'punishment' is actually just a quick, sharp correction, like in dog training. It's not personal and you're not angry. You just get caught up sometimes in your own reality and she doesn't always merit your full attention. You turn away for a second, which indicates disinterest, delivering a slight emotional tinge directly to her.

When you are training a dog to, say, not jump on you, you don't hit his nose, because that shows anger and dogs often can't correlate your anger with his behavior. (This is why calling a girl on her shit while on the phone *sucks*. It just makes her not want to take calls from you in the future.)

Instead you simply detach yourself from the equation by taking pennies, putting them in a jar and whenever your dog jumps, you shake it briefly by his head. This scares him. However, this is not enough of a solution because over time he will come to recognize that *you* are doing it, and he won't only not jump on you — he won't want to go *near* you.

So the solution dog trainers have is this: after the correction for bad behavior, you structure a challenge for the dog to do something *correctly*. For example, right after you shake the jar, you then say, "sit" and help the dog to sit. Then you reward him with love and affection "good boy! Yes good boy!"

If you *only punish*, the dog sees you as the punisher. But if you want him to obey you and love you still, you must reward him as well. So, in this way, when we IOD a girl, we must then structure an opportunity to have her jump through one of our hoops. When she does, you reward her with "respect," or, "damn that is witty. I give you that" or "ok you win" or "that was A-crowd!"

Jealousy Plotlines

Jealousy is a powerful motivator. For a girl, horniness is not as powerful a motivator as jealousy. Which is better: a girl who feels horny but is in a club with her friends or a girl who isn't horny but is super jealous? Always choose jealousy in the club because it is usually the moment when she realizes just how attracted she is to you. Horny has its place too, but *not* until you get her *alone* at the *sex location*.

So, while in Comfort phase, when you are not hitting on her, just laughing and spending time (after A3) imagine another girl comes and sits on your lap. You introduce the two and *voila!* Instant emotions! *See, plotlines* must be built into your game consciously — just like negs are really building a plotline between you and the target. The principle is that people are willing to work more to preserve an existing investment than they are to make a new investment, even if both carry the exact same risk and reward. Simply put, fear of loss is a more powerful motivator than anticipation of gain.

The moment finally comes when you *choose her over the other girl*. This willingness to flake off girls (which they do to guys all the time) is a DHV. And for her, it is her moment of triumph over another woman, which she relishes. She has invested, she has experienced fear of loss, and now she has the prize (you!)

Another way to use this is, if you have already attracted a certain girl but she isn't being motivated enough, just go into the next set and attract another one. You may like the new one better and thus flake off the first one, or you may use her as a pawn to make the first one jealous. You could even merge the two sets.

This may sound Machiavellian and perhaps you have moral qualms about it. Just keep in mind that jealousy plots are extremely effective. This is an accurate assessment of human social behavior. It will happen all around, even involving you sometimes completely at random. Girls will use it against you as well. You always have a free will — there is nothing forcing you to use jealousy plotlines in your game. But they exist

Demonstration is the secret key to a woman, not languaging. There's nothing better than a live demo and proof that there is another girl, and its not just talk Which is more powerful, telling a girl that girls like you, or actually having two girls on your arm? Telling a girl you are adventurous, or showing a picture of you rockclimbing?

Demonstrations that create jealousy

1. Have a female wing or pivot who is "in the know" with you,
2. Build a pawn while in the club.

So for example, you are in isolation with your target, and you do a brief take-away. Use a lock-in prop on her (Mystery often uses his hat) and then go find a girl from a previous set. Tell her, "I'm sitting over there with my friend, let me introduce you,"

So when you come back, you come back with a friend. Of course this 'friend' then sits in your lap. A previous set has now been merged with the new one, but instead of *group-to-group*, it's *isolation-to-isolation*. You have two different girls in C1 at the same time.

From the point of view of the girl you brought over, introducing her to one of your other 'friends' is respectful and is a comfort tactic; the fact that this friend is a hot girl helps with social proof. She also feels good when you kino her in front of the other girl.

From your target's point of view — the girl who is still wearing your lock-in prop — she now has a challenge on her hands and *jealousy*. Bam! Sometimes the moment she first feels jealousy is also when she first consciously realizes that she is into you, and that she wants to have you over the other girl.

If you don't have ready pawns from previous sets, you can make one when you do your takeaway. So you run off and enlist a girl to directly help you by saying, "I like this girl. Will you make her jealous for me?" It's a tool.

If you have a pivot, find her and tell her to find you and sit on your lap in two minutes.

Or just game another set quickly and then when you isolate the girl from that group, say, "I've got my friend over there, let me introduce you."

So there are several options:

1. Find your pivot
2. Enlist a girl to directly help you
3. Backwards merge to a previous set
4. Forwards merge by opening a new set and bringing the new girl back to the main target.

If you want a 10, you *need* to do *advanced group theory* - which is the application of merging groups. Anecdotal evidence from the field is, that of the sets where jealousy was utilized, success always came more often and with more of a solid set. So make her jealous as a regular part of your game and you'll have girls *wanting you*.

Demonstrations are always more effective than verbal insinuations. However, here are a couple verbal tactics to install jealousy:

1. On the phone say, "Hold on I have another call." Do this three or four times during the conversation and act annoyed. It'll make you seem popular. Girls have done this to me and it works.
2. You can also throw in the tact that you have a girlfriend (which you may, or not.) "A girlfriend of mine ..." or how about, "I don't think my girlfriend would like it that you're flirting with me." Don't worry about blowing yourself out because when the girl says, "I thought you have a girlfriend," you say, "you want me to be single don't you? So you can have me. You *like me!!!* Haa, I *thought* that would make you jealous."

Incidentally, example 2 is similar to the old *gay bit* where you convey to a girl that you are gay in order to create a challenge. Later on when you are making out with her and she says, "I thought you were gay" you can reply "I was."

DEFINITION: By the way, a *bit* is a length of thread. A piece of thread. A *bit* of thread.

Finally, here is an important note for those who try this. After you make her jealous, though it may increase your value and her attraction to you, she may not respond with visible IOIs. In fact, she may be cold when you return to her. This is partly a congruence test, and part female pride. The challenge here is to warm her up again to you, but without supplicating (and thus failing the congruence test). So ignore what appear to be IODs after this (in most cases), because here they are actually IOIs showing that she was hurt and threatened. *

* Credit to Style for this insight.

Style's Eliciting Values Routine

"What is the experience you most enjoy doing?" (She'll say dancing or being with family or something) Alternate wording: "If you had to pick one experience that makes life worth living...what would it be?"

"What is the ideal scenario of you doing that thing? Describe it."

"So picturing that *right now*, how do you feel.. .What emotions?"

"So really then, while I was asking you this, you smiled... and yeah it's kind of because I'm being a bit funny or weird or whatever... but also, it's because you could kind of feel that emotion right now, while we were talking about it... can you feel it., blah blah blah"

"So really then, even though your favorite experience is dancing, your core value is fun and excitement, and the way you feel those emotions in your body... So what's most important to you is the experience of fun and excitement, and whatever leads you to that is most important... blah blah"

"Ok, so in four minutes we've fulfilled your quest for core value. You can the now."

In other words:

1. Favorite activity
2. Description of her favorite activity in an ideal setting
3. What emotion she gets while she pictures this
4. Show her that she experienced the emotion while picturing it
5. Show her that what she really wants is not so much the activity (although it's important) but the emotional fulfillment she gets from it.
6. Now she can the happy ©

Grounding

[From Mystery's Lounge – Mystery's classic Grounding article.]

I'm sure you've found yourself in a set when you reach the point where your target says, "What do you do?" You either give her your honest but lame answer like, "I'm a student", or "I'm a system administrator", or worse, you try to circumvent the question entirely with "I'm an ass model." A cocky answer like this might be funny at first, but she will probably ask you again shortly. Do you have something to hide?

The problem is you don't have an attractive *identity*, or if you do, it's not a strong one. Some guys will experiment with "I'm a rock star," or "I'm a promoter," or "I'm a public speaker," but your target will either feel you are lying (in the same way we believe an "actress" is likely a "waitress"), or if she *does* believe your evidence, she becomes intimidated - you get weighed down by the stereotype she has of you. For example, I am a magician. How can she relate to that?

Instead of answering her question with "I'm a magician," I can *ground* my present identity to her reality and harness the opportunity to convey a much richer personality. Here's how I do it:

1. "Well when I was little I wanted to be..." I (Childhood regression. Tell stories about my dreams and ambitions as a child.)
2. "When I was a teenager..." (Tell stories about how I got from 1 to 3.)
3. "Now I'm a magician. Can you believe it?" (Talk about where I am now and what I'm working on next.)

Here is the applied format that I used to ground my identity to a recent 9's reality. It helped to attract her and build enough comfort to get her back to my place.

1. What do I do? Well, when I was young,
 - a. ...I wanted to be a ventriloquist, and then a magician. (Talk about this a bit.)
2. When I got a bit older...
 - a. Tell story of my first birthday party magic show and how the money was used to see a Copperfield show. (5 minute story.)
 - b. Tell story of how my biggest audience scared the shit out of me and how I went up and kicked ass. I really get into the fear of it all. (3 minute story.)
 - c. Talk about my first real TV experience. (2 minute story.)
 - d. Tell her about moving to Las Vegas and why. This is a "vulnerability routine" in comfort stage. (3 minute story.)
3. Tell her what is now on my plate...
 - a. My "**WTF?**" underground internet show, my TV reality show interest, the book I'm writing, and my seminars on various topics such as social dynamics and wealth building. (5 minutes of stories.)
 - b. Tell her what I am planning on doing next – illusion show concepts, publicity stunts, etc. (5 minutes of stories.)

That was at least 23 minutes of story-telling and I was holding this beautiful girl long before I performed any magic. The reason magic works for me of course is because I'm a magician. You do not need to use my style or do magic in any way to use Mystery Method. There is no shortage of former students of mine who don't perform magic yet still, by sticking to the method and running their unique personality conveying material, they can consistently attract women.

If I just come in and say "I'm a magician," my target really wouldn't feel that we share commonalities or lifestyle. She would have to rely on stereotyping. I

would also not appear very humble. She would feel that I'm too different for her and I would otherwise over-qualify myself. Some women it seems would actually reject a date with George Clooney because they don't understand his lifestyle - they feel they lack commonality and this lack creates discomfort. But what if he gave her his back-story and taught her what happened, step-by-step, to him to become who he is today? This is the concept of *grounding*.

By giving my target my back-story, I ground myself to her reality ("When I was as a regular Joe") so that she can see how she too could be the type of person I now am ("This is who I am today") if only she were to make similar decisions along the way. You can even later use this format to encourage your target to ground *her* life to *you* during A2 by having her stick to the format. Simply ask, "Whoa. Back up. So what happened next?"

Notice in my list of grounding stories above that the common theme is "This is what led me to become who I am today." You too must do this - once you decide what your identity in fact *is*. Does this mean you must steal my magician identity in order to do the Mystery Method? No. You won't be telling stories of your first birthday party magic show. That would be a lie. You won't talk about how you learned the secret to a card trick by beating it out of a classmate of yours, or how years later that classmate saw you on TV and said, "I can't believe your future changed that day." No, you won't use my specific material. Nor will any of my students. But you can use material from your own real life experiences as I do. The format or game plan is the Mystery Method. The personalized *material* you use to fill in the format is what constitutes your own, personal style.

Now, how does one answer the deep question, "Who am I?" A friend of mine told me, "You are what you repeatedly do."

I do magic on a regular basis. I perform it almost every day, whether for a beautiful woman or any other person. Style writes almost every day (and gets paid for it,

making him a full-time professional) . What do *you* do on a regular basis? Besides being a social butterfly that is. Remember, the pick-up arts exist to enrich your life, not define it. What stories do you already possess that convey who you have become today?

Grounding reality is far reaching. It will change the way you do A2, A3, and build comfort - but will not alter their basic structure. It will also change the way you choose and structure routines, sequence them (which routines you will use and when) , and convey to your target the way you handle challenges in your life.

So this is what you must now do to improve your game:

1. Figure out who *you* are by looking at what you *do* repeatedly - something you can say in a word or two (e.g. magician, writer, toy inventor, CEO, hacker, rock climber, rapper, public speaker, traveler...) Are you really pursuing your dream? What would you *do* with your life if you had no chance of failure? Start doing it.
2. Come up with several stories that convey *how* you got from being a normal kid to doing what you repeatedly do.
3. Practice telling these stories to others to make the stories enthusiastic and natural. She should feel as though she's been on this journey with you.

While grounding you can also ask her, "So what were you like as a teenager?" etc. This is a great way to open her up and get her invested in the interaction. Going for rapport in this way right at the opener would be try-hard and telegraph interest. But now that she has given you IOIs and she has earned *your* IOIs, sparingly using questions in this way you can effectively build a strong connection with her.

Chapter Seven Review

- *The game is played in comfort.* It's necessary to develop a wide conversational rapport, a sense of comfort and trust, a sense that the interaction is real and genuine, and a feeling of connection.
- Missing elements of A3 and *comfort* are the primary reason that girls will flake out and blur when you call them the next day. Most guys get all blurry numbers when they first start gaming.
- When you are *real* with her, it creates trust and allows her to feel safe. Don't front, sulk, or have a confrontational attitude. Keep it fun and remember that whatever the issue, *it's no big deal.*
- A comfort building location is usually a more quiet and secluded setting where you, your romantic interest, and potentially a few friends can share in lengthier dialogue.
- The C1 location is a quiet spot somewhere within the meeting location. The C2 location is a place to go on a bounce or time bridge. The C3 location is within the sex location.
- Practice *moving* her — take your romantic interest from the meeting location to the C1 location.
- It's important to be a talkative person and to constantly be practicing your conversational skills. Don't get stuck on boring or creepy topics — keep it fun, interesting, and emotionally compelling. (*Add value.*)
- Be agreeable, don't ask a lot of questions, and remember; don't seek attention, approval, or understanding from others. (*Be unaffected.*)
- *Talking* is also a powerful logistical tool that keeps her conscious mind occupied and out of trouble while you progress the courtship. You don't want her *ant-slut defease* rearing its ugly head and screwing everything up.
- Sharing *commonalities* builds comfort and rapport, and helps her to imagine spending time with you in the future. Beware: if it comes off like you are fishing for commonalities with her, it is a DLV. *Serendipity* must be preserved!
- A *conspiracy* is a *shared frame* between you and your romantic interest, characterized by inside jokes, nicknames, and a growing connection. It is the natural outgrowth of the A3 process where validation was used to bait her into frame submission.
- *Vulnerability* is attractive and builds comfort. Instead of trying to protect your ego, set it free. Be willing to laugh at yourself — it shows confidence.
- The *freeze-out* is the deliberate use of IODs to create discomfort (as *a way to train her* out of bad behavior.) The freeze-out should come off sincere and inadvertent; she shouldn't perceive that you are *trying* to punish her, rather, just a bit of disinterest triggered by her behavior, resulting in a temporary loss of attention or validation.
- After you '*punish*' her with the freeze-out, give her a compliance test so that you can *reward her* for passing it.
- *Jealousy* is a very powerful motivator. If she feels it, that's often when she first realizes that she wants you. This also gives her that much more *drama* when you do eventually *choose her.*
- When we relate our identity, sometimes it can create distance instead of closeness. But the use of a grounding routine allows her to follow your life through stories, leading up to where you are today. This helps her to relate to you and to empathize as if she had been there with you.
- Figure out what you *do* repeatedly. Pursue your dreams. To ground her reality to your identity, tell her stories that convey how you got to where you are today and what's coming next.

Mid-Game and End-Game

A. sense that "it is on" between us...logistical issues and the passage of time...intimacy and seduction

The point of C2 is to make her feel *familiar* with you. It's not about routines so much as *shared space*. Take her **with** you to the mail. Let her keep you **company** while you are working on a paper. It takes **four** to ten hours of comfort building to have sex **with** a girl. That's seven hours of babysitting, on average — just wait it out. When the time comes, get her isolated and escalate.

Mid-game is *an opportunity* to practice being with a girl and kissing her, to practice naturally leading her through bounces and bridges, and practice talking on the phone. Remember, *the game is played in comfort*.

The Seven Hour Rule



If you log the minutes you spend with a woman, you'll realize that it usually takes somewhere between four and ten hours, cumulatively, to go from meeting her to having sex with her. The average is around seven hours.

Mystery discovered the *Seven-Hour Rule* while searching for patterns relating his success stories. Anecdotal evidence and field reports from many venusian artists generally confirm the accuracy of the rule, excepting instances of *fool's mate* of course.

While it can take several days or even weeks to accumulate seven hours of time with a woman, if you seduce her prematurely, you run the high risk of making her uncomfortable enough to have her attraction for you turn off.

We have also discovered that the most emotionally rewarding long term relationships often develop into sexual ones within a week; sometimes within as little as a few days. This only happens when you accumulatively log an average of four to ten hours of comfort building in the presence of the woman before attempting to seduce her. Mystery's most passionate relationships (one of which lasted three and a half years), often became sexual within a few days of meeting the woman. They also averaged around 7 hours in accumulated time before seduction occurred.

It is interesting to note that the Seven Hour Rule is also intrinsically comforting — even if you are not actively "comfort building" during that time, the mere fact that you are sharing time together is a powerful component of the comfort stage.

The following time log is a typical example of a modern day courtship:

Day	Minutes	Stage	Location	Highlights
1	1:30	Attract, Comfort	Pub	Kiss, exchange numbers
3	0:05	Comfort	Phone	Invite for hot apple cider
4	0:10	Comfort	His Place	Brief house visit then leave
4	1:15	Comfort	Cafe	Talk and hold hands
4	0:45	Comfort	His Place	Video, kiss, mall invite
7	0:15	Comfort	Her Car	Picked up to go to mall
7	3:00	Comfort	Mall	Meet at mall, share straw
7	0:25	Seduce	His Place	Bath and sex

Total — 7 hours and 25 minutes have accumulated in 7 days.

Most of the time you share with a woman should be invested in comfort building (mid-game) so that she will be comfortable when you begin seduction.



Kissing

- Kino and kissing are comfort builders, not seduction.
- If you go too far (into seduction) before you have enough comfort, you'll feel like a great player at the time but you won't get laid when (a) your fool's mate backfires and (b) you get buyer's remorse the next day.
- How will you know the right moment to kiss? You must train your intuition through time in the field. A good rule of thumb is to kiss her after she has given you three IOIs. For example, she touches you, she laughs at your jokes, and she picks up the conversation when you let it drop. *Go for it*, just for the practice.
- To do this, when you are ready, just go for a make-out in every set. Take a month or two to focus on it. Do it at different times over dozens in sets in order to calibrate. Right now, can you consistently get make-outs while you're in the field?
- Within twenty minutes of meeting her, you should be able to kiss her and isolate her for comfort building. Note, this doesn't mean that, long-term, you should kiss every girl in every set. But you *should* have the *ability* to do so consistently, thus it is good practice for a beginner.
- Emotions! Control and direct the girl's emotions. We are usually far too intellectual! Just tell the girl to "*shhh*" and nuzzle her. Put your mouth to her ear and inhale and whisper how good she smells.



- "I want to kiss you."
- Let the conversation drop. When she re-initiates, interrupt with "Shh..." **kiss**
- "Kiss me."
- "You talk a lot. Would you like to kiss me?"

- "Do you like having your neck bit? Why? Because right now all I want to do is bite your neck."
- "May I bite your neck? (If she says 'why' that means she wants you to. Only if she says 'no' do you *not* bite her neck playfully.)"

Mystery's Kiss Close

You ask, "Would you like to kiss me?"

If she says yes, kiss her.

If she says, "Maybe," "Why?", "What do you mean" or "I donno" it means she does, but is shy about it. Reply with a gleam in your eye, "Let's find out..."
kiss Remember to caress the back of her neck to show you mean business

If she says no, you reply, "Well I didn't say you *could*, it just looked like you had something on your mind." (Don't ask "*Why not?*" This shows low self-esteem.)

If she says, "not yet" or "not here" it means she is open to it but there is a logistical issue. Perhaps her friends are nearby, or she needs more gaming first. Say, "I understand," and continue gaming her.

Does it seem as if most of these lines involve asking her for permission in order to kiss her? Is that wimpy? They are just considerations. We've found that just going for the kiss without indicating your intentions can sometimes lead to embarrassment — more than her saying just saying *no*. When she says no, that is much easier to save face from than the situation where you try to kiss her and she moves away.

That having been said, feel free to field-test every possible kiss move that you can think of. Just go right in for the kiss without saying a word. If she turns her head, use your hand to turn it back and kiss her anyway. Test it out a hundred times. Be enthusiastically willing to brainstorm and experiment.

Evolution Phase Shift Routine

by Style

1. I tell her that she smells good and ask what she is wearing. Then I lean in, brush her hair aside, and sniff her slowly, moving up from the shoulder to the ear. "Mmmm, that smells good. People don't pay enough attention to smell. But you'll notice how animals, before they mate, will always smell each other. Evolution has hard-wired us to respond to certain things. You are wired to respond when someone smells you."
2. "It's like when someone pulls the back of your hair. You'll notice how lions, when they mate, always bite and tug at the end of each other's mane, right here." (Since I'm shaved bald, I'll add here, "This is what I miss the most about not having hair"; if you have hair, say, "This is one of my favorite things".) Then I run my hand up the back of her neck and grab a fistful of hair at the roots and pull it, downwards. She says "Mmmm..." And I say "see."
3. Then I talk about how "No one knows this, but the most sensitive places on the body are places that are usually hidden from contact with the air, like the back of the elbow (touching it) and knee (touching it). Any place where your body bends, twists, or folds, there are millions of sensitive little nerve endings that release endorphins. Then I take her arm, bend it a little, and erotically bite the area on the opposite side of the elbow (that crease where it bends). She usually gets the chills, and I have her ratify how good it feels.

[Note for the less experienced: If you don't know how to erotically bite a girl, learn before you do this. You want to take a big chunk of skin -- not a little pinch! - and slowly and firmly slide your teeth together until they meet and release the skin. You may want to practice on your own elbow first.]

4. After, I say, "But do you know what the best thing in the world is?...A bite...right..here." And I point to the side of my neck. (Every now and then, I'll add, that "this has to do with the fact that it is where the jugular vein is most exposed, and since most sexual fantasies have to do with submission and vulnerability, it sends all the fantasy signals flying.") Then I'll expose my neck and say, "Bite me right here" as if I *expect* her to do it. Fifty percent of the time **she** will. If she doesn't, I just turn away calmly (punish), wait a few seconds, and then turn back and repeat, "Bite me right here." Usually she will.
5. Half the time, her bite is lame. If so, I correct her and say, "That's not how you bite. Come here." Then I give her a good bite on the neck and instruct her to "try again." This time, she ALWAYS does a great job.
6. Now you look her in the eye, smile mischievously/approvingly, and say, very slowly, "not bad." Then glance down at her mouth, back up at her eyes, and...yes...finally...you...may...if you want...and if she's ready...um...kiss!

Short Version: grab hair, bite my neck, kiss elbow, rub back of knee, triangular gazing.

The C2 Location



Any comfort building location separate from the meeting location and the sex location

When you are in C1, the presence of your romantic interest's friends or family may at times compromise your comfort building efforts. You may instead simply not have the time to sit with her. For whatever reason, when you are unable to continue building comfort in C1, you will have to jump from C1 to C2. Examples of C2 locations:

- *Sitting in bar, coffee shop, quiet restaurant or living room*
- *Window shopping (mall or street)*
- *As you walk or drive from one comfort building location to another*

Before you approach a woman in a meeting location, have your C2 comfort building location pre-selected. Every successful pick-up will inevitably jump to C2. You may jump from one C2 location to another as many times as necessary until you spend enough time and build enough comfort to successfully shift to C3.

Jumping

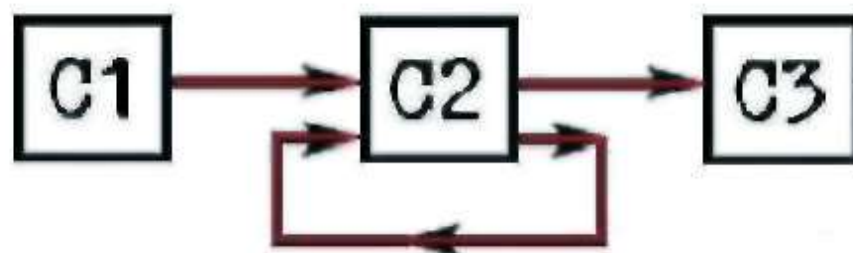

Going from one comfort location to another is called *jumping*. There are two ways to *jump*: the *bounce* and the *time-bridge*. To bounce means to move your group of people to a different venue that same night. Whereas time-bridging is to make plans to see her at another time. (Obviously bouncing is preferable.)

The Bounce

One way to change comfort building locations is to do so *at that time*. This instant venue change is called *bouncing*. (As when a friend says to you, 'We're leaving for Mel's Diner. Let's bounce.')

In other words, the purpose of bouncing is to successfully get you from one comfort building location to the next, so that you may continue spending time with your romantic interest *that same night*. Often, these are in fact structured opportunities for the woman to pursue you!

Examples:

Mystery turns **to** the woman he has been sitting with in C1 for a time and says, "My friends and I are about to grab a bite to eat over at Mel's Diner. You and your friends are more than welcome to tag along."

Daytime:

- "I'm starved; I've got to grab a bagel. Come join me."
- "I need to get an envelope from the post office, come keep me company."
- "I'm going down to Melrose to grab a shirt I need to get, let's go get some lunch."

Nighttime:

- "We're on the guest list for a better club. Come with us."
- "I'm starved. Let's get some food."
- "We're going next door to sit down for a bit. Would you and your friends like to join us?"

It's interesting to note that, for whatever reason, bouncing (as well as moving) is not only a necessary escalator, but also is a powerful comfort builder in-and-of-itself. It just creates that vibe.

If you are successfully bouncing and the seven hours are passing, comfort nearly takes care of itself. These are the two most important aspects of comfort-building.

The best way to calibrate your bouncing is to just do it as much as possible. Eventually your intuition will tell you when it is the right time.

The Time Bridge

The second way to jump comfort locations is *to agree to see each other at a later date*. This is called *time-bridging*.

The so-called "*number close*" (as in, "I got her phone number") isn't even a close at all. There is only one type of close, really: *sex*. Are you a closer?

Incidentally, there is no such thing as a "*kiss close*" either, since kissing is just a comfort-building tactic. Just like pulling the back of her hair is not a *hair pulling close*, or biting her neck is not a *neck biting close*. They are merely comfort building tactics.

So what *is* a time bridge?

A time bridge is an *optional move* in your game that you play *only* if you cannot follow the standard game plan of bouncing her for food and eventually sex. After all, if you both have the time and interest, isn't it better to continue *now* rather than try to continue it at another time?

But perhaps she won't bounce. Maybe logistics are screwed up, her friends are there, or you just haven't had the opportunity to build enough comfort for her to accept such an escalation. Then what? Well, you try to build as much comfort and trust as you can, and then you build a *time bridge*,

While talking, say, "It would be cool to talk again sometime," and then, when she agrees, you pop out the notepad and the pen as if *she* had requested it, saying, "Give me your number."

If your frame is congruent, she will behave as if it was her idea and comply. It all depends on the energy between the two of you. Is it *'on'*? When things are *on* they just seem to flow so naturally. Instead of looking for clever ways to ask for her number, focus on creating that chemistry that can grow between two people.

The purpose of the time bridge is simple: to bridge the gap of time that keeps you apart. You are with her *now* and the time bridge will allow you to be with her again in person so that you may continue. Remember, the courtship goes from *meet to sex*, not from meet to phone number. Merely getting a number is *not* a bridge, because a bridge must have two sides. A number doesn't have a definite *other side*. When you call, you're stuck trying to set a date to see each other again — if only you did that in the *first place*, you wouldn't even *need* her number.

A time bridge leads to a definite time and place where you will be with her in person to continue the courtship. It is something that you have painted onto her imagination and perhaps you even ran a routine about it. Whereas merely getting a number is nothing more than a stairway to heaven. It doesn't take much practice before you start getting phone numbers and realize they are all *blurring*. Making those numbers more solid is a serious concern.

Try setting a *time and place* to meet up again. You should be prepared with two or three time bridges for situations when you can't bounce.

Some examples:

1. "I'm picking up some shoes at the mall tomorrow. Come keep me company and we can window* shop."
2. "I've got to drop off some stuff to my sisters. Come keep me company for the drive. I'll pick you up at eight PM."
3. "I have a dinner party in two weeks. You *have* to come!"
4. "I'm going to the Magic Castle in Hollywood on Thursday to see a magic show. I'd like you to come. Let's exchange numbers."

Notice how you already have a *reason* to see each other *in-person* again. If you just got the number, you could be in a position where you have to try to convince her to see you again. You don't even need to exchange numbers. Exchanging numbers conforms too much to the stereotypical *dating frame*. If she won't meet you again, then the problem was with your not building enough value and comfort in the first place — and the number wouldn't have changed that.

Having solid game is more important than getting phone numbers. Solid game makes for solid numbers.

In the third example, you may get the number. (You've got two weeks to put together a dinner party!) Call her the next day and use the phone to establish greater rapport. Time on the phone counts toward the 7 hours — it's just another way of becoming a normal part of her life.

If you have enough comfort with her, you can meet her somewhere without even exchanging numbers and she will be there. But if you don't have enough comfort, the number will *blur*, which means it was worthless anyway. So don't place too much importance on getting numbers — practice *solid game*.

Choose locations that are conveniently near your house or where you plan on being anyways. Don't go out of your way to meet a girl who may flake on you. Have a life. The more compelling your life is, the more she will want to be a part of it.

Don't go to 'coffee' — instead say "I have to meet my friend Diane at the coffee pub to drop off a page layout for an underground newsletter. Meet me there."

I went to a mall yesterday and sat beside an old man in the crowded food court with my "*Made in Japan*" meal. He started to talk to me about this and that how skateboards used to be just metal wheels on wood boards and now they are fiberglass and such. Well, I just wanted to eat my food. I nodded but didn't want to invest in the conversation (nothing personal, he was a nice enough man and all, just... not my type haaa.)

I was displaying to him IODs (*indicators of disinterest*.) I didn't want to say, "Please don't talk to me" as that would have been rude and confrontational. Well, many women will find themselves in the same position. There are several IODs and I conveyed a couple of them to this old man. I averted my eyes to him, I opened a magazine and flipped through it while he was talking, I got *really* into my food and I answered his questions with one liner answers.

Now I'm not saying that you should give up on a girl when she gives you some IODs, because you can always torn it around. The old man could have talked about something that fascinated me and I maybe would have shared a conversation with him (a good reminder of how important it is to initiate an inherently interesting conversation), but imagine if after this conversation with the old man, he tried to get my number. Think how weird that would be.

I mean, I've gotten numbers from guys before. That's how we make male friends and buds. But imagine if this old man wanted to 'hang out.' I be like, "um, no thanks." He's not offering any *value*, and I feel no connection to him. Asking for my number under those circumstances would be an attempt to force a familiarity between us, which is Creepy, while simultaneously begging for rapport with me, which is try-hard *Both are severe DLVs*.

See. this is what a lot of guys put women through. A brief thirty seconds of boring talk and then they hit on the girl by asking for her number. Hot women are ultra-sensitive to this — they've been through it a slew of times. So when you do attempt to construct a time bridge, make it natural. Have a reason to see each other again and play solid game.

Don't be the old man in this story.

Phone Game

[From Mystery's Lounge – Lovedrop's original article on phone game.]

As you go into the Field and practice your game, you will start to accumulate phone numbers. At some point the venusian artist asks himself, "What do I do with these numbers? How do I convert these into lays?"

Oftentimes it happens like this: the venusian artist has been in the field for some weeks or months and finally he gets a number that has some importance to him. Perhaps the set went really well or the girl is especially hot, or he hasn't been laid in a while. For whatever reason, he wants to play it just *right* so that he gets this girl. He might even post in an online forum or call a friend with game so he can ask, "What do I do with this number? How do I get this girl?" *He doesn't want to fuck this up!!*

And there's the rub. You cannot ever let some number become that important to you - much in the same way that you cannot ever let any specific courtship matter to you. Opening sets and calling numbers are both activities that you should be doing over and over again purely for the practice.

If I am going into my sixth set of the night, and I know there will be more sets tonight {and tomorrow night, etc) I am just not going to be that concerned about the outcome. Instead, I can focus on the process and play with it. I can practice my skill while simultaneously giving off a natural, comfortable vibe with the subtext: *I don't care if I fuck this up.* Ironically this results in a greater success rate.

The same must be true of your phone calls and your dates {time bridges.) You have to do many of them, or your skill will never improve. You can't take any one call or date seriously. You're just doing it for the practice. Enjoy the process. Be willing to lose and learn.

Here are just a few ideas to play around with on the phone:

- Anyone who's taken a live program knows that you shouldn't eject from a set immediately after getting the phone number. Stay around and talk for a few more minutes afterwards. Otherwise you play into the pattern of all the other guys she flaked on who got her number immediately before parting.
- Don't make the number itself the point. The point is the time bridge. Maybe the two of you discussed going to sushi. Maybe some art exhibit. Whatever. The point is that the number is an incidental, not a goal. When in set, practice your bridging and collection numbers along the way.

- Don't assume that every phone call must occur for the purpose of setting up a meet. Is this how you use the phone when you talk to your friends?
- Call her up soon after the set is over (that same night) and chat for a few minutes, then let her go.
- Call her in the next day or two and chat her up, then let her go. In this way you come off non-needy, and you are conditioning her to accept you as a normal part of her life. Not some bar guy, not some club fantasy last Saturday - but a real person who is a normal and regular part of her life.
- Call her when you're somewhere fun, like you would call your guy friends, just to invite her over to hang out. Whether she comes or not, you're having a good time without her and she knows it.
- Time on the phone counts towards comfort time (the seven hours.) So use it as an opportunity to build comfort, become a pleasantly chatty person, and practice. Only time on the phone will give you the practice so that you can vibe on the phone.
- If you talk to her as described above, she will likely start hinting at a meet. Especially if you talk about the fun activities and friends that you experience in your day-to-day life. It's also perfectly reasonable to throw out an activity and see if she bites. If she doesn't, no big deal - your life is fun and fulfilling with or without her. You'll just get someone else. (This attitude, by the way, should be *subtext* to her, never explicitly communicated.)
- Even if a girl hasn't accepted an offer to meet (or preferably made one of her own) - it's *no big deal* to you because as soon as you get off the phone with her, you've still got to call five, ten, or twenty other girls and practice the same phone game with them. This is the most important piece. When you are holding that one phone number and worried that you are going to fuck it up, that's going about it all wrong. You should be out gaming regularly. Eventually you will be getting phone numbers regularly and you will be going through your calling rotation regularly as well. It's hard to be worried about any specific number when you know that you still have 5 others to call. It's all just practice - and the lack of neediness will be evident in your voice.

A Note on Flakes

There will always be some percentage of flakes. Girls tend to be flakey creatures. They don't just flake on you - they flake on their friends and family, and often they even flake on themselves.

- Just keep calling them anyway. Put them in the rotation. There is a random component to the game. Sometimes a girl who really liked you won't return your calls. Sometimes a girl that wasn't so solid is suddenly ready to come over and get it on. You never know! So just keep them in the rotation and keep practicing. Never take any number seriously.
- As your game improves, your flake percentages will drop. So keep working on value, attract, qualify, comfort, etc. Keep working on conditioning girls to chase after you and get invested in the interaction. The tighter your game, the fewer flakes you will have to deal with.
- * Often you can't even get the girl on the phone. Big deal. Maybe it's *buyer's remorse*. Maybe her friends talked her out of it. Maybe her grandma just died. Leave her a message and call the next girl. Go out practicing tonight. Etc! This is a lifestyle.

Dating

[From Mystery's Lounge — Lovedrop's original article on dating.]

At some point in my game, I discovered that it was really easy to get isolated with a girl. I could game up a set, get a number, call her a few days later, and soon she's sitting on my bed and we're watching a movie together.

But the problem was, I hadn't done enough A3 or comfort in order to escalate. There was this weird pressure for me to make a move, even though she wasn't ready for me to do so, and it would be awkward - and then I'd never hear from her again. I discovered that I could get girls over at my place but I couldn't make anything happen after that point.

The solution, for me, was to design a specific date plan that I could repeat over and over again. A routine that I could practice with on many different girls until I had my dating game tight. If you are getting numbers, but not lays, it's useful to practice your dating game in a structured way.

When designing my date, I decided it should have as many venue changes, and as many hours together, as possible. For some reason, moving, bouncing, and the seven hours are powerful comfort builders, so I built these ideas into my date routine. Here's what I came up with:

(On **the phone**) --—"Let's do sushi Wednesday night like we talked about. There's a good place near where I live. Come by around 7 and we'll go eat."

~ 7:30 PM——Girl shows up at my place. I come downstairs but then I "forgot" something so we have to run back upstairs "real quick." She gets to see my pimp pad and my bay view, which she Oos and Ahhs over. Then I hustle her out and we drive to the sushi shop. Kudos to David DeAngelo of *Double Your Dating* for this trick...it familiarizes her with your place (so it's not a big deal / fear **of the unknown** when you return!) and it also makes her more curious about being in my apartment, since I hustled her out.

~8:00 PM——We're at the Sushi shop. I have various routines that I always do...can't pour your own Sake, Japanese voice stuff, teach her chopsticks, etc. The specifics aren't important. Most of the time here is vibing, practicing comfort, the question game, palm read, whatever. Getting to know each other.

~9:00 PM——"There's this really cool band playing across the street, let's go check it out!!" There is an 80's parody rock band that plays every Wednesday right across the street from my sushi shop. I have a VIP card to the venue so we don't have to wait in line. I take the girl across the street but the band hasn't started yet. So we have a few drinks and more comfort building material, along with some push/pull to keep up the sexual tension.

-10:00 PM — The concert room opens and we enter (another venue change.) As the crowd thickens, I'm either leading her through the crowd or I've got my arms around her to protect her from the crowd. The band goes on shortly after and she spends the next two hours either laughing at their comedic dialogues, or singing along with old favorite rock songs.

~Midnight --—"We drive back to my place. I say, "Ok you can come upstairs but only for a few minutes, I have to work tomorrow." [Credit: David D.]

~12:30 AM ---We're sitting on my balcony making out. I take her by the hand, say, "Let's go make out like a couple of teenagers," and lead her back into my bedroom and fuck her.

Notice how this routine allows me to get in lots of venue changes, pass time with the girl, and also practice other bits of my game...When I need to attract, I can be cocky and playful and use hot/cold dynamics. I can keep screening and qualifying her, and I can work on comfort building and kino escalation. This all occurs within a date structure that I can repeat every week with a new girl and practice until it is tight.

And tight it is - this routine gets me laid.

Here's another date routine that I came up with recently for Saturday afternoons:

-10:30 AM - "It's such a beautiful day. I'm going to get lunch at the beach near where I live. Come over and we'll go together."

~12:00 PM --- Let her briefly upstairs and then hustle her out. Drive to the main drag and park.

~12:15 PM-----There is a billiards place that serves food. We hang out here for an hour or two, eat lunch and shoot some pool. Meanwhile continue gaming., comfort building, etc.

~ 2:00 PM ---Bounce and walk up and down the street. Go into clothes shops and try stuff on. There's one shop in particular with cool masks, wigs, etc. Go into a vintage shop and try stuff on.

~4:00 PM --After a few hours of bouncing around together, we go back to my car.

~ 4:15 PM --Swing by the store on the way home "to pick up some stuff." Get BBQ fixings. Walking around in the store together is a great way to subconsciously activate domestic couple fantasies in her lizard brain. She also gets involved in picking food out - which makes her involved in the BBQ at my place.

~5:00 PM --Get back to my place. Make a few drinks and fire up the BBQ. Watch the sunset together. Make out, etc.

Notice that all the venue changes seem perfectly spontaneous to her, even though they've all been planned out. So her experience is fun, constantly changing, and without pressure. You are leading through all of this, and practicing your date game along the way.

- Design a date plan {or several) that you can execute over and over again.
- Build the most useful logistics into the date. Design in the seven hours. Design in the venue changes. Design it so she ends up at your place.
- Do it over and over again with many girls.++ Focus on improving your skill and improving your dating routine. Don't take it too seriously.

The C3 Location



Any comfort building location within the sex location.

Not until you have built enough comfort with a woman can you jump to C3. Examples of C3 locations:

- *Sitting on couch in your living room*
- *In **whirlpool** a short distance from your bedroom or hotel room*
- *Sitting on couch in lobby near your hotel room*

Since every successful courtship will inevitably lead to the C3 location (**which** is in the sex location), before you even approach a woman in a meeting location, take efforts to secure a C3 comfort building location

++ Don't be a pervert..

The Sex Location

Most meeting locations and many comfort building locations are not appropriate settings for sexual intimacy. In order to share in mutual seduction, you will have to jump to a sex location.

A sex location is marked primarily by its privacy and should be in close proximity to a C3 comfort building location. That way you only have a short distance to move when the time comes. For example, your bedroom is very near your living room.

The best seduction location is one in which you have complete control, such as the bedroom of your own apartment or house. Few variables, such as phone calls, room mates, parents and pets will impede your success.

Consider the various benefits and limitations of the following sex location examples:

- A vehicle
- A hotel room
- A friend's living room or bedroom
- The woman's bedroom
- Your bedroom

Some C3 comfort building locations such as a private living room may also be a good sex location. If you are in such a location, you can save yourself from having to move from C3 to the sex location.

Before you assume a public toilet near an attract location is an excellent place to have sex, consider this: if your girlfriend of several years won't have sex with you in a public bathroom, don't expect a quality woman you just met to. This is only a rare fool's mate.

If you have not yet secured a sex location, take efforts to do so before you approach a woman in a meeting location. Do not leave the success of your end-game to chance.

Moving from C3 to S1



Mystery sits in his living room with a woman, showing her some short comedic home movies. They are in C3. He puts on some music, lights up the hookah and they share smoking it. He inhales the smoke from the pipe, and then exhales it into her mouth. They do this several times.

Sharing intimacy by holding each other and kissing, he now progresses their kissing into foreplay. Both aroused, he takes her by the hand, leads her into his bedroom, hands her a box of matches and says, "Here. Light the candles while I find the incense." He then says, "Can you close the blinds for me? I'm going to wash up." A minute later he returns. "Why don't you go wash up while I light the incense," he says to her, pointing out where the bathroom is.

Building the seduction scene together in this way is similar to the way long term couples regularly do. Such ritualistic behavior is familiar and comfortable.

In case it has not been made clear up until this point, do not make this move before you have properly qualified her and built comfort with her. If you do, it will activate her *anti-slut defense* or cause her to get *buyer's remorse*, or both.

Further complicating matters, if the window of opportunity is open and you miss it, it seldom opens twice for the same bird. She may go home and backwards rationalize all the reasons why it didn't happen. So, in the interests of practice and rapid improvement, when in doubt, just escalate. Even if you're wrong, it will still improve your calibration.

S2: Last-Minute Resistance

Last-minute resistance is a horrible, uncontrollable fear built right into the circuitry of most women, and it is your job to ease her through it. Having sex is a much larger risk and investment for a **woman** than it is for a man, and **LMR** is her last ring of defense before the Point of No Return.

LMR threshold differs from girl to girl, and even for a specific girl her LMR threshold will change depending on the circumstances and the value of the man she is sleeping with. Here are some common trigger points:

- Kissing
- Touching breasts
- Top removal
- Bra removal
- Pants removal
- Panties removal
- Fingering
- Oral sex (giving or receiving)

Overcoming LMR

1. *"You've hijacked my brain..."*
2. *"We should stop..."*
3. *Play solid game in the first place*
4. *Persistence*
5. *Freeze-outs*
6. *Just go to sleep*

"You've hijacked my brain..."

Often it is the case that your romantic interest doesn't feel qualified enough — she believes if she gives it up too easily, you will simply move on afterwards. This is why it's so important in A3 for her to feel that her efforts are succeeding and that she is winning you over. If this element is missing, notice that girls will freak out just poor to sex, saying things like, "Why me? Why do you like me?" and "I don't even know you..."

If you're lacking in this key element and need to compensate quickly in a logistical bind, use *"Baby I just can't stop thinking about you"* languaging to inoculate against her **LAIR** before you escalate.

'We should stop...'

The primary technique in the LMR arsenal is *token resistance, usually verbal in nature while simultaneously continuing to escalate physically*. "Baby, we should slow this down..." What is the purpose of this? What fantasy does it fulfill for her?

The ideal scenario involves a brave, intelligent heroine engaged in witty repartee with a cruelly taunting protagonist (with a heart of gold.) Sexual tension is building between them. At some point they will lose all control and ravenously consummate their flirtation. *It's not her fault*. She was overtaken by forces entirely beyond her control. Forces of Nature.

Token resistance is necessary to make that feeling real. *If you don't resist, she will*.

Notice that if *she* gives token resistance, the best response is to just agree with her and even voice it yourself. If you disagree, you are only giving her something to push against. Don't give her *traction* by way of disagreement.

Play Solid Game in the First Place

Her emotional circuitry is designed to select for a high-value man whom she trusts and is pair-bonded to her. If your game is tight, **LMR** will be greatly reduced as an issue. So examine your basic game:

1. Are you a healthy, ambitious, socially comfortable person?
2. Do you convey a lack of neediness at all times?
3. Have you otherwise demonstrated value, via pre-selection, leader-of-men switch (social intelligence and social proof), emotional stimulation, frame control, etc?
4. Has she chased, and otherwise invested in the interaction?
5. Have you been compliance testing? Do you have kino escalation and compliance?
6. Does she feel that she has earned your interest? (Have you demonstrated your "growing pairbond" for her, using qualifiers and other IOIs?)
 1. Have you built comfort and trust, and a sense of connection, over seven hours and several venue changes? Do you have jealousy?

Nearly always, if one is self-critical, it's possible to trace back to one of these points and determine what is causing the LMR.

Persistence

If you reach her **LMR** threshold, *do a slight tactical retreat and then continue*. For example, stop trying to remove her shirt; just make-out with her for a bit longer, then try the shirt again. Often the issue is just that she needs more arousal- Practice becoming attuned to a woman's feedback during foreplay.

Freeze-Outs

If the LMR seems **insurmountable**, just do a freeze-out: turn on the light, snuff out the candle, check your email, go to the kitchen to make a sandwich, or pull out a checkers board and challenge her to a game. The power of this is in its sincere delivery. If you were sulking, that would show that you were affected. But you're *unaffected*. Just switch off the arousal **circuitry** like it's *no big deal* and freeze her out sexually, then try again in ten minutes. **Freeze-outs are deadly.**

Just go to Sleep

If all else fails, just go to sleep with her. A few hours later, the two of you will awaken and have sex.#

S3: Sex

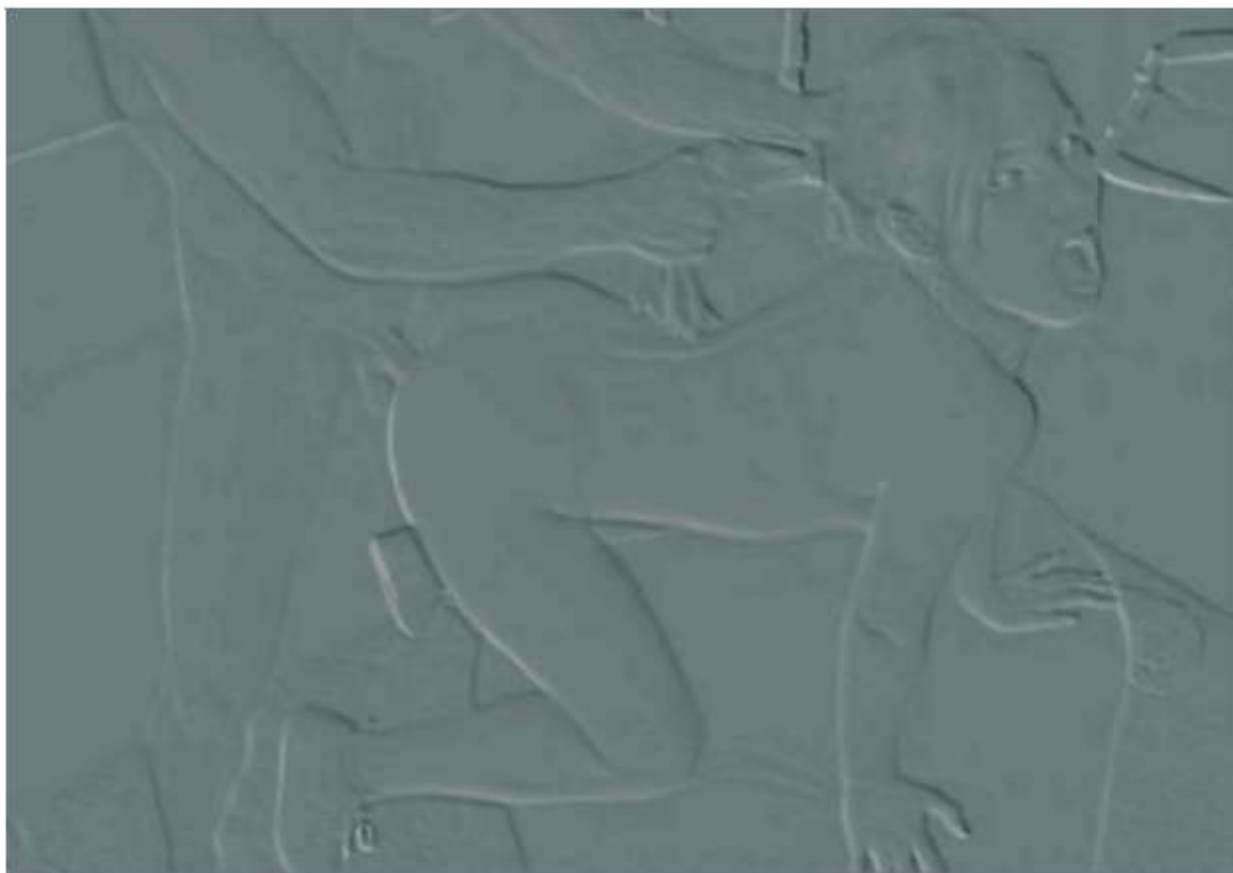

Credit to Sinn, who discovered and field-tested this tactic.

Waypoints

Whenever the venusian artist opens a set and begins the game, he is likely to encounter the same waypoints on his journey from meeting to sex.

Some waypoints are:

- Opening the set
- Hook Point (Flurry of IOIs)
- Locking-in
- "So how do you all know each other?" (optional)
- Introduction of playful kino
- "Would you like to join us?" (optional)
- She qualifies herself or otherwise chases you.
- Isolate the target for comfort-building
- Compliance threshold
- **Kissing**
- Time bridge
- "Your friend and I like each other, are you cool with that?" (optional)
- Bounce to a C2 location
- Bounce to a seduction location
- Overcoming LMR

The waypoints are important because they must all occur at some point in every set. If your game isn't where you want it to be, figure out which waypoint is giving you the most trouble and then focus your practice efforts in that area.

Sticking Points

Every venusian artist has *sticking points*, which are parts of his game that are currently causing him trouble. Even the best venusian artists have sticking points and will be eager to discuss them in order to discover new ideas for overcoming them. In fact, if someone is ever reluctant to discuss his sticking points, then likely the person is not a venusian artist at all, but a *keyboard jockey*.

Whenever your game reaches a new level, you will be confronted with new challenges and new sticking points. This process is never ending — the frustration often only increases with skill, and many will not have the patience to practice the venusian arts to mastery. To those who do, go the spoils.

Chapter Eight Review

It usually takes four to ten hours of comfort building before a woman is ready to have sex. This is known as the *Seven Hour Rule*.

Kissing is a comfort builder. Through practice it is possible to isolate and kiss girls consistently within twenty minutes of opening the set

The *C2 location* is any comfort building location that is separate from the meeting location and the sex location.

Moving from one comfort location to another is called *jumping*. There are two ways to jump: the *bounce* and the *time bridge*.

Bouncing is the act of leaving one venue and going to another one *at that time*.

If you bounce, get her number first. That way you won't appear to be settling for the number later if the bounce doesn't work out.

A *time bridge* is an agreement to see each other at a later date. This is an optional move in your game that you play only if you cannot follow the standard game plan of bouncing her for food and eventually sex.

Having solid game is more important than getting numbers. Solid game makes for solid numbers.

It's important to be practicing your game and getting lots of phone numbers. When you have five or ten numbers to call, you are much less likely to worry about *Jacking it up*. No single number ever becomes that important to you, which is exactly the right attitude.

After you get her phone number, stay and talk for a few more minutes.

Get in the habit of going through your numbers and calling them up just to chat or invite girls to whatever run activity you are currently doing.

Many girls will flake when you call them. It's *no big deal*. Just keep working on your game and keep up on your calling rotation. The game is a combination of skill (which requires practice) and luck (which requires random chance.) Both are greatly increased by playing the numbers.

If you are getting numbers, but not sex, it's useful to practice dating in a structured way. Design a date plan that you can repeat over and over again for the practice.

Build the most useful logistics into the date. Design in the seven hours. Design in the venue changes. Design it so she ends up at your place.

The *C3 location* is a comfort building location within the sex location, such as your living room or Jacuzzi.

A *sex location* is marked primarily by its privacy and should be in close proximity to a C3 location. Usually this is your bedroom.

Once you go from C3 into S1 (foreplay), you have crossed the point of no return. She will get *buyer's remorse* if you do this too soon, before enough comfort has been built.

Last-minute resistance is a fear that women experience just prior to having sex, similar to the way that men experience approach anxiety. It is your responsibility to ease her through this.

Often LMR is greatly increased as a result of weaknesses in your game. By improving your game, you also reduce LMR as an issue.

Other techniques for combating LMR are *token resistance*, *freeze-outs*, and *persistence*.

Waypoints are points in the game, such as opening or isolating, that must always be present in any set that leads to sex.

Sticking points are parts of your game that are currently causing you trouble. All venusian artists have sticking points.

Congratulations!

You have finished the Mystery Method Venusian Arts Handbook. You are now armed with some of the best information, tactics, strategies, and knowledge that the seduction community has to offer.

We've put a lot of our heart and soul into this. A couple of us have quit our jobs or taken leaves of absence to research and perfect this manual. I think we've really delivered, way above what we charge for this.

So I'll ask again — PLEASE don't share this. Obviously, you can do what you want, but put yourself in my shoes...if you'd spent most of your adult life developing and perfecting something, and wanted to share it with the world, you wouldn't want others stopping your ability to make a living out of it.

And if you have come across a "shared" or "free" version, but you think it was worth the price, please purchase a licensed copy online here: <http://www..mysterymethod.com/!XI^I-Products.aspx?action=goto&catid=2>
We're not a Fortune 500 company. We're a couple of guys trying to make life better for ourselves and our fans. What's more — if you buy a copy, you'll be eligible for free and discounted upgrades to the next version when it comes out, etc., etc.

Love,

Mystery

<http://www.mysterymethod.com>

What's next?

Once you've gotten into this material, you are probably wondering where you can go for more information. Here's what we have so far:

- Our full product line can be browsed here:
- There is a companion 5 DVD set that illustrates **many** of the concepts in this book and provides fresh information as well. With 5 hours of footage from Mystery and Lovedrop, it will answer any questions you still have and show you how to execute the tactics described here. Check it out (including free sample clips) in our DVD video library at:
<http://www.mysterymethod.com/MM-Products.aspx?action=goto&catid=1>
- There is no substitute for live seminars and workshops. Check out our upcoming schedule:
<http://www.mysterymethod.com/ProgramSchedule.aspx>
You can take a seminar, or a seminar and a workshop (where you go out to bars and coffee shops with Mystery Method instructors), or even a specialty program — like how to use magic to attract women, how to build an identity, or how to seduce strippers and hired guns.
- Consultations with Mystery Method instructors are also popular. For example, personalized, 1-1 telephone consultations are available as well as fully-customized 1-1 programs.
<http://www.mysterymethod.com/TrainingPrograms.aspx?action=goto&prog=tel>
- Write us! We'd love to hear how things are going and how we can help. Email us at info@mysterymethod.com