

# Pilot's Encyclopedia of Aeronautical Knowledge

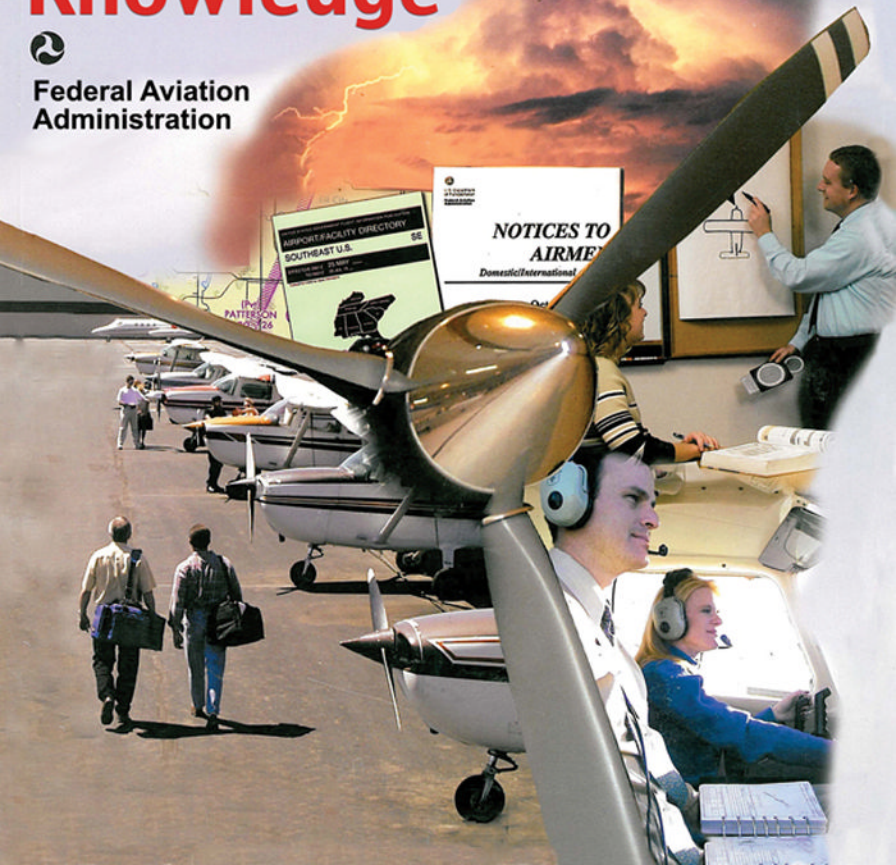

Federal Aviation  
Administration



# **PILOT'S ENCYCLOPEDIA OF AERONAUTICAL KNOWLEDGE**

**Federal Aviation Administration**



Skyhorse Publishing

Copyright © 2007 by Skyhorse Publishing, Inc.

All Rights Reserved. No part of this book may be reproduced in any manner without the express written consent of the publisher, except in the case of brief excerpts in critical reviews or articles. All inquiries should be addressed to: Skyhorse Publishing, 555 Eighth Avenue, Suite 903, New York, NY 10018.

[www.skyhorsepublishing.com](http://www.skyhorsepublishing.com)

10 9 8 7 6 5 4 3 2 1

ISBN-13: 978-1-60239-034-8

ISBN-10: 1-60239-034-7

Library of Congress Cataloging-in-Publication-Data is available on file.

Printed in China

## PREFACE

The *Pilot's Encyclopedia of Aeronautical Knowledge* provides basic knowledge that is essential for pilots. This handbook introduces pilots to the broad spectrum of knowledge that will be needed as they progress in their pilot training. Except for the Code of Federal Regulations pertinent to civil aviation, most of the knowledge areas applicable to pilot certification are presented. This handbook is useful to beginning pilots, as well as those pursuing more advanced pilot certificates.

Occasionally, the word "must" or similar language is used where the desired action is deemed critical. The use of such language is not intended to add to, interpret, or relieve a duty imposed by Title 14 of the Code of Federal Regulations (14 CFR).

It is essential for persons using this handbook to also become familiar with and apply the pertinent parts of 14 CFR and the *Aeronautical Information Manual* (AIM).

The current Flight Standards Service airman training and testing material and subject matter knowledge codes for all airman certificates and ratings can be obtained from the Flight Standards Service Web site at <http://av-info.faa.gov>.

This handbook supersedes Advisory Circular (AC) 61-23C, Pilot's Handbook of Aeronautical Knowledge, dated 1997.

This publication may be purchased from the Superintendent of Documents, U.S. Government Printing Office (GPO), Washington, DC 20402-9325, or from <http://bookstore.gpo.gov>.

This handbook is published by the U.S. Department of Transportation, Federal Aviation Administration, Airman Testing Standards Branch, AFS-630, P.O. Box 25082, Oklahoma City, OK 73125. Comments regarding this handbook should be sent in e-mail form to [AFS630comments@faa.gov](mailto:AFS630comments@faa.gov).

AC 00-2, Advisory Circular Checklist, transmits the current status of FAA advisory circulars and other flight information and publications. This checklist is available via the Internet at [http://www.faa.gov/aba/html\\_policies/ac00\\_2.html](http://www.faa.gov/aba/html_policies/ac00_2.html).



# CONTENTS

## Chapter 1—Aircraft Structure

Major Components .....	1-1
Fuselage .....	1-2
Wings .....	1-3
Empennage .....	1-4
Landing Gear .....	1-4
The Powerplant.....	1-5

## Chapter 2—Principles of Flight

Structure of the Atmosphere.....	2-1
Atmospheric Pressure .....	2-2
Effects of Pressure on Density .....	2-2
Effect of Temperature on Density .....	2-2
Effect of Humidity on Density .....	2-2
Newton's Laws of Motion and Force.....	2-2
Magnus Effect .....	2-3
Bernoulli's Principle of Pressure.....	2-3
Airfoil Design.....	2-4
Low Pressure Above.....	2-5
High Pressure Below .....	2-6
Pressure Distribution .....	2-6

## Chapter 3—Aerodynamics of Flight

Forces Acting on the Airplane.....	3-1
Thrust.....	3-2
Drag .....	3-3
Weight.....	3-5
Lift .....	3-6
Wingtip Vortices .....	3-6
Ground Effect .....	3-7
Axes of an Airplane.....	3-8
Moments and Moment Arm .....	3-9
Design Characteristics .....	3-9
Basic Concepts of Stability .....	3-10
Static Stability .....	3-10
Dynamic Stability .....	3-11
Longitudinal Stability (Pitching).....	3-11
Lateral Stability (Rolling) .....	3-14
Vertical Stability (Yawing).....	3-15
Free Directional Oscillations (Dutch Roll).....	3-16
Spiral Instability .....	3-16
Aerodynamic Forces in Flight Maneuvers ..	3-17
Forces in Turns .....	3-17
Forces in Climbs.....	3-19
Forces in Descents.....	3-19
Stalls .....	3-20
Basic Propeller Principles .....	3-21
Torque and P Factor.....	3-23
Torque Reaction.....	3-23
Corkscrew Effect .....	3-24
Gyroscopic Action .....	3-24

Asymmetric Loading (P Factor).....	3-25
Load Factors .....	3-26
Load Factors in Airplane Design.....	3-26
Load Factors in Steep Turns.....	3-27
Load Factors and Stalling Speeds .....	3-28
Load Factors and Flight Maneuvers.....	3-29
VG Diagram .....	3-30
Weight and Balance .....	3-31
Effects of Weight on Flight Performance .....	3-32
Effect of Weight on Airplane Structure ..	3-32
Effects of Weight on Stability and Controllability.....	3-33
Effect of Load Distribution .....	3-33
High Speed Flight.....	3-35
Supersonic vs. Subsonic Flow.....	3-35
Speed Ranges.....	3-35
Mach Number vs. Airspeed.....	3-36
Boundary Layer .....	3-36
Shock Waves.....	3-37
Sweepback .....	3-38
Mach Buffet Boundaries.....	3-39
Flight Controls.....	3-40

## Chapter 4—Flight Controls

Primary Flight Controls.....	4-1
Ailerons .....	4-1
Adverse Yaw.....	4-2
Differential Ailerons .....	4-2
Frise-Type Ailerons .....	4-2
Coupled Ailerons and Rudder .....	4-3
Elevator.....	4-3
T-Tail.....	4-3
Stabilator.....	4-4
Canard.....	4-5
Rudder .....	4-5
V-Tail .....	4-6
Secondary Flight Controls.....	4-6
Flaps.....	4-6
Leading Edge Devices.....	4-7
Spoilers .....	4-7
Trim Systems .....	4-8
Trim Tabs.....	4-8
Balance Tabs.....	4-8
Antiservo Tabs.....	4-8
Ground Adjustable Tabs .....	4-9
Adjustable Stabilizer .....	4-9

## Chapter 5—Aircraft Systems

Powerplant .....	5-1
Reciprocating Engines.....	5-1
Propeller.....	5-2

Fixed-Pitch Propeller.....	5-3	Turbojet.....	5-30
Adjustable-Pitch Propeller.....	5-4	Turboprop .....	5-30
Induction Systems .....	5-5	Turbofan .....	5-30
Carburetor Systems .....	5-5	Turboshaft.....	5-31
Mixture Control.....	5-5	Performance Comparison .....	5-31
Carburetor Icing.....	5-6	Turbine Engine Instruments .....	5-31
Carburetor Heat.....	5-7	Engine Pressure Ratio .....	5-32
Carburetor Air Temperature Gauge..	5-8	Exhaust Gas Temperature.....	5-32
Outside Air Temperature Gauge.....	5-8	Torquemeter.....	5-32
Fuel Injection Systems .....	5-8	N1 Indicator.....	5-32
Superchargers and Turbosuperchargers....	5-9	N2 Indicator.....	5-32
Superchargers .....	5-9	Turbine Engine Operational	
Turbosuperchargers .....	5-10	Considerations .....	5-32
System Operation .....	5-10	Engine Temperature Limitations .....	5-32
High Altitude Performance.....	5-11	Thrust Variations .....	5-32
Ignition System.....	5-11	Foreign Object Damage.....	5-32
Combustion.....	5-12	Turbine Engine Hot/Hung Start .....	5-33
Fuel Systems.....	5-13	Compressor Stalls.....	5-33
Fuel Pumps .....	5-14	Flameout .....	5-33
Fuel Primer.....	5-14	<b>Chapter 6—Flight Instruments</b>	
Fuel Tanks.....	5-14	Pitot-Static Flight Instruments.....	6-1
Fuel Gauges .....	5-14	Impact Pressure Chamber and Lines .....	6-1
Fuel Selectors .....	5-14	Static Pressure Chamber and Lines.....	6-1
Fuel Strainers, Sumps, and Drains .....	5-14	Altimeter.....	6-2
Fuel Grades.....	5-15	Principle of Operation .....	6-2
Fuel Contamination .....	5-15	Effect of Nonstandard Pressure and	
Refueling Procedures.....	5-16	Temperature .....	6-2
Starting System.....	5-16	Setting the Altimeter.....	6-3
Oil Systems.....	5-16	Altimeter Operation.....	6-4
Engine Cooling Systems .....	5-18	Types of Altitude .....	6-4
Exhaust Systems.....	5-19	Indicated Altitude .....	6-4
Electrical System.....	5-19	True Altitude.....	6-4
Hydraulic Systems.....	5-22	Absolute Altitude.....	6-4
Landing Gear .....	5-22	Pressure Altitude.....	6-4
Tricycle Landing Gear Airplanes .....	5-22	Density Altitude.....	6-5
Tailwheel Landing Gear Airplanes.....	5-23	Vertical Speed Indicator .....	6-5
Fixed and Retractable Landing Gear..	5-23	Principle of Operation .....	6-5
Brakes.....	5-23	Airspeed Indicator .....	6-6
Autopilot.....	5-23	Indicated Airspeed.....	6-6
Pressurized Airplanes .....	5-24	Calibrated Airspeed .....	6-6
Oxygen Systems .....	5-26	True Airspeed .....	6-6
Masks.....	5-27	Groundspeed.....	6-6
Diluter Demand Oxygen Systems.....	5-27	Airspeed Indicator Markings.....	6-6
Pressure Demand Oxygen Systems.....	5-27	Other Airspeed Limitations .....	6-7
Continuous Flow Oxygen System.....	5-27	Blockage of the Pitot-Static System.....	6-8
Servicing of Oxygen Systems .....	5-28	Blocked Pitot System .....	6-8
Ice Control Systems.....	5-28	Blocked Static System.....	6-8
Airfoil Ice Control.....	5-28	Gyroscopic Flight Instruments .....	6-9
Windscreen Ice Control.....	5-29	Gyroscopic Principles.....	6-9
Propeller Ice Control .....	5-29	Rigidity in Space .....	6-9
Other Ice Control Systems .....	5-29	Precession .....	6-9
Turbine Engines.....	5-29	Sources of Power.....	6-10
Types of Turbine Engines.....	5-30	Turn Indicators .....	6-10

Turn-and-Slip Indicator .....	6-11
Turn Coordinator .....	6-11
Inclinometer .....	6-11
The Attitude Indicator .....	6-12
Heading Indicator .....	6-12
Magnetic Compass .....	6-14
Compass Errors .....	6-15
Variation.....	6-15
Compass Deviation.....	6-16
Magnetic Dip .....	6-16
Using the Magnetic Compass.....	6-16
Acceleration/Deceleration Errors ...	6-16
Turning Errors .....	6-16
Vertical Card Compass .....	6-17
Outside Air Temperature Gauge.....	6-17

**Chapter 7—Flight Manuals and Other Documents**

Airplane Flight Manuals.....	7-1
Preliminary Pages.....	7-1
General (Section 1).....	7-2
Limitations (Section 2).....	7-2
Airspeed.....	7-2
Powerplant .....	7-2
Weight and Loading Distribution .....	7-2
Flight Limits .....	7-3
Placards.....	7-3
Emergency Procedures (Section 3) .....	7-3
Normal Procedures (Section 4) .....	7-3
Performance (Section 5).....	7-3
Weight and Balance/Equipment List (Section 6) .....	7-3
Systems Description (Section 7) .....	7-4
Handling, Service, and Maintenance (Section 8) .....	7-4
Supplements (Section 9).....	7-4
Safety Tips (Section 10) .....	7-5
Aircraft Documents .....	7-5
Certificate of Aircraft Registration.....	7-5
Airworthiness Certificate.....	7-6
Aircraft Maintenance.....	7-7
Aircraft Inspections .....	7-7
Annual Inspection.....	7-7
100-Hour Inspection.....	7-7
Other Inspection Programs .....	7-8
Altimeter System Inspection .....	7-8
Transponder Inspection .....	7-8
Preflight Inspections .....	7-8
Minimum Equipment Lists (MEL) and Operations with Inoperative Equipment .....	7-8
Preventive Maintenance .....	7-9
Repairs and Alterations .....	7-9
Special Flight Permits .....	7-9

Airworthiness Directives .....	7-10
Aircraft Owner/Operator Responsibilities.....	7-11

**Chapter 8—Weight and Balance**

Weight Control .....	8-1
Effects of Weight .....	8-1
Weight Changes .....	8-2
Balance, Stability, and Center of Gravity.....	8-2
Effects of Adverse Balance .....	8-2
Management of Weight and Balance Control .....	8-3
Terms and Definitions .....	8-3
Basic Principles of Weight and Balance Computations.....	8-4
Weight and Balance Restrictions.....	8-6
Determining Loaded Weight and Center of Gravity.....	8-6
Computational Method .....	8-6
Graph Method.....	8-6
Table Method.....	8-8
Computations with a Negative Arm.....	8-8
Computations with Zero Fuel Weight .....	8-9
Shifting, Adding, and Removing Weight .....	8-9
Weight Shifting .....	8-9
Weight Addition or Removal.....	8-10

**Chapter 9—Aircraft Performance**

Importance of Performance Data .....	9-1
Structure of the Atmosphere.....	9-1
Atmospheric Pressure .....	9-1
Pressure Altitude.....	9-2
Density Altitude.....	9-3
Effects of Pressure on Density .....	9-4
Effects of Temperature on Density.....	9-4
Effect of Humidity (Moisture) on Density.....	9-4
Performance .....	9-4
Straight-and-Level Flight .....	9-5
Climb Performance.....	9-6
Range Performance .....	9-8
Ground Effect .....	9-10
Region of Reversed Command .....	9-12
Runway Surface and Gradient.....	9-13
Water on the Runway and Dynamic Hydroplaning .....	9-14
Takeoff and Landing Performance .....	9-15
Takeoff Performance .....	9-15
Landing Performance .....	9-17
Performance Speeds .....	9-18
Performance Charts .....	9-19
Interpolation.....	9-20
Density Altitude Charts .....	9-20
Takeoff Charts .....	9-22
Climb and Cruise Charts .....	9-23



Crosswind and Headwind Component Chart.....	9-28
Landing Charts .....	9-29
Stall Speed Performance Charts.....	9-30
Transport Category Airplane Performance.....	9-31
Major Differences in Transport Category versus Non-Transport Category Performance Requirements....	9-31
Performance Requirements .....	9-31
Runway Requirements.....	9-32
Balanced Field Length.....	9-32
Climb Requirements.....	9-34
First Segment.....	9-35
Second Segment .....	9-35
Third or Acceleration Segment .....	9-35
Fourth or Final Segment.....	9-35
Second Segment Climb Limitations...	9-35
Air Carrier Obstacle Clearance Requirements.....	9-36
Summary of Takeoff Requirements.....	9-36
Landing Performance .....	9-37
Planning the Landing.....	9-37
Landing Requirements.....	9-37
Approach Climb Requirements .....	9-37
Landing Runway Required.....	9-37
Summary of Landing Requirements.....	9-38
Examples of Performance Charts.....	9-39

## Chapter 10—Weather Theory

Nature of the Atmosphere .....	10-1
Oxygen and the Human Body .....	10-2
Significance of Atmospheric Pressure....	10-3
Measurement of Atmospheric Pressure.....	10-3
Effect of Altitude on Atmospheric Pressure.....	10-4
Effect of Altitude on Flight .....	10-4
Effect of Differences in Air Density ..	10-5
Wind .....	10-5
The Cause of Atmosphere Circulation .....	10-5
Wind Patterns .....	10-6
Convective Currents .....	10-7
Effect of Obstructions on Wind.....	10-8
Low-Level Wind Shear .....	10-9
Wind and Pressure Representation on Surface Weather Maps.....	10-11
Atmospheric Stability.....	10-12
Inversion .....	10-13
Moisture and Temperature.....	10-13
Relative Humidity .....	10-13
Temperature/Dewpoint Relationship....	10-13
Methods By Which Air Reaches the Saturation Point .....	10-14

Dew and Frost .....	10-14
Fog .....	10-14
Clouds.....	10-15
Ceiling .....	10-17
Visibility .....	10-18
Precipitation.....	10-18
Air Masses .....	10-18
Fronts .....	10-18
Warm Front.....	10-19
Flight Toward an Approaching Warm Front.....	10-20
Cold Front.....	10-20
Fast-Moving Cold Front.....	10-21
Flight Toward an Approaching Cold Front.....	10-21
Comparison of Cold and Warm Fronts .....	10-21
Wind Shifts .....	10-21
Stationary Front .....	10-22
Occluded Front .....	10-22

## Chapter 11—Weather Reports, Forecasts, and Charts

Observations .....	11-1
Surface Aviation Weather Observations .....	11-1
Upper Air Observations .....	11-1
Radar Observations.....	11-2
Service Outlets.....	11-2
FAA Flight Service Station.....	11-2
Transcribed Information Briefing Service (TIBS).....	11-2
Direct User Access Terminal Service (DUATS).....	11-2
En Route Flight Advisory Service.....	11-2
Hazardous In-Flight Weather Advisory (HIWAS) .....	11-3
Transcribed Weather Broadcast (TWEB) .....	11-3
Weather Briefings .....	11-3
Standard Briefing.....	11-3
Abbreviated Briefing .....	11-4
Outlook Briefing.....	11-4
Aviation Weather Reports.....	11-4
Aviation Routine Weather Report (METAR) .....	11-4
Pilot Weather Reports (PIREPs).....	11-7
Radar Weather Reports (SD) .....	11-8
Aviation Forecasts .....	11-9
Terminal Aerodrome Forecasts.....	11-9
Area Forecasts .....	11-10
In-Flight Weather Advisories.....	11-12
Airman's Meteorological Information (AIRMET) .....	11-12

Significant Meteorological Information (SIGMET).....	11-12
Convective Significant Meteorological Information (WST) .....	11-12
Winds and Temperature Aloft Forecast (FD) .....	11-13
Weather Charts.....	11-14
Surface Analysis Chart .....	11-14
Weather Depiction Chart .....	11-15
Radar Summary Chart .....	11-16
Significant Weather Prognostic Charts .....	11-18

## Chapter 12—Airport Operations

Types of Airports .....	12-1
Controlled Airport .....	12-1
Uncontrolled Airport .....	12-1
Sources for Airport Data .....	12-1
Aeronautical Charts .....	12-1
Airport/Facility Directory.....	12-1
Notices to Airmen.....	12-3
Airport Markings and Signs .....	12-3
Runway Markings .....	12-3
Taxiway Markings .....	12-3
Other Markings.....	12-3
Airport Signs .....	12-3
Airport Lighting.....	12-5
Airport Beacon .....	12-5
Approach Light Systems .....	12-6
Visual Glideslope Indicators .....	12-6
Visual Approach Slope Indicator.....	12-6
Other Glidepath Systems.....	12-6
Runway Lighting .....	12-6
Runway End Identifier Lights .....	12-6
Runway Edge Lights .....	12-7
In-Runway Lighting .....	12-7
Control of Airport Lighting.....	12-7
Taxiway Lights .....	12-8
Obstruction Lights .....	12-8
Wind Direction Indicators .....	12-8
Radio Communications .....	12-8
Radio License .....	12-8
Radio Equipment .....	12-8
Lost Communication Procedures .....	12-9
Air Traffic Control Services .....	12-10
Primary Radar.....	12-10
Air Traffic Control Radar Beacon System .....	12-11
Transponder .....	12-11
Radar Traffic Information Service.....	12-11
Wake Turbulence .....	12-12
Vortex Generation.....	12-13
Vortex Strength.....	12-13

Vortex Behavior.....	12-13
Vortex Avoidance Procedures.....	12-13
Collision Avoidance.....	12-14
Clearing Procedures.....	12-14
Runway Incursion Avoidance.....	12-14

## Chapter 13—Airspace

Controlled Airspace .....	13-1
Class A Airspace .....	13-1
Class B Airspace.....	13-1
Class C Airspace.....	13-1
Class D Airspace .....	13-3
Class E Airspace .....	13-3
Uncontrolled Airspace .....	13-3
Class G Airspace .....	13-3
Special Use Airspace .....	13-3
Prohibited Areas .....	13-3
Restricted Areas.....	13-3
Warning Areas .....	13-4
Military Operation Areas.....	13-4
Alert Areas.....	13-4
Controlled Firing Areas .....	13-4
Other Airspace Areas.....	13-4
Airport Advisory Areas .....	13-4
Military Training Routes .....	13-4
Temporary Flight Restrictions.....	13-4
Parachute Jump Areas .....	13-4
Published VFR Routes .....	13-4
Terminal Radar Service Areas.....	13-5
National Security Areas.....	13-5

## Chapter 14—Navigation

Aeronautical Charts .....	14-1
Sectional Charts.....	14-1
Visual Flight Rule Terminal Area Charts.....	14-1
World Aeronautical Charts .....	14-1
Latitude and Longitude (Meridians and Parallels) .....	14-2
Time Zones .....	14-2
Measurement of Direction.....	14-3
Variation.....	14-4
Deviation .....	14-5
Effect of Wind .....	14-6
Basic Calculations .....	14-8
Converting Minutes to Equivalent Hours .....	14-8
Converting Knots to Miles Per Hour .....	14-8
Fuel Consumption .....	14-8
Flight Computers .....	14-8
Plotter.....	14-8
Pilotage .....	14-10

Dead Reckoning .....	14-10
The Wind Triangle or Vector	
Analysis .....	14-10
Flight Planning .....	14-13
Assembling Necessary Material .....	14-13
Weather Check.....	14-13
Use of the Airport/Facility Directory ...	14-13
Airplane Flight Manual or Pilot's	
Operating Handbook .....	14-13
Charting the Course.....	14-14
Steps in Charting the Course.....	14-14
Filing a VFR Flight Plan .....	14-16
Radio Navigation.....	14-17
Very High Frequency (VHF)	
Omnidirectional Range (VOR) .....	14-18
Using the VOR .....	14-19
Tracking with VOR .....	14-20
Tips On Using the VOR .....	14-21
Distance Measuring Equipment .....	14-21
VOR/DME RNAV .....	14-21
Automatic Direction Finder .....	14-22
Loran-C Navigation.....	14-24
Global Position System .....	14-26
Lost Procedures .....	14-27
Flight Diversion.....	14-27

### **Chapter 15—Aeromedical Factors**

Obtaining a Medical Certificate .....	15-1
Environmental and Health Factors	
Affecting Pilot Performance.....	15-2
Hypoxia .....	15-2
Hypoxic Hypoxia.....	15-2
Hypemic Hypoxia.....	15-2
Stagnant Hypoxia .....	15-2
Histotoxic Hypoxia.....	15-2
Symptoms of Hypoxia.....	15-2
Hyperventilation .....	15-3
Middle Ear and Sinus Problems.....	15-3

Spatial Disorientation and Illusions .....	15-4
Motion Sickness .....	15-6
Carbon Monoxide Poisoning.....	15-6
Stress.....	15-6
Fatigue .....	15-7
Dehydration and Heatstroke .....	15-7
Alcohol .....	15-8
Drugs .....	15-8
Scuba Diving .....	15-9
Vision in Flight.....	15-9
Empty-Field Myopia .....	15-10
Night Vision.....	15-10
Night Vision Illusions .....	15-11
Autokinesis .....	15-11
False Horizon.....	15-11
Night Landing Illusions.....	15-12

### **Chapter 16—Aeronautical Decision Making**

Origins of ADM Training .....	16-2
The Decision-Making Process.....	16-2
Defining the Problem .....	16-2
Choosing a Course of Action .....	16-3
Implementing the Decision and	
Evaluating the Outcome .....	16-4
Risk Management.....	16-4
Assessing Risk.....	16-5
Factors Affecting Decision Making .....	16-5
Pilot Self-Assessment.....	16-5
Recognizing Hazardous Attitudes .....	16-6
Stress Management.....	16-6
Use of Resources .....	16-7
Internal Resources .....	16-7
External Resources .....	16-8
Workload Management.....	16-8
Situational Awareness.....	16-8
Obstacles to Maintaining Situational	
Awareness .....	16-9
Operational Pitfalls.....	16-9

# Chapter 1



## Aircraft Structure

According to the current Title 14 of the Code of Federal Regulations (14 CFR) part 1, Definitions and Abbreviations, an **aircraft** is a device that is used, or intended to be used, for flight. Categories of aircraft for certification of airmen include airplane, rotorcraft, lighter-than-air, powered-lift, and glider. Part 1 also defines **airplane** as an engine-driven, fixed-wing aircraft heavier than air that is supported in flight by the dynamic reaction of air against its wings. This chapter

**Aircraft**—A device that is used for flight in the air.

**Airplane**—An engine-driven, fixed-wing aircraft heavier than air that is supported in flight by the dynamic reaction of air against its wings.

provides a brief introduction to the airplane and its major components.

### MAJOR COMPONENTS

Although airplanes are designed for a variety of purposes, most of them have the same major components. The overall characteristics are largely determined by the original design objectives. Most airplane structures include a fuselage, wings, an empennage, landing gear, and a powerplant. [Figure 1-1]

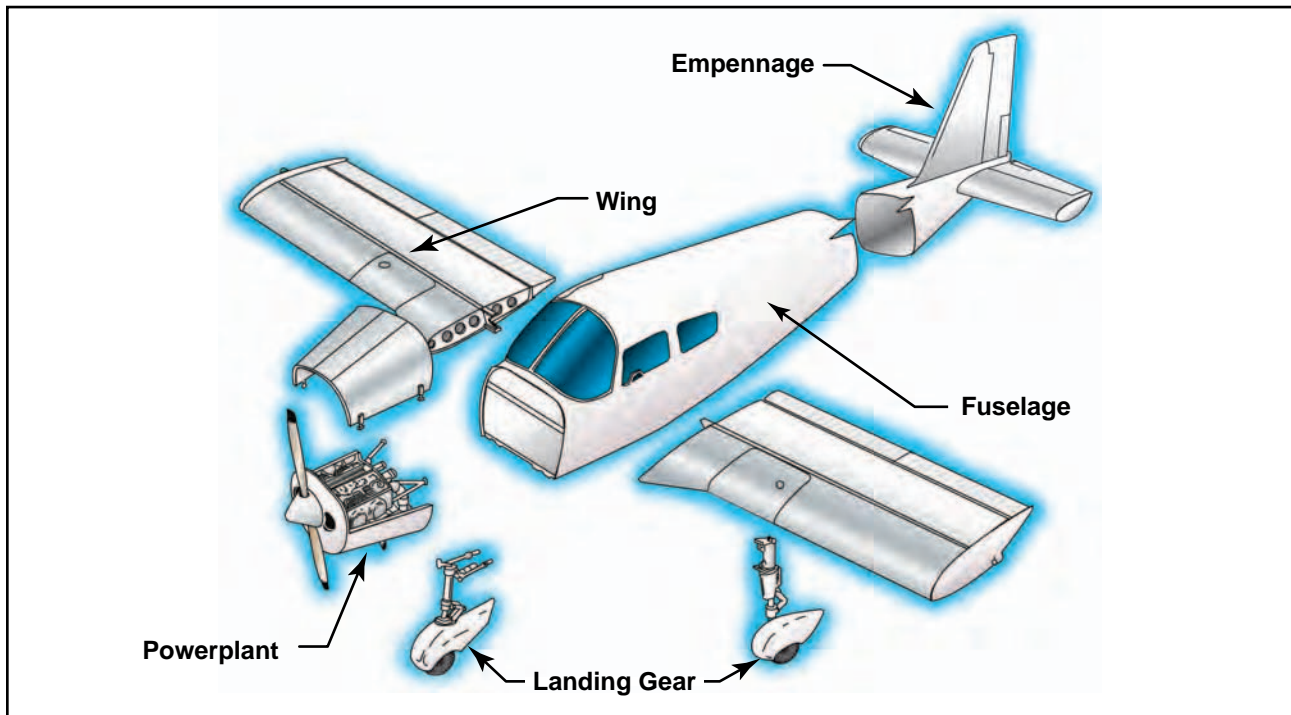

Figure 1-1. Airplane components.

## FUSELAGE

The fuselage includes the cabin and/or cockpit, which contains seats for the occupants and the controls for the airplane. In addition, the fuselage may also provide room for cargo and attachment points for the other major airplane components. Some aircraft utilize an open **truss** structure. The truss-type fuselage is constructed of steel or aluminum tubing. Strength and rigidity is achieved by welding the tubing together into a series of triangular shapes, called trusses. [Figure 1-2]

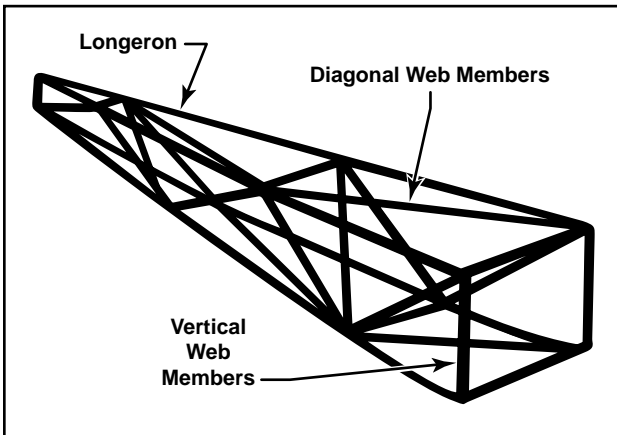

Figure 1-2. The Warren truss.

Construction of the Warren truss features longerons, as well as diagonal and vertical web members. To reduce weight, small airplanes generally utilize aluminum alloy tubing, which may be riveted or bolted into one piece with cross-bracing members.

As technology progressed, aircraft designers began to enclose the truss members to streamline the airplane and improve performance. This was originally accomplished with cloth fabric, which eventually gave way to lightweight metals such as aluminum. In some cases, the outside skin can support all or a major portion of the flight loads. Most modern aircraft use a form of this stressed skin structure known as monocoque or semi-monocoque construction.

The **monocoque** design uses stressed skin to support almost all imposed loads. This structure can be very strong but cannot tolerate dents or deformation of the surface. This characteristic is easily demonstrated by a thin aluminum beverage can. You can exert considerable force to the ends of the can without causing any damage.

**Truss**—A fuselage design made up of supporting structural members that resist deformation by applied loads.

**Monocoque**—A shell-like fuselage design in which the stressed outer skin is used to support the majority of imposed stresses. Monocoque fuselage design may include bulkheads but not stringers.

However, if the side of the can is dented only slightly, the can will collapse easily. The true monocoque construction mainly consists of the skin, formers, and bulkheads. The formers and bulkheads provide shape for the fuselage. [Figure 1-3]

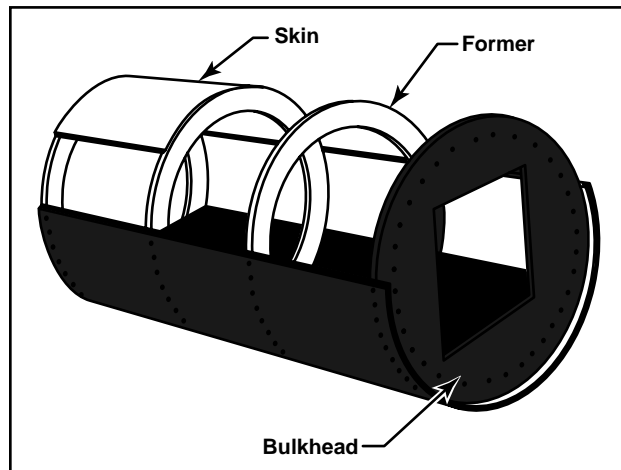

Figure 1-3. Monocoque fuselage design.

Since no bracing members are present, the skin must be strong enough to keep the fuselage rigid. Thus, a significant problem involved in monocoque construction is maintaining enough strength while keeping the weight within allowable limits. Due to the limitations of the monocoque design, a semi-monocoque structure is used on many of today's aircraft.

The **semi-monocoque** system uses a substructure to which the airplane's skin is attached. The substructure, which consists of bulkheads and/or formers of various sizes and stringers, reinforces the stressed skin by taking some of the bending stress from the fuselage. The main section of the fuselage also includes wing attachment points and a firewall. [Figure 1-4]

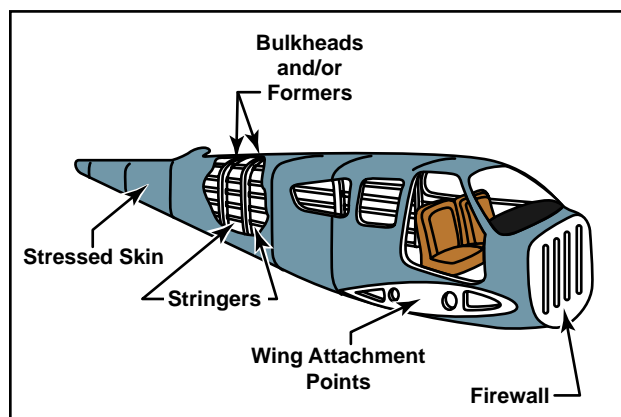

Figure 1-4. Semi-monocoque construction.

**Semi-Monocoque**—A fuselage design that includes a substructure of bulkheads and/or formers, along with stringers, to support flight loads and stresses imposed on the fuselage.

On single-engine airplanes, the engine is usually attached to the front of the fuselage. There is a fireproof partition between the rear of the engine and the cockpit or cabin to protect the pilot and passengers from accidental engine fires. This partition is called a firewall and is usually made of heat-resistant material such as stainless steel.

## WINGS

The wings are **airfoils** attached to each side of the fuselage and are the main lifting surfaces that support the airplane in flight. There are numerous wing designs, sizes, and shapes used by the various manufacturers. Each fulfills a certain need with respect to the expected performance for the particular airplane. How the wing produces lift is explained in subsequent chapters.

Wings may be attached at the top, middle, or lower portion of the fuselage. These designs are referred to as high-, mid-, and low-wing, respectively. The number of wings can also vary. Airplanes with a single set of wings are referred to as **monoplanes**, while those with two sets are called **biplanes**. [Figure 1-5]

Many high-wing airplanes have external braces, or wing struts, which transmit the flight and landing loads

**Airfoil**—An airfoil is any surface, such as a wing, propeller, rudder, or even a trim tab, which provides aerodynamic force when it interacts with a moving stream of air.

**Monoplane**—An airplane that has only one main lifting surface or wing, usually divided into two parts by the fuselage.

**Biplane**—An airplane that has two main airfoil surfaces or wings on each side of the fuselage, one placed above the other.

through the struts to the main fuselage structure. Since the wing struts are usually attached approximately halfway out on the wing, this type of wing structure is called semi-cantilever. A few high-wing and most low-wing airplanes have a full cantilever wing designed to carry the loads without external struts.



Figure 1-5. Monoplane and biplane.

The principal structural parts of the wing are spars, ribs, and stringers. [Figure 1-6] These are reinforced by

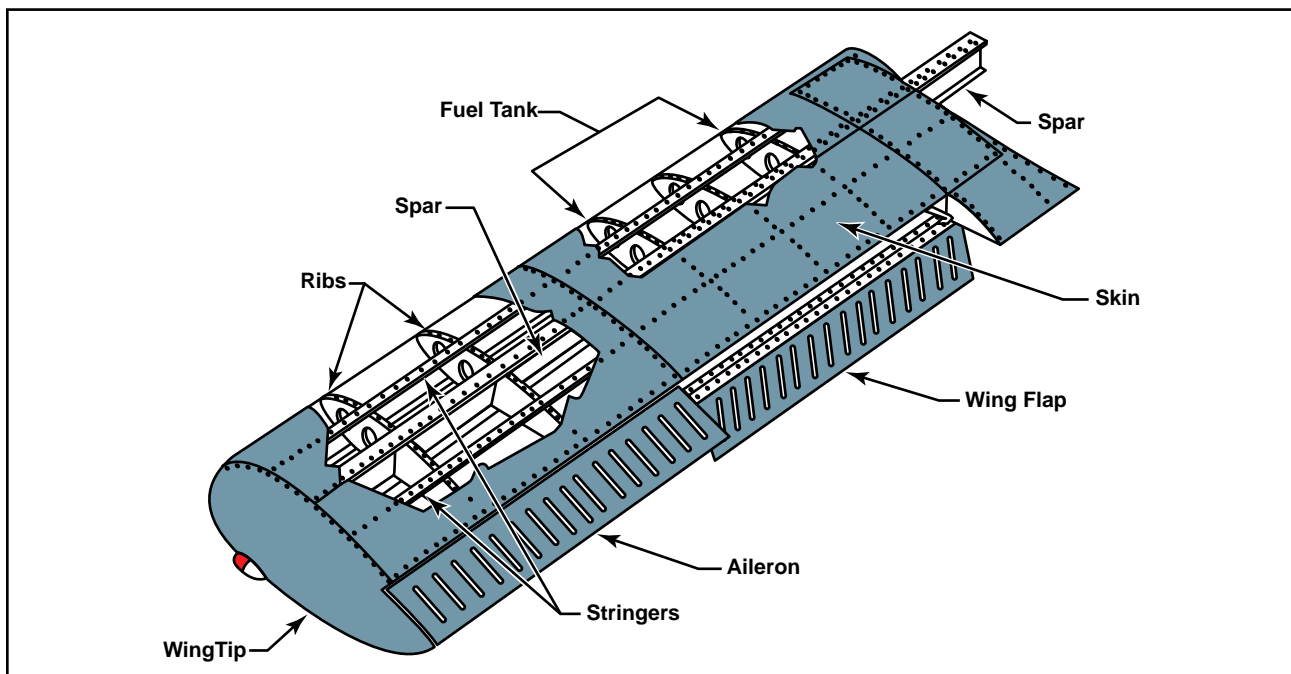

Figure 1-6. Wing components.

trusses, I-beams, tubing, or other devices, including the skin. The wing ribs determine the shape and thickness of the wing (airfoil). In most modern airplanes, the fuel tanks either are an integral part of the wing's structure, or consist of flexible containers mounted inside of the wing.

Attached to the rear, or trailing, edges of the wings are two types of control surfaces referred to as ailerons and flaps. Ailerons extend from about the midpoint of each wing outward toward the tip and move in opposite directions to create aerodynamic forces that cause the airplane to roll. Flaps extend outward from the fuselage to near the midpoint of each wing. The flaps are normally flush with the wing's surface during cruising flight. When extended, the flaps move simultaneously downward to increase the lifting force of the wing for takeoffs and landings.

## EMPENNAGE

The correct name for the tail section of an airplane is empennage. The **empennage** includes the entire tail group, consisting of fixed surfaces such as the vertical stabilizer and the horizontal stabilizer. The movable surfaces include the rudder, the elevator, and one or more trim tabs. [Figure 1-7]

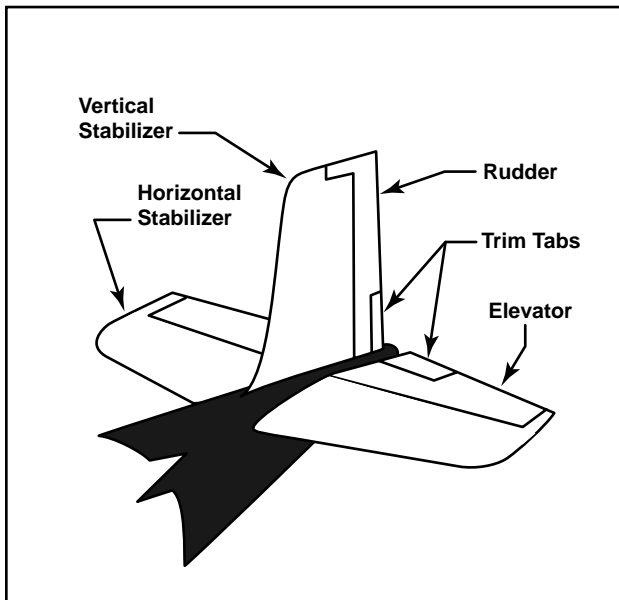

Figure 1-7. Empennage components.

**Empennage**—The section of the airplane that consists of the vertical stabilizer, the horizontal stabilizer, and the associated control surfaces.

A second type of empennage design does not require an elevator. Instead, it incorporates a one-piece horizontal stabilizer that pivots from a central hinge point. This type of design is called a stabilator, and is moved using the control wheel, just as you would the elevator. For example, when you pull back on the control wheel, the stabilator pivots so the trailing edge moves up. This increases the aerodynamic tail load and causes the nose of the airplane to move up. Stabilators have an antiservo tab extending across their trailing edge. [Figure 1-8]

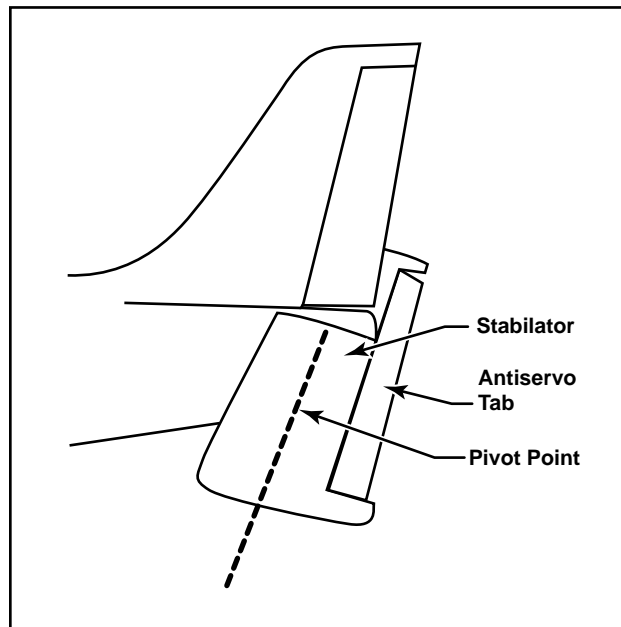

Figure 1-8. Stabilator components.

The antiservo tab moves in the same direction as the trailing edge of the stabilator. The antiservo tab also functions as a trim tab to relieve control pressures and helps maintain the stabilator in the desired position.

The rudder is attached to the back of the vertical stabilizer. During flight, it is used to move the airplane's nose left and right. The rudder is used in combination with the ailerons for turns during flight. The elevator, which is attached to the back of the horizontal stabilizer, is used to move the nose of the airplane up and down during flight.

Trim tabs are small, movable portions of the trailing edge of the control surface. These movable trim tabs, which are controlled from the cockpit, reduce control pressures. Trim tabs may be installed on the ailerons, the rudder, and/or the elevator.

## LANDING GEAR

The landing gear is the principle support of the airplane when parked, taxiing, taking off, or when landing. The

most common type of landing gear consists of wheels, but airplanes can also be equipped with floats for water operations, or skis for landing on snow. [Figure 1-9]



Figure 1-9. Landing gear.

The landing gear consists of three wheels—two main wheels and a third wheel positioned either at the front or rear of the airplane. Landing gear employing a rear-mounted wheel is called conventional landing gear. Airplanes with conventional landing gear are sometimes referred to as tailwheel airplanes. When the third wheel is located on the nose, it is called a nosewheel, and the design is referred to as a tricycle gear. A steerable nosewheel or tailwheel permits the airplane to be controlled throughout all operations while on the ground.

## THE POWERPLANT

The powerplant usually includes both the engine and the propeller. The primary function of the engine is to provide the power to turn the propeller. It also generates electrical power, provides a vacuum source for some flight instruments, and in most single-engine

airplanes, provides a source of heat for the pilot and passengers. The engine is covered by a cowling, or in the case of some airplanes, surrounded by a nacelle. The purpose of the cowling or nacelle is to streamline the flow of air around the engine and to help cool the engine by ducting air around the cylinders. The propeller, mounted on the front of the engine, translates the rotating force of the engine into a forward-acting force called thrust that helps move the airplane through the air. [Figure 1-10]

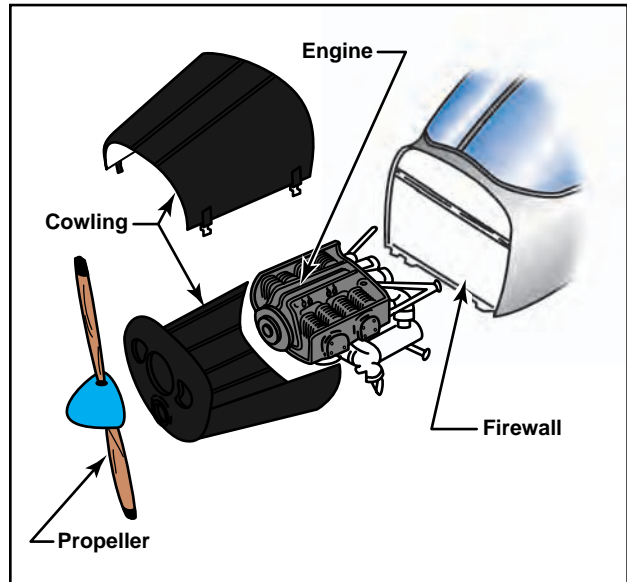

Figure 1-10. Engine compartment.

**Nacelle**—A streamlined enclosure on an aircraft in which an engine is mounted. On multiengine propeller-driven airplanes, the nacelle is normally mounted on the leading edge of the wing.





# Chapter 2

## Principles of Flight

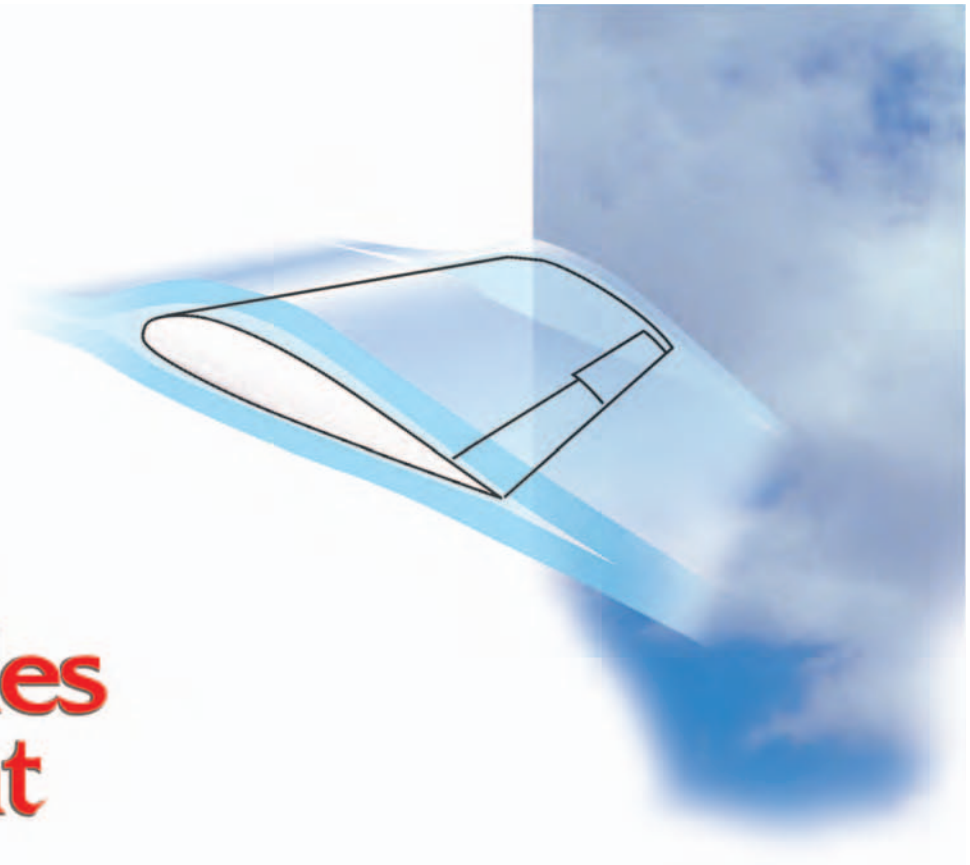

This chapter discusses the fundamental physical laws governing the forces acting on an airplane in flight, and what effect these natural laws and forces have on the performance characteristics of airplanes. To competently control the airplane, the pilot must understand the principles involved and learn to utilize or counteract these natural forces.

Modern general aviation airplanes have what may be considered high performance characteristics. Therefore, it is increasingly necessary that pilots appreciate and understand the principles upon which the art of flying is based.

### **STRUCTURE OF THE ATMOSPHERE**

The atmosphere in which flight is conducted is an envelope of air that surrounds the earth and rests upon its surface. It is as much a part of the earth as the seas or the land. However, air differs from land and water inasmuch as it is a mixture of gases. It has mass, weight, and indefinite shape.

Air, like any other fluid, is able to flow and change its shape when subjected to even minute pressures because of the lack of strong molecular cohesion. For example, gas will completely fill any container into which it is placed, expanding or contracting to adjust its shape to the limits of the container.

The atmosphere is composed of 78 percent nitrogen, 21 percent oxygen, and 1 percent other gases, such as argon or helium. As some of these elements are heavier than others, there is a natural tendency of these heavier elements, such as oxygen, to settle to the surface of the earth, while the lighter elements are lifted up to the region of higher altitude. This explains why most of the oxygen is contained below 35,000 feet altitude.

Because air has mass and weight, it is a body, and as a body, it reacts to the scientific laws of bodies in the same manner as other gaseous bodies. This body of air resting upon the surface of the earth has weight and at sea level develops an average pressure of 14.7 pounds on each square inch of surface, or 29.92 inches of

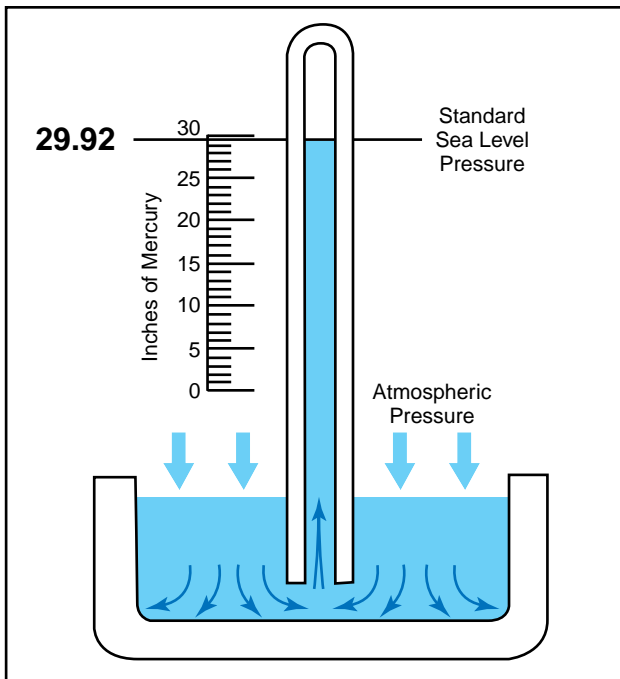

Figure 2-1. Standard sea level pressure.

mercury—but as its thickness is limited, the higher the altitude, the less air there is above. For this reason, the weight of the atmosphere at 18,000 feet is only one-half what it is at sea level. [Figure 2-1]

## ATMOSPHERIC PRESSURE

Though there are various kinds of pressure, this discussion is mainly concerned with atmospheric pressure. It is one of the basic factors in weather changes, helps to lift the airplane, and actuates some of the important flight instruments in the airplane. These instruments are the altimeter, the airspeed indicator, the rate-of-climb indicator, and the manifold pressure gauge.

Though air is very light, it has mass and is affected by the attraction of gravity. Therefore, like any other substance, it has weight, and because of its weight, it has force. Since it is a fluid substance, this force is exerted equally in all directions, and its effect on bodies within the air is called pressure. Under standard conditions at sea level, the average pressure exerted on the human body by the weight of the atmosphere around it is approximately 14.7 lb./in. The density of air has significant effects on the airplane's capability. As air becomes less dense, it reduces (1) power because the engine takes in less air, (2) thrust because the propeller is less efficient in thin air, and (3) lift because the thin air exerts less force on the airfoils.

## EFFECTS OF PRESSURE ON DENSITY

Since air is a gas, it can be compressed or expanded. When air is compressed, a greater amount of air can

occupy a given volume. Conversely, when pressure on a given volume of air is decreased, the air expands and occupies a greater space. That is, the original column of air at a lower pressure contains a smaller mass of air. In other words, the density is decreased. In fact, density is directly proportional to pressure. If the pressure is doubled, the density is doubled, and if the pressure is lowered, so is the density. This statement is true, only at a constant temperature.

## EFFECT OF TEMPERATURE ON DENSITY

The effect of increasing the temperature of a substance is to decrease its density. Conversely, decreasing the temperature has the effect of increasing the density. Thus, the density of air varies inversely as the absolute temperature varies. This statement is true, only at a constant pressure.

In the atmosphere, both temperature and pressure decrease with altitude, and have conflicting effects upon density. However, the fairly rapid drop in pressure as altitude is increased usually has the dominating effect. Hence, density can be expected to decrease with altitude.

## EFFECT OF HUMIDITY ON DENSITY

The preceding paragraphs have assumed that the air was perfectly dry. In reality, it is never completely dry. The small amount of water vapor suspended in the atmosphere may be almost negligible under certain conditions, but in other conditions humidity may become an important factor in the performance of an airplane. Water vapor is lighter than air; consequently, moist air is lighter than dry air. It is lightest or least dense when, in a given set of conditions, it contains the maximum amount of water vapor. The higher the temperature, the greater amount of water vapor the air can hold. When comparing two separate air masses, the first warm and moist (both qualities tending to lighten the air) and the second cold and dry (both qualities making it heavier), the first necessarily must be less dense than the second. Pressure, temperature, and humidity have a great influence on airplane performance, because of their effect upon density.

## NEWTON'S LAWS OF MOTION AND FORCE

In the 17th century, a philosopher and mathematician, Sir Isaac Newton, propounded three basic laws of motion. It is certain that he did not have the airplane in mind when he did so, but almost everything known about motion goes back to his three simple laws. These laws, named after Newton, are as follows:

**Newton's first law** states, in part, that: A body at rest tends to remain at rest, and a body in motion tends to

remain moving at the same speed and in the same direction.

This simply means that, in nature, nothing starts or stops moving until some outside force causes it to do so. An airplane at rest on the ramp will remain at rest unless a force strong enough to overcome its inertia is applied. Once it is moving, however, its inertia keeps it moving, subject to the various other forces acting on it. These forces may add to its motion, slow it down, or change its direction.

**Newton's second law** implies that: When a body is acted upon by a constant force, its resulting acceleration is inversely proportional to the mass of the body and is directly proportional to the applied force.

What is being dealt with here are the factors involved in overcoming Newton's First Law of Inertia. It covers both changes in direction and speed, including starting up from rest (positive acceleration) and coming to a stop (negative acceleration, or deceleration).

**Newton's third law** states that: Whenever one body exerts a force on another, the second body always exerts on the first, a force that is equal in magnitude but opposite in direction.

The recoil of a gun as it is fired is a graphic example of Newton's third law. The champion swimmer who pushes against the side of the pool during the turnaround, or the infant learning to walk—both would fail but for the phenomena expressed in this law. In an airplane, the propeller moves and pushes back the air; consequently, the air pushes the propeller (and thus the airplane) in the opposite direction—forward. In a jet airplane, the engine pushes a blast of hot gases backward; the force of equal and opposite reaction pushes against the engine and forces the airplane forward. The movement of all vehicles is a graphic illustration of Newton's third law.

## MAGNUS EFFECT

The explanation of lift can best be explained by looking at a cylinder rotating in an airstream. The local velocity near the cylinder is composed of the airstream velocity and the cylinder's rotational velocity, which decreases with distance from the cylinder. On a cylinder, which is rotating in such a way that the top surface area is rotating in the same direction as the airflow, the local velocity at the surface is high on top and low on the bottom.

As shown in figure 2-2, at point "A," a stagnation point exists where the airstream line that impinges on the surface splits; some air goes over and some under. Another stagnation point exists at "B," where the two

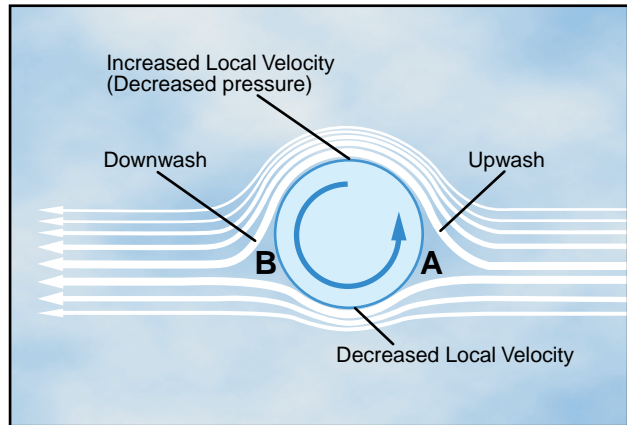
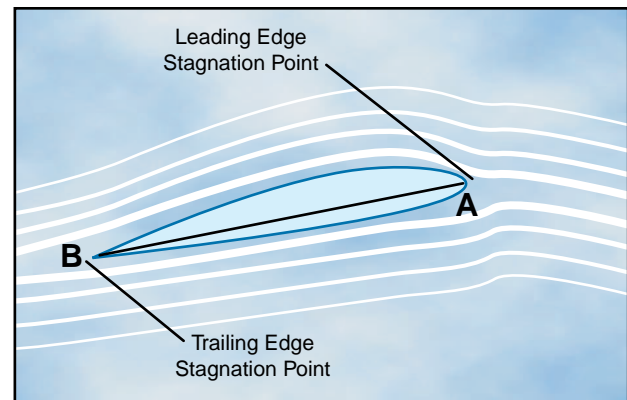

**Figure 2-2. Magnus Effect is a lifting force produced when a rotating cylinder produces a pressure differential. This is the same effect that makes a baseball curve or a golf ball slice.**

airstreams rejoin and resume at identical velocities. We now have upwash ahead of the rotating cylinder and downwash at the rear.

The difference in surface velocity accounts for a difference in pressure, with the pressure being lower on the top than the bottom. This low pressure area produces an upward force known as the "Magnus Effect." This mechanically induced circulation illustrates the relationship between circulation and lift.

An airfoil with a positive angle of attack develops air circulation as its sharp trailing edge forces the rear stagnation point to be aft of the trailing edge, while the front stagnation point is below the leading edge. [Figure 2-3]



**Figure 2-3. Air circulation around an airfoil occurs when the front stagnation point is below the leading edge and the aft stagnation point is beyond the trailing edge.**

## BERNOULLI'S PRINCIPLE OF PRESSURE

A half century after Sir Newton presented his laws, Mr. Daniel Bernoulli, a Swiss mathematician, explained how the pressure of a moving fluid (liquid or gas) varies with its speed of motion. Specifically,

he stated that an increase in the speed of movement or flow would cause a decrease in the fluid's pressure. This is exactly what happens to air passing over the curved top of the airplane wing.

An appropriate analogy can be made with water flowing through a garden hose. Water moving through a hose of constant diameter exerts a uniform pressure on the hose; but if the diameter of a section of the hose is increased or decreased, it is certain to change the pressure of the water at that point. Suppose the hose was pinched, thereby constricting the area through which the water flows. Assuming that the same volume of water flows through the constricted portion of the hose in the same period of time as before the hose was pinched, it follows that the speed of flow must increase at that point.

Therefore, if a portion of the hose is constricted, it not only increases the speed of the flow, but also decreases the pressure at that point. Like results could be achieved if streamlined solids (airfoils) were introduced at the same point in the hose. This same principle is the basis for the measurement of airspeed (fluid flow) and for analyzing the airfoil's ability to produce lift.

A practical application of Bernoulli's theorem is the venturi tube. The venturi tube has an air inlet which narrows to a throat (constricted point) and an outlet section which increases in diameter toward the rear. The diameter of the outlet is the same as that of the inlet. At the throat, the airflow speeds up and the pressure decreases; at the outlet, the airflow slows and the pressure increases. [Figure 2-4]

If air is recognized as a body and it is accepted that it must follow the above laws, one can begin to see how and why an airplane wing develops lift as it moves through the air.

## AIRFOIL DESIGN

In the sections devoted to Newton's and Bernoulli's discoveries, it has already been discussed in general

terms the question of how an airplane wing can sustain flight when the airplane is heavier than air. Perhaps the explanation can best be reduced to its most elementary concept by stating that lift (flight) is simply the result of fluid flow (air) about an airfoil—or in everyday language, the result of moving an airfoil (wing), by whatever means, through the air.

Since it is the airfoil which harnesses the force developed by its movement through the air, a discussion and explanation of this structure, as well as some of the material presented in previous discussions on Newton's and Bernoulli's laws, will be presented.

An airfoil is a structure designed to obtain reaction upon its surface from the air through which it moves or that moves past such a structure. Air acts in various ways when submitted to different pressures and velocities; but this discussion will be confined to the parts of an airplane that a pilot is most concerned with in flight—namely, the airfoils designed to produce lift. By looking at a typical airfoil profile, such as the cross section of a wing, one can see several obvious characteristics of design. [Figure 2-5] Notice that there is a difference in the curvatures of the upper and lower surfaces of the airfoil (the curvature is called camber). The camber of the upper surface is more pronounced than that of the lower surface, which is somewhat flat in most instances.

In figure 2-5, note that the two extremities of the airfoil profile also differ in appearance. The end which faces forward in flight is called the leading edge, and is rounded; while the other end, the trailing edge, is quite narrow and tapered.

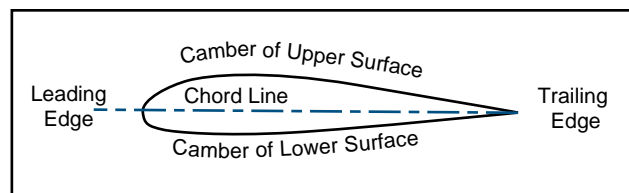

Figure 2-5. Typical airfoil section.

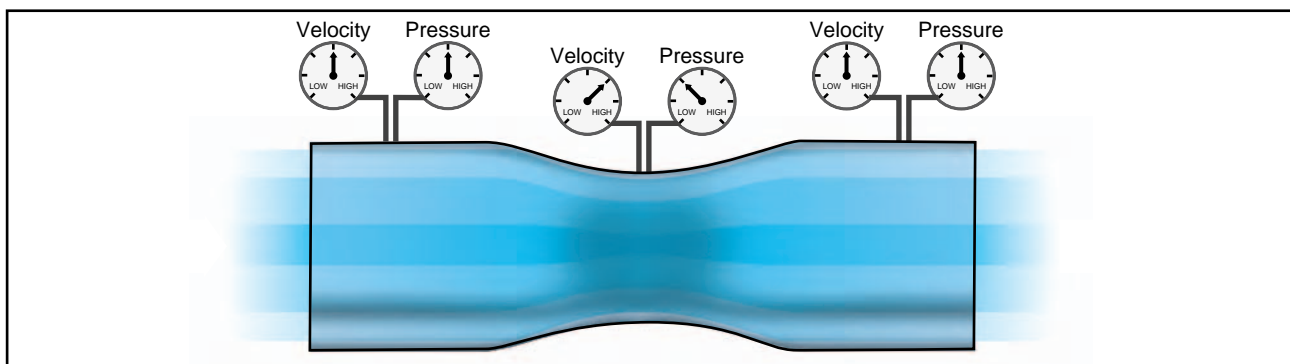

Figure 2-4. Air pressure decreases in a venturi.

A reference line often used in discussing the airfoil is the chord line, a straight line drawn through the profile connecting the extremities of the leading and trailing edges. The distance from this chord line to the upper and lower surfaces of the wing denotes the magnitude of the upper and lower camber at any point. Another reference line, drawn from the leading edge to the trailing edge, is the “mean camber line.” This mean line is equidistant at all points from the upper and lower contours.

The construction of the wing, so as to provide actions greater than its weight, is done by shaping the wing so that advantage can be taken of the air’s response to certain physical laws, and thus develop two actions from the air mass; a positive pressure lifting action from the air mass below the wing, and a negative pressure lifting action from lowered pressure above the wing.

As the airstream strikes the relatively flat lower surface of the wing when inclined at a small angle to its direction of motion, the air is forced to rebound downward and therefore causes an upward reaction in positive lift, while at the same time airstream striking the upper curved section of the “leading edge” of the wing is deflected upward. In other words, a wing shaped to cause an action on the air, and forcing it downward, will provide an equal reaction from the air, forcing the wing upward. If a wing is constructed in such form that it will cause a lift force greater than the weight of the airplane, the airplane will fly.

However, if all the lift required were obtained merely from the deflection of air by the lower surface of the wing, an airplane would need only a flat wing like a kite. This, of course, is not the case at all; under certain conditions disturbed air currents circulating at the trailing edge of the wing could be so excessive as to make the airplane lose speed and lift. The balance of the lift needed to support the airplane comes from the flow of air above the wing. Herein lies the key to flight. The fact that most lift is the result of the airflow’s downwash from above the wing, must be thoroughly understood in order to continue further in the study of flight. It is neither accurate nor does it serve a useful purpose, however, to assign specific values to the percentage of lift generated by the upper surface of an airfoil versus that generated by the lower surface. These are not constant values and will vary, not only with flight conditions, but with different wing designs.

It should be understood that different airfoils have different flight characteristics. Many thousands of airfoils have been tested in wind tunnels and in actual flight, but no one airfoil has been found that satisfies every flight requirement. The weight, speed, and

purpose of each airplane dictate the shape of its airfoil. It was learned many years ago that the most efficient airfoil for producing the greatest lift was one that had a concave, or “scooped out” lower surface. Later it was also learned that as a fixed design, this type of airfoil sacrificed too much speed while producing lift and, therefore, was not suitable for high-speed flight. It is interesting to note, however, that through advanced progress in engineering, today’s high-speed jets can again take advantage of the concave airfoil’s high lift characteristics. Leading edge (Kreuger) flaps and trailing edge (Fowler) flaps, when extended from the basic wing structure, literally change the airfoil shape into the classic concave form, thereby generating much greater lift during slow flight conditions.

On the other hand, an airfoil that is perfectly streamlined and offers little wind resistance sometimes does not have enough lifting power to take the airplane off the ground. Thus, modern airplanes have airfoils which strike a medium between extremes in design, the shape varying according to the needs of the airplane for which it is designed. Figure 2-6 shows some of the more common airfoil sections.

## LOW PRESSURE ABOVE

In a wind tunnel or in flight, an airfoil is simply a streamlined object inserted into a moving stream of air. If the airfoil profile were in the shape of a teardrop, the speed and the pressure changes of the air passing over the top and bottom would be the same on both sides. But if the teardrop shaped airfoil were cut in half lengthwise, a form resembling the basic airfoil (wing) section would result. If the airfoil were then inclined so the airflow strikes it at an angle (angle of attack), the air molecules moving over the upper surface would be forced to move faster than would the molecules moving along the bottom of the airfoil, since the upper molecules must travel a greater distance due to the curvature of the upper surface. This increased velocity reduces the pressure above the airfoil.

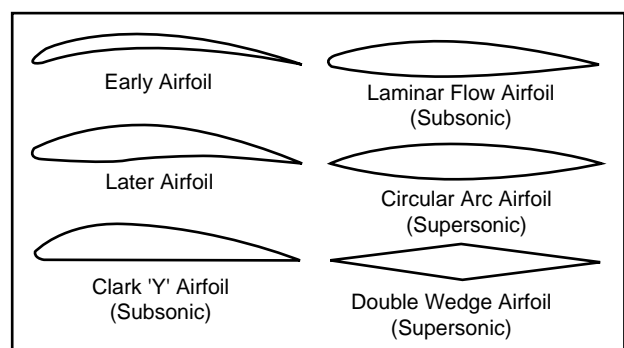

Figure 2-6. Airfoil designs.

Bernoulli's principle of pressure by itself does not explain the distribution of pressure over the upper surface of the airfoil. A discussion of the influence of momentum of the air as it flows in various curved paths near the airfoil will be presented. [Figure 2-7] Momentum is the resistance a moving body offers to having its direction or amount of motion changed. When a body is forced to move in a circular path, it offers resistance in the direction away from the center of the curved path. This is "centrifugal force." While the particles of air move in the curved path AB, centrifugal force tends to throw them in the direction of the arrows between A and B and hence, causes the air to exert more than normal pressure on the leading edge of the airfoil. But after the air particles pass B (the point of reversal of the curvature of the path) the centrifugal force tends to throw them in the direction of the arrows between B and C (causing reduced pressure on the airfoil). This effect is held until the particles reach C, the second point of reversal of curvature of the airflow. Again the centrifugal force is reversed and the particles may even tend to give slightly more than normal pressure on the trailing edge of the airfoil, as indicated by the short arrows between C and D.

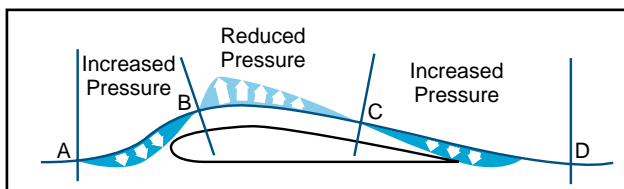

Figure 2-7. Momentum influences airflow over an airfoil.

Therefore, the air pressure on the upper surface of the airfoil is distributed so that the pressure is much greater on the leading edge than the surrounding atmospheric pressure, causing strong resistance to forward motion; but the air pressure is less than surrounding atmospheric pressure over a large portion of the top surface (B to C).

As seen in the application of Bernoulli's theorem to a venturi, the speedup of air on the top of an airfoil produces a drop in pressure. This lowered pressure is a component of total lift. It is a mistake, however, to assume that the pressure difference between the upper and lower surface of a wing alone accounts for the total lift force produced.

One must also bear in mind that associated with the lowered pressure is downwash; a downward backward flow from the top surface of the wing. As already seen from previous discussions relative to the dynamic action of the air as it strikes the lower surface of the wing, the reaction of this downward backward flow

results in an upward forward force on the wing. This same reaction applies to the flow of air over the top of the airfoil as well as to the bottom, and Newton's third law is again in the picture.

## HIGH PRESSURE BELOW

In the section dealing with Newton's laws as they apply to lift, it has already been discussed how a certain amount of lift is generated by pressure conditions underneath the wing. Because of the manner in which air flows underneath the wing, a positive pressure results, particularly at higher angles of attack. But there is another aspect to this airflow that must be considered. At a point close to the leading edge, the airflow is virtually stopped (stagnation point) and then gradually increases speed. At some point near the trailing edge, it has again reached a velocity equal to that on the upper surface. In conformance with Bernoulli's principles, where the airflow was slowed beneath the wing, a positive upward pressure was created against the wing; i.e., as the fluid speed decreases, the pressure must increase. In essence, this simply "accentuates the positive" since it increases the pressure differential between the upper and lower surface of the airfoil, and therefore increases total lift over that which would have resulted had there been no increase of pressure at the lower surface. Both Bernoulli's principle and Newton's laws are in operation whenever lift is being generated by an airfoil.

Fluid flow or airflow then, is the basis for flight in airplanes, and is a product of the velocity of the airplane. The velocity of the airplane is very important to the pilot since it affects the lift and drag forces of the airplane. The pilot uses the velocity (airspeed) to fly at a minimum glide angle, at maximum endurance, and for a number of other flight maneuvers. Airspeed is the velocity of the airplane relative to the air mass through which it is flying.

## PRESSURE DISTRIBUTION

From experiments conducted on wind tunnel models and on full size airplanes, it has been determined that as air flows along the surface of a wing at different angles of attack, there are regions along the surface where the pressure is negative, or less than atmospheric, and regions where the pressure is positive, or greater than atmospheric. This negative pressure on the upper surface creates a relatively larger force on the wing than is caused by the positive pressure resulting from the air striking the lower wing surface. Figure 2-8 shows the pressure distribution along an airfoil at three different angles of attack. In general, at high angles of attack the

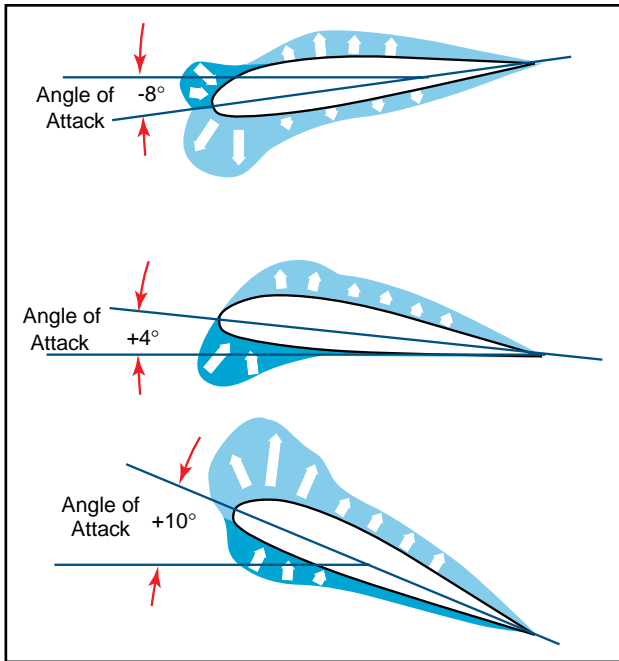

Figure 2-8. Pressure distribution on an airfoil.

center of pressure moves forward, while at low angles of attack the center of pressure moves aft. In the design of wing structures, this center of pressure travel is very important, since it affects the position of the airloads imposed on the wing structure in low angle-of-attack conditions and high angle-of-attack conditions. The airplane's aerodynamic balance and controllability are governed by changes in the center of pressure.

The center of pressure is determined through calculation and wind tunnel tests by varying the airfoil's angle of attack through normal operating extremes. As the angle of attack is changed, so are the various pressure distribution characteristics. [Figure 2-8] Positive (+) and negative (-) pressure forces are totaled for each angle of attack and the resultant force is obtained. The total resultant pressure is represented by the resultant force vector shown in figure 2-9.

The point of application of this force vector is termed the "center of pressure" (CP). For any given

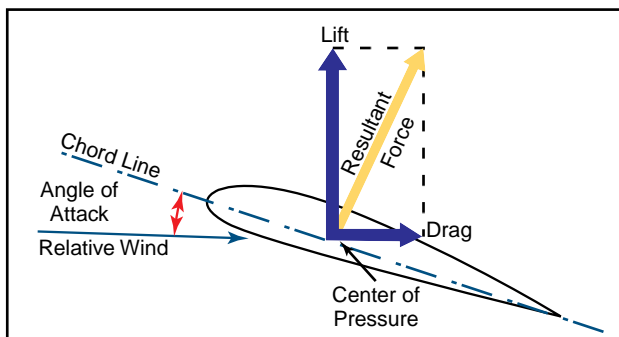

Figure 2-9. Force vectors on an airfoil.

angle of attack, the center of pressure is the point where the resultant force crosses the chord line. This point is expressed as a percentage of the chord of the airfoil. A center of pressure at 30 percent of a 60-inch chord would be 18 inches aft of the wing's leading edge. It would appear then that if the designer would place the wing so that its center of pressure was at the airplane's center of gravity, the airplane would always balance. The difficulty arises, however, that the location of the center of pressure changes with change in the airfoil's angle of attack. [Figure 2-10]

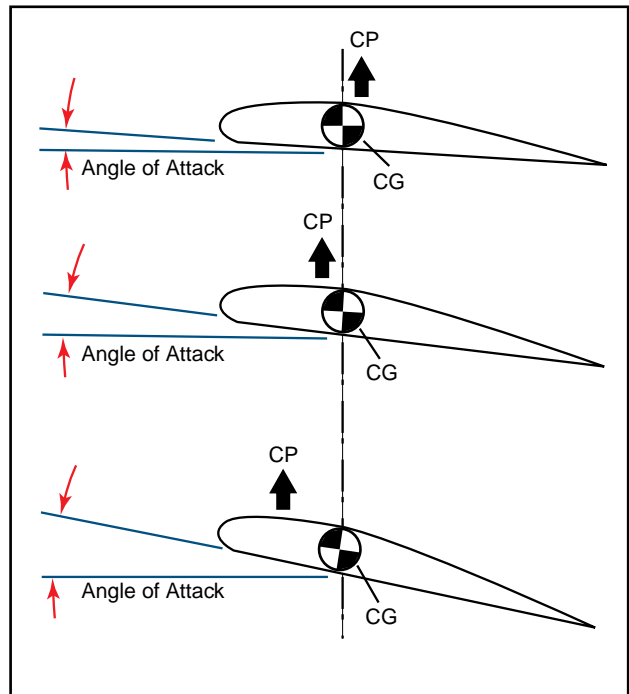

Figure 2-10. CP changes with an angle of attack.

In the airplane's normal range of flight attitudes, if the angle of attack is increased, the center of pressure moves forward; and if decreased, it moves rearward. Since the center of gravity is fixed at one point, it is evident that as the angle of attack increases, the center of lift (CL) moves ahead of the center of gravity, creating a force which tends to raise the nose of the airplane or tends to increase the angle of attack still more. On the other hand, if the angle of attack is decreased, the center of lift (CL) moves aft and tends to decrease the angle a greater amount. It is seen then, that the ordinary airfoil is inherently unstable, and that an auxiliary device, such as the horizontal tail surface, must be added to make the airplane balance longitudinally.

The balance of an airplane in flight depends, therefore, on the relative position of the center of gravity (CG) and the center of pressure (CP) of the airfoil. Experience has shown that an airplane with the center



of gravity in the vicinity of 20 percent of the wing chord can be made to balance and fly satisfactorily.

The tapered wing presents a variety of wing chords throughout the span of the wing. It becomes necessary then, to specify some chord about which the point of balance can be expressed. This chord, known as the mean aerodynamic chord (MAC),

usually is defined as the chord of an imaginary untapered wing, which would have the same center of pressure characteristics as the wing in question.

Airplane loading and weight distribution also affect center of gravity and cause additional forces, which in turn affect airplane balance.

# Chapter 3

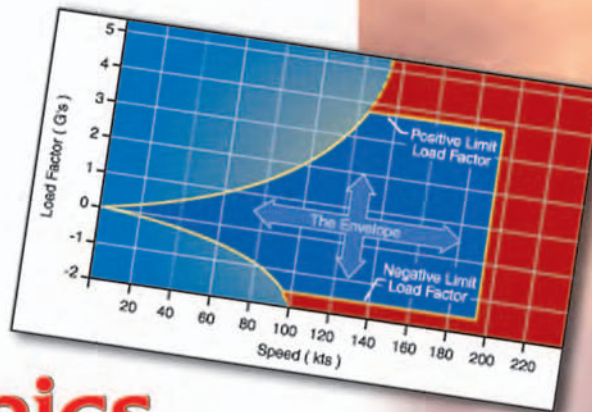

# Aerodynamics of Flight

## FORCES ACTING ON THE AIRPLANE

In some respects at least, how well a pilot performs in flight depends upon the ability to plan and coordinate the use of the power and flight controls for changing the forces of thrust, drag, lift, and weight. It is the balance between these forces that the pilot must always control. The better the understanding of the forces and means of controlling them, the greater will be the pilot's skill at doing so.

The following defines these forces in relation to straight-and-level, unaccelerated flight.

**Thrust** is the forward force produced by the power-plant/propeller. It opposes or overcomes the force of drag. As a general rule, it is said to act parallel to the longitudinal axis. However, this is not always the case as will be explained later.

**Drag** is a rearward, retarding force, and is caused by disruption of airflow by the wing, fuselage, and other protruding objects. Drag opposes thrust, and acts rearward parallel to the relative wind.

**Weight** is the combined load of the airplane itself, the crew, the fuel, and the cargo or baggage. Weight pulls the airplane downward because of the force of gravity. It opposes lift, and acts vertically downward through the airplane's center of gravity.

**Lift** opposes the downward force of weight, is produced by the dynamic effect of the air acting on the wing, and acts perpendicular to the flightpath through the wing's center of lift.

In steady flight, the sum of these opposing forces is equal to zero. There can be no unbalanced forces in steady, straight flight (Newton's Third Law). This is true whether flying level or when climbing or descending. This is not the same thing as saying that the four forces are all equal. It simply means that the opposing forces are equal to, and thereby cancel the effects of, each other. Often the relationship between the four forces has been erroneously explained or illustrated in such a way that this point is obscured. Consider figure 3-1 on the next page, for example. In the upper illustration the force vectors of thrust, drag, lift, and weight appear to be equal in value. The usual explanation states (without stipulating that thrust and drag do not equal weight and lift) that thrust equals drag and lift equals weight as shown in the lower illustration. This basically true statement must be understood or it can be misleading. It should be understood that in straight, level, unaccelerated flight, it is true that the opposing lift/weight forces are equal, but they are also greater than the opposing forces of thrust/drag that are equal only to each other; not to lift/weight. To be correct about it, it must be said that in steady flight:

- The sum of all upward forces (not just lift) equals the sum of all downward forces (not just weight).
- The sum of all forward forces (not just thrust) equals the sum of all backward forces (not just drag).

This refinement of the old "thrust equals drag; lift equals weight" formula takes into account the fact that

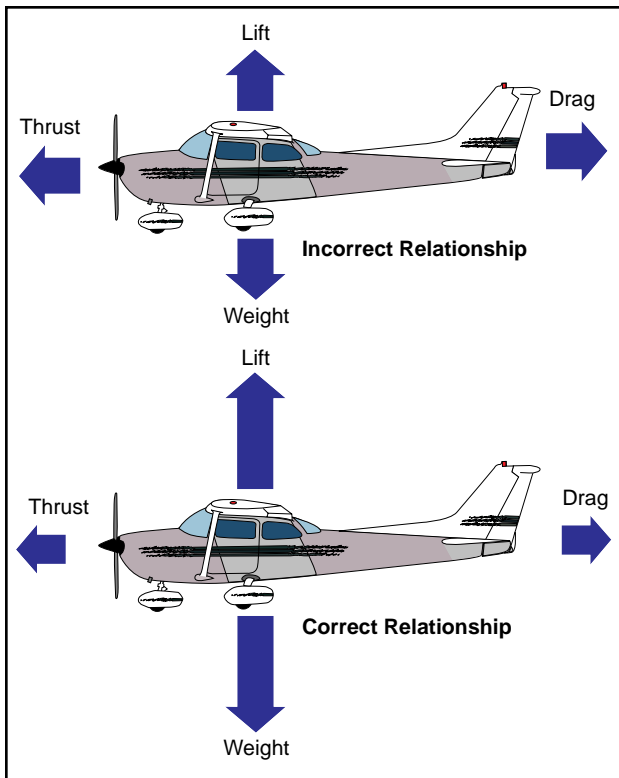

Figure 3-1. Relationship of forces acting on an airplane.

in climbs a portion of thrust, since it is directed upward, acts as if it were lift; and a portion of weight, since it is directed backward, acts as if it were drag. In glides, a portion of the weight vector is directed forward, and therefore acts as thrust. In other words, any time the flightpath of the airplane is not horizontal, lift, weight, thrust, and drag vectors must each be broken down into two components. [Figure 3-2]

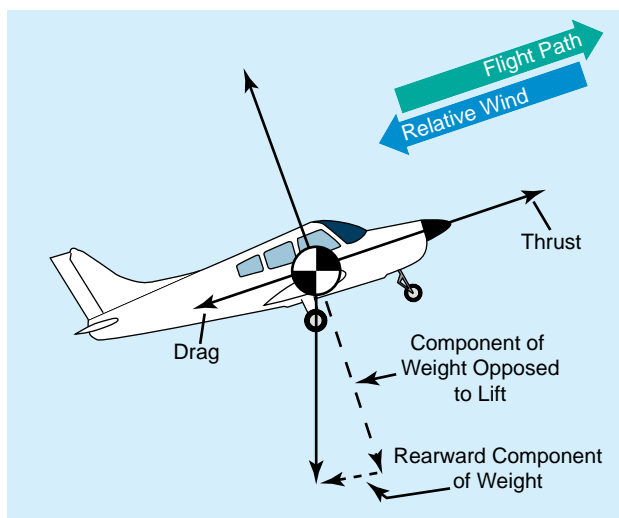

Figure 3-2. Force vectors during a stabilized climb.

Discussions of the preceding concepts are frequently omitted in aeronautical texts/handbooks/manuals. The reason is not that they are of no consequence, but because by omitting such discussions, the main ideas with respect to the aerodynamic forces acting upon

an airplane in flight can be presented in their most essential elements without being involved in the technicalities of the aerodynamicist. In point of fact, considering only level flight, and normal climbs and glides in a steady state, it is still true that wing lift is the really important upward force, and weight is the really important downward force.

Frequently, much of the difficulty encountered in explaining the forces that act upon an airplane is largely a matter of language and its meaning. For example, pilots have long believed that an airplane climbs because of excess lift. This is not true if one is thinking in terms of wing lift alone. It is true, however, if by lift it is meant the sum total of all "upward forces." But when referring to the "lift of thrust" or the "thrust of weight," the definitions previously established for these forces are no longer valid and complicate matters. It is this impreciseness in language that affords the excuse to engage in arguments, largely academic, over refinements to basic principles.

Though the forces acting on an airplane have already been defined, a discussion in more detail to establish how the pilot uses them to produce controlled flight is appropriate.

### THRUST

Before the airplane begins to move, thrust must be exerted. It continues to move and gain speed until thrust and drag are equal. In order to maintain a constant airspeed, thrust and drag must remain equal, just as lift and weight must be equal to maintain a constant altitude. If in level flight, the engine power is reduced, the thrust is lessened, and the airplane slows down. As long as the thrust is less than the drag, the airplane continues to decelerate until its airspeed is insufficient to support it in the air.

Likewise, if the engine power is increased, thrust becomes greater than drag and the airspeed increases. As long as the thrust continues to be greater than the drag, the airplane continues to accelerate. When drag equals thrust, the airplane flies at a constant airspeed.

Straight-and-level flight may be sustained at speeds from very slow to very fast. The pilot must coordinate angle of attack and thrust in all speed regimes if the airplane is to be held in level flight. Roughly, these regimes can be grouped in three categories: low-speed flight, cruising flight, and high-speed flight.

When the airspeed is low, the angle of attack must be relatively high to increase lift if the balance between lift and weight is to be maintained. [Figure 3-3] If thrust decreases and airspeed decreases, lift becomes

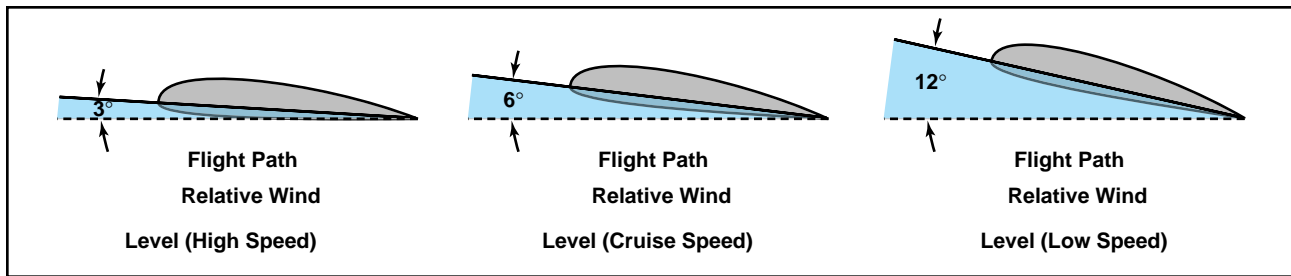

Figure 3-3. Angle of attack at various speeds.

less than weight and the airplane will start to descend. To maintain level flight, the pilot can increase the angle of attack an amount which will generate a lift force again equal to the weight of the airplane and while the airplane will be flying more slowly, it will still maintain level flight if the pilot has properly coordinated thrust and angle of attack.

Straight-and-level flight in the slow speed regime provides some interesting conditions relative to the equilibrium of forces, because with the airplane in a nose-high attitude, there is a vertical component of thrust that helps support the airplane. For one thing, wing loading tends to be less than would be expected. Most pilots are aware that an airplane will stall, other conditions being equal, at a slower speed with the power on than with the power off. (Induced airflow over the wings from the propeller also contributes to this.) However, if analysis is restricted to the four forces as they are usually defined, one can say that in straight-and-level slow speed flight the thrust is equal to drag, and lift is equal to weight.

During straight-and level-flight when thrust is increased and the airspeed increases, the angle of attack must be decreased. That is, if changes have been coordinated, the airplane will still remain in level flight but at a higher speed when the proper relationship between thrust and angle of attack is established.

If the angle of attack were not coordinated (decreased) with this increase of thrust, the airplane would climb. But decreasing the angle of attack modifies the lift, keeping it equal to the weight, and if properly done, the airplane still remains in level flight. Level flight at even slightly negative angles of attack is possible at very high speed. It is evident then, that level flight can be performed with any angle of attack between stalling angle and the relatively small negative angles found at high speed.

### DRAG

Drag in flight is of two basic types: parasite drag and induced drag. The first is called parasite because it in no way functions to aid flight, while the second is induced or created as a result of the wing developing lift.

Parasite drag is composed of two basic elements: form drag, resulting from the disruption of the streamline flow; and the resistance of skin friction.

Of the two components of parasite drag, form drag is the easier to reduce when designing an airplane. In general, a more streamlined object produces the best form to reduce parasite drag.

Skin friction is the type of parasite drag that is most difficult to reduce. No surface is perfectly smooth. Even machined surfaces, when inspected through magnification, have a ragged, uneven appearance. This rough surface will deflect the streamlines of air on the surface, causing resistance to smooth airflow. Skin friction can be minimized by employing a glossy, flat finish to surfaces, and by eliminating protruding rivet heads, roughness, and other irregularities.

Another element must be added to the consideration of parasite drag when designing an airplane. This drag combines the effects of form drag and skin friction and is called interference drag. If two objects are placed adjacent to one another, the resulting turbulence produced may be 50 to 200 percent greater than the parts tested separately.

The three elements, form drag, skin friction, and interference drag, are all computed to determine parasite drag on an airplane.

Shape of an object is a big factor in parasite drag. However, indicated airspeed is an equally important factor when speaking of parasite drag. The profile drag of a streamlined object held in a fixed position relative to the airflow increases approximately as the square of the velocity; thus, doubling the airspeed increases the drag four times, and tripling the airspeed increases the drag nine times. This relationship, however, holds good only at comparatively low subsonic speeds. At some higher airspeeds, the rate at which profile drag has been increased with speed suddenly begins to increase more rapidly.

The second basic type of drag is induced drag. It is an established physical fact that no system, which does work in the mechanical sense, can be 100 percent efficient. This means that whatever the nature

of the system, the required work is obtained at the expense of certain additional work that is dissipated or lost in the system. The more efficient the system, the smaller this loss.

In level flight the aerodynamic properties of the wing produce a required lift, but this can be obtained only at the expense of a certain penalty. The name given to this penalty is induced drag. Induced drag is inherent whenever a wing is producing lift and, in fact, this type of drag is inseparable from the production of lift. Consequently, it is always present if lift is produced.

The wing produces the lift force by making use of the energy of the free airstream. Whenever the wing is producing lift, the pressure on the lower surface of the wing is greater than that on the upper surface. As a result, the air tends to flow from the high pressure area below the wingtip upward to the low pressure area above the wing. In the vicinity of the wingtips, there is a tendency for these pressures to equalize, resulting in a lateral flow outward from the underside to the upper surface of the wing. This lateral flow imparts a rotational velocity to the air at the wingtips and trails behind the wing. Therefore, flow about the wingtips will be in the form of two vortices trailing behind as the wings move on.

When the airplane is viewed from the tail, these vortices will circulate counterclockwise about the right wingtip and clockwise about the left wingtip. [Figure 3-4] Bearing in mind the direction of rotation of these vortices, it can be seen that they induce an upward flow of air beyond the wingtip, and a downwash flow behind the wing's trailing edge. This induced downwash has nothing in common with the downwash that is necessary to produce lift. It is, in fact, the source of induced drag. The greater the size and strength of the vortices and consequent downwash component on the net airflow over the wing, the greater the induced drag effect becomes. This downwash over the top of the wing at the tip has the same effect as bending the lift vector rearward; therefore, the lift is slightly aft of perpendicular to the relative wind, creating a rearward lift component. This is induced drag.

It should be remembered that in order to create a greater negative pressure on the top of the wing, the wing can be inclined to a higher angle of attack; also, that if the angle of attack of an asymmetrical wing were zero, there would be no pressure differential and consequently no downwash component; therefore, no induced drag. In any case, as angle of attack increases, induced drag increases proportionally.

To state this another way—the lower the airspeed the greater the angle of attack required to produce lift

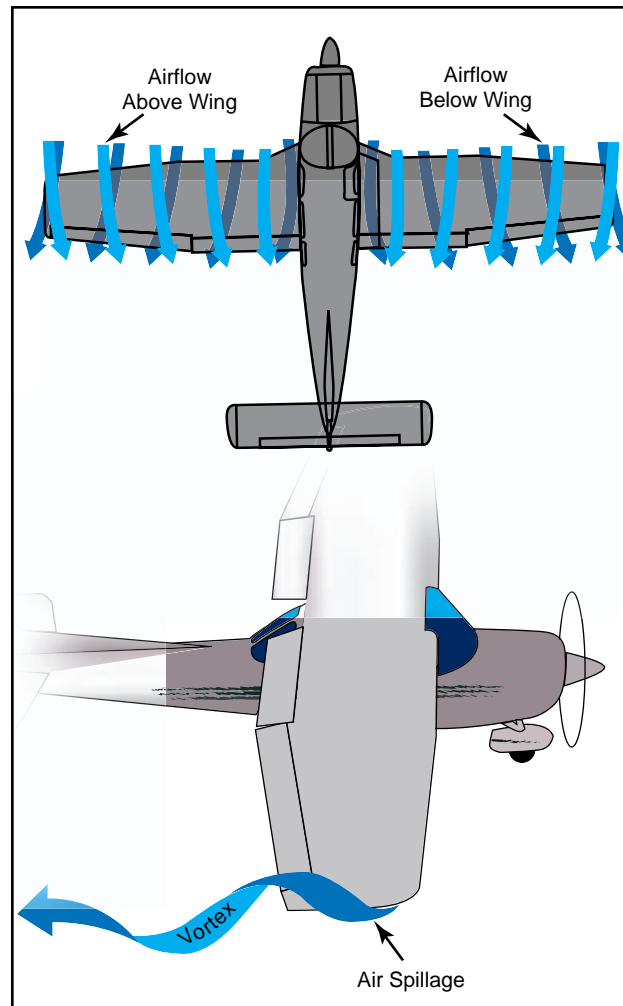

Figure 3-4. Wingtip vortices.

equal to the airplane's weight and consequently, the greater will be the induced drag. The amount of induced drag varies inversely as the square of the airspeed.

From the foregoing discussion, it can be noted that parasite drag increases as the square of the airspeed, and induced drag varies inversely as the square of the airspeed. It can be seen that as airspeed decreases to near the stalling speed, the total drag becomes greater, due mainly to the sharp rise in induced drag. Similarly, as the airspeed reaches the terminal velocity of the airplane, the total drag again increases rapidly, due to the sharp increase of parasite drag. As seen in figure 3-5, at some given airspeed, total drag is at its maximum amount. This is very important in figuring the maximum endurance and range of airplanes; for when drag is at a minimum, power required to overcome drag is also at a minimum.

To understand the effect of lift and drag on an airplane in flight, both must be combined and the lift/drag ratio considered. With the lift and drag data

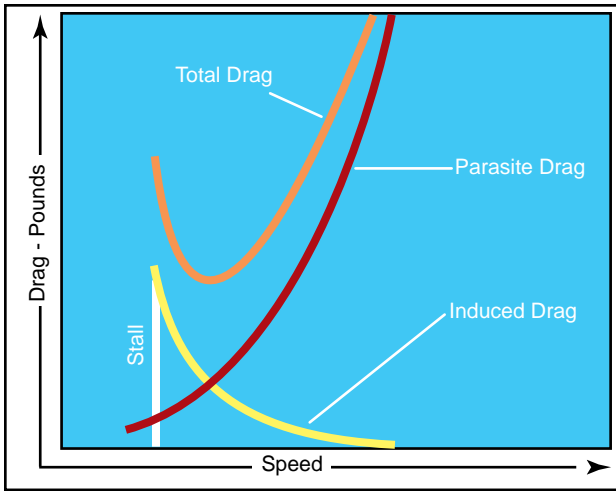

Figure 3-5. Drag versus speed.

available for various airspeeds of the airplane in steady, unaccelerated flight, the proportions of  $C_L$  (Coefficient of Lift) and  $C_D$  (Coefficient of Drag) can be calculated for each specific angle of attack. The resulting plot for lift/drag ratio with angle of attack shows that  $L/D$  increases to some maximum, then decreases at the higher lift coefficients and angles of attack, as shown in figure 3-6. Note that the maximum lift/drag ratio, ( $L/D$  max) occurs at one specific angle of attack and lift coefficient. If the airplane is operated in steady flight at  $L/D$  max, the total drag is at a minimum. Any angle of attack lower or higher than that for  $L/D$  max reduces the lift/drag ratio and consequently increases the total drag for a given airplane's lift.

The location of the center of gravity (CG) is determined by the general design of each particular airplane. The

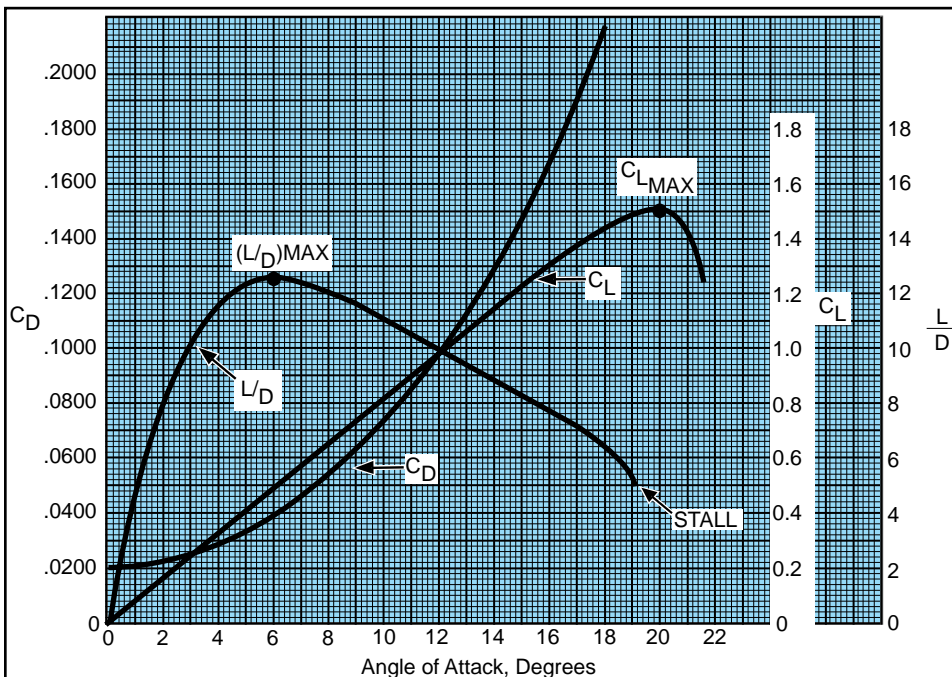

Figure 3-6. Lift coefficients at various angles of attack.

designers determine how far the center of pressure (CP) will travel. They then fix the center of gravity forward of the center of pressure for the corresponding flight speed in order to provide an adequate restoring moment to retain flight equilibrium.

The configuration of an airplane has a great effect on the lift/drag ratio. The high performance sailplane may have extremely high lift/drag ratios. The supersonic fighter may have seemingly low lift/drag ratios in subsonic flight, but the airplane configurations required for supersonic flight (and high  $L/D$ s at high Mach numbers) cause this situation.

## WEIGHT

Gravity is the pulling force that tends to draw all bodies to the center of the earth. The center of gravity (CG) may be considered as a point at which all the weight of the airplane is concentrated. If the airplane were supported at its exact center of gravity, it would balance in any attitude. It will be noted that center of gravity is of major importance in an airplane, for its position has a great bearing upon stability.

The location of the center of gravity is determined by the general design of each particular airplane. The designers determine how far the center of pressure (CP) will travel. They then fix the center of gravity forward of the center of pressure for the corresponding flight speed in order to provide an adequate restoring moment to retain flight equilibrium.

Weight has a definite relationship with lift, and thrust with drag. This relationship is simple, but important in understanding the aerodynamics of flying. Lift

is the upward force on the wing acting perpendicular to the relative wind. Lift is required to counteract the airplane's weight (which is caused by the force of gravity acting on the mass of the airplane). This weight (gravity) force acts downward through the airplane's center of gravity. In stabilized level flight, when the lift force is equal to the weight force, the airplane is in a state of equilibrium and neither gains nor loses altitude. If lift becomes less than weight, the airplane loses

altitude. When the lift is greater than weight, the airplane gains altitude.

### **LIFT**

The pilot can control the lift. Any time the control wheel is more fore or aft, the angle of attack is changed. As angle of attack increases, lift increases (all other factors being equal). When the airplane reaches the maximum angle of attack, lift begins to diminish rapidly. This is the stalling angle of attack, or burble point.

Before proceeding further with lift and how it can be controlled, velocity must be interjected. The shape of the wing cannot be effective unless it continually keeps “attacking” new air. If an airplane is to keep flying, it must keep moving. Lift is proportional to the square of the airplane’s velocity. For example, an airplane traveling at 200 knots has four times the lift as the same airplane traveling at 100 knots, if the angle of attack and other factors remain constant.

Actually, the airplane could not continue to travel in level flight at a constant altitude and maintain the same angle of attack if the velocity is increased. The lift would increase and the airplane would climb as a result of the increased lift force. Therefore, to maintain the lift and weight forces in balance, and to keep the airplane “straight and level” (not accelerating upward) in a state of equilibrium, as velocity is increased, lift must be decreased. This is normally accomplished by reducing the angle of attack; i.e., lowering the nose. Conversely, as the airplane is slowed, the decreasing velocity requires increasing the angle of attack to maintain lift sufficient to maintain flight. There is, of course, a limit to how far the angle of attack can be increased, if a stall is to be avoided.

Therefore, it may be concluded that for every angle of attack there is a corresponding indicated airspeed required to maintain altitude in steady, unaccelerated flight—all other factors being constant. (Bear in mind this is only true if maintaining “level flight.”) Since an airfoil will always stall at the same angle of attack, if increasing weight, lift must also be increased, and the only method for doing so is by increased velocity if the angle of attack is held constant just short of the “critical” or stalling angle of attack.

Lift and drag also vary directly with the density of the air. Density is affected by several factors: pressure, temperature, and humidity. Remember, at an altitude of 18,000 feet, the density of the air has one-half the density of air at sea level. Therefore, in order to maintain its lift at a higher altitude, an

airplane must fly at a greater true airspeed for any given angle of attack.

Furthermore, warm air is less dense than cool air, and moist air is less dense than dry air. Thus, on a hot humid day, an airplane must be flown at a greater true airspeed for any given angle of attack than on a cool, dry day.

If the density factor is decreased and the total lift must equal the total weight to remain in flight, it follows that one of the other factors must be increased. The factors usually increased are the airspeed or the angle of attack, because these factors can be controlled directly by the pilot.

It should also be pointed out that lift varies directly with the wing area, provided there is no change in the wing’s planform. If the wings have the same proportion and airfoil sections, a wing with a planform area of 200 square feet lifts twice as much at the same angle of attack as a wing with an area of 100 square feet.

As can be seen, two major factors from the pilot’s viewpoint are lift and velocity because these are the two that can be controlled most readily and accurately. Of course, the pilot can also control density by adjusting the altitude and can control wing area if the airplane happens to have flaps of the type that enlarge wing area. However, for most situations, the pilot is controlling lift and velocity to maneuver the airplane. For instance, in straight-and-level flight, cruising along at a constant altitude, altitude is maintained by adjusting lift to match the airplane’s velocity or cruise airspeed, while maintaining a state of equilibrium where lift equals weight. In an approach to landing, when the pilot wishes to land as slowly as practical, it is necessary to increase lift to near maximum to maintain lift equal to the weight of the airplane.

### **WINGTIP VORTICES**

The action of the airfoil that gives an airplane lift also causes induced drag. It was determined that when a wing is flown at a positive angle of attack, a pressure differential exists between the upper and lower surfaces of the wing—that is, the pressure above the wing is less than atmospheric pressure and the pressure below the wing is equal to or greater than atmospheric pressure. Since air always moves from high pressure toward low pressure, and the path of least resistance is toward the airplane’s wingtips, there is a spanwise movement of air from the bottom of the wing outward from the fuselage around the wingtips. This flow of air results in “spillage” over the wingtips, thereby setting up a whirlpool of air

called a “vortex.” [Figure 3-4] At the same time, the air on the upper surface of the wing has a tendency to flow in toward the fuselage and off the trailing edge. This air current forms a similar vortex at the inboard portion of the trailing edge of the wing, but because the fuselage limits the inward flow, the vortex is insignificant. Consequently, the deviation in flow direction is greatest at the wingtips where the unrestricted lateral flow is the strongest. As the air curls upward around the wingtip, it combines with the wing’s downwash to form a fast spinning trailing vortex. These vortices increase drag because of energy spent in producing the turbulence. It can be seen, then, that whenever the wing is producing lift, induced drag occurs, and wingtip vortices are created.

Just as lift increases with an increase in angle of attack, induced drag also increases. This occurs because as the angle of attack is increased, there is a greater pressure difference between the top and bottom of the wing, and a greater lateral flow of air; consequently, this causes more violent vortices to be set up, resulting in more turbulence and more induced drag.

The intensity or strength of the wingtip vortices is directly proportional to the weight of the airplane and inversely proportional to the wingspan and speed of the airplane. The heavier and slower the airplane, the greater the angle of attack and the stronger the wingtip vortices. Thus, an airplane will create wingtip vortices with maximum strength occurring during the takeoff, climb, and landing phases of flight.

## GROUND EFFECT

It is possible to fly an airplane just clear of the ground (or water) at a slightly slower airspeed than that required to sustain level flight at higher altitudes. This is the result of a phenomenon, which is better known than understood even by some experienced pilots.

When an airplane in flight gets within several feet from the ground surface, a change occurs in the three-dimensional flow pattern around the airplane because the vertical component of the airflow around the wing is restricted by the ground surface. This alters the wing’s upwash, downwash, and wingtip vortices. [Figure 3-7] These general effects due to the presence

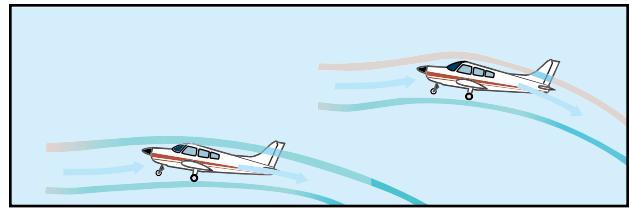

Figure 3-7. Ground effect changes airflow.

of the ground are referred to as “ground effect.” Ground effect, then, is due to the interference of the ground (or water) surface with the airflow patterns about the airplane in flight.

While the aerodynamic characteristics of the tail surfaces and the fuselage are altered by ground effects, the principal effects due to proximity of the ground are the changes in the aerodynamic characteristics of the wing. As the wing encounters ground effect and is maintained at a constant lift coefficient, there is consequent reduction in the upwash, downwash, and the wingtip vortices.

Induced drag is a result of the wing’s work of sustaining the airplane and the wing lifts the airplane simply by accelerating a mass of air downward. It is true that reduced pressure on top of an airfoil is essential to lift, but that is but one of the things that contributes to the overall effect of pushing an air mass downward. The more downwash there is, the harder the wing is pushing the mass of air down. At high angles of attack, the amount of induced drag is high and since this corresponds to lower airspeeds in actual flight, it can be said that induced drag predominates at low speed.

However, the reduction of the wingtip vortices due to ground effect alters the spanwise lift distribution and reduces the induced angle of attack and induced drag. Therefore, the wing will require a lower angle of attack in ground effect to produce the same lift coefficient or, if a constant angle of attack is maintained, an increase in lift coefficient will result. [Figure 3-8]

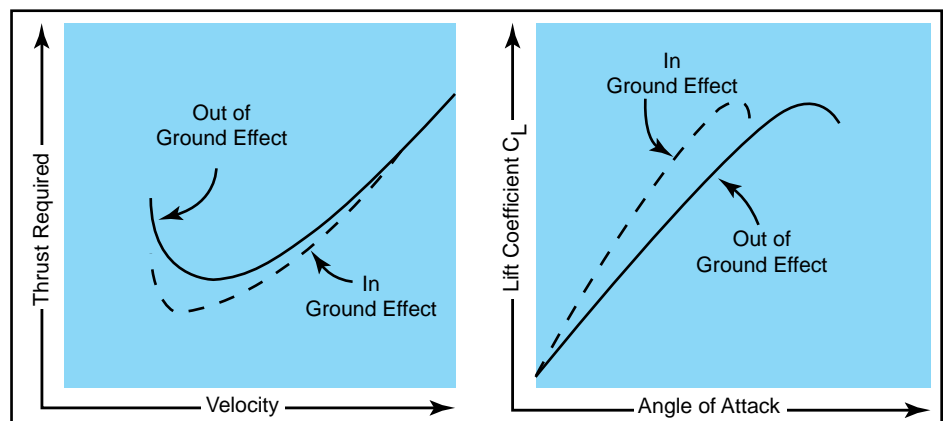

Figure 3-8. Ground effect changes drag and lift.



Ground effect also will alter the thrust required versus velocity. Since induced drag predominates at low speeds, the reduction of induced drag due to ground effect will cause the most significant reduction of thrust required (parasite plus induced drag) at low speeds.

The reduction in induced flow due to ground effect causes a significant reduction in induced drag but causes no direct effect on parasite drag. As a result of the reduction in induced drag, the thrust required at low speeds will be reduced.

Due to the change in upwash, downwash, and wingtip vortices, there may be a change in position (installation) error of the airspeed system, associated with ground effect. In the majority of cases, ground effect will cause an increase in the local pressure at the static source and produce a lower indication of airspeed and altitude. Thus, the airplane may be airborne at an indicated airspeed less than that normally required.

In order for ground effect to be of significant magnitude, the wing must be quite close to the ground. One of the direct results of ground effect is the variation of induced drag with wing height above the ground at a constant lift coefficient. When the wing is at a height equal to its span, the reduction in induced drag is only 1.4 percent. However, when the wing is at a height equal to one-fourth its span, the reduction in induced drag is 23.5 percent and, when the wing is at a height equal to one-tenth its span, the reduction in induced drag is 47.6 percent. Thus, a large reduction in induced drag will take place only when the wing is very close to the ground. Because of this variation, ground effect is most usually recognized during the liftoff for takeoff or just prior to touchdown when landing.

During the takeoff phase of flight, ground effect produces some important relationships. The airplane leaving ground effect after takeoff encounters just the reverse of the airplane entering ground effect during landing; i.e., the airplane leaving ground effect will:

- Require an increase in angle of attack to maintain the same lift coefficient.
- Experience an increase in induced drag and thrust required.
- Experience a decrease in stability and a nose-up change in moment.
- Produce a reduction in static source pressure and increase in indicated airspeed.

These general effects should point out the possible danger in attempting takeoff prior to achieving the recommended takeoff speed. Due to the reduced drag in ground effect, the airplane may seem capable of takeoff well below the recommended speed. However, as the airplane rises out of ground effect with a deficiency of speed, the greater induced drag may result in very marginal initial climb performance. In the extreme conditions such as high gross weight, high density altitude, and high temperature, a deficiency of airspeed during takeoff may permit the airplane to become airborne but be incapable of flying out of ground effect. In this case, the airplane may become airborne initially with a deficiency of speed, and then settle back to the runway. It is important that no attempt be made to force the airplane to become airborne with a deficiency of speed; the recommended takeoff speed is necessary to provide adequate initial climb performance. For this reason, it is imperative that a definite climb be established before retracting the landing gear or flaps.

During the landing phase of flight, the effect of proximity to the ground also must be understood and appreciated. If the airplane is brought into ground effect with a constant angle of attack, the airplane will experience an increase in lift coefficient and a reduction in the thrust required. Hence, a “floating” effect may occur. Because of the reduced drag and power off deceleration in ground effect, any excess speed at the point of flare may incur a considerable “float” distance. As the airplane nears the point of touchdown, ground effect will be most realized at altitudes less than the wingspan. During the final phases of the approach as the airplane nears the ground, a reduced power setting is necessary or the reduced thrust required would allow the airplane to climb above the desired glidepath.

## **AXES OF AN AIRPLANE**

Whenever an airplane changes its flight attitude or position in flight, it rotates about one or more of three axes, which are imaginary lines that pass through the airplane’s center of gravity. The axes of an airplane can be considered as imaginary axes around which the airplane turns, much like the axle around which a wheel rotates. At the point where all three axes intersect, each is at a 90° angle to the other two. The axis, which extends lengthwise through the fuselage from the nose to the tail, is the longitudinal axis. The axis, which extends crosswise from wingtip to wingtip, is the lateral axis. The axis, which passes vertically through the center of gravity, is the vertical axis. [Figure 3-9]

The airplane’s motion about its longitudinal axis resembles the roll of a ship from side to side. In fact,

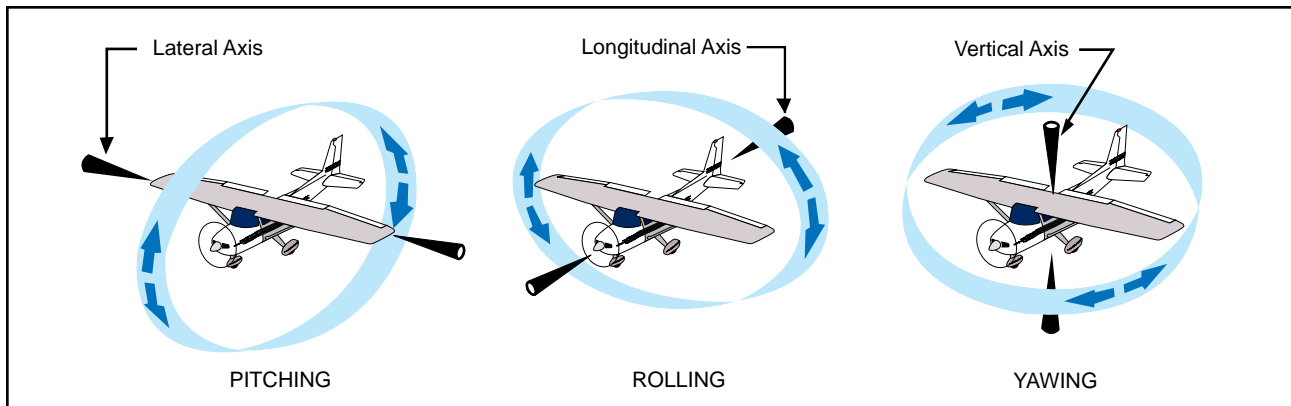

Figure 3-9. Axes of an airplane.

the names used in describing the motion about an airplane's three axes were originally nautical terms. They have been adapted to aeronautical terminology because of the similarity of motion between an airplane and the seagoing ship.

In light of the adoption of nautical terms, the motion about the airplane's longitudinal axis is called "roll"; motion about its lateral axis is referred to as "pitch." Finally, an airplane moves about its vertical axis in a motion, which is termed "yaw"—that is, a horizontal (left and right) movement of the airplane's nose.

The three motions of the airplane (roll, pitch, and yaw) are controlled by three control surfaces. Roll is controlled by the ailerons; pitch is controlled by the elevators; yaw is controlled by the rudder. The use of these controls is explained in Chapter 4—Flight Controls.

## MOMENTS AND MOMENT ARM

A study of physics shows that a body that is free to rotate will always turn about its center of gravity. In aerodynamic terms, the mathematical measure of an airplane's tendency to rotate about its center of gravity is called a "moment." A moment is said to be equal to the product of the force applied and the distance at which the force is applied. (A moment arm is the distance from a datum [reference point or line] to the applied force.) For airplane weight and balance computations, "moments" are expressed in terms of the distance of the arm times the airplane's weight, or simply, inch pounds.

Airplane designers locate the fore and aft position of the airplane's center of gravity as nearly as possible to the 20 percent point of the mean aerodynamic chord (MAC). If the thrust line is designed to pass horizontally through the center of gravity, it will not cause the airplane to pitch when power is changed, and there will be no difference in moment due to thrust for a power-on or power-off condition of flight. Although designers have some control over

the location of the drag forces, they are not always able to make the resultant drag forces pass through the center of gravity of the airplane. However, the one item over which they have the greatest control is the size and location of the tail. The objective is to make the moments (due to thrust, drag, and lift) as small as possible; and, by proper location of the tail, to provide the means of balancing the airplane longitudinally for any condition of flight.

The pilot has no direct control over the location of forces acting on the airplane in flight, except for controlling the center of lift by changing the angle of attack. Such a change, however, immediately involves changes in other forces. Therefore, the pilot cannot independently change the location of one force without changing the effect of others. For example, a change in airspeed involves a change in lift, as well as a change in drag and a change in the up or down force on the tail. As forces such as turbulence and gusts act to displace the airplane, the pilot reacts by providing opposing control forces to counteract this displacement.

Some airplanes are subject to changes in the location of the center of gravity with variations of load. Trimming devices are used to counteract the forces set up by fuel burnoff, and loading or off-loading of passengers or cargo. Elevator trim tabs and adjustable horizontal stabilizers comprise the most common devices provided to the pilot for trimming for load variations. Over the wide ranges of balance during flight in large airplanes, the force which the pilot has to exert on the controls would become excessive and fatiguing if means of trimming were not provided.

## DESIGN CHARACTERISTICS

Every pilot who has flown numerous types of airplanes has noted that each airplane handles somewhat differently—that is, each resists or responds to control pressures in its own way. A training type airplane is quick to respond to control applications,

while a transport airplane usually feels heavy on the controls and responds to control pressures more slowly. These features can be designed into an airplane to facilitate the particular purpose the airplane is to fulfill by considering certain stability and maneuvering requirements. In the following discussion, it is intended to summarize the more important aspects of an airplane's stability; its maneuvering and controllability qualities; how they are analyzed; and their relationship to various flight conditions. In brief, the basic differences between stability, maneuverability, and controllability are as follows:

- **Stability**—The inherent quality of an airplane to correct for conditions that may disturb its equilibrium, and to return or to continue on the original flightpath. It is primarily an airplane design characteristic.
- **Maneuverability**—The quality of an airplane that permits it to be maneuvered easily and to withstand the stresses imposed by maneuvers. It is governed by the airplane's weight, inertia, size and location of flight controls, structural strength, and powerplant. It too is an airplane design characteristic.
- **Controllability**—The capability of an airplane to respond to the pilot's control, especially with regard to flightpath and attitude. It is the quality of the airplane's response to the pilot's control application when maneuvering the airplane, regardless of its stability characteristics.

structural strength. These limitations indicate the maximum performance and maneuverability of the airplane. If the airplane is to provide maximum utility, it must be safely controllable to the full extent of these limits without exceeding the pilot's strength or requiring exceptional flying ability. If an airplane is to fly straight and steady along any arbitrary flightpath, the forces acting on it must be in static equilibrium. The reaction of any body when its equilibrium is disturbed is referred to as stability. There are two types of stability; static and dynamic. Static will be discussed first, and in this discussion the following definitions will apply:

- **Equilibrium**—All opposing forces acting on the airplane are balanced; (i.e., steady, unaccelerated flight conditions).
- **Static Stability**—The initial tendency that the airplane displays after its equilibrium is disturbed.
- **Positive Static Stability**—The initial tendency of the airplane to return to the original state of equilibrium after being disturbed. [Figure 3-10]
- **Negative Static Stability**—The initial tendency of the airplane to continue away from the original state of equilibrium after being disturbed. [Figure 3-10]
- **Neutral Static Stability**—The initial tendency of the airplane to remain in a new condition after its equilibrium has been disturbed. [Figure 3-10]

### BASIC CONCEPTS OF STABILITY

The flightpaths and attitudes in which an airplane can fly are limited only by the aerodynamic characteristics of the airplane, its propulsive system, and its

### STATIC STABILITY

Stability of an airplane in flight is slightly more complex than just explained, because the airplane is free to move in any direction and must be controllable in

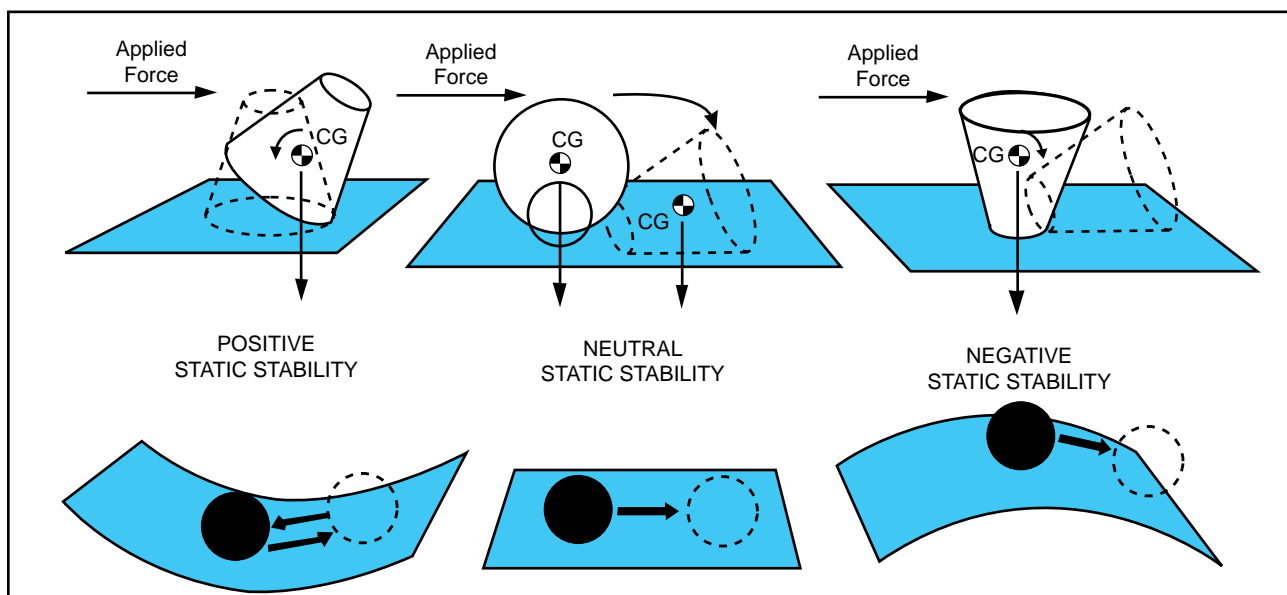

Figure 3-10. Types of stability.

pitch, roll, and direction. When designing the airplane, engineers must compromise between stability, maneuverability, and controllability; and the problem is compounded because of the airplane's three-axis freedom. Too much stability is detrimental to maneuverability, and similarly, not enough stability is detrimental to controllability. In the design of airplanes, compromise between the two is the keyword.

### DYNAMIC STABILITY

Static stability has been defined as the initial tendency that the airplane displays after being disturbed from its trimmed condition. Occasionally, the initial tendency is different or opposite from the overall tendency, so distinction must be made between the two. Dynamic stability is the overall tendency that the airplane displays after its equilibrium is disturbed. The curves of figure 3-11 represent the variation of controlled functions versus time. It is seen that the unit of time is very significant. If the time unit for one cycle or oscillation is above 10 seconds' duration, it is called a "long-period" oscillation (phugoid) and is easily controlled. In a longitudinal phugoid oscillation, the angle of attack remains constant when the airspeed increases and decreases. To a certain degree, a convergent phugoid is desirable but is not required. The phugoid can be determined only on a statically stable airplane, and this has a great effect on the trimming qualities of the airplane. If the time unit for one cycle or oscillation is less than one or two seconds, it is called a "short-period" oscillation and is normally very difficult, if not impossible, for the pilot to control. This is the type of oscillation that the pilot can easily "get in phase with" and reinforce.

A neutral or divergent, short-period oscillation is dangerous because structural failure usually results if the oscillation is not damped immediately. Short-period oscillations affect airplane and control surfaces alike and reveal themselves as "porpoising" in the airplane, or as "buzz" or "flutter" in the control surfaces. Basically, the short-period oscillation is a change in angle of attack with no change in airspeed. A short-period oscillation of a control surface is usually of such high frequency that the airplane does not have time to react. Logically, the Code of Federal Regulations require that short-period oscillations be heavily damped (i.e., die out immediately). Flight tests during the airworthiness certification of airplanes are conducted for this condition by inducing the oscillation in the controls for pitch, roll, or yaw at the most critical speed (i.e., at  $V_{NE}$ , the never-exceed speed). The test pilot strikes the control wheel or rudder pedal a sharp blow and observes the results.

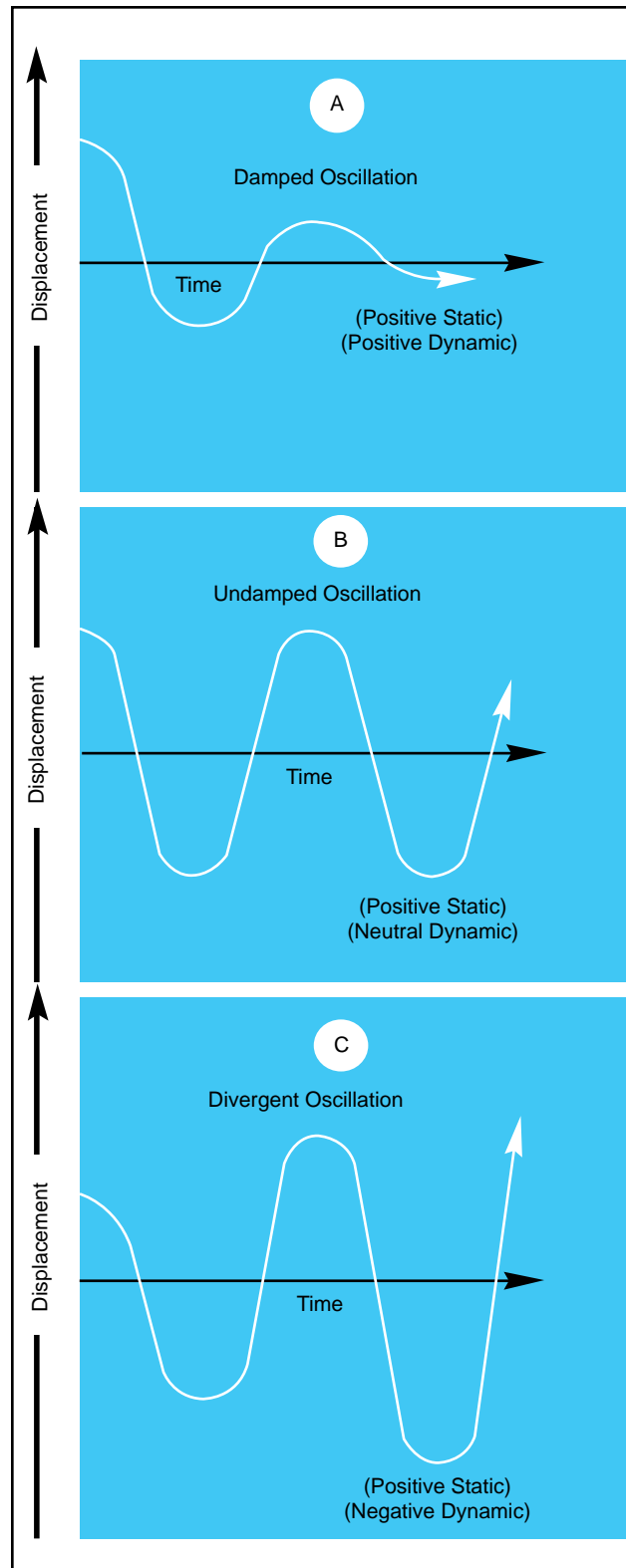

Figure 3-11. Damped versus undamped stability.

### LONGITUDINAL STABILITY (PITCHING)

In designing an airplane, a great deal of effort is spent in developing the desired degree of stability around all three axes. But longitudinal stability about the lateral axis is considered to be the most affected by certain variables in various flight conditions.

Longitudinal stability is the quality that makes an airplane stable about its lateral axis. It involves the pitching motion as the airplane's nose moves up and down in flight. A longitudinally unstable airplane has a tendency to dive or climb progressively into a very steep dive or climb, or even a stall. Thus, an airplane with longitudinal instability becomes difficult and sometimes dangerous to fly.

Static longitudinal stability or instability in an airplane, is dependent upon three factors:

1. Location of the wing with respect to the center of gravity;
2. Location of the horizontal tail surfaces with respect to the center of gravity; and
3. The area or size of the tail surfaces.

In analyzing stability, it should be recalled that a body that is free to rotate will always turn about its center of gravity.

To obtain static longitudinal stability, the relation of the wing and tail moments must be such that, if the moments are initially balanced and the airplane is suddenly nosed up, the wing moments and tail moments will change so that the sum of their forces will provide an unbalanced but restoring moment which, in turn, will bring the nose down again. Similarly, if the airplane is nosed down, the resulting change in moments will bring the nose back up.

The center of lift, sometimes called the center of pressure, in most unsymmetrical airfoils has a tendency to change its fore and aft position with a change in the angle of attack. The center of pressure tends to move forward with an increase in angle of attack and to move aft with a decrease in angle of attack. This means that when the angle of attack of an airfoil is increased, the center of pressure (lift) by moving forward, tends to lift the leading edge of the wing still more. This tendency gives the wing an inherent quality of instability.

Figure 3-12 shows an airplane in straight-and-level flight. The line CG-CL-T represents the airplane's longitudinal axis from the center of gravity (CG) to a point T on the horizontal stabilizer. The center of lift (or center of pressure) is represented by the point CL.

Most airplanes are designed so that the wing's center of lift (CL) is to the rear of the center of gravity. This makes the airplane "nose heavy" and requires that there be a slight downward force on the horizontal stabilizer in order to balance the airplane and keep

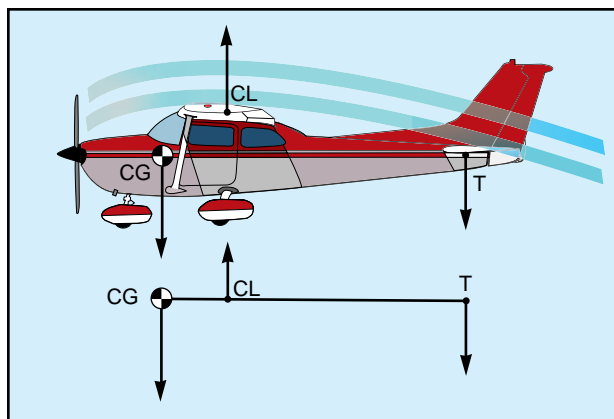

Figure 3-12. Longitudinal stability.

the nose from continually pitching downward. Compensation for this nose heaviness is provided by setting the horizontal stabilizer at a slight negative angle of attack. The downward force thus produced, holds the tail down, counterbalancing the "heavy" nose. It is as if the line CG-CL-T was a lever with an upward force at CL and two downward forces balancing each other, one a strong force at the CG point and the other, a much lesser force, at point T (downward air pressure on the stabilizer). Applying simple physics principles, it can be seen that if an iron bar were suspended at point CL with a heavy weight hanging on it at the CG, it would take some downward pressure at point T to keep the "lever" in balance.

Even though the horizontal stabilizer may be level when the airplane is in level flight, there is a downwash of air from the wings. This downwash strikes the top of the stabilizer and produces a downward pressure, which at a certain speed will be just enough to balance the "lever." The faster the airplane is flying, the greater this downwash and the greater the downward force on the horizontal stabilizer (except "T" tails). [Figure 3-13] In airplanes with fixed position horizontal stabilizers, the airplane manufacturer sets the stabilizer at an angle that will provide the best stability (or balance) during flight at the design cruising speed and power setting. [Figure 3-14]

If the airplane's speed decreases, the speed of the air-flow over the wing is decreased. As a result of this decreased flow of air over the wing, the downwash is reduced, causing a lesser downward force on the horizontal stabilizer. In turn, the characteristic nose heaviness is accentuated, causing the airplane's nose to pitch down more. This places the airplane in a nose-low attitude, lessening the wing's angle of attack and drag and allowing the airspeed to increase. As the airplane continues in the nose-low attitude and its speed increases, the downward force on the horizontal stabilizer is once again increased.

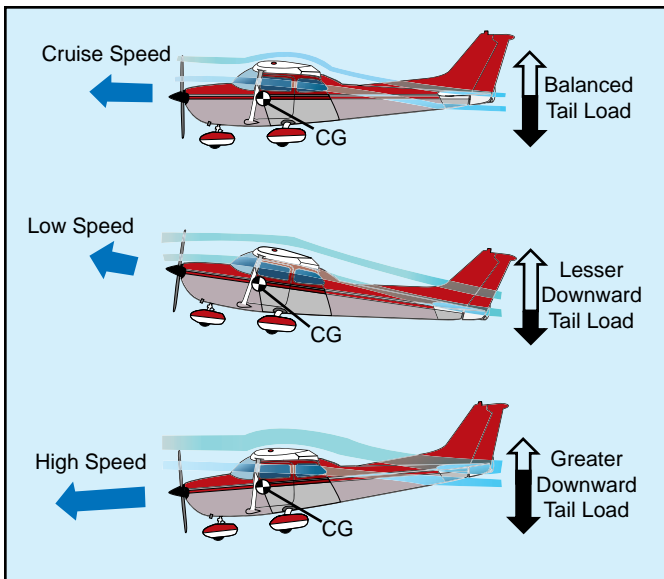

Figure 3-13. Effect of speed on downwash.

Consequently, the tail is again pushed downward and the nose rises into a climbing attitude.

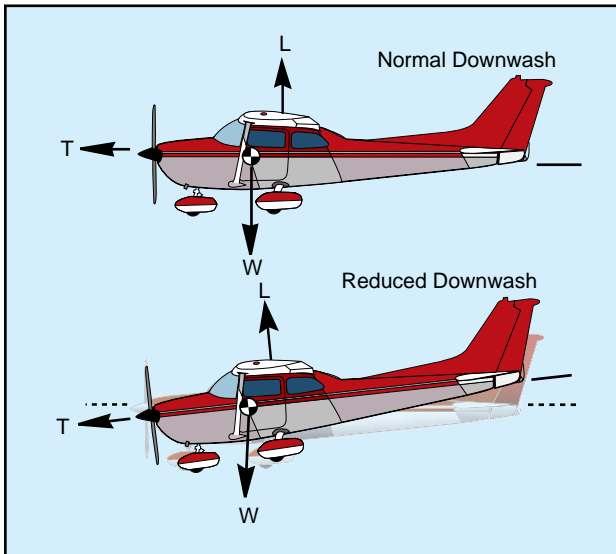

Figure 3-14. Reduced power allows pitch down.

As this climb continues, the airspeed again decreases, causing the downward force on the tail to decrease until the nose lowers once more. However, because the airplane is dynamically stable, the nose does not lower as far this time as it did before. The airplane will acquire enough speed in this more gradual dive to start it into another climb, but the climb is not so steep as the preceding one.

After several of these diminishing oscillations, in which the nose alternately rises and lowers, the airplane will finally settle down to a speed at which the downward force on the tail exactly counteracts the tendency of the airplane to dive. When this condition is attained, the airplane will once again

be in balanced flight and will continue in stabilized flight as long as this attitude and airspeed are not changed.

A similar effect will be noted upon closing the throttle. The downwash of the wings is reduced and the force at T in figure 3-12 is not enough to hold the horizontal stabilizer down. It is as if the force at T on the lever were allowing the force of gravity to pull the nose down. This, of course, is a desirable characteristic because the airplane is inherently trying to regain airspeed and reestablish the proper balance.

Power or thrust can also have a destabilizing effect in that an increase of power may tend to make the nose rise. The airplane designer can offset this by establishing a “high thrustline” wherein the line of thrust passes above the center of gravity. [Figures 3-15 and 3-16] In this case, as power or thrust is increased a moment is produced to counteract the down load on the tail. On the other hand, a very “low thrust line” would tend to add to the nose-up effect of the horizontal tail surface.

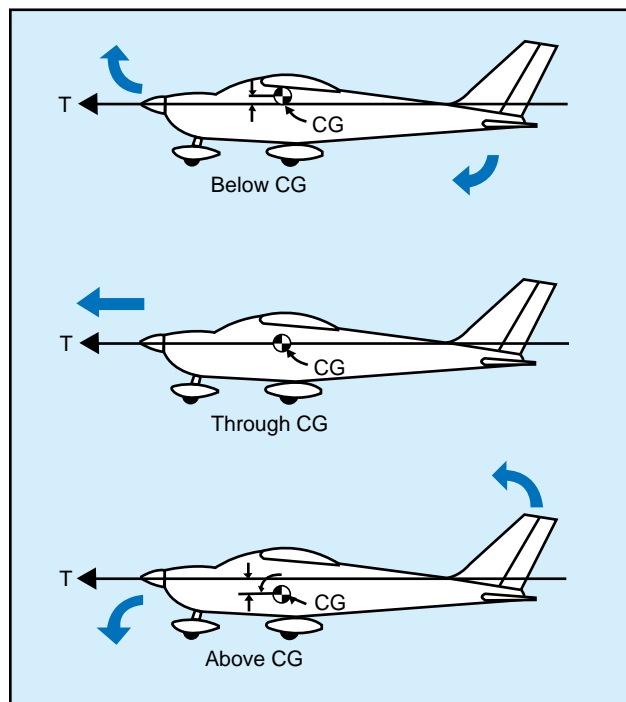

Figure 3-15. Thrust line affects longitudinal stability.

It can be concluded, then, that with the center of gravity forward of the center of lift, and with an aerodynamic tail-down force, the result is that the airplane always tries to return to a safe flying attitude.

A simple demonstration of longitudinal stability may be made as follows: Trim the airplane for “hands off” control in level flight. Then momentarily give the controls a slight push to nose the airplane down. If,

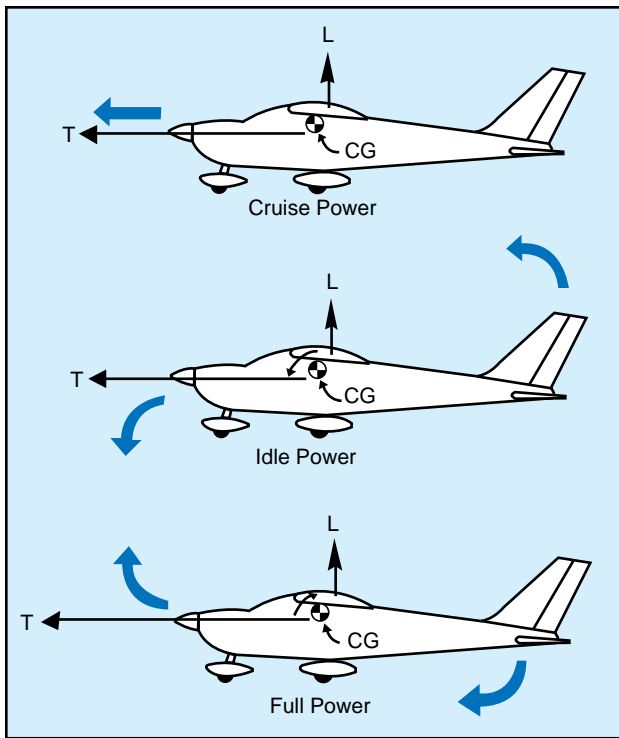

Figure 3-16. Power changes affect longitudinal stability.

within a brief period, the nose rises to the original position and then stops, the airplane is statically stable. Ordinarily, the nose will pass the original position (that of level flight) and a series of slow pitching oscillations will follow. If the oscillations gradually cease, the airplane has positive stability; if they continue unevenly, the airplane has neutral stability; if they increase, the airplane is unstable.

### LATERAL STABILITY (ROLLING)

Stability about the airplane's longitudinal axis, which extends from nose to tail, is called lateral stability. This helps to stabilize the lateral or rolling effect when one wing gets lower than the wing on the opposite side of the airplane. There are four main design factors that make an airplane stable laterally: dihedral, keel effect, sweepback, and weight distribution.

The most common procedure for producing lateral stability is to build the wings with a dihedral angle varying from one to three degrees. In other words, the wings on either side of the airplane join the fuselage to form a slight V or angle called "dihedral," and this is measured by the angle made by each wing above a line parallel to the lateral axis.

The basis of rolling stability is, of course, the lateral balance of forces produced by the airplane's wings. Any imbalance in lift results in a tendency for the airplane to roll about its longitudinal axis. Stated another way, dihedral involves a balance of

lift created by the wings' angle of attack on each side of the airplane's longitudinal axis.

If a momentary gust of wind forces one wing of the airplane to rise and the other to lower, the airplane will bank. When the airplane is banked without turning, it tends to sideslip or slide downward toward the lowered wing. [Figure 3-17] Since the wings have dihedral, the air strikes the low wing at much greater angle of attack than the high wing. This increases the lift on the low wing and decreases lift on the high wing, and tends to restore the airplane to its original lateral attitude (wings level)—that is, the angle of attack and lift on the two wings are again equal.

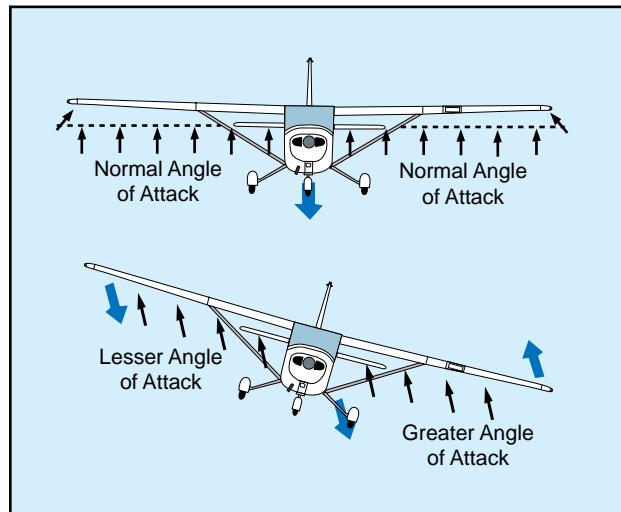

Figure 3-17. Dihedral for lateral stability.

The effect of dihedral, then, is to produce a rolling moment tending to return the airplane to a laterally balanced flight condition when a sideslip occurs.

The restoring force may move the low wing up too far, so that the opposite wing now goes down. If so, the process will be repeated, decreasing with each lateral oscillation until a balance for wings-level flight is finally reached.

Conversely, excessive dihedral has an adverse effect on lateral maneuvering qualities. The airplane may be so stable laterally that it resists any intentional rolling motion. For this reason, airplanes that require fast roll or banking characteristics usually have less dihedral than those designed for less maneuverability.

The contribution of sweepback to dihedral effect is important because of the nature of the contribution. In a sideslip, the wing into the wind is operating with an effective decrease in sweepback, while the wing out of the wind is operating with an effective increase in sweepback. The swept wing is responsive only to the wind component that is perpendicular to the wing's leading edge. Consequently, if the wing is

operating at a positive lift coefficient, the wing into the wind has an increase in lift, and the wing out of the wind has a decrease in lift. In this manner, the swept back wing would contribute a positive dihedral effect and the swept forward wing would contribute a negative dihedral effect.

During flight, the side area of the airplane's fuselage and vertical fin react to the airflow in much the same manner as the keel of a ship. That is, it exerts a steadying influence on the airplane laterally about the longitudinal axis.

Such laterally stable airplanes are constructed so that the greater portion of the keel area is above and behind the center of gravity. [Figure 3-18] Thus, when the airplane slips to one side, the combination of the airplane's weight and the pressure of the airflow against the upper portion of the keel area (both acting about the CG) tends to roll the airplane back to wings-level flight.

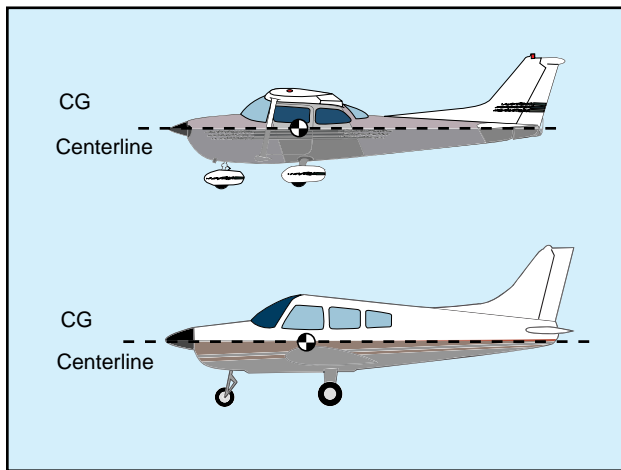

Figure 3-18. Keel area for lateral stability.

### VERTICAL STABILITY (YAWING)

Stability about the airplane's vertical axis (the sideways moment) is called yawing or directional stability.

Yawing or directional stability is the more easily achieved stability in airplane design. The area of the vertical fin and the sides of the fuselage aft of the center of gravity are the prime contributors which make the airplane act like the well known weathervane or arrow, pointing its nose into the relative wind.

In examining a weathervane, it can be seen that if exactly the same amount of surface were exposed to the wind in front of the pivot point as behind it, the forces fore and aft would be in balance and little or no directional movement would result. Consequently, it is necessary to have a greater surface aft of the pivot point than forward of it.

Similarly in an airplane, the designer must ensure positive directional stability by making the side surface greater aft than ahead of the center of gravity. [Figure 3-19] To provide more positive stability aside from that provided by the fuselage, a vertical fin is added. The fin acts similar to the feather on an arrow in maintaining straight flight. Like the weathervane and the arrow, the farther aft this fin is placed and the larger its size, the greater the airplane's directional stability.

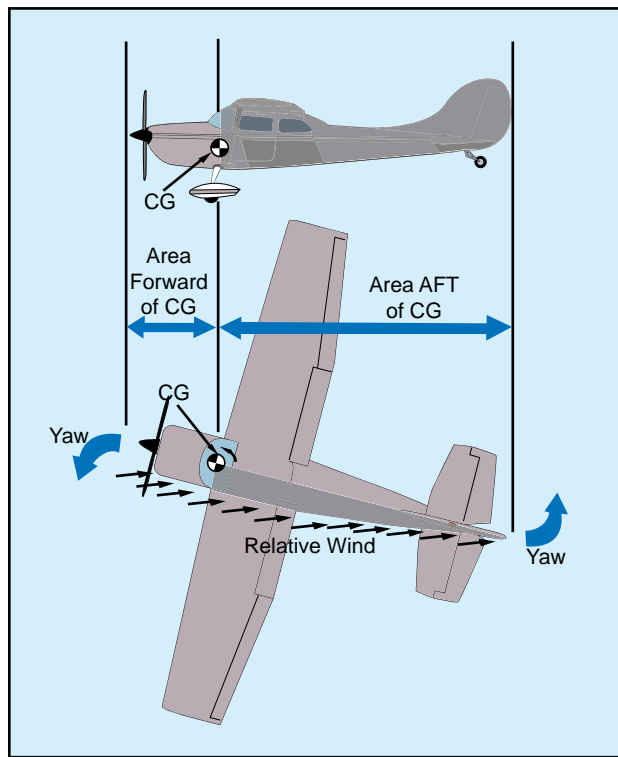

Figure 3-19. Fuselage and fin for vertical stability.

If an airplane is flying in a straight line, and a side-ward gust of air gives the airplane a slight rotation about its vertical axis (i.e., the right), the motion is retarded and stopped by the fin because while the airplane is rotating to the right, the air is striking the left side of the fin at an angle. This causes pressure on the left side of the fin, which resists the turning motion and slows down the airplane's yaw. In doing so, it acts somewhat like the weathervane by turning the airplane into the relative wind. The initial change in direction of the airplane's flightpath is generally slightly behind its change of heading. Therefore, after a slight yawing of the airplane to the right, there is a brief moment when the airplane is still moving along its original path, but its longitudinal axis is pointed slightly to the right.

The airplane is then momentarily skidding sideways, and during that moment (since it is assumed that although the yawing motion has stopped, the excess pressure on the left side of the fin still persists) there



is necessarily a tendency for the airplane to be turned partially back to the left. That is, there is a momentary restoring tendency caused by the fin.

This restoring tendency is relatively slow in developing and ceases when the airplane stops skidding. When it ceases, the airplane will be flying in a direction slightly different from the original direction. In other words, it will not of its own accord return to the original heading; the pilot must reestablish the initial heading.

A minor improvement of directional stability may be obtained through sweepback. Sweepback is incorporated in the design of the wing primarily to delay the onset of compressibility during high-speed flight. In lighter and slower airplanes, sweepback aids in locating the center of pressure in the correct relationship with the center of gravity. A longitudinally stable airplane is built with the center of pressure aft of the center of gravity.

Because of structural reasons, airplane designers sometimes cannot attach the wings to the fuselage at the exact desired point. If they had to mount the wings too far forward, and at right angles to the fuselage, the center of pressure would not be far enough to the rear to result in the desired amount of longitudinal stability. By building sweepback into the wings, however, the designers can move the center of pressure toward the rear. The amount of sweepback and the position of the wings then place the center of pressure in the correct location.

The contribution of the wing to static directional stability is usually small. The swept wing provides a stable contribution depending on the amount of sweepback, but the contribution is relatively small when compared with other components.

### **FREE DIRECTIONAL OSCILLATIONS (DUTCH ROLL)**

Dutch Roll is a coupled lateral/directional oscillation that is usually dynamically stable but is objectionable in an airplane because of the oscillatory nature. The damping of the oscillatory mode may be weak or strong depending on the properties of the particular airplane.

Unfortunately all air is not smooth. There are bumps and depressions created by gusty updrafts and downdrafts, and by gusts from ahead, behind, or the side of the airplane.

The response of the airplane to a disturbance from equilibrium is a combined rolling/yawing oscillation in which the rolling motion is phased to precede the yawing motion. The yawing motion is not too

significant, but the roll is much more noticeable. When the airplane rolls back toward level flight in response to dihedral effect, it rolls back too far and sideslips the other way. Thus, the airplane overshoots each time because of the strong dihedral effect. When the dihedral effect is large in comparison with static directional stability, the Dutch Roll motion has weak damping and is objectionable. When the static directional stability is strong in comparison with the dihedral effect, the Dutch Roll motion has such heavy damping that it is not objectionable. However, these qualities tend toward spiral instability.

The choice is then the least of two evils—Dutch Roll is objectionable and spiral instability is tolerable if the rate of divergence is low. Since the more important handling qualities are a result of high static directional stability and minimum necessary dihedral effect, most airplanes demonstrate a mild spiral tendency. This tendency would be indicated to the pilot by the fact that the airplane cannot be flown “hands off” indefinitely.

In most modern airplanes, except high-speed swept wing designs, these free directional oscillations usually die out automatically in a very few cycles unless the air continues to be gusty or turbulent. Those airplanes with continuing Dutch Roll tendencies usually are equipped with gyro stabilized yaw dampers. An airplane that has Dutch Roll tendencies is disconcerting, to say the least. Therefore, the manufacturer tries to reach a medium between too much and too little directional stability. Because it is more desirable for the airplane to have “spiral instability” than Dutch Roll tendencies, most airplanes are designed with that characteristic.

### **SPIRAL INSTABILITY**

Spiral instability exists when the static directional stability of the airplane is very strong as compared to the effect of its dihedral in maintaining lateral equilibrium. When the lateral equilibrium of the airplane is disturbed by a gust of air and a sideslip is introduced, the strong directional stability tends to yaw the nose into the resultant relative wind while the comparatively weak dihedral lags in restoring the lateral balance. Due to this yaw, the wing on the outside of the turning moment travels forward faster than the inside wing and as a consequence, its lift becomes greater. This produces an overbanking tendency which, if not corrected by the pilot, will result in the bank angle becoming steeper and steeper. At the same time, the strong directional stability that yaws the airplane into the relative wind is actually forcing the nose to a lower pitch attitude. Then, the start of a slow downward

spiral which has begun, if not counteracted by the pilot, will gradually increase into a steep spiral dive. Usually the rate of divergence in the spiral motion is so gradual that the pilot can control the tendency without any difficulty.

All airplanes are affected to some degree by this characteristic although they may be inherently stable in all other normal parameters. This tendency would be indicated to the pilot by the fact that the airplane cannot be flown “hands off” indefinitely.

Much study and effort has gone into development of control devices (wing leveler) to eliminate or at least correct this instability. Advanced stages of this spiral condition demand that the pilot be very careful in application of recovery controls, or excessive loads on the structure may be imposed. Of the in-flight structural failures that have occurred in general aviation airplanes, improper recovery from this condition has probably been the underlying cause of more fatalities than any other single factor. The reason is that the airspeed in the spiral condition builds up rapidly, and the application of back elevator force to reduce this speed and to pull the nose up only “tightens the turn,” increasing the load factor. The results of the prolonged uncontrolled spiral are always the same; either in-flight structural failure, crashing into the ground, or both. The most common causes on record for getting into this situation are: loss of horizon reference, inability of the pilot to control the airplane by reference to instruments, or a combination of both.

## AERODYNAMIC FORCES IN FLIGHT MANEUVERS

### FORCES IN TURNS

If an airplane were viewed in straight-and-level flight from the rear [figure 3-20], and if the forces acting on the airplane actually could be seen, two forces (lift and weight)

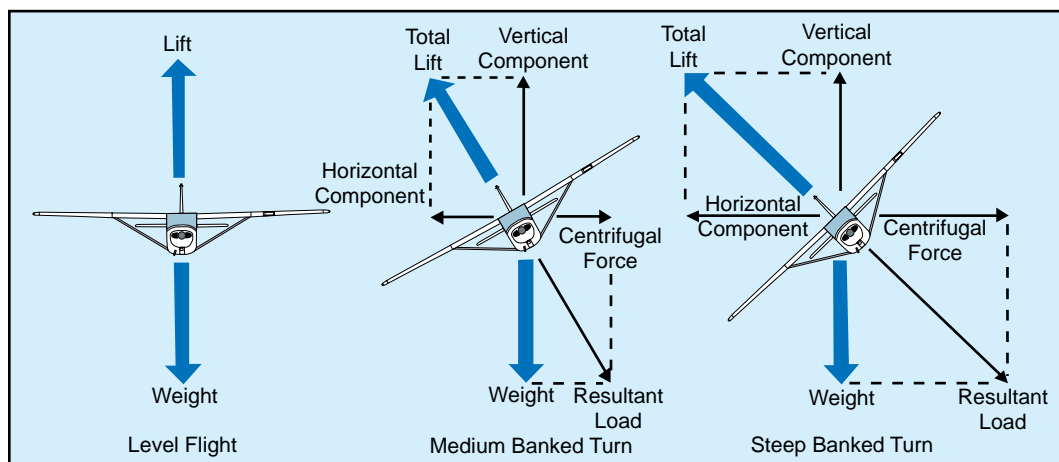

Figure 3-20. Forces during normal coordinated turn.

**Centripetal Force** – The force opposite centrifugal force and attracts a body towards its axis of rotation.

would be apparent, and if the airplane were in a bank it would be apparent that lift did not act directly opposite to the weight—it now acts in the direction of the bank. The fact that when the airplane banks, lift acts inward toward the center of the turn, as well as upward, is one of the basic truths to remember in the consideration of turns.

An object at rest or moving in a straight line will remain at rest or continue to move in a straight line until acted on by some other force. An airplane, like any moving object, requires a sideward force to make it turn. In a normal turn, this force is supplied by banking the airplane so that lift is exerted inward as well as upward. The force of lift during a turn is separated into two components at right angles to each other. One component, which acts vertically and opposite to the weight (gravity), is called the “vertical component of lift.” The other, which acts horizontally toward the center of the turn, is called the “horizontal component of lift,” or **centripetal force**. The horizontal component of lift is the force that pulls the airplane from a straight flightpath to make it turn. **Centrifugal force** is the “equal and opposite reaction” of the airplane to the change in direction and acts equal and opposite to the horizontal component of lift. This explains why, in a correctly executed turn, the force that turns the airplane is not supplied by the rudder.

An airplane is not steered like a boat or an automobile; in order for it to turn, it must be banked. If the airplane is not banked, there is no force available that will cause it to deviate from a straight flightpath. Conversely, when an airplane is banked, it will turn, provided it is not slipping to the inside of the turn. Good directional control is based on the fact that the airplane will attempt to turn whenever it is banked.

**Centrifugal Force**—An apparent force resulting from the effect of inertia during a turn.

This fact should be borne in mind at all times, particularly while attempting to hold the airplane in straight-and-level flight.

Merely banking the airplane into a turn produces no change in the total amount of lift developed. However, as was pointed out, the lift during the bank is divided into two components: one vertical and the other horizontal. This division reduces the amount of lift which is opposing gravity and actually supporting the airplane's weight; consequently, the airplane loses altitude unless additional lift is created. This is done by increasing the angle of attack until the vertical component of lift is again equal to the weight. Since the vertical component of lift decreases as the bank angle increases, the angle of attack must be progressively increased to produce sufficient vertical lift to support the airplane's weight. The fact that the vertical component of lift must be equal to the weight to maintain altitude is an important fact to remember when making constant altitude turns.

At a given airspeed, the rate at which an airplane turns depends upon the magnitude of the horizontal component of lift. It will be found that the horizontal component of lift is proportional to the angle of bank—that is, it increases or decreases respectively as the angle of bank increases or decreases. It logically follows then, that as the angle of bank is increased the horizontal component of lift increases, thereby increasing the rate of turn. Consequently, at any given airspeed the rate of turn can be controlled by adjusting the angle of bank.

To provide a vertical component of lift sufficient to hold altitude in a level turn, an increase in the angle of attack is required. Since the drag of the airfoil is directly proportional to its angle of attack, induced drag will increase as the lift is increased. This, in turn, causes a loss of airspeed in proportion to the

angle of bank; a small angle of bank results in a small reduction in airspeed and a large angle of bank results in a large reduction in airspeed. Additional thrust (power) must be applied to prevent a reduction in airspeed in level turns; the required amount of additional thrust is proportional to the angle of bank.

To compensate for added lift, which would result if the airspeed were increased during a turn, the angle of attack must be decreased, or the angle of bank increased, if a constant altitude were to be maintained. If the angle of bank were held constant and the angle of attack decreased, the rate of turn would decrease. Therefore, in order to maintain a constant rate of turn as the airspeed is increased, the angle of attack must remain constant and the angle of bank increased.

It must be remembered that an increase in airspeed results in an increase of the turn radius and that centrifugal force is directly proportional to the radius of the turn. In a correctly executed turn, the horizontal component of lift must be exactly equal and opposite to the centrifugal force. Therefore, as the airspeed is increased in a constant rate level turn, the radius of the turn increases. This increase in the radius of turn causes an increase in the centrifugal force, which must be balanced by an increase in the horizontal component of lift, which can only be increased by increasing the angle of bank.

In a slipping turn, the airplane is not turning at the rate appropriate to the bank being used, since the airplane is yawed toward the outside of the turning flightpath. The airplane is banked too much for the rate of turn, so the horizontal lift component is greater than the centrifugal force. [Figure 3-21] Equilibrium between the horizontal lift component and centrifugal force is reestablished either by

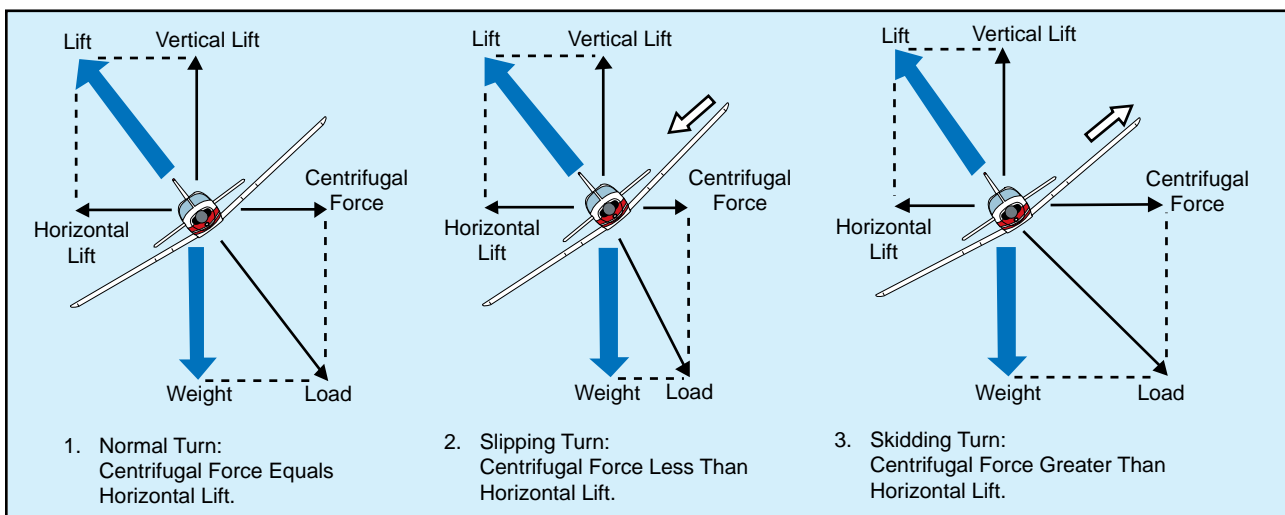

Figure 3-21. Normal, sloping, and skidding turns.

decreasing the bank, increasing the rate of turn, or a combination of the two changes.

A skidding turn results from an excess of centrifugal force over the horizontal lift component, pulling the airplane toward the outside of the turn. The rate of turn is too great for the angle of bank. Correction of a skidding turn thus involves a reduction in the rate of turn, an increase in bank, or a combination of the two changes.

To maintain a given rate of turn, the angle of bank must be varied with the airspeed. This becomes particularly important in high-speed airplanes. For instance, at 400 miles per hour (m.p.h.), an airplane must be banked approximately  $44^\circ$  to execute a standard rate turn ( $3^\circ$  per second). At this angle of bank, only about 79 percent of the lift of the airplane comprises the vertical component of the lift; the result is a loss of altitude unless the angle of attack is increased sufficiently to compensate for the loss of vertical lift.

### FORCES IN CLIMBS

For all practical purposes, the wing's lift in a steady state normal climb is the same as it is in a steady level flight at the same airspeed. Though the airplane's flightpath has changed when the climb has been established, the angle of attack of the wing with respect to the inclined flightpath reverts to practically the same values, as does the lift. There is an initial momentary change, however, as shown in figure 3-22. During the transition from straight-and-level flight to a climb, a change in lift occurs when back elevator pressure is first applied. Raising the airplane's nose increases the angle of attack and momentarily increases the lift. Lift at this moment is now greater than weight and starts the airplane climbing. After the flightpath is stabilized on the upward incline, the angle of attack and lift again revert to about the level flight values.

If the climb is entered with no change in power setting, the airspeed gradually diminishes because the

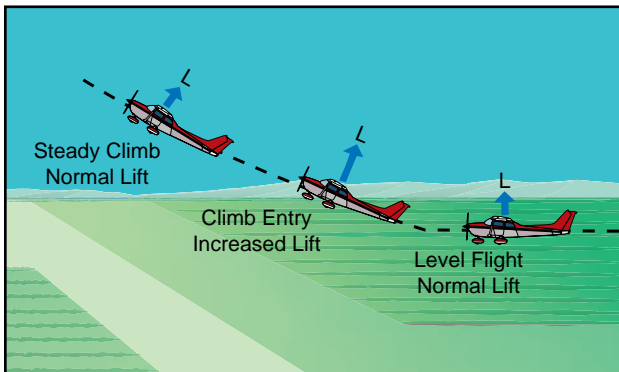

Figure 3-22. Changes in lift during climb entry.

thrust required to maintain a given airspeed in level flight is insufficient to maintain the same airspeed in a climb. When the flightpath is inclined upward, a component of the airplane's weight acts in the same direction as, and parallel to, the total drag of the airplane, thereby increasing the total effective drag. Consequently, the total drag is greater than the power, and the airspeed decreases. The reduction in airspeed gradually results in a corresponding decrease in drag until the total drag (including the component of weight acting in the same direction) equals the thrust. [Figure 3-23] Due to momentum, the change in airspeed is gradual, varying considerably with differences in airplane size, weight, total drag, and other factors.

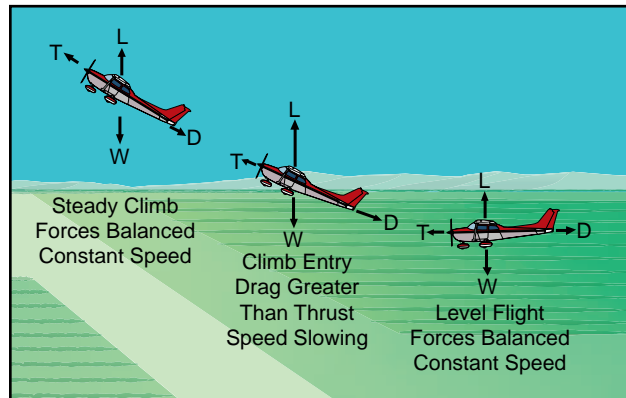

Figure 3-23. Changes in speed during climb entry.

Generally, the forces of thrust and drag, and lift and weight, again become balanced when the airspeed stabilizes but at a value lower than in straight-and-level flight at the same power setting. Since in a climb the airplane's weight is not only acting downward but rearward along with drag, additional power is required to maintain the same airspeed as in level flight. The amount of power depends on the angle of climb. When the climb is established so steep that there is insufficient power available, a slower speed results. It will be seen then that the amount of reserve power determines the climb performance of the airplane.

### FORCES IN DESCENTS

As in climbs, the forces acting on the airplane go through definite changes when a descent is entered from straight-and-level flight. The analysis here is that of descending at the same power as used in straight-and-level flight.

When forward pressure is applied to the elevator control to start descending, or the airplane's nose is allowed to pitch down, the angle of attack is reduced. This reduction in total lift and angle of attack is momentary and occurs during the time the

flightpath changes downward. The change to a downward flightpath is due to the lift momentarily becoming less than the weight of the airplane as the angle of attack is reduced. This imbalance between lift and weight causes the airplane to follow a descending flightpath with respect to the horizontal flightpath of straight-and-level flight. When the flightpath is in a steady descent, the airfoil's angle of attack again approaches the original value, and lift and weight will again become stabilized. From the time the descent is started until it is stabilized, the airspeed will gradually increase. This is due to a component of weight now acting forward along the flightpath, similar to the manner it acted rearward in a climb. The overall effect is that of increased power or thrust, which in turn causes the increase in airspeed associated with descending at the same power as used in level flight.

To descend at the same airspeed as used in straight-and-level flight, obviously, the power must be reduced as the descent is entered. The component of weight acting forward along the flightpath will increase as the angle of rate of descent increases and conversely, will decrease as the angle of rate of descent decreases. Therefore, the amount of power reduction required for a descent at the same speed as cruise will be determined by the steepness of the descent.

## STALLS

An airplane will fly as long as the wing is creating sufficient lift to counteract the load imposed on it. When the lift is completely lost, the airplane stalls.

Remember, the direct cause of every stall is an excessive angle of attack. There are any number of flight maneuvers which may produce an increase in the angle of attack, but the stall does not occur until the angle of attack becomes excessive.

It must be emphasized that the stalling speed of a particular airplane is not a fixed value for all flight situations. However, a given airplane will always stall at the same angle of attack regardless of airspeed, weight, load factor, or density altitude. Each airplane has a particular angle of attack where the airflow separates from the upper surface of the wing and the stall occurs. This critical angle of attack varies from  $16^\circ$  to  $20^\circ$  depending on the airplane's design. But each airplane has only one specific angle of attack where the stall occurs.

There are three situations in which the critical angle of attack can be exceeded: in low-speed flying, in high-speed flying, and in turning flight.

The airplane can be stalled in straight-and-level flight by flying too slowly. As the airspeed is being

decreased, the angle of attack must be increased to retain the lift required for maintaining altitude. The slower the airspeed becomes, the more the angle of attack must be increased. Eventually, an angle of attack is reached which will result in the wing not producing enough lift to support the airplane and it will start settling. If the airspeed is reduced further, the airplane will stall, since the angle of attack has exceeded the critical angle and the airflow over the wing is disrupted.

It must be reemphasized here that low speed is not necessary to produce a stall. The wing can be brought into an excessive angle of attack at any speed. For example, take the case of an airplane which is in a dive with an airspeed of 200 knots when suddenly the pilot pulls back sharply on the elevator control. [Figure 3-24] Because of gravity and centrifugal force, the airplane could not immediately alter its flightpath but would merely change its angle of attack abruptly from quite low to very high. Since the flightpath of the airplane in relation to the oncoming air determines the direction of the relative wind, the angle of attack is suddenly increased, and the airplane would quickly reach the stalling angle at a speed much greater than the normal stall speed.

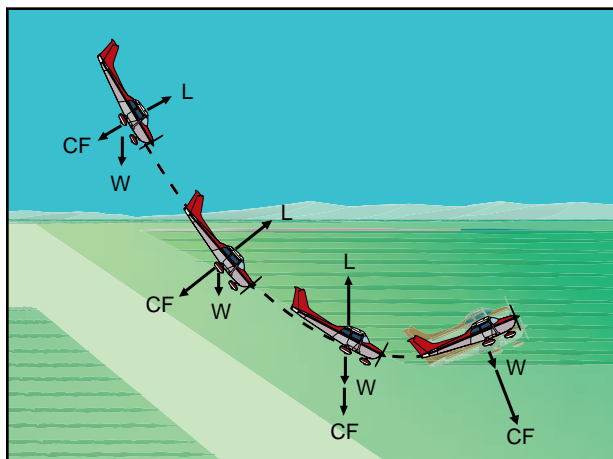

Figure 3-24. Forces exerted when pulling out of a dive.

Similarly, the stalling speed of an airplane is higher in a level turn than in straight-and-level flight. [Figure 3-25] This is because centrifugal force is added to the airplane's weight, and the wing must produce sufficient additional lift to counterbalance the load imposed by the combination of centrifugal force and weight. In a turn, the necessary additional lift is acquired by applying back pressure to the elevator control. This increases the wing's angle of attack, and results in increased lift. The angle of attack must increase as the bank angle increases to counteract the increasing load caused by centrifugal force. If at any time during a turn the angle of attack becomes excessive, the airplane will stall.

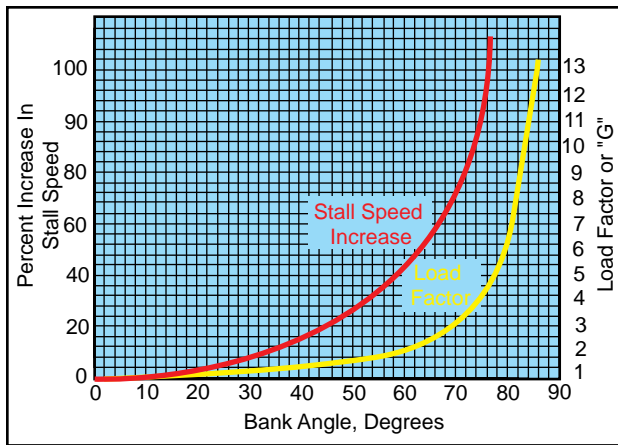

Figure 3-25. Increase in stall speed and load factor.

At this point, the action of the airplane during a stall should be examined. To balance the airplane aerodynamically, the center of lift is normally located aft of the center of gravity. Although this makes the airplane inherently “nose heavy,” downwash on the horizontal stabilizer counteracts this condition. It can be seen then, that at the point of stall when the upward force of the wing’s lift and the downward tail force cease, an unbalanced condition exists. This allows the airplane to pitch down abruptly, rotating about its center of gravity. During this nose-down attitude, the angle of attack decreases and the airspeed again increases; hence, the smooth flow of air over the wing begins again, lift returns, and the airplane is again flying. However, considerable altitude may be lost before this cycle is complete.

## BASIC PROPELLER PRINCIPLES

The airplane propeller consists of two or more blades and a central hub to which the blades are attached. Each blade of an airplane propeller is essentially a rotating wing. As a result of their construction, the propeller blades are like airfoils and produce forces that create the thrust to pull, or push, the airplane through the air.

The power needed to rotate the propeller blades is furnished by the engine. The engine rotates the airfoils of the blades through the air at high speeds, and the propeller transforms the rotary power of the engine into forward thrust.

An airplane moving through the air creates a drag force opposing its forward motion. Consequently, if an airplane is to fly, there must be a force applied to it that is equal to the drag, but acting forward. This force is called “thrust.”

A cross section of a typical propeller blade is shown in figure 3-26. This section or blade element is an

airfoil comparable to a cross section of an airplane wing. One surface of the blade is cambered or curved, similar to the upper surface of an airplane wing, while the other surface is flat like the bottom surface of a wing. The chord line is an imaginary line drawn through the blade from its leading edge to its trailing edge. As in a wing, the leading edge is the thick edge of the blade that meets the air as the propeller rotates.

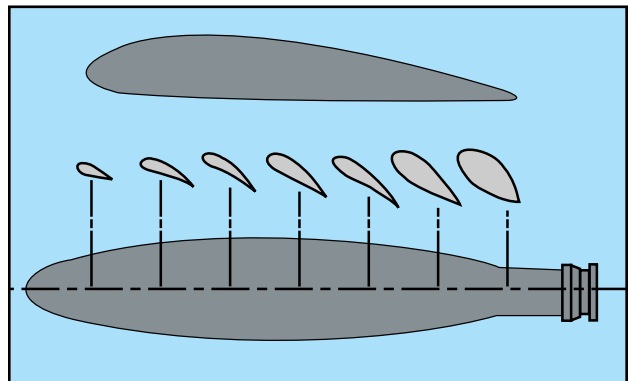

Figure 3-26. Airfoil sections of propeller blade.

Blade angle, usually measured in degrees, is the angle between the chord of the blade and the plane of rotation [figure 3-27] and is measured at a specific point along the length of the blade. Because most propellers have a flat blade “face,” the chord line is often drawn along the face of the propeller blade. Pitch is not the same as blade angle, but because pitch is largely determined by blade angle, the two terms are often used interchangeably. An increase or decrease in one is usually associated with an increase or decrease in the other.

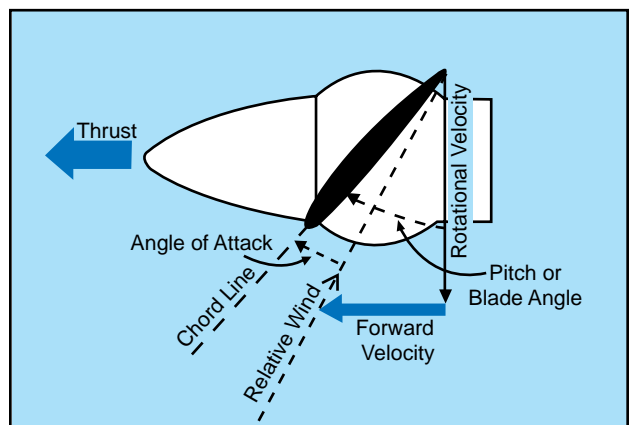

Figure 3-27. Propeller blade angle.

The pitch of a propeller may be designated in inches. A propeller designated as a “74-48” would be 74 inches in length and have an effective pitch of 48 inches. The pitch in inches is the distance which the propeller would screw through the air in one revolution if there were no slippage.

When specifying a fixed-pitch propeller for a new type of airplane, the manufacturer usually selects one with a pitch that will operate efficiently at the expected cruising speed of the airplane. Unfortunately, however, every fixed-pitch propeller must be a compromise, because it can be efficient at only a given combination of airspeed and r.p.m. Pilots do not have it within their power to change this combination in flight.

When the airplane is at rest on the ground with the engine operating, or moving slowly at the beginning of takeoff, the propeller efficiency is very low because the propeller is restrained from advancing with sufficient speed to permit its fixed-pitch blades to reach their full efficiency. In this situation, each propeller blade is turning through the air at an angle of attack that produces relatively little thrust for the amount of power required to turn it.

To understand the action of a propeller, consider first its motion, which is both rotational and forward. Thus, as shown by the vectors of propeller forces in figure 3-27, each section of a propeller blade moves downward and forward. The angle at which this air (relative wind) strikes the propeller blade is its angle of attack. The air deflection produced by this angle causes the dynamic pressure at the engine side of the propeller blade to be greater than atmospheric, thus creating thrust.

The shape of the blade also creates thrust, because it is cambered like the airfoil shape of a wing. Consequently, as the air flows past the propeller, the pressure on one side is less than that on the other. As in a wing, this produces a reaction force in the direction of the lesser pressure. In the case of a wing, the airflow over the wing has less pressure, and the force (lift) is upward. In the case of the propeller, which is mounted in a vertical instead of a horizontal plane, the area of decreased pressure is in front of the propeller, and the force (thrust) is in a forward direction. Aerodynamically, then, thrust is the result of the propeller shape and the angle of attack of the blade.

Another way to consider thrust is in terms of the mass of air handled by the propeller. In these terms, thrust is equal to the mass of air handled, times the slipstream velocity, minus the velocity of the airplane. The power expended in producing thrust depends on the rate of air mass movement. On the average, thrust constitutes approximately 80 percent of the torque (total horsepower absorbed by the propeller). The other 20 percent is lost in friction and slippage. For any speed of rotation, the horsepower absorbed by the propeller balances the horsepower delivered by the engine. For any single revolution of the propeller, the

amount of air handled depends on the blade angle, which determines how big a “bite” of air the propeller takes. Thus, the blade angle is an excellent means of adjusting the load on the propeller to control the engine r.p.m.

The blade angle is also an excellent method of adjusting the angle of attack of the propeller. On constant-speed propellers, the blade angle must be adjusted to provide the most efficient angle of attack at all engine and airplane speeds. Lift versus drag curves, which are drawn for propellers as well as wings, indicate that the most efficient angle of attack is a small one varying from  $2^{\circ}$  to  $4^{\circ}$  positive. The actual blade angle necessary to maintain this small angle of attack varies with the forward speed of the airplane.

Fixed-pitch and ground-adjustable propellers are designed for best efficiency at one rotation and forward speed. They are designed for a given airplane and engine combination. A propeller may be used that provides the maximum propeller efficiency for either takeoff, climb, cruise, or high-speed flight. Any change in these conditions results in lowering the efficiency of both the propeller and the engine. Since the efficiency of any machine is the ratio of the useful power output to the actual power input, propeller efficiency is the ratio of thrust horsepower to brake horsepower. Propeller efficiency varies from 50 to 87 percent, depending on how much the propeller “slips.”

Propeller slip is the difference between the geometric pitch of the propeller and its effective pitch. [Figure 3-28] Geometric pitch is the theoretical distance a propeller should advance in one revolution; effective pitch is the distance it actually advances. Thus, geometric or theoretical pitch is based on no slippage, but actual or effective pitch includes propeller slippage in the air.

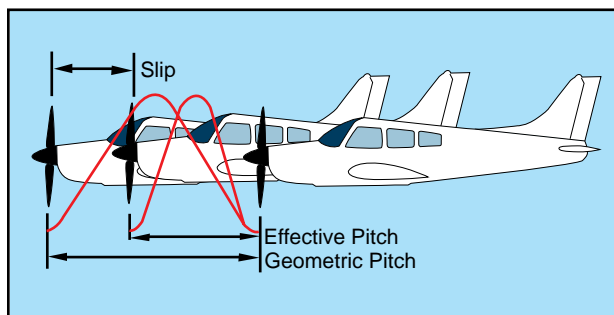

Figure 3-28. Propeller slippage.

The reason a propeller is “twisted” is that the outer parts of the propeller blades, like all things that turn about a central point, travel faster than the portions near the hub. [Figure 3-29] If the blades had the

same geometric pitch throughout their lengths, at cruise speed the portions near the hub could have negative angles of attack while the propeller tips would be stalled. “Twisting,” or variations in the geometric pitch of the blades, permits the propeller to operate with a relatively constant angle of attack along its length when in cruising flight. To put it another way, propeller blades are twisted to change the blade angle in proportion to the differences in speed of rotation along the length of the propeller and thereby keep thrust more nearly equalized along this length.

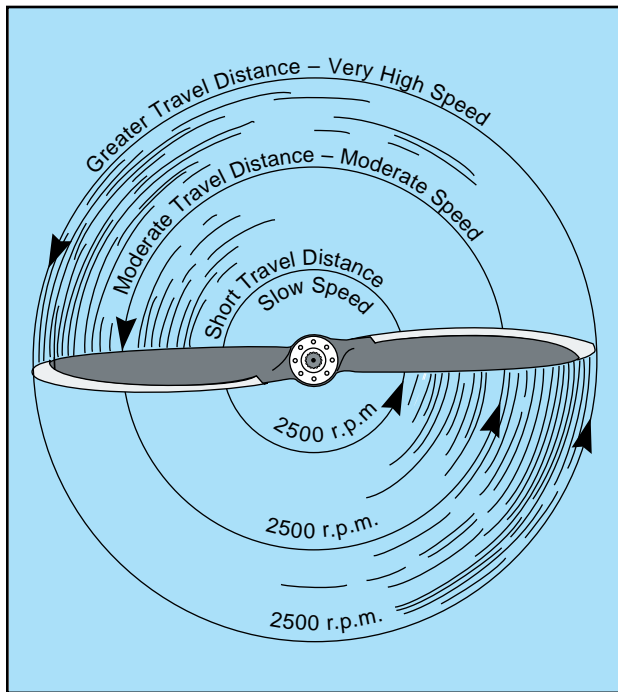

Figure 3-29. Propeller tips travel faster than hubs.

Usually  $1^{\circ}$  to  $4^{\circ}$  provides the most efficient lift/drag ratio, but in flight the propeller angle of attack of a fixed-pitch propeller will vary—normally from  $0^{\circ}$  to  $15^{\circ}$ . This variation is caused by changes in the relative airstream which in turn results from changes in airplane speed. In short, propeller angle of attack is the product of two motions: propeller rotation about its axis and its forward motion.

A constant-speed propeller, however, automatically keeps the blade angle adjusted for maximum efficiency for most conditions encountered in flight. During takeoff, when maximum power and thrust are required, the constant-speed propeller is at a low propeller blade angle or pitch. The low blade angle keeps the angle of attack small and efficient with respect to the relative wind. At the same time, it allows the propeller to handle a smaller mass of air per revolution. This light load allows the engine to turn at high r.p.m. and to convert the maximum amount of fuel into heat energy in a given time. The

high r.p.m. also creates maximum thrust; for, although the mass of air handled per revolution is small, the number of revolutions per minute is many, the slipstream velocity is high, and with the low airplane speed, the thrust is maximum.

After liftoff, as the speed of the airplane increases, the constant-speed propeller automatically changes to a higher angle (or pitch). Again, the higher blade angle keeps the angle of attack small and efficient with respect to the relative wind. The higher blade angle increases the mass of air handled per revolution. This decreases the engine r.p.m., reducing fuel consumption and engine wear, and keeps thrust at a maximum.

After the takeoff climb is established in an airplane having a controllable-pitch propeller, the pilot reduces the power output of the engine to climb power by first decreasing the manifold pressure and then increasing the blade angle to lower the r.p.m.

At cruising altitude, when the airplane is in level flight and less power is required than is used in takeoff or climb, the pilot again reduces engine power by reducing the manifold pressure and then increasing the blade angle to decrease the r.p.m. Again, this provides a torque requirement to match the reduced engine power; for, although the mass of air handled per revolution is greater, it is more than offset by a decrease in slipstream velocity and an increase in airspeed. The angle of attack is still small because the blade angle has been increased with an increase in airspeed.

### TORQUE AND P FACTOR

To the pilot, “torque” (the left turning tendency of the airplane) is made up of four elements which cause or produce a twisting or rotating motion around at least one of the airplane’s three axes. These four elements are:

1. Torque Reaction from Engine and Propeller.
2. Corkscrewing Effect of the Slipstream.
3. Gyroscopic Action of the Propeller.
4. Asymmetric Loading of the Propeller (P Factor).

### TORQUE REACTION

Torque reaction involves Newton’s Third Law of Physics—for every action, there is an equal and opposite reaction. As applied to the airplane, this means that as the internal engine parts and propeller are revolving in one direction, an equal force is trying to rotate the airplane in the opposite direction. [Figure 3-30]



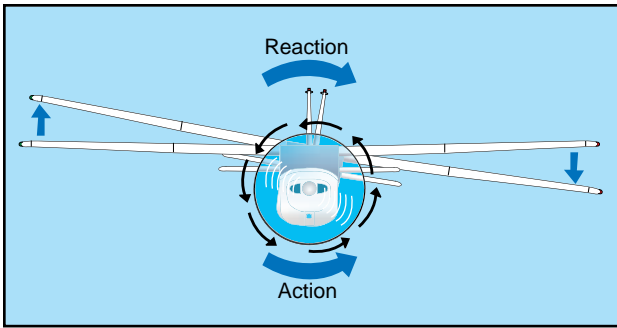

Figure 3-30. Torque reaction.

When the airplane is airborne, this force is acting around the longitudinal axis, tending to make the airplane roll. To compensate for this, some of the older airplanes are rigged in a manner to create more lift on the wing that is being forced downward. The more modern airplanes are designed with the engine offset to counteract this effect of torque.

*NOTE—Most United States built aircraft engines rotate the propeller clockwise, as viewed from the pilot's seat. The discussion here is with reference to those engines.*

Generally, the compensating factors are permanently set so that they compensate for this force at cruising speed, since most of the airplane's operating lift is at that speed. However, aileron trim tabs permit further adjustment for other speeds.

When the airplane's wheels are on the ground during the takeoff roll, an additional turning moment around the vertical axis is induced by torque reaction. As the left side of the airplane is being forced down by torque reaction, more weight is being placed on the left main landing gear. This results in more ground friction, or drag, on the left tire than on the right, causing a further turning moment to the left. The magnitude of this moment is dependent on many variables. Some of these variables are: (1) size and horsepower of engine, (2) size of propeller and the r.p.m., (3) size of the airplane, and (4) condition of the ground surface.

This yawing moment on the takeoff roll is corrected by the pilot's proper use of the rudder or rudder trim.

### CORKSCREW EFFECT

The high-speed rotation of an airplane propeller gives a corkscrew or spiraling rotation to the slipstream. At high propeller speeds and low forward speed (as in the takeoffs and approaches to power-on stalls), this spiraling rotation is very compact and exerts a strong sideward force on the airplane's vertical tail surface. [Figure 3-31]

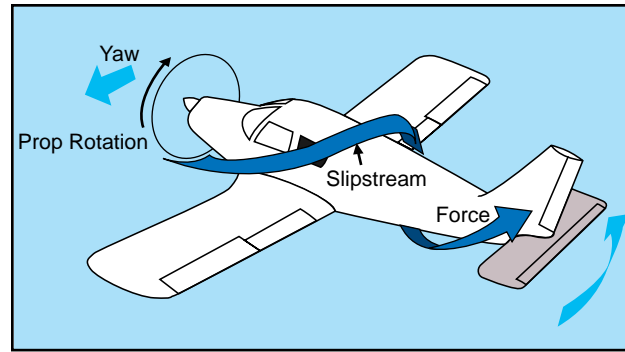

Figure 3-31. Corkscrewing slipstream.

When this spiraling slipstream strikes the vertical fin on the left, it causes a left turning moment about the airplane's vertical axis. The more compact the spiral, the more prominent this force is. As the forward speed increases, however, the spiral elongates and becomes less effective.

The corkscrew flow of the slipstream also causes a rolling moment around the longitudinal axis.

Note that this rolling moment caused by the corkscrew flow of the slipstream is to the right, while the rolling moment caused by torque reaction is to the left—in effect one may be counteracting the other. However, these forces vary greatly and it is up to the pilot to apply proper correction action by use of the flight controls at all times. These forces must be counteracted regardless of which is the most prominent at the time.

### GYROSCOPIC ACTION

Before the gyroscopic effects of the propeller can be understood, it is necessary to understand the basic principle of a gyroscope.

All practical applications of the gyroscope are based upon two fundamental properties of gyroscopic action: rigidity in space and precession. The one of interest for this discussion is precession.

Precession is the resultant action, or deflection, of a spinning rotor when a deflecting force is applied to its rim. As can be seen in figure 3-32, when a force is applied, the resulting force takes effect 90° ahead of and in the direction of rotation.

The rotating propeller of an airplane makes a very good gyroscope and thus has similar properties. Any time a force is applied to deflect the propeller out of its plane of rotation, the resulting force is 90° ahead of and in the direction of rotation and in the direction of application, causing a pitching moment, a yawing moment, or a combination of the two depending upon the point at which the force was applied.

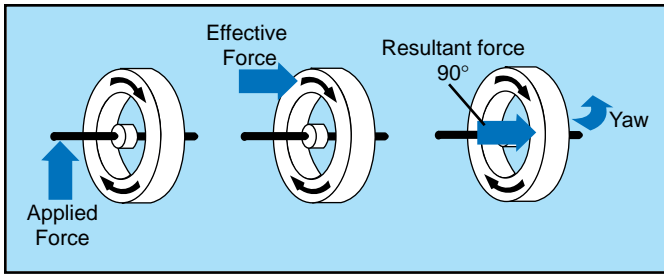

Figure 3-32. Gyroscopic precession.

This element of torque effect has always been associated with and considered more prominent in tailwheel-type airplanes, and most often occurs when the tail is being raised during the takeoff roll. [Figure 3-33] This change in pitch attitude has the same effect as applying a force to the top of the propeller's plane of rotation. The resultant force acting 90° ahead causes a yawing moment to the left around the vertical axis. The magnitude of this moment depends on several variables, one of which is the abruptness with which the tail is raised (amount of force applied). However, precession, or gyroscopic action, occurs when a force is applied to any point on the rim of the propeller's plane of rotation; the resultant force will still be 90° from the point of application in the direction of rotation. Depending on where the force is applied, the airplane is caused to yaw left or right, to pitch up or down, or a combination of pitching and yawing.

It can be said that as a result of gyroscopic action—any yawing around the vertical axis results in a pitching moment, and any pitching around the lateral axis results in a yawing moment.

To correct for the effect of gyroscopic action, it is necessary for the pilot to properly use elevator and rudder to prevent undesired pitching and yawing.

### ASYMMETRIC LOADING (P FACTOR)

When an airplane is flying with a high angle of attack, the “bite” of the downward moving blade is

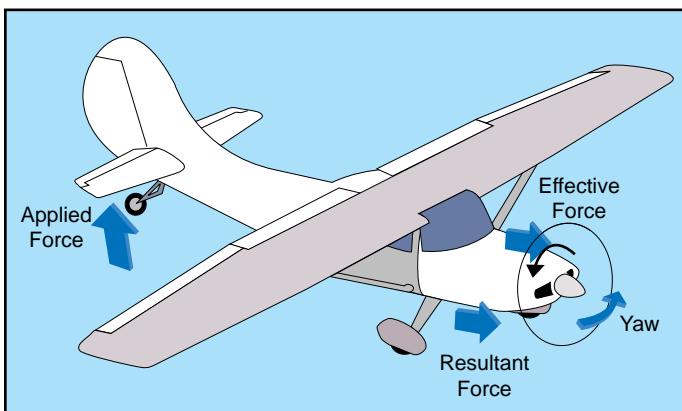

Figure 3-33. Raising tail produces gyroscopic precession.

greater than the “bite” of the upward moving blade; thus moving the center of thrust to the right of the prop disc area—causing a yawing moment toward the left around the vertical axis. That explanation is correct; however, to prove this phenomenon, it would be necessary to work wind vector problems on each blade, which gets quite involved when considering both the angle of attack of the airplane and the angle of attack of each blade.

This asymmetric loading is caused by the resultant velocity, which is generated by the combination of the velocity of the propeller blade in its plane of rotation and the velocity of the air passing horizontally through the propeller “disc.” With the airplane being flown at positive angles of attack, the right (viewed from the rear) or downswinging blade, is passing through an area of resultant velocity which is greater than that affecting the left or upswinging blade. Since the propeller blade is an airfoil, increased velocity means increased lift. Therefore, the downswinging blade having more “lift” tends to pull (yaw) the airplane’s nose to the left.

Simply stated, when the airplane is flying at a high angle of attack, the downward moving blade has a higher resultant velocity; therefore creating more lift than the upward moving blade. [Figure 3-34] This might be easier to visualize if the propeller shaft was

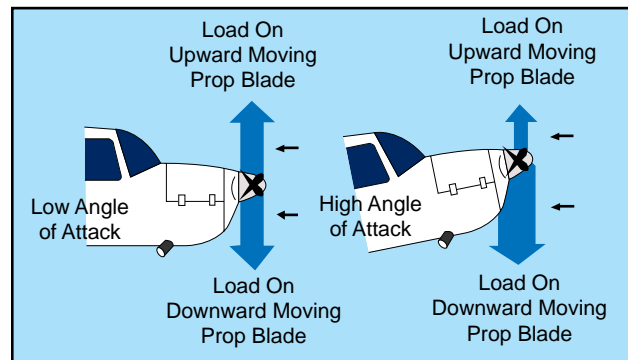

Figure 3-34. Asymmetrical loading of propeller (P-factor).

mounted perpendicular to the ground (like a helicopter). If there were no air movement at all, except that generated by the propeller itself, identical sections of each blade would have the same airspeed. However, with air moving horizontally across this vertically mounted propeller, the blade proceeding forward into the flow of air will have a higher airspeed than the blade retreating with the airflow. Thus, the blade proceeding into the horizontal airflow is creating more lift, or thrust, moving the center of thrust toward that blade. Visualize ROTATING the vertically mounted propeller shaft to shallower

angles relative to the moving air (as on an airplane). This unbalanced thrust then becomes proportionately smaller and continues getting smaller until it reaches the value of zero when the propeller shaft is exactly horizontal in relation to the moving air.

Each of these four elements of torque effects vary in values with changes in flight situations. In one phase of flight, one of these elements may be more prominent than another; whereas, in another phase of flight, another element may be more prominent. The relationship of these values to each other will vary with different airplanes—depending on the AIRFRAME, ENGINE, AND PROPELLER combinations as well as other design features.

To maintain positive control of the airplane in all flight conditions, the pilot must apply the flight controls as necessary to compensate for these varying values.

## LOAD FACTORS

The preceding sections only briefly considered some of the practical points of the principles of flight. To become a pilot, a detailed technical course in the science of aerodynamics is not necessary. However, with responsibilities for the safety of passengers, the competent pilot must have a well-founded concept of the forces which act on the airplane, and the advantageous use of these forces, as well as the operating limitations of the particular airplane. Any force applied to an airplane to deflect its flight from a straight line produces a stress on its structure; the amount of this force is termed “load factor.”

A load factor is the ratio of the total airload acting on the airplane to the gross weight of the airplane. For example, a load factor of 3 means that the total load on an airplane’s structure is three times its gross weight. Load factors are usually expressed in terms of “G”—that is, a load factor of 3 may be spoken of as 3 G’s, or a load factor of 4 as 4 G’s.

It is interesting to note that in subjecting an airplane to 3 G’s in a pullup from a dive, one will be pressed down into the seat with a force equal to three times the person’s weight. Thus, an idea of the magnitude of the load factor obtained in any maneuver can be determined by considering the degree to which one is pressed down into the seat. Since the operating speed of modern airplanes has increased significantly, this effect has become so pronounced that it is a primary consideration in the design of the structure for all airplanes.

With the structural design of airplanes planned to withstand only a certain amount of overload, a

knowledge of load factors has become essential for all pilots. Load factors are important to the pilot for two distinct reasons:

1. Because of the obviously dangerous overload that is possible for a pilot to impose on the airplane structures; and
2. Because an increased load factor increases the stalling speed and makes stalls possible at seemingly safe flight speeds.

### LOAD FACTORS IN AIRPLANE DESIGN

The answer to the question “how strong should an airplane be” is determined largely by the use to which the airplane will be subjected. This is a difficult problem, because the maximum possible loads are much too high for use in efficient design. It is true that any pilot can make a very hard landing or an extremely sharp pullup from a dive, which would result in abnormal loads. However, such extremely abnormal loads must be dismissed somewhat if airplanes are built that will take off quickly, land slowly, and carry a worthwhile payload.

The problem of load factors in airplane design then reduces to that of determining the highest load factors that can be expected in normal operation under various operational situations. These load factors are called “limit load factors.” For reasons of safety, it is required that the airplane be designed to withstand these load factors without any structural damage. Although the Code of Federal Regulations requires that the airplane structure be capable of supporting one and one-half times these limit load factors without failure, it is accepted that parts of the airplane may bend or twist under these loads and that some structural damage may occur.

This 1.5 value is called the “factor of safety” and provides, to some extent, for loads higher than those expected under normal and reasonable operation. However, this strength reserve is not something which pilots should willfully abuse; rather it is there for their protection when they encounter unexpected conditions.

The above considerations apply to all loading conditions, whether they be due to gusts, maneuvers, or landings. The gust load factor requirements now in effect are substantially the same as those that have been in existence for years. Hundreds of thousands of operational hours have proven them adequate for safety. Since the pilot has little control over gust load factors (except to reduce the airplane’s speed when rough air is encountered), the gust loading requirements are substantially the same for most general aviation type airplanes regardless of their

operational use. Generally, the gust load factors control the design of airplanes which are intended for strictly nonacrobatic usage.

An entirely different situation exists in airplane design with maneuvering load factors. It is necessary to discuss this matter separately with respect to: (1) Airplanes which are designed in accordance with the Category System (i.e., Normal, Utility, Acrobatic); and (2) Airplanes of older design which were built to requirements which did not provide for operational categories.

Airplanes designed under the Category System are readily identified by a placard in the cockpit, which states the operational category (or categories) in which the airplane is certificated. The maximum safe load factors (limit load factors) specified for airplanes in the various categories are as follows:

CATEGORY	LIMIT LOAD
Normal <sup>1</sup>	3.8 to -1.52
Utility (mild acrobatics, including spins)	4.4 to -1.76
Acrobatic	6.0 to -3.0

<sup>1</sup> For airplanes with gross weight of more than 4,000 pounds, the limit load factor is reduced. To the limit loads given above, a safety factor of 50 percent is added.

There is an upward graduation in load factor with the increasing severity of maneuvers. The Category System provides for obtaining the maximum utility of an airplane. If normal operation alone is intended, the required load factor (and consequently the weight of the airplane) is less than if the airplane is to be employed in training or acrobatic maneuvers as they result in higher maneuvering loads.

Airplanes that do not have the category placard are designs that were constructed under earlier engineering requirements in which no operational restrictions were specifically given to the pilots. For airplanes of this type (up to weights of about 4,000 pounds) the required strength is comparable to present-day utility category airplanes, and the same types of operation are permissible. For airplanes of this type over 4,000 pounds, the load factors decrease with weight so that these airplanes should be regarded as being comparable to the normal category airplanes designed under the Category System, and they should be operated accordingly.

### LOAD FACTORS IN STEEP TURNS

In a constant altitude, coordinated turn in any airplane, the load factor is the result of two forces: centrifugal force and gravity. [Figure 3-35] For any given bank angle, the rate of turn varies with the

airspeed; the higher the speed, the slower the rate of turn. This compensates for added centrifugal force, allowing the load factor to remain the same.

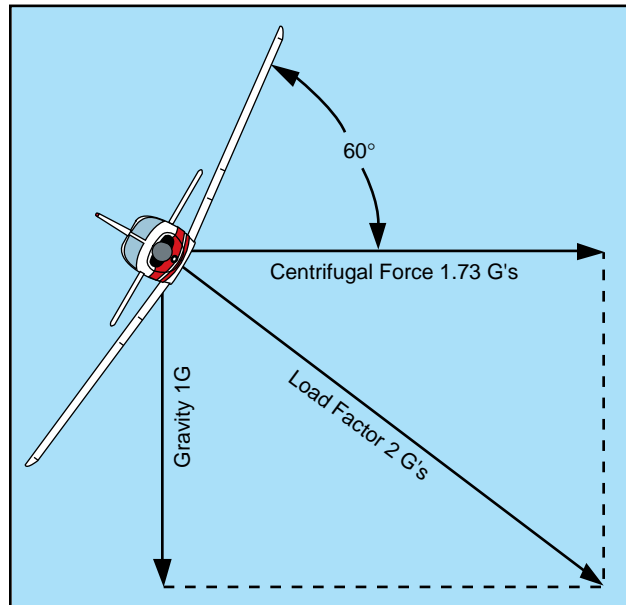

Figure 3-35. Two forces cause load factor during turns.

Figure 3-36 reveals an important fact about turns—that the load factor increases at a terrific rate after a bank has reached 45° or 50°. The load factor for any airplane in a 60° bank is 2 G's. The load factor in an 80° bank is 5.76 G's. The wing must produce lift equal to these load factors if altitude is to be maintained.

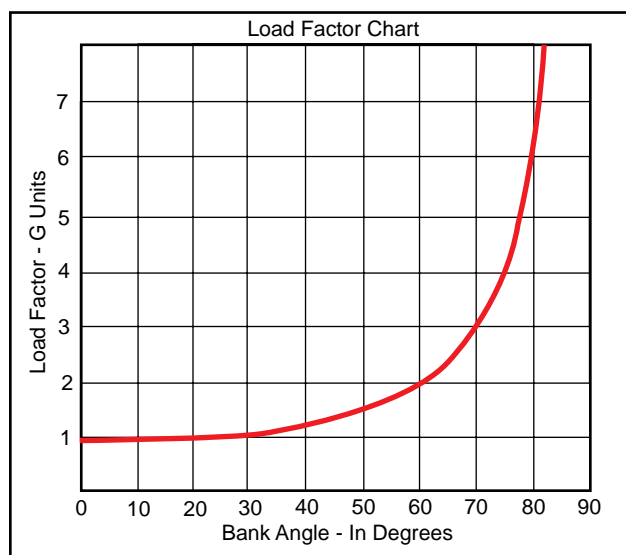

Figure 3-36. Angle of bank changes load factor.

It should be noted how rapidly the line denoting load factor rises as it approaches the 90° bank line, which it reaches only at infinity. The 90° banked, constant altitude turn mathematically is not possible. True, an airplane may be banked to 90° but not in a coordinated turn; an airplane which can be held in a 90°

banked slipping turn is capable of straight knife-edged flight. At slightly more than 80°, the load factor exceeds the limit of 6 G's, the limit load factor of an acrobatic airplane.

For a coordinated, constant altitude turn, the approximate maximum bank for the average general aviation airplane is 60°. This bank and its resultant necessary power setting reach the limit of this type of airplane. An additional 10° bank will increase the load factor by approximately 1 G, bringing it close to the yield point established for these airplanes. [Figure 3-36]

**LOAD FACTORS AND STALLING SPEEDS**

Any airplane, within the limits of its structure, may be stalled at any airspeed. When a sufficiently high angle of attack is imposed, the smooth flow of air over an airfoil breaks up and separates, producing an abrupt change of flight characteristics and a sudden loss of lift, which results in a stall.

A study of this effect has revealed that the airplane's stalling speed increases in proportion to the square root of the load factor. This means that an airplane with a normal unaccelerated stalling speed of 50 knots can be stalled at 100 knots by inducing a load factor of 4 G's. If it were possible for this airplane to withstand a load factor of 9, it could be stalled at a speed of 150 knots. Therefore, a competent pilot should be aware of the following:

- The danger of inadvertently stalling the airplane by increasing the load factor, as in a steep turn or spiral; and

- That in intentionally stalling an airplane above its design maneuvering speed, a tremendous load factor is imposed.

Reference to the charts in figures 3-36 and 3-37 will show that by banking the airplane to just beyond 72° in a steep turn produces a load factor of 3, and the stalling speed is increased significantly. If this turn is made in an airplane with a normal unaccelerated stalling speed of 45 knots, the airspeed must be kept above 75 knots to prevent inducing a stall. A similar effect is experienced in a quick pullup, or any maneuver producing load factors above 1 G. This has been the cause of accidents resulting from a sudden, unexpected loss of control, particularly in a steep turn or abrupt application of the back elevator control near the ground.

Since the load factor squares as the stalling speed doubles, it may be realized that tremendous loads may be imposed on structures by stalling an airplane at relatively high airspeeds.

The maximum speed at which an airplane may be stalled safely is now determined for all new designs. This speed is called the "design maneuvering speed" ( $V_A$ ) and is required to be entered in the FAA-approved Airplane Flight Manual or Pilot's Operating Handbook (AFM/POH) of all recently designed airplanes. For older general aviation airplanes, this speed will be approximately 1.7 times the normal stalling speed. Thus, an older airplane which normally stalls at 60 knots must never be stalled at above 102 knots (60 knots x 1.7 = 102 knots). An airplane with a normal stalling speed of

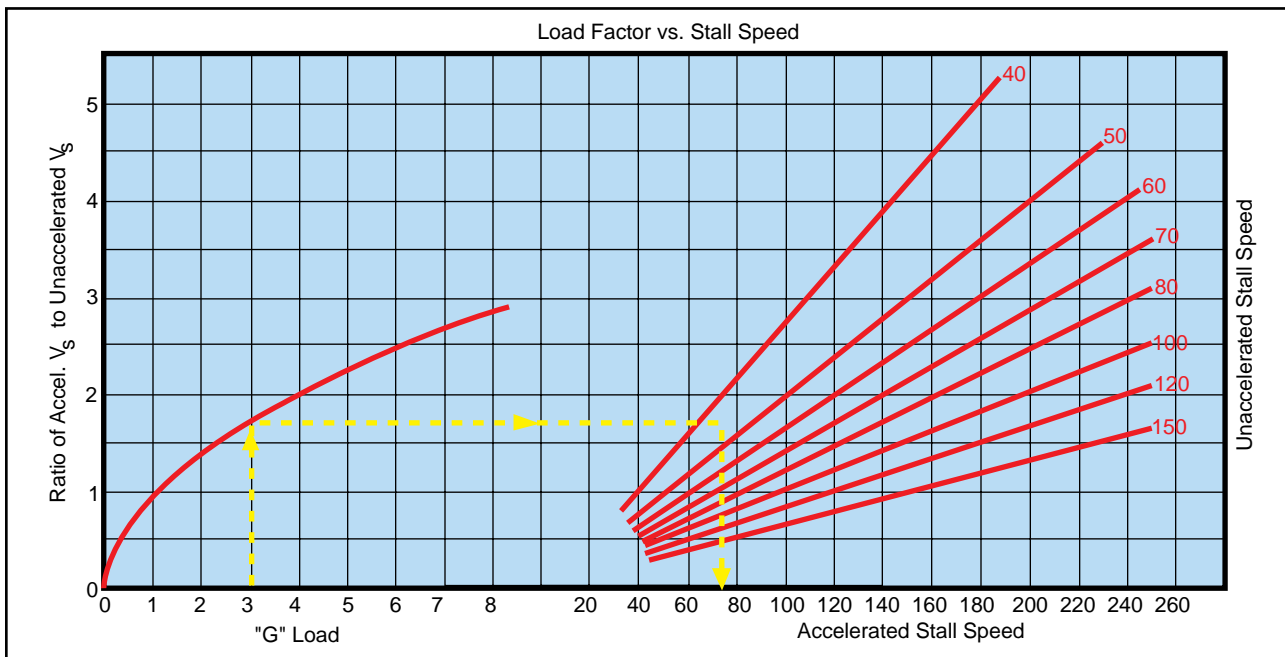

Figure 3-37. Load factor changes stall speed.

60 knots will undergo, when stalled at 102 knots, a load factor equal to the square of the increase in speed or 2.89 G's ( $1.7 \times 1.7 = 2.89$  G's). (The above figures are an approximation to be considered as a guide and are not the exact answers to any set of problems. The design maneuvering speed should be determined from the particular airplane's operating limitations when provided by the manufacturer.)

Since the leverage in the control system varies with different airplanes and some types employ "balanced" control surfaces while others do not, the pressure exerted by the pilot on the controls cannot be accepted as an index of the load factors produced in different airplanes. In most cases, load factors can be judged by the experienced pilot from the feel of seat pressure. They can also be measured by an instrument called an "accelerometer," but since this instrument is not common in general aviation training airplanes, the development of the ability to judge load factors from the feel of their effect on the body is important. A knowledge of the principles outlined above is essential to the development of this ability to estimate load factors.

A thorough knowledge of load factors induced by varying degrees of bank, and the significance of design maneuvering speed ( $V_A$ ) will aid in the prevention of two of the most serious types of accidents:

1. Stalls from steep turns or excessive maneuvering near the ground; and
2. Structural failures during acrobatics or other violent maneuvers resulting from loss of control.

### **LOAD FACTORS AND FLIGHT MANEUVERS**

Critical load factors apply to all flight maneuvers except unaccelerated straight flight where a load factor of 1 G is always present. Certain maneuvers considered in this section are known to involve relatively high load factors.

**URNS**—Increased load factors are a characteristic of all banked turns. As noted in the section on load factors in steep turns and particularly figures 3-36 and 3-37, load factors become significant both to flight performance and to the load on wing structure as the bank increases beyond approximately  $45^\circ$ .

The yield factor of the average light plane is reached at a bank of approximately  $70^\circ$  to  $75^\circ$ , and the stalling speed is increased by approximately one-half at a bank of approximately  $63^\circ$ .

**STALLS**—The normal stall entered from straight level flight, or an unaccelerated straight climb, will not produce added load factors beyond the 1 G of

straight-and-level flight. As the stall occurs, however, this load factor may be reduced toward zero, the factor at which nothing seems to have weight; and the pilot has the feeling of "floating free in space." In the event recovery is effected by snapping the elevator control forward, negative load factors, those which impose a down load on the wings and raise the pilot from the seat, may be produced.

During the pullup following stall recovery, significant load factors sometimes are induced. Inadvertently these may be further increased during excessive diving (and consequently high airspeed) and abrupt pullups to level flight. One usually leads to the other, thus increasing the load factor. Abrupt pullups at high diving speeds may impose critical loads on airplane structures and may produce recurrent or secondary stalls by increasing the angle of attack to that of stalling.

As a generalization, a recovery from a stall made by diving only to cruising or design maneuvering airspeed, with a gradual pullup as soon as the airspeed is safely above stalling, can be effected with a load factor not to exceed 2 or 2.5 G's. A higher load factor should never be necessary unless recovery has been effected with the airplane's nose near or beyond the vertical attitude, or at extremely low altitudes to avoid diving into the ground.

**SPINS**—Since a stabilized spin is not essentially different from a stall in any element other than rotation, the same load factor considerations apply as those that apply to stall recovery. Since spin recoveries usually are effected with the nose much lower than is common in stall recoveries, higher airspeeds and consequently higher load factors are to be expected. The load factor in a proper spin recovery will usually be found to be about 2.5 G's.

The load factor during a spin will vary with the spin characteristics of each airplane but is usually found to be slightly above the 1 G of level flight. There are two reasons this is true:

1. The airspeed in a spin is very low, usually within 2 knots of the unaccelerated stalling speeds; and
2. The airplane pivots, rather than turns, while it is in a spin.

**HIGH-SPEED STALLS**—The average light plane is not built to withstand the repeated application of load factors common to high-speed stalls. The load factor necessary for these maneuvers produces a stress on the wings and tail structure, which does not leave a reasonable margin of safety in most light airplanes.

The only way this stall can be induced at an airspeed above normal stalling involves the imposition of an added load factor, which may be accomplished by a severe pull on the elevator control. A speed of 1.7 times stalling speed (about 102 knots in a light airplane with a stalling speed of 60 knots) will produce a load factor of 3 G's. Further, only a very narrow margin for error can be allowed for acrobatics in light airplanes. To illustrate how rapidly the load factor increases with airspeed, a high-speed stall at 112 knots in the same airplane would produce a load factor of 4 G's.

**CHANDELLES AND LAZY EIGHTS**—It would be difficult to make a definite statement concerning load factors in these maneuvers as both involve smooth, shallow dives and pullups. The load factors incurred depend directly on the speed of the dives and the abruptness of the pullups.

Generally, the better the maneuver is performed, the less extreme will be the load factor induced. A chandelle or lazy eight, in which the pullup produces a load factor greater than 2 G's will not result in as great a gain in altitude, and in low-powered airplanes it may result in a net loss of altitude.

The smoothest pullup possible, with a moderate load factor, will deliver the greatest gain in altitude in a chandelle and will result in a better overall performance in both chandelles and lazy eights. Further, it will be noted that recommended entry speed for these maneuvers is generally near the manufacturer's design maneuvering speed, thereby allowing maximum development of load factors without exceeding the load limits.

**ROUGH AIR**—All certificated airplanes are designed to withstand loads imposed by gusts of considerable intensity. Gust load factors increase with increasing airspeed and the strength used for design purposes usually corresponds to the highest level flight speed. In extremely rough air, as in thunderstorms or frontal conditions, it is wise to reduce the speed to the design maneuvering speed. Regardless of the speed held, there may be gusts that can produce loads which exceed the load limits.

Most airplane flight manuals now include turbulent air penetration information. Operators of modern airplanes, capable of a wide range of speeds and altitudes, are benefited by this added feature both in comfort and safety. In this connection, it is to be noted that the maximum "never-exceed" placard dive speeds are determined for smooth air only. High-speed dives or acrobatics involving speed above the known maneuvering speed should never be practiced in rough or turbulent air.

In summary, it must be remembered that load factors induced by intentional acrobatics, abrupt pullups from dives, high-speed stalls, and gusts at high airspeeds all place added stress on the entire structure of an airplane.

Stress on the structure involves forces on any part of the airplane. There is a tendency for the uninformed to think of load factors only in terms of their effect on spars and struts. Most structural failures due to excess load factors involve rib structure within the leading and trailing edges of wings and tail group. The critical area of fabric-covered airplanes is the covering about one-third of the chord aft on the top surface of the wing.

The cumulative effect of such loads over a long period of time may tend to loosen and weaken vital parts so that actual failure may occur later when the airplane is being operated in a normal manner.

### **VG DIAGRAM**

The flight operating strength of an airplane is presented on a graph whose horizontal scale is based on load factor. [Figure 3-38] The diagram is called a Vg diagram—velocity versus "g" loads or load factor. Each airplane has its own Vg diagram which is valid at a certain weight and altitude.

The lines of maximum lift capability (curved lines) are the first items of importance on the Vg diagram. The subject airplane in the illustration is capable of developing no more than one positive "g" at 62 m.p.h., the wing level stall speed of the airplane. Since the maximum load factor varies with the square of the airspeed, the maximum positive lift capability of this airplane is 2 "g" at 92 m.p.h., 3 "g" at 112 m.p.h., 4.4 "g" at 137 m.p.h., and so forth. Any load factor above this line is unavailable aerodynamically; i.e., the subject airplane cannot fly above the line of maximum lift capability (it will stall). Essentially the same situation exists for negative lift flight with the exception that the speed necessary to produce a given negative load factor is higher than that to produce the same positive load factor.

If the subject airplane is flown at a positive load factor greater than the positive limit load factor of 4.4, structural damage will be possible. When the airplane is operated in this region, objectionable permanent deformation of the primary structure may take place and a high rate of fatigue damage is incurred. Operation above the limit load factor must be avoided in normal operation.

There are two other points of importance on the Vg diagram. First, is the intersection of the positive limit

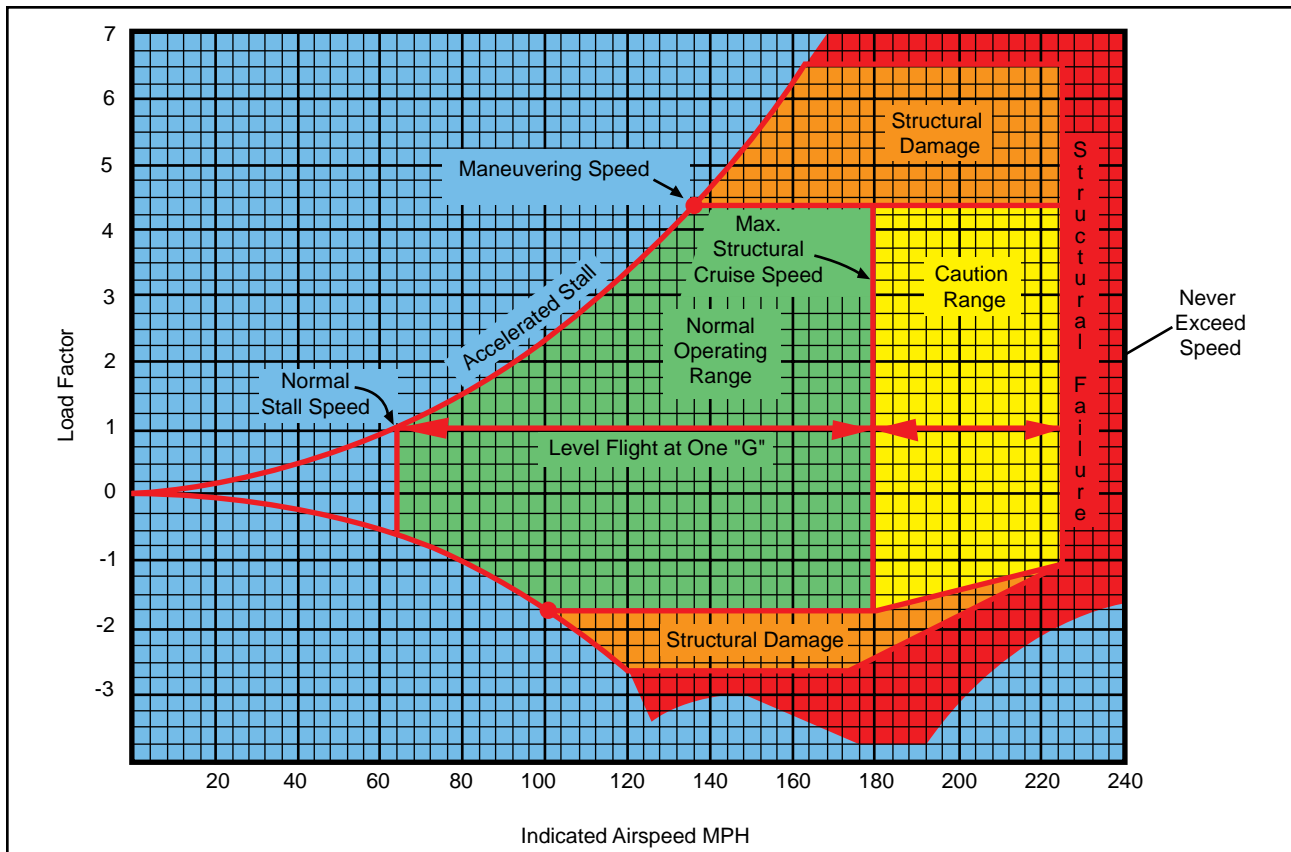

Figure 3-38. Typical Vg diagram.

load factor and the line of maximum positive lift capability. The airspeed at this point is the minimum airspeed at which the limit load can be developed aerodynamically. Any airspeed greater than this provides a positive lift capability sufficient to damage the airplane; any airspeed less does not provide positive lift capability sufficient to cause damage from excessive flight loads. The usual term given to this speed is “maneuvering speed,” since consideration of subsonic aerodynamics would predict minimum usable turn radius to occur at this condition. The maneuver speed is a valuable reference point, since an airplane operating below this point cannot produce a damaging positive flight load. Any combination of maneuver and gust cannot create damage due to excess airload when the airplane is below the maneuver speed.

Next, is the intersection of the negative limit load factor and line of maximum negative lift capability. Any airspeed greater than this provides a negative lift capability sufficient to damage the airplane; any airspeed less does not provide negative lift capability sufficient to damage the airplane from excessive flight loads.

The limit airspeed (or redline speed) is a design reference point for the airplane—the subject airplane is limited to 225 m.p.h. If flight is attempted beyond

the limit airspeed, structural damage or structural failure may result from a variety of phenomena.

Thus, the airplane in flight is limited to a regime of airspeeds and g’s which do not exceed the limit (or redline) speed, do not exceed the limit load factor, and cannot exceed the maximum lift capability. The airplane must be operated within this “envelope” to prevent structural damage and ensure that the anticipated service lift of the airplane is obtained. The pilot must appreciate the Vg diagram as describing the allowable combination of airspeeds and load factors for safe operation. Any maneuver, gust, or gust plus maneuver outside the structural envelope can cause structural damage and effectively shorten the service life of the airplane.

## WEIGHT AND BALANCE

Often a pilot regards the airplane’s weight and balance data as information of interest only to engineers, dispatchers, and operators of scheduled and non-scheduled air carriers. Along with this idea, the reasoning is that the airplane was weighed during the certification process and that this data is valid indefinitely, regardless of equipment changes or modifications. Further, this information is mistakenly reduced to a workable routine or “rule of thumb” such as: “If I have three passengers, I can load only 100 gallons of fuel; four passengers—70 gallons.”



Admittedly, this rule of thumb is adequate in many cases, but as the subject “Weight and Balance” suggests, the concern is not only with the weight of the airplane but also the location of its center of gravity (CG). The importance of the CG should have become apparent in the discussion of stability, controllability, and performance. If all pilots understood and respected the effect of CG on an airplane, then one type of accident would be eliminated from the records: “PRIMARY CAUSE OF ACCIDENT—AIRPLANE CENTER OF GRAVITY OUT OF REARWARD LIMITS AND UNEQUAL LOAD DISTRIBUTION RESULTING IN AN UNSTABLE AIRPLANE. PILOT LOST CONTROL OF AIRPLANE ON TAKEOFF AND CRASHED.”

The reasons airplanes are so certificated are obvious when one gives it a little thought. For instance, it is of added value to the pilot to be able to carry extra fuel for extended flights when the full complement of passengers is not to be carried. Further, it is unreasonable to forbid the carriage of baggage when it is only during spins that its weight will adversely affect the airplane’s flight characteristics. Weight and balance limits are placed on airplanes for two principal reasons:

1. Because of the effect of the weight on the airplane’s primary structure and its performance characteristics; and
2. Because of the effect the location of this weight has on flight characteristics, particularly in stall and spin recovery and stability.

### **EFFECTS OF WEIGHT ON FLIGHT PERFORMANCE**

The takeoff/climb and landing performance of an airplane are determined on the basis of its maximum allowable takeoff and landing weights. A heavier gross weight will result in a longer takeoff run and shallower climb, and a faster touchdown speed and longer landing roll. Even a minor overload may make it impossible for the airplane to clear an obstacle that normally would not have been seriously considered during takeoffs under more favorable conditions.

The detrimental effects of overloading on performance are not limited to the immediate hazards involving takeoffs and landings. Overloading has an adverse effect on all climb and cruise performance which leads to overheating during climbs, added wear on engine parts, increased fuel consumption, slower cruising speeds, and reduced range.

The manufacturers of modern airplanes furnish weight and balance data with each airplane produced.

Generally, this information may be found in the FAA-approved Airplane Flight Manual or Pilot’s Operating Handbook (AFM/POH). With the advancements in airplane design and construction in recent years has come the development of “easy to read charts” for determining weight and balance data. Increased performance and load carrying capability of these airplanes require strict adherence to the operating limitations prescribed by the manufacturer. Deviations from the recommendations can result in structural damage or even complete failure of the airplane’s structure. Even if an airplane is loaded well within the maximum weight limitations, it is imperative that weight distribution be within the limits of center of gravity location. The preceding brief study of aerodynamics and load factors points out the reasons for this precaution. The following discussion is background information into some of the reasons why weight and balance conditions are important to the safe flight of an airplane.

The pilot is often completely unaware of the weight and balance limitations of the airplane being flown and of the reasons for these limitations. In some airplanes, it is not possible to fill all seats, baggage compartments, and fuel tanks, and still remain within approved weight or balance limits. As an example, in several popular four-place airplanes the fuel tanks may not be filled to capacity when four occupants and their baggage are carried. In a certain two-place airplane, no baggage may be carried in the compartment aft of the seats when spins are to be practiced.

### **EFFECT OF WEIGHT ON AIRPLANE STRUCTURE**

The effect of additional weight on the wing structure of an airplane is not readily apparent. Airworthiness requirements prescribe that the structure of an airplane certificated in the normal category (in which acrobatics are prohibited) must be strong enough to withstand a load factor of 3.8 to take care of dynamic loads caused by maneuvering and gusts. This means that the primary structure of the airplane can withstand a load of 3.8 times the approved gross weight of the airplane without structural failure occurring. If this is accepted as indicative of the load factors that may be imposed during operations for which the airplane is intended, a 100-pound overload imposes a potential structural overload of 380 pounds. The same consideration is even more impressive in the case of utility and acrobatic category airplanes, which have load factor requirements of 4.4 and 6.0 respectively.

Structural failures which result from overloading may be dramatic and catastrophic, but more often they affect structural components progressively in a

manner which is difficult to detect and expensive to repair. One of the most serious results of habitual overloading is that its results tend to be cumulative, and may result in structural failure later during completely normal operations. The additional stress placed on structural parts by overloading is believed to accelerate the occurrence of metallic fatigue failures.

A knowledge of load factors imposed by flight maneuvers and gusts will emphasize the consequences of an increase in the gross weight of an airplane. The structure of an airplane about to undergo a load factor of 3 G's, as in the recovery from a steep dive, must be prepared to withstand an added load of 300 pounds for each 100-pound increase in weight. It should be noted that this would be imposed by the addition of about 16 gallons of unneeded fuel in a particular airplane. The FAA certificated civil airplane has been analyzed structurally, and tested for flight at the maximum gross weight authorized and within the speeds posted for the type of flights to be performed. Flights at weights in excess of this amount are quite possible and often are well within the performance capabilities of an airplane. Nonetheless, this fact should not be allowed to mislead the pilot, as the pilot may not realize that loads for which the airplane was not designed are being imposed on all or some part of the structure.

In loading an airplane with either passengers or cargo, the structure must be considered. Seats, baggage compartments, and cabin floors are designed for a certain load or concentration of load and no more. As an example, a light plane baggage compartment may be placarded for 20 pounds because of the limited strength of its supporting structure even though the airplane may not be overloaded or out of center-of-gravity limits with more weight at that location.

### EFFECTS OF WEIGHT ON STABILITY AND CONTROLLABILITY

The effects that overloading has on stability also are not generally recognized. An airplane, which is observed to be quite stable and controllable when loaded normally, may be discovered to have very different flight characteristics when it is overloaded. Although the distribution of weight has the most direct effect on this, an increase in the airplane's gross weight may be expected to have an adverse effect on stability, regardless of location of the center of gravity.

The stability of many certificated airplanes is completely unsatisfactory if the gross weight is exceeded.

### EFFECT OF LOAD DISTRIBUTION

The effect of the position of the center of gravity on the load imposed on an airplane's wing in flight is not generally realized, although it may be very significant to climb and cruising performance. Contrary to the beliefs of some pilots, an airplane with forward loading is "heavier" and consequently, slower than the same airplane with the center of gravity further aft.

Figure 3-39 illustrates the reason for this. With forward loading, "nose-up" trim is required in most airplanes to maintain level cruising flight. Nose-up trim involves setting the tail surfaces to produce a greater down load on the aft portion of the fuselage, which adds to the wing loading and the total lift required from the wing if altitude is to be maintained. This requires a higher angle of attack of the wing, which results in more drag and, in turn, produces a higher stalling speed.

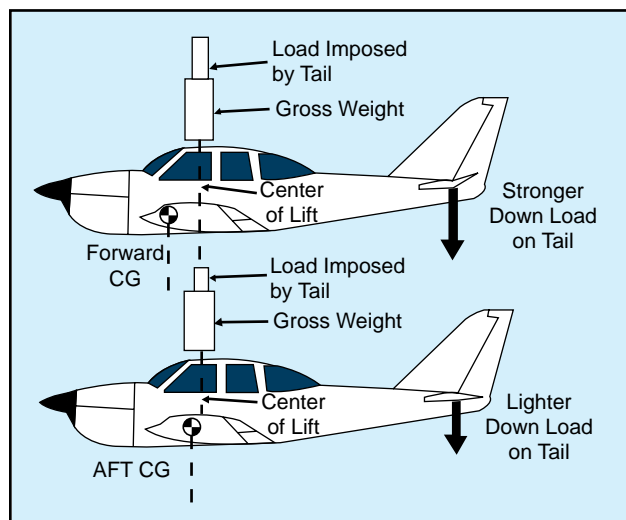

Figure 3-39. Load distribution affects balance.

With aft loading and "nose-down" trim, the tail surfaces will exert less down load, relieving the wing of that much wing loading and lift required to maintain altitude. The required angle of attack of the wing is less, so the drag is less, allowing for a faster cruise speed. Theoretically, a neutral load on the tail surfaces in cruising flight would produce the most efficient overall performance and fastest cruising speed, but would also result in instability. Consequently, modern airplanes are designed to require a down load on the tail for stability and controllability.

Remember that a zero indication on the trim tab control is not necessarily the same as "neutral trim" because of the force exerted by downwash from the wings and the fuselage on the tail surfaces.

The effects of the distribution of the airplane's useful load have a significant influence on its flight

characteristics, even when the load is within the center-of-gravity limits and the maximum permissible gross weight. Important among these effects are changes in controllability, stability, and the actual load imposed on the wing.

Generally, an airplane becomes less controllable, especially at slow flight speeds, as the center of gravity is moved further aft. An airplane which cleanly recovers from a prolonged spin with the center of gravity at one position may fail completely to respond to normal recovery attempts when the center of gravity is moved aft by 1 or 2 inches.

It is common practice for airplane designers to establish an aft center-of-gravity limit that is within 1 inch of the maximum which will allow normal recovery from a one-turn spin. When certificating an airplane in the utility category to permit intentional spins, the aft center-of-gravity limit is usually established at a point several inches forward of that which is permissible for certification in the normal category.

Another factor affecting controllability, which is becoming more important in current designs of large airplanes, is the effect of long moment arms to the positions of heavy equipment and cargo. The same airplane may be loaded to maximum gross weight within its center-of-gravity limits by concentrating fuel, passengers, and cargo near the design center of gravity; or by dispersing fuel and cargo loads in wingtip tanks and cargo bins forward and aft of the cabin.

With the same total weight and center of gravity, maneuvering the airplane or maintaining level flight in turbulent air will require the application of greater control forces when the load is dispersed. This is true because of the longer moment arms to the positions of the heavy fuel and cargo loads which must be overcome by the action of the control surfaces. An airplane with full outboard wing tanks or tip tanks tends to be sluggish in roll when control situations are marginal, while one with full nose and aft cargo bins tends to be less responsive to the elevator controls.

The rearward center-of-gravity limit of an airplane is determined largely by considerations of stability. The original airworthiness requirements for a type certificate specify that an airplane in flight at a certain speed will dampen out vertical displacement of the nose within a certain number of oscillations. An airplane loaded too far rearward may not do this; instead when the nose is momentarily pulled up, it may alternately climb and dive becoming steeper with each oscillation. This instability is not only uncomfortable to occupants, but it could even

become dangerous by making the airplane unmanageable under certain conditions.

The recovery from a stall in any airplane becomes progressively more difficult as its center of gravity moves aft. This is particularly important in spin recovery, as there is a point in rearward loading of any airplane at which a “flat” spin will develop. A flat spin is one in which centrifugal force, acting through a center of gravity located well to the rear, will pull the tail of the airplane out away from the axis of the spin, making it impossible to get the nose down and recover.

An airplane loaded to the rear limit of its permissible center-of-gravity range will handle differently in turns and stall maneuvers and have different landing characteristics than when it is loaded near the forward limit.

The forward center-of-gravity limit is determined by a number of considerations. As a safety measure, it is required that the trimming device, whether tab or adjustable stabilizer, be capable of holding the airplane in a normal glide with the power off. A conventional airplane must be capable of a full stall, power-off landing in order to ensure minimum landing speed in emergencies. A tailwheel-type airplane loaded excessively nose heavy will be difficult to taxi, particularly in high winds. It can be nosed over easily by use of the brakes, and it will be difficult to land without bouncing since it tends to pitch down on the wheels as it is slowed down and flared for landing. Steering difficulties on the ground may occur in nosewheel-type airplanes, particularly during the landing roll and takeoff.

- The CG position influences the lift and angle of attack of the wing, the amount and direction of force on the tail, and the degree of deflection of the stabilizer needed to supply the proper tail force for equilibrium. The latter is very important because of its relationship to elevator control force.
- The airplane will stall at a higher speed with a forward CG location. This is because the stalling angle of attack is reached at a higher speed due to increased wing loading.
- Higher elevator control forces normally exist with a forward CG location due to the increased stabilizer deflection required to balance the airplane.
- The airplane will cruise faster with an aft CG location because of reduced drag. The drag is reduced because a smaller angle of attack and less

downward deflection of the stabilizer are required to support the airplane and overcome the nose-down pitching tendency.

- The airplane becomes less stable as the CG is moved rearward. This is because when the CG is moved rearward it causes an increase in the angle of attack. Therefore, the wing contribution to the airplane's stability is now decreased, while the tail contribution is still stabilizing. When the point is reached that the wing and tail contributions balance, then neutral stability exists. Any CG movement further aft will result in an unstable airplane.
- A forward CG location increases the need for greater back elevator pressure. The elevator may no longer be able to oppose any increase in nose-down pitching. Adequate elevator control is needed to control the airplane throughout the airspeed range down to the stall.

## HIGH-SPEED FLIGHT

### SUPERSONIC VS. SUBSONIC FLOW

In subsonic aerodynamics, the theory of lift is based upon the forces generated on a body and a moving gas (air) in which it is immersed. At speeds below about 260 knots, air can be considered incompressible, in that at a fixed altitude, its density remains nearly constant while its pressure varies. Under this assumption, air acts the same as water and is classified as a fluid. Subsonic aerodynamic theory also assumes the effects of viscosity (the property of a fluid that tends to prevent motion of one part of the fluid with respect to another) are negligible, and classifies air as an ideal fluid, conforming to the principles of ideal-fluid aerodynamics such as continuity, Bernoulli's principle, and circulation.

In reality, air is compressible and viscous. While the effects of these properties are negligible at low speeds, compressibility effects in particular become increasingly important as speed increases. Compressibility (and to a lesser extent viscosity) is of paramount importance at speeds approaching the speed of sound. In these speed ranges, compressibility causes a change in the density of the air around an airplane.

During flight, a wing produces lift by accelerating the airflow over the upper surface. This accelerated air can, and does, reach sonic speeds even though the airplane itself may be flying subsonic. At some extreme angles of attack, in some airplanes, the speed of the air over the top surface of the wing may be double the airplane's speed. It is therefore entirely

possible to have both supersonic and subsonic airflow on an airplane at the same time. When flow velocities reach sonic speeds at some location on an airplane (such as the area of maximum camber on the wing), further acceleration will result in the onset of compressibility effects such as shock wave formation, drag increase, buffeting, stability, and control difficulties. Subsonic flow principles are invalid at all speeds above this point. [Figure 3-40]

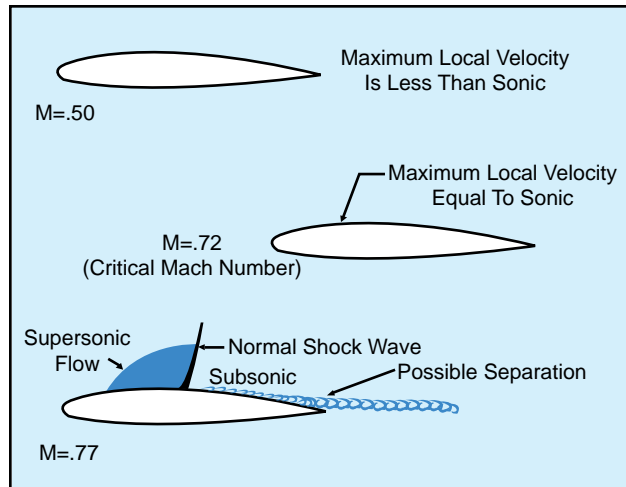

Figure 3-40. Wing airflow.

### SPEED RANGES

The speed of sound varies with temperature. Under standard temperature conditions of 15°C, the speed of sound at sea level is 661 knots. At 40,000 feet, where the temperature is -55°C, the speed of sound decreases to 574 knots. In high-speed flight and/or high-altitude flight, the measurement of speed is expressed in terms of a "Mach number"—the ratio of the true airspeed of the airplane to the speed of sound in the same atmospheric conditions. An airplane traveling at the speed of sound is traveling at Mach 1.0. Airplane speed regimes are defined as follows:

Subsonic—Mach numbers below 0.75

Transonic—Mach numbers from .075 to 1.20

Supersonic—Mach numbers from 1.20 to 5.00

Hypersonic—Mach numbers above 5.00

While flights in the transonic and supersonic ranges are common occurrences for military airplanes, civilian jet airplanes normally operate in a cruise speed range of Mach 0.78 to Mach 0.90.

The speed of an airplane in which airflow over any part of the wing first reaches (but does not exceed) Mach 1.0 is termed that airplane's critical Mach number or "Mach Crit." Thus, critical Mach number

is the boundary between subsonic and transonic flight and is an important point of reference for all compressibility effects encountered in transonic flight. Shock waves, buffet, and airflow separation take place above critical Mach number. A jet airplane typically is most efficient when cruising at or near its critical Mach number. At speeds 5 – 10 percent above the critical Mach number, compressibility effects begin. Drag begins to rise sharply. Associated with the “drag rise” are buffet, trim and stability changes, and a decrease in control surface effectiveness. This is the point of “drag divergence,” and is typically the speed chosen for high-speed cruise operations. At some point beyond high-speed cruise are the turbine powered airplane’s maximum operating limit speeds:  $V_{MO}/M_{MO}$ . [Figure 3-41]

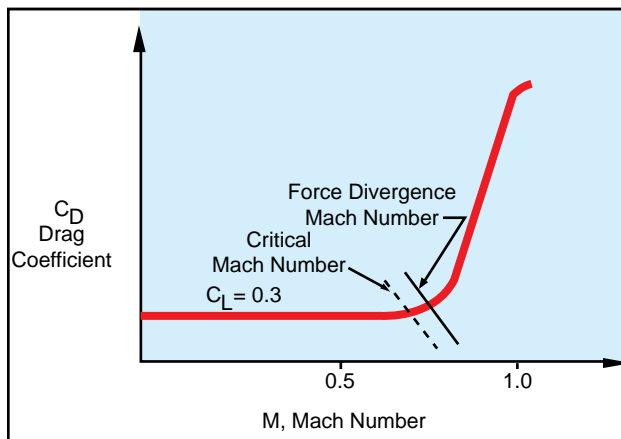

Figure 3-41. Critical Mach.

$V_{MO}$  is the maximum operating speed expressed in terms of knots.  $V_{MO}$  limits ram air pressure acting against the structure and prevents flutter.  $M_{MO}$  is the maximum operating speed expressed in terms of Mach number. An airplane should not be flown in excess of this speed. Doing so risks encountering the full effects of compressibility, including possible loss of control.

### MACH NUMBER VS. AIRSPEED

Speeds such as Mach Crit and  $M_{MO}$  for a specific airplane occur at a given Mach number. The true airspeed (TAS), however, varies with outside air temperature. Therefore, true airspeeds corresponding to a specific Mach number can vary considerably (as much as 75 – 100 knots). When an airplane cruising at a constant Mach number enters an area of higher outside air temperatures, true airspeed and required fuel increases, and range decreases. Conversely, when entering an area of colder outside air temperatures, true airspeed and fuel flow decreases, and range increases.

In a jet airplane operating at high altitude, the indicated airspeed (IAS) for any given Mach number decreases with an increase in altitude above a certain level. The reverse occurs during descent. Normally, climbs and

descents are accomplished using indicated airspeed in the lower altitudes and Mach number in the higher altitudes.

Unlike operations in the lower altitudes, the indicated airspeed (IAS) at which a jet airplane stalls increases significantly with altitude. This is due to the fact that true airspeed (TAS) increases with altitude. At high true airspeeds, air compression causes airflow distortion over the wings and in the pitot system. At the same time, the indicated airspeed (IAS) representing  $M_{MO}$  decreases with altitude. Eventually, the airplane can reach an altitude where there is little or no difference between the two.

### BOUNDARY LAYER

Air has viscosity, and will encounter resistance to flow over a surface. The viscous nature of airflow reduces the local velocities on a surface and is responsible for skin friction drag. As the air passes over the wing’s surface, the air particles nearest the surface come to rest. The next layer of particles is slowed down but not stopped. Some small but measurable distance from the surface, the air particles are moving at free stream velocity. The layer of air over the wing’s surface, which is slowed down or stopped by viscosity, is termed the “boundary layer.” Typical boundary layer thicknesses on an airplane range from small fractions of an inch near the leading edge of a wing to the order of 12 inches at the aft end of a large airplane such as a Boeing 747.

There are two different types of boundary layer flow: laminar and turbulent. The laminar boundary layer is a very smooth flow, while the turbulent boundary layer contains swirls or “eddies.” The laminar flow creates less skin friction drag than the turbulent flow, but is less stable. Boundary layer flow over a wing surface begins as a smooth laminar flow. As the flow continues back from the leading edge, the laminar boundary layer increases in thickness. At some distance back from the leading edge, the smooth laminar flow breaks down and transitions to a turbulent flow. From a drag standpoint, it is advisable to have the transition from laminar to turbulent flow as far aft on the wing as possible, or have a large amount of the wing surface within the laminar portion of the boundary layer. The low energy laminar flow, however, tends to break down more suddenly than the turbulent layer.

Another phenomenon associated with viscous flow is separation. Separation occurs when the airflow breaks away from an airfoil. The natural progression is from laminar boundary layer to turbulent boundary layer and then to airflow separation. Airflow separation produces high drag and ultimately destroys lift. The boundary layer separation point

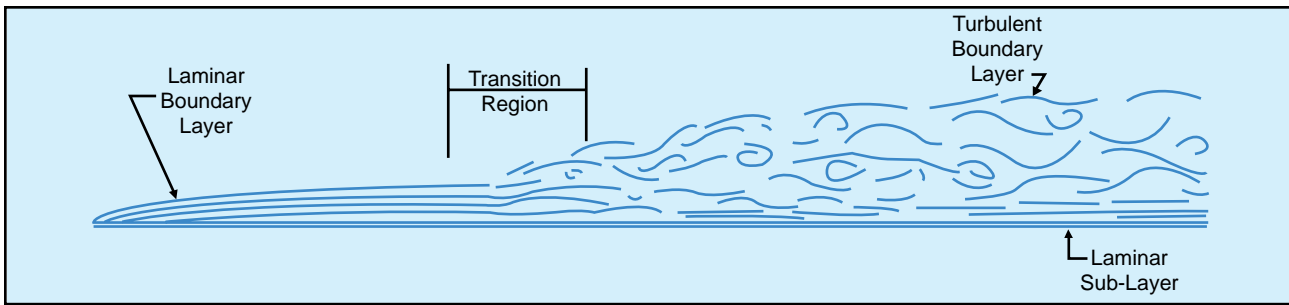

Figure 3-42. Boundary layer.

moves forward on the wing as the angle of attack is increased. [Figure 3-42]

“Vortex Generators” are used to delay or prevent shock wave induced boundary layer separation encountered in transonic flight. Vortex generators are small low aspect ratio airfoils placed at a  $12^\circ$  to  $15^\circ$  angle of attack to the airstream. They are usually spaced a few inches apart along the wing ahead of the ailerons or other control surfaces. Vortex generators create a vortex which mixes the boundary airflow with the high energy airflow just above the surface. This produces higher surface velocities and increases the energy of the boundary layer. Thus, a stronger shock wave will be necessary to produce airflow separation.

### SHOCK WAVES

When an airplane flies at subsonic speeds, the air ahead is “warned” of the airplane’s coming by a pressure change transmitted ahead of the airplane at the speed of sound. Because of this warning, the air begins to move aside before the airplane arrives and is prepared to let it pass easily. When the airplane’s speed reaches the speed of sound, the pressure change can no longer warn the air ahead because the airplane is keeping up with its own pressure waves. Rather, the air particles pile up in front of the airplane causing a sharp decrease in the flow velocity directly in front of the airplane with a corresponding increase in air pressure and density.

As the airplane’s speed increases beyond the speed of sound, the pressure and density of the compressed air ahead of it increase, the area of compression extending some distance ahead of the airplane. At some point in the airstream, the air particles are completely undisturbed, having had no advanced warning of the airplane’s approach, and in the next instant the same air particles are forced to undergo sudden and drastic changes in temperature, pressure, density, and velocity. The boundary between the undisturbed air and the region of compressed air is called a shock or “compression” wave.

This same type of wave is formed whenever a supersonic airstream is slowed to subsonic without a change

in direction, such as when the airstream is accelerated to sonic speed over the cambered portion of a wing, and then decelerates to subsonic speed as the area of maximum camber is passed. A shock wave will form as a boundary between the supersonic and subsonic ranges.

Whenever a shock wave forms perpendicular to the airflow, it is termed a “normal” shock wave, and the flow immediately behind the wave is subsonic. A supersonic airstream passing through a normal shock wave will experience these changes:

- The airstream is slowed to subsonic.
- The airflow immediately behind the shock wave does not change direction.
- The static pressure and density of the airstream behind the wave is greatly increased.
- The energy of the airstream (indicated by total pressure—dynamic plus static) is greatly reduced.

Shock wave formation causes an increase in drag. One of the principal effects of a shock wave is the formation of a dense high pressure region immediately behind the wave. The instability of the high pressure region, and the fact that part of the velocity energy of the airstream is converted to heat as it flows through the wave is a contributing factor in the drag increase, but the drag resulting from airflow separation is much greater. If the shock wave is strong, the boundary layer may not have sufficient kinetic energy to withstand airflow separation. The drag incurred in the transonic region due to shock wave formation and airflow separation is known as “wave drag.” When speed exceeds the critical Mach number by about 10 percent, wave drag increases sharply. A considerable increase in thrust (power) is required to increase flight speed beyond this point into the supersonic range where, depending on the airfoil shape and the angle of attack, the boundary layer may reattach.

Normal shock waves form on the wing’s upper surface first. Further increases in Mach number, however, can enlarge the supersonic area on the

upper surface and form an additional area of supersonic flow and a normal shock wave on the lower surface. As flight speed approaches the speed of sound, the areas of supersonic flow enlarge and the shock waves move nearer the trailing edge. [Figure 3-43]

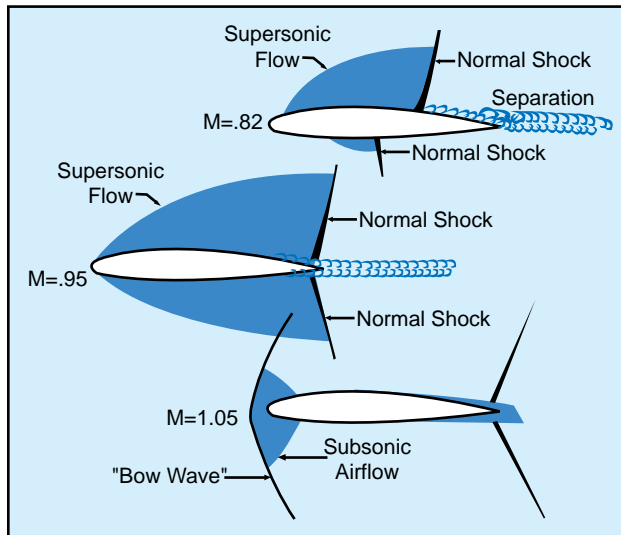

Figure 3-43. Shock waves.

Associated with “drag rise” are buffet (known as Mach buffet), trim and stability changes, and a decrease in control force effectiveness. The loss of lift due to airflow separation results in a loss of downwash, and a change in the position of the center pressure on the wing. Airflow separation produces a turbulent wake behind the wing which causes the tail surfaces to buffet (vibrate). The nose-up and nose-down pitch control provided by the horizontal tail is dependent on the downwash behind the wing. Thus, a decrease in downwash decreases the horizontal tail’s pitch control effectiveness. Movement of the wing center of pressure affects the wing pitching moment. If the center of pressure moves aft, a diving moment referred to as “Mach tuck” or “tuck under” is produced, and if it moves forward, a nose-up moment is produced. This is the primary reason for the development of

the T-tail configuration on many turbine-powered airplanes, which places the horizontal stabilizer as far as practical from the turbulence of the wings.

### SWEEPBACK

Most of the difficulties of transonic flight are associated with shock wave induced flow separation. Therefore, any means of delaying or alleviating the shock induced separation will improve aerodynamic performance. One method is wing sweepback. Sweepback theory is based upon the concept that it is only the component of the airflow perpendicular to the leading edge of the wing that affects pressure distribution and formation of shock waves. [Figure 3-44]

On a straight wing airplane, the airflow strikes the wing leading edge at 90°, and its full impact produces pressure and lift. A wing with sweepback is struck by the same airflow at an angle smaller than 90°. This airflow on the swept wing has the effect of persuading the wing into believing that it is flying slower than it really is; thus the formation of shock waves is delayed. Advantages of wing sweep include an increase in critical Mach number, force divergence

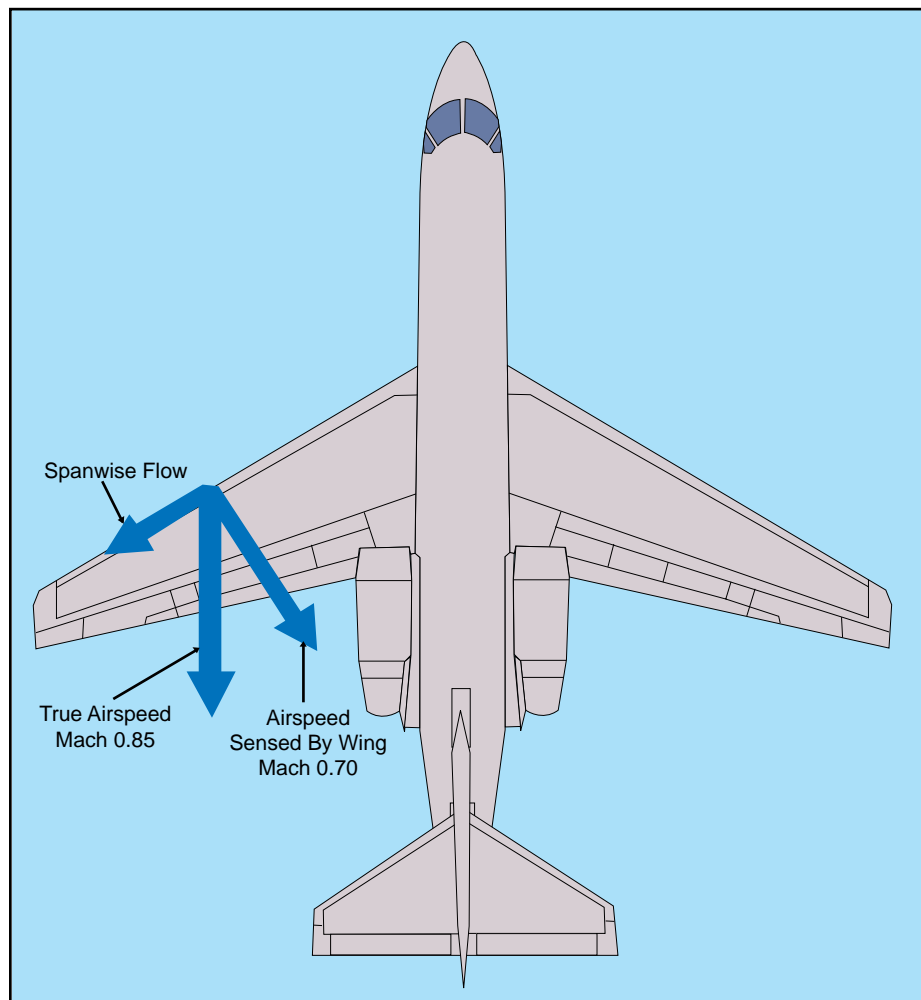

Figure 3-44. Sweepback effect.

Mach number, and the Mach number at which drag rise will peak. In other words, sweep will delay the onset of compressibility effects.

The Mach number, which produces a sharp change in drag coefficient, is termed the “force divergence” Mach number and, for most airfoils, usually exceeds the critical Mach number by 5 to 10 percent. At this speed, the airflow separation induced by shock wave formation can create significant variations in the drag, lift, or pitching moment coefficients. In addition to the delay of the onset of compressibility effects, sweepback reduces the magnitude in the changes of drag, lift or moment coefficients. In other words, the use of sweepback will “soften” the force divergence.

A disadvantage of swept wings is that they tend to stall at the wingtips rather than at the wing roots. [Figure 3-45] This is because the boundary layer tends to flow spanwise toward the tips and to separate near the leading edges. Because the tips of a swept wing are on the aft part of the wing (behind the center of lift), a wingtip stall will cause the center of lift to move forward on the wing, forcing the nose to rise further. The tendency for tip stall is greatest when wing sweep and taper are combined.

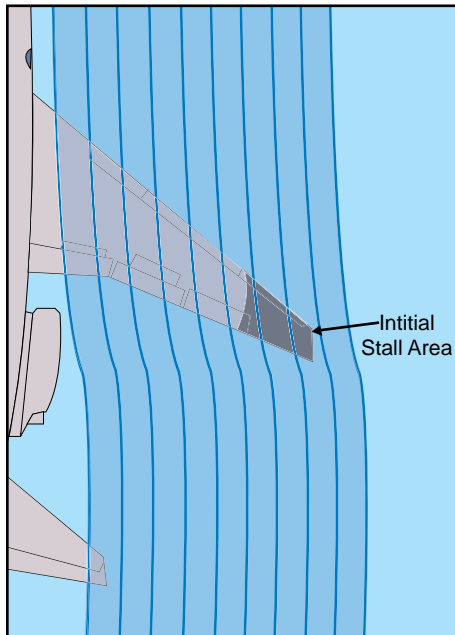

Figure 3-45 Wingtip stall.

The stall situation can be aggravated by a T-tail configuration, which affords little or no pre-stall warning in the form of tail control surface buffet. [Figure 3-46] The T-tail, being above the wing wake remains effective even after the wing has begun to stall, allowing the pilot to inadvertently drive the wing into a deeper stall at a much greater angle of attack. If the horizontal tail surfaces then become buried in the

wing’s wake, the elevator may lose all effectiveness, making it impossible to reduce pitch attitude and break the stall. In the pre-stall and immediate post-stall regimes, the lift/drag qualities of a swept wing airplane (specifically the enormous increase in drag at low speeds) can cause an increasingly descending flight-path with no change in pitch attitude, further increasing the angle of attack. In this situation, without reliable angle of attack information, a nose-down pitch attitude with an increasing airspeed is no guarantee that recovery has been effected, and up-elevator movement at this stage may merely keep the airplane stalled.

It is a characteristic of T-tail airplanes to pitch up viciously when stalled in extreme nose-high attitudes, making recovery difficult or violent. The stick pusher inhibits this type of stall. At approximately one knot above stall speed, pre-programmed stick forces automatically move the stick forward, preventing the stall from developing. A “g” limiter may also be incorporated into the system to prevent the pitch down generated by the stick pusher from imposing excessive loads on the airplane. A “stick

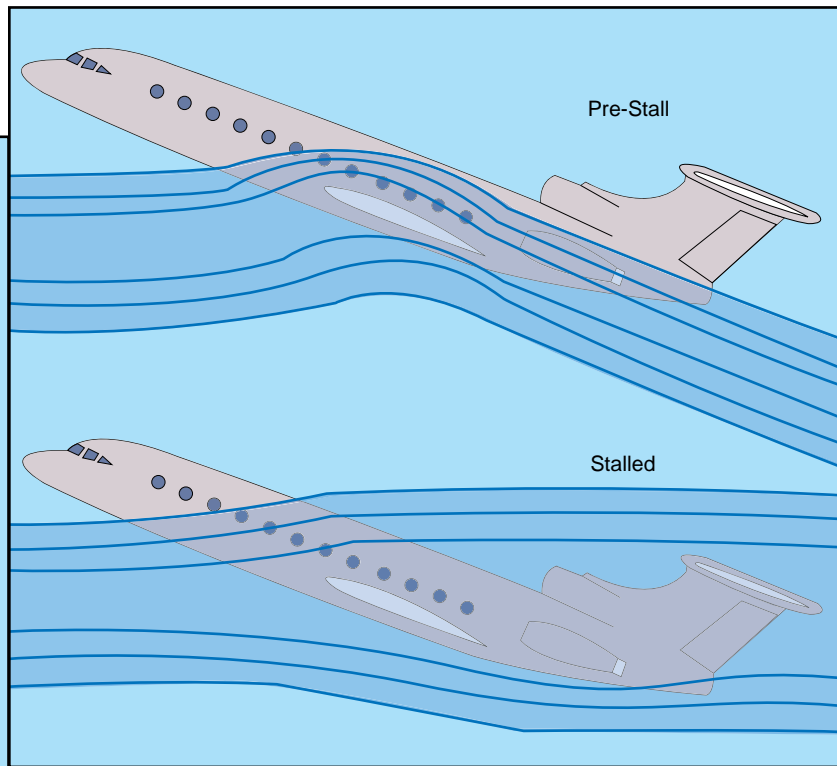

Figure 3-46. T-tail stall.

shaker,” on the other hand provides stall warning when the airspeed is 5 to 7 percent above stall speed.

### MACH BUFFET BOUNDARIES

Thus far, only the Mach buffet that results from excessive speed has been addressed. It must be remembered that Mach buffet is a function of the speed of the airflow over the wing—not necessarily the speed of the airplane. Any time that too great a



lift demand is made on the wing, whether from too fast an airspeed or from too high an angle of attack near the  $M_{MO}$ , the “high-speed” buffet will occur. However, there are also occasions when the buffet can be experienced at much lower speeds known as the “low-speed Mach buffet.”

The most likely situation that could cause the low-speed buffet would be when the airplane is flown at too slow a speed for its weight and altitude necessitating a high angle of attack. This very high angle of attack would have the effect of increasing airflow velocity over the upper surface of the wing to the point that all of the same effects of the shock waves and buffet would occur as in the high-speed buffet situation. The angle of attack of the wing has the greatest effect on inducing the Mach buffet at either the high-speed or low-speed boundaries for the airplane. The conditions that increase the angle of attack, hence the speed of the airflow over the wing and chances of Mach buffet are as follows:

- **High Altitudes**—The higher an airplane flies, the thinner the air and the greater the angle of attack required to produce the lift needed to maintain level flight.
- **Heavy Weights**—The heavier the airplane, the greater the lift required of the wing, and all other things being equal, the greater the angle of attack.
- **“G” Loading**—An increase in the “G” loading on the airplane has the same effect as increasing the weight of the airplane. Whether the increase in “G” forces is caused by turns, rough control usage, or turbulence, the effect of increasing the wing’s angle of attack is the same.

## FLIGHT CONTROLS

On high-speed airplanes, flight controls are divided into primary flight controls and secondary or auxiliary flight controls. The primary flight controls maneuver the airplane about the pitch, roll, and yaw axes. They include the ailerons, elevator, and rudder. Secondary or auxiliary flight controls include tabs, leading edge flaps, trailing edge flaps, spoilers, and slats.

Spoilers are used on the upper surface of the wing to spoil or reduce lift. High-speed airplanes, due to their clean low drag design use spoilers as speed brakes to slow them down. Spoilers are extended immediately after touchdown to dump lift and thus transfer the weight of the airplane from the wings onto the wheels for better braking performance. [Figure 3-47]

Jet transport airplanes have small ailerons. The space for ailerons is limited because as much of the wing

trailing edge as possible is needed for flaps. Another reason is that a conventional size aileron would cause wing twist at high speed. Because the ailerons are necessarily small, spoilers are used in unison with ailerons to provide additional roll control.

Some jet transports have two sets of ailerons; a pair of outboard low-speed ailerons, and a pair of high-speed inboard ailerons. When the flaps are fully retracted after takeoff, the outboard ailerons are automatically locked out in the faired position.

When used for roll control, the spoiler on the side of the up-going aileron extends and reduces the lift on that side, causing the wing to drop. If the spoilers are extended as speed brakes, they can still be used for roll control. If they are the Differential type, they will extend further on one side and retract on the other side. If they are the Non-Differential type, they will extend further on one side but will not retract on the other side. When fully extended as speed brakes, the Non-Differential spoilers remain extended and do not supplement the ailerons.

To obtain a smooth stall and a higher angle of attack without airflow separation, an airplane’s wing leading edge should have a well-rounded almost blunt shape that the airflow can adhere to at the higher angle of attack. With this shape, the airflow separation will start at the trailing edge and progress forward gradually as angle of attack is increased.

The pointed leading edge necessary for high-speed flight results in an abrupt stall and restricts the use of trailing edge flaps because the airflow cannot follow the sharp curve around the wing leading edge. The airflow tends to tear loose rather suddenly from the upper surface at a moderate angle of attack. To utilize trailing edge flaps, and thus increase the maximum lift coefficient, the wing must go to a higher angle of attack without airflow separation. Therefore, leading edge slots, slats, and flaps are used to improve the low-speed characteristics during takeoff, climb, and landing. Although these devices are not as powerful as trailing edge flaps, they are effective when used full span in combination with high-lift trailing edge flaps. With the aid of these sophisticated high-lift devices, airflow separation is delayed and the maximum lift coefficient ( $C_{Lmax}$ ) is increased considerably. In fact, a 50-knot reduction in stall speed is not uncommon.

The operational requirements of a large jet transport airplane necessitate large pitch trim changes. Some of these requirements are:

- The requirement for a large CG range.
- The need to cover a large speed range.

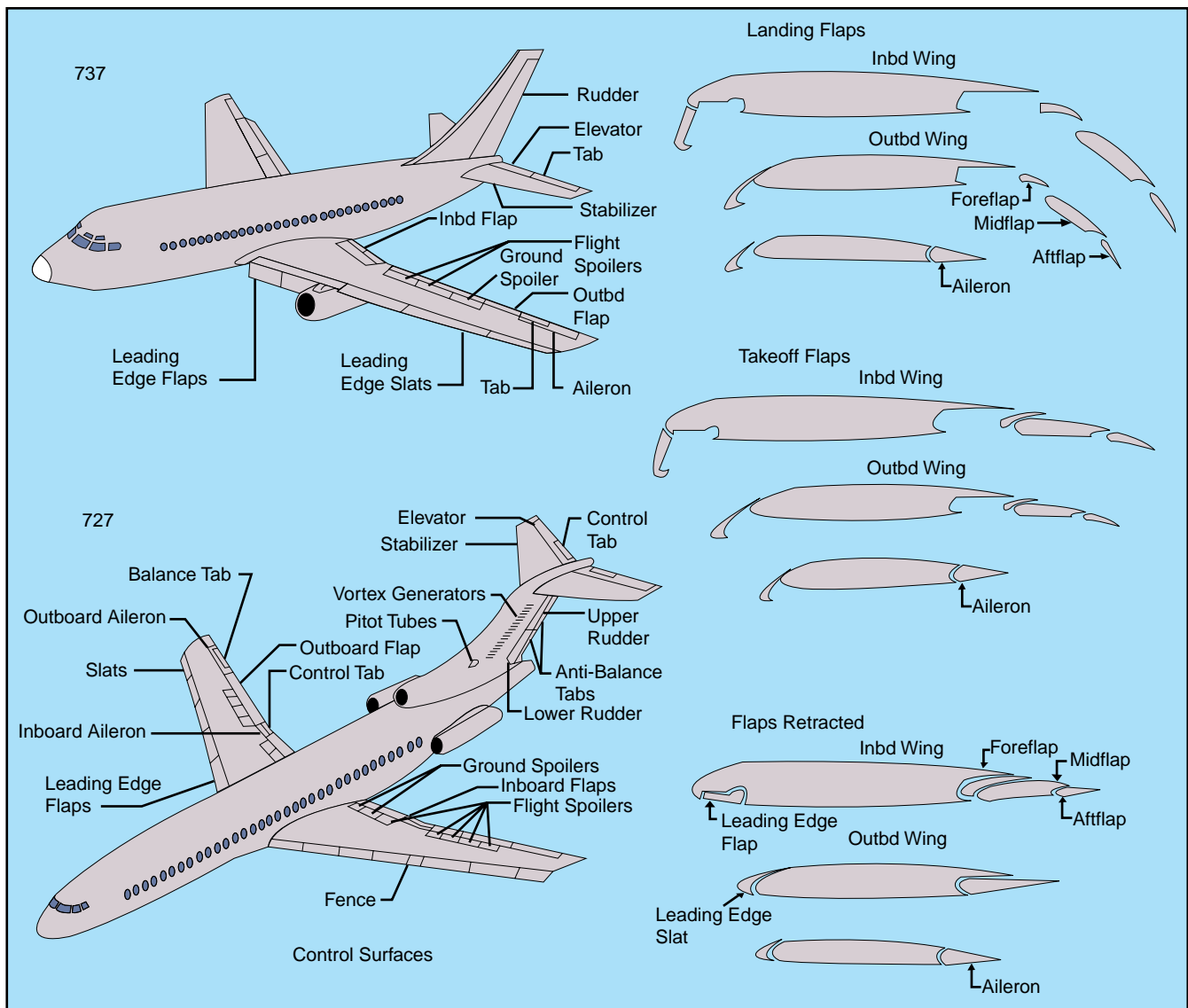

Figure 3-47. Control surfaces.

- The need to cope with possibly large trim changes due to wing leading edge and trailing edge high-lift devices without limiting the amount of elevator remaining.
- The need to reduce trim drag to a minimum.

These requirements are met by the use of a variable incidence horizontal stabilizer. Large trim changes on a fixed-tail airplane require large elevator deflections. At these large deflections, little further elevator movement remains in the same direction. A variable incidence horizontal stabilizer is designed to take out the trim changes. The stabilizer is larger than the elevator, and consequently does not need to be moved through as large an angle. This leaves the elevator streamlining the tail plane with a full range of movement up and down. The variable incidence horizontal stabilizer can be set to handle the bulk of the pitch control demand, with the elevator handling the rest. On airplanes equipped with a variable

incidence horizontal stabilizer, the elevator is smaller and less effective in isolation than it is on a fixed-tail airplane. In comparison to other flight controls, the variable incidence horizontal stabilizer is enormously powerful in its effect. Its use and effect must be fully understood and appreciated by flight crewmembers.

Because of the size and high speeds of jet transport airplanes, the forces required to move the control surfaces can be beyond the strength of the pilot. Consequently, the control surfaces are actuated by hydraulic or electrical power units. Moving the controls in the cockpit signals the control angle required, and the power unit positions the actual control surface. In the event of complete power unit failure, movement of the control surface can be effected by manually controlling the control tabs. Moving the control tab upsets the aerodynamic balance which causes the control surface to move.



# Chapter 4



## Flight Controls

Aircraft flight control systems are classified as primary and secondary. The primary control systems consist of those that are required to safely control an airplane during flight. These include the ailerons, elevator (or stabilator), and rudder. Secondary control systems improve the performance characteristics of the airplane, or relieve the pilot of excessive control forces. Examples of secondary control systems are wing flaps and trim systems.

### PRIMARY FLIGHT CONTROLS

Airplane control systems are carefully designed to provide a natural feel, and at the same time, allow adequate responsiveness to control inputs. At low airspeeds, the controls usually feel soft and sluggish, and the airplane responds slowly to control applications. At high speeds, the controls feel firm and the response is more rapid.

Movement of any of the three primary flight control surfaces changes the airflow and pressure distribution over and around the airfoil. These changes affect the lift and drag produced by the airfoil/control surface combination, and allow a pilot to control the airplane about its three axes of rotation.

Design features limit the amount of deflection of flight control surfaces. For example, control-stop mechanisms may be incorporated into the flight controls, or movement of the control column and/or rudder pedals may be limited. The purpose of these design limits is to prevent the pilot from inadvertently overcontrolling and overstressing the aircraft during normal maneuvers.

A properly designed airplane should be stable and easily controlled during maneuvering. Control surface inputs cause movement about the three axes of rotation. The types of stability an airplane exhibits also relate to the three axes of rotation. [Figure 4-1]

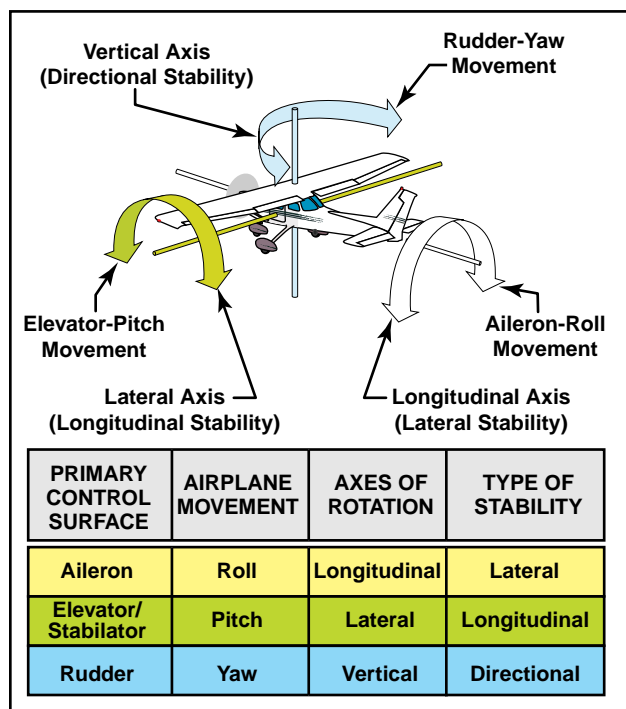

Figure 4-1. Airplane controls, movement, axes of rotation, and type of stability.

### AILERONS

Ailerons control roll about the longitudinal axis. The ailerons are attached to the outboard trailing edge of

each wing and move in the opposite direction from each other. Ailerons are connected by cables, bellcranks, pulleys or push-pull tubes to each other and to the control wheel.

Moving the control wheel to the right causes the right aileron to deflect upward and the left aileron to deflect downward. The upward deflection of the right aileron decreases the camber resulting in decreased lift on the right wing. The corresponding downward deflection of the left aileron increases the camber resulting in increased lift on the left wing. Thus, the increased lift on the left wing and the decreased lift on the right wing causes the airplane to roll to the right.

### ADVERSE YAW

Since the downward deflected aileron produces more lift, it also produces more drag. This added drag attempts to yaw the airplane's nose in the direction of the raised wing. This is called adverse yaw. [Figure 4-2]

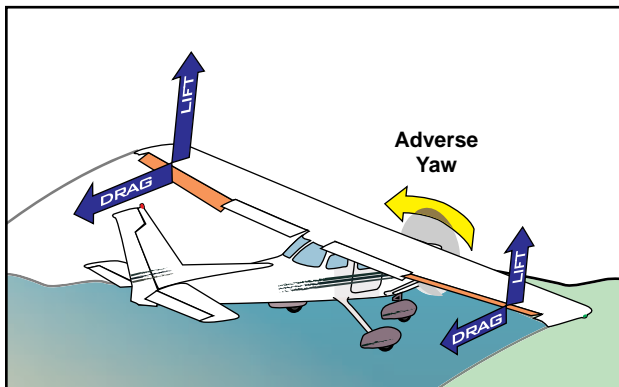

Figure 4-2. Adverse yaw is caused by higher drag on the outside wing, which is producing more lift.

The rudder is used to counteract adverse yaw, and the amount of rudder control required is greatest at low airspeeds, high angles of attack, and with large aileron deflections. However, with lower airspeeds, the vertical stabilizer/rudder combination becomes less effective, and magnifies the control problems associated with adverse yaw.

All turns are coordinated by use of ailerons, rudder, and elevator. Applying aileron pressure is necessary to place the airplane in the desired angle of bank, while simultaneously applying rudder pressure to counteract the resultant adverse yaw. During a turn, the angle of attack must be increased by applying elevator pressure because more lift is required than when in straight-and-level flight. The steeper the turn, the more back elevator pressure is needed.

As the desired angle of bank is established, aileron and rudder pressures should be relaxed. This will stop the bank from increasing because the aileron and rudder control surfaces will be neutral in their streamlined position. Elevator pressure should be held constant to maintain a constant altitude.

The rollout from a turn is similar to the roll-in except the flight controls are applied in the opposite direction. Aileron and rudder are applied in the direction of the rollout or toward the high wing. As the angle of bank decreases, the elevator pressure should be relaxed as necessary to maintain altitude.

### DIFFERENTIAL AILERONS

With differential ailerons, one aileron is raised a greater distance than the other aileron is lowered for a given movement of the control wheel. This produces an increase in drag on the descending wing. The greater drag results from deflecting the up aileron on the descending wing to a greater angle than the down aileron on the rising wing. While adverse yaw is reduced, it is not eliminated completely. [Figure 4-3]

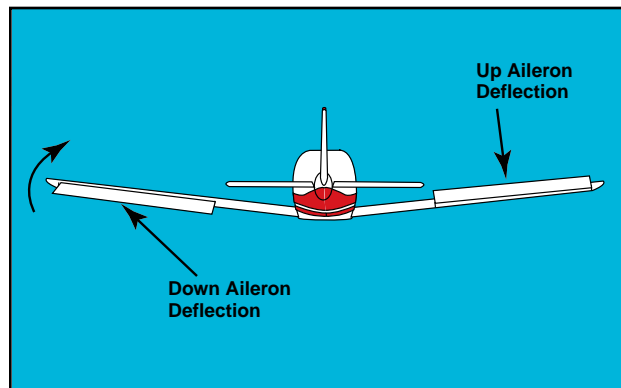

Figure 4-3. Differential ailerons.

### FRISE-TYPE AILERONS

With a Frise-type aileron, when pressure is applied to the control wheel, the aileron that is being raised pivots on an offset hinge. This projects the leading edge of the aileron into the airflow and creates drag. This helps equalize the drag created by the lowered aileron on the opposite wing and reduces adverse yaw. [Figure 4-4]

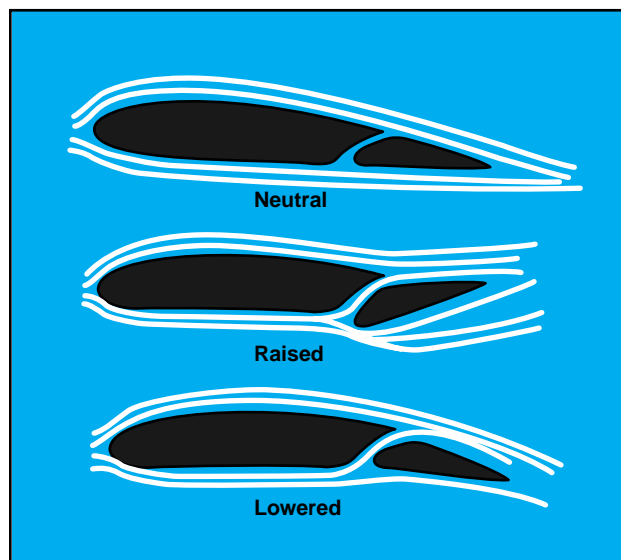

Figure 4-4. Frise-type ailerons.

The Frise-type aileron also forms a slot so that air flows smoothly over the lowered aileron, making it more effective at high angles of attack. Frise-type ailerons also may be designed to function differentially. Like the differential aileron, the Frise-type aileron does not eliminate adverse yaw entirely. Coordinated rudder application is still needed wherever ailerons are applied.

### COUPLED AILERONS AND RUDDER

Coupled ailerons and rudder means these controls are linked. This is accomplished with rudder-aileron interconnect springs, which help correct for aileron drag by automatically deflecting the rudder at the same time the ailerons are deflected. For example, when the control yoke is moved to produce a left roll, the interconnect cable and spring pulls forward on the left rudder pedal just enough to prevent the nose of the airplane from yawing to the right. The force applied to the rudder by the springs can be overridden if it becomes necessary to slip the airplane. [Figure 4-5]

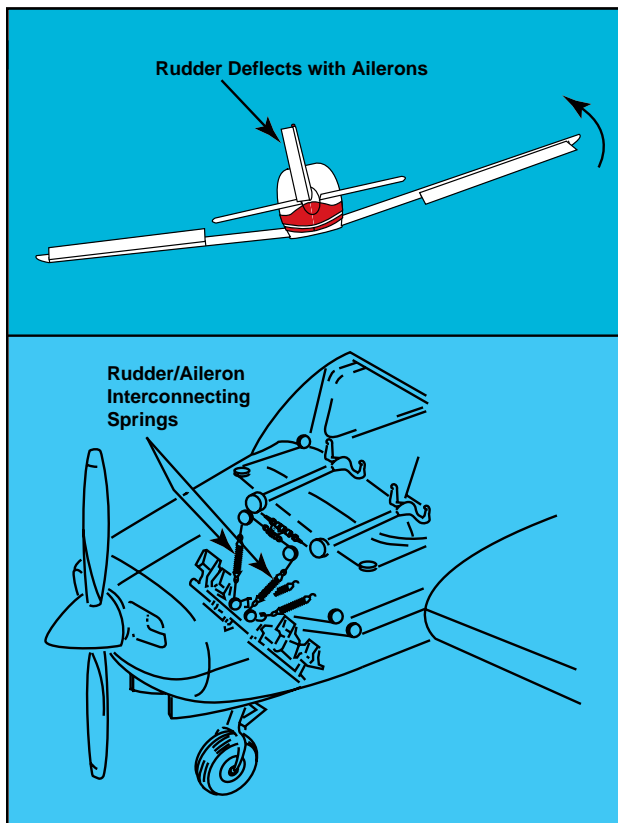

Figure 4-5. Coupled ailerons and rudder.

### ELEVATOR

The elevator controls pitch about the lateral axis. Like the ailerons on small airplanes, the elevator is connected to the control column in the cockpit by a series of mechanical linkages. Aft movement of the control column deflects the trailing edge of the elevator surface up. This is usually referred to as up elevator. [Figure 4-6]

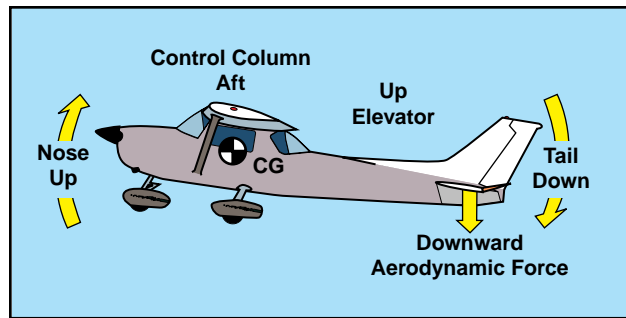

Figure 4-6. The elevator is the primary control for changing the pitch attitude of an airplane.

The up-elevator position decreases the camber of the elevator and creates a downward aerodynamic force, which is greater than the normal tail-down force that exists in straight-and-level flight. The overall effect causes the tail of the airplane to move down and the nose to pitch up. The pitching moment occurs about the center of gravity (CG). The strength of the pitching moment is determined by the distance between the CG and the horizontal tail surface, as well as by the aerodynamic effectiveness of the horizontal tail surface.

Moving the control column forward has the opposite effect. In this case, elevator camber increases, creating more lift (less tail-down force) on the horizontal stabilizer/elevator. This moves the tail upward and pitches the nose down. Again, the pitching moment occurs about the CG.

As mentioned earlier in the coverage on stability, power, thrustline, and the position of the horizontal tail surfaces on the empennage are factors in how effective the elevator is in controlling pitch. For example, the horizontal tail surfaces may be attached near the lower part of the vertical stabilizer, at the midpoint, or at the high point, as in the T-tail design.

### T-TAIL

In a T-tail configuration, the elevator is above most of the effects of downwash from the propeller as well as airflow around the fuselage and/or wings during normal flight conditions. Operation of the elevators in this undisturbed air makes for control movements that are consistent throughout most flight regimes. T-tail designs have become popular on many light airplanes and on large aircraft, especially those with aft-fuselage mounted engines since the T-tail configuration removes the tail from the exhaust blast of the engines. Seaplanes and amphibians often have T-tails in order to keep the horizontal surfaces as far from the water as possible. An additional benefit is reduced vibration and noise inside the aircraft.

At slow speeds, the elevator on a T-tail aircraft must be moved through a larger number of degrees of travel to raise the nose a given amount as compared to a conventional-tail aircraft. This is because the

conventional-tail aircraft has the downwash from the propeller pushing down on the tail to assist in raising the nose. Since controls on aircraft are rigged in such a manner as to require increasing control forces for increased control travel, the forces required to raise the nose of a T-tail aircraft are greater than for a conventional-tail aircraft. Longitudinal stability of a trimmed aircraft is the same for both types of configuration, but the pilot must be aware that at slow speeds during takeoffs and landings or stalls, the control forces will be greater than for similar size airplanes equipped with conventional tails.

T-tail airplanes also require additional design considerations to counter the problem of flutter. Since the weight of the horizontal surfaces is at the top of the vertical stabilizer, the moment arm created causes high loads on the vertical stabilizer which can result in flutter. Engineers must compensate for this by increasing the design stiffness of the vertical stabilizer, usually resulting in a weight penalty over conventional tail designs.

When flying at a very high angle of attack with a low airspeed and an aft CG, the T-tail airplane may be susceptible to a deep stall. In a deep stall, the airflow over the horizontal tail is blanketed by the disturbed airflow from the wings and fuselage. In these circumstances, elevator or stabilator control could be diminished, making it difficult to recover from the stall. It should be noted that an aft CG could be a contributing factor in these incidents since similar recovery problems are also found with conventional-tail aircraft with an aft CG. [Figure 4-7]

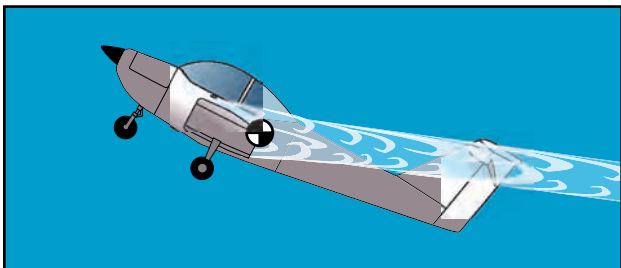
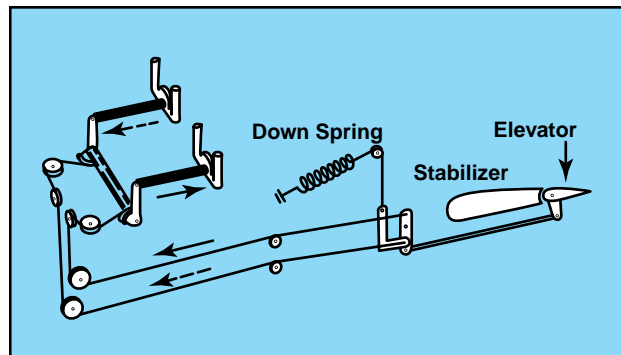

**Figure 4-7. Airplane with a T-tail design at a high angle of attack and an aft CG.**

Since flight at a high angle of attack with a low airspeed and an aft CG position can be dangerous, many airplanes have systems to compensate for this situation. The systems range from control stops to elevator down springs. An elevator down spring assists in lowering the nose to prevent a stall caused by the aft CG position. The stall occurs because the properly trimmed airplane is flying with the elevator in a trailing edge down position, forcing the tail up and the nose down. In this unstable condition, if the airplane encounters turbulence and slows down further, the trim

tab no longer positions the elevator in the nose-down position. The elevator then streamlines, and the nose of the aircraft pitches upward. This aggravates the situation and can possibly result in a stall.

The elevator down spring produces a mechanical load on the elevator, causing it to move toward the nose-down position if not otherwise balanced. The elevator trim tab balances the elevator down spring to position the elevator in a trimmed position. When the trim tab becomes ineffective, the down spring drives the elevator to a nose down position. The nose of the aircraft lowers, speed builds up, and a stall is prevented. [Figure 4-8]



**Figure 4-8. When the aerodynamic efficiency of the horizontal tail surface is inadequate due to an aft center of gravity condition, an elevator down spring may be used to supply a mechanical load to lower the nose.**

The elevator must also have sufficient authority to hold the nose of the airplane up during the roundout for a landing. In this case, a forward CG may cause a problem. During the landing flare, power normally is reduced, which decreases the airflow over the empennage. This, coupled with the reduced landing speed, makes the elevator less effective.

From this discussion, it should be apparent that pilots must understand and follow proper loading procedures, particularly with regard to the CG position. More information on aircraft loading, as well as weight and balance, is included in Chapter 8.

## STABILATOR

As mentioned in Chapter 1, a stabilator is essentially a one-piece horizontal stabilizer with the same type of control system. Because stabilators pivot around a central hinge point, they are extremely sensitive to control inputs and aerodynamic loads.

Antiservo tabs are incorporated on the trailing edge to decrease sensitivity. In addition, a balance weight is usually incorporated ahead of the main spar. The balance weight may project into the empennage or may be incorporated on the forward portion of the stabilator tips. [Figure 4-9]

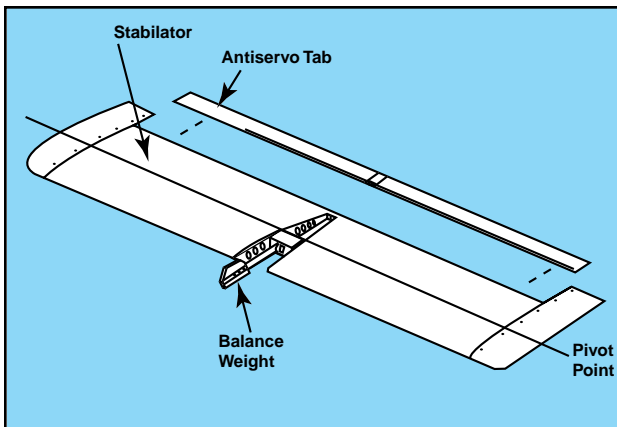

**Figure 4-9.** The stabilator is a one-piece horizontal tail surface that pivots up and down about a central hinge point.

When the control column is pulled back, it raises the stabilator's trailing edge, rotating the airplane's nose up. Pushing the control column forward lowers the trailing edge of the stabilator and pitches the nose of the airplane down. Without an antiservo tab, the airplane would be prone to overcontrolling from pilot-induced control inputs.

## CANARD

The term **canard** refers to a control surface that functions as a horizontal stabilizer but is located in front of the main wings. The term also is used to describe an airplane equipped with a canard. In effect, it is an airfoil similar to the horizontal surface on a conventional aft-tail design. The difference is that the canard actually creates lift and holds the nose up, as opposed to the aft-tail design which exerts downward force on the tail to prevent the nose from rotating downward. [Figure 4-10]



**Figure 4-10.** This advanced aircraft includes a variable-sweep canard design, which provides longitudinal stability about the lateral axis.

**Canard**—A horizontal surface mounted ahead of the main wing to provide longitudinal stability and control. It may be a fixed, movable, or variable geometry surface, with or without control surfaces.

**Canard Configuration**—A configuration in which the span of the forward wings is substantially less than that of the main wing.

Although the Wright Flyer was configured as a canard with the horizontal surfaces in front of the lifting surface, it was not until recently that the **canard configuration** began appearing on newer airplanes. Canard designs include two types—one with a horizontal surface of about the same size as a normal aft-tail design, and the other with a surface of the same approximate size and airfoil of the aft-mounted wing known as a tandem wing configuration. Theoretically, the canard is considered more efficient because using the horizontal surface to help lift the weight of the aircraft should result in less drag for a given amount of lift.

The canard's main advantage is in the area of stall characteristics. A properly designed canard or tandem wing will run out of authority to raise the nose of the aircraft at a point before the main wing will stall. This makes the aircraft stall-proof and results only in a descent rate that can be halted by adding power. Ailerons on the main wing remain effective throughout the recovery. Other canard configurations are designed so the canard stalls before the main wing, automatically lowering the nose and recovering the aircraft to a safe flying speed. Again, the ailerons remain effective throughout the stall.

The canard design has several limitations. First, it is important that the forward lifting surface of a canard design stalls before the main wing. If the main wing stalls first, the lift remaining from the forward wing or canard would be well ahead of the CG, and the airplane would pitch up uncontrollably. Second, when the forward surface stalls first, or is limited in its ability to increase the angle of attack, the main wing never reaches a point where its maximum lift is created, sacrificing some performance. Third, use of flaps on the main wing causes design problems for the forward wing or canard. As lift on the main wing is increased by extension of flaps, the lift requirement of the canard is also increased. The forward wing or canard must be large enough to accommodate flap use, but not so large that it creates more lift than the main wing.

Finally, the relationship of the main wing to the forward surface also makes a difference. When positioned closely in the vertical plane, downwash from the forward wing can have a negative effect on the lift of the main wing. Increasing vertical separation increases efficiency of the design. Efficiency is also increased as the size of the two surfaces grows closer to being equal.

## RUDDER

The rudder controls movement of the airplane about its vertical axis. This motion is called yaw. Like the



other primary control surfaces, the rudder is a movable surface hinged to a fixed surface, in this case, to the vertical stabilizer, or fin. Moving the left or right rudder pedal controls the rudder. When the rudder is deflected into the airflow, a horizontal force is exerted in the opposite direction. [Figure 4-11]

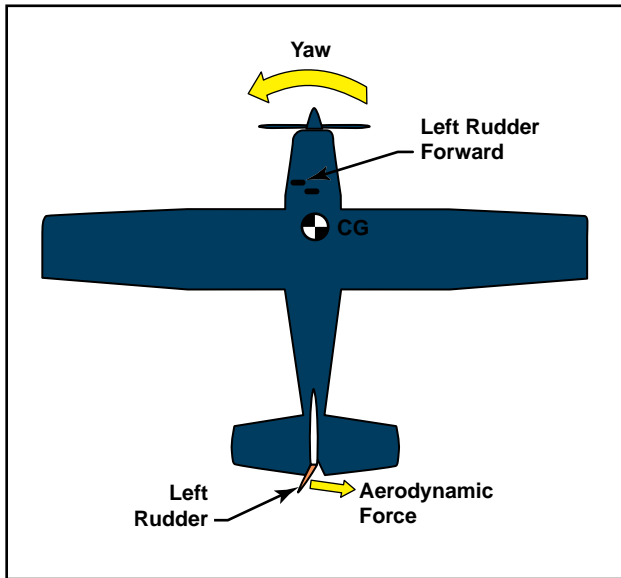

Figure 4-11. The effect of left rudder pressure.

By pushing the left pedal, the rudder moves left. This alters the airflow around the vertical stabilizer/rudder, and creates a sideward lift that moves the tail to the right and yaws the nose of the airplane to the left. Rudder effectiveness increases with speed, so large deflections at low speeds and small deflections at high speeds may be required to provide the desired reaction. In propeller-driven aircraft, any slipstream flowing over the rudder increases its effectiveness.

### V-TAIL

The V-tail design utilizes two slanted tail surfaces to perform the same functions as the surfaces of a conventional elevator and rudder configuration. The fixed surfaces act as both horizontal and vertical stabilizers. [Figure 4-12]



Figure 4-12. V-tail design.

The movable surfaces, which are usually called **ruddervators**, are connected through a special linkage that allows the control wheel to move both surfaces simultaneously. On the other hand, displacement of the rudder pedals moves the surfaces differentially, thereby providing directional control.

When both rudder and elevator controls are moved by the pilot, a control mixing mechanism moves each surface the appropriate amount. The control system for the V-tail is more complex than that required for a conventional tail. In addition, the V-tail design is more susceptible to Dutch roll tendencies than a conventional tail and total reduction in drag is only minimal.

## SECONDARY FLIGHT CONTROLS

Secondary flight control systems may consist of the flaps, leading edge devices, spoilers, and trim devices.

### FLAPS

Flaps are the most common high-lift devices used on practically all airplanes. These surfaces, which are attached to the trailing edge of the wing, increase both lift and induced drag for any given angle of attack. Flaps allow a compromise between high cruising speed and low landing speed, because they may be extended when needed, and retracted into the wing's structure when not needed. There are four common types of flaps: plain, split, slotted, and Fowler flaps. [Figure 4-13]

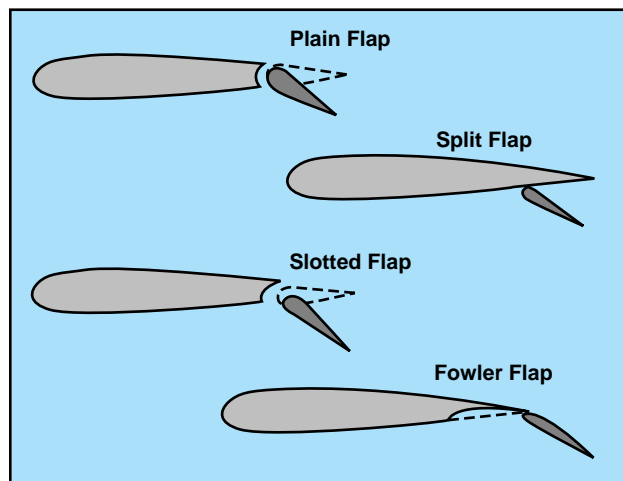

Figure 4-13. Four common types of flaps

The plain flap is the simplest of the four types. It increases the airfoil camber, resulting in a significant increase in the coefficient of lift at a given angle of attack. At the same time, it greatly increases drag and moves the center of pressure aft on the airfoil, resulting in a nose-down pitching moment.

**Ruddervator**—A pair of control surfaces on the tail of an aircraft arranged in the form of a V. These surfaces, when moved together by the control wheel, serve as elevators, and when moved differentially by the rudder pedals, serve as a rudder.

The split flap is deflected from the lower surface of the airfoil and produces a slightly greater increase in lift than does the plain flap. However, more drag is created because of the turbulent air pattern produced behind the airfoil. When fully extended, both plain and split flaps produce high drag with little additional lift.

The most popular flap on airplanes today is the slotted flap. Variations of this design are used for small airplanes as well as for large ones. Slotted flaps increase the lift coefficient significantly more than plain or split flaps. On small airplanes, the hinge is located below the lower surface of the flap, and when the flap is lowered, it forms a duct between the flap well in the wing and the leading edge of the flap.

When the slotted flap is lowered, high-energy air from the lower surface is ducted to the flap's upper surface. The high-energy air from the slot accelerates the upper surface boundary layer and delays airflow separation, providing a higher coefficient of lift. Thus, the slotted flap produces much greater increases in  $C_{Lmax}$  than the plain or split flap. While there are many types of slotted flaps, large airplanes often have double- and even triple-slotted flaps. These allow the maximum increase in drag without the airflow over the flaps separating and destroying the lift they produce.

Fowler flaps are a type of slotted flap. This flap design not only changes the camber of the wing, it also increases the wing area. Instead of rotating down on a hinge, it slides backwards on tracks. In the first portion of its extension, it increases the drag very little, but increases the lift a great deal as it increases both the area and camber. As the extension continues, the flap deflects downward, and during the last portion of its travel, it increases the drag with little additional increase in lift.

### LEADING EDGE DEVICES

High-lift devices also can be applied to the leading edge of the airfoil. The most common types are fixed slots, movable slats, and leading edge flaps. [Figure 4-14]

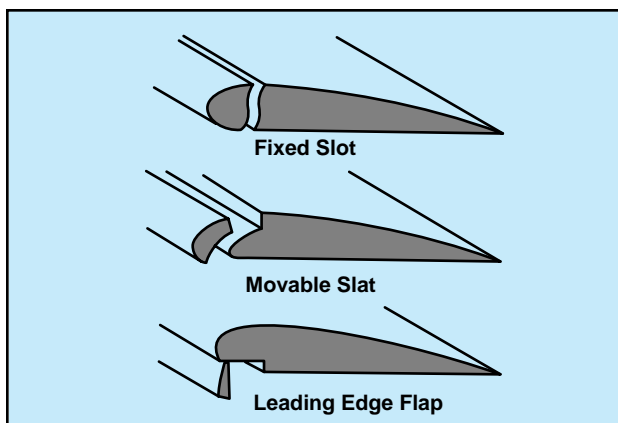

Figure 4-14. Leading edge high lift devices.

Fixed slots direct airflow to the upper wing surface and delay airflow separation at higher angles of attack. The slot does not increase the wing camber, but allows a higher maximum coefficient of lift because the stall is delayed until the wing reaches a greater angle of attack.

Movable slats consist of leading edge segments, which move on tracks. At low angles of attack, each slat is held flush against the wing's leading edge by the high pressure that forms at the wing's leading edge. As the angle of attack increases, the high-pressure area moves aft below the lower surface of the wing, allowing the slats to move forward. Some slats, however, are pilot operated and can be deployed at any angle of attack. Opening a slat allows the air below the wing to flow over the wing's upper surface, delaying airflow separation.

Leading edge flaps, like trailing edge flaps, are used to increase both  $C_{Lmax}$  and the camber of the wings. This type of leading edge device is frequently used in conjunction with trailing edge flaps and can reduce the nose-down pitching movement produced by the latter. As is true with trailing edge flaps, a small increment of leading edge flaps increases lift to a much greater extent than drag. As greater amounts of flaps are extended, drag increases at a greater rate than lift.

### SPOILERS

On some airplanes, high-drag devices called spoilers are deployed from the wings to spoil the smooth airflow, reducing lift and increasing drag. Spoilers are used for roll control on some aircraft, one of the advantages being the elimination of adverse yaw. To turn right, for example, the spoiler on the right wing is raised, destroying some of the lift and creating more drag on the right. The right wing drops, and the airplane banks and yaws to the right. Deploying spoilers on both wings at the same time allows the aircraft to descend without gaining speed. Spoilers are also deployed to help shorten ground roll after landing. By destroying lift, they transfer weight to the wheels, improving braking effectiveness. [Figure 4-15]



Figure 4-15. Spoilers reduce lift and increase drag during descent and landing.

## TRIM SYSTEMS

Although the airplane can be operated throughout a wide range of attitudes, airspeeds, and power settings, it can only be designed to fly hands off within a very limited combination of these variables. Therefore, trim systems are used to relieve the pilot of the need to maintain constant pressure on the flight controls. Trim systems usually consist of cockpit controls and small hinged devices attached to the trailing edge of one or more of the primary flight control surfaces. They are designed to help minimize a pilot's workload by aerodynamically assisting movement and position of the flight control surface to which they are attached. Common types of trim systems include trim tabs, balance tabs, antiservo tabs, ground adjustable tabs, and an adjustable stabilizer.

### TRIM TABS

The most common installation on small airplanes is a single trim tab attached to the trailing edge of the elevator. Most trim tabs are manually operated by a small, vertically mounted control wheel. However, a trim crank may be found in some airplanes. The cockpit control includes a tab position indicator. Placing the trim control in the full nose-down position moves the tab to its full up position. With the tab up and into the airstream, the airflow over the horizontal tail surface tends to force the trailing edge of the elevator down. This causes the tail of the airplane to move up, and results in a nose-down pitch change. [Figure 4-16]

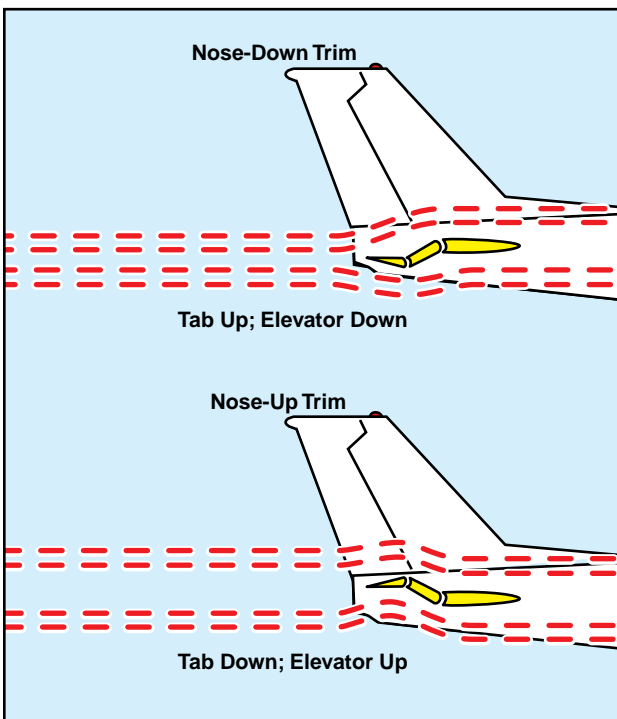

Figure 4-16. The movement of the elevator is opposite to the direction of movement of the elevator trim tab.

If you set the trim tab to the full nose-up position, the tab moves to its full-down position. In this case, the air flowing under the horizontal tail surface hits the tab and tends to force the trailing edge of the elevator up, reducing the elevator's angle of attack. This causes a tail-down movement of the airplane and a nose-up pitch change.

In spite of the opposite direction movement of the trim tab and the elevator, control of trim is natural to a pilot. If you have to exert constant back pressure on the control column, the need for nose-up trim is indicated. The normal trim procedure is to continue trimming until the airplane is balanced and the nose-heavy condition is no longer apparent. Pilots normally establish the desired power, pitch attitude, and configuration first, and then trim the airplane to relieve control pressures that may exist for that flight condition. Any time power, pitch attitude, or configuration is changed, expect that retrimming will be necessary to relieve the control pressures for the new flight condition.

### BALANCE TABS

The control forces may be excessively high in some airplanes, and in order to decrease them, the manufacturer may use balance tabs. They look like trim tabs and are hinged in approximately the same places as trim tabs. The essential difference between the two is that the balancing tab is coupled to the control surface rod so that when the primary control surface is moved in any direction, the tab automatically moves in the opposite direction. In this manner, the airflow striking the tab counter-balances some of the air pressure against the primary control surface, and enables the pilot to more easily move and hold the control surface in position.

If the linkage between the tab and the fixed surface is adjustable from the cockpit, the tab acts as a combination trim and balance tab, which can be adjusted to any desired deflection. Any time the control surface is deflected, the tab moves in the opposite direction and eases the load on the pilot.

### ANTISERVO TABS

In addition to decreasing the sensitivity of the stabilator, an antiservo tab also functions as a trim device to relieve control pressure and maintain the stabilator in the desired position. The fixed end of the linkage is on the opposite side of the surface from the horn on the tab, and when the trailing edge of the stabilator moves up, the linkage forces the trailing edge of the tab up. When the stabilator moves down, the tab also moves down. This is different than trim tabs on elevators, which move opposite of the control surface. [Figure 4-17]

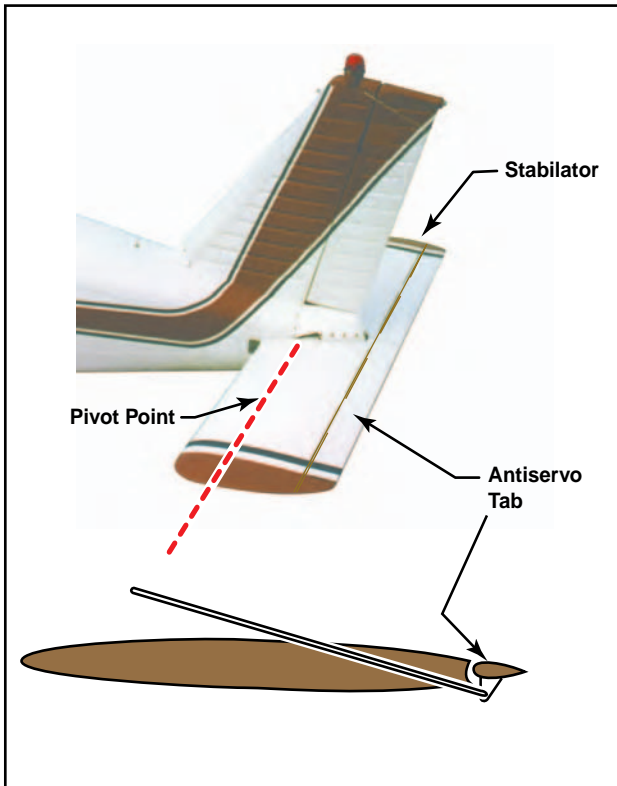

Figure 4-17. An antiservo tab attempts to streamline the control surface and is used to make the stabilator less sensitive by opposing the force exerted by the pilot.

This tab works in the same manner as the balance tab except that, instead of moving in the opposite direction, it moves in the same direction as the trailing edge of the stabilator. For example, when the trailing edge of the stabilator moves up, the linkage forces the trailing edge of the tab up. When the stabilator moves down, the tab also moves down.

### GROUND ADJUSTABLE TABS

Many small airplanes have a non-moveable metal trim tab on the rudder. This tab is bent in one direction or the other while on the ground to apply a trim force to the rudder. The correct displacement is determined by trial-and-error process. Usually, small adjustments are necessary until you are satisfied that the airplane is no longer skidding left or right during normal cruising flight. [Figure 4-18]

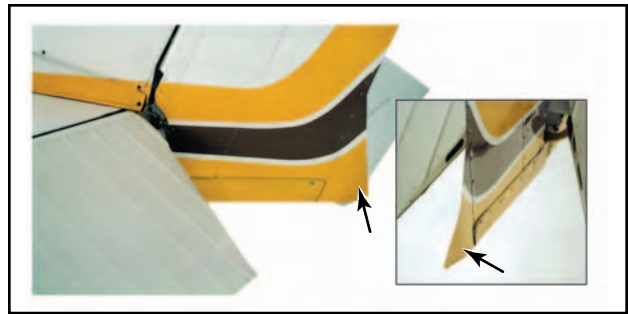

Figure 4-18. A ground-adjustable tab is used on the rudder of many small airplanes to correct for a tendency to fly with the fuselage slightly misaligned with the relative wind.

### ADJUSTABLE STABILIZER

Rather than using a movable tab on the trailing edge of the elevator, some airplanes have an adjustable stabilizer. With this arrangement, linkages pivot the horizontal stabilizer about its rear spar. This is accomplished by use of a jackscrew mounted on the leading edge of the stabilizer. [Figure 4-19]

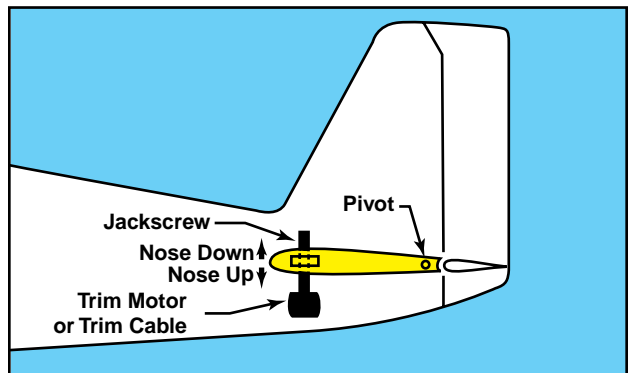

Figure 4-19. Some airplanes, including most jet transports, use an adjustable stabilizer to provide the required pitch trim forces.

On small airplanes, the jackscrew is cable-operated with a trim wheel or crank, and on larger airplanes, it is motor driven. The trimming effect and cockpit indications for an adjustable stabilizer are similar to those of a trim tab.

Since the primary and secondary flight control systems vary extensively between aircraft, you need to be familiar with the systems in your aircraft. A good source of information is the Airplane Flight Manual (AFM) or the Pilot's Operating Handbook (POH).



# Chapter 5

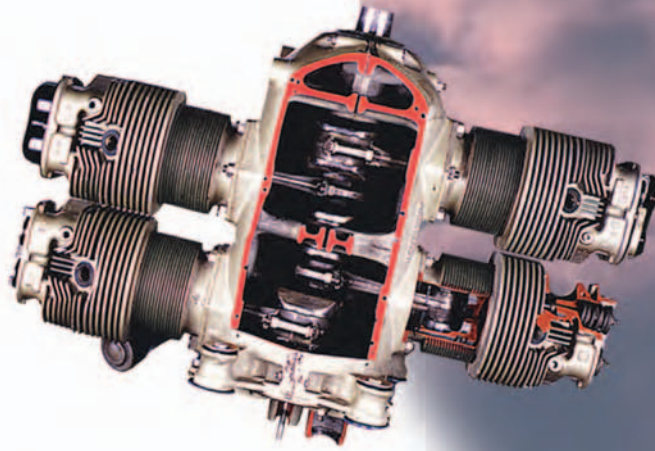

## Aircraft Systems

This chapter covers the main systems found on small airplanes. These include the engine, propeller, and induction systems, as well as the ignition, fuel, lubrication, cooling, electrical, landing gear, autopilot, and environmental control systems. A comprehensive introduction to gas turbine engines is included at the end of this chapter.

### POWERPLANT

The airplane engine and propeller, often referred to as a **powerplant**, work in combination to produce thrust. The powerplant propels the airplane and drives the various systems that support the operation of an airplane.

### RECIPROCATING ENGINES

Most small airplanes are designed with reciprocating engines. The name is derived from the back-and-forth, or reciprocating, movement of the pistons. It is this motion that produces the mechanical energy needed to accomplish work. Two common means of classifying reciprocating engines are:

1. by cylinder arrangement with respect to the crankshaft—radial, in-line, v-type or opposed, or
2. by the method of cooling—liquid or air-cooled.

**Powerplant**—A complete engine and propeller combination with accessories.

Radial engines were widely used during World War II, and many are still in service today. With these engines, a row or rows of cylinders are arranged in a circular pattern around the crankcase. The main advantage of a radial engine is the favorable power-to-weight ratio.

In-line engines have a comparatively small frontal area, but their power-to-weight ratios are relatively low. In addition, the rearmost cylinders of an air-cooled, in-line engine receive very little cooling air, so these engines are normally limited to four or six cylinders. V-type engines provide more horsepower than in-line engines and still retain a small frontal area. Further improvements in engine design led to the development of the horizontally-opposed engine.

Opposed-type engines are the most popular reciprocating engines used on small airplanes. These engines always have an even number of cylinders, since a cylinder on one side of the crankcase “opposes” a cylinder on the other side. The majority of these engines are air cooled and usually are mounted in a horizontal position when installed on fixed-wing airplanes. Opposed-type engines have high power-to-weight ratios because they have a comparatively small, lightweight crankcase. In addition, the compact cylinder arrangement reduces the engine’s frontal area and allows a streamlined installation that minimizes aerodynamic drag.

The main parts of a reciprocating engine include the cylinders, crankcase, and accessory housing. The intake/exhaust valves, spark plugs, and pistons are located in the cylinders. The crankshaft and connecting rods are located in the crankcase. [Figure 5-1] The magnetos are normally located on the engine accessory housing.

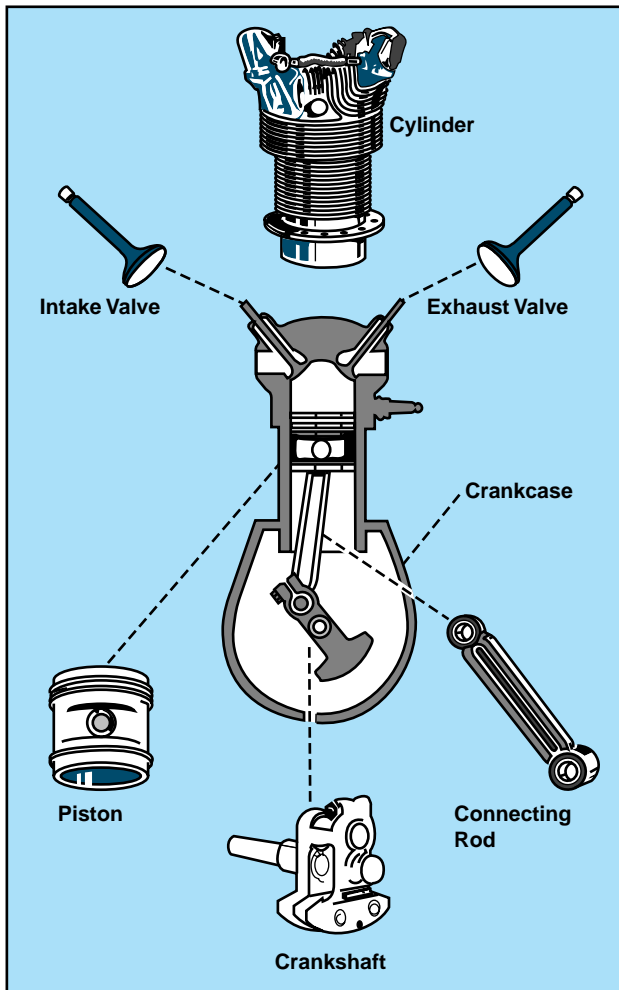

Figure 5-1. Main components of a reciprocating engine.

The basic principle for reciprocating engines involves the conversion of chemical energy, in the form of fuel, into mechanical energy. This occurs within the cylinders of the engine through a process known as the four-stroke operating cycle. These strokes are called intake, compression, power, and exhaust. [Figure 5-2]

1. The intake stroke begins as the piston starts its downward travel. When this happens, the intake valve opens and the fuel/air mixture is drawn into the cylinder.
2. The compression stroke begins when the intake valve closes and the piston starts moving back to the top of the cylinder. This phase of the cycle is used to obtain a much greater power output from the fuel/air mixture once it is ignited.

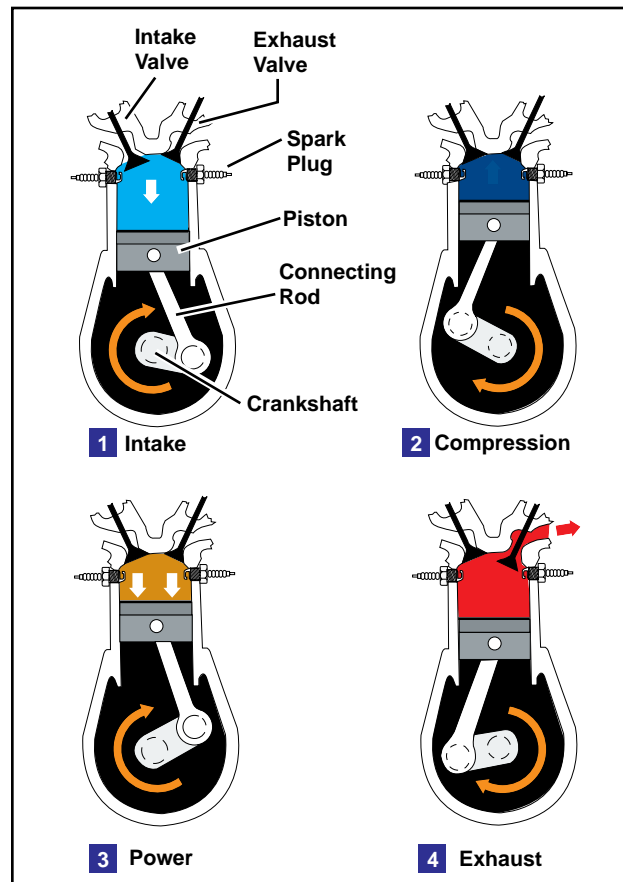

Figure 5-2. The arrows in this illustration indicate the direction of motion of the crankshaft and piston during the four-stroke cycle.

3. The power stroke begins when the fuel/air mixture is ignited. This causes a tremendous pressure increase in the cylinder, and forces the piston downward away from the cylinder head, creating the power that turns the crankshaft.
4. The exhaust stroke is used to purge the cylinder of burned gases. It begins when the exhaust valve opens and the piston starts to move toward the cylinder head once again.

Even when the engine is operated at a fairly low speed, the four-stroke cycle takes place several hundred times each minute. In a four-cylinder engine, each cylinder operates on a different stroke. Continuous rotation of a crankshaft is maintained by the precise timing of the power strokes in each cylinder. Continuous operation of the engine depends on the simultaneous function of auxiliary systems, including the induction, ignition, fuel, oil, cooling, and exhaust systems.

## PROPELLER

The propeller is a rotating airfoil, subject to induced drag, stalls, and other aerodynamic principles that apply to any airfoil. It provides the necessary thrust to pull, or in some cases push, the airplane through the air. The engine power is used to rotate the propeller, which

in turn generates thrust very similar to the manner in which a wing produces lift. The amount of thrust produced depends on the shape of the airfoil, the angle of attack of the propeller blade, and the r.p.m. of the engine. The propeller itself is twisted so the blade angle changes from hub to tip. The greatest **angle of incidence**, or the highest pitch, is at the hub while the smallest pitch is at the tip. [Figure 5-3]

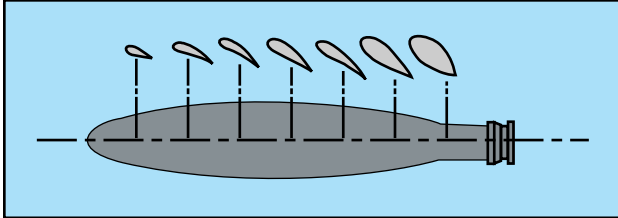

Figure 5-3. Changes in propeller blade angle from hub to tip.

The reason for the twist is to produce uniform lift from the hub to the tip. As the blade rotates, there is a difference in the actual speed of the various portions of the blade. The tip of the blade travels faster than that part near the hub, because the tip travels a greater distance than the hub in the same length of time. Changing the angle of incidence (pitch) from the hub to the tip to correspond with the speed produces uniform lift throughout the length of the blade. If the propeller blade was designed with the same angle of incidence throughout its entire length, it would be inefficient, because as airspeed increases in flight, the portion near the hub would have a negative angle of attack while the blade tip would be stalled. [Figure 5-4]

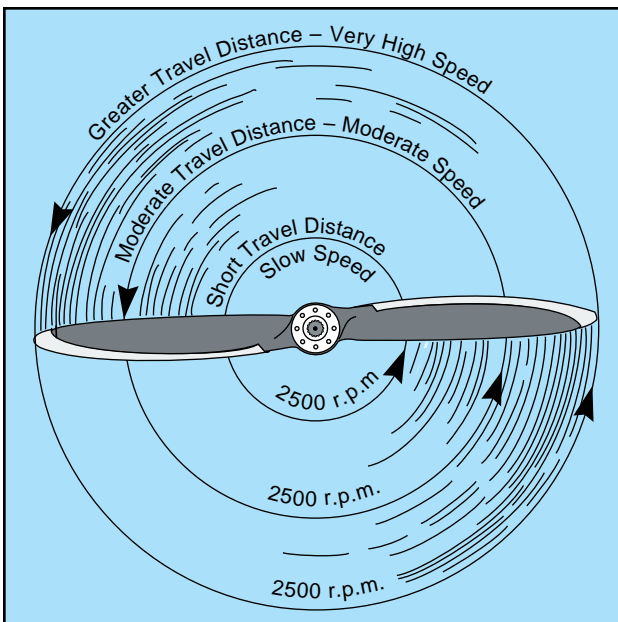

Figure 5-4. Relationship of travel distance and speed of various portions of propeller blade.

**Angle of Incidence**—For a propeller, it is the angle formed by the chord line and the reference plane containing the propeller hub. For a wing, it is the angle formed by the chord line of the wing and the longitudinal axis of the airplane.

Small airplanes are equipped with either one of two types of propellers. One is the fixed-pitch, and the other is the controllable-pitch.

### FIXED-PITCH PROPELLER

The pitch of this propeller is set by the manufacturer, and cannot be changed. With this type of propeller, the best efficiency is achieved only at a given combination of airspeed and r.p.m.

There are two types of fixed-pitch propellers—the climb propeller and the cruise propeller. Whether the airplane has a climb or cruise propeller installed depends upon its intended use:

- The climb propeller has a lower pitch, therefore less drag. Less drag results in higher r.p.m. and more horsepower capability, which increases performance during takeoffs and climbs, but decreases performance during cruising flight.
- The cruise propeller has a higher pitch, therefore more drag. More drag results in lower r.p.m. and less horsepower capability, which decreases performance during takeoffs and climbs, but increases efficiency during cruising flight.

The propeller is usually mounted on a shaft, which may be an extension of the engine crankshaft. In this case, the r.p.m. of the propeller would be the same as the crankshaft r.p.m. On some engines, the propeller is mounted on a shaft geared to the engine crankshaft. In this type, the r.p.m. of the propeller is different than that of the engine. In a fixed-pitch propeller, the tachometer is the indicator of engine power. [Figure 5-5]



Figure 5-5. Engine r.p.m. is indicated on the tachometer.

A tachometer is calibrated in hundreds of r.p.m., and gives a direct indication of the engine and propeller r.p.m. The instrument is color-coded, with a green arc denoting the maximum continuous operating r.p.m. Some tachometers have additional markings to reflect



engine and/or propeller limitations. Therefore, the manufacturer's recommendations should be used as a reference to clarify any misunderstanding of tachometer markings.

The revolutions per minute are regulated by the throttle, which controls the fuel/air flow to the engine. At a given altitude, the higher the tachometer reading, the higher the power output of the engine.

When operating altitude increases, the tachometer may not show correct power output of the engine. For example, 2,300 r.p.m. at 5,000 feet produce less horsepower than 2,300 r.p.m. at sea level. The reason for this is that power output depends on air density. Air density decreases as altitude increases. Therefore, a decrease in air density (higher density altitude) decreases the power output of the engine. As altitude changes, the position of the throttle must be changed to maintain the same r.p.m. As altitude is increased, the throttle must be opened further to indicate the same r.p.m. as at a lower altitude.

### **ADJUSTABLE-PITCH PROPELLER**

Although some older adjustable-pitch propellers could only be adjusted on the ground, most modern adjustable-pitch propellers are designed so that you can change the propeller pitch in flight. The first adjustable-pitch propeller systems provided only two pitch settings—a low-pitch setting and a high-pitch setting. Today, however, nearly all adjustable-pitch propeller systems are capable of a range of pitch settings.

A constant-speed propeller is the most common type of adjustable-pitch propeller. The main advantage of a constant-speed propeller is that it converts a high percentage of brake horsepower (BHP) into thrust horsepower (THP) over a wide range of r.p.m. and airspeed combinations. A constant-speed propeller is more efficient than other propellers because it allows selection of the most efficient engine r.p.m. for the given conditions.

An airplane with a constant-speed propeller has two controls—the throttle and the propeller control. The throttle controls power output, and the propeller control regulates engine r.p.m. and, in turn, propeller r.p.m., which is registered on the tachometer.

Once a specific r.p.m. is selected, a governor automatically adjusts the propeller blade angle as necessary to maintain the selected r.p.m. For example, after setting the desired r.p.m. during cruising flight, an increase in airspeed or decrease in propeller load will cause the propeller blade angle to increase as necessary to maintain the selected r.p.m. A reduction in airspeed or increase in propeller load will cause the propeller blade angle to decrease.

The range of possible blade angles for a constant-speed propeller is the propeller's constant-speed range and is defined by the high and low pitch stops. As long as the propeller blade angle is within the constant-speed range and not against either pitch stop, a constant engine r.p.m. will be maintained. However, once the propeller blades contact a pitch stop, the engine r.p.m. will increase or decrease as appropriate, with changes in airspeed and propeller load. For example, once a specific r.p.m. has been selected, if aircraft speed decreases enough to rotate the propeller blades until they contact the low pitch stop, any further decrease in airspeed will cause engine r.p.m. to decrease the same way as if a fixed-pitch propeller were installed. The same holds true when an airplane equipped with a constant-speed propeller accelerates to a faster airspeed. As the aircraft accelerates, the propeller blade angle increases to maintain the selected r.p.m. until the high pitch stop is reached. Once this occurs, the blade angle cannot increase any further and engine r.p.m. increases.

On airplanes that are equipped with a constant-speed propeller, power output is controlled by the throttle and indicated by a manifold pressure gauge. The gauge measures the absolute pressure of the fuel/air mixture inside the intake manifold and is more correctly a measure of **manifold absolute pressure (MAP)**. At a constant r.p.m. and altitude, the amount of power produced is directly related to the fuel/air flow being delivered to the combustion chamber. As you increase the throttle setting, more fuel and air is flowing to the engine; therefore, MAP increases. When the engine is not running, the manifold pressure gauge indicates ambient air pressure (i.e., 29.92 in. Hg). When the engine is started, the manifold pressure indication will decrease to a value less than ambient pressure (i.e., idle at 12 in. Hg). Correspondingly, engine failure or power loss is indicated on the manifold gauge as an increase in manifold pressure to a value corresponding to the ambient air pressure at the altitude where the failure occurred. [Figure 5-6]

The manifold pressure gauge is color-coded to indicate the engine's operating range. The face of the manifold pressure gauge contains a green arc to show the normal operating range, and a red radial line to indicate the upper limit of manifold pressure.

For any given r.p.m., there is a manifold pressure that should not be exceeded. If manifold pressure is excessive for a given r.p.m., the pressure within the cylinders could be exceeded, thus placing undue stress on the cylinders. If repeated too frequently, this stress could weaken the cylinder components, and eventually cause engine failure.

**Manifold Absolute Pressure (MAP)**—The absolute pressure of the fuel/air mixture within the intake manifold, usually indicated in inches of mercury.



**Figure 5-6. Engine power output is indicated on the manifold pressure gauge.**

You can avoid conditions that could overstress the cylinders by being constantly aware of the r.p.m., especially when increasing the manifold pressure. Conform to the manufacturer's recommendations for power settings of a particular engine so as to maintain the proper relationship between manifold pressure and r.p.m.

When both manifold pressure and r.p.m. need to be changed, avoid engine overstress by making power adjustments in the proper order:

- When power settings are being decreased, reduce manifold pressure before reducing r.p.m. If r.p.m. is reduced before manifold pressure, manifold pressure will automatically increase and possibly exceed the manufacturer's tolerances.
- When power settings are being increased, reverse the order—increase r.p.m. first, then manifold pressure.
- To prevent damage to radial engines, operating time at maximum r.p.m. and manifold pressure must be held to a minimum, and operation at maximum r.p.m. and low manifold pressure must be avoided.

Under normal operating conditions, the most severe wear, fatigue, and damage to high performance reciprocating engines occurs at high r.p.m. and low manifold pressure.

## **INDUCTION SYSTEMS**

The induction system brings in air from the outside, mixes it with fuel, and delivers the fuel/air mixture to the cylinder where combustion occurs. Outside air enters the induction system through an intake port on the front of the engine cowling. This port normally contains an air filter that inhibits the entry of dust and other foreign objects. Since the filter may occasionally

become clogged, an alternate source of air must be available. Usually, the alternate air comes from inside the engine cowling, where it bypasses a clogged air filter. Some alternate air sources function automatically, while others operate manually.

Two types of induction systems are commonly used in small airplane engines:

1. the carburetor system, which mixes the fuel and air in the carburetor before this mixture enters the intake manifold, and
2. the fuel injection system, which mixes the fuel and air just before entry into each cylinder.

## **CARBURETOR SYSTEMS**

Carburetors are classified as either float-type or pressure-type. Pressure carburetors are usually not found on small airplanes. The basic difference between a pressure carburetor and a float-type is the pressure carburetor delivers fuel under pressure by a fuel pump.

In the operation of the float-type carburetor system, the outside air first flows through an air filter, usually located at an air intake in the front part of the engine cowling. This filtered air flows into the carburetor and through a venturi, a narrow throat in the carburetor. When the air flows through the venturi, a low-pressure area is created, which forces the fuel to flow through a main fuel jet located at the throat. The fuel then flows into the airstream, where it is mixed with the flowing air. See figure 5-7 on page 5-6.

The fuel/air mixture is then drawn through the intake manifold and into the combustion chambers, where it is ignited. The "float-type carburetor" acquires its name from a float, which rests on fuel within the float chamber. A needle attached to the float opens and closes an opening at the bottom of the carburetor bowl. This meters the correct amount of fuel into the carburetor, depending upon the position of the float, which is controlled by the level of fuel in the float chamber. When the level of the fuel forces the float to rise, the needle valve closes the fuel opening and shuts off the fuel flow to the carburetor. The needle valve opens again when the engine requires additional fuel. The flow of the fuel/air mixture to the combustion chambers is regulated by the throttle valve, which is controlled by the throttle in the cockpit.

## **MIXTURE CONTROL**

Carburetors are normally calibrated at sea-level pressure, where the correct fuel-to-air mixture ratio is established with the mixture control set in the FULL RICH position. However, as altitude increases, the density of air entering the carburetor decreases, while the density of the fuel remains the same. This creates a

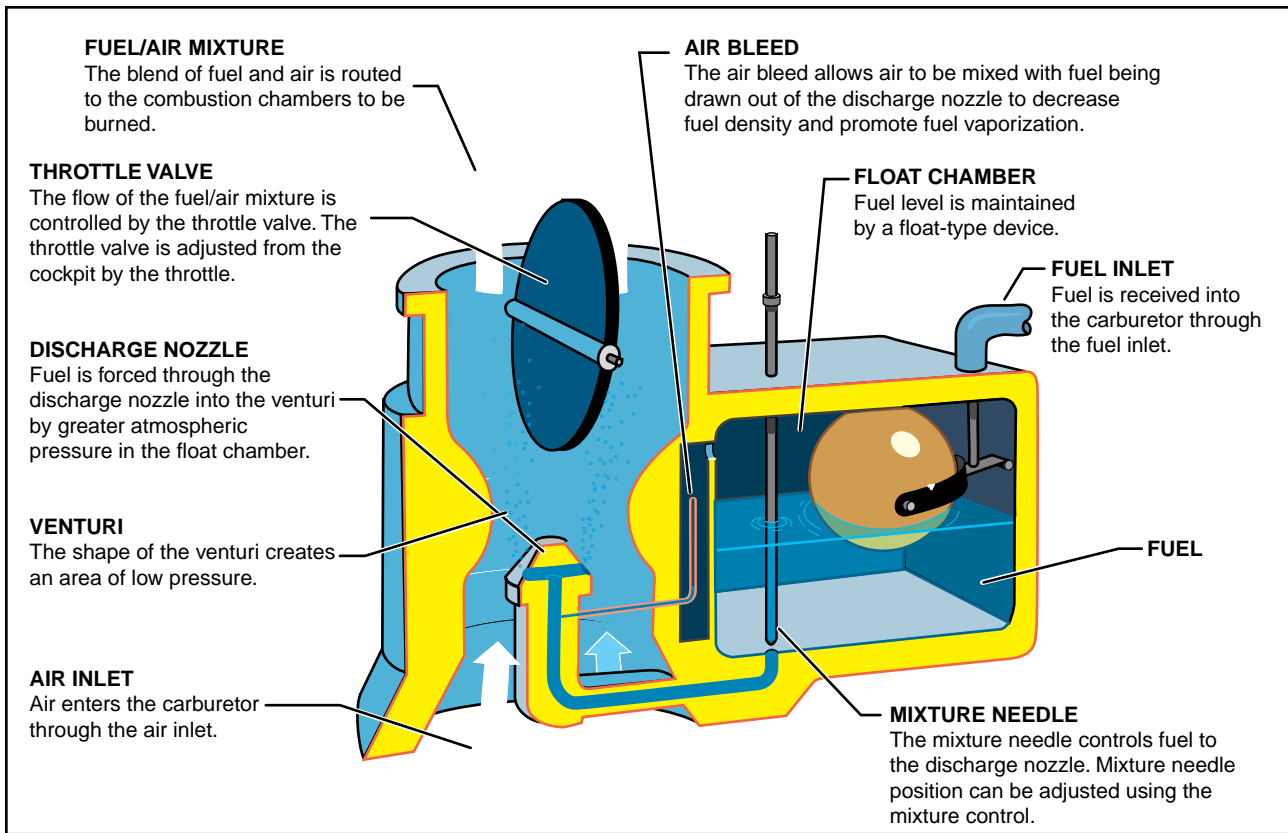

Figure 5-7. Float-type carburetor.

progressively richer mixture, which can result in engine roughness and an appreciable loss of power. The roughness normally is due to spark plug fouling from excessive carbon buildup on the plugs. Carbon buildup occurs because the excessively rich mixture lowers the temperature inside the cylinder, inhibiting complete combustion of the fuel. This condition may occur during the pretakeoff runup at high-elevation airports and during climbs or cruise flight at high altitudes. To maintain the correct fuel/air mixture, you must lean the mixture using the mixture control. Leaning the mixture decreases fuel flow, which compensates for the decreased air density at high altitude.

During a descent from high altitude, the opposite is true. The mixture must be enriched, or it may become too lean. An overly lean mixture causes detonation, which may result in rough engine operation, overheating, and a loss of power. The best way to maintain the proper mixture is to monitor the engine temperature and enrichen the mixture as needed. Proper mixture control and better fuel economy for fuel-injected engines can be achieved by use of an exhaust gas temperature gauge. Since the process of adjusting the mixture can vary from one airplane to another, it is important to refer to the Airplane Flight Manual (AFM) or the Pilot's Operating Handbook (POH) to determine the specific procedures for a given airplane.

#### CARBURETOR ICING

One disadvantage of the float-type carburetor is its icing tendency. Carburetor ice occurs due to the effect of fuel vaporization and the decrease in air pressure in the venturi, which causes a sharp temperature drop in the carburetor. If water vapor in the air condenses when the carburetor temperature is at or below freezing, ice may form on internal surfaces of the carburetor, including the throttle valve. [Figure 5-8]

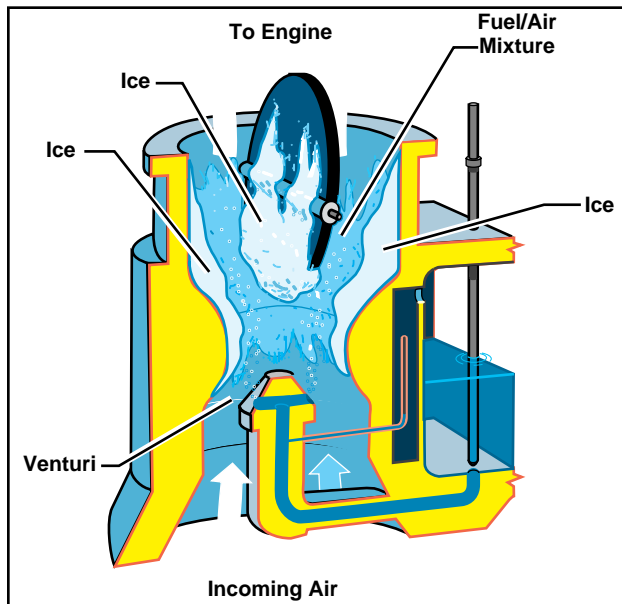
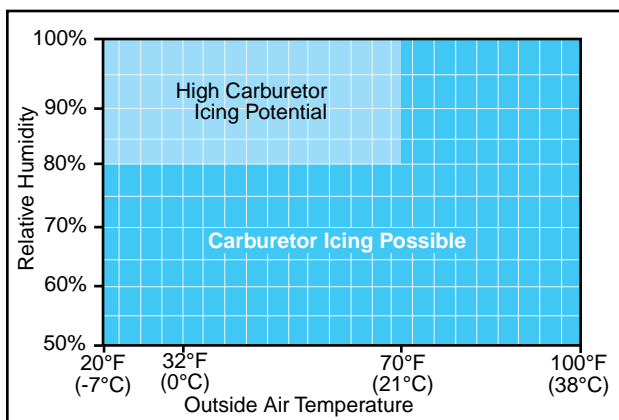

Figure 5-8. The formation of carburetor ice may reduce or block fuel/air flow to the engine.

The reduced air pressure, as well as the vaporization of fuel, contributes to the temperature decrease in the carburetor. Ice generally forms in the vicinity of the throttle valve and in the venturi throat. This restricts the flow of the fuel/air mixture and reduces power. If enough ice builds up, the engine may cease to operate.

Carburetor ice is most likely to occur when temperatures are below 70°F (21°C) and the relative humidity is above 80 percent. However, due to the sudden cooling that takes place in the carburetor, icing can occur even with temperatures as high as 100°F (38°C) and humidity as low as 50 percent. This temperature drop can be as much as 60 to 70°F. Therefore, at an outside air temperature of 100°F, a temperature drop of 70°F results in an air temperature in the carburetor of 30°F. [Figure 5-9]



**Figure 5-9. Although carburetor ice is most likely to form when the temperature and humidity are in ranges indicated by this chart, carburetor ice is possible under conditions not depicted.**

The first indication of carburetor icing in an airplane with a fixed-pitch propeller is a decrease in engine r.p.m., which may be followed by engine roughness. In an airplane with a constant-speed propeller, carburetor icing usually is indicated by a decrease in manifold pressure, but no reduction in r.p.m. Propeller pitch is automatically adjusted to compensate for loss of power. Thus, a constant r.p.m. is maintained. Although carburetor ice can occur during any phase of flight, it is particularly dangerous when using reduced power during a descent. Under certain conditions, carburetor ice could build unnoticed until you try to add power. To combat the effects of carburetor ice, engines with float-type carburetors employ a carburetor heat system.

### **CARBURETOR HEAT**

Carburetor heat is an anti-icing system that preheats the air before it reaches the carburetor. Carburetor heat is intended to keep the fuel/air mixture above the freezing temperature to prevent the formation of carburetor ice. Carburetor heat can be used to melt ice that has already formed in the carburetor provided that the accumulation is not too great. The

emphasis, however, is on using carburetor heat as a preventative measure.

The carburetor heat should be checked during the engine runup. When using carburetor heat, follow the manufacturer's recommendations.

When conditions are conducive to carburetor icing during flight, periodic checks should be made to detect its presence. If detected, full carburetor heat should be applied immediately, and it should be left in the ON position until you are certain that all the ice has been removed. If ice is present, applying partial heat or leaving heat on for an insufficient time might aggravate the situation. In extreme cases of carburetor icing, even after the ice has been removed, full carburetor heat should be used to prevent further ice formation. A carburetor temperature gauge, if installed, is very useful in determining when to use carburetor heat.

Whenever the throttle is closed during flight, the engine cools rapidly and vaporization of the fuel is less complete than if the engine is warm. Also, in this condition, the engine is more susceptible to carburetor icing. Therefore, if you suspect carburetor icing conditions and anticipate closed-throttle operation, adjust the carburetor heat to the full ON position before closing the throttle, and leave it on during the closed-throttle operation. The heat will aid in vaporizing the fuel, and help prevent the formation of carburetor ice. Periodically, open the throttle smoothly for a few seconds to keep the engine warm, otherwise the carburetor heater may not provide enough heat to prevent icing.

The use of carburetor heat causes a decrease in engine power, sometimes up to 15 percent, because the heated air is less dense than the outside air that had been entering the engine. This enriches the mixture. When ice is present in an airplane with a fixed-pitch propeller and carburetor heat is being used, there is a decrease in r.p.m., followed by a gradual increase in r.p.m. as the ice melts. The engine also should run more smoothly after the ice has been removed. If ice is not present, the r.p.m. will decrease, then remain constant. When carburetor heat is used on an airplane with a constant-speed propeller, and ice is present, a decrease in the manifold pressure will be noticed, followed by a gradual increase. If carburetor icing is not present, the gradual increase in manifold pressure will not be apparent until the carburetor heat is turned off.

It is imperative that a pilot recognizes carburetor ice when it forms during flight. In addition, a loss of power, altitude, and/or airspeed will occur. These symptoms may sometimes be accompanied by vibration or engine roughness. Once a power loss is noticed, immediate action should be taken to eliminate

ice already formed in the carburetor, and to prevent further ice formation. This is accomplished by applying full carburetor heat, which will cause a further reduction in power, and possibly engine roughness as melted ice goes through the engine. These symptoms may last from 30 seconds to several minutes, depending on the severity of the icing. During this period, the pilot must resist the temptation to decrease the carburetor heat usage. Carburetor heat must remain in the full-hot position until normal power returns.

Since the use of carburetor heat tends to reduce the output of the engine and also to increase the operating temperature, carburetor heat should not be used when full power is required (as during takeoff) or during normal engine operation, except to check for the presence or to remove carburetor ice.

### CARBURETOR AIR TEMPERATURE GAUGE

Some airplanes are equipped with a carburetor air temperature gauge, which is useful in detecting potential icing conditions. Usually, the face of the gauge is calibrated in degrees Celsius ( $^{\circ}\text{C}$ ), with a yellow arc indicating the carburetor air temperatures where icing may occur. This yellow arc typically ranges between  $-15^{\circ}\text{C}$  and  $+5^{\circ}\text{C}$  ( $5^{\circ}\text{F}$  and  $41^{\circ}\text{F}$ ). If the air temperature and moisture content of the air are such that carburetor icing is improbable, the engine can be operated with the indicator in the yellow range with no adverse effects. However, if the atmospheric conditions are conducive to carburetor icing, the indicator must be kept outside the yellow arc by application of carburetor heat.

Certain carburetor air temperature gauges have a red radial, which indicates the maximum permissible carburetor inlet air temperature recommended by the engine manufacturer; also, a green arc may be included to indicate the normal operating range.

### OUTSIDE AIR TEMPERATURE GAUGE

Most airplanes also are equipped with an outside air temperature (OAT) gauge calibrated in both degrees Celsius and Fahrenheit. It provides the outside or ambient air temperature for calculating true airspeed, and also is useful in detecting potential icing conditions.

### FUEL INJECTION SYSTEMS

In a fuel injection system, the fuel is injected either directly into the cylinders, or just ahead of the intake valve. A fuel injection system is considered to be less susceptible to icing than the carburetor system. Impact icing on the air intake, however, is a possibility in either system. Impact icing occurs when ice forms on the exterior of the airplane, and blocks openings such as the air intake for the injection system.

The air intake for the fuel injection system is similar to that used in the carburetor system, with an alternate air source located within the engine cowling. This source is used if the external air source is obstructed. The alternate air source is usually operated automatically, with a backup manual system that can be used if the automatic feature malfunctions.

A fuel injection system usually incorporates these basic components—an engine-driven fuel pump, a fuel/air control unit, fuel manifold (fuel distributor), discharge nozzles, an auxiliary fuel pump, and fuel pressure/flow indicators. [Figure 5-10]

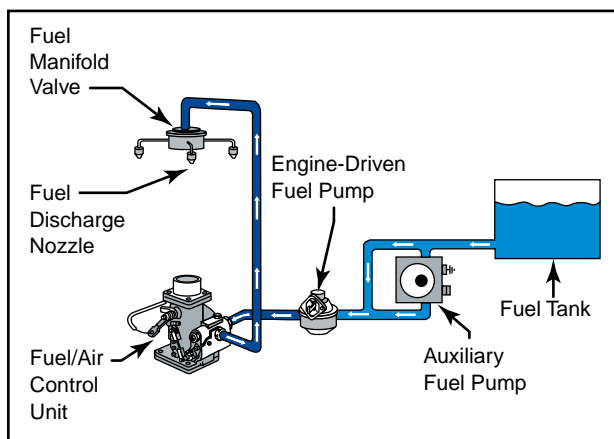

Figure 5-10. Fuel injection system.

The auxiliary fuel pump provides fuel under pressure to the fuel/air control unit for engine starting and/or emergency use. After starting, the engine-driven fuel pump provides fuel under pressure from the fuel tank to the fuel/air control unit. This control unit, which essentially replaces the carburetor, meters fuel based on the mixture control setting, and sends it to the fuel manifold valve at a rate controlled by the throttle. After reaching the fuel manifold valve, the fuel is distributed to the individual fuel discharge nozzles. The discharge nozzles, which are located in each cylinder head, inject the fuel/air mixture directly into each cylinder intake port.

Some of the advantages of fuel injection are:

- Reduction in evaporative icing.
- Better fuel flow.
- Faster throttle response.
- Precise control of mixture.
- Better fuel distribution.
- Easier cold weather starts.

Disadvantages usually include:

- Difficulty in starting a hot engine.
- Vapor locks during ground operations on hot days.
- Problems associated with restarting an engine that quits because of fuel starvation.

## **SUPERCHARGERS AND TURBOSUPERCHARGERS**

To increase an engine's horsepower, manufacturers have developed supercharger and turbosupercharger systems that compress the intake air to increase its density. Airplanes with these systems have a manifold pressure gauge, which displays manifold absolute pressure (MAP) within the engine's intake manifold.

On a standard day at sea level with the engine shut down, the manifold pressure gauge will indicate the ambient absolute air pressure of 29.92 in. Hg. Because atmospheric pressure decreases approximately 1 in. Hg per 1,000 feet of altitude increase, the manifold pressure gauge will indicate approximately 24.92 in. Hg at an airport that is 5,000 feet above sea level with standard day conditions.

As a normally aspirated aircraft climbs, it eventually reaches an altitude where the MAP is insufficient for a normal climb. That altitude limit is the aircraft's **service ceiling**, and it is directly affected by the engine's ability to produce power. If the induction air entering the engine is pressurized, or boosted, by either a supercharger or a turbosupercharger, the aircraft's service ceiling can be increased. With these systems, you can fly at higher altitudes with the advantage of higher true airspeeds and the increased ability to circumnavigate adverse weather.

### **SUPERCHARGERS**

A **supercharger** is an engine-driven air pump or compressor that increases manifold pressure and forces the fuel/air mixture into the cylinders. The higher the manifold pressure, the more dense the fuel/air mixture, and the more power an engine can produce. With a normally aspirated engine, it is not possible to have manifold pressure higher than the existing atmospheric pressure. A supercharger is capable of boosting manifold pressure above 30 in. Hg.

**Service Ceiling**—The maximum density altitude where the best rate-of-climb airspeed will produce a 100 feet-per-minute climb at maximum weight while in a clean configuration with maximum continuous power.

**Supercharger**—An engine-driven air compressor used to provide additional pressure to the induction air so the engine can produce additional power.

The components in a supercharged induction system are similar to those in a normally aspirated system, with the addition of a supercharger between the fuel metering device and intake manifold. A supercharger is driven by the engine through a gear train at one speed, two speeds, or variable speeds. In addition, superchargers can have one or more stages. Each stage provides an increase in pressure. Therefore, superchargers may be classified as single stage, two stage, or multistage, depending on the number of times compression occurs.

An early version of a single-stage, single-speed supercharger may be referred to as a sea-level supercharger. An engine equipped with this type of supercharger is called a **sea-level engine**. With this type of supercharger, a single gear-driven impeller is used to increase the power produced by an engine at all altitudes. The drawback, however, is that with this type of supercharger, engine power output still decreases with an increase in altitude, in the same way that it does with a normally aspirated engine.

Single-stage, single-speed superchargers are found on many high-powered radial engines, and use an air intake that faces forward so the induction system can take full advantage of the ram air. Intake air passes through ducts to a carburetor, where fuel is metered in proportion to the airflow. The fuel/air charge is then ducted to the supercharger, or blower impeller, which accelerates the fuel/air mixture outward. Once accelerated, the fuel/air mixture passes through a diffuser, where air velocity is traded for pressure energy. After compression, the resulting high pressure fuel/air mixture is directed to the cylinders.

Some of the large radial engines developed during World War II have a single-stage, two-speed supercharger. With this type of supercharger, a single impeller may be operated at two speeds. The low impeller speed is often referred to as the low blower setting, while the high impeller speed is called the high blower setting. On engines equipped with a two-speed supercharger, a lever or switch in the cockpit activates an oil-operated clutch that switches from one speed to the other.

Under normal operations, takeoff is made with the supercharger in the low blower position. In this mode, the engine performs as a ground-boosted engine, and the power output decreases as the aircraft gains altitude. However, once the aircraft reaches a specified altitude, a power reduction is made, and the supercharger control is switched to the high blower position. The throttle is then reset to the desired

**Sea-Level Engine**—A reciprocating aircraft engine having a rated takeoff power that is producible only at sea level.

manifold pressure. An engine equipped with this type of supercharger is called an **altitude engine**. [Figure 5-11]

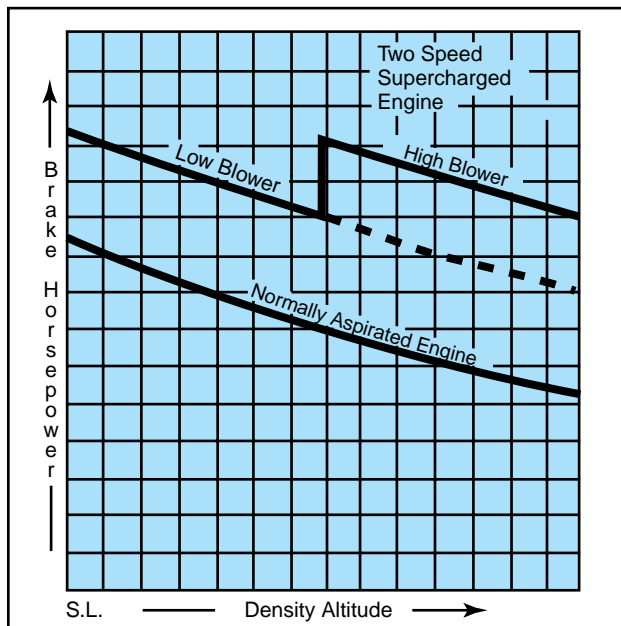

**Figure 5-11. Power output of normally aspirated engine compared to a single-stage, two-speed supercharged engine.**

### TURBOSUPERCHARGERS

The most efficient method of increasing horsepower in a reciprocating engine is by use of a turbosupercharger, or **turbocharger**, as it is usually called. A drawback of gear-driven superchargers is that they use a large amount of the engine's power output for the amount of power increase they produce. This problem is avoided with a turbocharger, because turbochargers are powered by an engine's exhaust gases. This means a turbocharger recovers energy from hot exhaust gases that would otherwise be lost.

Another advantage of turbochargers is that they can be controlled to maintain an engine's rated sea-level horsepower from sea level up to the engine's critical altitude. Critical altitude is the maximum altitude at which a turbocharged engine can produce its rated horsepower. Above the critical altitude, power output begins to decrease like it does for a normally aspirated engine.

Turbochargers increase the pressure of the engine's induction air, which allows the engine to develop sea level or greater horsepower at higher altitudes. A turbocharger is comprised of two main elements—a

**Altitude Engine**—A reciprocating aircraft engine having a rated takeoff power that is producible from sea level to an established higher altitude.

**Turbocharger**—An air compressor driven by exhaust gases, which increases the pressure of the air going into the engine through the carburetor or fuel injection system.

turbine and a compressor. The compressor section houses an impeller that turns at a high rate of speed. As induction air is drawn across the impeller blades, the impeller accelerates the air, allowing a large volume of air to be drawn into the compressor housing. The impeller's action subsequently produces high-pressure, high-density air, which is delivered to the engine. To turn the impeller, the engine's exhaust gases are used to drive a turbine wheel that is mounted on the opposite end of the impeller's drive shaft. By directing different amounts of exhaust gases to flow over the turbine, more energy can be extracted, causing the impeller to deliver more compressed air to the engine. The **waste gate** is used to vary the mass of exhaust gas flowing into the turbine. A waste gate is essentially an adjustable butterfly valve that is installed in the exhaust system. When closed, most of the exhaust gases from the engine are forced to flow through the turbine. When open, the exhaust gases are allowed to bypass the turbine by flowing directly out through the engine's exhaust pipe. [Figure 5-12]

Since the temperature of a gas rises when it is compressed, turbocharging causes the temperature of the induction air to increase. To reduce this temperature and lower the risk of detonation, many turbocharged engines use an intercooler. An **intercooler** is a small heat exchanger that uses outside air to cool the hot compressed air before it enters the fuel metering device.

### SYSTEM OPERATION

On most modern turbocharged engines, the position of the waste gate is governed by a pressure-sensing control mechanism coupled to an actuator. Engine oil directed into or away from this actuator moves the waste gate position. On these systems, the actuator is automatically positioned to produce the desired MAP simply by changing the position of the throttle control.

Other turbocharging system designs use a separate manual control to position the waste gate. With manual control, you must closely monitor the manifold pressure gauge to determine when the desired MAP has been achieved. Manual systems are often found on aircraft that have been modified with aftermarket turbocharging systems. These systems require special operating considerations. For example, if the waste gate is left closed after descending from a high altitude, it is possible to produce a manifold pressure that exceeds the engine's limitations. This condition is

**Waste Gate**—A controllable valve in the exhaust system of a reciprocating engine equipped with a turbocharger. The valve is controlled to vary the amount of exhaust gases forced through the turbocharger turbine.

**Intercooler**—A device used to remove heat from air or liquid.

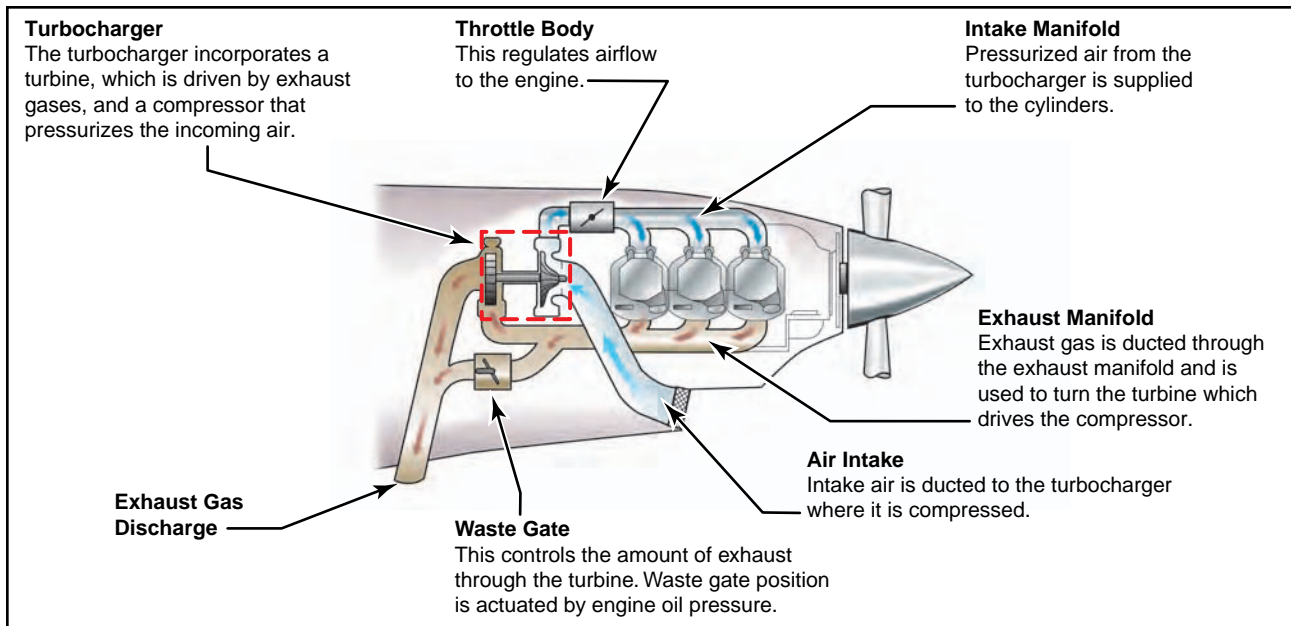

Figure 5-12. Turbocharger components.

referred to as an **overboost**, and it may produce severe detonation because of the leaning effect resulting from increased air density during descent.

Although an automatic waste gate system is less likely to experience an overboost condition, it can still occur. If you try to apply takeoff power while the engine oil temperature is below its normal operating range, the cold oil may not flow out of the waste gate actuator quickly enough to prevent an overboost. To help prevent overboosting, you should advance the throttle cautiously to prevent exceeding the maximum manifold pressure limits.

There are system limitations that you should be aware of when flying an aircraft with a turbocharger. For instance, a turbocharger turbine and impeller can operate at rotational speeds in excess of 80,000 r.p.m. while at extremely high temperatures. To achieve high rotational speed, the bearings within the system must be constantly supplied with engine oil to reduce the frictional forces and high temperature. To obtain adequate lubrication, the oil temperature should be in the normal operating range before high throttle settings are applied. In addition, you should allow the turbocharger to cool and the turbine to slow down before shutting the engine down. Otherwise, the oil remaining in the bearing housing will boil, causing hard carbon deposits to form on the bearings and shaft. These deposits rapidly deteriorate the turbocharger's efficiency and service life. For further limitations, refer to the AFM/POH.

### HIGH ALTITUDE PERFORMANCE

As an aircraft equipped with a turbocharging system climbs, the waste gate is gradually closed to maintain the maximum allowable manifold pressure. At some point, however, the waste gate will be fully closed, and with further increases in altitude, the manifold pressure will begin to decrease. This is the critical altitude, which is established by the airplane or engine manufacturer. When evaluating the performance of the turbocharging system, if the manifold pressure begins decreasing before the specified critical altitude, the engine and turbocharging system should be inspected by a qualified aviation maintenance technician to verify the system's proper operation.

### IGNITION SYSTEM

The ignition system provides the spark that ignites the fuel/air mixture in the cylinders and is made up of magnetos, spark plugs, high-tension leads, and the ignition switch. [Figure 5-13]

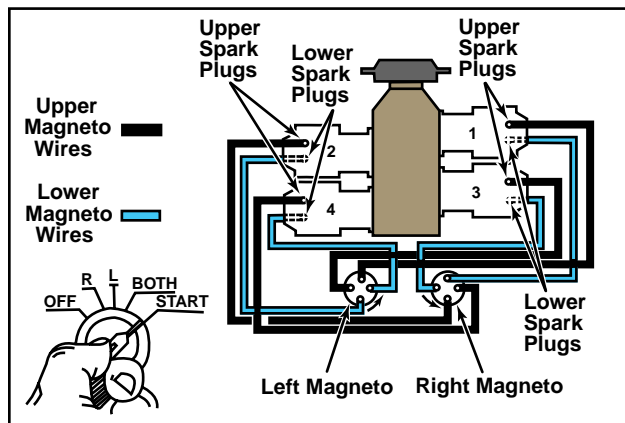

Figure 5-13. Ignition system components.

**Overboost**—A condition in which a reciprocating engine has exceeded the maximum manifold pressure allowed by the manufacturer.



A **magneto** uses a permanent magnet to generate an electrical current completely independent of the aircraft's electrical system. The magneto generates sufficiently high voltage to jump a spark across the spark plug gap in each cylinder. The system begins to fire when you engage the starter and the crankshaft begins to turn. It continues to operate whenever the crankshaft is rotating.

Most standard certificated airplanes incorporate a dual ignition system with two individual magnetos, separate sets of wires, and spark plugs to increase reliability of the ignition system. Each magneto operates independently to fire one of the two spark plugs in each cylinder. The firing of two spark plugs improves combustion of the fuel/air mixture and results in a slightly higher power output. If one of the magnetos fails, the other is unaffected. The engine will continue to operate normally, although you can expect a slight decrease in engine power. The same is true if one of the two spark plugs in a cylinder fails.

The operation of the magneto is controlled in the cockpit by the ignition switch. The switch has five positions:

1. OFF
2. R—Right
3. L—Left
4. BOTH
5. START

With RIGHT or LEFT selected, only the associated magneto is activated. The system operates on both magnetos with BOTH selected.

You can identify a malfunctioning ignition system during the pretakeoff check by observing the decrease in r.p.m. that occurs when you first move the ignition switch from BOTH to RIGHT, and then from BOTH to LEFT. A small decrease in engine r.p.m. is normal during this check. The permissible decrease is listed in the AFM or POH. If the engine stops running when you switch to one magneto or if the r.p.m. drop exceeds the allowable limit, do not fly the airplane until the problem is corrected. The cause could be fouled plugs, broken or shorted wires between the magneto and the plugs, or improperly timed firing of the plugs. It should be noted that “no drop” in r.p.m. is not normal, and in that instance, the airplane should not be flown.

**Magneto**—A self-contained, engine-driven unit that supplies electrical current to the spark plugs; completely independent of the airplane's electrical system. Normally, there are two magnetos per engine.

Following engine shutdown, turn the ignition switch to the OFF position. Even with the battery and master switches OFF, the engine can fire and turn over if you leave the ignition switch ON and the propeller is moved because the magneto requires no outside source of electrical power. The potential for serious injury in this situation is obvious.

Loose or broken wires in the ignition system also can cause problems. For example, if the ignition switch is OFF, the magneto may continue to fire if the ignition switch ground wire is disconnected. If this occurs, the only way to stop the engine is to move the mixture lever to the idle cutoff position, then have the system checked by a qualified aviation maintenance technician.

## COMBUSTION

During normal combustion, the fuel/air mixture burns in a very controlled and predictable manner. Although the process occurs in a fraction of a second, the mixture actually begins to burn at the point where it is ignited by the spark plugs, then burns away from the plugs until it is all consumed. This type of combustion causes a smooth buildup of temperature and pressure and ensures that the expanding gases deliver the maximum force to the piston at exactly the right time in the power stroke. [Figure 5-14]

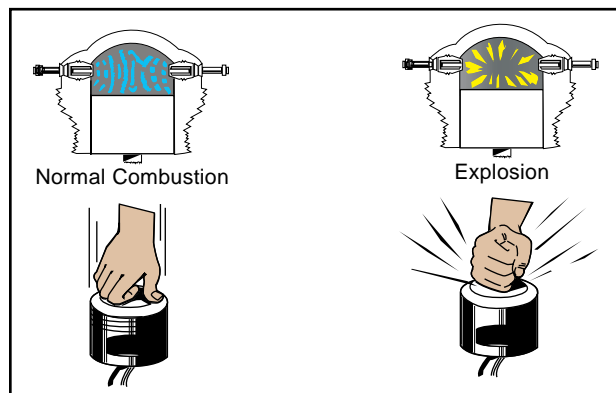

Figure 5-14. Normal combustion and explosive combustion.

**Detonation** is an uncontrolled, explosive ignition of the fuel/air mixture within the cylinder's combustion chamber. It causes excessive temperatures and pressures which, if not corrected, can quickly lead to failure of the piston, cylinder, or valves. In less severe cases, detonation causes engine overheating, roughness, or loss of power.

Detonation is characterized by high cylinder head temperatures, and is most likely to occur when operating at high power settings. Some common operational causes of detonation include:

**Detonation**—An uncontrolled, explosive ignition of the fuel/air mixture within the cylinder's combustion chamber.

- Using a lower fuel grade than that specified by the aircraft manufacturer.
- Operating with extremely high manifold pressures in conjunction with low r.p.m.
- Operating the engine at high power settings with an excessively lean mixture.
- Detonation also can be caused by extended ground operations, or steep climbs where cylinder cooling is reduced.

Detonation may be avoided by following these basic guidelines during the various phases of ground and flight operations:

- Make sure the proper grade of fuel is being used.
- While on the ground, keep the cowl flaps (if available) in the full-open position to provide the maximum airflow through the cowling.
- During takeoff and initial climb, the onset of detonation can be reduced by using an enriched fuel mixture, as well as using a shallower climb angle to increase cylinder cooling.
- Avoid extended, high power, steep climbs.
- Develop a habit of monitoring the engine instruments to verify proper operation according to procedures established by the manufacturer.

**Preignition** occurs when the fuel/air mixture ignites prior to the engine's normal ignition event. Premature burning is usually caused by a residual hot spot in the combustion chamber, often created by a small carbon deposit on a spark plug, a cracked spark plug insulator, or other damage in the cylinder that causes a part to heat sufficiently to ignite the fuel/air charge. Preignition causes the engine to lose power, and produces high operating temperature. As with detonation, preignition may also cause severe engine damage, because the expanding gases exert excessive pressure on the piston while still on its compression stroke.

Detonation and preignition often occur simultaneously and one may cause the other. Since either condition causes high engine temperature accompanied by a decrease in engine performance, it is often difficult to distinguish between the two. Using the recommended grade of fuel and operating the engine within its proper temperature, pressure, and r.p.m. ranges reduce the chance of detonation or preignition.

**Preignition**—The uncontrolled combustion of the fuel/air mixture in advance of the normal ignition.

## FUEL SYSTEMS

The fuel system is designed to provide an uninterrupted flow of clean fuel from the fuel tanks to the engine. The fuel must be available to the engine under all conditions of engine power, altitude, attitude, and during all approved flight maneuvers. Two common classifications apply to fuel systems in small airplanes—gravity-feed and fuel-pump systems.

The gravity-feed system utilizes the force of gravity to transfer the fuel from the tanks to the engine—for example, on high-wing airplanes where the fuel tanks are installed in the wings. This places the fuel tanks above the carburetor, and the fuel is gravity fed through the system and into the carburetor. If the design of the airplane is such that gravity cannot be used to transfer fuel, fuel pumps are installed—for example, on low-wing airplanes where the fuel tanks in the wings are located below the carburetor. [Figure 5-15]

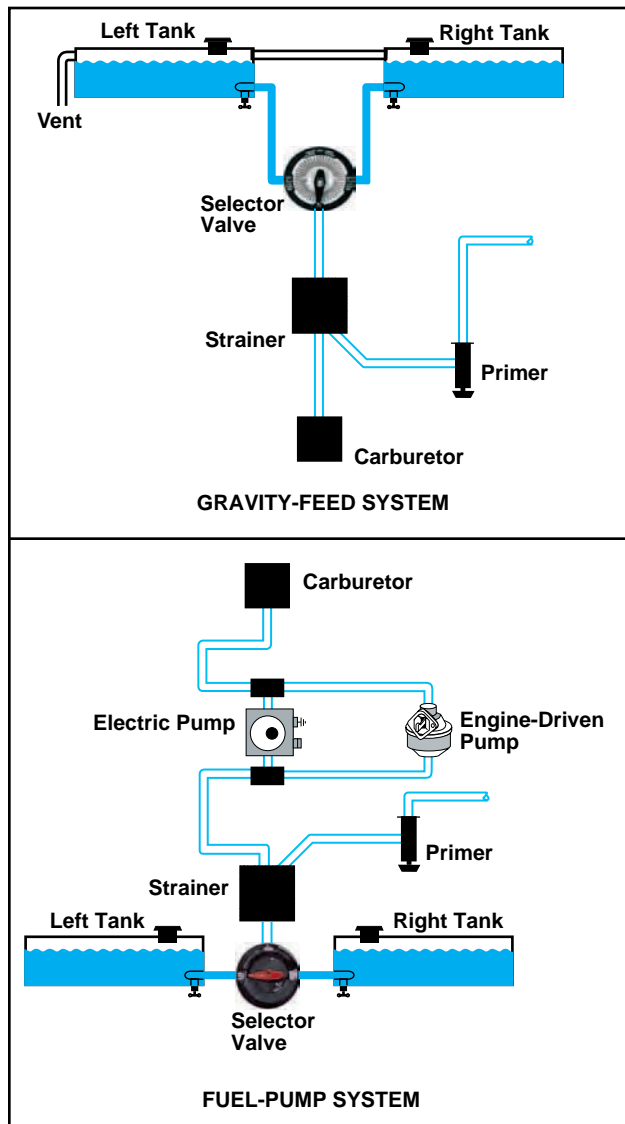

Figure 5-15. Gravity-feed and fuel-pump systems.

## FUEL PUMPS

Airplanes with fuel pump systems have two fuel pumps. The main pump system is engine driven, and an electrically driven auxiliary pump is provided for use in engine starting and in the event the engine pump fails. The auxiliary pump, also known as a boost pump, provides added reliability to the fuel system. The electrically driven auxiliary pump is controlled by a switch in the cockpit.

## FUEL PRIMER

Both gravity fed and pump systems may incorporate a fuel primer into the system. The primer is used to draw fuel from the tanks to vaporize it directly into the cylinders prior to starting the engine. This is particularly helpful during cold weather, when engines are hard to start because there is not enough heat available to vaporize the fuel in the carburetor. It is important to lock the primer in place when it is not in use. If the knob is free to move, it may vibrate out during flight and can cause an excessively rich mixture. To avoid overpriming, read the priming instructions for your airplane.

## FUEL TANKS

The fuel tanks, normally located inside the wings of an airplane, have a filler opening on top of the wing through which they can be filled. A filler cap covers this opening. The tanks are vented to the outside to maintain atmospheric pressure inside the tank. They may be vented through the filler cap or through a tube extending through the surface of the wing. Fuel tanks also include an overflow drain that may stand alone or be collocated with the fuel tank vent. This allows fuel to expand with increases in temperature without damage to the tank itself. If the tanks have been filled on a hot day, it is not unusual to see fuel coming from the overflow drain.

## FUEL GAUGES

The fuel quantity gauges indicate the amount of fuel measured by a sensing unit in each fuel tank and is displayed in gallons or pounds. Aircraft certification rules only require accuracy in fuel gauges when they read “empty.” Any reading other than “empty” should be verified. Do not depend solely on the accuracy of the fuel quantity gauges. Always visually check the fuel level in each tank during the preflight inspection, and then compare it with the corresponding fuel quantity indication.

If a fuel pump is installed in the fuel system, a fuel pressure gauge is also included. This gauge indicates the pressure in the fuel lines. The normal operating pressure can be found in the AFM/POH, or on the gauge by color coding.

## FUEL SELECTORS

The fuel selector valve allows selection of fuel from various tanks. A common type of selector valve contains four positions: LEFT, RIGHT, BOTH, and OFF. Selecting the LEFT or RIGHT position allows fuel to feed only from that tank, while selecting the BOTH position feeds fuel from both tanks. The LEFT or RIGHT position may be used to balance the amount of fuel remaining in each wing tank. [Figure 5-16]



Figure 5-16. Fuel selector valve.

Fuel placards will show any limitations on fuel tank usage, such as “level flight only” and/or “both” for landings and takeoffs.

Regardless of the type of fuel selector in use, fuel consumption should be monitored closely to ensure that a tank does not run completely out of fuel. Running a fuel tank dry will not only cause the engine to stop, but running for prolonged periods on one tank causes an unbalanced fuel load between tanks. Running a tank completely dry may allow air to enter the fuel system, which may cause vapor lock. When this situation develops, it may be difficult to restart the engine. On fuel-injected engines, the fuel may become so hot it vaporizes in the fuel line, not allowing fuel to reach the cylinders.

## FUEL STRAINERS, SUMPS, AND DRAINS

After the fuel selector valve, the fuel passes through a strainer before it enters the carburetor. This strainer removes moisture and other sediments that might be in the system. Since these contaminants are heavier than aviation fuel, they settle in a sump at the bottom of the strainer assembly. A sump is defined as a low point in a fuel system and/or fuel tank. The fuel system may contain sump, fuel strainer, and fuel tank drains, some of which may be collocated.

The fuel strainer should be drained before each flight. Fuel samples should be drained and checked visually

for water and contaminants. Water in the sump is hazardous because in cold weather the water can freeze and block fuel lines. In warm weather, it can flow into the carburetor and stop the engine. If water is present in the sump, it is likely there is more water in the fuel tanks, and you should continue to drain them until there is no evidence of water. In any event, never take off until you are certain that all water and contaminants have been removed from the engine fuel system.

Because of the variation in fuel systems, you should become thoroughly familiar with the systems that apply to your airplane. Consult the AFM or POH for specific operating procedures.

### FUEL GRADES

Aviation gasoline, or AVGAS, is identified by an octane or performance number (grade), which designates the antiknock value or knock resistance of the fuel mixture in the engine cylinder. The higher the grade of gasoline, the more pressure the fuel can withstand without detonating. Lower grades of fuel are used in lower-compression engines because these fuels ignite at a lower temperature. Higher grades are used in higher-compression engines, because they must ignite at higher temperatures, but not prematurely. If the proper grade of fuel is not available, use the next higher grade as a substitute. Never use a lower grade. This can cause the cylinder head temperature and engine oil temperature to exceed their normal operating range, which may result in detonation.

Several grades of aviation fuel are available. Care must be exercised to ensure that the correct aviation grade is being used for the specific type of engine. The proper fuel grade is stated in the AFM or POH, on placards in the cockpit, and next to the filler caps. Due to its lead content, auto gas should NEVER be used in aircraft engines unless the aircraft has been modified with a Supplemental Type Certificate (STC) issued by the Federal Aviation Administration.

The current method to identify aviation gasoline for aircraft with reciprocating engines is by the octane and performance number, along with the abbreviation AVGAS. These aircraft use AVGAS 80, 100, and 100LL. Although AVGAS 100LL performs the same as grade 100, the “LL” indicates it has a low lead content. Fuel for aircraft with turbine engines is classified as JET A, JET A-1, and JET B. Jet fuel is basically kerosene and has a distinctive kerosene smell.

Since use of the correct fuel is critical, dyes are added to help identify the type and grade of fuel. [Figure 5-17]





FUEL TYPE AND GRADE	COLOR OF FUEL	EQUIPMENT COLOR
AVGAS 80	RED	
AVGAS 100	GREEN	
AVGAS 100LL	BLUE	
JET A	COLORLESS OR STRAW	

Figure 5-17. Aviation fuel color-coding system.

In addition to the color of the fuel itself, the color-coding system extends to decals and various airport fuel handling equipment. For example, all aviation gasolines are identified by name, using white letters on a red background. In contrast, turbine fuels are identified by white letters on a black background.

### FUEL CONTAMINATION

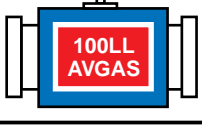
Of the accidents attributed to powerplant failure from fuel contamination, most have been traced to:

- Inadequate preflight inspection by the pilot.
- Servicing aircraft with improperly filtered fuel from small tanks or drums.
- Storing aircraft with partially filled fuel tanks.
- Lack of proper maintenance.

Fuel should be drained from the fuel strainer quick drain and from each fuel tank sump into a transparent container, and then checked for dirt and water. When the fuel strainer is being drained, water in the tank may not appear until all the fuel has been drained from the lines leading to the tank. This indicates that water remains in the tank, and is not forcing the fuel out of the fuel lines leading to the fuel strainer. Therefore, drain enough fuel from the fuel strainer to be certain that fuel is being drained from the tank. The amount will depend on the length of fuel line from the tank to the drain. If water or other contaminants are found in the first sample, drain further samples until no trace appears.

Water may also remain in the fuel tanks after the drainage from the fuel strainer had ceased to show any trace of water. This residual water can be removed only by draining the fuel tank sump drains.

Water is the principal fuel contaminant. Suspended water droplets in the fuel can be identified by a cloudy appearance of the fuel or by the clear separation of water from the colored fuel, which occurs after the water has settled to the bottom of the tank. As a safety measure, the fuel sumps should be drained before every flight during the preflight inspection.

Fuel tanks should be filled after each flight, or at least after the last flight of the day to prevent moisture condensation within the tank. Another way to prevent fuel contamination is to avoid refueling from cans and drums. Refueling from cans or drums may result in fuel contamination.

The use of a funnel and chamois skin when refueling from cans or drums is hazardous under any conditions, and should be discouraged. In remote areas or in emergency situations, there may be no alternative to refueling from sources with inadequate anticontamination systems, and a chamois and funnel may be the only possible means of filtering fuel. However, the use of a chamois will not always ensure decontaminated fuel. Worn-out chamois will not filter water; neither will a new, clean chamois that is already water-wet or damp. Most imitation chamois skins will not filter water.

### **REFUELING PROCEDURES**

Static electricity is formed by the friction of air passing over the surfaces of an airplane in flight and by the flow of fuel through the hose and nozzle during refueling. Nylon, dacron, or wool clothing is especially prone to accumulate and discharge static electricity from the person to the funnel or nozzle. To guard against the possibility of static electricity igniting fuel fumes, a ground wire should be attached to the aircraft before the fuel cap is removed from the tank. The refueling nozzle then should be grounded to the aircraft before refueling is begun, and should remain grounded throughout the refueling process. When a fuel truck is used, it should be grounded prior to the fuel nozzle contacting the aircraft.

If fueling from drums or cans is necessary, proper bonding and grounding connections are important. Drums should be placed near grounding posts, and the following sequence of connections observed:

1. Drum to ground.
2. Ground to aircraft.
3. Drum to aircraft.

4. Nozzle to aircraft before the fuel cap is removed.

When disconnecting, reverse the order.

The passage of fuel through a chamois increases the charge of static electricity and the danger of sparks. The aircraft must be properly grounded and the nozzle, chamois filter, and funnel bonded to the aircraft. If a can is used, it should be connected to either the grounding post or the funnel. Under no circumstances should a plastic bucket or similar nonconductive container be used in this operation.

### **STARTING SYSTEM**

Most small aircraft use a direct-cranking electric starter system. This system consists of a source of electricity, wiring, switches, and solenoids to operate the starter and a starter motor. Most aircraft have starters that automatically engage and disengage when operated, but some older aircraft have starters that are mechanically engaged by a lever actuated by the pilot. The starter engages the aircraft flywheel, rotating the engine at a speed that allows the engine to start and maintain operation.

Electrical power for starting is usually supplied by an on-board battery, but can also be supplied by external power through an external power receptacle. When the battery switch is turned on, electricity is supplied to the main power bus through the battery solenoid. Both the starter and the starter switch draw current from the main bus, but the starter will not operate until the starting solenoid is energized by the starter switch being turned to the "start" position. When the starter switch is released from the "start" position, the solenoid removes power from the starter motor. The starter motor is protected from being driven by the engine through a clutch in the starter drive that allows the engine to run faster than the starter motor. [Figure 5-18]

When starting an engine, the rules of safety and courtesy should be strictly observed. One of the most important is to make sure there is no one near the propeller. In addition, the wheels should be chocked and the brakes set, to avoid hazards caused by unintentional movement. To avoid damage to the propeller and property, the airplane should be in an area where the propeller will not stir up gravel or dust.

### **OIL SYSTEMS**

The engine oil system performs several important functions, including:

- Lubrication of the engine's moving parts.
- Cooling of the engine by reducing friction.
- Removing heat from the cylinders.

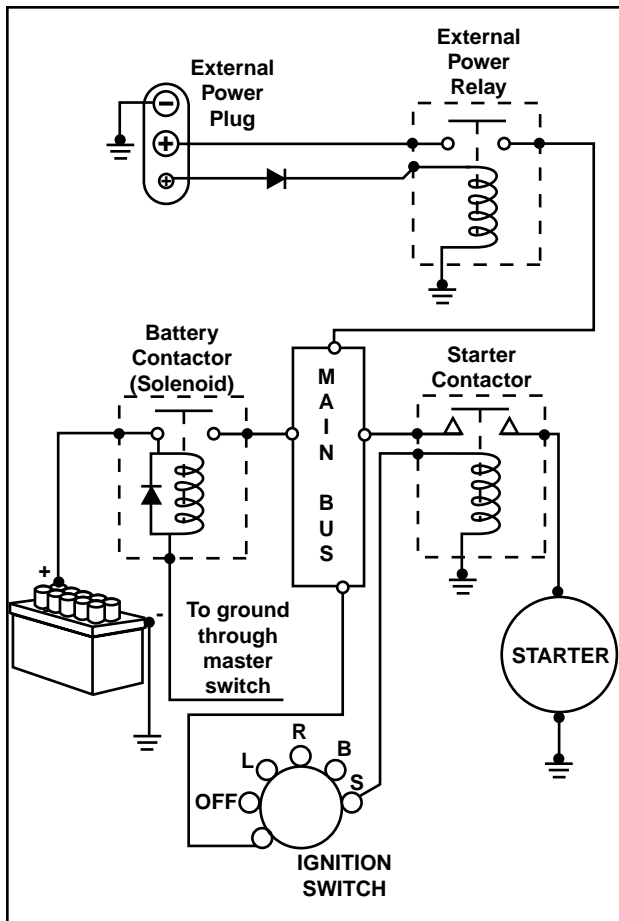

Figure 5-18. Typical starting circuit.

- Providing a seal between the cylinder walls and pistons.
- Carrying away contaminants.

Reciprocating engines use either a wet-sump or dry-sump oil system. In a dry-sump system, the oil is contained in a separate tank, and circulated through the engine by pumps. In a wet-sump system, the oil is located in a sump, which is an integral part of the engine. [Figure 5-19]

The main component of a wet-sump system is the oil pump, which draws oil from the sump and routes it to the engine. After the oil passes through the engine, it returns to the sump. In some engines, additional lubrication is supplied by the rotating crankshaft, which splashes oil onto portions of the engine.

An oil pump also supplies oil pressure in a dry-sump system, but the source of the oil is a separate oil tank, located external to the engine. After oil is routed through the engine, it is pumped from the various locations in the engine back to the oil tank by scavenge pumps. Dry sump systems allow for a greater volume of oil to be supplied to the engine, which makes them more suitable for very large reciprocating engines.

The oil pressure gauge provides a direct indication of the oil system operation. It measures the pressure in

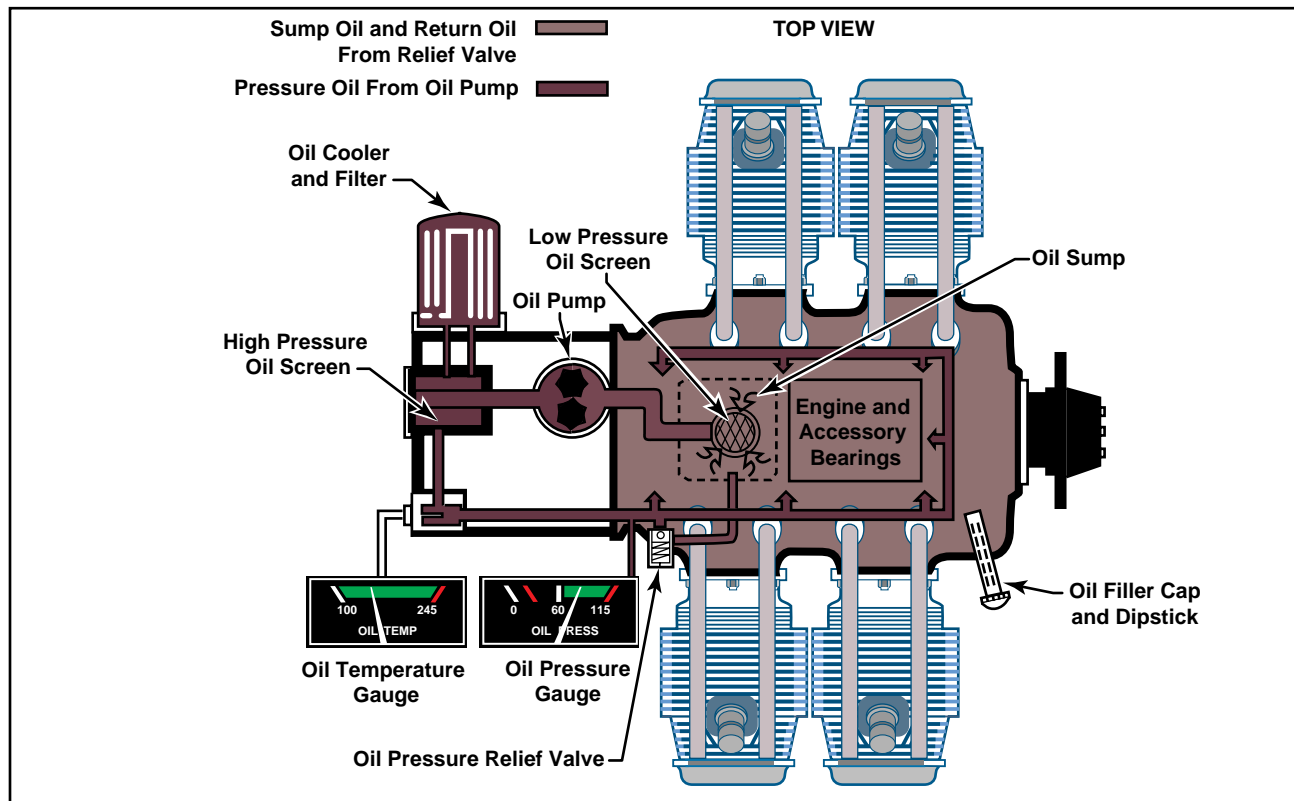

Figure 5-19. Wet-sump oil system.

pounds per square inch (p.s.i.) of the oil supplied to the engine. Green indicates the normal operating range, while red indicates the minimum and maximum pressures. There should be an indication of oil pressure during engine start. Refer to the AFM/POH for manufacturer limitations.

The oil temperature gauge measures the temperature of oil. A green area shows the normal operating range and the red line indicates the maximum allowable temperature. Unlike oil pressure, changes in oil temperature occur more slowly. This is particularly noticeable after starting a cold engine, when it may take several minutes or longer for the gauge to show any increase in oil temperature.

Check oil temperature periodically during flight especially when operating in high or low ambient air temperature. High temperature indications may indicate a plugged oil line, a low oil quantity, a blocked oil cooler, or a defective temperature gauge. Low temperature indications may indicate improper oil viscosity during cold weather operations.

The oil filler cap and dipstick (for measuring the oil quantity) are usually accessible through a panel in the engine cowling. If the quantity does not meet the manufacturer's recommended operating levels, oil should be added. The AFM, POH, or placards near the access panel provide information about the correct oil type and weight, as well as the minimum and maximum oil quantity. [Figure 5-20]



Figure 5-20. Always check the engine oil level during the pre-flight inspection.

## ENGINE COOLING SYSTEMS

The burning fuel within the cylinders produces intense heat, most of which is expelled through the exhaust system. Much of the remaining heat, however, must be removed, or at least dissipated, to prevent the engine from overheating. Otherwise, the extremely high engine temperatures can lead to loss of power, excessive oil consumption, detonation, and serious engine damage.

While the oil system is vital to internal cooling of the engine, an additional method of cooling is necessary for the engine's external surface. Most small airplanes are air cooled, although some are liquid cooled.

Air cooling is accomplished by air flowing into the engine compartment through openings in front of the engine cowling. Baffles route this air over fins attached to the engine cylinders, and other parts of the engine, where the air absorbs the engine heat. Expulsion of the hot air takes place through one or more openings in the lower, aft portion of the engine cowling. [Figure 5-21]

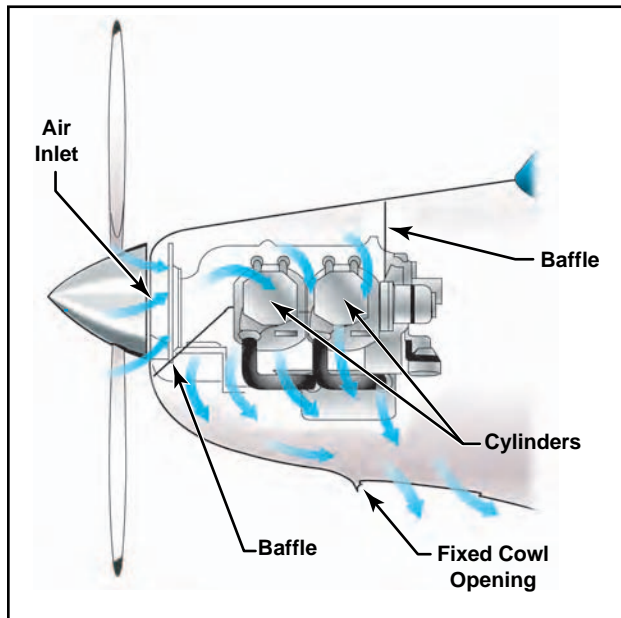

Figure 5-21. Outside air aids in cooling the engine.

The outside air enters the engine compartment through an inlet behind the propeller hub. Baffles direct it to the hottest parts of the engine, primarily the cylinders, which have fins that increase the area exposed to the airflow.

The air cooling system is less effective during ground operations, takeoffs, go-arounds, and other periods of high-power, low-air-speed operation. Conversely, high-speed descents provide excess air and can shock-cool the engine, subjecting it to abrupt temperature fluctuations.

Operating the engine at higher than its designed temperature can cause loss of power, excessive oil consumption, and detonation. It will also lead to serious permanent damage, such as scoring the cylinder walls, damaging the pistons and rings, and burning and warping the valves. Monitoring the cockpit engine temperature instruments will aid in avoiding high operating temperature.

Under normal operating conditions in airplanes not equipped with cowl flaps, the engine temperature can be controlled by changing the airspeed or the power output of the engine. High engine temperatures can be decreased by increasing the airspeed and/or reducing the power.

The oil temperature gauge gives an indirect and delayed indication of rising engine temperature, but can be used for determining engine temperature if this is the only means available.

Many airplanes are equipped with a cylinder-head temperature gauge. This instrument indicates a direct and immediate cylinder temperature change. This instrument is calibrated in degrees Celsius or Fahrenheit, and is usually color-coded with a green arc to indicate the normal operating range. A red line on the instrument indicates maximum allowable cylinder head temperature.

To avoid excessive cylinder head temperatures, increase airspeed, enrich the mixture, and/or reduce power. Any of these procedures help in reducing the engine temperature. On airplanes equipped with **cowl flaps**, use the cowl flap positions to control the temperature. Cowl flaps are hinged covers that fit over the opening through which the hot air is expelled. If the engine temperature is low, the cowl flaps can be closed, thereby restricting the flow of expelled hot air and increasing engine temperature. If the engine temperature is high, the cowl flaps can be opened to permit a greater flow of air through the system, thereby decreasing the engine temperature.

## EXHAUST SYSTEMS

Engine exhaust systems vent the burned combustion gases overboard, provide heat for the cabin, and defrost the windscreen. An exhaust system has exhaust piping attached to the cylinders, as well as a muffler and a muffler shroud. The exhaust gases are pushed out of the cylinder through the exhaust valve and then through the exhaust pipe system to the atmosphere.

**Cowl Flaps**—Shutter-like devices arranged around certain air-cooled engine cowlings, which may be opened or closed to regulate the flow of air around the engine.

For cabin heat, outside air is drawn into the air inlet and is ducted through a shroud around the muffler. The muffler is heated by the exiting exhaust gases and, in turn, heats the air around the muffler. This heated air is then ducted to the cabin for heat and defrost applications. The heat and defrost are controlled in the cockpit, and can be adjusted to the desired level.

Exhaust gases contain large amounts of carbon monoxide, which is odorless and colorless. Carbon monoxide is deadly, and its presence is virtually impossible to detect. The exhaust system must be in good condition and free of cracks.

Some exhaust systems have an exhaust gas temperature probe. This probe transmits the exhaust gas temperature (EGT) to an instrument in the cockpit. The EGT gauge measures the temperature of the gases at the exhaust manifold. This temperature varies with the ratio of fuel to air entering the cylinders and can be used as a basis for regulating the fuel/air mixture. The EGT gauge is highly accurate in indicating the correct mixture setting. When using the EGT to aid in leaning the fuel/air mixture, fuel consumption can be reduced. For specific procedures, refer to the manufacturer's recommendations for leaning the mixture.

## ELECTRICAL SYSTEM

Airplanes are equipped with either a 14- or 28-volt direct-current electrical system. A basic airplane electrical system consists of the following components:

- Alternator/generator
- Battery
- Master/battery switch
- Alternator/generator switch
- Bus bar, fuses, and circuit breakers
- Voltage regulator
- Ammeter/loadmeter
- Associated electrical wiring

Engine-driven alternators or generators supply electric current to the electrical system. They also maintain a sufficient electrical charge in the battery. Electrical energy stored in a battery provides a source of electrical power for starting the engine and a limited supply of electrical power for use in the event the alternator or generator fails.



Most direct current generators will not produce a sufficient amount of electrical current at low engine r.p.m. to operate the entire electrical system. Therefore, during operations at low engine r.p.m., the electrical needs must be drawn from the battery, which can quickly be depleted.

Alternators have several advantages over generators. Alternators produce sufficient current to operate the entire electrical system, even at slower engine speeds, by producing alternating current, which is converted to direct current. The electrical output of an alternator is more constant throughout a wide range of engine speeds.

Some airplanes have receptacles to which an external ground power unit (GPU) may be connected to provide electrical energy for starting. These are very useful, especially during cold weather starting. Follow the manufacturer's recommendations for engine starting using a GPU.

The electrical system is turned on or off with a master switch. Turning the master switch to the ON position provides electrical energy to all the electrical equipment circuits with the exception of the ignition system. Equipment that commonly uses the electrical system for its source of energy includes:

- Position lights
- Anticollision lights
- Landing lights
- Taxi lights
- Interior cabin lights
- Instrument lights
- Radio equipment
- Turn indicator
- Fuel gauges
- Electric fuel pump
- Stall warning system
- Pitot heat
- Starting motor

Many airplanes are equipped with a battery switch that controls the electrical power to the airplane in a manner similar to the master switch. In addition, an alternator switch is installed which permits the pilot to exclude the alternator from the electrical system in the event of alternator failure. [Figure 5-22]



**Figure 5-22.** On this master switch, the left half is for the alternator and the right half is for the battery.

With the alternator half of the switch in the OFF position, the entire electrical load is placed on the battery. Therefore, all nonessential electrical equipment should be turned off to conserve battery power.

A bus bar is used as a terminal in the airplane electrical system to connect the main electrical system to the equipment using electricity as a source of power. This simplifies the wiring system and provides a common point from which voltage can be distributed throughout the system. [Figure 5-23]

Fuses or circuit breakers are used in the electrical system to protect the circuits and equipment from electrical overload. Spare fuses of the proper amperage limit should be carried in the airplane to replace defective or blown fuses. Circuit breakers have the same function as a fuse but can be manually reset, rather than replaced, if an overload condition occurs in the electrical system. Placards at the fuse or circuit breaker panel identify the circuit by name and show the amperage limit.

An ammeter is used to monitor the performance of the airplane electrical system. The ammeter shows if the alternator/generator is producing an adequate supply of electrical power. It also indicates whether or not the battery is receiving an electrical charge.

Ammeters are designed with the zero point in the center of the face and a negative or positive indication on either side. [Figure 5-24] When the pointer of the ammeter on the left is on the plus side, it shows the charging rate of the battery. A minus indication means more current is being drawn from the battery than is being replaced. A full-scale minus deflection indicates a malfunction of the alternator/generator. A full-scale positive deflection indicates a malfunction of the regulator. In either case, consult the AFM or POH for appropriate action to be taken.

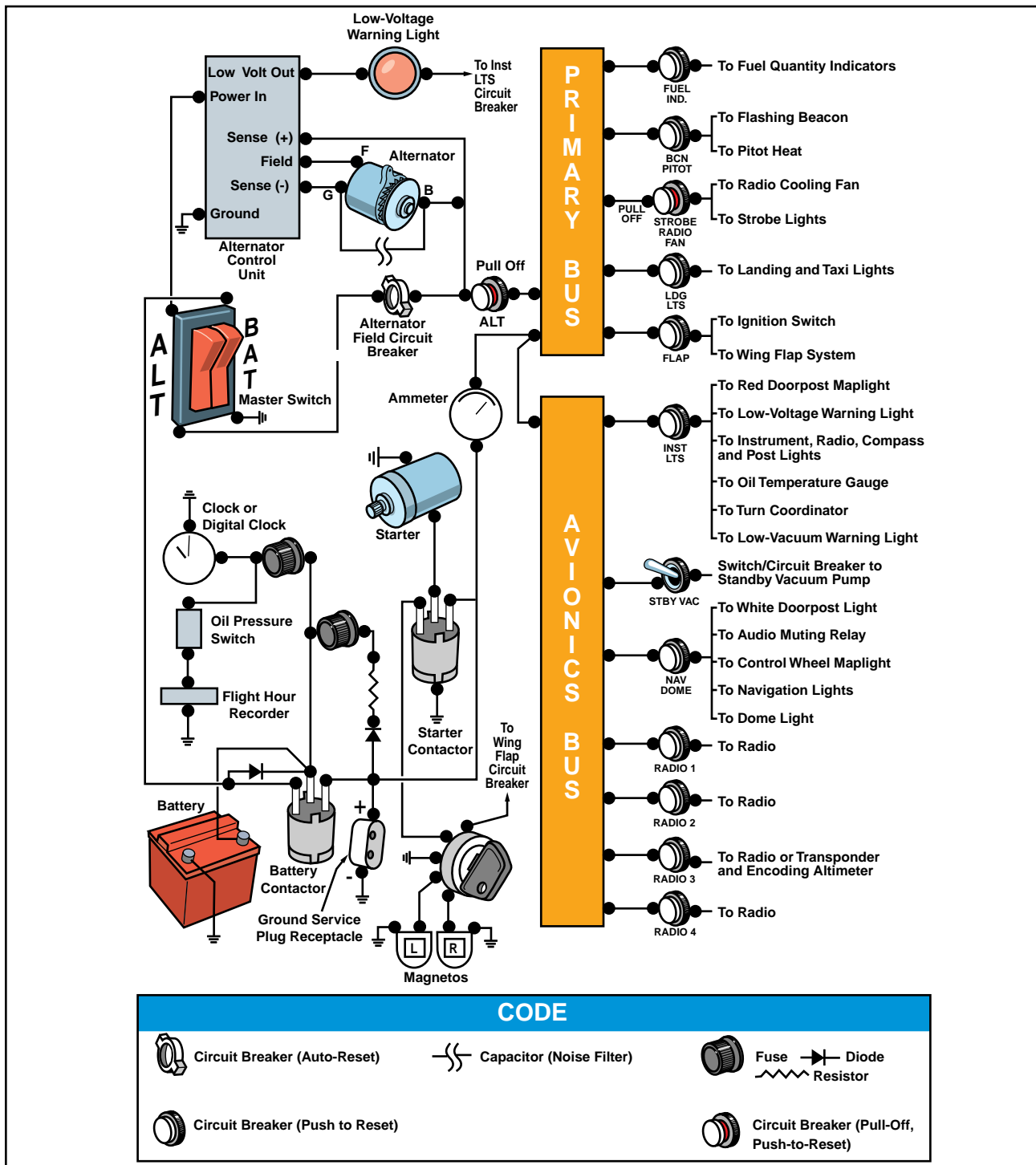

Figure 5-23. Electrical system schematic.



Figure 5-24. Ammeter and loadmeter.

Not all airplanes are equipped with an ammeter. Some have a warning light that, when lighted, indicates a discharge in the system as a generator/alternator malfunction. Refer to the AFM or POH for appropriate action to be taken.

Another electrical monitoring indicator is a loadmeter. This type of gauge, illustrated on the right in figure 5-24, has a scale beginning with zero and shows the load being placed on the alternator/generator. The loadmeter reflects the total percentage of the load placed on the

generating capacity of the electrical system by the electrical accessories and battery. When all electrical components are turned off, it reflects only the amount of charging current demanded by the battery.

A voltage regulator controls the rate of charge to the battery by stabilizing the generator or alternator electrical output. The generator/alternator voltage output should be higher than the battery voltage. For example, a 12-volt battery would be fed by a generator/alternator system of approximately 14 volts. The difference in voltage keeps the battery charged.

## HYDRAULIC SYSTEMS

There are multiple applications for hydraulic use in airplanes, depending on the complexity of the airplane. For example, hydraulics are often used on small airplanes to operate wheel brakes, retractable landing gear, and some constant-speed propellers. On large airplanes, hydraulics are used for flight control surfaces, wing flaps, spoilers, and other systems.

A basic hydraulic system consists of a reservoir, pump (either hand, electric, or engine driven), a filter to keep the fluid clean, selector valve to control the direction of flow, relief valve to relieve excess pressure, and an actuator.

The hydraulic fluid is pumped through the system to an actuator or **servo**. Servos can be either single-acting or double-acting servos based on the needs of the system. This means that the fluid can be applied to one or both sides of the servo, depending on the servo type, and therefore provides power in one direction with a single-acting servo. A servo is a cylinder with a piston inside that turns fluid power into work and creates the power needed to move an aircraft system or flight control. The selector valve allows the fluid direction to be controlled. This is necessary for operations like the extension and retraction of landing gear where the fluid must work in two different directions. The relief valve provides an outlet for the system in the event of excessive fluid pressure in the system. Each system incorporates different components to meet the individual needs of different aircraft.

A mineral-based fluid is the most widely used type for small airplanes. This type of hydraulic fluid, which is a kerosene-like petroleum product, has good lubricating properties, as well as additives to inhibit foaming and prevent the formation of corrosion. It is quite stable chemically, has very little viscosity change with temperature, and is dyed for identification. Since several types of hydraulic fluids are commonly used,

**Servo**—A motor or other form of actuator which receives a small signal from the control device and exerts a large force to accomplish the desired work.

make sure your airplane is serviced with the type specified by the manufacturer. Refer to the AFM, POH, or the Maintenance Manual. [Figure 5-25]

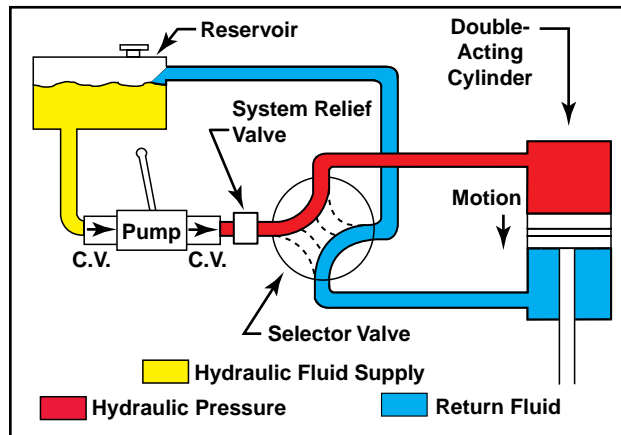

Figure 5-25. Basic hydraulic system.

## LANDING GEAR

The landing gear forms the principal support of the airplane on the surface. The most common type of landing gear consists of wheels, but airplanes can also be equipped with floats for water operations, or skis for landing on snow. [Figure 5-26]



Figure 5-26. The landing gear supports the airplane during the takeoff run, landing, taxiing, and when parked.

The landing gear on small airplanes consists of three wheels—two main wheels, one located on each side of the fuselage, and a third wheel, positioned either at the front or rear of the airplane. Landing gear employing a rear-mounted wheel is called a conventional landing gear. Airplanes with conventional landing gear are often referred to as tailwheel airplanes. When the third wheel is located on the nose, it is called a nosewheel, and the design is referred to as a tricycle gear. A steerable nosewheel or tailwheel permits the airplane to be controlled throughout all operations while on the ground.

## TRICYCLE LANDING GEAR AIRPLANES

A tricycle gear airplane has three main advantages:

1. It allows more forceful application of the brakes during landings at high speeds without resulting in the airplane nosing over.
2. It permits better forward visibility for the pilot during takeoff, landing, and taxiing.
3. It tends to prevent ground looping (swerving) by providing more directional stability during ground operation since the airplane's center of gravity (CG) is forward of the main wheels. The forward CG, therefore, tends to keep the airplane moving forward in a straight line rather than ground looping.

Nosewheels are either steerable or castering. Steerable nosewheels are linked to the rudders by cables or rods, while castering nosewheels are free to swivel. In both cases, you steer the airplane using the rudder pedals. However, airplanes with a castering nosewheel may require you to combine the use of the rudder pedals with independent use of the brakes.

### TAILWHEEL LANDING GEAR AIRPLANES

On tailwheel airplanes, two main wheels, which are attached to the airframe ahead of its center of gravity, support most of the weight of the structure, while a tailwheel at the very back of the fuselage provides a third point of support. This arrangement allows adequate ground clearance for a larger propeller and is more desirable for operations on unimproved fields. [Figure 5-27]

The main drawback with the tailwheel landing gear is that the center of gravity is behind the main gear. This makes directional control more difficult while on the ground. If you allow the airplane to swerve while rolling on the ground at a speed below that at which the rudder has sufficient control, the center of gravity will attempt to get ahead of the main gear. This may cause the airplane to ground loop.



Figure 5-27. Tailwheel landing gear.

Another disadvantage for tailwheel airplanes is the lack of good forward visibility when the tailwheel is on or near the surface. Because of the associated hazards, specific training is required in tailwheel airplanes.

### FIXED AND RETRACTABLE LANDING GEAR

Landing gear can also be classified as either fixed or retractable. A fixed gear always remains extended and has the advantage of simplicity combined with low maintenance. A retractable gear is designed to streamline the airplane by allowing the landing gear to be stowed inside the structure during cruising flight. [Figure 5-28]

### BRAKES

Airplane brakes are located on the main wheels and are applied by either a hand control or by foot pedals (toe or heel). Foot pedals operate independently and allow for differential braking. During ground operations, differential braking can supplement nosewheel/tailwheel steering.

### AUTOPILOT

Autopilots are designed to control the aircraft and help reduce the pilot's workload. The limitations of the autopilot depend on the complexity of the system. The



Figure 5-28. Fixed and retractable gear airplanes.

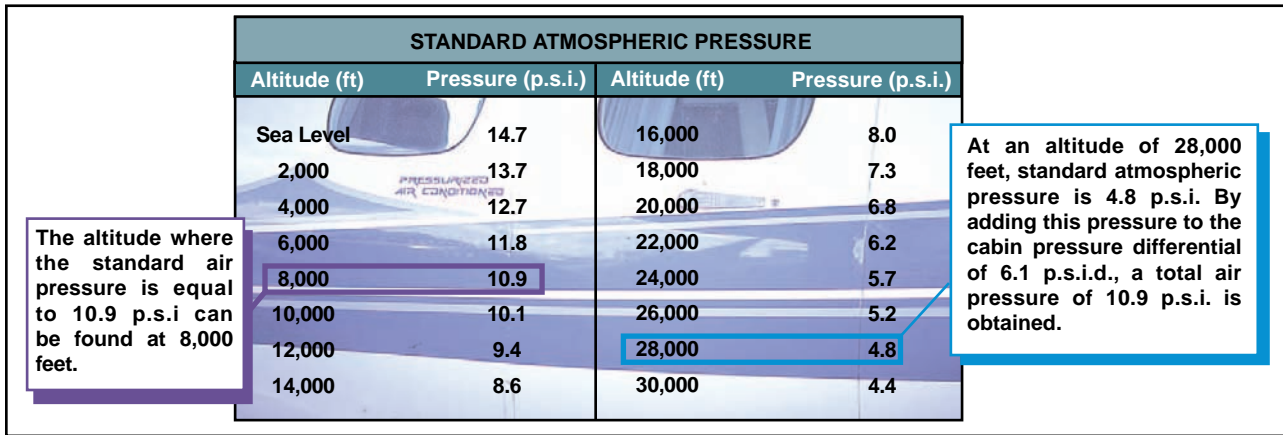

Figure 5-29. Standard atmospheric pressure chart.

common features available on an autopilot are altitude and heading hold. More advanced systems may include a vertical speed and/or indicated airspeed hold mode. Most autopilot systems are coupled to navigational aids.

An autopilot system consists of servos that actuate the flight controls. The number and location of these servos depends on the complexity of the system. For example, a single-axis autopilot controls the aircraft about the longitudinal axis and a servo actuates the ailerons. A three-axis autopilot controls the aircraft about the longitudinal, lateral, and vertical axes; and three different servos actuate the ailerons, the elevator, and the rudder.

The autopilot system also incorporates a disconnect safety feature to automatically or manually disengage the system. Autopilots can also be manually overridden. Because autopilot systems differ widely in their operation, refer to the autopilot operating instructions in the AFM or POH.

## PRESSURIZED AIRPLANES

When an airplane is flown at a high altitude, it consumes less fuel for a given airspeed than it does for the same speed at a lower altitude. In other words, the airplane is more efficient at a high altitude. In addition, bad weather and turbulence may be avoided by flying in the relatively smooth air above the storms. Because of the advantages of flying at high altitudes, many modern general aviation-type airplanes are being designed to operate in that environment. It is important that pilots transitioning to such sophisticated equipment be familiar with at least the basic operating principles.

A cabin pressurization system accomplishes several functions in providing adequate passenger comfort and safety. It maintains a cabin pressure altitude of approximately 8,000 feet at the maximum designed cruising altitude of the airplane, and prevents rapid changes of cabin altitude that may be uncomfortable or

cause injury to passengers and crew. In addition, the pressurization system permits a reasonably fast exchange of air from the inside to the outside of the cabin. This is necessary to eliminate odors and to remove stale air. [Figure 5-29]

Pressurization of the airplane cabin is an accepted method of protecting occupants against the effects of hypoxia. Within a pressurized cabin, occupants can be transported comfortably and safely for long periods of time, particularly if the cabin altitude is maintained at 8,000 feet or below, where the use of oxygen equipment is not required. The flight crew in this type of airplane must be aware of the danger of accidental loss of cabin pressure and must be prepared to deal with such an emergency whenever it occurs.

In the typical pressurization system, the cabin, flight compartment, and baggage compartments are incorporated into a sealed unit that is capable of containing air under a pressure higher than outside atmospheric pressure. On aircraft powered by turbine engines, bleed air from the engine compressor section is used to pressurize the cabin. Superchargers may be used on older model turbine powered airplanes to pump air into the sealed fuselage. Piston-powered airplanes may use air supplied from each engine turbocharger through a sonic venturi (flow limiter). Air is released from the fuselage by a device called an outflow valve. The outflow valve, by regulating the air exit, provides a constant inflow of air to the pressurized area. [Figure 5-30]

To understand the operating principles of pressurization and air-conditioning systems, it is necessary to become familiar with some of the related terms and definitions, such as:

- **Aircraft altitude**—the actual height above sea level at which the airplane is flying.
- **Ambient temperature**—the temperature in the area immediately surrounding the airplane.

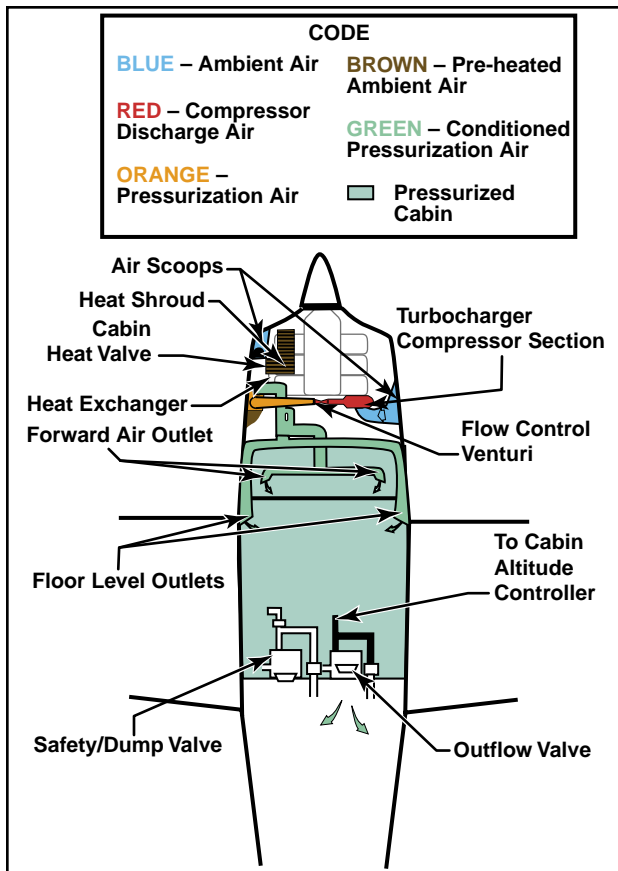

Figure 5-30. High performance airplane pressurization system.

- **Ambient pressure**—the pressure in the area immediately surrounding the airplane.
- **Cabin altitude**—used to express cabin pressure in terms of equivalent altitude above sea level.
- **Differential pressure**—the difference in pressure between the pressure acting on one side of a wall and the pressure acting on the other side of the wall. In aircraft air-conditioning and pressurizing systems, it is the difference between cabin pressure and atmospheric pressure.

The cabin pressure control system provides cabin pressure regulation, pressure relief, vacuum relief, and the means for selecting the desired cabin altitude in the isobaric and differential range. In addition, dumping of the cabin pressure is a function of the pressure control system. A cabin pressure regulator, an outflow valve, and a safety valve are used to accomplish these functions.

The cabin pressure regulator controls cabin pressure to a selected value in the isobaric range and limits cabin pressure to a preset differential value in the differential range. When the airplane reaches the altitude at which the difference between the pressure inside and outside the cabin is equal to the highest differential pressure for

which the fuselage structure is designed, a further increase in airplane altitude will result in a corresponding increase in cabin altitude. Differential control is used to prevent the maximum differential pressure, for which the fuselage was designed, from being exceeded. This differential pressure is determined by the structural strength of the cabin and often by the relationship of the cabin size to the probable areas of rupture, such as window areas and doors.

The cabin air pressure safety valve is a combination pressure relief, vacuum relief, and dump valve. The pressure relief valve prevents cabin pressure from exceeding a predetermined differential pressure above ambient pressure. The vacuum relief prevents ambient pressure from exceeding cabin pressure by allowing external air to enter the cabin when ambient pressure exceeds cabin pressure. The cockpit control switch actuates the dump valve. When this switch is positioned to ram, a solenoid valve opens, causing the valve to dump cabin air to atmosphere.

The degree of pressurization and the operating altitude of the aircraft are limited by several critical design factors. Primarily the fuselage is designed to withstand a particular maximum cabin differential pressure.

Several instruments are used in conjunction with the pressurization controller. The cabin differential pressure gauge indicates the difference between inside and outside pressure. This gauge should be monitored to assure that the cabin does not exceed the maximum allowable differential pressure. A cabin altimeter is also provided as a check on the performance of the system. In some cases, these two instruments are combined into one. A third instrument indicates the cabin rate of climb or descent. A cabin rate-of-climb instrument and a cabin altimeter are illustrated in Figure 5-31 on page 5-26.

Decompression is defined as the inability of the airplane's pressurization system to maintain its designed pressure differential. This can be caused by a malfunction in the pressurization system or structural damage to the airplane. Physiologically, decompressions fall into two categories; they are:

- **Explosive Decompression**—Explosive decompression is defined as a change in cabin pressure faster than the lungs can decompress; therefore, it is possible that lung damage may occur. Normally, the time required to release air from the lungs without restrictions, such as masks, is 0.2 seconds. Most authorities consider any decompression that occurs in less than 0.5 seconds as explosive and potentially dangerous.

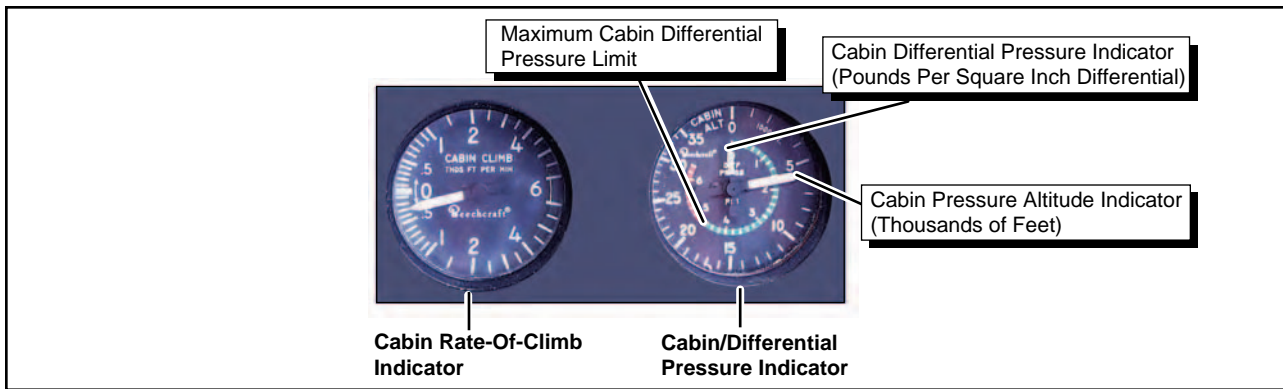

Figure 5-31. Cabin pressurization instruments.

- **Rapid Decompression**—Rapid decompression is defined as a change in cabin pressure where the lungs can decompress faster than the cabin; therefore, there is no likelihood of lung damage.

During an explosive decompression, there may be noise, and for a split second, one may feel dazed. The cabin air will fill with fog, dust, or flying debris. Fog occurs due to the rapid drop in temperature and the change of relative humidity. Normally, the ears clear automatically. Air will rush from the mouth and nose due to the escape of air from the lungs, and may be noticed by some individuals.

The primary danger of decompression is hypoxia. Unless proper utilization of oxygen equipment is accomplished quickly, unconsciousness may occur in a very short time. The period of useful consciousness is considerably shortened when a person is subjected to a rapid decompression. This is due to the rapid reduction of pressure on the body—oxygen in the lungs is exhaled rapidly. This in effect reduces the partial pressure of oxygen in the blood and therefore reduces the pilot's effective performance time by one-third to one-fourth its normal time. For this reason, the oxygen mask should be worn when flying at very high altitudes (35,000 feet or higher). It is recommended that the crewmembers select the 100 percent oxygen setting on the oxygen regulator at high altitude if the airplane is equipped with a demand or pressure demand oxygen system.

Another hazard is being tossed or blown out of the airplane if near an opening. For this reason, individuals near openings should wear safety harnesses or seatbelts at all times when the airplane is pressurized and they are seated.

Another potential hazard during high altitude decompressions is the possibility of evolved gas decompression sicknesses. Exposure to wind blasts and extremely cold temperatures are other hazards one might have to face.

Rapid descent from altitude is necessary if these problems are to be minimized. Automatic visual and aural warning systems are included in the equipment of all pressurized airplanes.

## OXYGEN SYSTEMS

Most high altitude airplanes come equipped with some type of fixed oxygen installation. If the airplane does not have a fixed installation, portable oxygen equipment must be readily accessible during flight. The portable equipment usually consists of a container, regulator, mask outlet, and pressure gauge. Aircraft oxygen is usually stored in high pressure system containers of 1,800 – 2,200 pounds per square inch (p.s.i.). When the ambient temperature surrounding an oxygen cylinder decreases, pressure within that cylinder will decrease because pressure varies directly with temperature if the volume of a gas remains constant. If a drop in indicated pressure on a supplemental oxygen cylinder is noted, there is no reason to suspect depletion of the oxygen supply, which has simply been compacted due to storage of the containers in an unheated area of the aircraft. High pressure oxygen containers should be marked with the p.s.i. tolerance (i.e., 1,800 p.s.i.) before filling the container to that pressure. The containers should be supplied with aviation oxygen only, which is 100 percent pure oxygen. Industrial oxygen is not intended for breathing and may contain impurities, and medical oxygen contains water vapor that can freeze in the regulator when exposed to cold temperatures. To assure safety, oxygen system periodic inspection and servicing should be done.

An oxygen system consists of a mask and a regulator that supplies a flow of oxygen dependent upon cabin altitude. Regulators approved for use up to 40,000 feet are designed to provide zero percent cylinder oxygen and 100 percent cabin air at cabin altitudes of 8,000 feet or less, with the ratio changing to 100 percent oxygen and zero percent cabin air at approximately 34,000 feet cabin altitude. Regulators approved up to 45,000 feet are designed to provide 40 percent cylinder oxygen and 60 percent cabin air at lower altitudes, with

the ratio changing to 100 percent at the higher altitude. Pilots should avoid flying above 10,000 feet without oxygen during the day and above 8,000 feet at night. [Figure 5-32]



Figure 5-32. Oxygen system regulator.

Pilots should be aware of the danger of fire when using oxygen. Materials that are nearly fireproof in ordinary air may be susceptible to burning in oxygen. Oils and greases may catch fire if exposed to oxygen, and cannot be used for sealing the valves and fittings of oxygen equipment. Smoking during any kind of oxygen equipment use is prohibited. Before each flight, the pilot should thoroughly inspect and test all oxygen equipment. The inspection should include a thorough examination of the aircraft oxygen equipment, including available supply, an operational check of the system, and assurance that the supplemental oxygen is readily accessible. The inspection should be accomplished with clean hands and should include a visual inspection of the mask and tubing for tears, cracks, or deterioration; the regulator for valve and lever condition and positions; oxygen quantity; and the location and functioning of oxygen pressure gauges, flow indicators and connections. The mask should be donned and the system should be tested. After any oxygen use, verify that all components and valves are shut off.

## MASKS

There are numerous types of oxygen masks in use that vary in design detail. It would be impractical to discuss all of the types in this handbook. It is important that the masks used be compatible with the particular oxygen system involved. Crew masks are fitted to the user's face with a minimum of leakage. Crew masks usually contain a microphone. Most masks are the oronasal-type, which covers only the mouth and nose.

Passenger masks may be simple, cup-shaped rubber moldings sufficiently flexible to obviate individual fitting. They may have a simple elastic head strap or

the passenger may hold them to the face.

All oxygen masks should be kept clean. This reduces the danger of infection and prolongs the life of the mask. To clean the mask, wash it with a mild soap and water solution and rinse it with clear water. If a microphone is installed, use a clean swab, instead of running water, to wipe off the soapy solution. The mask should also be disinfected. A gauze pad that has been soaked in a water solution of Merthiolate can be used to swab out the mask. This solution should contain one-fifth teaspoon of Merthiolate per quart of water. Wipe the mask with a clean cloth and air dry.

## DILUTER DEMAND OXYGEN SYSTEMS

Diluter demand oxygen systems supply oxygen only when the user inhales through the mask. An automix lever allows the regulators to automatically mix cabin air and oxygen or supply 100 percent oxygen, depending on the altitude. The demand mask provides a tight seal over the face to prevent dilution with outside air and can be used safely up to 40,000 feet. A pilot who has a beard or mustache should be sure it is trimmed in a manner that will not interfere with the sealing of the oxygen mask. The fit of the mask around the beard or mustache should be checked on the ground for proper sealing.

## PRESSURE DEMAND OXYGEN SYSTEMS

Pressure demand oxygen systems are similar to diluter demand oxygen equipment, except that oxygen is supplied to the mask under pressure at cabin altitudes above 34,000 feet. Pressure demand regulators also create airtight and oxygen-tight seals, but they also provide a positive pressure application of oxygen to the mask face piece that allows the user's lungs to be pressurized with oxygen. This feature makes pressure demand regulators safe at altitudes above 40,000 feet. Some systems may have a pressure demand mask with the regulator attached directly to the mask, rather than mounted on the instrument panel or other area within the flight deck. The mask-mounted regulator eliminates the problem of a long hose that must be purged of air before 100 percent oxygen begins flowing into the mask.

## CONTINUOUS FLOW OXYGEN SYSTEM

Continuous flow oxygen systems are usually provided for passengers. The passenger mask typically has a reservoir bag, which collects oxygen from the continuous flow oxygen system during the time when the mask user is exhaling. The oxygen collected in the reservoir bag allows a higher aspiratory flow rate during the inhalation cycle, which reduces the amount of air dilution. Ambient air is added to the supplied



oxygen during inhalation after the reservoir bag oxygen supply is depleted. The exhaled air is released to the cabin. [Figure 5-33]

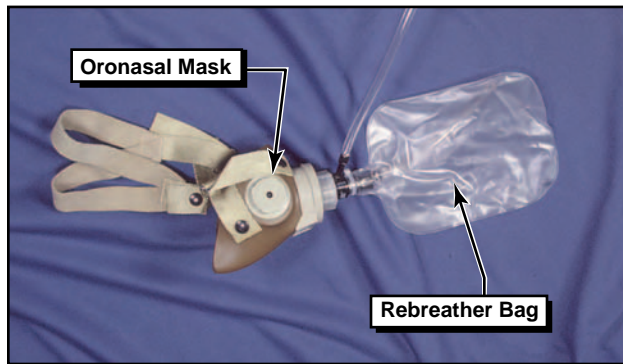

Figure 5-33. Continuous flow mask and rebreather bag.

### SERVICING OF OXYGEN SYSTEMS

Certain precautions should be observed whenever aircraft oxygen systems are to be serviced. Before servicing any aircraft with oxygen, consult the specific aircraft service manual to determine the type of equipment required and procedures to be used. Oxygen system servicing should be accomplished only when the aircraft is located outside of the hangars. Personal cleanliness and good housekeeping are imperative when working with oxygen. Oxygen under pressure and petroleum products create spontaneous results when they are brought in contact with each other. Service people should be certain to wash dirt, oil, and grease (including lip salves and hair oil) from their hands before working around oxygen equipment. It is also essential that clothing and tools are free of oil, grease, and dirt. Aircraft with permanently installed oxygen tanks usually require two persons to accomplish servicing of the system. One should be stationed at the service equipment control valves, and the other stationed where he or she can observe the aircraft system pressure gauges. Oxygen system servicing is not recommended during aircraft fueling operations or while other work is performed that could provide a source of ignition. Oxygen system servicing while passengers are on board the aircraft is not recommended.

### ICE CONTROL SYSTEMS

Ice control systems installed on aircraft consist of anti-ice and de-ice equipment. Anti-icing equipment is designed to prevent the formation of ice, while de-icing equipment is designed to remove ice once it has formed. Ice control systems protect the leading edge of wing and tail surfaces, pitot and static port openings, fuel tank vents, stall warning devices, windshields, and propeller blades. Ice detection lighting may also be installed on some airplanes to determine the extent of structural icing during night flights. Since many airplanes are not certified for flight in icing conditions, refer to the AFM or POH for details.

### AIRFOIL ICE CONTROL

Inflatable de-icing boots consist of a rubber sheet bonded to the leading edge of the airfoil. When ice builds up on the leading edge, an engine-driven pneumatic pump inflates the rubber boots. Some turboprop aircraft divert engine bleed air to the wing to inflate the rubber boots. Upon inflation, the ice is cracked and should fall off the leading edge of the wing. De-icing boots are controlled from the cockpit by a switch and can be operated in a single cycle or allowed to cycle at automatic, timed intervals. It is important that de-icing boots are used in accordance with the manufacturer's recommendations. If they are allowed to cycle too often, ice can form over the contour of the boot and render the boots ineffective. [Figure 5-34]

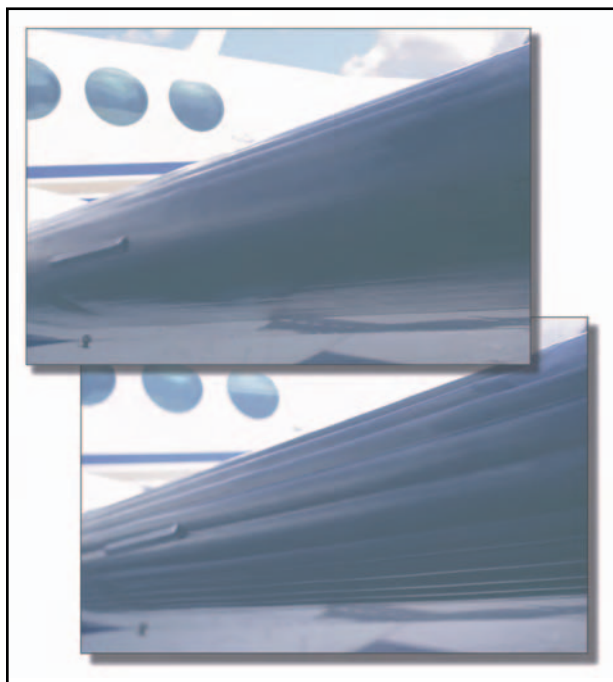

Figure 5-34. De-icing boots on the leading edge of the wing.

Many de-icing boot systems use the instrument system suction gauge and a pneumatic pressure gauge to indicate proper boot operation. These gauges have range markings that indicate the operating limits for boot operation. Some systems may also incorporate an annunciator light to indicate proper boot operation.

Proper maintenance and care of de-icing boots is important for continued operation of this system. They need to be carefully inspected prior to a flight.

Another type of leading edge protection is the thermal anti-ice system installed on airplanes with turbine engines. This system is designed to prevent the buildup of ice by directing hot air from the compressor section of the engine to the leading edge surfaces. The system is activated prior to entering icing conditions. The hot air heats the leading edge sufficiently to prevent the formation of ice.

An alternate type of leading edge protection that is not as common as thermal anti-ice and de-icing boots is known as a weeping wing. The weeping-wing design uses small holes located in the leading edge of the wing. A chemical mixture is pumped to the leading edge and weeps out through the holes to prevent the formation and buildup of ice.

### WINDSCREEN ICE CONTROL

There are two main types of windscreen anti-ice systems. The first system directs a flow of alcohol to the windscreen. By using it early enough, the alcohol will prevent ice from building up on the windshield. The rate of alcohol flow can be controlled by a dial in the cockpit according to procedures recommended by the airplane manufacturer.

Another effective method of anti-icing equipment is the electric heating method. Small wires or other conductive material is imbedded in the windscreen. The heater can be turned on by a switch in the cockpit, at which time electrical current is passed across the shield through the wires to provide sufficient heat to prevent the formation of ice on the windscreen. The electrical current can cause compass deviation errors; in some cases, as much as 40°. The heated windscreen should only be used during flight. Do not leave it on during ground operations, as it can overheat and cause damage to the windscreen.

### PROPELLER ICE CONTROL

Propellers are protected from icing by use of alcohol or electrically heated elements. Some propellers are equipped with a discharge nozzle that is pointed toward the root of the blade. Alcohol is discharged from the nozzles, and centrifugal force makes the alcohol flow down the leading edge of the blade. This prevents ice from forming on the leading edge of the propeller. Propellers can also be fitted with propeller anti-ice boots. The propeller boot is divided into two sections—the inboard and the outboard sections. The boots are grooved to help direct the flow of alcohol, and they are also imbedded with electrical wires that carry current for heating the propeller. The prop anti-ice system can be monitored for proper operation by monitoring the prop anti-ice ammeter. During the preflight inspection, check the propeller boots for proper operation. If a boot fails to heat one blade, an unequal blade loading can result, and may cause severe propeller vibration. [Figure 5-35]

### OTHER ICE CONTROL SYSTEMS

Pitot and static ports, fuel vents, stall-warning sensors, and other optional equipment may be heated by

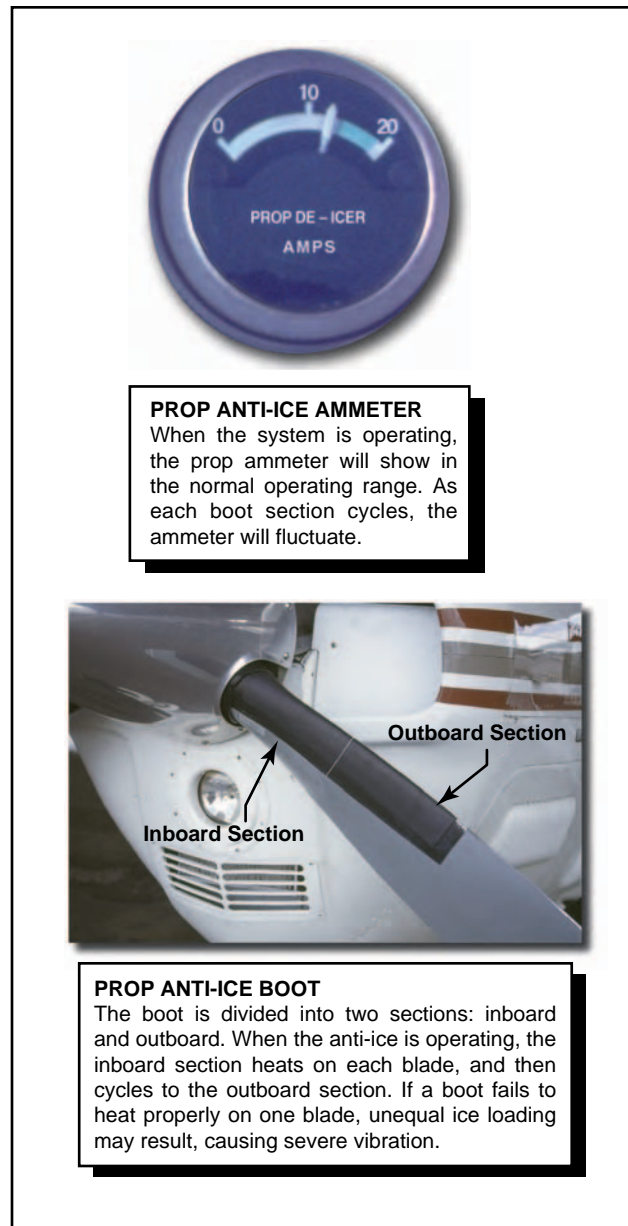

Figure 5-35. Prop ammeter and anti-ice boots.

electrical elements. Operational checks of the electrically heated systems are to be checked in accordance with the AFM or POH.

Operation of aircraft anti-icing and de-icing systems should be checked prior to encountering icing conditions. Encounters with structural ice require immediate remedial action. Anti-icing and de-icing equipment is not intended to sustain long-term flight in icing conditions.

## TURBINE ENGINES

The turbine engine produces thrust by increasing the velocity of the air flowing through the engine. It consists of an air inlet, compressor, combustion chambers, turbine section, and exhaust. [Figure 5-36] The turbine

engine has the following advantages over a reciprocating engine: less vibration, increased aircraft performance, reliability, and ease of operation.

### TYPES OF TURBINE ENGINES

Turbine engines are classified according to the type of compressors they use. The compressor types fall into three categories—centrifugal flow, axial flow, and centrifugal-axial flow. Compression of inlet air is achieved in a centrifugal flow engine by accelerating air outward perpendicular to the longitudinal axis of the machine. The axial-flow engine compresses air by a series of rotating and stationary airfoils moving the air parallel to the longitudinal axis. The centrifugal-axial flow design uses both kinds of compressors to achieve the desired compression.

The path the air takes through the engine and how power is produced determines the type of engine. There are four types of aircraft turbine engines—turbojet, turboprop, turbofan, and turboshaft.

### TURBOJET

The turbojet engine contains four sections: compressor, combustion chamber, turbine section, and exhaust. The compressor section passes inlet air at a high rate of speed to the combustion chamber. The combustion chamber contains the fuel inlet and igniter for combustion. The expanding air drives a turbine, which is connected by a shaft to the compressor, sustaining engine operation. The accelerated exhaust gases from the engine provide thrust. This is a basic application of compressing air, igniting the fuel-air mixture, producing power to self-sustain the engine operation, and exhaust for propulsion.

Turbojet engines are limited on range and endurance.

They are also slow to respond to throttle applications at slow compressor speeds.

### TURBOPROP

A turboprop engine is a turbine engine that drives a propeller through a reduction gear. The exhaust gases drive a power turbine connected by a shaft that drives the reduction gear assembly. Reduction gearing is necessary in turboprop engines because optimum propeller performance is achieved at much slower speeds than the engine's operating r.p.m. Turboprop engines are a compromise between turbojet engines and reciprocating powerplants. Turboprop engines are most efficient at speeds between 250 and 400 m.p.h. and altitudes between 18,000 and 30,000 feet. They also perform well at the slow airspeeds required for takeoff and landing, and are fuel efficient. The minimum specific fuel consumption of the turboprop engine is normally available in the altitude range of 25,000 feet to the tropopause.

### TURBOFAN

Turbofans were developed to combine some of the best features of the turbojet and the turboprop. Turbofan engines are designed to create additional thrust by diverting a secondary airflow around the combustion chamber. The turbofan bypass air generates increased thrust, cools the engine, and aids in exhaust noise suppression. This provides turbojet-type cruise speed and lower fuel consumption.

The inlet air that passes through a turbofan engine is usually divided into two separate streams of air. One stream passes through the engine core, while a second stream bypasses the engine core. It is this bypass stream of air that is responsible for the term "bypass engine." A turbofan's bypass ratio refers to the ratio of the mass airflow that passes through the fan divided by the mass airflow that passes through the engine core.

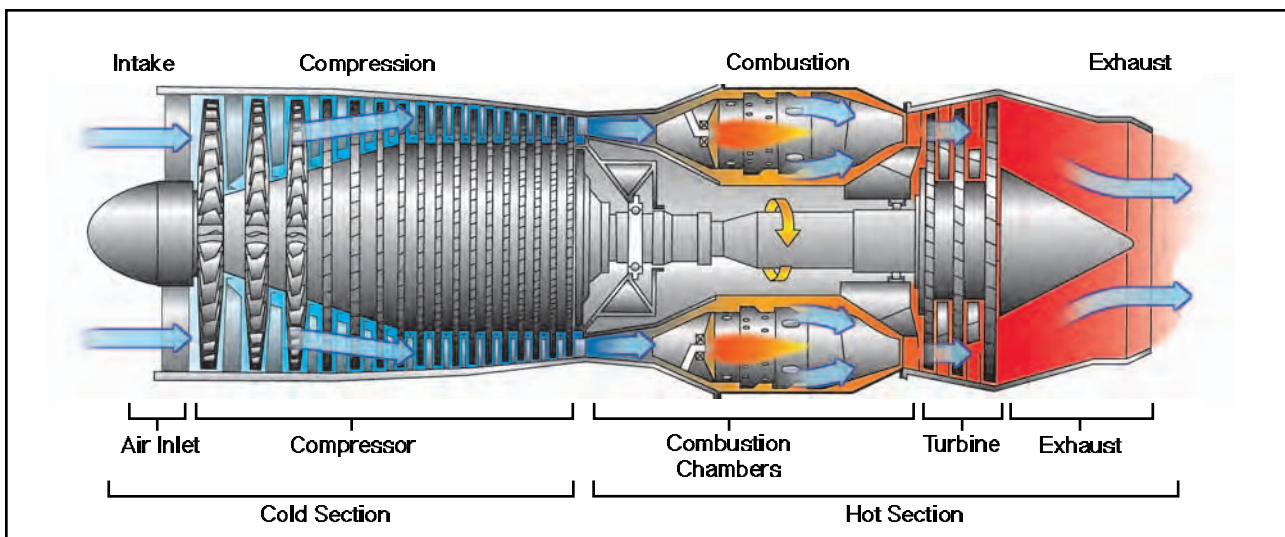

Figure 5-36. Basic components of a turbine engine.

## TURBOSHAFT

The fourth common type of jet engine is the turboshaft. It delivers power to a shaft that drives something other than a propeller. The biggest difference between a turbojet and turboshaft engine is that on a turboshaft engine, most of the energy produced by the expanding gases is used to drive a turbine rather than produce thrust. Many helicopters use a turboshaft gas turbine engine. In addition, turboshaft engines are widely used as auxiliary power units on large aircraft.

## PERFORMANCE COMPARISON

It is possible to compare the performance of a reciprocating powerplant and different types of turbine engines. However, for the comparison to be accurate, thrust horsepower (usable horsepower) for the reciprocating powerplant must be used rather than brake horsepower, and net thrust must be used for the turbine-powered engines. In addition, aircraft design configuration, and size must be approximately the same.

- BHP— Brake horsepower is the horsepower actually delivered to the output shaft. Brake horsepower is the actual usable horsepower.
- Net Thrust— The thrust produced by a turbojet or turbofan engine.
- THP— Thrust horsepower is the horsepower equivalent of the thrust produced by a turbojet or turbofan engine.
- ESHP— Equivalent shaft horsepower, with respect to turboprop engines, is the sum of the shaft horsepower (SHP) delivered to the propeller and the thrust horsepower (THP) produced by the exhaust gases.

Figure 5-37 shows how four types of engines compare in net thrust as airspeed is increased. This figure is for explanatory purposes only and is not for specific models of engines. The four types of engines are:

- Reciprocating powerplant.
- Turbine, propeller combination (turboprop).
- Turbine engine incorporating a fan (turbofan).
- Turbojet (pure jet).

The comparison is made by plotting the performance curve for each engine, which shows how maximum aircraft speed varies with the type of engine used. Since the graph is only a means of comparison, numerical values for net thrust, aircraft speed, and drag are not included.

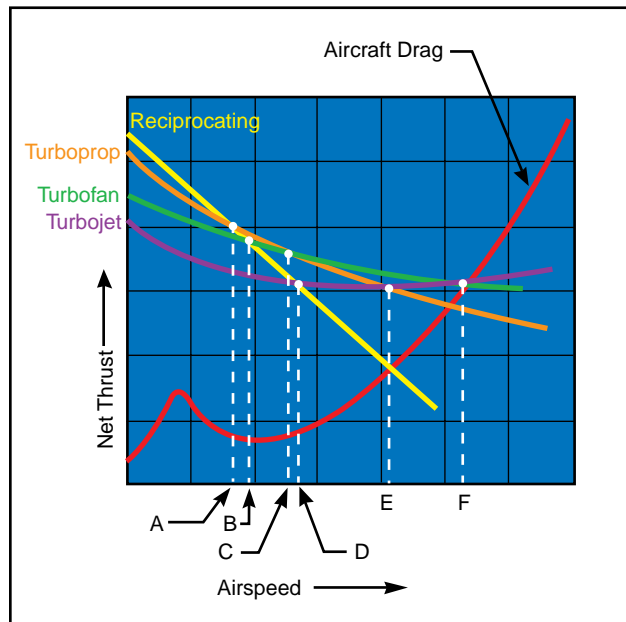

Figure 5-37. Engine net thrust versus aircraft speed and drag.

Comparison of the four powerplants on the basis of net thrust makes certain performance capabilities evident. In the speed range shown to the left of Line A, the reciprocating powerplant outperforms the other three types. The turboprop outperforms the turbofan in the range to the left of Line C. The turbofan engine outperforms the turbojet in the range to the left of Line F. The turbofan engine outperforms the reciprocating powerplant to the right of Line B and the turboprop to the right of Line C. The turbojet outperforms the reciprocating powerplant to the right of Line D, the turboprop to the right of Line E, and the turbofan to the right of Line F.

The points where the aircraft drag curve intersects the net thrust curves are the maximum aircraft speeds. The vertical lines from each of the points to the baseline of the graph indicate that the turbojet aircraft can attain a higher maximum speed than aircraft equipped with the other types of engines. Aircraft equipped with the turbofan engine will attain a higher maximum speed than aircraft equipped with a turboprop or reciprocating powerplant.

## TURBINE ENGINE INSTRUMENTS

Engine instruments that indicate oil pressure, oil temperature, engine speed, exhaust gas temperature, and fuel flow are common to both turbine and reciprocating engines. However, there are some instruments that are unique to turbine engines. These instruments provide indications of engine pressure ratio, turbine discharge pressure, and torque. In addition, most gas turbine engines have multiple temperature-sensing instruments, called thermocouples, that provide pilots with temperature readings in and around the turbine section.

## ENGINE PRESSURE RATIO

An engine pressure ratio (EPR) gauge is used to indicate the power output of a turbojet/turbofan engine. EPR is the ratio of turbine discharge to compressor inlet pressure. Pressure measurements are recorded by probes installed in the engine inlet and at the exhaust. Once collected, the data is sent to a differential pressure transducer, which is indicated on a cockpit EPR gauge.

EPR system design automatically compensates for the effects of airspeed and altitude. However, changes in ambient temperature do require a correction to be applied to EPR indications to provide accurate engine power settings.

## EXHAUST GAS TEMPERATURE

A limiting factor in a gas turbine engine is the temperature of the turbine section. The temperature of a turbine section must be monitored closely to prevent overheating the turbine blades and other exhaust section components. One common way of monitoring the temperature of a turbine section is with an exhaust gas temperature (EGT) gauge. EGT is an engine operating limit used to monitor overall engine operating conditions.

Variations of EGT systems bear different names based on the location of the temperature sensors. Common turbine temperature sensing gauges include the turbine inlet temperature (TIT) gauge, turbine outlet temperature (TOT) gauge, interstage turbine temperature (ITT) gauge, and turbine gas temperature (TGT) gauge.

## TORQUEMETER

Turboprop/turboshaft engine power output is measured by the torque meter. Torque is a twisting force applied to a shaft. The torque meter measures power applied to the shaft. Turboprop and turboshaft engines are designed to produce torque for driving a propeller. Torque meters are calibrated in percentage units, foot-pounds, or pounds per square inch.

## $N_1$ INDICATOR

$N_1$  represents the rotational speed of the low pressure compressor and is presented on the indicator as a percentage of design r.p.m. After start the speed of the low pressure compressor is governed by the  $N_1$  turbine wheel. The  $N_1$  turbine wheel is connected to the low pressure compressor through a **concentric shaft**.

## $N_2$ INDICATOR

$N_2$  represents the rotational speed of the high pressure compressor and is presented on the indicator as a percentage of design r.p.m. The high pressure compressor is governed by the  $N_2$  turbine wheel. The

$N_2$  turbine wheel is connected to the high pressure compressor through a concentric shaft. [Figure 5-38]

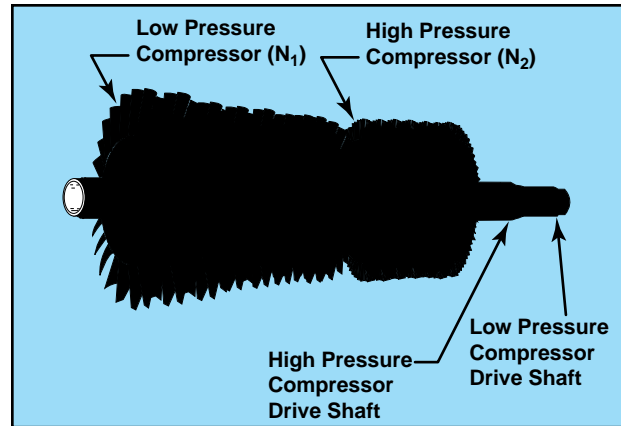

Figure 5-38. Dual-spool axial-flow compressor.

## TURBINE ENGINE OPERATIONAL CONSIDERATIONS

Because of the great variety of turbine engines, it is impractical to cover specific operational procedures. However, there are certain operational considerations that are common to all turbine engines. They are engine temperature limits, foreign object damage, hot start, compressor stall, and flameout.

## ENGINE TEMPERATURE LIMITATIONS

The highest temperature in any turbine engine occurs at the turbine inlet. Turbine inlet temperature is therefore usually the limiting factor in turbine engine operation.

## THRUST VARIATIONS

Turbine engine thrust varies directly with air density. As air density decreases, so does thrust. While both turbine and reciprocating powered engines are affected to some degree by high relative humidity, turbine engines will experience a negligible loss of thrust, while reciprocating engines a significant loss of brake horsepower.

## FOREIGN OBJECT DAMAGE

Due to the design and function of a turbine engine's air inlet, the possibility of ingestion of debris always exists. This causes significant damage, particularly to the compressor and turbine sections. When this occurs, it is called foreign object damage (FOD). Typical FOD consists of small nicks and dents caused by ingestion of small objects from the ramp, taxiway, or runway. However, FOD damage caused by bird strikes or ice ingestion can also occur, and may result in total destruction of an engine.

Prevention of FOD is a high priority. Some engine inlets have a tendency to form a vortex between the ground and the inlet during ground operations. A vortex dissipater may be installed on these engines.

**Concentric Shaft**—One shaft inside another shaft having a common core.

Other devices, such as screens and/or deflectors, may also be utilized. Preflight procedures include a visual inspection for any sign of FOD.

### TURBINE ENGINE HOT/HUNG START

A hot start is when the EGT exceeds the safe limit. Hot starts are caused by too much fuel entering the combustion chamber, or insufficient turbine r.p.m. Any time an engine has a hot start, refer to the AFM, POH, or an appropriate maintenance manual for inspection requirements.

If the engine fails to accelerate to the proper speed after ignition or does not accelerate to idle r.p.m., a hung start has occurred. A hung start, may also be called a false start. A hung start may be caused by an insufficient starting power source or fuel control malfunction.

### COMPRESSOR STALLS

Compressor blades are small airfoils and are subject to the same aerodynamic principles that apply to any airfoil. A compressor blade has an angle of attack. The angle of attack is a result of inlet air velocity and the compressor's rotational velocity. These two forces combine to form a vector, which defines the airfoil's actual angle of attack to the approaching inlet air.

A compressor stall can be described as an imbalance between the two vector quantities, inlet velocity and compressor rotational speed. Compressor stalls occur when the compressor blades' angle of attack exceeds the critical angle of attack. At this point, smooth airflow is interrupted and turbulence is created with pressure fluctuations. Compressor stalls cause air flowing in the compressor to slow down and stagnate, sometimes reversing direction. [Figure 5-39]

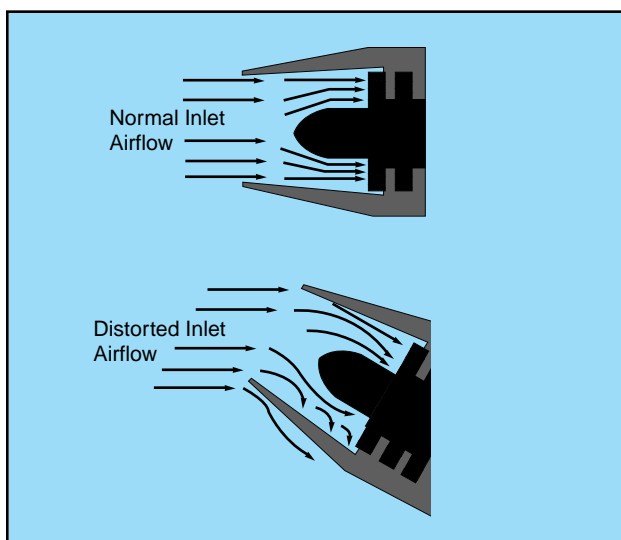

Figure 5-39. Comparison of normal and distorted airflow into the compressor section.

Compressor stalls can be transient and intermittent or steady state and severe. Indications of a transient/intermittent stall are usually an intermittent “bang” as backfire and flow reversal take place. If the stall develops and becomes steady, strong vibration and a loud roar may develop from the continuous flow reversal. Quite often the cockpit gauges will not show a mild or transient stall, but will indicate a developed stall. Typical instrument indications include fluctuations in r.p.m., and an increase in exhaust gas temperature. Most transient stalls are not harmful to the engine and often correct themselves after one or two pulsations. The possibility of engine damage, which may be severe, from a steady state stall is immediate. Recovery must be accomplished quickly by reducing power, decreasing the airplane's angle of attack and increasing airspeed.

Although all gas turbine engines are subject to compressor stalls, most models have systems that inhibit these stalls. One such system uses variable inlet guide vane (VIGV) and variable stator vanes, which direct the incoming air into the rotor blades at an appropriate angle. The main way to prevent air pressure stalls is to operate the airplane within the parameters established by the manufacturer. If a compressor stall does develop, follow the procedures recommended in the AFM or POH.

### FLAMEOUT

A flameout is a condition in the operation of a gas turbine engine in which the fire in the engine unintentionally goes out. If the rich limit of the fuel/air ratio is exceeded in the combustion chamber, the flame will blow out. This condition is often referred to as a rich flameout. It generally results from very fast engine acceleration, where an overly rich mixture causes the fuel temperature to drop below the combustion temperature. It also may be caused by insufficient airflow to support combustion.

Another, more common flameout occurrence is due to low fuel pressure and low engine speeds, which typically are associated with high-altitude flight. This situation also may occur with the engine throttled back during a descent, which can set up the lean-condition flameout. A weak mixture can easily cause the flame to die out, even with a normal airflow through the engine.

Any interruption of the fuel supply also can result in a flameout. This may be due to prolonged unusual attitudes, a malfunctioning fuel control system, turbulence, icing or running out of fuel.

Symptoms of a flameout normally are the same as those following an engine failure. If the flameout is due to a transitory condition, such as an imbalance between fuel flow and engine speed, an airstart may be

attempted once the condition is corrected. In any case, pilots must follow the applicable emergency procedures outlined in the AFM or POH. Generally,

these procedures contain recommendations concerning altitude and airspeed where the airstart is most likely to be successful.

# Chapter 6



## Flight Instruments

Flight instruments enable an airplane to be operated with maximum performance and enhanced safety, especially when flying long distances. Manufacturers provide the necessary flight instruments, but to use them effectively, pilots need to understand how they operate. This chapter covers the operational aspects of the pitot-static system and associated instruments, the vacuum system and associated instruments, and the magnetic compass.

### PITOT-STATIC FLIGHT INSTRUMENTS

There are two major parts of the pitot-static system: the impact pressure chamber and lines, and the static pressure chamber and lines. They provide the source of ambient air pressure for the operation of the altimeter, vertical speed indicator (vertical velocity indicator), and the airspeed indicator. [Figure 6-1]

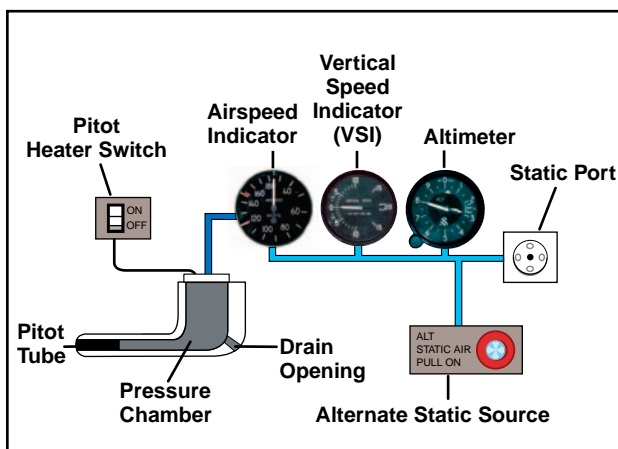

Figure 6-1. Pitot-static system and instruments.

### IMPACT PRESSURE CHAMBER AND LINES

In this system, the impact air pressure (air striking the airplane because of its forward motion) is taken from a pitot tube, which is mounted in locations that provide minimum disturbance or turbulence caused by the motion of the airplane through the air. The static pressure (pressure of the still air) is usually taken from the static line attached to a vent or vents mounted flush with the side of the fuselage. This compensates for any possible variation in static pressure due to erratic changes in airplane attitude.

The openings of both the pitot tube and the static vent must be checked during the preflight inspection to assure that they are free from obstructions. Blocked or partially blocked openings should be cleaned by a certificated mechanic. Blowing into these openings is not recommended because this could damage the instruments.

As the airplane moves through the air, the impact pressure on the open pitot tube affects the pressure in the pitot chamber. Any change of pressure in the pitot chamber is transmitted through a line connected to the airspeed indicator, which utilizes impact pressure for its operation.

### STATIC PRESSURE CHAMBER AND LINES

The static chamber is vented through small holes to the free undisturbed air, and as the atmospheric pressure increases or decreases, the pressure in the static chamber changes accordingly. Again, this pressure change is transmitted through lines to the instruments which utilize static pressure.



An alternate source for static pressure is provided in some airplanes in the event the static ports become blocked. This source usually is vented to the pressure inside the cockpit. Because of the venturi effect of the flow of air over the cockpit, this alternate static pressure is usually lower than the pressure provided by the normal static air source. When the alternate static source is used, the following differences in the instrument indications usually occur: the altimeter will indicate higher than the actual altitude, the airspeed will indicate greater than the actual airspeed, and the vertical speed will indicate a climb while in level flight. Consult the Airplane Flight Manual or Pilot's Operating Handbook (AFM/POH) to determine the amount of error.

If the airplane is not equipped with an alternate static source, breaking the glass seal of the vertical speed indicator allows ambient air pressure to enter the static system. This makes the VSI unusable.

## ALTIMETER

The altimeter measures the height of the airplane above a given pressure level. Since it is the only instrument that gives altitude information, the altimeter is one of the most vital instruments in the airplane. To use the altimeter effectively, its operation and how atmospheric pressure and temperature affect it must be thoroughly understood. A stack of sealed **aneroid** wafers comprises the main component of the altimeter. These wafers expand and contract with changes in atmospheric pressure from the static source. The mechanical linkage translates these changes into pointer movements on the indicator. [Figure 6-2]

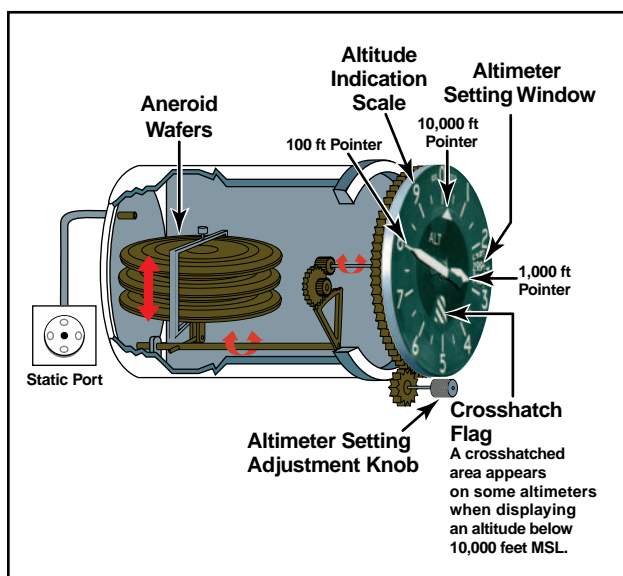

Figure 6-2. Altimeter.

**Aneroid**—A sealed flexible container, which expands or contracts in relation to the surrounding air pressure. It is used in an altimeter or a barometer to measure the pressure of the air.

## PRINCIPLE OF OPERATION

The pressure altimeter is an aneroid barometer that measures the pressure of the atmosphere at the level where the altimeter is located, and presents an altitude indication in feet. The altimeter uses static pressure as its source of operation. Air is denser at sea level than aloft, so as altitude increases, atmospheric pressure decreases. This difference in pressure at various levels causes the altimeter to indicate changes in altitude.

The presentation of altitude varies considerably between different types of altimeters. Some have one pointer while others have two or more. Only the multipointer type will be discussed in this handbook. The dial of a typical altimeter is graduated with numerals arranged clockwise from 0 to 9. Movement of the aneroid element is transmitted through gears to the three hands that indicate altitude. The shortest hand indicates altitude in tens of thousands of feet; the intermediate hand in thousands of feet; and the longest hand in hundreds of feet.

This indicated altitude is correct, however, only when the sea level barometric pressure is standard (29.92 inches of mercury), the sea level free air temperature is standard (+15°C or 59°F), and the pressure and temperature decrease at a standard rate with an increase in altitude. Adjustments for nonstandard conditions are accomplished by setting the corrected pressure into a barometric scale located on the face of the altimeter. Only after the altimeter is set does it indicate the correct altitude.

## EFFECT OF NONSTANDARD PRESSURE AND TEMPERATURE

If no means were provided for adjusting altimeters to nonstandard pressure, flight could be hazardous. For example, if flying from a high-pressure area to a low-pressure area without adjusting the altimeter, the actual altitude of the airplane would be **LOWER** than the indicated altitude. An old saying, "HIGH TO LOW, LOOK OUT BELOW" is a way of remembering which condition is dangerous. When flying from a low-pressure area to a high-pressure area without adjusting the altimeter, the actual altitude of the airplane is **HIGHER** than the indicated altitude.

Figure 6-3 shows how variations in air temperature also affect the altimeter. On a warm day, a given mass of air expands to a larger volume than on a cold day, raising the pressure levels. For example, the pressure level where the altimeter indicates 5,000 feet is **HIGHER** on a warm day than under standard conditions. On a cold day, the reverse is true, and the pressure level where the altimeter indicates 5,000 feet is **LOWER**.

The adjustment to compensate for nonstandard pressure does not compensate for nonstandard temperature.

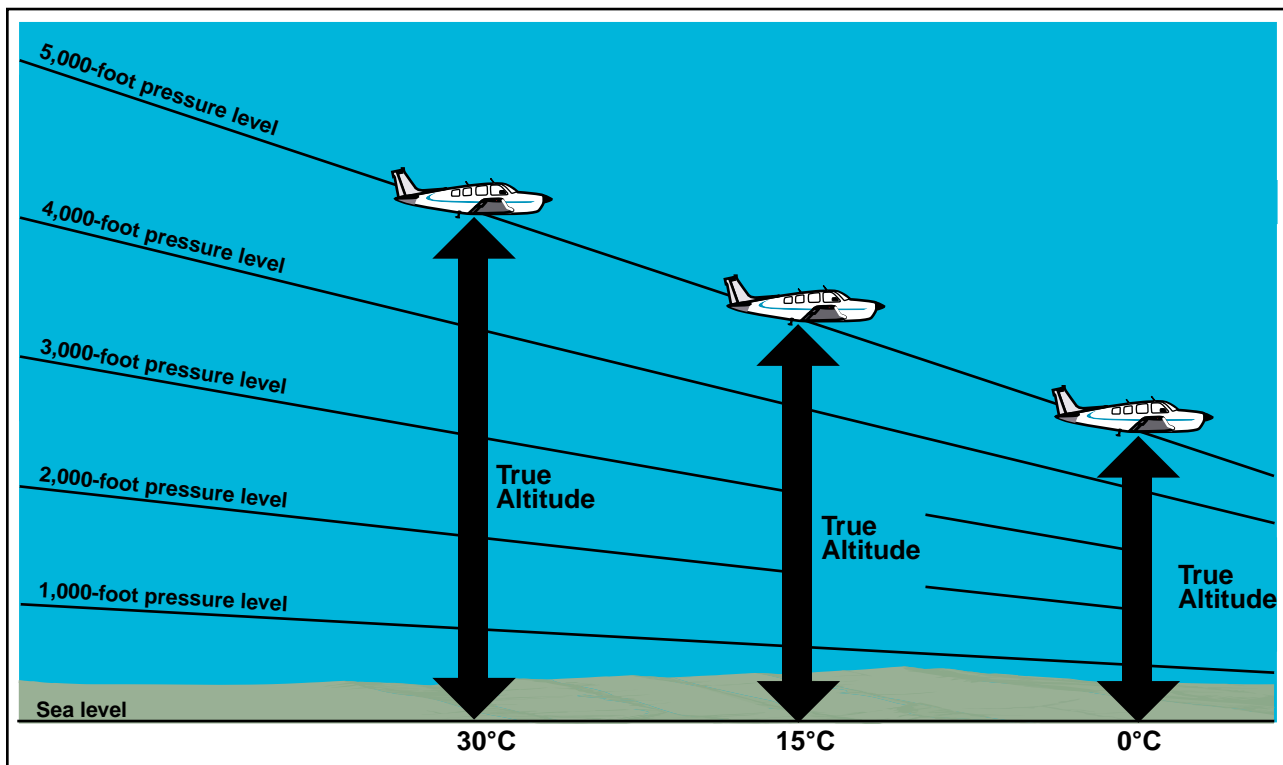

Figure 6-3. Effects of nonstandard temperature on an altimeter.

If terrain or obstacle clearance is a factor in selecting a cruising altitude, particularly at higher altitudes, remember to anticipate that a colder-than-standard temperature places the airplane **LOWER** than the altimeter indicates. Therefore, it is necessary to use a higher indicated altitude to provide adequate terrain clearance. Modify the memory aid to “**HIGH TO LOW OR HOT TO COLD, LOOK OUT BELOW.**”

### SETTING THE ALTIMETER

Most altimeters are equipped with a barometric pressure setting window (sometimes referred to as the Kollsman window) providing a means to adjust the altimeter. A knob is located at the bottom of the instrument for this adjustment.

To adjust the altimeter for variation in atmospheric pressure, the pressure scale in the altimeter setting window, calibrated in inches of mercury (in. Hg) and/or millibars (Mb), is adjusted to match the given altimeter setting. Altimeter setting is defined as station pressure reduced to sea level. However, an altimeter setting is accurate only in the vicinity of the reporting station. Therefore, the altimeter must be adjusted as the flight progresses from one station to the next.

Many pilots confidently expect that the current altimeter setting will compensate for irregularities in atmospheric pressure at all altitudes, but this is not always true. The altimeter setting broadcast by ground stations is the

station pressure corrected to mean sea level. It does not account for the irregularities at higher levels, particularly the effect of nonstandard temperature. However, if each pilot in a given area is using the same altimeter setting, each altimeter should be equally affected by temperature and pressure variation errors, making it possible to maintain the desired vertical separation between aircraft.

When flying over high, mountainous terrain, certain atmospheric conditions can cause the altimeter to indicate an altitude of 1,000 feet, or more, **HIGHER** than the actual altitude. For this reason, a generous margin of altitude should be allowed—not only for possible altimeter error, but also for possible downdrafts that might be associated with high winds.

To illustrate the use of the altimeter setting system, follow a flight from Dallas Love Field, Texas to Abilene Municipal Airport, Texas via Mineral Wells. Before taking off from Love Field, the pilot receives a current altimeter setting of 29.85 from the control tower or **automatic terminal information service (ATIS)**, and sets this value in the altimeter setting

**Automatic Terminal Information Service (ATIS)**—The continuous broadcast of recorded noncontrol information in selected terminal areas. Its purpose is to improve controller effectiveness and to relieve frequency congestion by automating the repetitive transmission of essential but routine information.

window. The altimeter indication should then be compared with the known airport elevation of 487 feet. Since most altimeters are not perfectly calibrated, an error may exist.

When over Mineral Wells, assume the pilot receives a current altimeter setting of 29.94 and sets this in the altimeter window. Before entering the traffic pattern at Abilene Municipal Airport, a new altimeter setting of 29.69 is received from the Abilene Control Tower, and set in the altimeter setting window. If the pilot desires to fly the traffic pattern at approximately 800 feet above the terrain, and the field elevation of Abilene is 1,791 feet, an indicated altitude of 2,600 feet should be maintained (1,791 feet + 800 feet = 2,591 feet rounded to 2,600 feet).

The importance of properly setting the altimeter cannot be overemphasized. Assume that the pilot did not adjust the altimeter at Abilene to the current setting, and continued using the Mineral Wells setting of 29.94. When entering the Abilene traffic pattern at an indicated altitude of 2,600 feet, the airplane would be approximately 250 feet below the proper traffic pattern altitude. Upon landing, the altimeter would indicate approximately 250 feet higher than the field elevation.

Altimeter setting	29.94
Current altimeter setting	<u>29.69</u>
Difference	.25

(Since 1 inch of pressure is equal to approximately 1,000 feet of altitude,  $.25 \times 1,000$  feet = 250 feet.)

When determining whether to add or subtract the amount of altimeter error, remember that, when the actual pressure is lower than what is set in the altimeter window, the actual altitude of the airplane will be lower than what is indicated on the altimeter.

## ALTIMETER OPERATION

There are two means by which the altimeter pointers can be moved. The first is a change in air pressure, while the other is an adjustment to the barometric scale. When the airplane climbs or descends, changing pressure within the altimeter case expands or contracts the aneroid barometer. This movement is transmitted through mechanical linkage to rotate the pointers. A decrease in pressure causes the altimeter to indicate an increase in altitude, and an increase in pressure causes the altimeter to indicate a decrease in altitude. Accordingly, if the airplane is flown from a pressure level of 28.75 in. Hg. to a pressure level of 29.75 in. Hg., the altimeter would show a decrease of approximately 1,000 feet in altitude.

The other method of moving the pointers does not rely on changing air pressure, but the mechanical construction of the altimeter. Do not be confused by the fact that as the barometric pressure scale is moved, the indicator needles move in the same direction, which is opposite to the reaction the pointers have when air pressure changes. To illustrate this point, suppose the pilot lands at an airport with an elevation of 1,000 feet and the altimeter is correctly set to the current sea level pressure of 30.00 in. Hg. While the airplane is parked on the ramp, the pressure decreases to 29.50. The altimeter senses this as a climb and now indicates 1,500 feet. When returning to the airplane, if the setting in the altimeter window is decreased to the current sea level pressure of 29.50, the indication will be reduced back down to 1,000 feet.

Knowing the airplane's altitude is vitally important to a pilot. The pilot must be sure that the airplane is flying high enough to clear the highest terrain or obstruction along the intended route. It is especially important to have accurate altitude information when visibility is restricted. To clear obstructions, the pilot must constantly be aware of the altitude of the airplane and the elevation of the surrounding terrain. To reduce the possibility of a midair collision, it is essential to maintain altitude in accordance with air traffic rules.

## TYPES OF ALTITUDE

Altitude is vertical distance above some point or level used as a reference. There are as many kinds of altitude as there are reference levels from which altitude is measured, and each may be used for specific reasons. Pilots are mainly concerned with five types of altitudes:

**Indicated Altitude**—That altitude read directly from the altimeter (uncorrected) when it is set to the current altimeter setting.

**True Altitude**—The vertical distance of the airplane above sea level—the actual altitude. It is often expressed as feet above mean sea level (MSL). Airport, terrain, and obstacle elevations on aeronautical charts are true altitudes.

**Absolute Altitude**—The vertical distance of an airplane above the terrain, or above ground level (AGL).

**Pressure Altitude**—The altitude indicated when the altimeter setting window (barometric scale) is adjusted to 29.92. This is the altitude above the standard datum plane, which is a theoretical plane where air pressure

(corrected to 15°C) equals 29.92 in. Hg. Pressure altitude is used to compute density altitude, true altitude, true airspeed, and other performance data.

**Density Altitude**—This altitude is pressure altitude corrected for variations from standard temperature. When conditions are standard, pressure altitude and density altitude are the same. If the temperature is above standard, the density altitude is higher than pressure altitude. If the temperature is below standard, the density altitude is lower than pressure altitude. This is an important altitude because it is directly related to the airplane's performance.

As an example, consider an airport with a field elevation of 5,048 feet MSL where the standard temperature is 5°C. Under these conditions, pressure altitude and density altitude are the same—5,048 feet. If the temperature changes to 30°C, the density altitude increases to 7,855 feet. This means an airplane would perform on takeoff as though the field elevation were 7,855 feet at standard temperature. Conversely, a temperature of -25°C would result in a density altitude of 1,232 feet. An airplane would have much better performance under these conditions.

**Instrument Check**—To determine the condition of an altimeter, set the barometric scale to the altimeter setting transmitted by the local automated flight service station (AFSS) or any other reliable source. The altimeter pointers should indicate the surveyed elevation of the airport. If the indication is off more than 75 feet from the surveyed elevation, the instrument should be referred to a certificated instrument repair station for recalibration.

## VERTICAL SPEED INDICATOR

The vertical speed indicator (VSI), which is sometimes called a vertical velocity indicator (VVI), indicates whether the airplane is climbing, descending, or in level flight. The rate of climb or descent is indicated in feet per minute. If properly calibrated, the VSI indicates zero in level flight. [Figure 6-4]

### PRINCIPLE OF OPERATION

Although the vertical speed indicator operates solely from static pressure, it is a differential pressure instrument. It contains a diaphragm with connecting linkage and gearing to the indicator pointer inside an airtight case. The inside of the diaphragm is connected directly to the static line of the pitot-static system. The area outside the diaphragm, which is inside the instrument case, is also connected to the static line, but through a restricted orifice (calibrated leak).

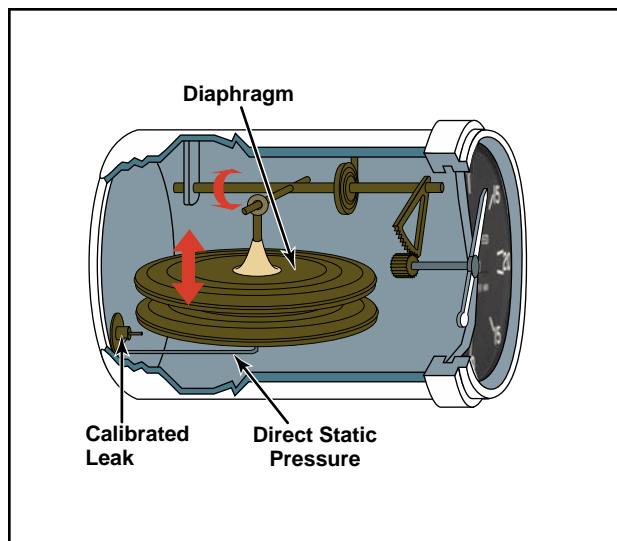

Figure 6-4. Vertical speed indicator.

Both the diaphragm and the case receive air from the static line at existing atmospheric pressure. When the airplane is on the ground or in level flight, the pressures inside the diaphragm and the instrument case remain the same and the pointer is at the zero indication. When the airplane climbs or descends, the pressure inside the diaphragm changes immediately, but due to the metering action of the restricted passage, the case pressure remains higher or lower for a short time, causing the diaphragm to contract or expand. This causes a pressure differential that is indicated on the instrument needle as a climb or descent. When the pressure differential stabilizes at a definite ratio, the needle indicates the rate of altitude change.

The vertical speed indicator is capable of displaying two different types of information:

- Trend information shows an immediate indication of an increase or decrease in the airplane's rate of climb or descent.
- Rate information shows a stabilized rate of change in altitude.

For example, if maintaining a steady 500-foot per minute (f.p.m.) climb, and the nose is lowered slightly, the VSI immediately senses this change and indicates a decrease in the rate of climb. This first indication is called the trend. After a short time, the VSI needle stabilizes on the new rate of climb, which in this example, is something less than 500 f.p.m. The time from the initial change in the rate of climb, until the VSI displays an accurate indication of the new rate, is called the lag. Rough control technique and turbulence can extend the lag period and cause erratic and unstable rate indications. Some airplanes are

equipped with an instantaneous vertical speed indicator (IVSI), which incorporates accelerometers to compensate for the lag in the typical VSI. [Figure 6-5]

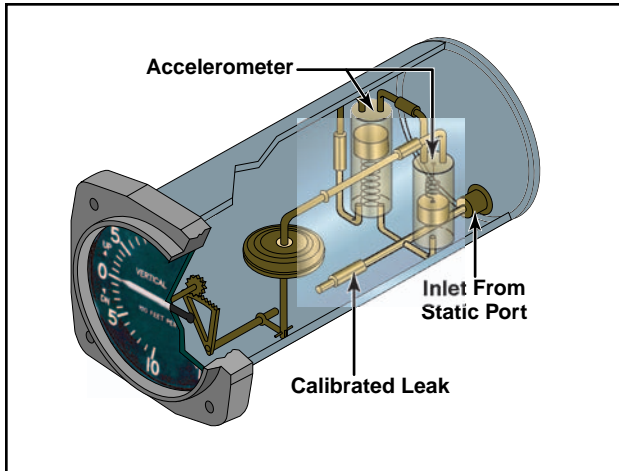

Figure 6-5. An instantaneous vertical speed indicator incorporates accelerometers to help the instrument immediately indicate changes in vertical speed.

**Instrument Check**—To verify proper operation, make sure the VSI is indicating near zero prior to takeoff. After takeoff, it should indicate a positive rate of climb.

## AIRSPEED INDICATOR

The airspeed indicator is a sensitive, differential pressure gauge which measures and shows promptly the difference between pitot or impact pressure, and static pressure, the undisturbed atmospheric pressure at level flight. These two pressures will be equal when the airplane is parked on the ground in calm air. When the airplane moves through the air, the pressure on the pitot line becomes greater than the pressure in the static lines. This difference in pressure is registered by the airspeed pointer on the face of the instrument, which is calibrated in miles per hour, **knots**, or both. [Figure 6-6]

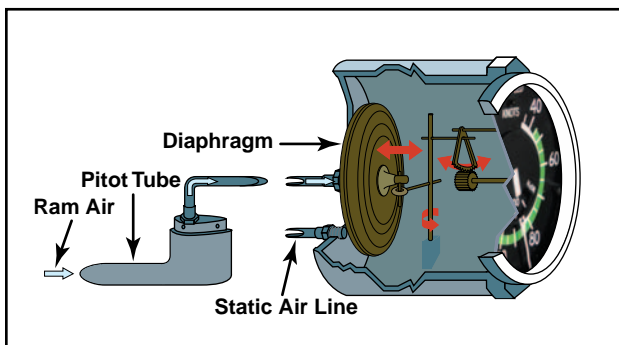

Figure 6-6. Airspeed indicator.

**Knots**—Nautical miles per hour.

Pilots should understand the following speeds:

**Indicated Airspeed (IAS)**—The direct instrument reading obtained from the airspeed indicator, uncorrected for variations in atmospheric density, installation error, or instrument error. Manufacturers use this airspeed as the basis for determining airplane performance. Takeoff, landing, and stall speeds listed in the AFM or POH are indicated airspeeds and do not normally vary with altitude or temperature.

**Calibrated Airspeed (CAS)**—Indicated airspeed corrected for installation error and instrument error. Although manufacturers attempt to keep airspeed errors to a minimum, it is not possible to eliminate all errors throughout the airspeed operating range. At certain airspeeds and with certain flap settings, the installation and instrument errors may total several knots. This error is generally greatest at low airspeeds. In the cruising and higher airspeed ranges, indicated airspeed and calibrated airspeed are approximately the same. Refer to the airspeed calibration chart to correct for possible airspeed errors.

**True Airspeed (TAS)**—Calibrated airspeed corrected for altitude and nonstandard temperature. Because air density decreases with an increase in altitude, an airplane has to be flown faster at higher altitudes to cause the same pressure difference between pitot impact pressure and static pressure. Therefore, for a given calibrated airspeed, true airspeed increases as altitude increases; or for a given true airspeed, calibrated airspeed decreases as altitude increases.

A pilot can find true airspeed by two methods. The most accurate method is to use a flight computer. With this method, the calibrated airspeed is corrected for temperature and pressure variation by using the airspeed correction scale on the computer. Extremely accurate electronic flight computers are also available. Just enter the CAS, pressure altitude, and temperature and the computer calculates the true airspeed.

A second method, which is a “rule of thumb,” will provide the approximate true airspeed. Simply add 2 percent to the calibrated airspeed for each 1,000 feet of altitude.

**Groundspeed (GS)**—The actual speed of the airplane over the ground. It is true airspeed adjusted for wind. Groundspeed decreases with a headwind, and increases with a tailwind.

## AIRSPEED INDICATOR MARKINGS

Airplanes weighing 12,500 pounds or less, manufactured after 1945, and certificated by the FAA, are required to have airspeed indicators marked in accordance with a standard color-coded marking

system. This system of color-coded markings enables a pilot to determine at a glance certain airspeed limitations that are important to the safe operation of the airplane. For example, if during the execution of a maneuver, it is noted that the airspeed needle is in the yellow arc and rapidly approaching the red line, the immediate reaction should be to reduce airspeed.

As shown in figure 6-7, airspeed indicators on single-engine small airplanes include the following standard color-coded markings:

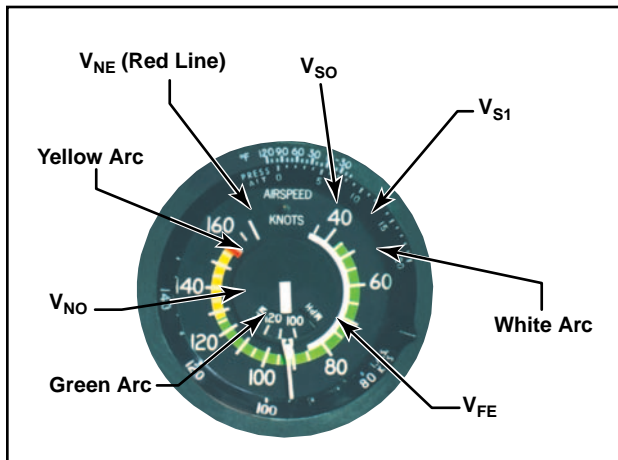

**Figure 6-7.** In addition to delineating various speed ranges, the boundaries of the color-coded arcs also identify airspeed limitations.

- White arc—This arc is commonly referred to as the flap operating range since its lower limit represents the full flap stall speed and its upper limit provides the maximum flap speed. Approaches and landings are usually flown at speeds within the white arc.
- Lower limit of white arc ( $V_{S0}$ )—The stalling speed or the minimum steady flight speed in the landing configuration. In small airplanes, this is the power-off stall speed at the maximum landing weight in the landing configuration (gear and flaps down).
- Upper limit of the white arc ( $V_{FE}$ )—The maximum speed with the flaps extended.
- Green arc—This is the normal operating range of the airplane. Most flying occurs within this range.
- Lower limit of green arc ( $V_{S1}$ )—The stalling speed or the minimum steady flight speed obtained in a specified configuration. For most airplanes, this is the power-off stall speed at the maximum takeoff weight in the clean configuration (gear up, if retractable, and flaps up).

- Upper limit of green arc ( $V_{NO}$ )—The maximum structural cruising speed. Do not exceed this speed except in smooth air.
- Yellow arc—Caution range. Fly within this range only in smooth air, and then, only with caution.
- Red line ( $V_{NE}$ )—Never-exceed speed. Operating above this speed is prohibited since it may result in damage or structural failure.

## OTHER AIRSPEED LIMITATIONS

Some important airspeed limitations are not marked on the face of the airspeed indicator, but are found on placards and in the AFM or POH. These airspeeds include:

- Design maneuvering speed ( $V_A$ )—This is the “rough air” speed and the maximum speed for abrupt maneuvers. If during flight, rough air or severe turbulence is encountered, reduce the airspeed to maneuvering speed or less to minimize stress on the airplane structure. It is important to consider weight when referencing this speed. For example,  $V_A$  may be 100 knots when an airplane is heavily loaded, but only 90 knots when the load is light.
- Landing gear operating speed ( $V_{LO}$ )—The maximum speed for extending or retracting the landing gear if using an airplane equipped with retractable landing gear.
- Landing gear extended speed ( $V_{LE}$ )—The maximum speed at which an airplane can be safely flown with the landing gear extended.
- Best angle-of-climb speed ( $V_X$ )—The airspeed at which an airplane gains the greatest amount of altitude in a given distance. It is used during a short-field takeoff to clear an obstacle.
- Best rate-of-climb speed ( $V_Y$ )—This airspeed provides the most altitude gain in a given period of time.
- Minimum control speed ( $V_{MC}$ )—This is the minimum flight speed at which a light, twin-engine airplane can be satisfactorily controlled when an engine suddenly becomes inoperative and the remaining engine is at takeoff power.
- Best rate of climb with one engine inoperative ( $V_{YSE}$ )—This airspeed provides the most altitude gain in a given period of time in a light, twin-engine airplane following an engine failure.

**Instrument Check**—Prior to takeoff, the airspeed indicator should read zero. However, if there is a strong wind blowing directly into the pitot tube, the airspeed

indicator may read higher than zero. When beginning the takeoff, make sure the airspeed is increasing at an appropriate rate.

### BLOCKAGE OF THE PITOT-STATIC SYSTEM

Errors almost always indicate blockage of the pitot tube, the static port(s), or both. Blockage may be caused by moisture (including ice), dirt, or even insects. During pre-flight, make sure the pitot tube cover is removed. Then, check the pitot and static port openings. A blocked pitot tube affects the accuracy of only the airspeed indicator. However, a blockage of the static system not only affects the airspeed indicator, but can also cause errors in the altimeter and vertical speed indicator.

### BLOCKED PITOT SYSTEM

The pitot system can become blocked completely or only partially if the pitot tube drain hole remains open. If the pitot tube becomes blocked and its associated drain hole remains clear, ram air no longer is able to enter the pitot system. Air already in the system will vent through the drain hole, and the remaining pressure will drop to ambient (outside) air pressure. Under these circumstances, the airspeed indicator reading decreases to zero, because the airspeed indicator senses no difference between ram and static air pressure. The airspeed indicator acts as if the airplane were stationary on the ramp. The apparent loss of airspeed is not usually instantaneous. Instead, the airspeed will drop toward zero. [Figure 6-8]

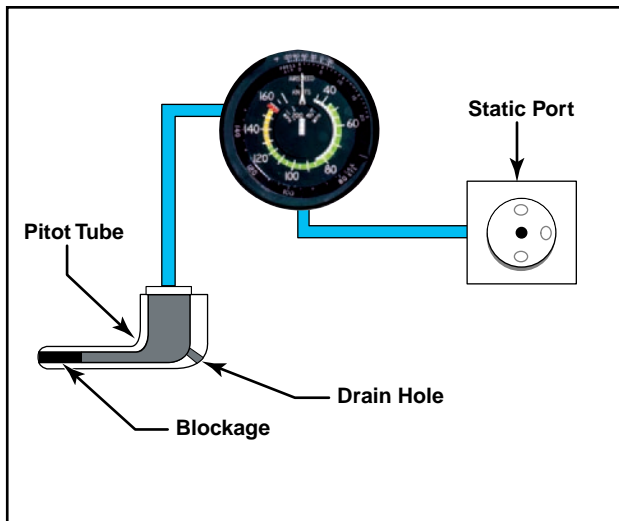

Figure 6-8. A blocked pitot tube, but clear drain hole.

If the pitot tube, drain hole, and static system all become blocked in flight, changes in airspeed will not be indicated, due to the trapped pressures. However, if the static system remains clear, the airspeed indicator acts as an altimeter. An apparent increase in the ram air pressure relative to static pressure occurs as altitude increases above the level where the pitot tube and drain hole became blocked. This pressure differential causes

the airspeed indicator to show an increase in speed. A decrease in indicated airspeed occurs as the airplane descends below the altitude at which the pitot system became blocked. [Figure 6-9]

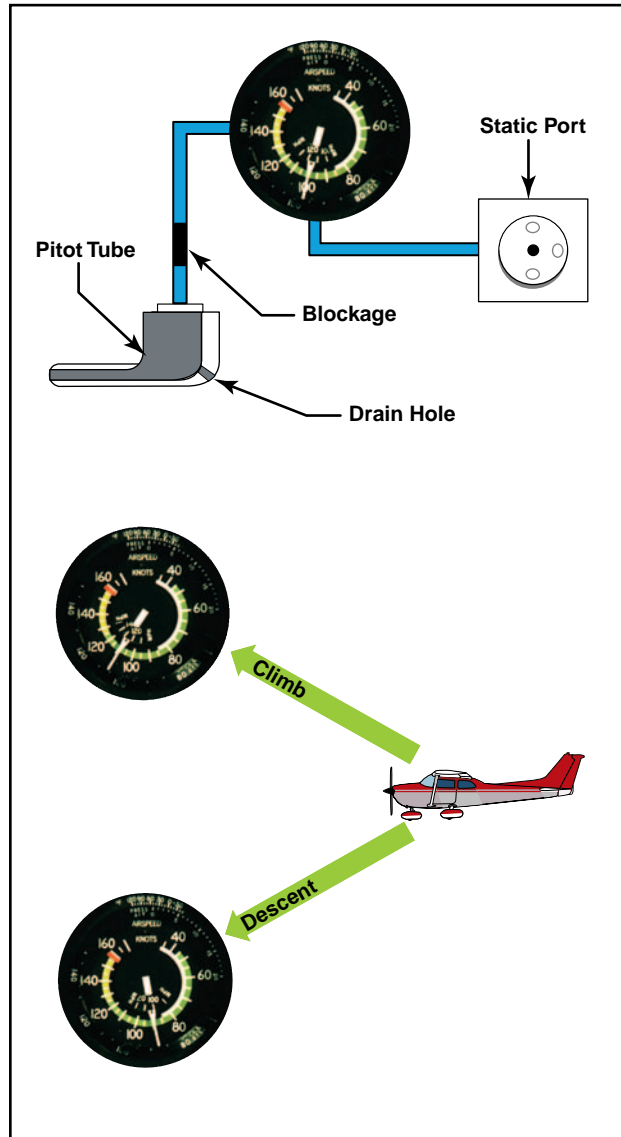

Figure 6-9. Blocked pitot system with clear static system.

The pitot tube may become blocked during flight through visible moisture. Some airplanes may be equipped with pitot heat for flight in visible moisture. Consult the AFM or POH for specific procedures regarding the use of pitot heat.

### BLOCKED STATIC SYSTEM

If the static system becomes blocked but the pitot tube remains clear, the airspeed indicator continues to operate; however, it is inaccurate. Airspeed indications are slower than the actual speed when the airplane is operated above the altitude where the static ports became blocked, because the trapped static pressure is higher than normal for that altitude. When operating at

a lower altitude, a faster than actual airspeed is displayed due to the relatively low static pressure trapped in the system.

A blockage of the static system also affects the altimeter and VSI. Trapped static pressure causes the altimeter to freeze at the altitude where the blockage occurred. In the case of the VSI, a blocked static system produces a continuous zero indication. [Figure 6-10]

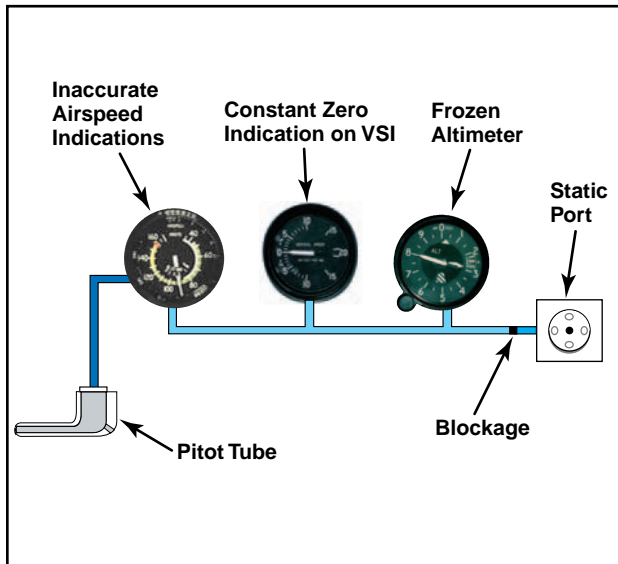

Figure 6-10. Blocked static system.

## GYROSCOPIC FLIGHT INSTRUMENTS

Several flight instruments utilize the properties of a gyroscope for their operation. The most common instruments containing gyroscopes are the turn coordinator, heading indicator, and the attitude indicator. To understand how these instruments operate requires knowledge of the instrument power systems, gyroscopic principles, and the operating principles of each instrument.

## GYROSCOPIC PRINCIPLES

Any spinning object exhibits gyroscopic properties. A wheel or rotor designed and mounted to utilize these properties is called a gyroscope. Two important design characteristics of an instrument gyro are great weight for its size, or high density, and rotation at high speed with low friction bearings.

There are two general types of mountings; the type used depends upon which property of the gyro is utilized. A freely or universally mounted gyroscope is free to rotate in any direction about its center of gravity. Such a wheel is said to have three planes of freedom. The wheel or rotor is free to rotate in any plane in relation to the base and is so balanced that with the gyro wheel at rest, it will remain in the position in which it is placed. Restricted or

semirigidly mounted gyroscopes are those mounted so that one of the planes of freedom is held fixed in relation to the base.

There are two fundamental properties of gyroscopic action—rigidity in space and precession.

## RIGIDITY IN SPACE

Rigidity in space refers to the principle that a gyroscope remains in a fixed position in the plane in which it is spinning. By mounting this wheel, or gyroscope, on a set of **gimbal rings**, the gyro is able to rotate freely in any direction. Thus, if the gimbal rings are tilted, twisted, or otherwise moved, the gyro remains in the plane in which it was originally spinning. [Figure 6-11]

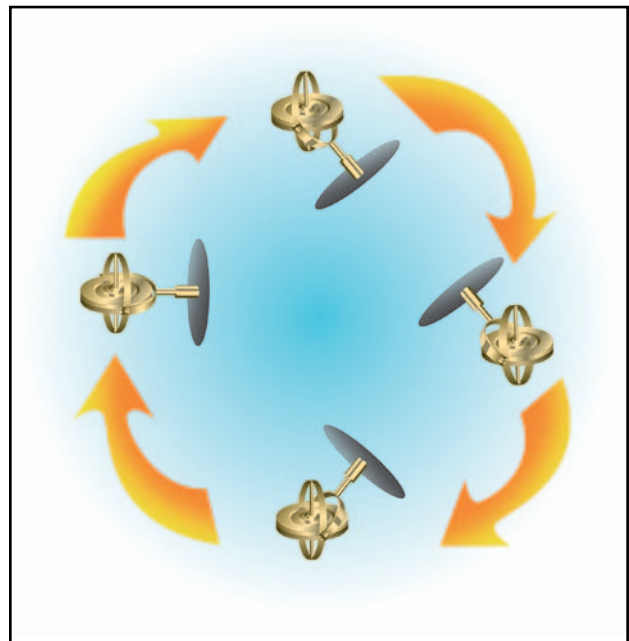

Figure 6-11. Regardless of the position of its base, a gyro tends to remain rigid in space, with its axis of rotation pointed in a constant direction.

## PRECESSION

Precession is the tilting or turning of a gyro in response to a deflective force. The reaction to this force does not occur at the point where it was applied; rather, it occurs at a point that is 90° later in the direction of rotation. This principle allows the gyro to determine a rate of turn by sensing the amount of pressure created by a change in direction. The rate at which the gyro precesses is inversely proportional to the speed of the rotor and proportional to the deflective force.

**Gimbal Ring**—A type of support that allows an object, such as a gyroscope, to remain in an upright condition when its base is tilted.



Precession can also create some minor errors in some instruments. [Figure 6-12]

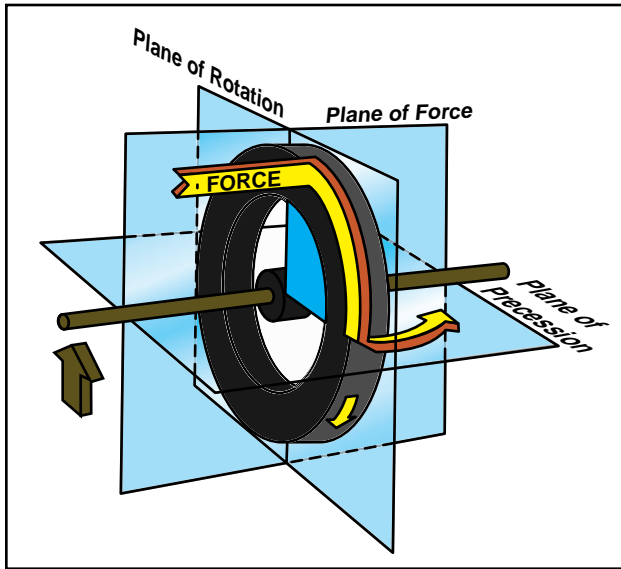

Figure 6-12. Precession of a gyroscope resulting from an applied deflective force.

### SOURCES OF POWER

In some airplanes, all the gyros are vacuum, pressure, or electrically operated; in others, vacuum or pressure systems provide the power for the heading and attitude indicators, while the electrical system provides the power for the turn coordinator. Most airplanes have at least two sources of power to ensure at least one source of bank information if one power source fails.

The vacuum or pressure system spins the gyro by drawing a stream of air against the rotor vanes to spin the rotor at high speed, much like the operation of a waterwheel or turbine. The amount of vacuum or

pressure required for instrument operation varies, but is usually between 4.5 and 5.5 in. Hg.

One source of vacuum for the gyros is a vane-type engine-driven pump that is mounted on the accessory case of the engine. Pump capacity varies in different airplanes, depending on the number of gyros.

A typical vacuum system consists of an engine-driven vacuum pump, relief valve, air filter, gauge, and tubing necessary to complete the connections. The gauge is mounted in the airplane's instrument panel and indicates the amount of pressure in the system (vacuum is measured in inches of mercury less than ambient pressure).

As shown in figure 6-13, air is drawn into the vacuum system by the engine-driven vacuum pump. It first goes through a filter, which prevents foreign matter from entering the vacuum or pressure system. The air then moves through the attitude and heading indicators, where it causes the gyros to spin. A relief valve prevents the vacuum pressure, or suction, from exceeding prescribed limits. After that, the air is expelled overboard or used in other systems, such as for inflating pneumatic deicing boots.

It is important to monitor vacuum pressure during flight, because the attitude and heading indicators may not provide reliable information when suction pressure is low. The vacuum, or suction, gauge generally is marked to indicate the normal range. Some airplanes are equipped with a warning light that illuminates when the vacuum pressure drops below the acceptable level.

### TURN INDICATORS

Airplanes use two types of turn indicators—the turn-and-slip indicator and the turn coordinator. Because of

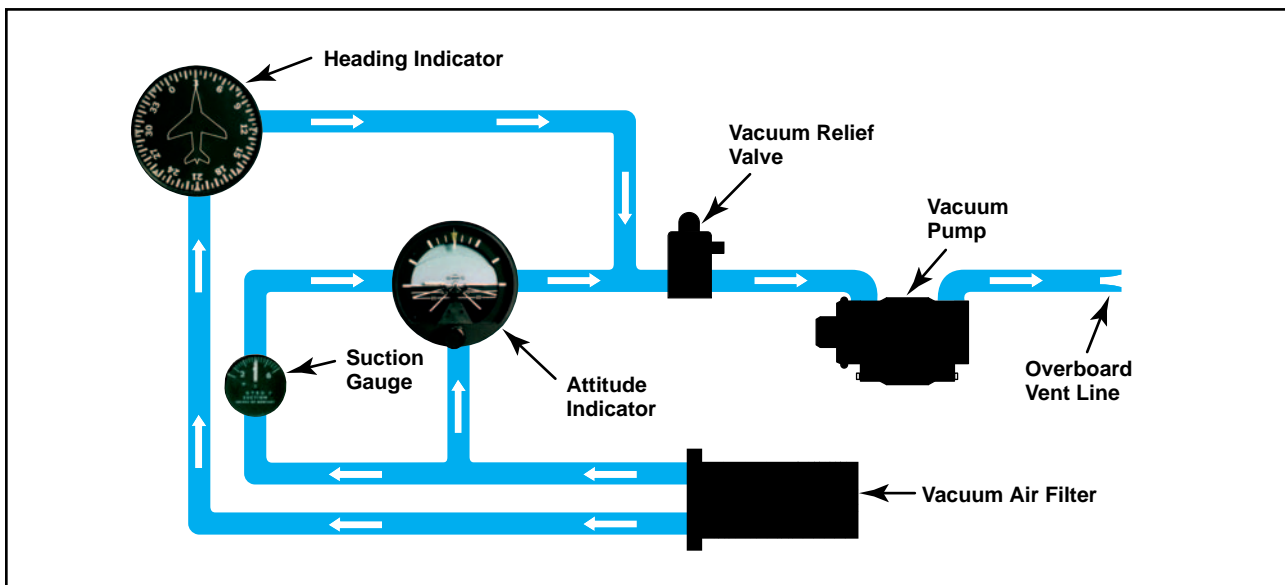

Figure 6-13. Typical Vacuum System.

the way the gyro is mounted, the turn-and-slip indicator only shows the rate of turn in degrees per second. Because the gyro on the turn coordinator is set at an angle, or canted, it can initially also show roll rate. Once the roll stabilizes, it indicates rate of turn. Both instruments indicate turn direction and quality (coordination), and also serve as a backup source of bank information in the event an attitude indicator fails. Coordination is achieved by referring to the **inclinometer**, which consists of a liquid-filled curved tube with a ball inside. [Figure 6-14]

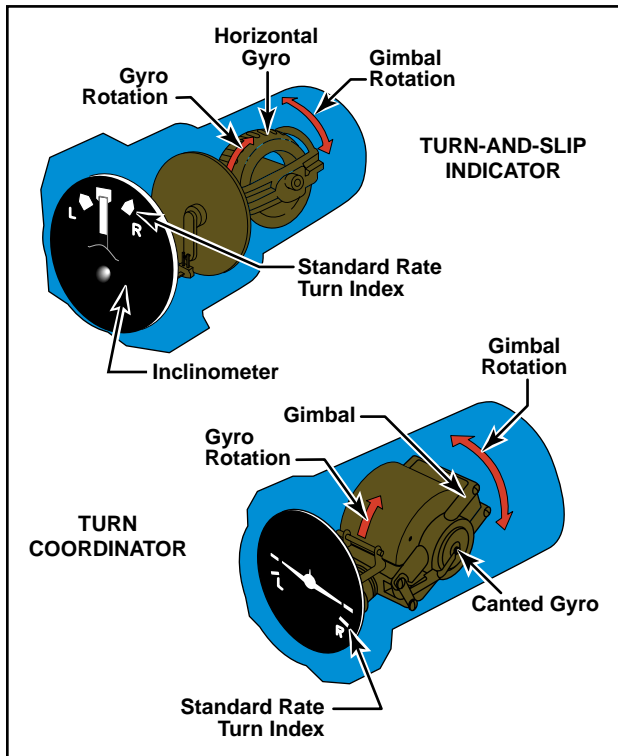

Figure 6-14. Turn indicators rely on controlled precession for their operation.

### TURN-AND-SLIP INDICATOR

The gyro in the turn-and-slip indicator rotates in the vertical plane, corresponding to the airplane's longitudinal axis. A single gimbal limits the planes in which the gyro can tilt, and a spring tries to return it to center. Because of precession, a yawing force causes the gyro to tilt left or right as viewed from the pilot seat. The turn-and-slip indicator uses a pointer, called the turn needle, to show the direction and rate of turn.

### TURN COORDINATOR

The gimbal in the turn coordinator is canted; therefore, its gyro can sense both rate of roll and rate of turn. Since turn coordinators are more prevalent in training

**Inclinometer**—An instrument consisting of a curved glass tube, housing a glass ball, and damped with a fluid similar to kerosene. It may be used to indicate inclination, as a level, or, as used in the turn indicators, to show the relationship between gravity and centrifugal force in a turn.

airplanes, this discussion concentrates on that instrument. When rolling into or out of a turn, the miniature airplane banks in the direction the airplane is rolled. A rapid roll rate causes the miniature airplane to bank more steeply than a slow roll rate.

The turn coordinator can be used to establish and maintain a **standard-rate-turn** by aligning the wing of the miniature airplane with the turn index. The turn coordinator indicates only the rate and direction of turn; it does not display a specific angle of bank.

### INCLINOMETER

The inclinometer is used to depict airplane yaw, which is the side-to-side movement of the airplane's nose. During coordinated, straight-and-level flight, the force of gravity causes the ball to rest in the lowest part of the tube, centered between the reference lines. Coordinated flight is maintained by keeping the ball centered. If the ball is not centered, it can be centered by using the rudder. To do this, apply rudder pressure on the side where the ball is deflected. Use the simple rule, "step on the ball," to remember which rudder pedal to press.

If aileron and rudder are coordinated during a turn, the ball remains centered in the tube. If aerodynamic forces are unbalanced, the ball moves away from the center of the tube. As shown in figure 6-15, in a slip, the rate of

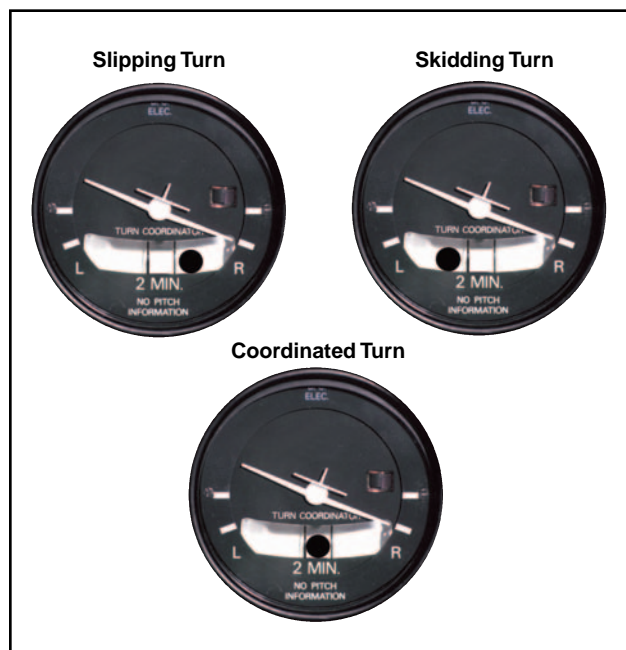

Figure 6-15. If inadequate right rudder is applied in a right turn, a slip results. Too much right rudder causes the airplane to skid through the turn. Centering the ball results in a coordinated turn.

**Standard-Rate-Turn**—A turn of 3° per second. A complete 360° turn takes 2 minutes. A rule of thumb for determining the approximate bank angle required for a standard-rate turn is to divide the true airspeed by 10 and add one-half the result. For example, at 120 knots, approximately 18° of bank is required (120 ÷ 10 = 12 + 6 = 18). At 200 knots, it would take approximately 30° of bank for a standard-rate-turn.

turn is too slow for the angle of bank, and the ball moves to the inside of the turn. In a skid, the rate of turn is too great for the angle of bank, and the ball moves to the outside of the turn. To correct for these conditions, and improve the quality of the turn, remember to “step on the ball.” Varying the angle of bank can also help restore coordinated flight from a slip or skid. To correct for a slip, decrease bank and/or increase the rate of turn. To correct for a skid, increase the bank and/or decrease the rate of turn.

**Instrument Check**—During the preflight, check to see that the inclinometer is full of fluid and has no air bubbles. The ball should also be resting at its lowest point. When taxiing, the turn coordinator should indicate a turn in the correct direction.

### THE ATTITUDE INDICATOR

The attitude indicator, with its miniature airplane and horizon bar, displays a picture of the attitude of the airplane. The relationship of the miniature airplane to the horizon bar is the same as the relationship of the real airplane to the actual horizon. The instrument gives an instantaneous indication of even the smallest changes in attitude.

The gyro in the attitude indicator is mounted on a horizontal plane and depends upon rigidity in space for its operation. The horizon bar represents the true horizon. This bar is fixed to the gyro and remains in a horizontal plane as the airplane is pitched or banked about its lateral or longitudinal axis, indicating the attitude of the airplane relative to the true horizon. [Figure 6-16]

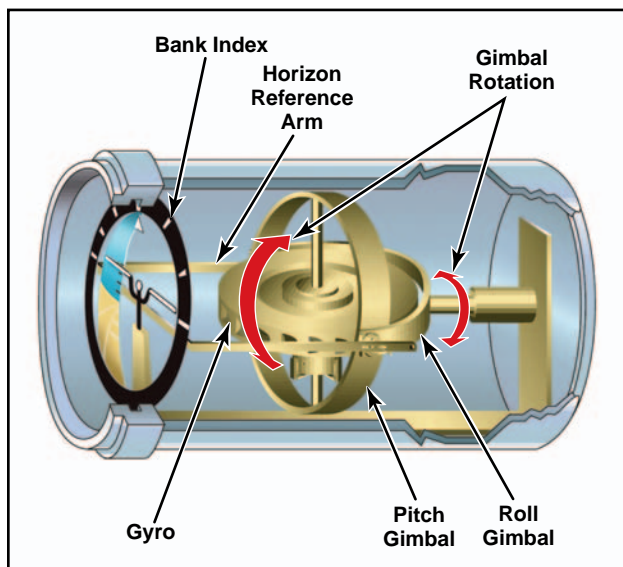

Figure 6-16. Attitude indicator.

An adjustment knob is provided with which the pilot may move the miniature airplane up or down to align the miniature airplane with the horizon bar to suit the pilot’s line of vision. Normally, the miniature airplane

is adjusted so that the wings overlap the horizon bar when the airplane is in straight-and-level cruising flight.

The pitch and bank limits depend upon the make and model of the instrument. Limits in the banking plane are usually from 100° to 110°, and the pitch limits are usually from 60° to 70°. If either limit is exceeded, the instrument will tumble or spill and will give incorrect indications until restabilized. A number of modern attitude indicators will not tumble.

Every pilot should be able to interpret the banking scale illustrated in figure 6-17. Most banking scale indicators on the top of the instrument move in the same direction from that in which the airplane is actually banked. Some other models move in the opposite direction from that in which the airplane is actually banked. This may confuse the pilot if the indicator is used to determine the direction of bank. This scale should be used only to control the degree of desired bank. The relationship of the miniature airplane to the horizon bar should be used for an indication of the direction of bank.

The attitude indicator is reliable and the most realistic flight instrument on the instrument panel. Its indications are very close approximations of the actual attitude of the airplane.

### HEADING INDICATOR

The heading indicator (or directional gyro) is fundamentally a mechanical instrument designed to facilitate the use of the magnetic compass. Errors in the magnetic compass are numerous, making straight flight and precision turns to headings difficult to accomplish, particularly in turbulent air. A heading indicator, however, is not affected by the forces that make the magnetic compass difficult to interpret. [Figure 6-18]

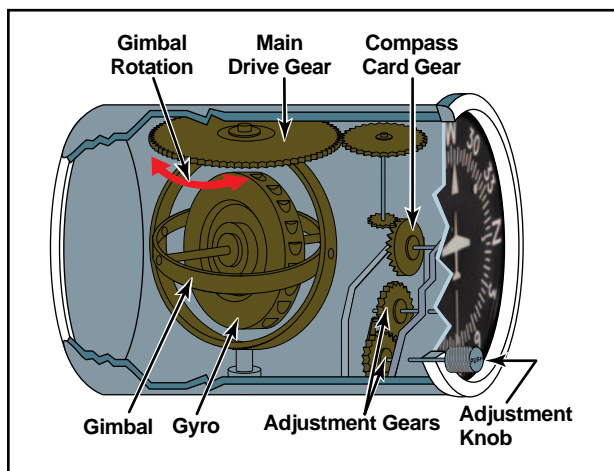

Figure 6-18. A heading indicator displays headings based on a 360° azimuth, with the final zero omitted. For example, a 6 represents 060°, while a 21 indicates 210°. The adjustment knob is used to align the heading indicator with the magnetic compass.

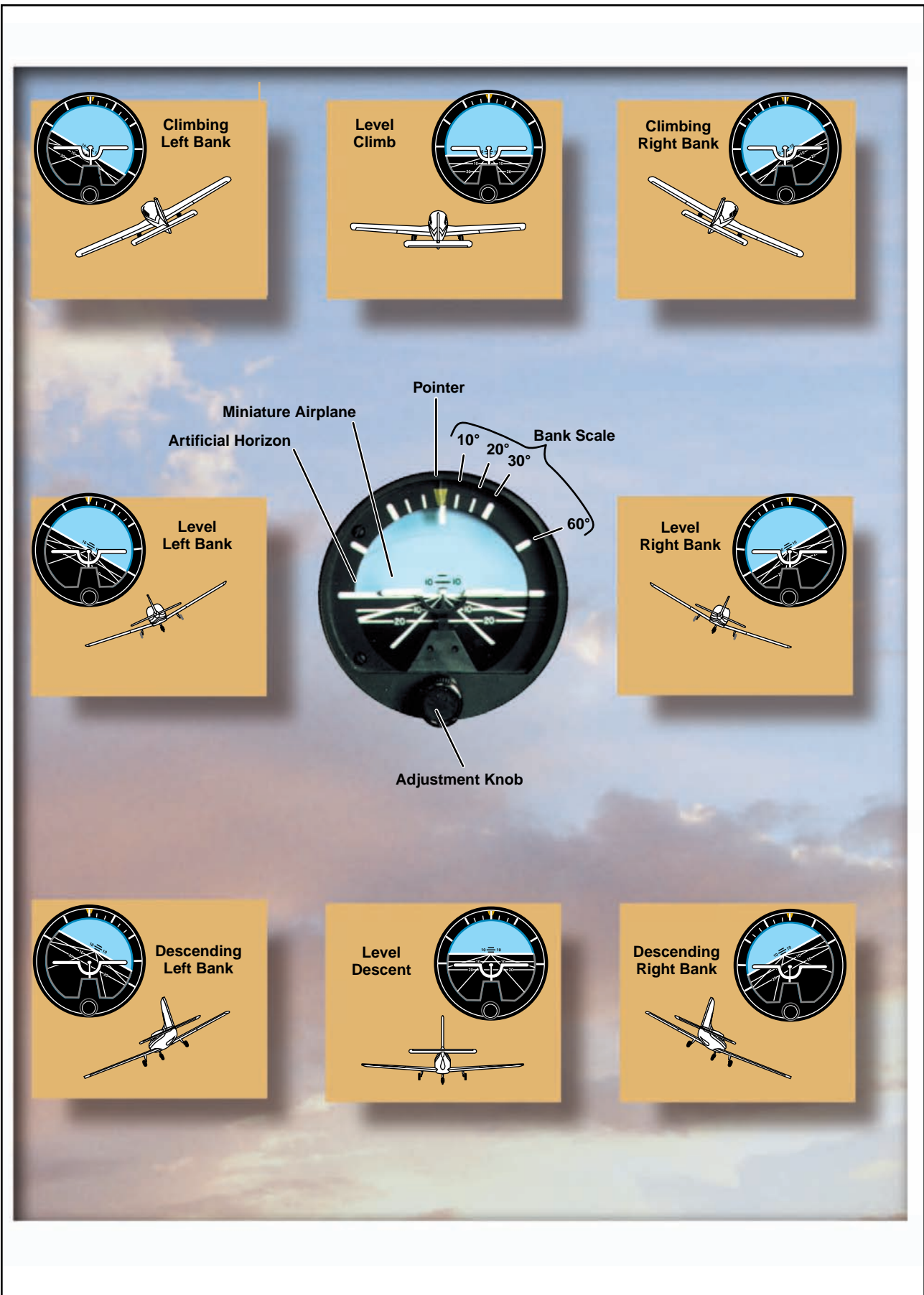

Figure 6-17. Attitude representation by the attitude indicator corresponds to that of the airplane to the real horizon.

The operation of the heading indicator depends upon the principle of rigidity in space. The rotor turns in a vertical plane, and fixed to the rotor is a compass card. Since the rotor remains rigid in space, the points on the card hold the same position in space relative to the vertical plane. As the instrument case and the airplane revolve around the vertical axis, the card provides clear and accurate heading information.

Because of precession, caused by friction, the heading indicator will creep or drift from a heading to which it is set. Among other factors, the amount of drift depends largely upon the condition of the instrument. If the bearings are worn, dirty, or improperly lubricated, the drift may be excessive. Another error in the heading indicator is caused by the fact that the gyro is oriented in space, and the earth rotates in space at a rate of 15° in 1 hour. Thus, discounting precession caused by friction, the heading indicator may indicate as much as 15° error per every hour of operation.

Some heading indicators receive a magnetic north reference from a magnetic slaving transmitter, and generally need no adjustment. Heading indicators that do not have this automatic north-seeking capability are called “free” gyros, and require periodic adjustment. It is important to check the indications frequently (approximately every 15 minutes) and reset the heading indicator to align it with the magnetic compass when required. Adjust the heading indicator to the magnetic compass heading when the airplane is straight and level at a constant speed to avoid compass errors.

The bank and pitch limits of the heading indicator vary with the particular design and make of instrument. On some heading indicators found in light airplanes, the limits are approximately 55° of pitch and 55° of bank. When either of these attitude limits is exceeded, the instrument “tumbles” or “spills” and no longer gives the correct indication until reset. After spilling, it may be reset with the caging knob. Many of the modern instruments used are designed in such a manner that they will not tumble.

**Instrument Check**—As the gyro spools up, make sure there are no abnormal sounds. While taxiing, the instrument should indicate turns in the correct direction, and precession should not be abnormal. At idle power settings, the gyroscopic instruments using the vacuum system might not be up to operating speeds and precession might occur more rapidly than during flight.

## MAGNETIC COMPASS

Since the magnetic compass works on the principle of magnetism, it is well for the pilot to have at least a basic understanding of magnetism. A simple bar magnet has two centers of magnetism which are called poles. Lines

of magnetic force flow out from each pole in all directions, eventually bending around and returning to the other pole. The area through which these lines of force flow is called the field of the magnet. For the purpose of this discussion, the poles are designated “north” and “south.” If two bar magnets are placed near each other, the north pole of one will attract the south pole of the other. There is evidence that there is a magnetic field surrounding the Earth, and this theory is applied in the design of the magnetic compass. It acts very much as though there were a huge bar magnet running along the axis of the Earth which ends several hundred miles below the surface. [Figure 6-19]

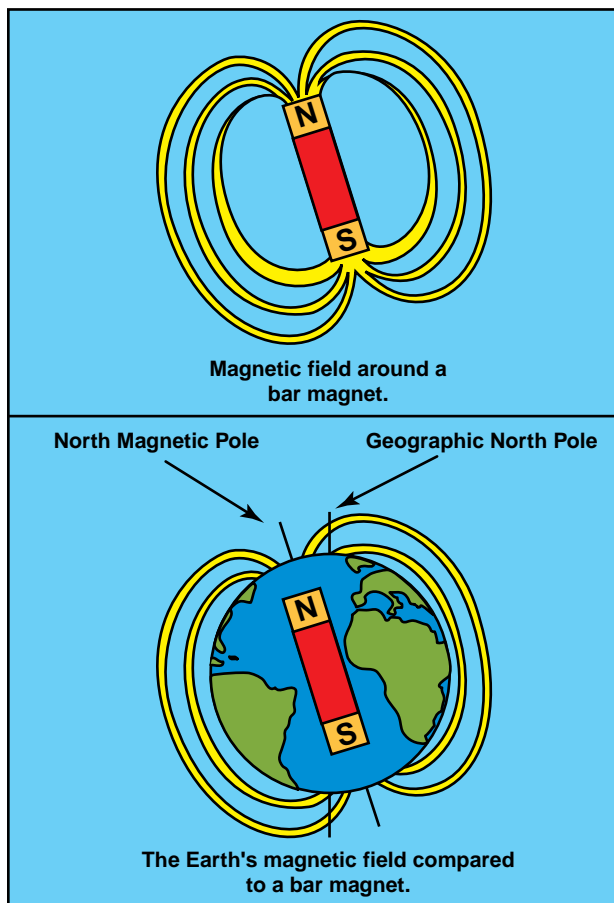

Figure 6-19. Earth's magnetic field.

The geographic north and south poles form the axis for the Earth's rotation. These positions are also referred to as true north and south. Another axis is formed by the magnetic north and south poles. Lines of magnetic force flow out from each pole in all directions, and eventually return to the opposite pole. A compass aligns itself with the magnetic axis formed by the north/south magnetic field of the Earth.

The lines of force have a vertical component (or pull) which is zero at the Equator, but builds to 100 percent of the total force at the magnetic poles. If magnetic needles, such as in the airplane's magnetic compass, are held along these lines of force, the vertical component

causes one end of the needle to dip or deflect downward. The amount of dip increases as the needles are moved closer and closer to the poles. It is this deflection, or dip, that causes some of the larger compass errors.

The magnetic compass, which is usually the only direction-seeking instrument in the airplane, is simple in construction. It contains two steel magnetized needles fastened to a float, around which is mounted a compass card. The needles are parallel, with their north-seeking ends pointing in the same direction. The compass card has letters for cardinal headings, and each 30° interval is represented by a number, the last zero of which is omitted. For example, 30° appears as a 3 and 300° appears as a 30. Between these numbers, the card is graduated for each 5°. The magnetic compass is required equipment in all airplanes. It is used to set the gyroscopic heading indicator, correct for precession, and as a backup in the event the heading indicator(s) fails. [Figure 6-20]

## COMPASS ERRORS

### VARIATION

Although the magnetic field of the Earth lies roughly north and south, the Earth's magnetic poles do not coincide with its geographic poles, which are used in the construction of aeronautical charts. Consequently, at most places on the Earth's surface, the direction-sensitive steel needles that seek the Earth's magnetic field will not point to true north, but to magnetic north. Furthermore, local magnetic fields from mineral deposits and other conditions may distort the Earth's magnetic field, and cause additional error in the

position of the compass' north-seeking magnetized needles with reference to true north.

The angular difference between magnetic north, the reference for the magnetic compass, and true north is variation. Lines that connect points of equal variation are called isogonic lines. The line connecting points where the magnetic variation is zero is an agonic line. To convert from true courses or headings to magnetic, subtract easterly variation and add westerly variation. Reverse the process to convert from magnetic to true. [Figure 6-21]

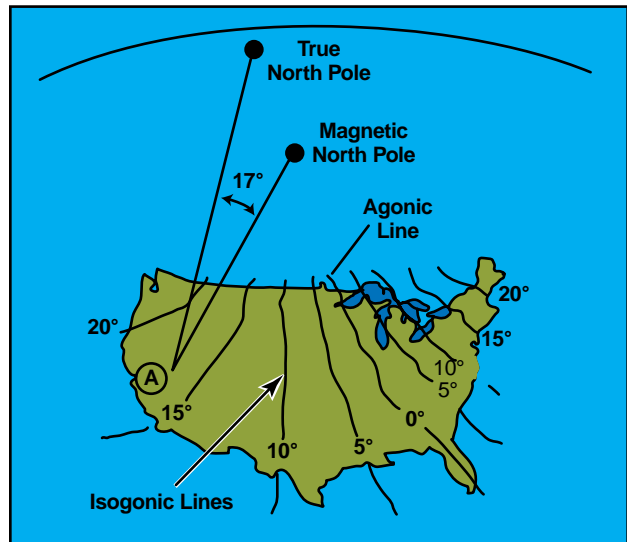

Figure 6-21. Variation at point A in the western United States is 17°. Since the magnetic north pole is located to the east of the true north pole in relation to this point, the variation is easterly. When the magnetic pole falls to the west of the true north pole, variation is westerly.

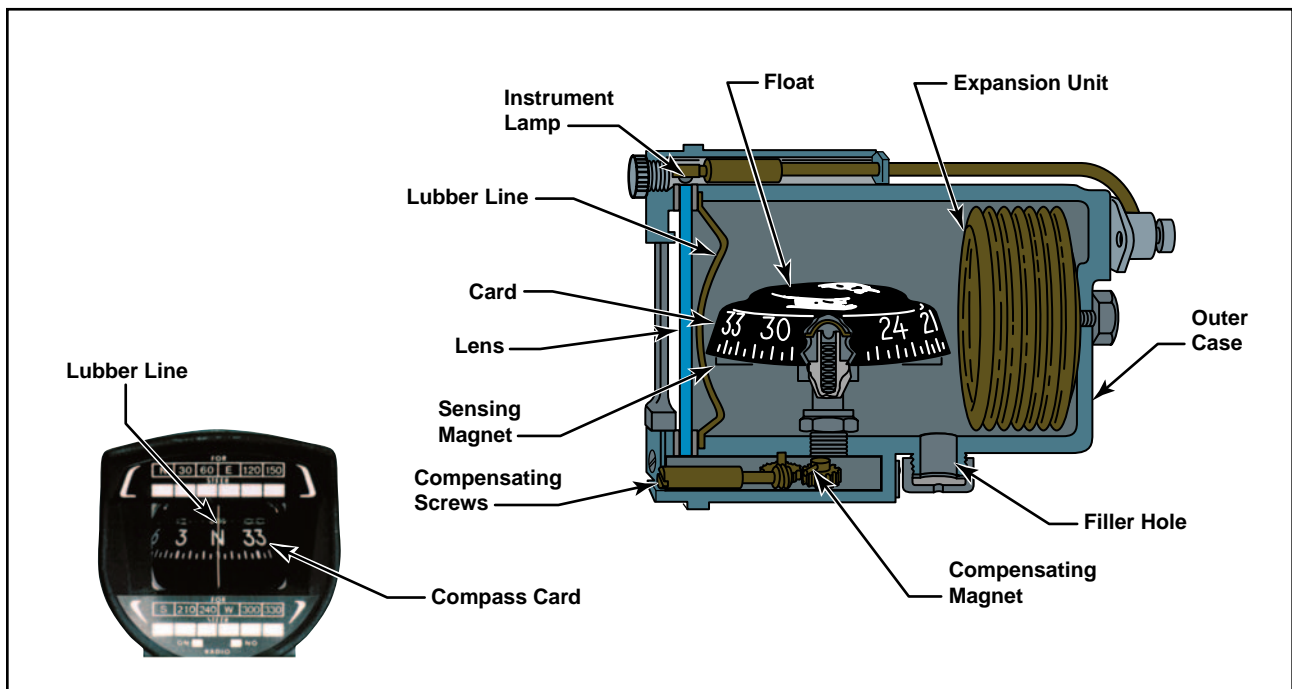

Figure 6-20. Magnetic compass.

## COMPASS DEVIATION

Besides the magnetic fields generated by the Earth, other magnetic fields are produced by metal and electrical accessories within the airplane. These magnetic fields distort the Earth's magnetic force, and cause the compass to swing away from the correct heading. This error is called deviation. Manufacturers install compensating magnets within the compass housing to reduce the effects of deviation. The magnets are usually adjusted while the engine is running and all electrical equipment is operating. However, it is not possible to completely eliminate deviation error; therefore, a compass correction card is mounted near the compass. This card corrects for deviation that occurs from one heading to the next as the lines of force interact at different angles. [Figure 6-22]

## MAGNETIC DIP

Magnetic dip is the result of the vertical component of the Earth's magnetic field. This dip is virtually non-existent at the magnetic equator, since the lines of force are parallel to the Earth's surface and the vertical component is minimal. When a compass is moved toward the poles, the vertical component increases, and magnetic dip becomes more apparent at higher latitudes. Magnetic dip is responsible for compass errors during acceleration, deceleration, and turns.

## USING THE MAGNETIC COMPASS

### ACCELERATION/DECELERATION ERRORS

Acceleration and deceleration errors are fluctuations in the compass during changes in speed. In the Northern Hemisphere, the compass swings towards the north during acceleration, and towards the south during deceleration. When the speed stabilizes, the compass returns to an accurate indication. This error is most pronounced when flying on a heading of east or west, and decreases gradually when flying closer to a north or south heading. The error does not occur when flying directly north or south. The memory aid, ANDS (Accelerate North, Decelerate South) may help in recalling this error. In the Southern Hemisphere, this error occurs in the opposite direction.

## TURNING ERRORS

Turning errors are most apparent when turning to or from a heading of north or south. This error increases as the poles are neared and magnetic dip becomes more apparent. There is no turning error when flying near the magnetic equator.

In the Northern Hemisphere, when making a turn from a northerly heading, the compass gives an initial indication of a turn in the opposite direction. It then begins to show the turn in the proper direction, but lags behind the actual heading. The amount of lag decreases as the turn continues, then disappears as the airplane reaches a heading of east or west. When turning from a heading of east or west to a heading of north, there is no error as the turn begins. However, as the heading approaches north, the compass increasingly lags behind the airplane's actual heading. When making a turn from a southerly heading, the compass gives an indication of a turn in the correct direction, but leads the actual heading. This error also disappears as the airplane approaches an east or west heading. Turning from east or west to a heading of south causes the compass to move correctly at the start of a turn, but then it increasingly leads the actual heading as the airplane nears a southerly direction.

The amount of lead or lag is approximately equal to the latitude of the airplane. For example, if turning from a heading of south to a heading of west while flying at 40° north latitude, the compass rapidly turns to a heading of 220° (180° + 40°). At the midpoint of the turn, the lead decreases to approximately half (20°), and upon reaching a heading of west, it is zero.

The magnetic compass, which is the only direction-seeking instrument in the airplane, should be read only when the airplane is flying straight and level at a constant speed. This will help reduce errors to a minimum.

If the pilot thoroughly understands the errors and characteristics of the magnetic compass, this instrument can become the most reliable means of determining headings.

FOR (MH)	0°	30°	60°	90°	120°	150°	180°	210°	240°	270°	300°	330°
STEER (CH)	359°	30°	60°	88°	120°	152°	183°	212°	240°	268°	300°	329°
RADIO ON <input checked="" type="checkbox"/> RADIO OFF <input type="checkbox"/>												

Figure 6-22. Compass correction card.

**Instrument Check**—Prior to flight, make sure that the compass is full of fluid. Then during turns, the compass should swing freely and indicate known headings.

### VERTICAL CARD COMPASS

A newer design, the vertical card compass significantly reduces the inherent error of the older compass designs. It consists of an azimuth on a rotating vertical card, and resembles a heading indicator with a fixed miniature airplane to accurately present the heading of the airplane. The presentation is easy to read, and the pilot can see the complete 360° dial in relation to the airplane heading. This design uses **eddy current damping** to minimize lead and lag during turns. [Figure 6-23]

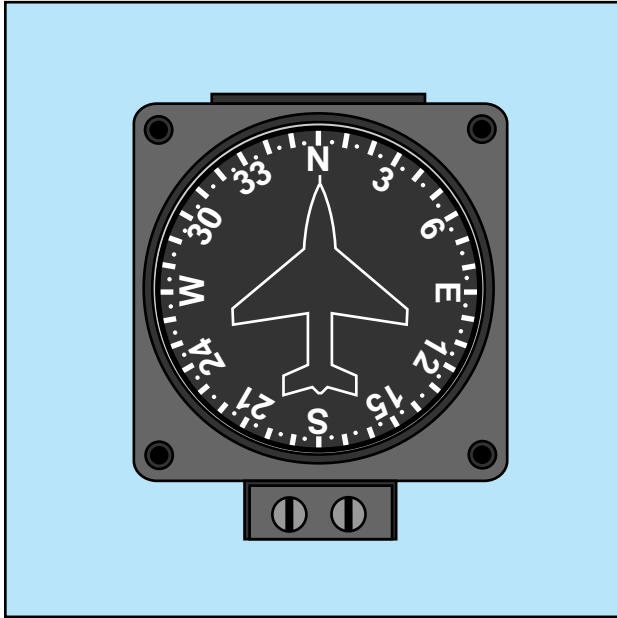

Figure 6-23. Vertical card compass.

### OUTSIDE AIR TEMPERATURE GAUGE

The outside air temperature gauge (OAT) is a simple and effective device mounted so that the sensing element is exposed to the outside air. The sensing element consists of a bimetallic-type thermometer in which two dissimilar materials are welded together in a single strip and twisted into a helix. One end is anchored into protective tube and the other end is affixed to the pointer, which reads against the calibration on a circular face. OAT gauges are calibrated in degrees Celsius, Fahrenheit, or both. An accurate air temperature will provide the pilot with useful information about temperature lapse rate with altitude change. [Figure 6-24].



Figure 6-24. Outside air temperature gauge.

**Eddy Current Damping**—The decreased amplitude of oscillations by the interaction of magnetic fields. In the case of a vertical card magnetic compass, flux from the oscillating permanent magnet produces eddy currents in a damping disk or cup. The magnetic flux produced by the eddy currents opposes the flux from the permanent magnet and decreases the oscillations.





# Chapter 7

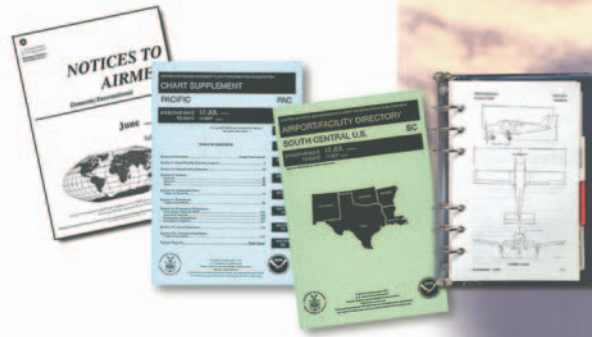

## Flight Manuals and Other Documents

### AIRPLANE FLIGHT MANUALS

An airplane flight manual is a document developed by the airplane manufacturer and approved by the Federal Aviation Administration (FAA). It is specific to a particular make and model airplane by serial number and contains operating procedures and limitations. Title 14 of the Code of Federal Regulations (14 CFR) part 91 requires that pilots comply with the operating limitations specified in the approved airplane flight manuals, markings, and placards. Originally, flight manuals followed whatever format and content the manufacturer felt was appropriate. This changed with the acceptance of the General Aviation Manufacturers Association's (GAMA) *Specification for Pilot's Operating Handbook*, which established a standardized format for all general aviation airplane and rotorcraft flight manuals. The Pilot's Operating Handbook (POH) is developed by the airplane manufacturer and contains the FAA-approved Airplane Flight Manual (AFM) information. However, if *Pilot's Operating Handbook* is used as the main title instead of *Airplane Flight Manual*, a statement must be included on the title page indicating that sections of the document are FAA-approved as the Airplane Flight Manual. [Figure 7-1]

An airplane owner/information manual is a document developed by the airplane manufacturer containing general information about the make and model of airplane. The airplane owner's manual is not FAA-approved and is not specific to a particular serial numbered airplane. This manual provides general information about the operation of the airplane and is not kept current, and therefore cannot be substituted for the AFM/POH.

Besides the preliminary pages, a POH may contain as many as ten sections. These sections are: General;



Figure 7-1. Airplane Flight Manuals.

Limitations; Emergency Procedures; Normal Procedures; Performance; Weight and Balance/Equipment List; Systems Description; Handling, Service, and Maintenance; and Supplements. Manufacturers have the option of including a tenth section on Safety Tips, as well as an alphabetical index at the end of the POH.

### PRELIMINARY PAGES

While the AFM/POH may appear similar for the same make and model of airplane, each manual is unique since it contains specific information about a particular airplane, such as the equipment installed and weight and balance information. Therefore, manufacturers are required to include the serial number and registration on the title page to identify the airplane to which the manual belongs. If a manual does not indicate a specific airplane registration and serial number, it is limited to general study purposes only.

Most manufacturers include a table of contents, which identifies the order of the entire manual by section

number and title. Usually, each section also contains its own table of contents. Page numbers reflect the section and page within that section (1-1, 1-2, 2-1, 3-1, and so forth). If the manual is published in loose-leaf form, each section is usually marked with a divider tab indicating the section number or title, or both. The Emergency Procedures section may have a red tab for quick identification and reference.

## GENERAL (SECTION 1)

The General section provides the basic descriptive information on the airplane and powerplant(s). Some manuals include a three-view drawing of the airplane that provides dimensions of various components. Included are such items as wingspan, maximum height, overall length, wheelbase length, main landing gear track width, maximum propeller diameter, propeller ground clearance, minimum turning radius, and wing area. This section serves as a quick reference in becoming familiar with the airplane.

The last segment of the General section contains definitions, abbreviations, explanations of symbology, and some of the terminology used in the POH. At the option of the manufacturer, metric and other conversion tables may also be included.

## LIMITATIONS (SECTION 2)

The Limitations section contains only those limitations required by regulation or that are necessary for the safe operation of the airplane, powerplant, systems, and equipment. It includes operating limitations, instrument markings, color-coding, and basic placards. Some of the limitation areas are: airspeed, powerplant, weight and loading distribution, and flight.

### AIRSPEED

Airspeed limitations are shown on the airspeed indicator by color-coding and on placards or graphs in the airplane. [Figure 7-2] A red line on the airspeed indicator shows the airspeed limit beyond which structural damage could occur. This is called the never-exceed speed ( $V_{NE}$ ). A yellow arc indicates the speed range between maximum structural cruising speed ( $V_{NO}$ ) and  $V_{NE}$ . Operation of the airplane in the yellow airspeed arc is for smooth air only, and then with caution. A green arc depicts the normal operating speed range, with the upper end at  $V_{NO}$ , and the lower end at stalling speed at maximum weight with the landing gear and flaps retracted ( $V_{S1}$ ). The flap operating range is depicted by the white arc, with the upper end at the maximum flap extended speed ( $V_{FE}$ ), and the lower end at the stalling speed with the landing gear and flaps in the landing configuration ( $V_{SO}$ ).

In addition to the markings listed above, small multi-engine airplanes will have a red radial line to indicate single-engine minimum controllable airspeed ( $V_{MC}$ ). A

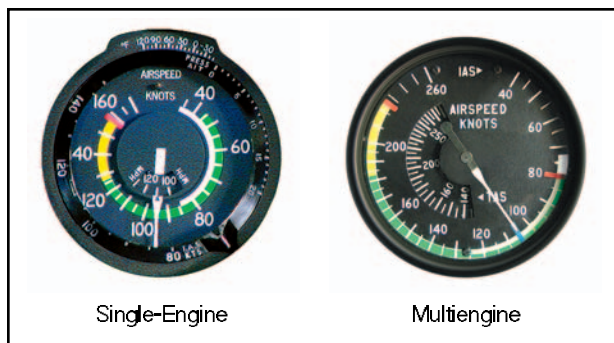

Figure 7-2. Airspeed limitations are depicted by colored arcs and radial lines.

blue radial line is used to indicate single-engine best rate-of-climb speed at maximum weight at sea level ( $V_{YSE}$ ).

### POWERPLANT

The Powerplant Limitations area describes operating limitations on the airplane's reciprocating or turbine engine(s). These include limitations for takeoff power, maximum continuous power, and maximum normal operating power, which is the maximum power the engine can produce without any restrictions, and is depicted by a green arc. Other items that can be included in this area are the minimum and maximum oil and fuel pressures, oil and fuel grades, and propeller operating limits. [Figure 7-3]



Figure 7-3. Minimum, maximum, and normal operating range markings on oil gauge.

All reciprocating-engine powered airplanes must have an r.p.m. indicator for each engine. Airplanes equipped with a constant-speed propeller use a manifold pressure gauge to monitor power output and an r.p.m. gauge to monitor propeller speed. Both instruments depict the maximum operating limit with a red radial line and the normal operating range with a green arc. Some instruments may have a yellow arc to indicate a caution area. [Figure 7-4]

### WEIGHT AND LOADING DISTRIBUTION

The Weight and Loading Distribution area contains the maximum certificated weights, as well as the center-of-gravity (CG) range. The location of the reference datum used in balance computations is included in this

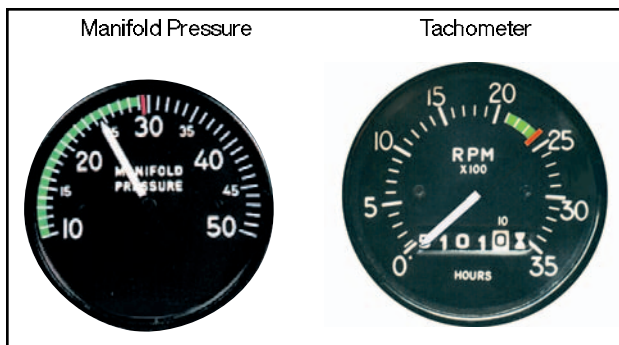

Figure 7-4. Manifold pressure and r.p.m. indicators.

section. Weight and balance computations are not provided in this area, but rather in the Weight and Balance section of the AFM/POH.

### FLIGHT LIMITS

This area lists authorized maneuvers with appropriate entry speeds, flight load factor limits, and kinds of operation limits. It also indicates those maneuvers that are prohibited, such as spins, acrobatic flight, and operational limitations such as flight into known icing conditions.

### PLACARDS

Most airplanes display one or more placards that contain information having a direct bearing on the safe operation of the airplane. These placards are located in conspicuous places within the airplane and are reproduced in the Limitations section or as directed by an Airworthiness Directive (AD). [Figure 7-5]



Figure 7-5. Placards are a common method of depicting airplane limitations.

### EMERGENCY PROCEDURES (SECTION 3)

Checklists describing the recommended procedures and airspeeds for coping with various types of

emergencies or critical situations are located in the Emergency Procedures section. Some of the emergencies covered include: engine failure, fires, and systems failures. The procedures for in-flight engine restarting and ditching may also be included.

Manufacturers may first show the emergencies checklists in an abbreviated form with the order of items reflecting the sequence of action. Amplified checklists that provide additional information on the procedures follow the abbreviated checklist. To be prepared for emergency situations, memorize the immediate action items and after completion, refer to the appropriate checklist.

Manufacturers may include an optional area titled “Abnormal Procedures.” This section describes recommended procedures for handling malfunctions that are not considered emergencies in nature.

### NORMAL PROCEDURES (SECTION 4)

This section begins with a listing of the airspeeds for normal operations. The next area consists of several checklists that may include preflight inspection, before starting procedures, starting engine, before taxiing, taxiing, before takeoff, takeoff, climb, cruise, descent, before landing, bailed landing, after landing, and post-flight procedures. An Amplified Procedures area follows the checklists to provide more detailed information about the various procedures.

To avoid missing important steps, always use the appropriate checklists whenever they are available. Consistent adherence to approved checklists is a sign of a disciplined and competent pilot.

### PERFORMANCE (SECTION 5)

The Performance section contains all the information required by the aircraft certification regulations, and any additional performance information the manufacturer feels may enhance a pilot’s ability to safely operate the airplane. Performance charts, tables, and graphs vary in style, but all contain the same basic information. Some examples of the performance information found in most flight manuals include a graph or table for converting calibrated airspeed into true airspeed; stall speeds in various configurations; and data for determining takeoff and climb performance, cruise performance, and landing performance. Figure 7-6 is an example of a typical performance graph. For more information on how to use the charts, graphs, and tables, refer to Chapter 9—Aircraft Performance.

### WEIGHT AND BALANCE/EQUIPMENT LIST (SECTION 6)

The Weight and Balance/Equipment List section contains all the information required by the FAA to calculate the weight and balance of the airplane.

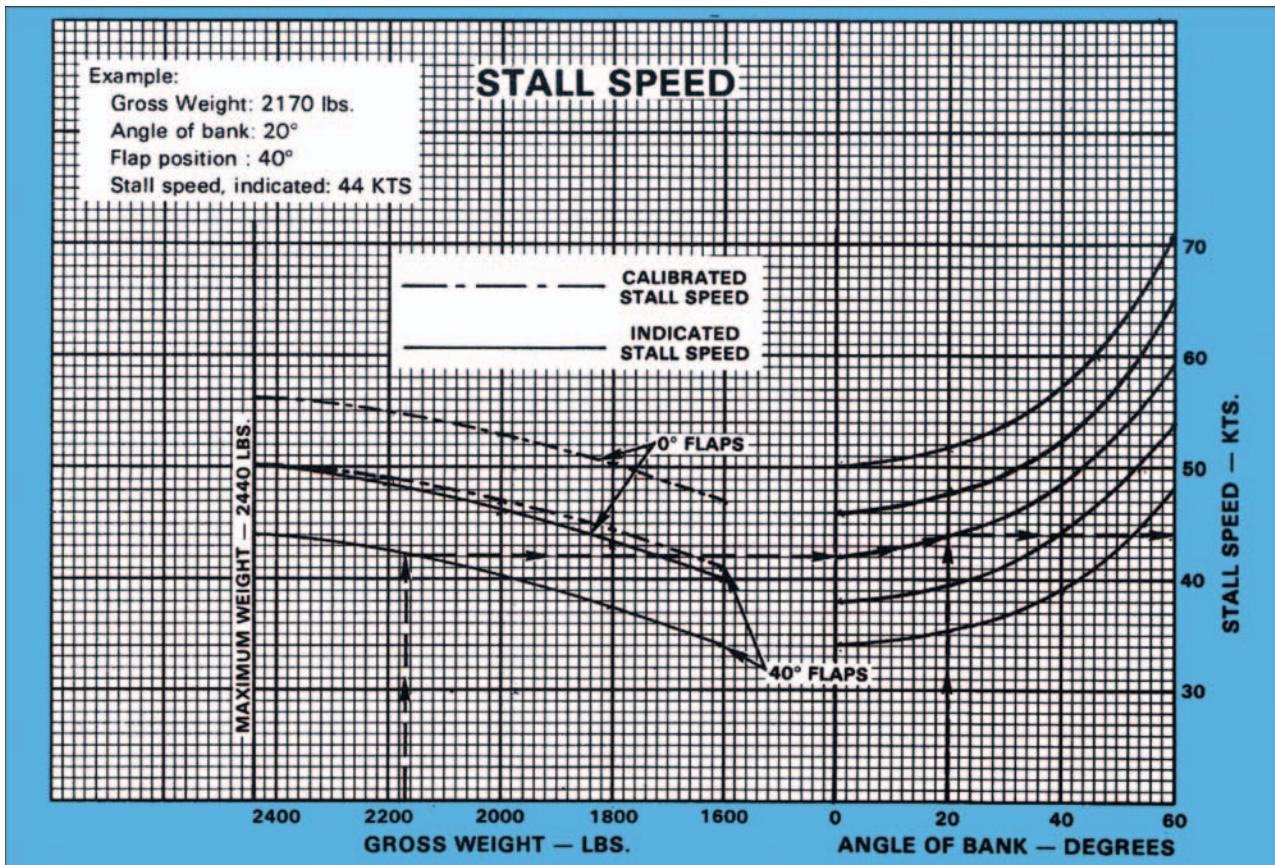

Figure 7-6. Stall speed chart.

Manufacturers include sample weight and balance problems. Weight and balance is discussed in greater detail in Chapter 8—Weight and Balance.

### SYSTEMS DESCRIPTION (SECTION 7)

The Systems Description section is where the manufacturer describes the systems in enough detail for the pilot to understand how the systems operate. For more information on airplane systems, refer to Chapter 5—Aircraft Systems.

### HANDLING, SERVICE, AND MAINTENANCE (SECTION 8)

The Handling, Service, and Maintenance section describes the maintenance and inspections recommended by the manufacturer and the regulations. Additional maintenance or inspections may be required by the issuance of **Airworthiness Directives (AD)** applicable to the airplane, engine, propeller, and components.

**Airworthiness Directive (AD)**—A regulatory notice that is sent out by the FAA to the registered owners of aircraft informing them of the discovery of a condition that keeps their aircraft from continuing to meet its conditions for airworthiness. For further information, see 14 CFR part 39.

This section also describes preventive maintenance that may be accomplished by certificated pilots, as well as the manufacturer’s recommended ground handling procedures. This includes considerations for hangaring, tie-down, and general storage procedures for the airplane.

### SUPPLEMENTS (SECTION 9)

The Supplements section describes pertinent information necessary to safely and efficiently operate the airplane when equipped with the various optional systems and equipment not provided with the standard airplane. Some of this information may be supplied by the airplane manufacturer, or by the manufacturer of the optional equipment. The appropriate information is inserted into the flight manual at the time the equipment is installed. Autopilots, navigation systems, and air-conditioning systems are examples of equipment described in this section.

## SAFETY TIPS (SECTION 10)

The Safety Tips section is an optional section containing a review of information that enhances the safe operation of the airplane. Some examples of the information that might be covered include: physiological factors, general weather information, fuel conservation procedures, high altitude operations, and cold weather operations.

## AIRCRAFT DOCUMENTS

### CERTIFICATE OF AIRCRAFT REGISTRATION

Before an aircraft can be flown legally, it must be registered with the FAA Civil Aviation Registry. The Certificate of Aircraft Registration, which is issued to the owner as evidence of the registration, must be carried in the aircraft at all times. [Figure 7-7]

The Certificate of Aircraft Registration cannot be used for operations when:

- The aircraft is registered under the laws of a foreign country.

- The aircraft's registration is canceled at the written request of the holder of the certificate.
- The aircraft is totally destroyed or scrapped.
- The ownership of the aircraft is transferred.
- The holder of the certificate loses United States citizenship.

For additional events, see 14 CFR section 47.41.

When one of the events listed in 14 CFR section 47.41 occurs, the previous owner must notify the FAA by filling in the back of the Certificate of Aircraft Registration, and mailing it to:

Federal Aviation Administration  
Civil Aviation Registry, AFS-750  
P.O. Box 25504  
Oklahoma City, OK 73125

A dealer's aircraft registration certificate is another form of registration certificate, but is valid only for

REGISTRATION NOT TRANSFERABLE	
UNITED STATES OF AMERICA DEPARTMENT OF TRANSPORTATION - FEDERAL AVIATION ADMINISTRATION CERTIFICATE OF AIRCRAFT REGISTRATION	
NATIONALITY AND REGISTRATION MARKS <b>N48SB</b>	AIRCRAFT SERIAL NO. <b>9411</b>
MANUFACTURER AND MANUFACTURER'S DESIGNATION OF AIRCRAFT <b>PITTS SIS</b> ICAO Aircraft Address Code: <b>5163722</b>	
ISSUED TO <b>JACOBS MARK W.            520 BIPLANE LANE            TECUMSEH, MI 49286</b>	This certificate is issued for registration purposes only and is not a certificate of title. The Federal Aviation Administration does not determine rights of ownership as between private persons.
It is certified that the above described aircraft has been entered on the register of the Federal Aviation Administration, United States of America, in accordance with the Convention on International Civil Aviation, dated December 7, 1944, and with the Federal Aviation Act of 1958, and regulations issued thereunder.	
DATE OF ISSUE <b>JUNE 3, 1995</b>	ADMINISTRATOR <i>David Brown</i>
U.S. Department of Transportation Federal Aviation Administration	
AC Form 8050-3(11/93) Supersedes previous editions	
<b>EFFECT OF REGISTRATION</b> Section 5010) of the Federal Aviation Act of 1958(49 U.S.C.1401) provides: "...Registration shall not be evidence of ownership of aircraft in any proceeding in which such ownership by a particular person is, or may be, in issue." THIS CERTIFICATE MUST BE SIGNED AND RETURNED BY THE REGISTERED OWNER WITHIN 90 DAYS WHEN IT IS NO LONGER IN EFFECT FOR ANY REASON UNDER 14 C.F.R. 47.41(a)(1) THROUGH (9)	
<input type="checkbox"/> a. Registration is cancelled at the request of the owner. (Also check and/or complete Block, b, c, d, e, or f).	<input type="checkbox"/> e. The aircraft is to be registered under the laws of a foreign country: (NAME OF FOREIGN COUNTRY) _____
<input type="checkbox"/> b. The aircraft is totally destroyed or scrapped.	<input type="checkbox"/> f. The ownership of the aircraft is transferred to: (NAME) _____
<input type="checkbox"/> c. United States citizenship has been lost, or the owner's status as a resident alien has changed (unless changed to that of a U.S. citizen).	(ADDRESS) _____
<input type="checkbox"/> d. Thirty days have elapsed since the death of the registered owner (estate representative should sign).	(CITY, STATE, ZIP) _____
(SIGNATURE) _____	(TITLE) _____ (DATE) _____
This certificate must be returned to: AIRCRAFT REGISTRATION BRANCH, P.O. BOX 25504, OKLAHOMA CITY, OKLAHOMA 73125-0504	

U.S. Department of Transportation Federal Aviation Administration Office of Aviation System Standards P.O. Box 25504 Oklahoma City, OK 73125-0504 Official Business Penalty for Private Use \$300 AC Form 8050-3(11/93) Supersedes previous editions
<b>TO:</b> <b>MARK W. JACOBS            520 BIPLANE LANE            TECUMSEH, MI 49286</b>
<b>RETAIN THIS INFORMATION FOR FUTURE REFERENCE</b> <b>CHANGE OF ADDRESS</b> Federal Aviation Regulations require that the registered owner of the aircraft shall report in writing within 30 days any change in permanent mailing address. A revised Certificate of Registration will be issued without charge. The Application for Registration AC Form 8050-1 must be used to report a change of address.
<b>REPLACEMENT OF CERTIFICATE</b> If this certificate is lost, destroyed, or mutilated, a replacement may be obtained at the written request of the holder. Send your request and \$2.00 check (money order made payable to United States Treasury) to: Aircraft Registration Branch P.O. Box 25504 Oklahoma City, Oklahoma 73125-0504
<b>NOTE:</b> All correspondence should include the registration "N" number, manufacturer, model, and serial number of the aircraft.

Figure 7-7. AC Form 8050-3, Certificate of Aircraft Registration.

required flight tests by the manufacturer or in flights that are necessary for the sale of the aircraft by the manufacturer or a dealer. The dealer must remove it when the aircraft is sold.

After compliance with 14 CFR section 47.31, the pink copy of the application for a Certificate of Aircraft Registration is authorization to operate an unregistered aircraft for a period not to exceed 90 days. Since the aircraft is unregistered, it cannot be operated outside of the United States until a permanent Certificate of Aircraft Registration is received and placed in the aircraft.

The FAA does not issue any certificate of ownership or endorse any information with respect to ownership on a Certificate of Aircraft Registration.

**NOTE:** For additional information concerning the Aircraft Registration Application or the Aircraft Bill of Sale, contact the nearest FAA Flight Standards District Office (FSDO).

**AIRWORTHINESS CERTIFICATE**

An Airworthiness Certificate is issued by a representative of the FAA after the aircraft has been inspected, is found to meet the requirements of 14 CFR part 21, and is in condition for safe operation. The Airworthiness Certificate must be displayed in the aircraft so it is legible to the passengers and crew whenever it is operated. The Airworthiness Certificate is

transferred with the aircraft except when it is sold to a foreign purchaser.

A Standard Airworthiness Certificate is issued for aircraft type certificated in the normal, utility, acrobatic, commuter, and transport categories or for manned free balloons. Figure 7-8 illustrates a Standard Airworthiness Certificate, and an explanation of each item in the certificate follows.

**Item 1 Nationality**—The “N” indicates the aircraft is registered in the United States. Registration marks consist of a series of up to five numbers or numbers and letters. In this case, N2631A is the registration number assigned to this airplane.

**Item 2**—Indicates the manufacturer, make, and model of the aircraft.

**Item 3**—Indicates the manufacturer’s serial number assigned to the aircraft, as noted on the aircraft data plate.

**Item 4**—Indicates the category in which the aircraft must be operated. In this case, it must be operated in accordance with the limitations specified for the “NORMAL” category.

UNITED STATES OF AMERICA DEPARTMENT OF TRANSPORTATION—FEDERAL AVIATION ADMINISTRATION			
<b>STANDARD AIRWORTHINESS CERTIFICATE</b>			
1 NATIONALITY AND REGISTRATION MARKS <b>N2631A</b>	2 MANUFACTURER AND MODEL <b>PIPER PA-22-135</b>	3 AIRCRAFT SERIAL NUMBER <b>22-903</b>	4 CATEGORY <b>NORMAL</b>
5. AUTHORITY AND BASIS FOR ISSUANCE This airworthiness certificate is issued pursuant to the Federal Aviation Act of 1958 and certifies that, as of the date of issuance, the aircraft to which issued has been inspected and found to conform to the type certificate therefor, to be in condition for safe operation, and has been shown to meet the requirements of the applicable comprehensive and detailed airworthiness code as provided by Annex 8 to the Convention on International Civil Aviation, except as noted herein. Exceptions:  <b>NONE</b>			
6 TERMS AND CONDITIONS Unless sooner surrendered, suspended, revoked, or a termination date is otherwise established by the Administrator, this airworthiness certificate is effective as long as the maintenance, preventative maintenance, and alterations are performed in accordance with Parts 21, 43, and 91 of the Federal Aviation Regulations, as appropriate, and the aircraft is registered in the United States.			
DATE OF ISSUANCE <b>08-10-95</b>	FAA REPRESENTATIVE <i>Marion W. Williams</i> <b>MARION W. WILLIAMS</b>	DESIGNATION NUMBER <b>SW-FSDO-OKC</b>	
Any alteration, reproduction, or misuse of this certificate may be punishable by a fine not exceeding \$1,000, or imprisonment not exceeding 3 years, or both. THIS CERTIFICATE MUST BE DISPLAYED IN THE AIRCRAFT IN ACCORDANCE WITH APPLICABLE FEDERAL AVIATION REGULATIONS.			
<b>FAA Form 8100-2</b> (8-82)		GPO 892-804	

Figure 7-8. FAA Form 8100-2, Standard Airworthiness Certificate.

**Item 5**—Indicates the aircraft conforms to its type certificate and is considered in condition for safe operation at the time of inspection and issuance of the certificate. Any exemptions from the applicable airworthiness standards are briefly noted here and the exemption number given. The word “NONE” is entered if no exemption exists.

**Item 6**—Indicates the Airworthiness Certificate is in effect indefinitely if the aircraft is maintained in accordance with 14 CFR parts 21, 43, and 91, and the aircraft is registered in the United States.

Also included are the date the certificate was issued and the signature and office identification of the FAA representative.

A Standard Airworthiness Certificate remains in effect as long as the aircraft receives the required maintenance and is properly registered in the United States. Flight safety relies, in part, on the condition of the aircraft, which is determined by inspections performed by mechanics, approved repair stations, or manufacturers who meet specific requirements of 14 CFR part 43.

A Special Airworthiness Certificate is issued for all aircraft certificated in other than the Standard classifications, such as Experimental, Restricted, Limited, Provisional, and Sport Pilot. When purchasing an aircraft classified as other than Standard, it is recommended that the local FSDO be contacted for an explanation of the pertinent airworthiness requirements and the limitations of such a certificate.

## **AIRCRAFT MAINTENANCE**

Maintenance is defined as the preservation, inspection, overhaul, and repair of an aircraft, including the replacement of parts. A PROPERLY MAINTAINED AIRCRAFT IS A SAFE AIRCRAFT. In addition, regular and proper maintenance ensures that an aircraft meets an acceptable standard of airworthiness throughout its operational life.

Although maintenance requirements vary for different types of aircraft, experience shows that aircraft need some type of preventive maintenance every 25 hours of flying time or less, and minor maintenance at least every 100 hours. This is influenced by the kind of operation, climatic conditions, storage facilities, age, and construction of the aircraft. Manufacturers supply maintenance manuals, parts catalogs, and other service information that should be used in maintaining the aircraft.

## **AIRCRAFT INSPECTIONS**

14 CFR part 91 places primary responsibility on the owner or operator for maintaining an aircraft in an

airworthy condition. Certain inspections must be performed on the aircraft, and the owner must maintain the airworthiness of the aircraft during the time between required inspections by having any defects corrected.

14 CFR part 91, subpart E, requires the inspection of all civil aircraft at specific intervals to determine the overall condition. The interval depends upon the type of operations in which the aircraft is engaged. Some aircraft need to be inspected at least once each 12-calendar months, while inspection is required for others after each 100 hours of operation. In some instances, an aircraft may be inspected in accordance with an inspection system set up to provide for total inspection of the aircraft on the basis of calendar time, time in service, number of system operations, or any combination of these.

All inspections should follow the current manufacturer’s maintenance manual, including the Instructions for Continued Airworthiness concerning inspections intervals, parts replacement, and life-limited items as applicable to the aircraft.

### **ANNUAL INSPECTION**

Any reciprocating-engine powered or single-engine-turbojet/turbo-propeller powered small aircraft (12,500 pounds and under) flown for business or pleasure and not flown for compensation or hire is required to be inspected at least annually. The inspection shall be performed by a certificated airframe and powerplant (A&P) mechanic who holds an Inspection Authorization (IA), by the manufacturer, or by a certificated and appropriately rated repair station. The aircraft may not be operated unless the annual inspection has been performed within the preceding 12-calendar months. A period of 12-calendar months extends from any day of a month to the last day of the same month the following year. An aircraft overdue for an annual inspection may be operated under a Special Flight Permit issued by the FAA for the purpose of flying the aircraft to a location where the annual inspection can be performed. However, all applicable Airworthiness Directives that are due must be complied with.

### **100-HOUR INSPECTION**

All aircraft under 12,500 pounds (except turbojet/turbo-propeller powered multiengine airplanes and turbine powered rotorcraft), used to carry passengers for hire, must have received a 100-hour inspection within the preceding 100 hours of time in service and have been approved for return to service. Additionally, an aircraft used for flight instruction for hire, when provided by the person giving the flight instruction, must also have received a 100-hour inspection. This inspection must be performed by an FAA certificated A&P mechanic, an appropriately rated FAA certificated repair station,



or by the aircraft manufacturer. An annual inspection, or an inspection for the issuance of an Airworthiness Certificate may be substituted for a required 100-hour inspection. The 100-hour limitation may be exceeded by not more than 10 hours while en route to reach a place where the inspection can be done. The excess time used to reach a place where the inspection can be done must be included in computing the next 100 hours of time in service.

### **OTHER INSPECTION PROGRAMS**

The annual and 100-hour inspection requirements do not apply to large (over 12,500 pounds) airplanes, turbojets, or turbo-propeller powered multiengine airplanes or to aircraft for which the owner complies with a progressive inspection program. Details of these requirements may be determined by reference to 14 CFR part 43, section 43.11 and part 91, subpart E, and by inquiring at a local FSDO.

### **ALTIMETER SYSTEM INSPECTION**

14 CFR part 91, section 91.411 requires that the altimeter, encoding altimeter, and related system be tested and inspected in the preceding 24 months before operated in controlled airspace under instrument flight rules (IFR).

### **TRANSPONDER INSPECTION**

14 CFR part 91, section 91.413 requires that before a transponder can be used under 14 CFR part 91, section 91.215(a), it shall be tested and inspected within the preceding 24 months.

### **PREFLIGHT INSPECTIONS**

The preflight inspection is a thorough and systematic means by which a pilot determines if the aircraft is airworthy and in condition for safe operation. POHs and owner/information manuals contain a section devoted to a systematic method of performing a preflight inspection.

### **MINIMUM EQUIPMENT LISTS (MEL) AND OPERATIONS WITH INOPERATIVE EQUIPMENT**

The Code of Federal Regulations (CFRs) requires that all aircraft instruments and installed equipment are operative prior to each departure. When the FAA adopted the **minimum equipment list (MEL)** concept for 14 CFR part 91 operations, this allowed for the first time, operations with inoperative items determined to be nonessential for safe flight. At the same

time, it allowed part 91 operators, without an MEL, to defer repairs on nonessential equipment within the guidelines of part 91.

There are two primary methods of deferring maintenance on small rotorcraft, non-turbine powered airplanes, gliders, or lighter-than-air aircraft operated under part 91. They are the deferral provision of 14 CFR part 91, section 91.213(d) and an FAA-approved MEL.

The deferral provision of section 91.213(d) is widely used by most pilot/operators. Its popularity is due to simplicity and minimal paperwork. When inoperative equipment is found during preflight or prior to departure, the decision should be to cancel the flight, obtain maintenance prior to flight, or to defer the item or equipment.

Maintenance deferrals are not used for in-flight discrepancies. The manufacturer's AFM/POH procedures are to be used in those situations. The discussion that follows assumes that the pilot wishes to defer maintenance that would ordinarily be required prior to flight.

Using the deferral provision of section 91.213(d), the pilot determines whether the inoperative equipment is required by type design, the CFRs, or ADs. If the inoperative item is not required, and the aircraft can be safely operated without it, the deferral may be made. The inoperative item shall be deactivated or removed and an INOPERATIVE placard placed near the appropriate switch, control, or indicator. If deactivation or removal involves maintenance (removal always will), it must be accomplished by certificated maintenance personnel.

For example, if the position lights (installed equipment) were discovered to be inoperative prior to a daytime flight, the pilot would follow the requirements of section 91.213(d).

The deactivation may be a process as simple as the pilot positioning a circuit breaker to the OFF position, or as complex as rendering instruments or equipment totally inoperable. Complex maintenance tasks require a certificated and appropriately rated maintenance person to perform the deactivation. In all cases, the item or equipment must be placarded INOPERATIVE.

**Minimum Equipment List (MEL)**—An inventory of instruments and equipment that may legally be inoperative, with the specific conditions under which an aircraft may be flown with such items inoperative.

All small rotorcraft, non-turbine powered airplanes, gliders, or lighter-than-air aircraft operated under part 91 are eligible to use the maintenance deferral provisions of section 91.213(d). However, once an operator requests an MEL, and a Letter of Authorization (LOA) is issued by the FAA, then the use of the MEL becomes mandatory for that aircraft. All maintenance deferrals must be accomplished in accordance with the terms and conditions of the MEL and the operator-generated procedures document.

The use of an MEL for an aircraft operated under part 91 also allows for the deferral of inoperative items or equipment. The primary guidance becomes the FAA-approved MEL issued to that specific operator and N-numbered aircraft.

The FAA has developed master minimum equipment lists (MMELs) for aircraft in current use. Upon written request by an operator, the local FSDO may issue the appropriate make and model MMEL, along with an LOA, and the preamble. The operator then develops operations and maintenance (O&M) procedures from the MMEL. This MMEL with O&M procedures now becomes the operator's MEL. The MEL, LOA, preamble, and procedures document developed by the operator must be on board the aircraft when it is operated.

The FAA considers an approved MEL to be a supplemental type certificate (STC) issued to an aircraft by serial number and registration number. It therefore becomes the authority to operate that aircraft in a condition other than originally type certificated.

With an approved MEL, if the position lights were discovered inoperative prior to a daytime flight, the pilot would make an entry in the maintenance record or discrepancy record provided for that purpose. The item is then either repaired or deferred in accordance with the MEL. Upon confirming that daytime flight with inoperative position lights is acceptable in accordance with the provisions of the MEL, the pilot would leave the position lights switch OFF, open the circuit breaker (or whatever action is called for in the procedures document), and placard the position light switch as INOPERATIVE.

There are exceptions to the use of the MEL for deferral. For example, should a component fail that is not listed in the MEL as deferrable (the tachometer, flaps, or stall warning device, for example), then repairs are required to be performed prior to departure. If maintenance or parts are not readily available at that location, a special flight permit can be obtained from the nearest FSDO. This permit allows the aircraft to be flown to another location for maintenance. This allows an aircraft that may not currently meet applicable airworthiness requirements, but is capable of safe flight, to be

operated under the restrictive special terms and conditions attached to the special flight permit.

Deferral of maintenance is not to be taken lightly, and due consideration should be given to the effect an inoperative component may have on the operation of an aircraft, particularly if other items are inoperative. Further information regarding MELs and operations with inoperative equipment can be found in Advisory Circular (AC) 91-67, Minimum Equipment Requirements for General Aviation Operations Under FAR Part 91.

## **PREVENTIVE MAINTENANCE**

Preventive maintenance is considered to be simple or minor preservation operations and the replacement of small standard parts, not involving complex assembly operations. Certificated pilots, excluding student pilots, sport pilots, and recreational pilots, may perform preventive maintenance on any aircraft that is owned or operated by them provided that aircraft is not used in air carrier service. (Sport pilots operating light sport aircraft, refer to 14 CFR part 65 for maintenance privileges.) 14 CFR part 43, Appendix A, contains a list of the operations that are considered to be preventive maintenance.

## **REPAIRS AND ALTERATIONS**

Repairs and alterations are classified as either major or minor. 14 CFR part 43, Appendix A, describes the alterations and repairs considered major. Major repairs or alterations shall be approved for return to service on FAA Form 337, Major Repairs and Major Alterations, by an appropriately rated certificated repair station, an FAA certificated A&P mechanic holding an Inspection Authorization, or a representative of the Administrator. Minor repairs and minor alterations may be approved for return to service with a proper entry in the maintenance records by an FAA certificated A&P mechanic or an appropriately certificated repair station.

For modifications of experimental aircraft, refer to the operating limitations issued to that aircraft. Modifications in accordance with FAA Order 8130.2, Airworthiness Certification of Aircraft and Related Products, may require the notification of the issuing authority.

## **SPECIAL FLIGHT PERMITS**

A special flight permit is a Special Airworthiness Certificate issued authorizing operation of an aircraft that does not currently meet applicable airworthiness requirements but is safe for a specific flight. Before the permit is issued, an FAA inspector may personally inspect the aircraft, or require it to be inspected by an FAA certificated A&P mechanic or an appropriately certificated repair station, to determine its safety for the intended flight. The inspection shall be recorded in the aircraft records.

The special flight permit is issued to allow the aircraft to be flown to a base where repairs, alterations, or maintenance can be performed; for delivering or exporting the aircraft; or for evacuating an aircraft from an area of impending danger. A special flight permit may be issued to allow the operation of an overweight aircraft for flight beyond its normal range over water or land areas where adequate landing facilities or fuel is not available.

If a special flight permit is needed, assistance and the necessary forms may be obtained from the local FSDO or Designated Airworthiness Representative (DAR). [Figure 7-9]

### AIRWORTHINESS DIRECTIVES

A primary safety function of the FAA is to require correction of unsafe conditions found in an aircraft, aircraft engine, propeller, or appliance when such conditions exist and are likely to exist or develop in other products of the same design. The unsafe condition may exist because of a design defect, maintenance, or other causes. 14 CFR part 39, Airworthiness Directives (ADs), defines the authority and responsibility of the Administrator for requiring the necessary corrective action. ADs are the means used to notify aircraft owners and other interested persons of unsafe conditions and to specify the conditions under which the product may continue to be operated.

ADs may be divided into two categories:

1. those of an emergency nature requiring immediate compliance prior to further flight, and
2. those of a less urgent nature requiring compliance within a specified period of time.

Airworthiness Directives are regulatory and shall be complied with unless a specific exemption is granted. It is the aircraft owner or operator's responsibility to ensure compliance with all pertinent ADs. This includes those ADs that require recurrent or continuing action. For example, an AD may require a repetitive inspection each 50 hours of operation, meaning the particular inspection shall be accomplished and recorded every 50 hours of time in service. Owners/operators are reminded there is no provision to overfly the maximum hour requirement of an AD unless it is specifically written into the AD. To help determine if an AD applies to an amateur-built aircraft, contact the local FSDO.

14 CFR part 91, section 91.417 requires a record to be maintained that shows the current status of applicable ADs, including the method of compliance; the AD number and revision date, if recurring; the time and date when due again; the signature; kind of certificate; and certificate number of the repair station or mechanic who performed the work. For ready reference, many

UNITED STATES OF AMERICA DEPARTMENT OF TRANSPORTATION - FEDERAL AVIATION ADMINISTRATION <b>SPECIAL AIRWORTHINESS CERTIFICATE</b>			
<b>A</b>	CATEGORY/DESIGNATION <b>EXPERIMENTAL</b>		
	PURPOSE <b>OPERATING AMATEUR-BUILT AIRCRAFT</b>		
<b>B</b>	MANU-FACTURER	NAME <b>N/A</b>	
		ADDRESS <b>N/A</b>	
<b>C</b>	FLIGHT	FROM <b>N/A</b>	
		TO <b>N/A</b>	
<b>D</b>	N- <b>48SB</b>		SERIAL NO. <b>9411</b>
	BUILDER <b>MARK W. JACOBS</b>		MODEL <b>PITTS SIS</b>
<b>E</b>	DATE OF ISSUANCE <b>04-01-95</b>		EXPIRY <b>UNLIMITED</b>
	OPERATING LIMITATIONS DATED <b>04-01-95</b> ARE A PART OF THIS CERTIFICATE		
	SIGNATURE OF FAA REPRESENTATIVE <i>Darrel A. Freeman</i>		DESIGNATION OR OFFICE NO. <b>OKC-MIDO-41</b>
Any alteration, reproduction or misuse of this certificate may be punishable by a fine not exceeding \$1,000 or imprisonment not exceeding 3 years, or both. THIS CERTIFICATE MUST BE DISPLAYED IN THE AIRCRAFT IN ACCORDANCE WITH APPLICABLE FEDERAL AVIATION REGULATIONS.			
FAA FORM 8130-7 (10/82)		SEE REVERSE SIDE	

Figure 7-9. FAA Form 8130-7, Special Airworthiness Certificate.

aircraft owners have a chronological listing of the pertinent ADs in the back of their aircraft, engine, and propeller maintenance records.

All Airworthiness Directives and the AD Biweekly are free on the Internet at [www.airweb.faa.gov/rgl](http://www.airweb.faa.gov/rgl)

Paper copies of the Summary of Airworthiness Directives and the AD Biweekly may be purchased from the Superintendent of Documents. The Summary contains all the valid ADs previously published and is divided into two areas. The small aircraft and rotorcraft books contain all ADs applicable to small aircraft (12,500 pounds or less maximum certificated takeoff weight) and ADs applicable to all helicopters. The large aircraft books contain all ADs applicable to large aircraft.

For further information on how to order ADs and the current price, contact:

U.S. Department of Transportation  
Federal Aviation Administration  
Delegation & Airworthiness Programs Branch,  
AIR-140  
P.O. Box 26460  
Oklahoma City, OK 73125  
Telephone Number: (405) 954-4103  
Fax: (405) 954-4104

## **AIRCRAFT OWNER/OPERATOR RESPONSIBILITIES**

The registered owner/operator of an aircraft is responsible for certain items such as:

- Having a current Airworthiness Certificate and a Certificate of Aircraft Registration in the aircraft.
- Maintaining the aircraft in an airworthy condition, including compliance with all applicable Airworthiness Directives.
- Assuring that maintenance is properly recorded.
- Keeping abreast of current regulations concerning the operation and maintenance of the aircraft.
- Notifying the FAA Civil Aviation Registry immediately of any change of permanent mailing address, or of the sale or export of the aircraft, or of the loss of the eligibility to register an aircraft. (Refer to 14 CFR part 47, section 47.41.)
- Having a current FCC radio station license if equipped with radios, including emergency locator transmitter (ELT), if operated outside of the United States.



# Chapter 8

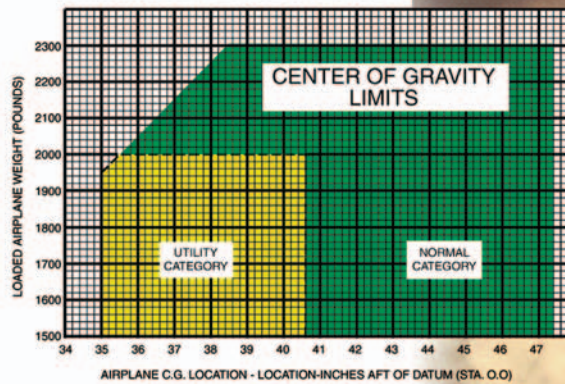

## Weight and Balance

Compliance with the weight and balance limits of any airplane is critical to flight safety. Operating an airplane above the maximum weight limitation compromises the structural integrity of the airplane and adversely affects its performance. Operation with the center of gravity (CG) outside the approved limits may result in control difficulty.

### WEIGHT CONTROL

Weight is the force with which gravity attracts a body toward the center of the earth. It is a product of the mass of a body and the acceleration acting on the body. Weight is a major factor in airplane construction and operation, and demands respect from all pilots.

The force of gravity continually attempts to pull the airplane down toward earth. The force of lift is the only force that counteracts weight and sustains the airplane in flight. However, the amount of lift produced by an airfoil is limited by the airfoil design, angle of attack, airspeed, and air density. Therefore, to assure that the lift generated is sufficient to counteract weight, loading the airplane beyond the manufacturer's recommended weight must be avoided. If the weight is greater than the lift generated, the airplane may be incapable of flight.

### EFFECTS OF WEIGHT

Any item aboard the airplane that increases the total weight is undesirable as far as performance is concerned. Manufacturers attempt to make the airplane as light as possible without sacrificing strength or safety.

The pilot of an airplane should always be aware of the consequences of overloading. An overloaded airplane may not be able to leave the ground, or if it does become airborne, it may exhibit unexpected and

unusually poor flight characteristics. If an airplane is not properly loaded, the initial indication of poor performance usually takes place during takeoff.

Excessive weight reduces the flight performance of an airplane in almost every respect. The most important performance deficiencies of the overloaded airplane are:

- Higher takeoff speed.
- Longer takeoff run.
- Reduced rate and angle of climb.
- Lower maximum altitude.
- Shorter range.
- Reduced cruising speed.
- Reduced maneuverability.
- Higher stalling speed.
- Higher approach and landing speed.
- Longer landing roll.
- Excessive weight on the nosewheel or tailwheel.

The pilot must be knowledgeable in the effect of weight on the performance of the particular airplane being flown. Preflight planning should include a check of performance charts to determine if the airplane's weight may contribute to hazardous flight operations. Excessive weight in itself reduces the safety margins available to the pilot, and becomes even more hazardous when other performance-reducing factors are combined with overweight. The pilot must also consider the consequences of an overweight airplane if an emergency

condition arises. If an engine fails on takeoff or airframe ice forms at low altitude, it is usually too late to reduce the airplane's weight to keep it in the air.

## WEIGHT CHANGES

The weight of the airplane can be changed by altering the fuel load. Gasoline has considerable weight—6 pounds per gallon—30 gallons may weigh more than one passenger. But it must be remembered that if weight is lowered by reducing fuel, the range of the airplane is decreased. During flight, fuel burn is normally the only weight change that takes place. As fuel is used, the airplane becomes lighter and performance is improved.

Changes of fixed equipment have a major effect upon the weight of the airplane. An airplane can be overloaded by the installation of extra radios or instruments. Repairs or modifications may also affect the weight of the airplane.

## BALANCE, STABILITY, AND CENTER OF GRAVITY

Balance refers to the location of the center of gravity (CG) of an airplane, and is important to airplane stability and safety in flight. The center of gravity is a point at which an airplane would balance if it were suspended at that point.

The prime concern of airplane balancing is the fore and aft location of the CG along the longitudinal axis. The center of gravity is not necessarily a fixed point; its location depends on the distribution of weight in the airplane. As variable load items are shifted or expended, there is a resultant shift in CG location. The pilot should realize that if the CG of an airplane is displaced too far forward on the longitudinal axis, a nose-heavy condition will result. Conversely, if the CG is displaced too far aft on the longitudinal axis, a tail-heavy condition will result. It is possible that an unfavorable location of the CG could produce such an unstable condition that the pilot could not control the airplane. [Figure 8-1]

Location of the CG with reference to the lateral axis is also important. For each item of weight existing to the left of the fuselage centerline, there is an equal weight existing at a corresponding location on the right. This may be upset, however, by unbalanced lateral loading. The position of the lateral CG is not computed, but the pilot must be aware that adverse effects will certainly arise as a result of a laterally unbalanced condition. Lateral unbalance will occur if the fuel load is mismanaged by supplying the engine(s) unevenly from tanks on one side of the airplane. The pilot can compensate for the resulting wing-heavy condition by adjusting the aileron trim tab or by holding a constant aileron control

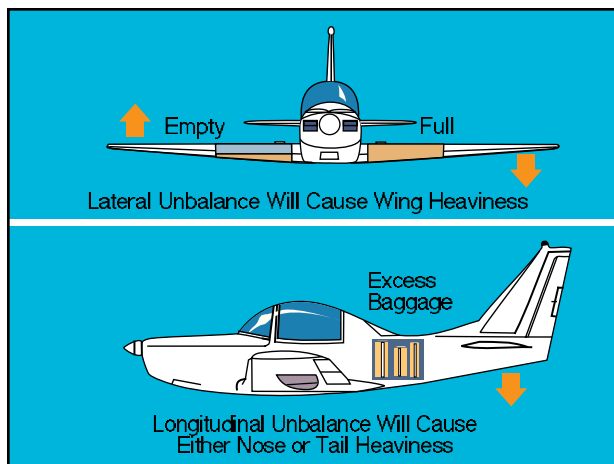

Figure 8-1. Lateral or longitudinal unbalance.

pressure. However, this places the airplane controls in an out-of-streamline condition, increases drag, and results in decreased operating efficiency. Since lateral balance is relatively easy to control and longitudinal balance is more critical, further reference to balance in this handbook will mean longitudinal location of the center of gravity.

In any event, flying an airplane that is out of balance can produce increased pilot fatigue with obvious effects on the safety and efficiency of flight. The pilot's natural correction for longitudinal unbalance is a change of trim to remove the excessive control pressure. Excessive trim, however, has the effect of not only reducing aerodynamic efficiency but also reducing primary control travel distance in the direction the trim is applied.

## EFFECTS OF ADVERSE BALANCE

Adverse balance conditions affect airplane flight characteristics in much the same manner as those mentioned for an excess weight condition. In addition, there are two essential airplane characteristics that may be seriously affected by improper balance; these are stability and control. Loading in a nose-heavy condition causes problems in controlling and raising the nose, especially during takeoff and landing. Loading in a tail-heavy condition has a most serious effect upon longitudinal stability, and can reduce the airplane's capability to recover from stalls and spins. Another undesirable characteristic produced from tail-heavy loading is that it produces very light control forces. This makes it easy for the pilot to inadvertently overstress the airplane.

Limits for the location of the airplane's center of gravity are established by the manufacturer. These are the fore and aft limits beyond which the CG should not be located for flight. These limits are published for each airplane in the Type Certificate Data Sheet, or Aircraft Specification and the Airplane Flight Manual or Pilot's

Operating Handbook (AFM/POH). If, after loading, the CG is not within the allowable limits, it will be necessary to relocate some items within the airplane before flight is attempted.

The forward center-of-gravity limit is often established at a location that is determined by the landing characteristics of the airplane. During landing, which is one of the most critical phases of flight, exceeding the forward CG limit may result in excessive loads on the nosewheel; a tendency to nose over on tailwheel-type airplanes; decreased performance; higher stalling speeds; and higher control forces. In extreme cases, a CG location that is forward of the forward limit may result in nose heaviness to the extent that it may be difficult or impossible to flare for landing. Manufacturers purposely place the forward CG limit as far rearward as possible to aid pilots in avoiding damage to the airplane when landing. In addition to decreased static and dynamic longitudinal stability, other undesirable effects caused by a CG location aft of the allowable range may include extreme control difficulty, violent stall characteristics, and very light stick forces that make it easy to overstress the airplane inadvertently.

A restricted forward center-of-gravity limit is also specified to assure that sufficient elevator deflection is available at minimum airspeed. When structural limitations or large stick forces do not limit the forward CG position, it is located at the position where full-up elevator is required to obtain a high angle of attack for landing.

The aft center-of-gravity limit is the most rearward position at which the CG can be located for the most critical maneuver or operation. As the CG moves aft, a less stable condition occurs, which decreases the ability of the airplane to right itself after maneuvering or turbulence.

For some airplanes the CG limits, both fore and aft, may be specified to vary as gross weight changes. They may also be changed for certain operations such as acrobatic flight, retraction of the landing gear, or the installation of special loads and devices that change the flight characteristics.

The actual location of the CG can be altered by many variable factors and is usually controlled by the pilot. Placement of baggage and cargo items determines the CG location. The assignment of seats to passengers can also be used as a means of obtaining a favorable balance. If the airplane is tail-heavy, it is only logical to place heavy passengers in forward seats. Also, fuel burn can affect the CG based on the location of the fuel tanks.

## MANAGEMENT OF WEIGHT AND BALANCE CONTROL

Weight and balance control should be a matter of concern to all pilots. The pilot has control over loading and fuel management (the two variable factors that can change both total weight and CG location) of a particular airplane.

The airplane owner or operator should make certain that up-to-date information is available in the airplane for the pilot's use, and should ensure that appropriate entries are made in the airplane records when repairs or modifications have been accomplished. Weight changes must be accounted for and the proper notations made in weight and balance records. The equipment list must be updated, if appropriate. Without such information, the pilot has no foundation upon which to base the necessary calculations and decisions.

Before any flight, the pilot should determine the weight and balance condition of the airplane. Simple and orderly procedures, based on sound principles, have been devised by airplane manufacturers for the determination of loading conditions. The pilot must use these procedures and exercise good judgment. In many modern airplanes, it is not possible to fill all seats, baggage compartments, and fuel tanks, and still remain within the approved weight and balance limits. If the maximum passenger load is carried, the pilot must often reduce the fuel load or reduce the amount of baggage.

## TERMS AND DEFINITIONS

The pilot should be familiar with terms used in working the problems related to weight and balance. The following list of terms and their definitions is well standardized, and knowledge of these terms will aid the pilot to better understand weight and balance calculations of any airplane. Terms defined by the *General Aviation Manufacturers Association* as an industry standard are marked in the titles with *GAMA*.

- **Arm (moment arm)**—is the horizontal distance in inches from the reference datum line to the center of gravity of an item. The algebraic sign is plus (+) if measured aft of the datum, and minus (–) if measured forward of the datum.
- **Basic empty weight (GAMA)**—includes the standard empty weight plus optional and special equipment that has been installed.
- **Center of gravity (CG)**—is the point about which an airplane would balance if it were possible to suspend it at that point. It is the mass center of the airplane, or the theoretical point at which the entire weight of the airplane is assumed to be concentrated. It may be expressed in inches from



the reference datum, or in percent of mean aerodynamic chord (MAC).

- **Center-of-gravity limits**—are the specified forward and aft points within which the CG must be located during flight. These limits are indicated on pertinent airplane specifications.
- **Center-of-gravity range**—is the distance between the forward and aft CG limits indicated on pertinent airplane specifications.
- **Datum (reference datum)**—is an imaginary vertical plane or line from which all measurements of arm are taken. The datum is established by the manufacturer. Once the datum has been selected, all moment arms and the location of CG range are measured from this point.
- **Delta**—is a Greek letter expressed by the symbol  $\Delta$  to indicate a change of values. As an example,  $\Delta$  CG indicates a change (or movement) of the CG.
- **Floor load limit**—is the maximum weight the floor can sustain per square inch/foot as provided by the manufacturer.
- **Fuel load**—is the expendable part of the load of the airplane. It includes only usable fuel, not fuel required to fill the lines or that which remains trapped in the tank sumps.
- **Licensed empty weight**—is the empty weight that consists of the airframe, engine(s), unusable fuel, and undrainable oil plus standard and optional equipment as specified in the equipment list. Some manufacturers used this term prior to GAMA standardization.
- **Maximum landing weight**—is the greatest weight that an airplane normally is allowed to have at landing.
- **Maximum ramp weight**—is the total weight of a loaded aircraft, and includes all fuel. It is greater than the takeoff weight due to the fuel that will be burned during the taxi and runup operations. Ramp weight may also be referred to as taxi weight.
- **Maximum takeoff weight**—is the maximum allowable weight for takeoff.
- **Maximum weight**—is the maximum authorized weight of the aircraft and all of its equipment as specified in the Type Certificate Data Sheets (TCDS) for the aircraft.
- **Maximum zero fuel weight (GAMA)**—is the maximum weight, exclusive of usable fuel.

- **Mean aerodynamic chord (MAC)**—is the average distance from the leading edge to the trailing edge of the wing.
- **Moment**—is the product of the weight of an item multiplied by its arm. Moments are expressed in pound-inches (lb-in). Total moment is the weight of the airplane multiplied by the distance between the datum and the CG.
- **Moment index (or index)**—is a moment divided by a constant such as 100, 1,000, or 10,000. The purpose of using a moment index is to simplify weight and balance computations of airplanes where heavy items and long arms result in large, unmanageable numbers.
- **Payload (GAMA)**—is the weight of occupants, cargo, and baggage.
- **Standard empty weight (GAMA)**—consists of the airframe, engines, and all items of operating equipment that have fixed locations and are permanently installed in the airplane; including fixed ballast, hydraulic fluid, unusable fuel, and full engine oil.
- **Standard weights**—have been established for numerous items involved in weight and balance computations. These weights should not be used if actual weights are available. Some of the standard weights are:

---

Gasoline . . . . .	6 lb/US gal
Jet A, Jet A-1 . . . . .	6.8 lb/US gal
Jet B . . . . .	6.5 lb/US gal
Oil . . . . .	7.5 lb/US gal
Water . . . . .	8.35 lb/US gal

---

- **Station**—is a location in the airplane that is identified by a number designating its distance in inches from the datum. The datum is, therefore, identified as station zero. An item located at station +50 would have an arm of 50 inches.
- **Useful load**—is the weight of the pilot, copilot, passengers, baggage, usable fuel, and drainable oil. It is the basic empty weight subtracted from the maximum allowable gross weight. This term applies to general aviation aircraft only.

## BASIC PRINCIPLES OF WEIGHT AND BALANCE COMPUTATIONS

It might be advantageous at this point to review and discuss some of the basic principles of how weight and balance can be determined. The following method of computation can be applied to any object or vehicle where weight and balance information is essential; but

to fulfill the purpose of this handbook, it is directed primarily toward the airplane.

By determining the weight of the empty airplane and adding the weight of everything loaded on the airplane, a total weight can be determined. This is quite simple; but to distribute this weight in such a manner that the entire mass of the loaded airplane is balanced around a point (CG), which must be located within specified limits, presents a greater problem, particularly if the basic principles of weight and balance are not understood.

The point where the airplane will balance can be determined by locating the center of gravity, which is, as stated in the definitions of terms, the imaginary point where all the weight is concentrated. To provide the necessary balance between longitudinal stability and elevator control, the center of gravity is usually located slightly forward of the center of lift. This loading condition causes a nose-down tendency in flight, which is desirable during flight at a high angle of attack and slow speeds.

A safe zone within which the balance point (CG) must fall is called the CG range. The extremities of the range are called the forward CG limits and aft CG limits. These limits are usually specified in inches, along the longitudinal axis of the airplane, measured from a datum reference. The datum is an arbitrary point, established by airplane designers, which may vary in location between different airplanes. [Figure 8-2]

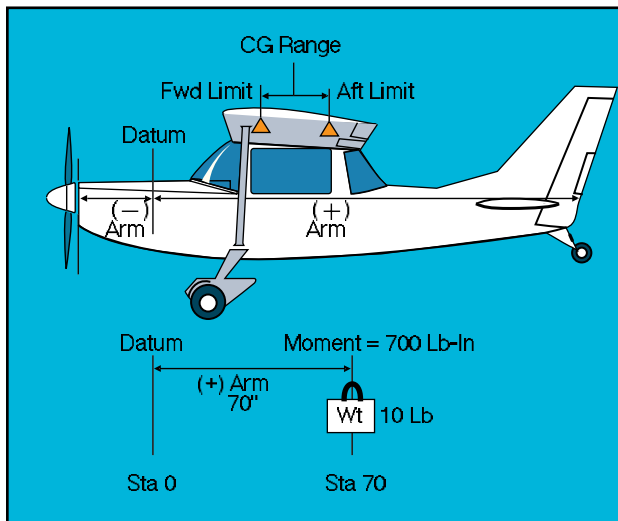

Figure 8-2. Weight and balance illustrated.

The distance from the datum to any component part of the airplane, or any object loaded on the airplane, is called the arm. When the object or component is located aft of the datum, it is measured in positive inches; if located forward of the datum, it is measured as negative inches, or minus inches. The location of the object or part is often referred to as the station. If

the weight of any object or component is multiplied by the distance from the datum (arm), the product is the moment. The moment is the measurement of the gravitational force that causes a tendency of the weight to rotate about a point or axis and is expressed in pound-inches.

To illustrate, assume a weight of 50 pounds is placed on the board at a station or point 100 inches from the datum. The downward force of the weight can be determined by multiplying 50 pounds by 100 inches, which produces a moment of 5,000 lb-in. [Figure 8-3]

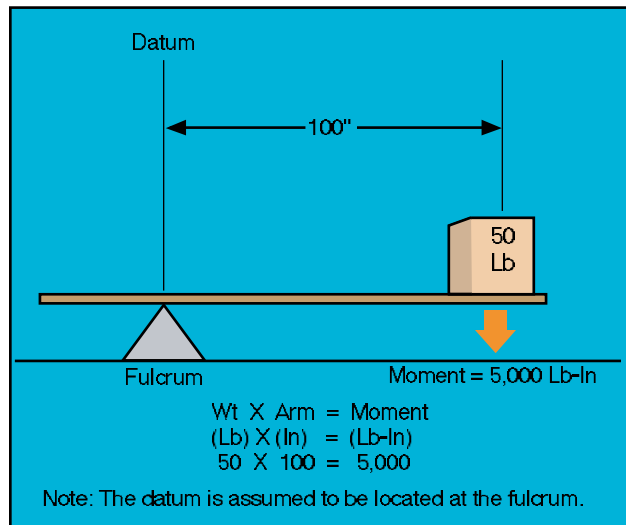

Figure 8-3. Determining moments.

To establish a balance, a total of 5,000 lb-in must be applied to the other end of the board. Any combination of weight and distance which, when multiplied, produces a 5,000 lb-in moment will balance the board. For example, as illustrated in figure 8-4, if a 100-pound weight is placed at a point (station) 25 inches from the datum, and another 50-pound weight is placed at a point (station) 50 inches from the datum, the sum of the product of the two weights and their distances will total a moment of 5,000 lb-in, which will balance the board.

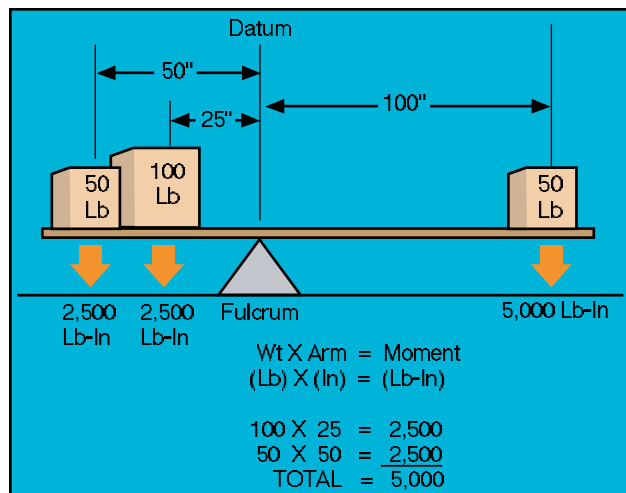

Figure 8-4. Establishing a balance.

## WEIGHT AND BALANCE RESTRICTIONS

The airplane's weight and balance restrictions should be closely followed. The loading conditions and empty weight of a particular airplane may differ from that found in the AFM/POH because modifications or equipment changes may have been made. Sample loading problems in the AFM/POH are intended for guidance only; therefore, each airplane must be treated separately. Although an airplane is certified for a specified maximum gross takeoff weight, it will not safely take off with this load under all conditions. Conditions that affect takeoff and climb performance such as high elevations, high temperatures, and high humidity (high-density altitudes) may require a reduction in weight before flight is attempted. Other factors to consider prior to takeoff are runway length, runway surface, runway slope, surface wind, and the presence of obstacles. These factors may require a reduction in weight prior to flight.

Some airplanes are designed so that it is difficult to load them in a manner that will place the CG out of limits. These are usually small airplanes with the seats, fuel, and baggage areas located near the CG limit. These airplanes, however, can be overloaded in weight.

Other airplanes can be loaded in such a manner that they will be out of CG limits even though the useful load has not been exceeded.

Because of the effects of an out-of-balance or overweight condition, a pilot should always be sure that an airplane is properly loaded.

## DETERMINING LOADED WEIGHT AND CENTER OF GRAVITY

There are various methods for determining the loaded weight and center of gravity of an aircraft. There is the computation method, as well as methods that utilize graphs and tables provided by the aircraft manufacturer.

### COMPUTATIONAL METHOD

The computational method involves the application of basic math functions. The following is an example of the computational method.

Given:

Maximum Gross Weight	3400 lb
Center-of-Gravity Range	78-86 in
Front Seat Occupants	340 lb
Rear Seat Occupants	350 lb
Fuel	75 gal
Baggage Area 1	80 lb

To determine the loaded weight and CG, follow these steps.

**Step 1**—List the weight of the airplane, occupants, fuel, and baggage. Remember that fuel weighs 6 pounds per gallon.

**Step 2**—Enter the moment for each item listed. Remember “weight x arm = moment.”

**Step 3**—Total the weight and moments.

**Step 4**—To determine the CG, divide the total moment by the total weight.

NOTE: The weight and balance records for a particular airplane will provide the empty weight and moment as well as the information on the arm distance.

Item	Weight	Arm	Moment
Airplane Empty Weight	2,100	78.3	164,430
Front Seat Occupants	340	85.0	28,900
Rear Seat Occupants	350	121.0	42,350
Fuel	450	75.0	33,750
Baggage Area 1	80	150.0	12,000
<b>Total</b>	<b>3,320</b>		<b>281,430</b>
			<b>281,430 divided by 3,320 = 84.8</b>

The total loaded weight of 3,320 pounds does not exceed the maximum gross weight of 3,400 pounds and the CG of 84.8 is within the 78-86 inch range; therefore, the airplane is loaded within limits.

### GRAPH METHOD

Another method for determining the loaded weight and CG is the use of graphs provided by the manufacturers. To simplify calculations, the moment may sometimes be divided by 100, 1,000, or 10,000. The following is an example of the graph method. [Figures 8-5 and 8-6]

Given:

Front Seat Occupants	340 lb
Rear Seat Occupants	300 lb
Fuel	40 gal
Baggage Area 1	20 lb

The same steps should be followed as in the computational method except the graphs provided will calculate the moments and allow the pilot to determine if the airplane is loaded within limits. To determine the

SAMPLE LOADING PROBLEM	Weight (Lb)	Moment (Lb-In/1000)
1. Basic Empty Weight (Use the data pertaining to your airplane as it is presently equipped.) Includes unusable fuel and full oil . . . . .	1,467	57.3
2. Usable Fuel (At 6 Lb/Gal)		
Standard Tanks (40 Gal Maximum) . . . . .	240	11.5
Long Range Tanks (50 Gal Maximum) . . . . .		
Integral Tanks (62 Gal Maximum). . . . .		
Integral Reduced Fuel (42 Gal) . . . . .		
3. Pilot and Front Passenger (Station 34 to 46) . . . . .	340	12.7
4. Rear Passengers . . . . .	300	21.8
5. Baggage Area 1 or Passenger on Child's Seat ( Station 82 to 108, 120 Lb Max) . . . . .	20	1.9
6. Baggage Area 2 (Station 108 to 142, 50 Lb Max.) . . . . .		
7. Weight and Moment	2,367	105.2

moment using the loading graph, find the weight and draw a line straight across until it intercepts the item for which the moment is to be calculated. Then draw a line straight down to determine the moment. (The red line on the loading graph represents the moment for the pilot and front passenger. All other moments were determined in the same way.) Once this has been done for each item, total the weight and moments and draw a line for both weight and moment on the center-of-gravity envelope graph. If the lines intersect within the envelope, the airplane is loaded within limits. In this sample loading problem, the airplane is loaded within limits.

Figure 8-5. Weight and balance data.

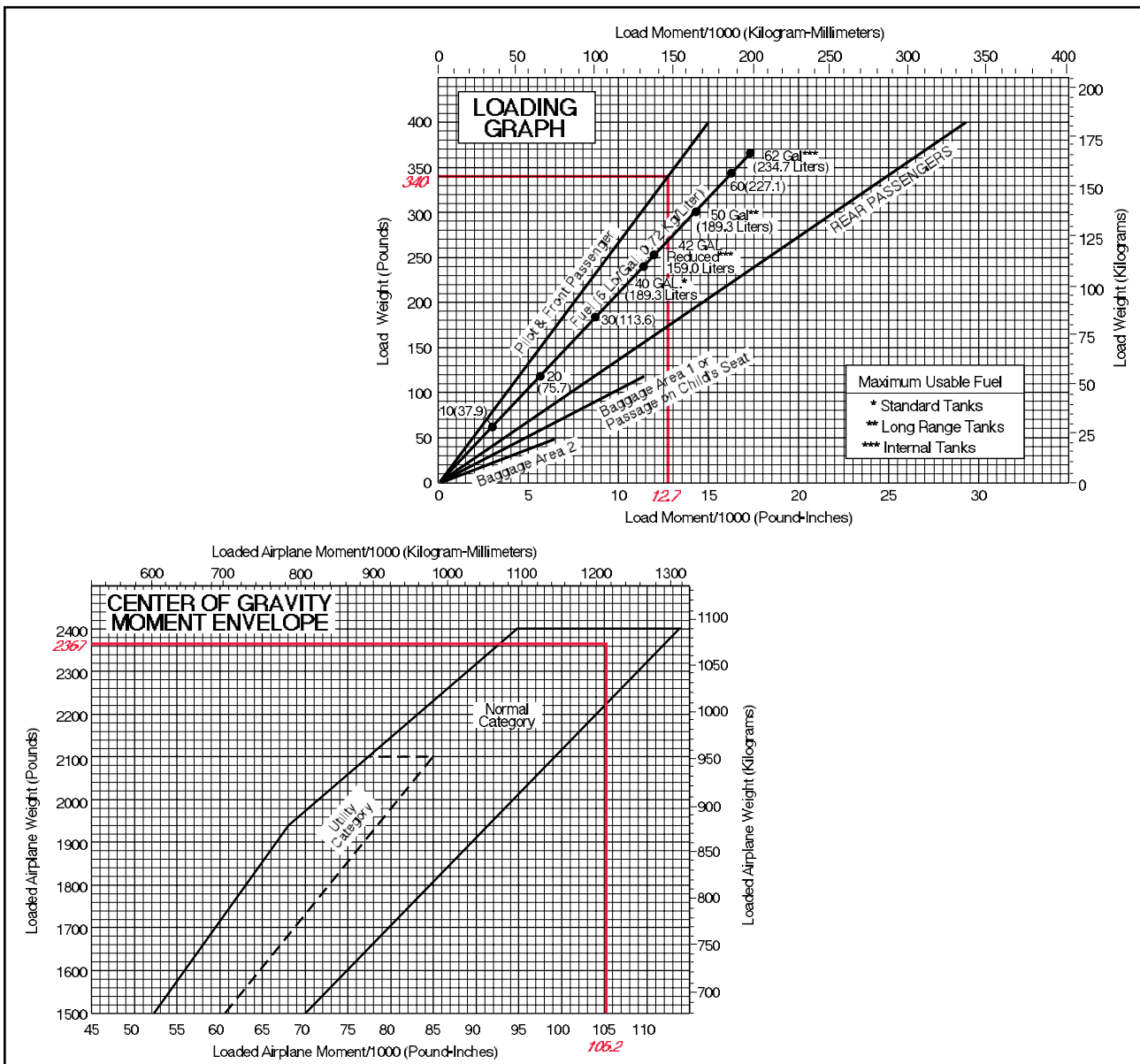

Figure 8-6. CG moment envelope and loading graph.

## TABLE METHOD

The table method applies the same principles as the computational and graph methods. The information and limitations are contained in tables provided by the manufacturer. Figure 8-7 is an example of a table and a weight and balance calculation based on that table. In this problem, the total weight of 2,799 pounds and moment of 2,278/100 are within the limits of the table.

## COMPUTATIONS WITH A NEGATIVE ARM

Figure 8-8 is a sample of weight and balance computation using an airplane with a negative arm. It is important to remember that a positive times a negative equals a negative, and a negative would be subtracted from the total moments.

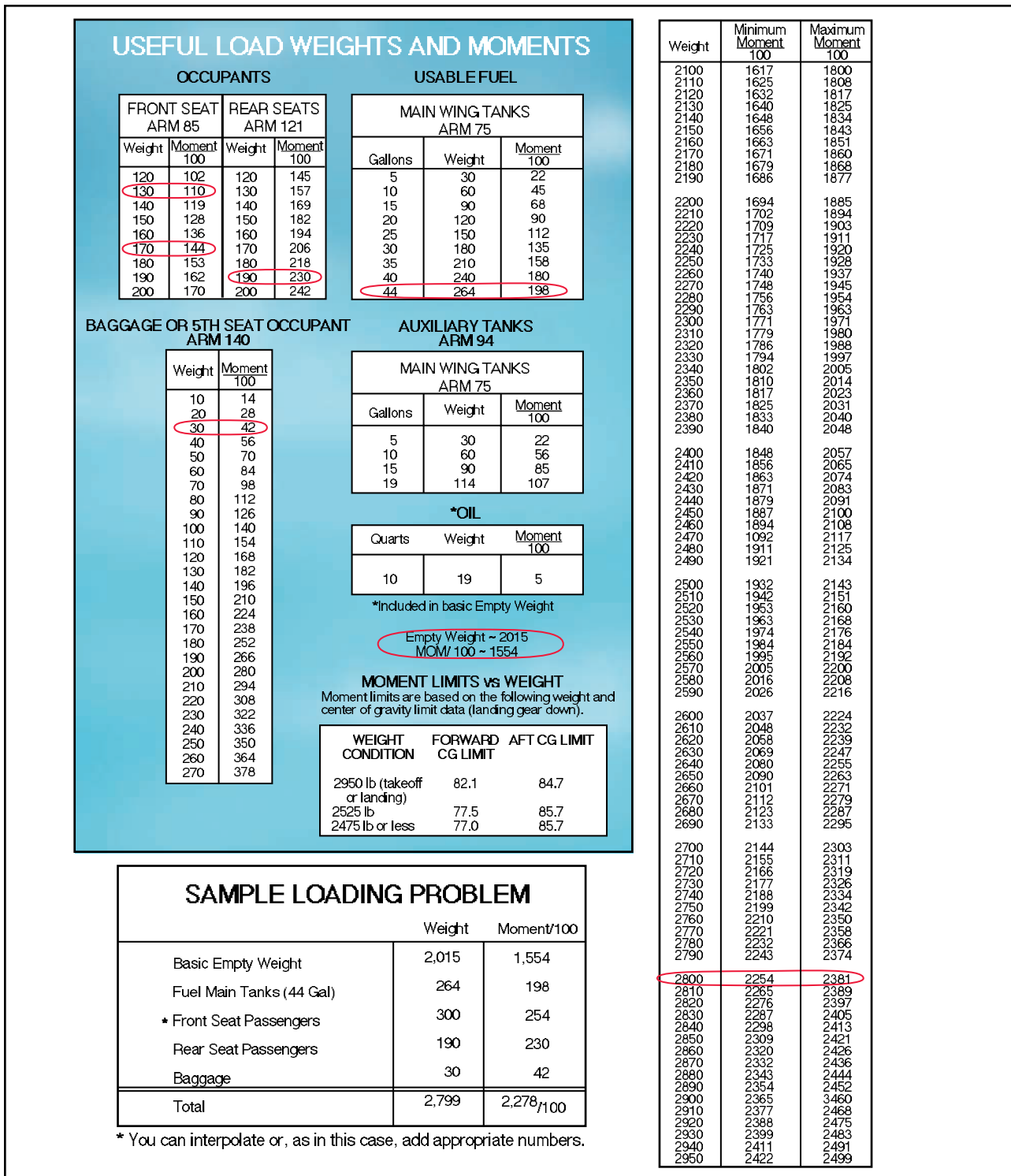

Figure 8-7. Loading schedule placard.

Item	Weight	Arm	Moment
Licensed Empty Weight	1,011.9	68.6	69,393.0
Oil (6 qt)	11.0	-31.0	-341.0
Fuel (18 gal)	108.0	84.0	9,072.0
Fuel, Auxiliary (18 gal)	108.0	84.0	9,072.0
Pilot	170.0	81.0	13,770.0
Passenger	170.0	81.0	13,770.0
Baggage	70.0	105.0	7,350.0
Total	1,648.9		122,086.0
CG		74.0	

Figure 8-8. Sample weight and balance using a negative.

### COMPUTATIONS WITH ZERO FUEL WEIGHT

Figure 8-9 is a sample of weight and balance computation using an airplane with a zero fuel weight. In this example, the total weight of the airplane less fuel is 4,240 pounds, which is under the zero fuel weight of 4,400 pounds. If the total weight of the airplane without fuel had exceeded 4,400 pounds, passengers or cargo would have to be reduced to bring the weight at or below the max zero fuel weight.

### SHIFTING, ADDING, AND REMOVING WEIGHT

A pilot must be able to accurately and rapidly solve any problems that involve the shift, addition, or removal of

Item	Weight	Arm	Moment
Basic Empty Weight	3,230	CG 90.5	292,315.0
Front Seat Occupants	335	89.0	2,9815.0
3 <sup>rd</sup> and 4 <sup>th</sup> Seat Occupants Fwd Facing	350	126.0	44,100.0
5 <sup>th</sup> and 6 <sup>th</sup> Seat Occupants	200	157.0	31,400.0
Nose Baggage	100	10.0	1,000.0
Aft Baggage	25	183.0	4,575.0
Zero Fuel Weight Max 4400 lb. Sub Total	4,240	CG 95.1	403,205.0
Fuel	822	113.0	92,886.0
Ramp Weight Max 5224 lb. Sub Total Ramp Weight	5,062	CG 98.0	496,091.0
* Less Fuel for Start, Taxi, and Takeoff	-24	113.0	-2,712.0
Sub Total Takeoff Weight	5,038	CG 97.9	493,379.0
Less Fuel to Destination	-450	113.0	-50,850.0
Max Landing Weight 4940 lb. Actual Landing Weight	4,588	CG 96.5	442,529.0
*Fuel for Start, Taxi, and Takeoff is normally 24 lb.			

Figure 8-9. Sample weight and balance using an airplane with a published zero fuel weight.

weight. For example, the pilot may load the aircraft within the allowable takeoff weight limit, then find a CG limit has been exceeded. The most satisfactory solution to this problem is to shift baggage, passengers, or both. The pilot should be able to determine the minimum load shift needed to make the aircraft safe for flight. Pilots should be able to determine if shifting a load to a new location will correct an out-of-limit condition. There are some standardized calculations that can help make these determinations.

### WEIGHT SHIFTING

When weight is shifted from one location to another, the total weight of the aircraft is unchanged. The total moments, however, do change in relation and proportion to the direction and distance the weight is moved. When weight is moved forward, the total moments decrease; when weight is moved aft, total moments increase. The moment change is proportional to the amount of weight moved. Since many aircraft have forward and aft baggage compartments, weight may be shifted from one to the other to change the CG. If starting with a known aircraft weight, CG, and total moments, calculate the new CG (after the weight shift) by dividing the new total moments by the total aircraft weight.

To determine the new total moments, find out how many moments are gained or lost when the weight is shifted. Assume that 100 pounds has been shifted from station 30 to station 150. This movement increases the total moments of the aircraft by 12,000 lb-in.

Moment when

$$\text{at station 150} = 100 \text{ lb} \times 150 \text{ in} = 15,000 \text{ lb-in}$$

Moment when

$$\text{at station 30} = 100 \text{ lb} \times 30 \text{ in} = 3,000 \text{ lb-in}$$

Moment change = 12,000 lb-in

By adding the moment change to the original moment (or subtracting if the weight has been moved forward instead of aft), the new total moments are obtained. Then determine the new CG by dividing the new moments by the total weight:

$$\text{Total moments} = 616,000 + 12,000 = 628,000$$

$$\text{CG} = \frac{628,000}{8,000 \text{ (Total weight)}} = 78.5 \text{ in}$$

The shift has caused the CG to shift to station 78.5

A simpler solution may be obtained by using a computer or calculator and a proportional formula. This can be done because the CG will shift a distance that is proportional to the distance the weight is shifted.

**EXAMPLE**

$$\frac{\text{Weight Shifted}}{\text{Total Weight}} = \frac{\Delta\text{CG (change of CG)}}{\text{Distance weight is shifted}}$$

$$\frac{100}{8,000} = \frac{\Delta\text{CG}}{120}$$

$$\Delta\text{CG} = 1.5 \text{ in}$$

The change of CG is added to (or subtracted from when appropriate) the original CG to determine the new CG:

$$77 + 1.5 = 78.5 \text{ inches aft of datum}$$

The shifting weight proportion formula can also be used to determine how much weight must be shifted to achieve a particular shift of the CG. The following problem illustrates a solution of this type.

**EXAMPLE**

Given:

Aircraft Total Weight	.....	7,800 lb
CG	.....	Station 81.5
Aft CG Limit	.....	80.5

Determine how much cargo must be shifted from the aft cargo compartment at station 150 to the forward cargo compartment at station 30 to move the CG to exactly the aft limit.

Solution:

$$\frac{\text{Weight to be Shifted}}{\text{Total Weight}} = \frac{\Delta\text{CG}}{\text{Distance weight is shifted}}$$

$$\frac{\text{Weight to be Shifted}}{7,800} = \frac{1.0 \text{ in}}{120 \text{ in}}$$

$$\text{Weight to be Shifted} = 65 \text{ lb}$$

**WEIGHT ADDITION OR REMOVAL**

In many instances, the weight and balance of the aircraft will be changed by the addition or removal of weight. When this happens, a new CG must be calculated and checked against the limitations to see if the location is acceptable. This type of weight and balance problem is commonly encountered when the aircraft burns fuel in flight, thereby reducing the weight located at the fuel tanks. Most small aircraft are designed with the fuel tanks positioned close to the CG; therefore, the consumption of fuel does not affect the CG to any great extent.

The addition or removal of cargo presents a CG change problem that must be calculated before flight. The problem may always be solved by calculations involving total moments. A typical problem may involve the calculation of a new CG for an aircraft which, when loaded and ready for flight, receives some additional cargo or passengers just before departure time.

**EXAMPLE**

Given:

Aircraft Total Weight	.....	6,860 lb
CG Station	.....	80.0

Determine the location of the CG if 140 pounds of baggage is added to station 150.

Solution:

$$\frac{\text{Added Weight}}{\text{New Total Weight}} = \frac{\Delta\text{CG}}{\text{Distance between weight and old CG}}$$

$$\frac{140}{6,860 + 140} = \frac{\Delta\text{CG}}{150 - 80}$$

$$\frac{140}{7,000} = \frac{\Delta\text{CG}}{70}$$

$$\text{CG} = 1.4 \text{ in aft}$$

Add  $\Delta\text{CG}$  to old CG  
New CG = 80.0 in + 1.4 in = 81.4 in

**EXAMPLE**

Given:

Aircraft Total Weight	.....	6,100 lb
CG Station	.....	80.0

Determine the location of the CG if 100 pounds is removed from station 150.

Solution:

$$\frac{\text{Weight Removed}}{\text{New Total Weight}} = \frac{\Delta\text{CG}}{\text{Distance between weight and old CG}}$$

$$\frac{100}{6,100 - 100} = \frac{\Delta\text{CG}}{150 - 80}$$

$$\frac{100}{6,000} = \frac{\Delta\text{CG}}{70}$$

$$\text{CG} = 1.2 \text{ in forward}$$

Subtract  $\Delta\text{CG}$  from old CG  
New CG = 80 in - 1.2 in = 78.8 in

In the previous examples, the  $\Delta\text{CG}$  is either added or subtracted from the old CG. Deciding which to accomplish is best handled by mentally calculating which way the CG will shift for the particular weight change. If the CG is shifting aft, the  $\Delta\text{CG}$  is added to the old CG; if the CG is shifting forward, the  $\Delta\text{CG}$  is subtracted from the old CG.

# Chapter 9

## Aircraft Performance

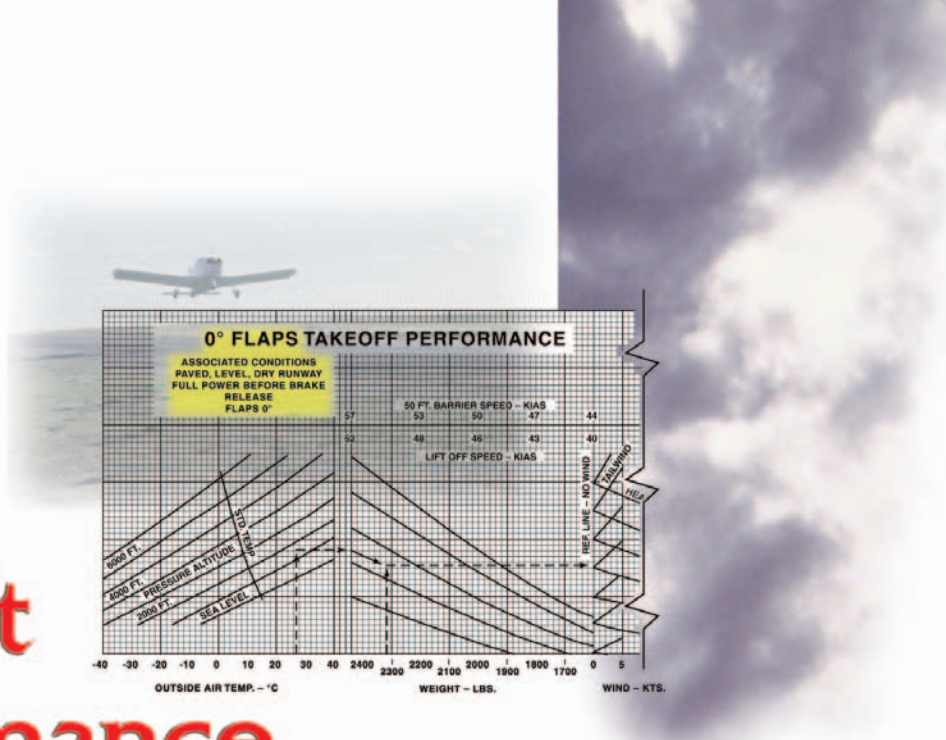

This chapter discusses the factors that affect airplane performance, which includes the airplane weight, atmospheric conditions, runway environment, and the fundamental physical laws governing the forces acting on an airplane.

### IMPORTANCE OF PERFORMANCE DATA

The performance or operational information section of the Airplane Flight Manual/Pilot's Operating Handbook (AFM/POH) contains the operating data for the airplane; that is, the data pertaining to takeoff, climb, range, endurance, descent, and landing. The use of this data in flying operations is mandatory for safe and efficient operation. Considerable knowledge and familiarity of the airplane can be gained through study of this material.

It must be emphasized that the manufacturers' information and data furnished in the AFM/POH is not standardized. Some provide the data in tabular form, while others use graphs. In addition, the performance data may be presented on the basis of standard atmospheric conditions, pressure altitude, or density altitude. The performance information in the AFM/POH has little or no value unless the user recognizes those variations and makes the necessary adjustments.

To be able to make practical use of the airplane's capabilities and limitations, it is essential to understand the significance of the operational data. The pilot must be cognizant of the basis for the performance data, as well as the meanings of the various terms used in expressing performance capabilities and limitations.

Since the characteristics of the atmosphere have a predominant effect on performance, it is necessary to review some of the dominant factors—pressure and temperature.

### STRUCTURE OF THE ATMOSPHERE

The atmosphere is an envelope of air that surrounds the earth and rests upon its surface. It is as much a part of the earth as the seas or the land. However, air differs from land and water inasmuch as it is a mixture of gases. It has mass, weight, and indefinite shape.

Air, like any other fluid, is able to flow and change its shape when subjected to even minute pressures because of the lack of strong molecular cohesion. For example, gas will completely fill any container into which it is placed, expanding or contracting to adjust its shape to the limits of the container.

The atmosphere is composed of 78 percent nitrogen, 21 percent oxygen, and 1 percent other gases, such as argon or helium. Most of the oxygen is contained below 35,000 feet altitude.

### ATMOSPHERIC PRESSURE

Though there are various kinds of pressure, pilots are mainly concerned with atmospheric pressure. It is one of the basic factors in weather changes, helps to lift the airplane, and actuates some of the important flight instruments in the airplane. These instruments are the altimeter, the airspeed indicator, the rate-of-climb indicator, and the manifold pressure gauge.

Though air is very light, it has mass and is affected by the attraction of gravity. Therefore, like any other



substance, it has weight, and because of its weight, it has force. Since it is a fluid substance, this force is exerted equally in all directions, and its effect on bodies within the air is called pressure. Under standard conditions at sea level, the average pressure exerted by the weight of the atmosphere is approximately 14.7 lb./in. The density of air has significant effects on the airplane's performance. As air becomes less dense, it reduces:

- power because the engine takes in less air,
- thrust because the propeller is less efficient in thin air, and
- lift because the thin air exerts less force on the airfoils.

The pressure of the atmosphere varies with time and location. Due to the changing atmospheric pressure, a standard reference was developed. The standard atmosphere at sea level is a surface temperature of 59°F or 15°C and a surface pressure of 29.92 in. Hg or 1013.2 millibars. [Figure 9-1]

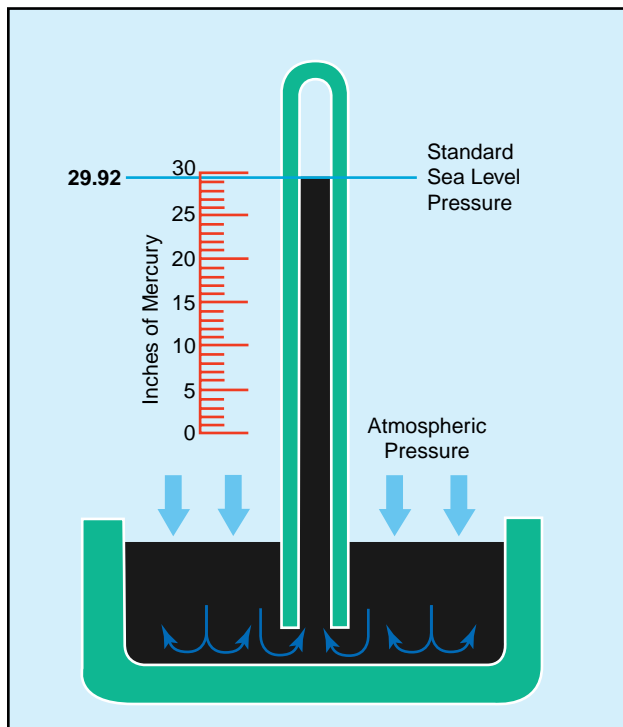

Figure 9-1. Standard sea level pressure.

A standard temperature lapse rate is one in which the temperature decreases at the rate of approximately 3.5°F or 2°C per thousand feet up to 36,000 feet. Above this point, the temperature is considered constant up to 80,000 feet. A standard pressure lapse rate is one in which pressure decreases at a rate of approximately 1 in. Hg per 1,000 feet of altitude gain to 10,000 feet. [Figure 9-2] The International Civil Aviation Organization (ICAO) has established this as a worldwide standard, and it is often referred to as

**International Standard Atmosphere (ISA)** or ICAO Standard Atmosphere. Any temperature or pressure that differs from the standard lapse rates is considered non-standard temperature and pressure. Adjustments for nonstandard temperatures and pressures are provided on the manufacturer's performance charts.

Standard Atmosphere			
Altitude (ft)	Pressure (in. Hg)	Temp. (°C)	Temp. (°F)
0	29.92	15.0	59.0
1,000	28.86	13.0	55.4
2,000	27.82	11.0	51.9
3,000	26.82	9.1	48.3
4,000	25.84	7.1	44.7
5,000	24.89	5.1	41.2
6,000	23.98	3.1	37.6
7,000	23.09	1.1	34.0
8,000	22.22	-0.9	30.5
9,000	21.38	-2.8	26.9
10,000	20.57	-4.8	23.3
11,000	19.79	-6.8	19.8
12,000	19.02	-8.8	16.2
13,000	18.29	-10.8	12.6
14,000	17.57	-12.7	9.1
15,000	16.88	-14.7	5.5
16,000	16.21	-16.7	1.9
17,000	15.56	-18.7	-1.6
18,000	14.94	-20.7	-5.2
19,000	14.33	-22.6	-8.8
20,000	13.74	-24.6	-12.3

Figure 9-2. Properties of standard atmosphere.

Since all airplane performance is compared and evaluated with respect to the standard atmosphere, all aircraft instruments are calibrated for the standard atmosphere. Thus, certain corrections must apply to the instrumentation, as well as the airplane performance, if the actual operating conditions do not fit the standard atmosphere. In order to account properly for the non-standard atmosphere, certain related terms must be defined.

## PRESSURE ALTITUDE

Pressure altitude is the height above a standard datum plane. The airplane altimeter is essentially a sensitive barometer calibrated to indicate altitude in the standard atmosphere. If the altimeter is set for 29.92 in. Hg Standard Datum Plane (SDP), the altitude indicated is the pressure altitude—the altitude in the standard atmosphere corresponding to the sensed pressure.

The SDP is a theoretical level where the weight of the atmosphere is 29.92 in. Hg as measured by a barometer. As atmospheric pressure changes, the SDP may be below, at, or above sea level. Pressure altitude is important as a

**International Standard Atmosphere (ISA)**—Also known as a standard day. A representative model of atmospheric air pressure, temperature, and density at various altitudes for reference purposes. At sea level, the ISA has a temperature of 59°F or 15°C and a pressure of 29.92 in. Hg or 1013.2 millibars.

**Pressure Altitude**—The height above a standard datum plane.

basis for determining airplane performance as well as for assigning flight levels to airplanes operating at above 18,000 feet.

The pressure altitude can be determined by either of two methods:

1. by setting the barometric scale of the altimeter to 29.92 and reading the indicated altitude, or
2. by applying a correction factor to the indicated altitude according to the reported “altimeter setting.”

## DENSITY ALTITUDE

The more appropriate term for correlating aerodynamic performance in the nonstandard atmosphere is **density altitude**—the altitude in the standard atmosphere corresponding to a particular value of air density.

Density altitude is pressure altitude corrected for nonstandard temperature. As the density of the air increases (lower density altitude), airplane performance increases and conversely as air density decreases (higher density altitude), airplane performance decreases. *A decrease in air density means a high density altitude; and an increase in air density means a lower density altitude.* Density altitude is used in calculating airplane performance. Under standard atmospheric condition, air at each level in the atmosphere has a specific density, and under standard conditions, pressure altitude and density altitude identify the same level. Density altitude, then, is the vertical distance above sea level in the standard atmosphere at which a given density is to be found.

The computation of density altitude must involve consideration of pressure (pressure altitude) and temperature. Since airplane performance data at any level is based upon air density under standard day conditions, such performance data apply to air density levels that may not be identical with altimeter indications. Under conditions higher or lower than standard, these levels cannot be determined directly from the altimeter.

Density altitude is determined by first finding pressure altitude, and then correcting this altitude for nonstandard temperature variations. Since density varies directly with pressure, and inversely with temperature, a given pressure altitude may exist for a wide range of temperature by allowing the density to vary. However, a known density occurs for any one temperature and pressure altitude. The density of the air, of course, has a pronounced effect on airplane and engine performance. Regardless of the actual altitude at which the airplane is operating, it will perform as though it were operating at an altitude equal to the existing density altitude.

For example, when set at 29.92, the altimeter may indicate a pressure altitude of 5,000 feet. According to the

**Density Altitude**—Pressure altitude corrected for nonstandard temperature.

AFM/POH, the ground run on takeoff may require a distance of 790 feet under standard temperature conditions. However, if the temperature is 20°C above standard, the expansion of air raises the density level. Using temperature correction data from tables or graphs, or by deriving the density altitude with a computer, it may be found that the density level is above 7,000 feet, and the ground run may be closer to 1,000 feet.

Air density is affected by changes in altitude, temperature, and humidity. High density altitude refers to thin air while low density altitude refers to dense air. The conditions that result in a high density altitude are high elevations, low atmospheric pressures, high temperatures, high humidity, or some combination of these factors. Lower elevations, high atmospheric pressure, low temperatures, and low humidity are more indicative of low density altitude.

Using a flight computer, density altitude can be computed by inputting the pressure altitude and outside air temperature at flight level. Density altitude can also be determined by referring to the table and chart in figures 9-3 and 9-4.

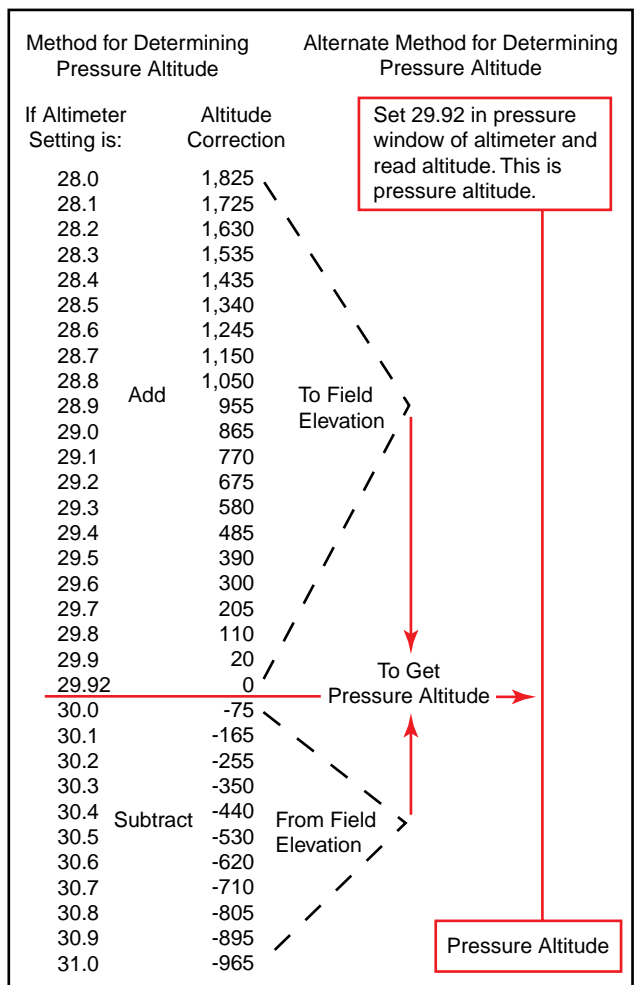

Figure 9-3. Field elevation versus pressure altitude.

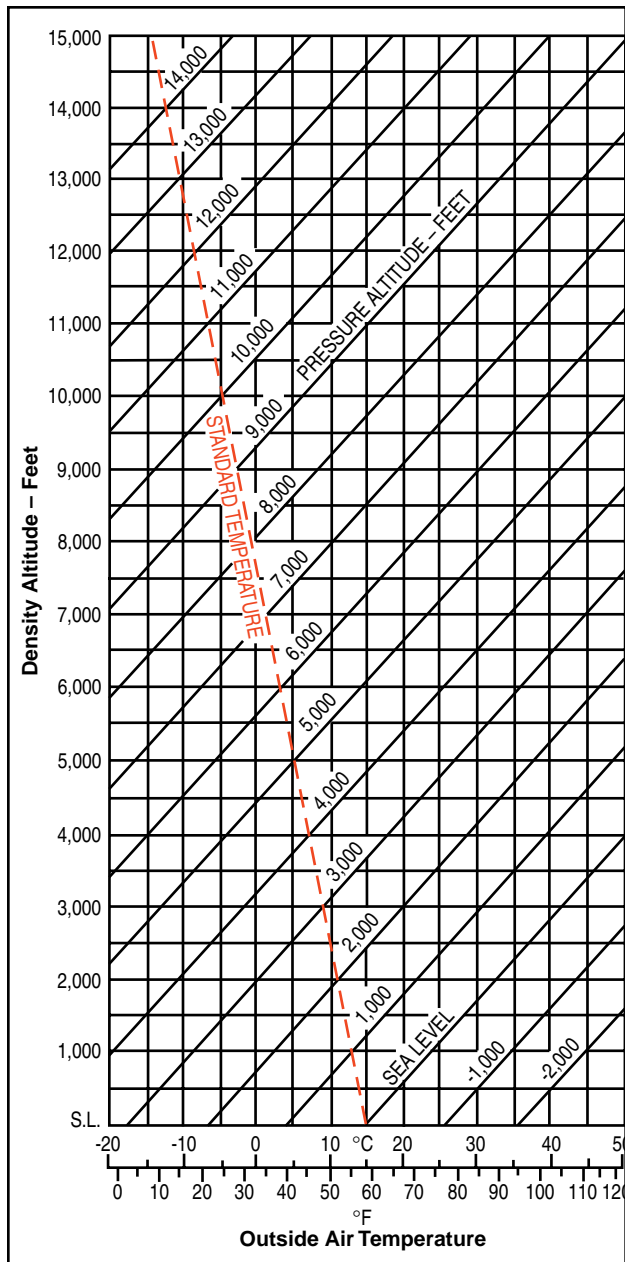

Figure 9-4. Density altitude chart.

### EFFECTS OF PRESSURE ON DENSITY

Since air is a gas, it can be compressed or expanded. When air is compressed, a greater amount of air can occupy a given volume. Conversely, when pressure on a given volume of air is decreased, the air expands and occupies a greater space. That is, the original column of air at a lower pressure contains a smaller mass of air. In other words, the density is decreased. In fact, density is directly proportional to pressure. If the pressure is doubled, the density is doubled, and if the pressure is lowered, so is the density. This statement is true only at a constant temperature.

### EFFECT OF TEMPERATURE ON DENSITY

Increasing the temperature of a substance decreases its density. Conversely, decreasing the temperature

increases the density. Thus, the density of air varies inversely with temperature. This statement is true only at a constant pressure.

In the atmosphere, both temperature and pressure decrease with altitude, and have conflicting effects upon density. However, the fairly rapid drop in pressure as altitude is increased usually has the dominating effect. Hence, pilots can expect the density to decrease with altitude.

### EFFECT OF HUMIDITY (MOISTURE) ON DENSITY

The preceding paragraphs have assumed that the air was perfectly dry. In reality, it is never completely dry. The small amount of water vapor suspended in the atmosphere may be almost negligible under certain conditions, but in other conditions humidity may become an important factor in the performance of an airplane. Water vapor is lighter than air; consequently, moist air is lighter than dry air. Therefore, as the water content of the air increases, the air becomes less dense, increasing density altitude and decreasing performance. It is lightest or least dense when, in a given set of conditions, it contains the maximum amount of water vapor.

Humidity, also called “**relative humidity**,” refers to the amount of water vapor contained in the atmosphere, and is expressed as a percentage of the maximum amount of water vapor the air can hold. This amount varies with the temperature; warm air can hold more water vapor, while colder air can hold less. Perfectly dry air that contains no water vapor has a relative humidity of 0 percent, while saturated air, that cannot hold any more water vapor, has a relative humidity of 100 percent. Humidity alone is usually not considered an important factor in calculating density altitude and airplane performance; however, it does contribute.

The higher the temperature, the greater amount of water vapor that the air can hold. When comparing two separate air masses, the first warm and moist (both qualities tending to lighten the air) and the second cold and dry (both qualities making it heavier), the first necessarily must be less dense than the second. Pressure, temperature, and humidity have a great influence on airplane performance because of their effect upon density. There are no rules-of-thumb or charts used to compute the effects of humidity on density altitude, so take this into consideration by expecting a decrease in overall performance in high humidity conditions.

### PERFORMANCE

“Performance” is a term used to describe the ability of an airplane to accomplish certain things that make it

**Relative Humidity**—The amount of water vapor contained in the air compared to the amount the air could hold.

useful for certain purposes. For example, the ability of the airplane to land and take off in a very short distance is an important factor to the pilot who operates in and out of short, unimproved airfields. The ability to carry heavy loads, fly at high altitudes at fast speeds, or travel long distances is essential performance for operators of airline and executive type airplanes.

The chief elements of performance are the takeoff and landing distance, rate of climb, ceiling, payload, range, speed, maneuverability, stability, and fuel economy. Some of these factors are often directly opposed: for example, high speed versus shortness of landing distance; long range versus great payload; and high rate of climb versus fuel economy. It is the preeminence of one or more of these factors which dictates differences between airplanes and which explains the high degree of specialization found in modern airplanes.

The various items of airplane performance result from the combination of airplane and powerplant characteristics. The aerodynamic characteristics of the airplane generally define the power and thrust requirements at various conditions of flight while powerplant characteristics generally define the power and thrust available at various conditions of flight. The matching of the aerodynamic configuration with the powerplant is accomplished by the manufacturer to provide maximum performance at the specific design condition; e.g., range, endurance, and climb.

### STRAIGHT-AND-LEVEL FLIGHT

All of the principal items of flight performance involve steady-state flight conditions and equilibrium of the airplane. For the airplane to remain in steady, level flight, equilibrium must be obtained by a lift equal to the airplane weight and a powerplant thrust equal to the airplane drag. Thus, the airplane drag defines the thrust required to maintain steady, level flight.

All parts of the airplane that are exposed to the air contribute to the drag, though only the wings provide lift of any significance. For this reason, and certain others related to it, the total drag may be divided into two parts: the wing drag (induced) and the drag of everything but the wings (parasite).

The total power required for flight then can be considered as the sum of induced and parasite effects; that is, the total drag of the airplane. Parasite drag is the sum of pressure and friction drag, which is due to the airplane's basic configuration and, as defined, is independent of lift. Induced drag is the undesirable but unavoidable consequence of the development of lift.

While the parasite drag predominates at high speed, induced drag predominates at low speed. [Figure 9-5] For example, if an airplane in a steady flight condition at 100 knots is then accelerated to 200 knots, the

parasite drag becomes four times as great, but the power required to overcome that drag is eight times the original value. Conversely, when the airplane is operated in steady, level flight at twice as great a speed, the induced drag is one-fourth the original value, and the power required to overcome that drag is only one-half the original value.

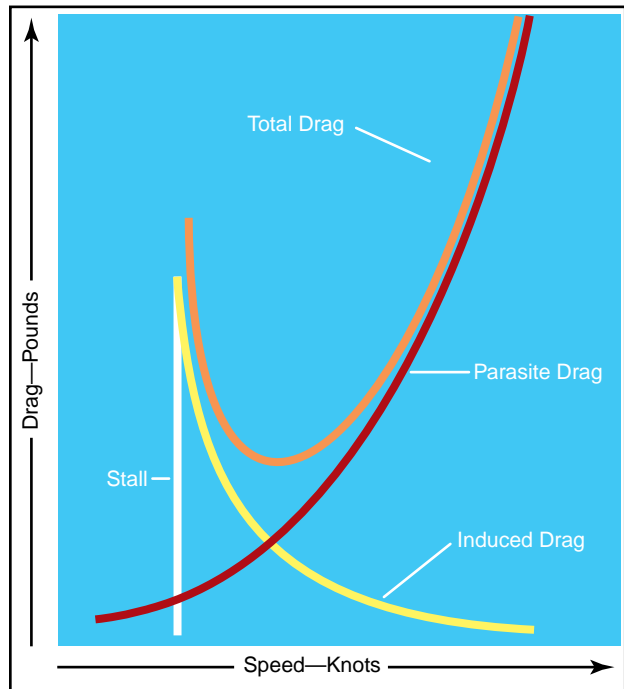

Figure 9-5. Drag versus speed.

The wing or induced drag changes with speed in a very different way, because of the changes in the angle of attack. Near the stalling speed, the wing is inclined to the relative wind at nearly the stalling angle, and its drag is very strong. But at cruise flying speed, with the angle of attack nearly zero, induced drag is minimal. After attaining cruise speed, the angle of attack changes very little with any further increase in speed, and the drag of the wing increases in direct proportion to any further increase in speed. This does not consider the factor of compressibility drag that is involved at speeds beyond 260 knots.

To sum up these changes, as the speed increases from stalling speed to VNE, the induced drag decreases and parasite drag increases.

When the airplane is in steady, level flight, the condition of equilibrium must prevail. The unaccelerated condition of flight is achieved with the airplane trimmed for lift equal to weight and the powerplant set for a thrust to equal the airplane drag.

The maximum level flight speed for the airplane will be obtained when the power or thrust required equals the maximum power or thrust available from the

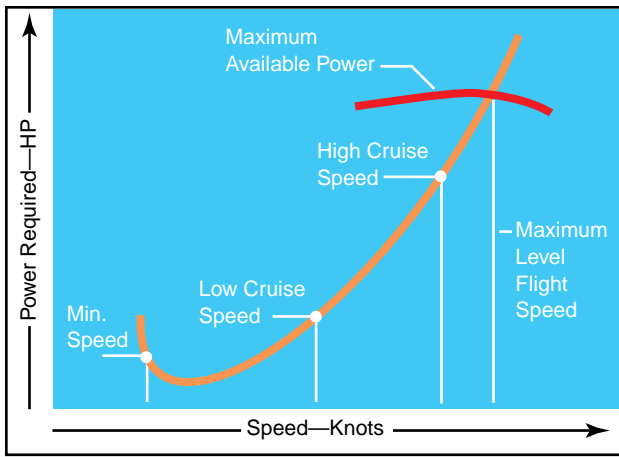

Figure 9-6. Power versus speed.

powerplant. [Figure 9-6] The minimum level flight airspeed is not usually defined by thrust or power requirement since conditions of stall or stability and control problems generally predominate.

### CLIMB PERFORMANCE

Climb depends upon the reserve power or thrust. Reserve power is the available power over and above that required to maintain horizontal flight at a given speed. Thus, if an airplane is equipped with an engine that produces 200 total available horsepower and the airplane requires only 130 horsepower at a certain level flight speed, the power available for climb is 70 horsepower.

Although the terms “**power**” and “**thrust**” are sometimes used interchangeably, erroneously implying that they are synonymous, it is important to distinguish between the two when discussing climb performance. **Work** is the product of a force moving through a distance and is usually independent of time. Work is measured by several standards; the most common unit is called a “foot-pound.” If a 1-pound mass is raised 1 foot, a work unit of 1 foot-pound has been performed. The common unit of mechanical power is horsepower; one horsepower is work equivalent to lifting 33,000 pounds a vertical distance of 1 foot in 1 minute. The term “power” implies work rate or units of work per unit of time, and as such is a function of the speed at which the force is developed. “Thrust,” also a function of work, means the force that imparts a change in the velocity of a mass. This force is measured in pounds but has no element of time or rate. It can be said then, that during a steady climb, the rate of climb is a function of excess thrust.

**Power**—Work rate or units of work per unit of time, and is a function of the speed at which the force is developed.

**Thrust**—Also a function of work and means the force that imparts a change in the velocity of a mass.

**Work**—The product of a force moving through a distance and is usually expressed in foot-pounds.

When the airplane is in steady, level flight or with a slight angle of climb, the vertical component of lift is very nearly the same as the actual total lift. Such climbing flight would exist with the lift very nearly equal to the weight. The net thrust of the powerplant may be inclined relative to the flightpath, but this effect will be neglected here for the sake of simplicity. Although the weight of the airplane acts vertically, a component of weight will act rearward along the flightpath. [Figure 9-7]

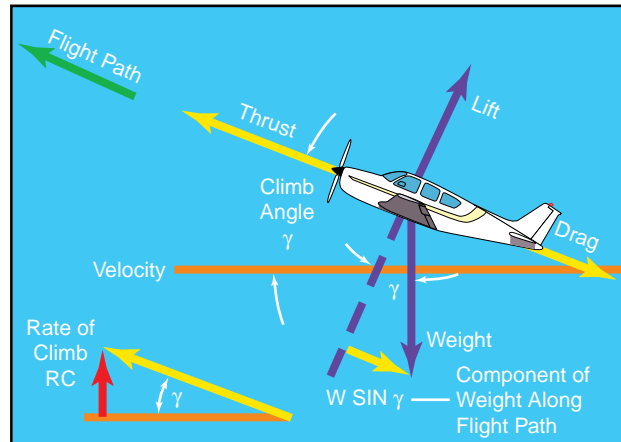

Figure 9-7. Weight has rearward component.

If it is assumed that the airplane is in a steady climb with essentially a small inclination of the flightpath, the summation of forces along the flightpath resolves to the following:

$$\text{Forces forward} = \text{Forces aft}$$

The basic relationship neglects some of the factors that may be of importance for airplanes of very high climb performance. (For example, a more detailed consideration would account for the inclination of thrust from the flightpath, lift not being equal to weight, and a subsequent change of induced drag.) However, this basic relationship will define the principal factors affecting climb performance.

This relationship means that, for a given weight of the airplane, the angle of climb depends on the difference between thrust and drag, or the excess thrust. [Figure 9-8] Of course, when the excess thrust is zero, the inclination of the flightpath is zero, and the airplane will be in steady, level flight. When the thrust is greater than the drag, the excess thrust will allow a climb angle depending on the value of excess thrust. On the other hand, when the thrust is less than the drag, the deficiency of thrust will allow an angle of descent.

The most immediate interest in the climb angle performance involves obstacle clearance. The most obvious purpose for which it might be used

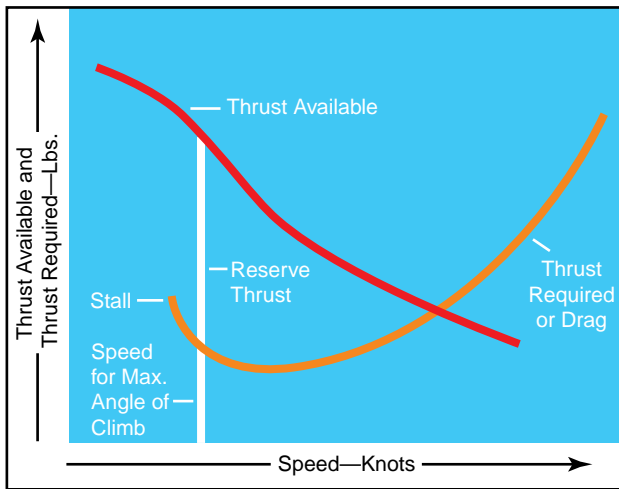

Figure 9-8. Thrust versus climb angle.

is to clear obstacles when climbing out of short or confined airports.

The maximum angle of climb would occur where there exists the greatest difference between thrust available and thrust required; i.e., for the propeller-powered airplane, the maximum excess thrust and angle of climb will occur at some speed just above the stall speed. Thus, if it is necessary to clear an obstacle after takeoff, the propeller-powered airplane will attain maximum angle of climb at an airspeed close to—if not at—the takeoff speed.

Of greater interest in climb performance are the factors that affect the rate of climb. The vertical velocity of an airplane depends on the flight speed and the inclination of the flightpath. In fact, the rate of climb is the vertical component of the flightpath velocity.

For rate of climb, the maximum rate would occur where there exists the greatest difference between power available and power required. [Figure 9-9] The above relationship means that, for a given weight of the

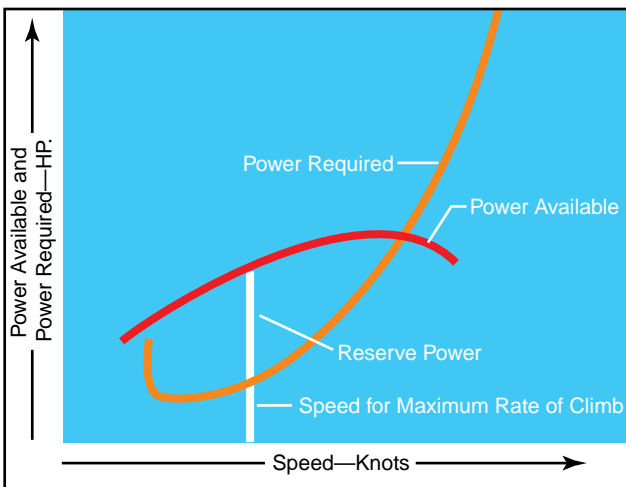

Figure 9-9. Power versus climb rate.

airplane, the rate of climb depends on the difference between the power available and the power required, or the excess power. Of course, when the excess power is zero, the rate of climb is zero and the airplane is in steady, level flight. When power available is greater than the power required, the excess power will allow a rate of climb specific to the magnitude of excess power.

During a steady climb, the rate of climb will depend on excess power while the angle of climb is a function of excess thrust.

The climb performance of an airplane is affected by certain variables. The conditions of the airplane's maximum climb angle or maximum climb rate occur at specific speeds, and variations in speed will produce variations in climb performance. There is sufficient latitude in most airplanes that small variations in speed from the optimum do not produce large changes in climb performance, and certain operational considerations may require speeds slightly different from the optimum. Of course, climb performance would be most critical with high gross weight, at high altitude, in obstructed takeoff areas, or during malfunction of a powerplant. Then, optimum climb speeds are necessary.

Weight has a very pronounced effect on airplane performance. If weight is added to the airplane, it must fly at a higher angle of attack to maintain a given altitude and speed. This increases the induced drag of the wings, as well as the parasite drag of the airplane. Increased drag means that additional thrust is needed to overcome it, which in turn means that less reserve thrust is available for climbing. Airplane designers go to great effort to minimize the weight since it has such a marked effect on the factors pertaining to performance.

A change in the airplane's weight produces a twofold effect on climb performance. First, a change in weight will change the drag and the power required. This alters the reserve power available, which in turn, affects both the climb angle and the climb rate. Secondly, an increase in weight will reduce the maximum rate of climb, but the airplane must be operated at a higher climb speed to achieve the smaller peak climb rate.

An increase in altitude also will increase the power required and decrease the power available. Therefore, the climb performance of an airplane diminishes with altitude. The speeds for maximum rate of climb, maximum angle of climb, and maximum and minimum level flight airspeeds vary with altitude. As altitude is increased, these various speeds finally converge at the absolute ceiling of the airplane. At the absolute ceiling, there is no excess of power and only one speed will

allow steady, level flight. Consequently, the absolute ceiling of the airplane produces zero rate of climb. The service ceiling is the altitude at which the airplane is unable to climb at a rate greater than 100 feet per minute. Usually, these specific performance reference points are provided for the airplane at a specific design configuration. [Figure 9-10]

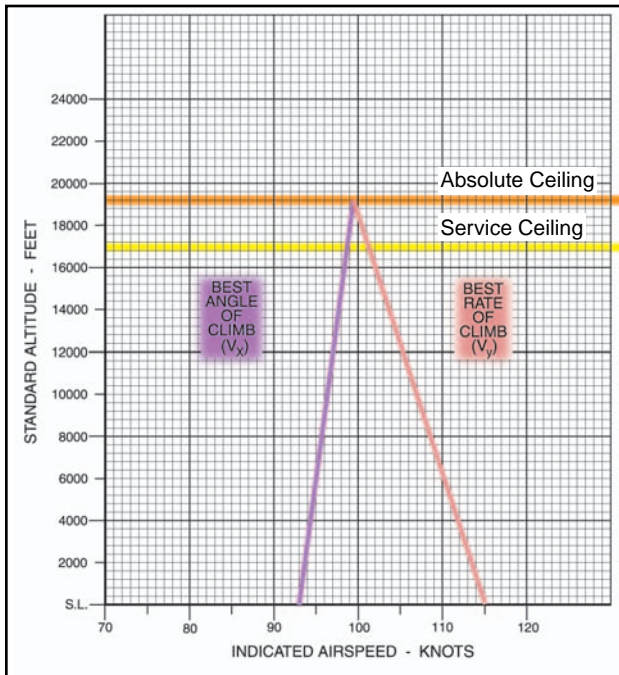

Figure 9-10. Absolute and service ceiling.

In discussing performance, it frequently is convenient to use the terms “power loading” and “wing loading.” Power loading is expressed in pounds per horsepower and is obtained by dividing the total weight of the airplane by the rated horsepower of the engine. It is a significant factor in the airplane’s takeoff and climb capabilities. Wing loading is expressed in pounds per square foot and is obtained by dividing the total weight of the airplane in pounds by the wing area (including ailerons) in square feet. It is the airplane’s wing loading that determines the landing speed. These factors are discussed in subsequent sections of this chapter.

### RANGE PERFORMANCE

The ability of an airplane to convert fuel energy into flying distance is one of the most important items of airplane performance. In flying operations, the problem of efficient range operation of an airplane appears in two general forms:

1. to extract the maximum flying distance from a given fuel load or,
2. to fly a specified distance with a minimum expenditure of fuel.

A common denominator for each of these operating problems is the “specific range”; that is, nautical miles

of flying distance per pound of fuel. Cruise flight operations for maximum range should be conducted so that the airplane obtains maximum specific range throughout the flight.

The specific range can be defined by the following relationship:

$$\text{specific range} = \frac{\text{nautical miles}}{\text{lb. of fuel}}$$

or,

$$\text{specific range} = \frac{\text{nautical miles/hr.}}{\text{lb. of fuel/hr.}}$$

or,

$$\text{specific range} = \frac{\text{knots}}{\text{fuel flow}}$$

If maximum specific range is desired, the flight condition must provide a maximum of speed per fuel flow.

Range must be clearly distinguished from the item of endurance. [Figure 9-11] The item of range involves consideration of flying distance, while endurance involves consideration of flying time. Thus, it is appropriate to define a separate term, “specific endurance.”

$$\text{specific endurance} = \frac{\text{flight hours}}{\text{lb. of fuel}}$$

or,

$$\text{specific endurance} = \frac{\text{flight hours/hr.}}{\text{lb. of fuel/hr.}}$$

or,

$$\text{specific endurance} = \frac{1}{\text{fuel flow}}$$

If maximum endurance is desired, the flight condition must provide a minimum of fuel flow. While the peak value of specific range would provide maximum range operation, long-range cruise operation is generally recommended at some slightly higher airspeed. Most long-range cruise operations are conducted at the flight condition that provides 99 percent of the absolute maximum specific range. The advantage of such operation is that 1 percent of range is traded for 3 to 5 percent higher cruise speed. Since the higher cruise speed has a great number of advantages, the small sacrifice of

range is a fair bargain. The values of specific range versus speed are affected by three principal variables:

1. airplane gross weight,
2. altitude, and
3. the external aerodynamic configuration of the airplane. These are the source of range and endurance operating data included in the performance section of the AFM/POH.

“Cruise control” of an airplane implies that the airplane is operated to maintain the recommended long-range cruise condition throughout the flight. Since fuel is consumed during cruise, the gross weight of the airplane will vary and optimum airspeed, altitude, and power setting can also vary. “Cruise control” means the control of the optimum airspeed, altitude, and power setting to maintain the 99 percent maximum specific range condition. At the beginning of cruise flight, the relatively high initial weight of the airplane will require specific values of airspeed, altitude, and power setting to produce the recommended cruise condition. As fuel is consumed and the airplane’s gross weight decreases, the optimum airspeed and power setting may decrease, or, the optimum altitude may increase. In addition, the optimum specific range will increase. Therefore, the pilot must provide the proper cruise control procedure to ensure that optimum conditions are maintained.

Total range is dependent on both fuel available and specific range. When range and economy of operation are the principal goals, the pilot must ensure that the airplane will be operated at the recommended long-range cruise condition. By this procedure, the airplane will be capable of its maximum design-operating radius, or can achieve flight distances less than the maximum with a maximum of fuel reserve at the destination.

The propeller-driven airplane combines the propeller with the reciprocating engine for propulsive power. In the case of the reciprocating engine, fuel flow is determined mainly by the shaft power put into the propeller rather than thrust. Thus, the fuel flow can be related directly to the power required to maintain the airplane in steady, level flight. This fact allows for the determination of range through analysis of power required versus speed.

The maximum endurance condition would be obtained at the point of minimum power required since this would require the lowest fuel flow to keep the airplane in steady, level flight. Maximum range condition would occur where the proportion between speed and power required is greatest. [Figure 9-11]

The maximum range condition is obtained at maximum lift/drag ratio (L/D max), and it is important to note that

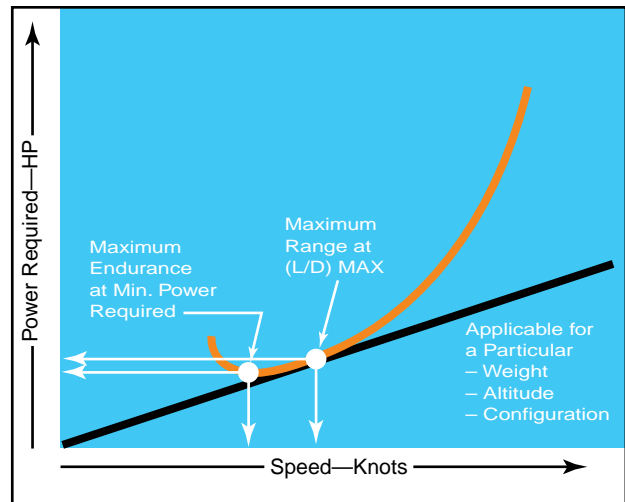

Figure 9-11. Airspeeds for maximum endurance vs. maximum range.

for a given airplane configuration, the maximum lift/drag ratio occurs at a particular angle of attack and lift coefficient, and is unaffected by weight or altitude. A variation in weight will alter the values of airspeed and power required to obtain the maximum lift/drag ratio. [Figure 9-12]

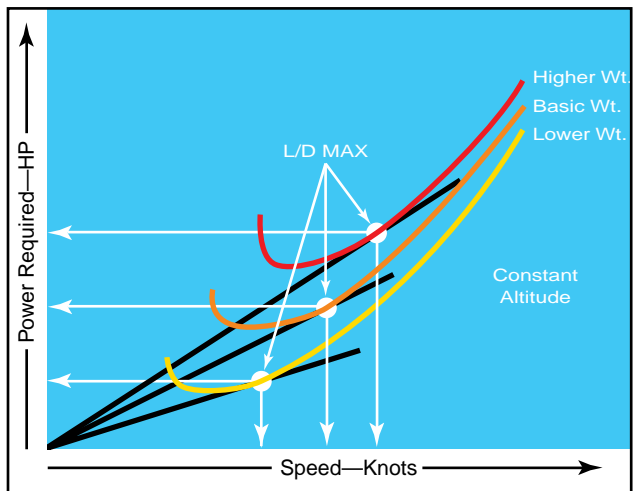

Figure 9-12. Effect of weight on speed for maximum range.

The variations of speed and power required must be monitored by the pilot as part of the cruise control procedure to maintain the maximum lift/drag ratio. When the airplane’s fuel weight is a small part of the gross weight and the airplane’s range is small, the cruise control procedure can be simplified to essentially maintaining a constant speed and power setting throughout the time of cruise flight. The long-range airplane has a fuel weight that is a considerable part of the gross weight, and cruise control procedures must employ scheduled airspeed and power changes to maintain optimum range conditions.



The effect of altitude on the range of the propeller-driven airplane may be understood by inspection of figure 9-13. A flight conducted at high altitude will have a greater true airspeed, and the power required will be proportionately greater than when conducted at sea level. The drag of the airplane at altitude is the same as the drag at sea level, but the higher true airspeed causes a proportionately greater power required. Note that the straight line that is tangent to the sea level power curve is also tangent to the altitude power curve.

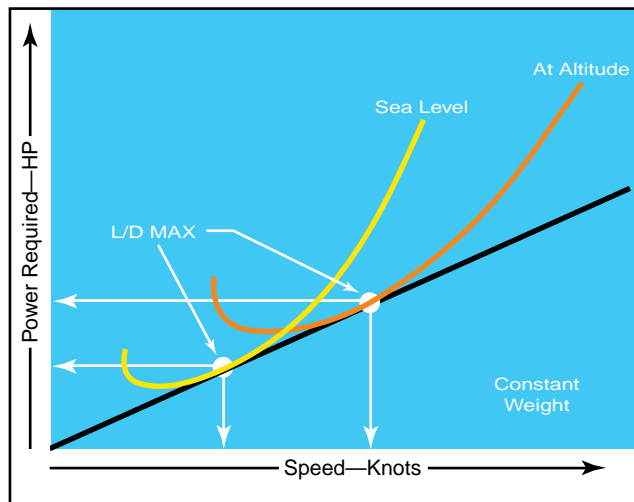

Figure 9-13. Effect of altitude on range.

The effect of altitude on specific range also can be appreciated from the previous relationships. If a change in altitude causes identical changes in speed and power required, the proportion of speed to power required would be unchanged. The fact implies that the specific range of the propeller-driven airplane would be unaffected by altitude. Actually, this is true to the extent that specific fuel consumption and propeller efficiency are the principal factors that could cause a variation of specific range with altitude. If compressibility effects are negligible, any variation of specific range with altitude is strictly a function of engine/propeller performance.

The airplane equipped with the reciprocating engine will experience very little, if any, variation of specific range up to its absolute altitude. There is negligible variation of **brake specific fuel consumption** for values of **brake horsepower** below the maximum cruise power rating of the engine that is the lean range of engine operation. Thus, an increase in altitude will produce a decrease in specific range only when the increased power requirement exceeds the maximum cruise power rating of the engine. One advantage of supercharging is that the cruise power may be maintained at high altitude, and the airplane may achieve the range at high altitude with the corresponding increase in true airspeed. The principal differences in

the high altitude cruise and low altitude cruise are the true airspeeds and climb fuel requirements.

## GROUND EFFECT

**Ground effect** is due to the interference of the surface with the flow pattern about the airplane in flight. Ground effect can be detected and measured up to an altitude equal to one wing span above the surface. However, ground effect is most significant when the airplane (especially the low-wing airplane) is maintaining a constant attitude at low airspeed and low altitude (for example, during landing flare before touchdown, and during takeoff when the airplane lifts off and accelerates to climb speed).

When the wing is under the influence of ground effect, there is a reduction in upwash, downwash, and tip vortices. As a result of the reduced tip vortices, induced drag is reduced. When the wing is at a height equal to one-fourth the span, the reduction in induced drag is about 25 percent, and when the wing is at a height equal to one-tenth the span, the reduction in induced drag is about 50 percent. At high speeds where parasite drag predominates, induced drag is a small part of the total drag. Consequently, the effects of ground effect are of greater concern during takeoff and landing. [Figure 9-14]

Assuming that the airplane descends into ground effect maintaining a constant angle of attack and a constant airspeed, the following effects will take place:

Because of the reduction in drag, a smaller wing angle of attack will be required to produce the same lift coefficient or, if a constant wing angle of attack is maintained, the wing will experience an increase in lift coefficient.

As a result of the reduction in drag, the thrust required at low speeds will be reduced.

The reduction in downwash at the horizontal tail will reduce the effectiveness of the elevator. It may cause a pitch-down tendency, thus requiring greater up elevator to trim the airplane.

In the majority of cases, ground effect will cause an increase in pressure at the static source and produce a lower indication of airspeed and altitude.

During the landing flare when the airplane is brought into ground effect at a constant angle of attack, the airplane will experience an increase in lift coefficient.

**Brake Specific Fuel Consumption**—The number of pounds of fuel burned per hour to produce one horsepower in a reciprocating engine.

**Brake Horsepower**—The power delivered at the propeller shaft (main drive or main output) of an aircraft engine.

**Ground Effect**—A condition due to the interference of the surface with the airflow around the wing and which can be detected up to an altitude of one wing span above the surface.

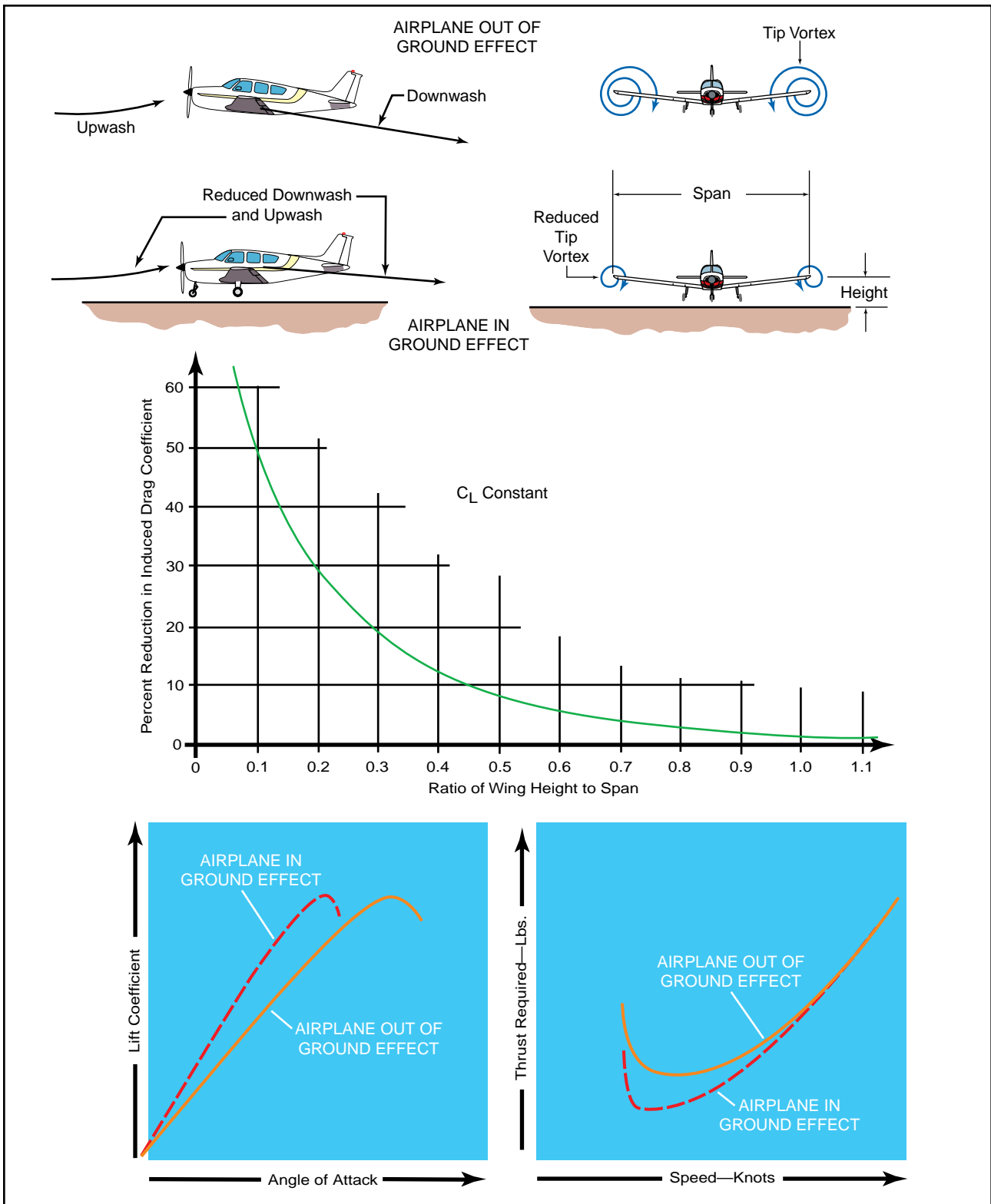

Figure 9-14. Ground effect.

Thus, a “floating” sensation may be experienced. Because of the reduced drag in ground effect, any excess speed at the point of landing flare may result in a considerable “float” distance. If a power approach is being made, the power setting should be reduced as the airplane descends into ground effect to avoid overshooting the desired touchdown point.

During takeoff, the airplane leaving ground effect encounters the reverse of entering ground effect. For example, an airplane leaving ground effect will:

require an increase in angle of attack to maintain the same lift coefficient,

experience an increase in induced drag and thrust required,

experience a pitch-up tendency requiring less elevator travel to trim the airplane because of the increase in downwash at the horizontal tail, and

usually experience a reduction in static source pressure and an increase in indicated airspeed.

Due to the reduced drag in ground effect, the airplane may seem able to take off below the recommended airspeed. However, as the airplane rises out of ground effect with an insufficient airspeed, initial climb performance may prove to be marginal because of the increased drag. Under extreme conditions such as high-density altitude, high temperature, and maximum gross weight, the airplane may be able to become airborne at an insufficient airspeed, but unable to fly out of ground effect. Consequently, the airplane may not be able to clear an obstruction, or may settle back on the runway. Under marginal conditions, it is important the airplane takes off at the recommended speed that will provide adequate initial climb performance. If the runway is long enough, or no obstacles exist, ground effect can be used to an advantage by using the reduced drag to improve initial acceleration. Ground effect is important to normal flight operations in the performance of soft and rough field takeoffs and landings. The procedure for takeoff from these surfaces is to transfer as much weight as possible to the wings during the ground run, and to lift off with the aid of ground effect before true flying speed is attained. It is then necessary to reduce the angle of attack gradually until normal airspeed is attained before attempting to climb away from the ground effect.

### REGION OF REVERSED COMMAND

The aerodynamic properties of the airplane generally determine the power requirements at various conditions of flight, while the powerplant capabilities generally determine the power available at various conditions of flight. When the airplane is in steady, level flight, the condition of equilibrium must prevail. An unaccelerated condition of flight is achieved when lift equals weight, and the powerplant is set for a thrust equal to the airplane drag. The power required to achieve equilibrium in constant-altitude flight at various airspeeds is depicted on a power required curve. The power required curve illustrates the fact that at low airspeeds near the stall or minimum controllable airspeed, the power setting required for steady, level flight is quite high.

Flight in the region of normal command means that while holding a constant altitude, a higher airspeed requires a higher power setting and a lower airspeed requires a lower power setting. The majority of all air-

plane flying (climb, cruise, and maneuvers) is conducted in the region of normal command.

Flight in the **region of reversed command** means that a higher airspeed requires a lower power setting and a lower airspeed requires a higher power setting to hold altitude. It does not imply that a decrease in power will produce lower airspeed. The region of reversed command is encountered in the low speed phases of flight. Flight speeds below the speed for maximum endurance (lowest point on the power curve) require higher power settings with a decrease in airspeed. Since the need to increase the required power setting with decreased speed is contrary to the normal command of flight, the regime of flight speeds between the speed for minimum required power setting and the stall speed (or minimum control speed) is termed the region of reversed command. In the region of reversed command, a decrease in airspeed must be accompanied by an increased power setting in order to maintain steady flight.

Figure 9-15 shows the “maximum power available” as a curved line. Lower power settings, such as cruise power, would also appear in a similar curve. The lowest point on the power required curve represents the speed at which the lowest brake horsepower will sustain level flight. This is termed the best endurance airspeed.

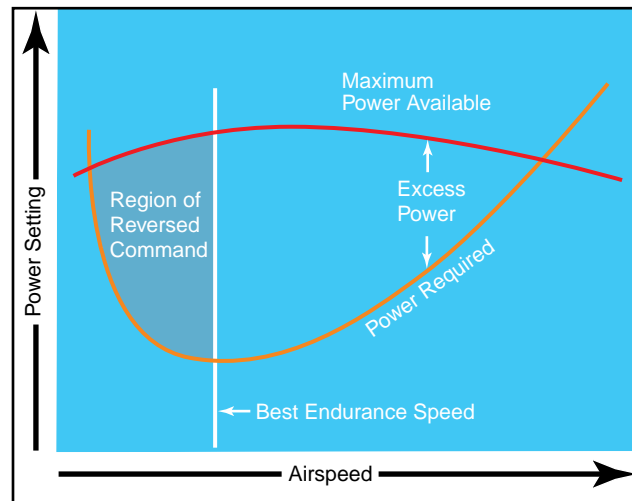

Figure 9-15. Power required curve.

An airplane performing a low airspeed, high pitch attitude power approach for a short-field landing is an example of operating in the region of reversed command. If an unacceptably high sink rate should develop, it may be possible for the pilot to reduce or stop the descent by applying power. But without further use of power, the airplane would probably stall or be incapable of flaring for the landing. Merely

**Region of Reversed Command**—Means in flight a higher airspeed requires a lower power setting and a lower airspeed requires a higher power setting to maintain altitude.

lowering the nose of the airplane to regain flying speed in this situation, without the use of power, would result in a rapid sink rate and corresponding loss of altitude.

If during a soft-field takeoff and climb, for example, the pilot attempts to climb out of ground effect without first attaining normal climb pitch attitude and airspeed, the airplane may inadvertently enter the region of reversed command at a dangerously low altitude. Even with full power, the airplane may be incapable of climbing or even maintaining altitude. The pilot's only recourse in this situation is to lower the pitch attitude in order to increase airspeed, which will inevitably result in a loss of altitude.

Airplane pilots must give particular attention to precise control of airspeed when operating in the low flight speeds of the region of reversed command.

### RUNWAY SURFACE AND GRADIENT

Runway conditions affect takeoff and landing performance. Typically, performance chart information assumes paved, level, smooth, and dry runway surfaces. Since no two runways are alike, the runway surface differs from one runway to another, as does the runway gradient or slope. [Figure 9-16]

Runway surfaces vary widely from one airport to another. The runway surface encountered may be concrete, asphalt, gravel, dirt, or grass. The runway surface for a specific airport is noted in the *Airport/Facility Directory*. Any surface that is not hard and smooth will increase the ground roll during takeoff. This is due to the inability of the tires to smoothly roll along the runway. Tires can sink into soft, grassy, or muddy runways. Potholes or other ruts in the pavement can be the cause of poor tire movement along the runway.

Obstructions such as mud, snow, or standing water reduce the airplane's acceleration down the runway. Although muddy and wet surface conditions can reduce friction between the runway and the tires, they can also act as obstructions and reduce the landing distance. [Figure 9-17]



Figure 9-17. Airplane performance depends greatly on the runway surface.

Braking effectiveness is another consideration when dealing with various runway types. The condition of the surface affects the braking ability of the airplane.

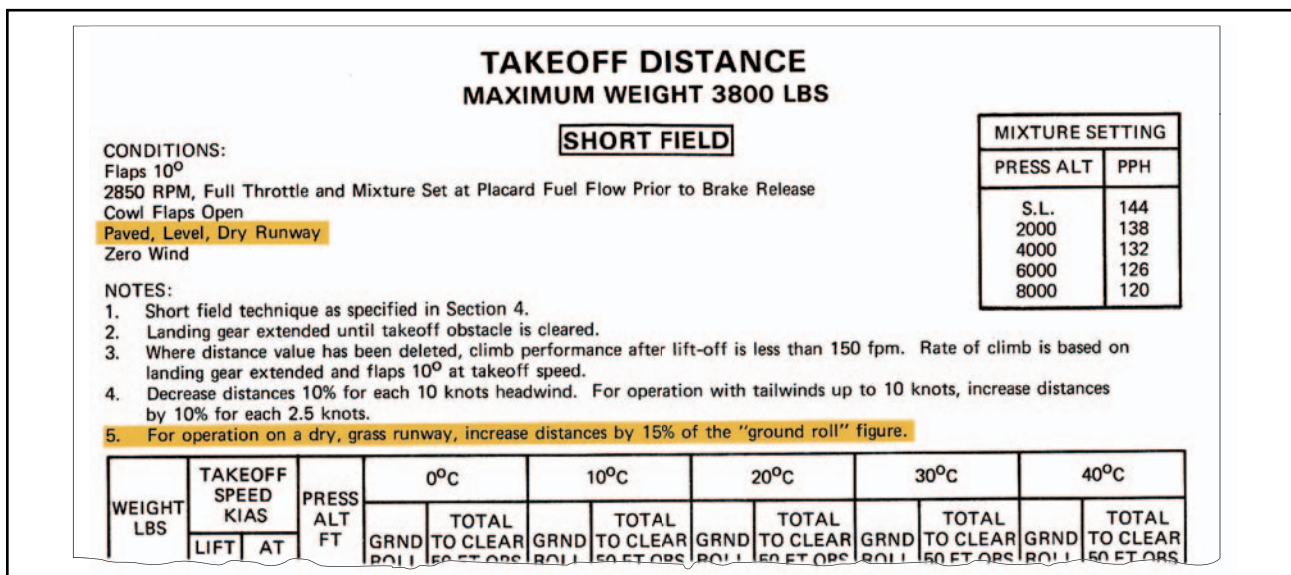

Figure 9-16. Charts assume paved, level, dry runway conditions.

The amount of power that is applied to the brakes without skidding the tires is referred to as braking effectiveness. Ensure that runways are adequate in length for takeoff acceleration and landing deceleration when less than ideal surface conditions are being reported.

The gradient or slope of the runway is the amount of change in runway height over the length of the runway. The gradient is expressed as a percentage such as a 3 percent gradient. This means that for every 100 feet of runway length, the runway height changes by 3 feet. A positive gradient indicates that the runway height increases, and a negative gradient indicates that the runway decreases in height. An upsloping runway impedes acceleration and results in a longer ground run during takeoff. However, landing on an upsloping runway typically reduces the landing roll. A downsloping runway aids in acceleration on takeoff resulting in shorter takeoff distances. The opposite is true when landing, as landing on a downsloping runway increases landing distances. Runway slope information is contained in the *Airport/Facility Directory*. [Figure 9-18]

### WATER ON THE RUNWAY AND DYNAMIC HYDROPLANING

Water on the runways reduces the friction between the tires and the ground, and can reduce braking effectiveness. The ability to brake can be completely lost when the tires are hydroplaning because a layer of water separates the tires from the runway surface. This is also true of braking effectiveness when runways are covered in ice.

When the runway is wet, the pilot may be confronted with dynamic hydroplaning. **Dynamic hydroplaning** is a condition in which the airplane tires ride on a thin

sheet of water rather than on the runway's surface. Because hydroplaning wheels are not touching the runway, braking and directional control are almost nil.

To help minimize dynamic hydroplaning, some runways are grooved to help drain off water; but most runways are not.

Tire pressure is a factor in dynamic hydroplaning. By the simple formula in figure 9-19, the pilot can calculate the minimum speed, in knots, at which hydroplaning will begin. In plain language, the minimum hydroplaning speed is determined by multiplying the square root of the main gear tire pressure in pounds per square inch (p.s.i.), by nine. For example, if the main gear tire pressure is at 36 pounds per square inch, the airplane would begin hydroplaning at 54 knots.



Figure 9-19. Dynamic hydroplane formula and example for a tire pressure of 36 pounds.

**Dynamic Hydroplaning**—A condition in which the airplane tires ride on a thin sheet of water rather than the runway surface.

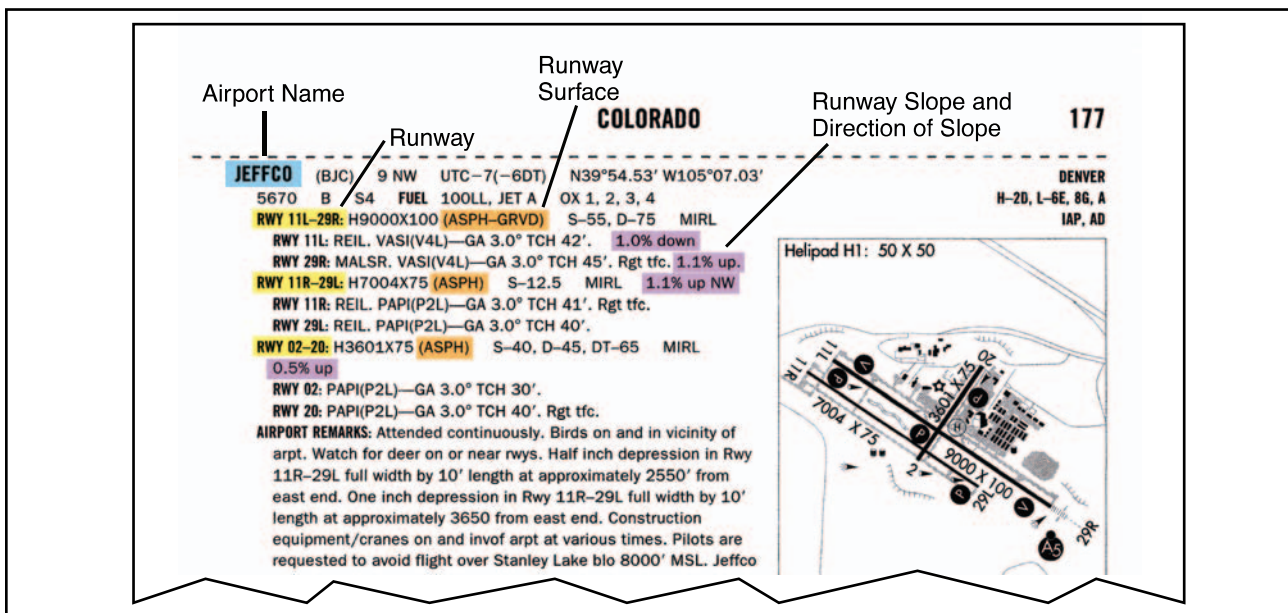

Figure 9-18. A/FDs provide information regarding runway slope.

Landing at higher than recommended touchdown speeds will expose the airplane to a greater potential for hydroplaning. And once hydroplaning starts, it can continue well below the minimum, initial hydroplaning speed.

On wet runways, directional control can be maximized by landing into the wind. Abrupt control inputs should be avoided. When the runway is wet, anticipate braking problems well before landing and be prepared for hydroplaning. Opt for a suitable runway most aligned with the wind. Mechanical braking may be ineffective, so aerodynamic braking should be used to its fullest advantage.

## **TAKEOFF AND LANDING PERFORMANCE**

The majority of pilot-caused airplane accidents occur during the takeoff and landing phase of flight. Because of this fact, the pilot must be familiar with all the variables that influence the takeoff and landing performance of an airplane and must strive for exacting, professional procedures of operation during these phases of flight.

Takeoff and landing performance is a condition of accelerated and decelerated motion. For instance, during takeoff, the airplane starts at zero speed and accelerates to the takeoff speed to become airborne. During landing, the airplane touches down at the landing speed and decelerates to zero speed.

The important factors of takeoff or landing performance are as follows:

- The takeoff or landing speed which will generally be a function of the stall speed or minimum flying speed.
- The rate of acceleration and deceleration during the takeoff or landing roll. The acceleration and deceleration experienced by any object varies directly with the imbalance of force and inversely with the mass of the object.
- The takeoff or landing roll distance is a function of both acceleration/deceleration and speed.

### **TAKEOFF PERFORMANCE**

The minimum takeoff distance is of primary interest in the operation of any airplane because it defines the runway requirements. The minimum takeoff distance is obtained by taking off at some minimum safe speed that allows sufficient margin above stall and provides satisfactory control and initial rate of climb. Generally, the lift-off speed is some fixed percentage of the stall speed or minimum control speed for the airplane in the takeoff configuration. As such, the lift-off will be accomplished at some particular value of lift coeffi-

cient and angle of attack. Depending on the airplane characteristics, the lift-off speed will be anywhere from 1.05 to 1.25 times the stall speed or minimum control speed.

To obtain minimum takeoff distance at the specific lift-off speed, the forces that act on the airplane must provide the maximum acceleration during the takeoff roll. The various forces acting on the airplane may or may not be under the control of the pilot, and various procedures may be necessary in certain airplanes to maintain takeoff acceleration at the highest value.

The powerplant thrust is the principal force to provide the acceleration and, for minimum takeoff distance, the output thrust should be at a maximum. Lift and drag are produced as soon as the airplane has speed, and the values of lift and drag depend on the angle of attack and dynamic pressure.

In addition to the important factors of proper procedures, many other variables affect the takeoff performance of an airplane. Any item that alters the takeoff speed or acceleration rate during the takeoff roll will affect the takeoff distance.

For example, the effect of gross weight on takeoff distance is significant and proper consideration of this item must be made in predicting the airplane's takeoff distance. Increased gross weight can be considered to produce a threefold effect on takeoff performance:

1. higher lift-off speed,
2. greater mass to accelerate, and
3. increased retarding force (drag and ground friction).  
If the gross weight increases, a greater speed is necessary to produce the greater lift necessary to get the airplane airborne at the takeoff lift coefficient. As an example of the effect of a change in gross weight, a 21 percent increase in takeoff weight will require a 10 percent increase in lift-off speed to support the greater weight.

A change in gross weight will change the net accelerating force and change the mass that is being accelerated. If the airplane has a relatively high thrust-to-weight ratio, the change in the net accelerating force is slight and the principal effect on acceleration is due to the change in mass.

The takeoff distance will vary at least as the square of the gross weight. For example, a 10 percent increase in takeoff gross weight would cause:

- a 5 percent increase in takeoff velocity,
- at least a 9 percent decrease in rate of acceleration, and
- at least a 21 percent increase in takeoff distance.

For the airplane with a high thrust-to-weight ratio, the increase in takeoff distance might be approximately 21 to 22 percent, but for the airplane with a relatively low thrust-to-weight ratio, the increase in takeoff distance would be approximately 25 to 30 percent. Such a powerful effect requires proper consideration of gross weight in predicting takeoff distance.

The effect of wind on takeoff distance is large, and proper consideration also must be provided when predicting takeoff distance. The effect of a headwind is to allow the airplane to reach the lift-off speed at a lower groundspeed while the effect of a tailwind is to require the airplane to achieve a greater groundspeed to attain the lift-off speed.

A headwind that is 10 percent of the takeoff airspeed will reduce the takeoff distance approximately 19 percent. However, a tailwind that is 10 percent of the takeoff airspeed will increase the takeoff distance approximately 21 percent. In the case where the headwind speed is 50 percent of the takeoff speed, the takeoff distance would be approximately 25 percent of the zero wind takeoff distance (75 percent reduction).

The effect of wind on landing distance is identical to the effect on takeoff distance. Figure 9-20 illustrates the general effect of wind by the percent change in takeoff or landing distance as a function of the ratio of wind velocity to takeoff or landing speed.

The effect of proper takeoff speed is especially important when runway lengths and takeoff distances are critical. The takeoff speeds specified in the AFM/POH are generally the minimum

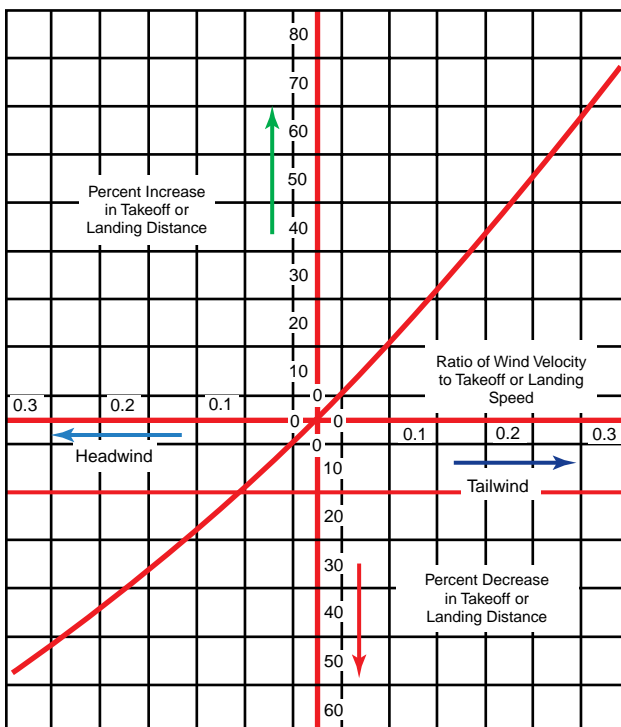

Figure 9-20. Effect of wind on takeoff and landing.

safe speeds at which the airplane can become airborne. Any attempt to take off below the recommended speed could mean that the airplane may stall, be difficult to control, or have a very low initial rate of climb. In some cases, an excessive angle of attack may not allow the airplane to climb out of ground effect. On the other hand, an excessive airspeed at takeoff may improve the initial rate of climb and “feel” of the airplane, but will produce an undesirable increase in takeoff distance. Assuming that the acceleration is essentially unaffected, the takeoff distance varies as the square of the takeoff velocity.

Thus, 10 percent excess airspeed would increase the takeoff distance 21 percent. In most critical takeoff conditions, such an increase in takeoff distance would be prohibitive, and the pilot must adhere to the recommended takeoff speeds.

The effect of pressure altitude and ambient temperature is to define primarily the density altitude and its effect on takeoff performance. While subsequent corrections are appropriate for the effect of temperature on certain items of powerplant performance, density altitude defines specific effects on takeoff performance. An increase in density altitude can produce a twofold effect on takeoff performance:

1. greater takeoff speed and
2. decreased thrust and reduced net accelerating force.

If an airplane of given weight and configuration is operated at greater heights above standard sea level, the airplane will still require the same dynamic pressure to become airborne at the takeoff lift coefficient. Thus, the airplane at altitude will take off at the same indicated airspeed as at sea level, but because of the reduced air density, the true airspeed will be greater.

The effect of density altitude on powerplant thrust depends much on the type of powerplant. An increase in altitude above standard sea level will bring an immediate decrease in power output for the unsupercharged reciprocating engine. However, an increase in altitude above standard sea level will not cause a decrease in power output for the supercharged reciprocating engine until the altitude exceeds the critical operating altitude. For those powerplants that experience a decay in thrust with an increase in altitude, the effect on the net accelerating force and acceleration rate can be approximated by assuming a direct variation with density. Actually, this assumed variation would closely approximate the effect on airplanes with high thrust-to-weight ratios.

Proper accounting of pressure altitude (field elevation is a poor substitute) and temperature is mandatory for accurate prediction of takeoff roll distance.

The most critical conditions of takeoff performance are the result of some combination of high gross weight, altitude, temperature, and unfavorable wind. In all cases, the pilot must make an accurate prediction of takeoff distance from the performance data of the AFM/POH, regardless of the runway available, and strive for a polished, professional takeoff procedure.

In the prediction of takeoff distance from the AFM/POH data, the following primary considerations must be given:

- Pressure altitude and temperature—to define the effect of density altitude on distance.
- Gross weight—a large effect on distance.
- Wind—a large effect due to the wind or wind component along the runway.
- Runway slope and condition—the effect of an incline and the retarding effect of factors such as snow or ice.

## LANDING PERFORMANCE

In many cases, the landing distance of an airplane will define the runway requirements for flying operations. The minimum landing distance is obtained by landing at some minimum safe speed, which allows sufficient margin above stall and provides satisfactory control and capability for a go-around. Generally, the landing speed is some fixed percentage of the stall speed or minimum control speed for the airplane in the landing configuration. As such, the landing will be accomplished at some particular value of lift coefficient and angle of attack. The exact values will depend on the airplane characteristics but, once defined, the values are independent of weight, altitude, and wind.

To obtain minimum landing distance at the specified landing speed, the forces that act on the airplane must provide maximum deceleration during the landing roll. The forces acting on the airplane during the landing roll may require various procedures to maintain landing deceleration at the peak value.

A distinction should be made between the procedures for minimum landing distance and an ordinary landing roll with considerable excess runway available. Minimum landing distance will be obtained by creating a continuous peak deceleration of the airplane; that is, extensive use of the brakes for maximum deceleration. On the other hand, an ordinary landing roll with considerable excess runway may allow extensive use of aerodynamic drag to minimize wear and tear on the tires and brakes. If aerodynamic drag is sufficient to cause deceleration of the airplane, it can be used in deference to the brakes in the early stages of the landing

roll; i.e., brakes and tires suffer from continuous hard use, but airplane aerodynamic drag is free and does not wear out with use. The use of aerodynamic drag is applicable only for deceleration to 60 or 70 percent of the touchdown speed. At speeds less than 60 to 70 percent of the touchdown speed, aerodynamic drag is so slight as to be of little use, and braking must be utilized to produce continued deceleration of the airplane. Since the objective during the landing roll is to decelerate, the powerplant thrust should be the smallest possible positive value (or largest possible negative value in the case of thrust reversers).

In addition to the important factors of proper procedures, many other variables affect the landing performance. Any item that alters the landing speed or deceleration rate during the landing roll will affect the landing distance.

The effect of gross weight on landing distance is one of the principal items determining the landing distance. One effect of an increased gross weight is that a greater speed will be required to support the airplane at the landing angle of attack and lift coefficient.

For an example of the effect of a change in gross weight, a 21 percent increase in landing weight will require a 10 percent increase in landing speed to support the greater weight.

When minimum landing distances are considered, braking friction forces predominate during the landing roll and, for the majority of airplane configurations, braking friction is the main source of deceleration.

The minimum landing distance will vary in direct proportion to the gross weight. For example, a 10 percent increase in gross weight at landing would cause a:

- 5 percent increase in landing velocity and
- 10 percent increase in landing distance.

A contingency of this is the relationship between weight and braking friction force.

The effect of wind on landing distance is large and deserves proper consideration when predicting landing distance. Since the airplane will land at a particular airspeed independent of the wind, the principal effect of wind on landing distance is due to the change in the groundspeed at which the airplane touches down. The effect of wind on deceleration during the landing is identical to the effect on acceleration during the take-off.

A headwind that is 10 percent of the landing airspeed will reduce the landing distance approximately 19 percent, but



a tailwind that is 10 percent of the landing speed will increase the landing distance approximately 21 percent. Figure 9-20 illustrates this general effect.

The effect of pressure altitude and ambient temperature is to define density altitude and its effect on landing performance. An increase in density altitude will increase the landing speed but will not alter the net retarding force. Thus, the airplane at altitude will land at the same indicated airspeed as at sea level but, because of the reduced density, the true airspeed (TAS) will be greater. Since the airplane lands at altitude with the same weight and dynamic pressure, the drag and braking friction throughout the landing roll have the same values as at sea level. As long as the condition is within the capability of the brakes, the net retarding force is unchanged, and the deceleration is the same as with the landing at sea level. Since an increase in altitude does not alter deceleration, the effect of density altitude on landing distance would actually be due to the greater TAS.

The minimum landing distance at 5,000 feet would be 16 percent greater than the minimum landing distance at sea level. The approximate increase in landing distance with altitude is approximately 3 1/2 percent for each 1,000 feet of altitude. Proper accounting of density altitude is necessary to accurately predict landing distance.

The effect of proper landing speed is important when runway lengths and landing distances are critical. The landing speeds specified in the AFM/POH are generally the minimum safe speeds at which the airplane can be landed. Any attempt to land at below the specified speed may mean that the airplane may stall, be difficult to control, or develop high rates of descent. On the other hand, an excessive speed at landing may improve the controllability slightly (especially in crosswinds), but will cause an undesirable increase in landing distance.

A 10 percent excess landing speed would cause at least a 21 percent increase in landing distance. The excess speed places a greater working load on the brakes because of the additional kinetic energy to be dissipated. Also, the additional speed causes increased drag and lift in the normal ground attitude, and the increased lift will reduce the normal force on the braking surfaces. The deceleration during this range of speed immediately after touchdown may suffer, and it will be more likely that a tire can be blown out from braking at this point.

The most critical conditions of landing performance are the result of some combination of high gross weight, high density altitude, and unfavorable wind. These conditions produce the greatest landing distance

and provide critical levels of energy dissipation required of the brakes. In all cases, it is necessary to make an accurate prediction of minimum landing distance to compare with the available runway. A polished, professional landing procedure is necessary because the landing phase of flight accounts for more pilot-caused airplane accidents than any other single phase of flight.

In the prediction of minimum landing distance from the AFM/POH data, the following considerations must be given:

- Pressure altitude and temperature—to define the effect of density altitude.
- Gross weight—which defines the CAS for landing.
- Wind—a large effect due to wind or wind component along the runway.
- Runway slope and condition—relatively small correction for ordinary values of runway slope, but a significant effect of snow, ice, or soft ground.

## PERFORMANCE SPEEDS

True Airspeed (TAS) – the speed of the airplane in relation to the air mass in which it is flying.

Indicated Airspeed (IAS) – the speed of the airplane as observed on the airspeed indicator. It is the airspeed without correction for indicator, position (or installation), or compressibility errors.

Calibrated Airspeed (CAS) – the airspeed indicator reading corrected for position (or installation), and instrument errors. (CAS is equal to TAS at sea level in standard atmosphere.) The color-coding for various design speeds marked on airspeed indicators may be IAS or CAS.

Equivalent Airspeed (EAS) – the airspeed indicator reading corrected for position (or installation), or instrument error, and for adiabatic compressible flow for the particular altitude. (EAS is equal to CAS at sea level in standard atmosphere.)

$V_{S0}$  – the calibrated power-off stalling speed or the minimum steady flight speed at which the airplane is controllable in the landing configuration.

$V_{S1}$  – the calibrated power-off stalling speed or the minimum steady flight speed at which the airplane is controllable in a specified configuration.

$V_Y$  – the calibrated airspeed at which the airplane will obtain the maximum increase in altitude per unit of

time. This best rate-of-climb speed normally decreases slightly with altitude.

$V_X$  – the calibrated airspeed at which the airplane will obtain the highest altitude in a given horizontal distance. This best angle-of-climb speed normally increases slightly with altitude.

$V_{LE}$  – the maximum calibrated airspeed at which the airplane can be safely flown with the landing gear extended. This is a problem involving stability and controllability.

$V_{LO}$  – the maximum calibrated airspeed at which the landing gear can be safely extended or retracted. This is a problem involving the air loads imposed on the operating mechanism during extension or retraction of the gear.

$V_{FE}$  – the highest calibrated airspeed permissible with the wing flaps in a prescribed extended position. This is because of the air loads imposed on the structure of the flaps.

$V_A$  – the calibrated design maneuvering airspeed. This is the maximum speed at which the limit load can be imposed (either by gusts or full deflection of the control surfaces) without causing structural damage.

$V_{NO}$  – the maximum calibrated airspeed for normal operation or the maximum structural cruising speed. This is the speed at which exceeding the limit load factor may cause permanent deformation of the airplane structure.

$V_{NE}$  – the calibrated airspeed which should NEVER be exceeded. If flight is attempted above this speed, structural damage or structural failure may result.

## PERFORMANCE CHARTS

Performance charts allow a pilot to predict the takeoff, climb, cruise, and landing performance of the airplane. These charts, provided by the manufacturer, are included in the AFM/POH. The information the manufacturer provides on these charts has been gathered from test flights conducted in a new airplane, under normal operating conditions while using average piloting skills, and with the airplane and engine in good working order. Engineers record the flight data and create performance charts based on the behavior of the airplane during the test flights. By using these performance charts, a pilot can determine the runway length needed to take off and land, the amount of fuel that will be used during flight, and the length of time it will take to arrive at the destination. It is important to remember that the data from the charts will not be accurate if the airplane is not in good working order or when operating under adverse conditions. So take into consideration that it is necessary to compensate the performance numbers if the airplane is not in good working order or piloting skills are below average. Each airplane performs differently and therefore, has different performance numbers. Compute the performance of the airplane prior to every flight, as every flight is different.

Every chart is based on certain conditions and contains notes on how to adapt the information for flight conditions. It is important to read every chart and understand how to use it. Read the accompanying instructions provided by the manufacturer. For an explanation on how to use the charts, refer to the example provided by the manufacturer for that specific chart. [Figure 9-21]

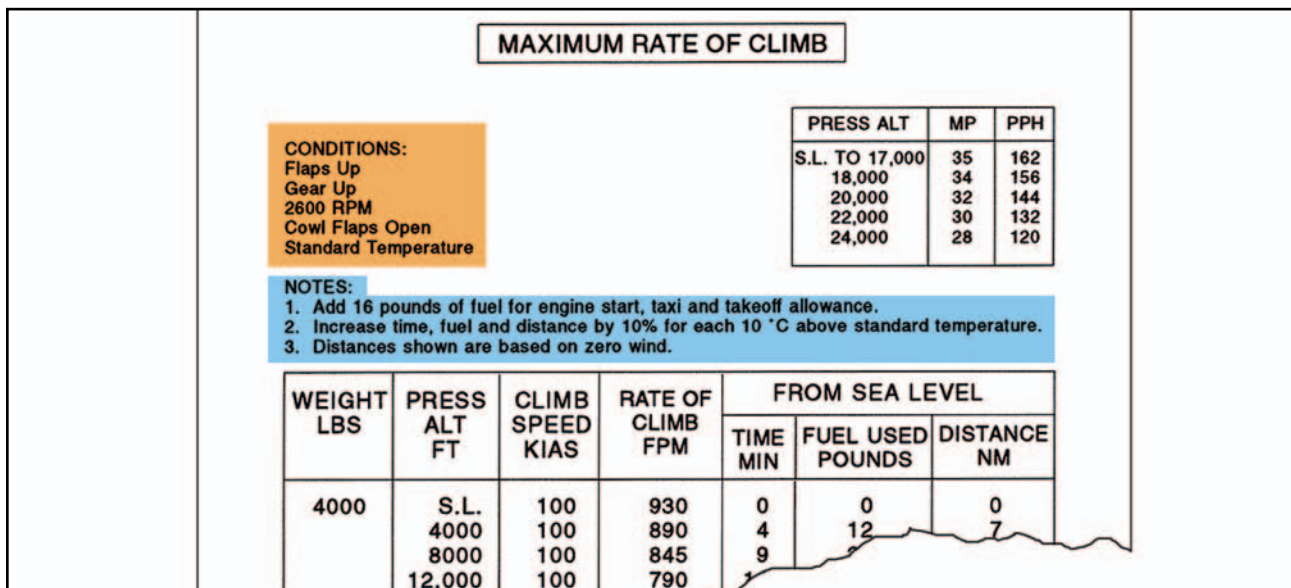

Figure 9-21. Carefully read all conditions and notes for every chart.

The information manufacturers furnish is not standardized. Information may be contained in a table format, and other information may be contained in a graph format. Sometimes combined graphs incorporate two or more graphs into one chart to compensate for multiple conditions of flight. Combined graphs allow the pilot to predict airplane performance for variations in density altitude, weight, and winds all on one chart. Because of the vast amount of information that can be extracted from this type of chart, it is important to be very accurate in reading the chart. A small error in the beginning can lead to a large error at the end.

The remainder of this section covers performance information for airplanes in general and discusses what information the charts contain and how to extract information from the charts by direct reading and interpolation methods. Every chart contains a wealth of information that should be used when flight planning. Examples of the table, graph, and combined graph formats for all aspects of flight will be discussed.

### INTERPOLATION

Not all of the information on the charts is easily extracted. Some charts require interpolation to find the information for specific flight conditions. Interpolating information means that by taking the known information, a pilot can compute intermediate information. However, pilots sometimes round off values from charts to a more conservative figure.

Using values that reflect slightly more adverse conditions provides a reasonable estimate of performance information and gives a slight margin of safety. The following illustration is an example of interpolating information from a takeoff distance chart. [Figure 9-22]

### DENSITY ALTITUDE CHARTS

Use a density altitude chart to figure the density altitude at the departing airport. Using figure 9-23, determine the density altitude based on the given information.

#### Sample Problem 1

Airport Elevation.....5,883 feet  
 OAT.....70°F  
 Altimeter.....30.10 in. Hg

First, compute the pressure altitude conversion. Find 30.10 under the altimeter heading. Read across to the second column. It reads “-165.” Therefore, it is necessary to subtract 165 from the airport elevation giving a pressure altitude of 5,718 feet. Next, locate the outside air temperature on the scale along the bottom of the graph. From 70°, draw a line up to the 5,718 feet pressure altitude line, which is about two-thirds of the way up between the 5,000 and 6,000-foot lines. Draw a line straight across to the far left side of the graph and read the approximate density altitude. The approximate density altitude in thousands of feet is 7,700 feet.

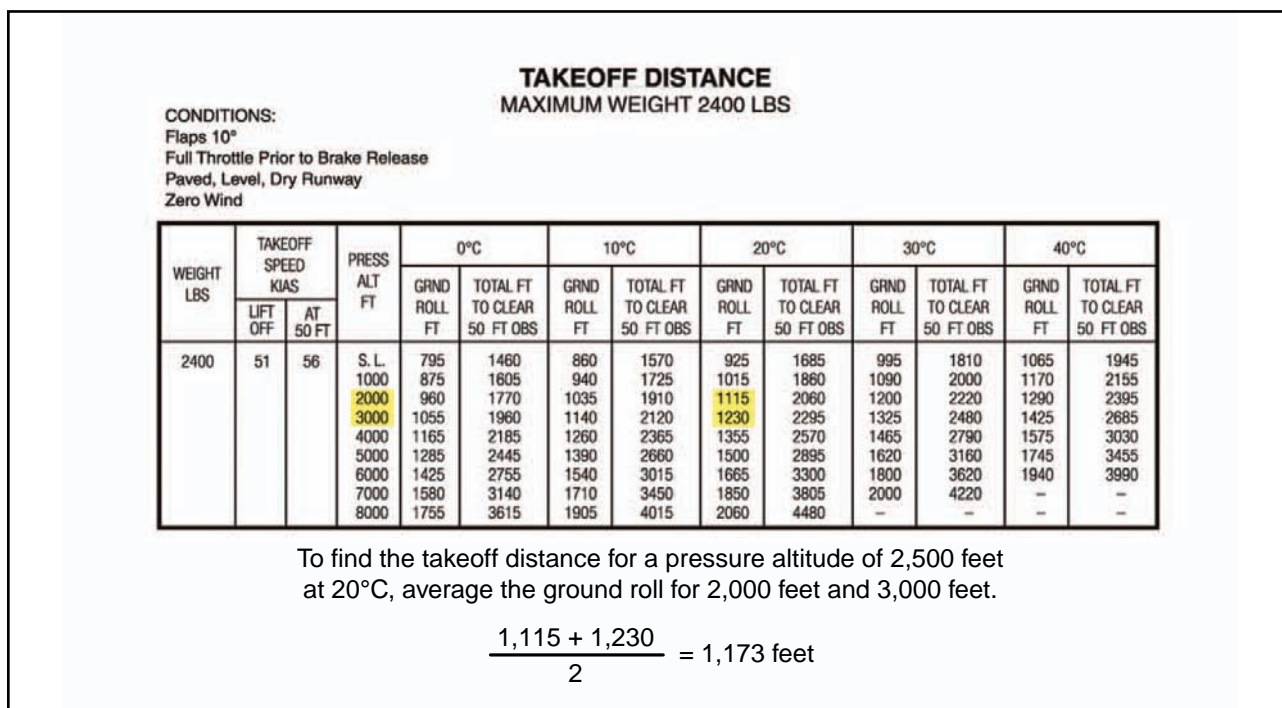
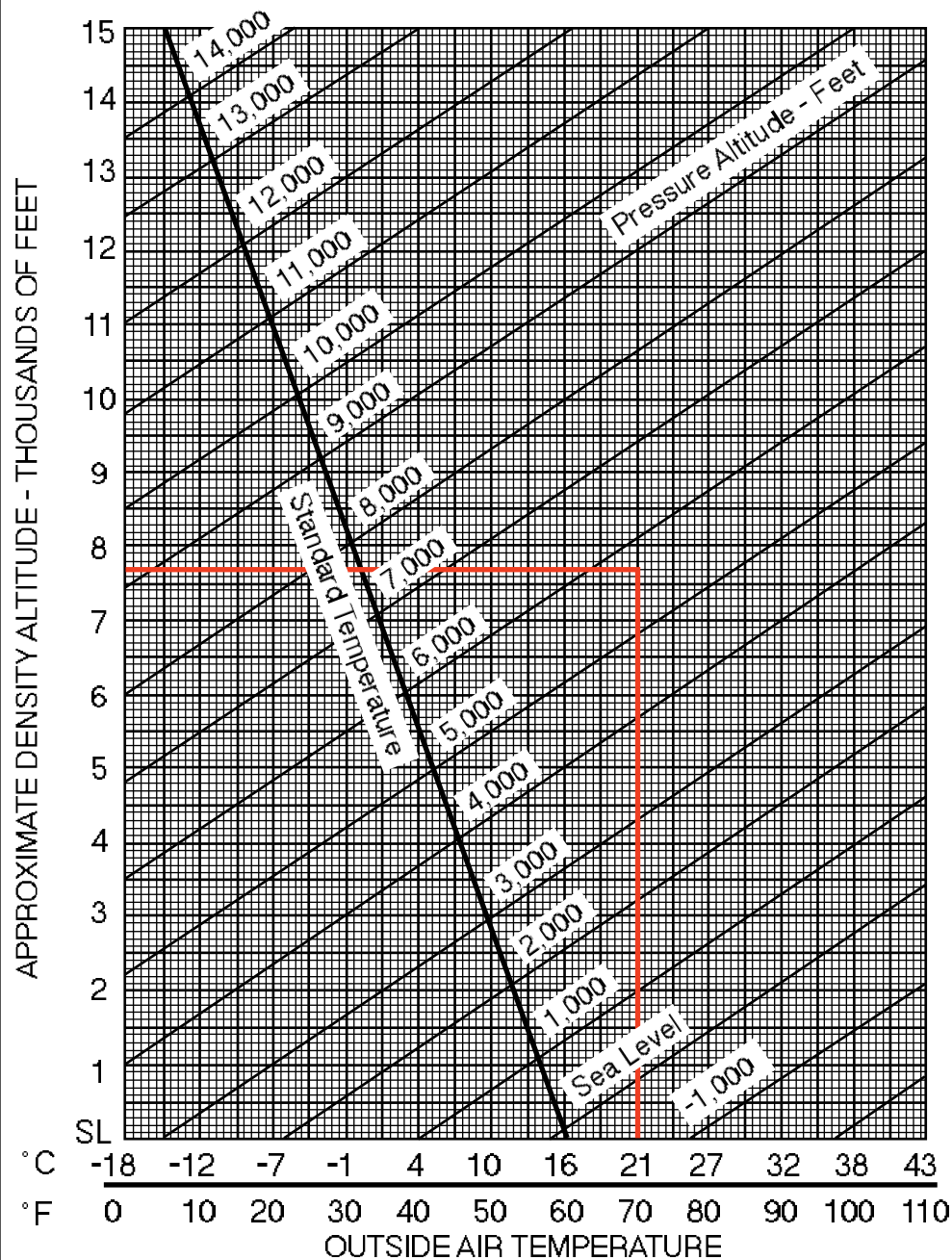

Figure 9-22. Interpolating charts.

# DENSITY ALTITUDE CHART



Altimeter Setting (" Hg)	Pressure Altitude Conversion Factor
28.0	1,824
28.1	1,727
28.2	1,630
28.3	1,533
28.4	1,436
28.5	1,340
28.6	1,244
28.7	1,148
28.8	1,053
28.9	957
29.0	863
29.1	768
29.2	673
29.3	579
29.4	485
29.5	392
29.6	298
29.7	205
29.8	112
29.9	20
29.92	0
30.0	-73
30.1	-165
30.2	-257
30.3	-348
30.4	-440
30.5	-531
30.6	-622
30.7	-712
30.8	-803
30.9	-893
31.0	-983

Figure 9-23. Density altitude chart.

## TAKEOFF CHARTS

Takeoff charts are typically provided in several forms. They allow a pilot to compute the takeoff distance of the airplane with no flaps or with a specific flap configuration. A pilot can also compute distances for a no flap takeoff over a 50-foot obstacle scenario as well as with flaps over a 50-foot obstacle. The takeoff distance chart provides for various airplane weights, altitudes, temperatures, winds, and obstacle heights.

### Sample Problem 2

Pressure Altitude.....2,000 feet  
 OAT.....22°C  
 Takeoff Weight.....2,600 pounds  
 Headwind.....6 knots  
 Obstacle Height.....50-foot obstacle

Refer to figure 9-24. This chart is an example of a combined takeoff distance graph. It takes into consideration pressure altitude, temperature, weight, wind, and obstacles all on one chart. First, find the correct temperature on the bottom left-hand side of the graph. Follow the line from 22°C straight up until it intersects the 2,000-foot altitude line. From that point, draw a line straight across to the first dark reference line. Continue to draw the line from the reference point in a diagonal direction following the surrounding lines until it intersects the corresponding weight line. From the intersection of

2,600 pounds, draw a line straight across until it reaches the second reference line. Once again, follow the lines in a diagonal manner until it reaches the 6-knot headwind mark. Follow straight across to the third reference line and from here, draw a line in two directions. First, draw a line straight across to figure the ground roll distance. Next, follow the diagonal lines again until it reaches the corresponding obstacle height. In this case, it is a 50-foot obstacle. Therefore, draw the diagonal line to the far edge of the chart. This results in a 600-foot ground roll distance and a total distance of 1,200 feet over a 50-foot obstacle. To find the corresponding takeoff speeds at lift-off and over the 50-foot obstacle, refer to the table on the top of the chart. In this case, the lift-off speed at 2,600 pounds would be 63 knots and over the 50-foot obstacle would be 68 knots.

### Sample Problem 3

Pressure Altitude.....3,000 feet  
 OAT.....30°C  
 Takeoff Weight.....2,400 pounds  
 Headwind.....18 knots

Refer to figure 9-25. This chart is an example of a takeoff distance table for short-field takeoffs. For this table, first find the takeoff weight. Once at 2,400 pounds, begin reading from left to right across the

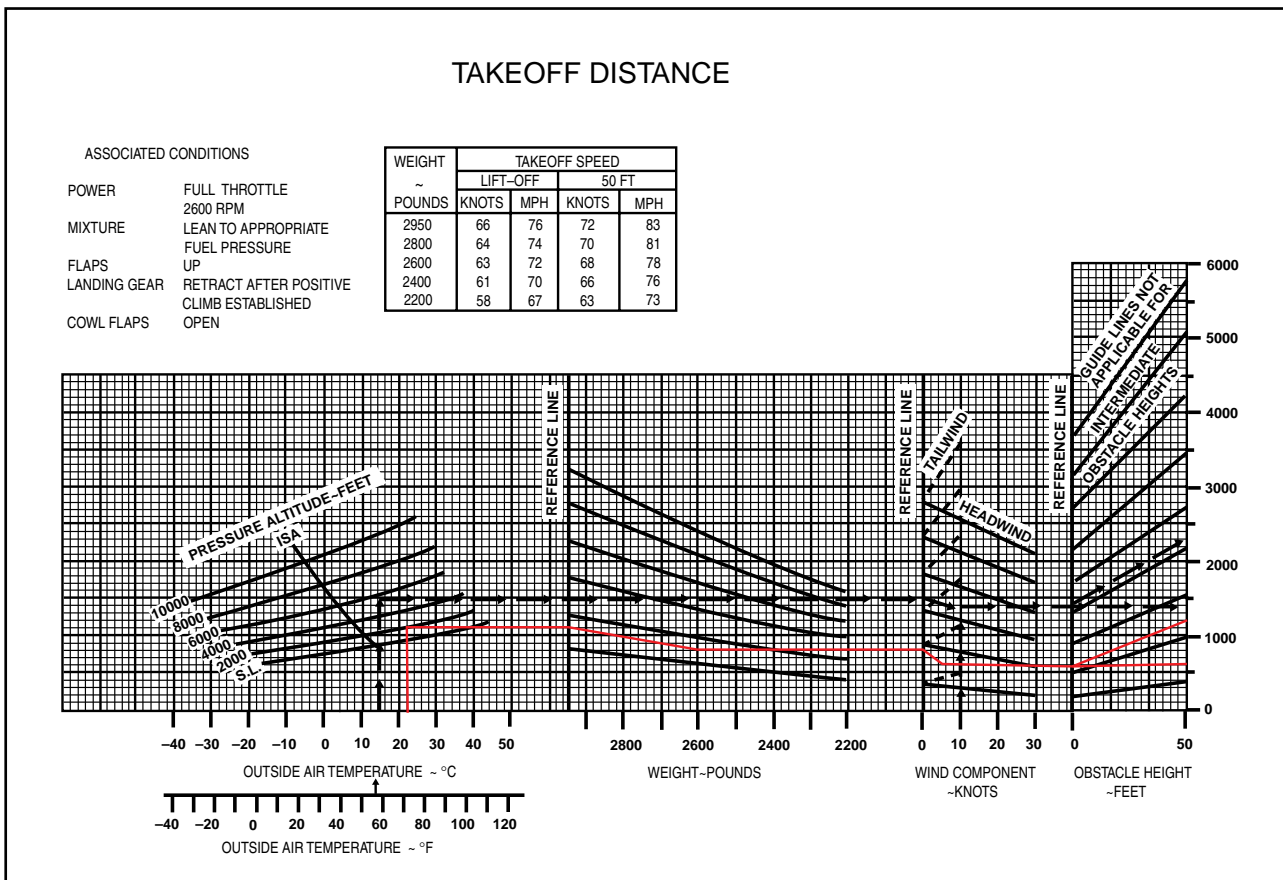

Figure 9-24. Combined takeoff distance graph.

table. The takeoff speed is in the second column and, in the third column under pressure altitude, find the pressure altitude of 3,000 feet. Carefully follow that line to the right until it is under the correct temperature column of 30°C. The ground roll total reads 1,325 feet and the total required to clear a 50-foot obstacle is 2,480 feet. At this point, there are 18 knots of headwind. Reading in the notes section under point number two, it says to decrease the distances by 10 percent for each 9 knots of headwind. With 18 knots of headwind, it is necessary to decrease the distance by 20 percent. Multiply 1,325 feet by 20 percent or by .20 (1325 x .20 = 265), then subtract that amount from the total distance (1325 - 265 = 1060). Repeat this process for the total distance over a 50-foot obstacle. The ground roll distance is 1,060 feet and the total distance over a 50-foot obstacle is 1,984 feet.

### CLIMB AND CRUISE CHARTS

Climb and cruise chart information is based on actual flight tests conducted in an airplane of the same type. This information is extremely useful when planning a cross-country to predict the performance and fuel consumption of the airplane. Manufacturers produce

several different charts for climb and cruise performance. These charts will include everything from fuel, time, and distance to climb, to best power setting during cruise, to cruise range performance.

The first chart to check for climb performance is a fuel, time, and distance-to-climb chart. This chart will give the fuel amount used during the climb, the time it will take to accomplish the climb, and the ground distance that will be covered during the climb. To use this chart, obtain the information for the departing airport and for the cruise altitude. Using figure 9-26, calculate the fuel, time, and distance to climb based on the information provided.

#### Sample Problem 4

Departing Airport Pressure Altitude.....6,000 feet  
 Departing Airport OAT.....25°C  
 Cruise Pressure Altitude.....10,000 feet  
 Cruise OAT.....10°C

First, find the information for the departing airport. Find the OAT for the departing airport along the bottom, left-hand side of the graph. Follow the line from

<b>TAKEOFF DISTANCE MAXIMUM WEIGHT 2400 LB</b>													
<b>SHORT FIELD</b>													
CONDITIONS: Flaps 10° Full Throttle Prior to Brake Release Paved Level Runway Zero Wind													
NOTES: 1. Prior to takeoff from fields above 3000 feet elevation, the mixture should be leaned to give maximum RPM in a full throttle, static runup. 2. Decrease distances 10% for each 9 knots headwind. For operation with tailwind up to 10 knots, increase distances by 10% for each 2 knots. 3. For operation on a dry, grass runway, increase distances by 15% of the "ground roll" figure.													
WEIGHT LB	TAKEOFF SPEED KIAS		PRESS ALT FT	0 °C		10 °C		20 °C		30 °C		40 °C	
	LIFT OFF	AT 50 FT		GRND ROLL FT	TOTAL FT TO CLEAR 50 FT OBS	GRND ROLL FT	TOTAL FT TO CLEAR 50 FT OBS	GRND ROLL FT	TOTAL FT TO CLEAR 50 FT OBS	GRND ROLL FT	TOTAL FT TO CLEAR 50 FT OBS	GRND ROLL FT	TOTAL FT TO CLEAR 50 FT OBS
2400	51	56	S.L.	795	1460	860	1570	925	1685	995	1810	1065	1945
			1000	875	1605	940	1725	1015	1860	1090	2000	1170	2155
			2000	960	1770	1035	1910	1115	2060	1200	2220	1290	2395
			3000	1055	1960	1140	2120	1230	2295	1325	2480	1425	2685
			4000	1165	2185	1260	2365	1355	2570	1465	2790	1575	3030
			5000	1285	2445	1390	2660	1500	2895	1620	3160	1745	3455
			6000	1425	2755	1540	3015	1665	3300	1800	3620	1940	3990
			7000	1580	3140	1710	3450	1850	3805	2000	4220	---	---
			8000	1755	3615	1905	4015	2060	4480	---	---	---	---
2200	49	54	S.L.	650	1195	700	1280	750	1375	805	1470	865	1575
			1000	710	1310	765	1405	825	1510	885	1615	950	1735
			2000	780	1440	840	1545	905	1660	975	1785	1045	1915
			3000	855	1585	925	1705	995	1835	1070	1975	1150	2130
			4000	945	1750	1020	1890	1100	2040	1180	2200	1270	2375
			5000	1040	1945	1125	2105	1210	2275	1305	2465	1405	2665
			6000	1150	2170	1240	2355	1340	2555	1445	2775	1555	3020
			7000	1270	2440	1375	2655	1485	2890	1605	3155	1730	3450
			8000	1410	2760	1525	3015	1650	3305	1785	3630	1925	4005
2000	46	51	S.L.	525	970	565	1035	605	1110	650	1185	695	1265
			1000	570	1060	615	1135	665	1215	710	1295	765	1385
			2000	625	1160	675	1240	725	1330	780	1425	840	1525
			3000	690	1270	740	1365	800	1465	860	1570	920	1685
			4000	755	1400	815	1500	880	1615	945	1735	1015	1865
			5000	830	1545	900	1660	970	1790	2145	1925	1120	2070
			6000	920	1710	990	1845	1070	1990	2405	2145	1235	2315
			7000	1015	1900	1095	2055	1180	2225	2715	2405	1370	2605
			8000	1125	2125	1215	2305	1310	2500	3015	2715	1520	2950

Figure 9-25. Takeoff distance table, short-field.

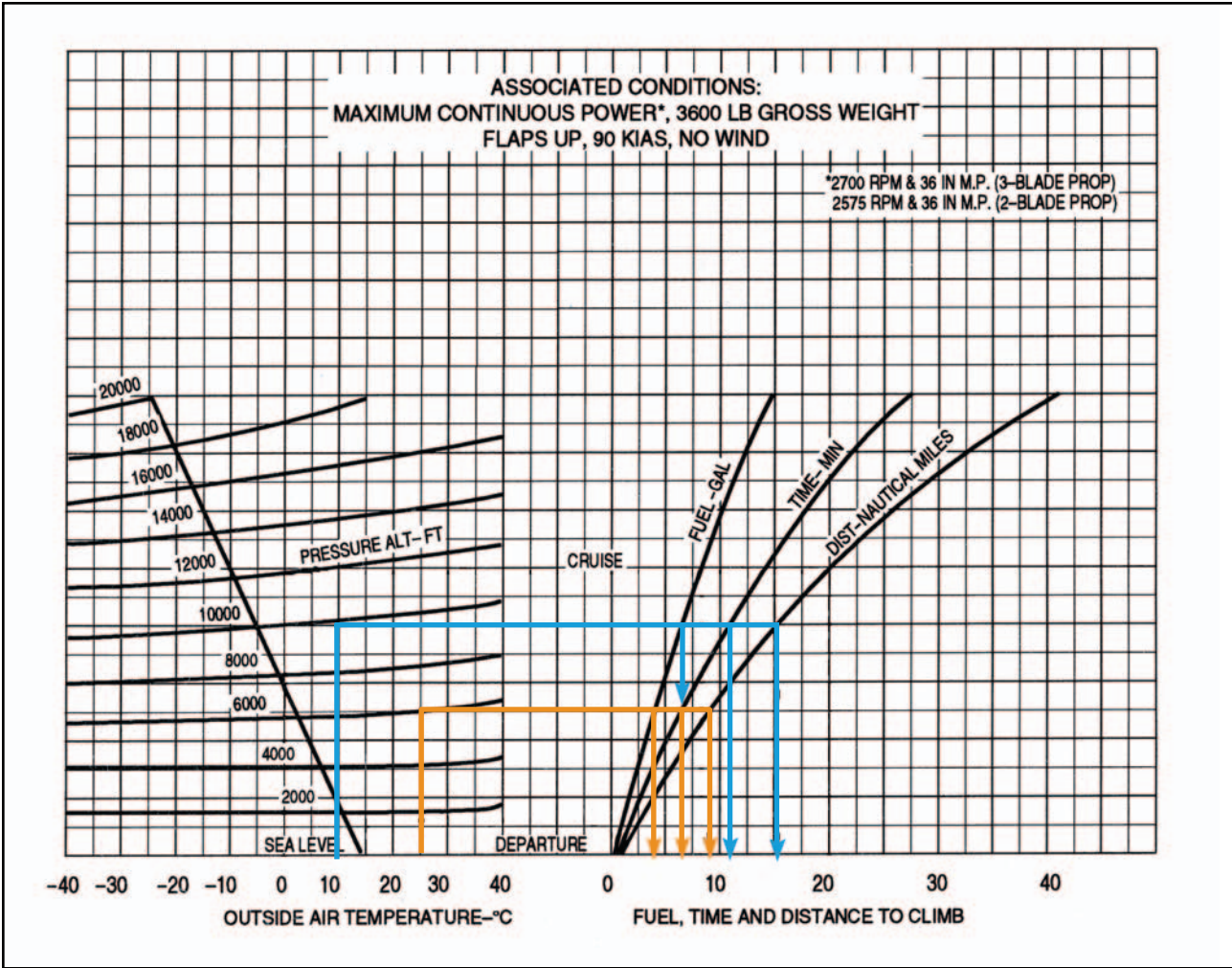

Figure 9-26. Fuel, time, and distance-to-climb chart.

25°C straight up until it intersects the line corresponding to the pressure altitude of 6,000 feet. Continue this line straight across until it intersects all three lines for fuel, time, and distance. Draw a line straight down from the intersection of altitude and fuel, altitude and time, and a third line at altitude and distance. It should read 3.5 gallons of fuel, 6.5 minutes of time, and 9 nautical miles. Next, repeat the steps to find the information for the cruise altitude. It should read 6.5 gallons of fuel, 11.5 minutes of time, and 15 nautical miles. Take each set of numbers for fuel, time, and distance and subtract them from one another (6.5 - 3.5 = 3 gallons of fuel). It will take 3 gallons of fuel and 5 minutes of time to climb to 10,000 feet. During that climb, the distance covered is 6 nautical miles. Remember, according to the notes at the top of the chart, these numbers do not take into account wind, and it is assumed maximum continuous power is being used.

The next example is a fuel, time, and distance-to-climb table. For this table, use the same basic criteria as for the previous chart. However, it is necessary to figure

the information in a different manner. Refer to figure 9-27 to work the following sample problem.

**Sample Problem 5**

Departing Airport Pressure Altitude.....Sea Level  
 Departing Airport OAT.....22°C  
 Cruise Pressure Altitude.....8,000 feet  
 Takeoff Weight.....3,400 pounds

To begin, find the given weight of 3,400 in the first column of the chart. Move across to the pressure altitude column to find the sea level altitude numbers. At sea level, the numbers read zero. Next, read the line that corresponds with the cruising altitude of 8,000 feet. Normally, a pilot would subtract these two sets of number from one another, but given the fact that the numbers read zero at sea level, it is known that the time to climb from sea level to 8,000 feet is 10 minutes. It is also known that 21 pounds of fuel will be used and 20 nautical miles will be covered during the climb. However, the temperature is 22°C, which is 7° above the standard temperature of 15°C. The notes section of this chart indicate that our findings must

**NORMAL CLIMB – 110 KIAS**

**CONDITIONS:**  
 Flaps Up  
 Gear Up  
 2500 RPM  
 30 Inches Hg  
 120 PPH Fuel Flow  
 Cowl Flaps Open  
 Standard Temperature

**NOTES:**  
 1. Add 16 pounds of fuel for engine start, taxi and takeoff allowance.  
 2. Increase time, fuel and distance by 10% for each 7 °C above standard temperature.  
 3. Distances shown are based on zero wind.

WEIGHT LBS	PRESS ALT FT	RATE OF CLIMB FPM	FROM SEA LEVEL		
			TIME MIN	FUEL USED POUNDS	DISTANCE NM
4000	S.L.	605	0	0	0
	4000	570	7	14	13
	8000	530	14	28	27
	12,000	485	22	44	43
	16,000	430	31	62	63
	20,000	365	41	82	87
3700	S.L.	700	0	0	0
	4000	665	6	12	11
	8000	625	12	24	23
	12,000	580	19	37	37
	16,000	525	26	52	53
	20,000	460	34	68	72
3400	S.L.	810	0	0	0
	4000	775	5	10	9
	8000	735	10	21	20
	12,000	690	16	32	31
	16,000	635	22	44	45
	20,000	565	29	57	61

Figure 9-27. Fuel, time, and distance-to-climb table.

be increased by 10 percent for each 7° above standard. Multiply the findings by 10 percent or .10 (10 x .10 = 1, 1 + 10 = 11 minutes). After accounting for the additional 10 percent, the findings should read 11 minutes, 23.1 pounds of fuel, and 22 nautical miles. Notice that the fuel is reported in pounds of fuel, not gallons. Aviation fuel weighs 6 pounds per gallon, so 23.1 pounds of fuel is equal to 3.85 gallons of fuel (23.1 / 6 = 3.85).

The next example is a cruise and range performance chart. This type of table is designed to give true air-speed, fuel consumption, endurance in hours, and range in miles at specific cruise configurations. Use figure 9-28 to determine the cruise and range performance under the given conditions.

**Sample Problem 6**

Pressure Altitude.....5,000 feet  
 RPM.....2,400 r.p.m.  
 Fuel Carrying Capacity.....38 gallons, no reserve

Find 5,000 feet pressure altitude in the first column on the left-hand side of the table. Next, find the correct r.p.m. of 2,400 in the second column. Follow that line straight across and read the TAS of 116 m.p.h., and a fuel burn rate of 6.9 gallons per hour. As per the example, the airplane is equipped with a fuel carrying capacity of 38 gallons. Under this column, read that the endurance in hours is 5.5 hours and the range in miles is 635 miles.



Gross Weight- 2300 Lbs.  
Standard Conditions  
Zero Wind Lean Mixture

NOTE: Maximum cruise is normally limited to 75% power.

ALT.	RPM	% BHP	TAS MPH	GAL/HOUR	38 GAL (NO RESERVE)		48 GAL (NO RESERVE)	
					ENDR. HOURS	RANGE MILES	ENDR. HOURS	RANGE MILES
2500	2700	86	134	9.7	3.9	525	4.9	660
	2600	79	129	8.6	4.4	570	5.6	720
	2500	72	123	7.8	4.9	600	6.2	760
	2400	65	117	7.2	5.3	620	6.7	780
	2300	58	111	6.7	5.7	630	7.2	795
	2200	52	103	6.3	6.1	625	7.7	790
5000	2700	82	134	9.0	4.2	565	5.3	710
	2600	75	128	8.1	4.7	600	5.9	760
	2500	68	122	7.4	5.1	625	6.4	790
	2400	61	116	6.9	5.5	635	6.9	805
	2300	55	108	6.5	5.9	635	7.4	805
	2200	49	100	6.0	6.3	630	7.9	795
7500	2700	78	133	8.4	4.5	600	5.7	755
	2600	71	127	7.7	4.9	625	6.2	790
	2500	64	121	7.1	5.3	645	6.7	810
	2400	58	113	6.7	5.7	645	7.2	820
	2300	52	105	6.2	6.1	640	7.7	810
10,000	2650	70	129	7.6	5.0	640	6.3	810
	2600	67	125	7.3	5.2	650	6.5	820
	2500	61	118	6.9	5.5	655	7.0	830
	2400	55	110	6.4	5.9	650	7.5	825
	2300	49	100	6.0	6.3	635	8.0	800

Figure 9-28. Cruise and range performance.

Cruise power setting tables are useful when planning cross-country flights. The table gives the correct cruise power settings as well as the fuel flow and airspeed performance numbers at that altitude and airspeed.

**Sample Problem 7**

Pressure Altitude @ Cruise.....6,000 feet  
OAT.....36°F above standard

Refer to figure 9-29 for this sample problem. First, locate the pressure altitude of 6,000 feet on the far left side of the table. Follow that line across to the far right side of the table under the 20°C (or 36°F) column. At 6,000 feet, the r.p.m. setting of 2,450 will maintain 65

percent continuous power at 21.0 inches of manifold pressure with a fuel flow rate of 11.5 gallons per hour and airspeed of 161 knots.

Another type of cruise chart is a best power mixture range graph. This graph gives the best range based on power setting and altitude. Using figure 9-30, find the range at 65 percent power with and without a reserve based on the provided conditions.

**Sample Problem 8**

OAT.....Standard  
Pressure Altitude.....5,000 feet

## CRUISE POWER SETTINGS

65% MAXIMUM CONTINUOUS POWER (OR FULL THROTTLE)  
2800 POUNDS

PRESS ALT.	ISA -20 °C (-36 °F)								STANDARD DAY (ISA)								ISA +20 °C (+36 °F)							
	IOAT		ENGINE SPEED	MAN. PRESS	FUEL FLOW PER ENGINE		TAS		IOAT		ENGINE SPEED	MAN. PRESS	FUEL FLOW PER ENGINE		TAS		IOAT		ENGINE SPEED	MAN. PRESS	FUEL FLOW PER ENGINE		TAS	
	FEET	°F	°C	RPM	IN HG	PSI	GPH	KTS	MPH	°F	°C	RPM	IN HG	PSI	GPH	KTS	MPH	°F	°C	RPM	IN HG	PSI	GPH	KTS
SL	27	-3	2450	20.7	6.6	11.5	147	169	63	17	2450	21.2	6.6	11.5	150	173	99	37	2450	21.8	6.6	11.5	153	176
2000	19	-7	2450	20.4	6.6	11.5	149	171	55	13	2450	21.0	6.6	11.5	153	176	91	33	2450	21.5	6.6	11.5	156	180
4000	12	-11	2450	20.1	6.6	11.5	152	175	48	9	2450	20.7	6.6	11.5	156	180	84	29	2450	21.3	6.6	11.5	159	183
6000	5	-15	2450	19.8	6.6	11.5	155	178	41	5	2450	20.4	6.6	11.5	158	182	79	26	2450	21.0	6.6	11.5	161	185
8000	-2	-19	2450	19.5	6.6	11.5	157	181	36	2	2450	20.2	6.6	11.5	161	185	72	22	2450	20.8	6.6	11.5	164	189
10000	-8	-22	2450	19.2	6.6	11.5	160	184	28	-2	2450	19.9	6.6	11.5	163	188	64	18	2450	20.3	6.5	11.4	166	191
12000	-15	-26	2450	18.8	6.4	11.3	162	186	21	-6	2450	18.8	6.1	10.9	163	188	57	14	2450	18.8	5.9	10.6	163	188
14000	-22	-30	2450	17.4	5.8	10.5	159	183	14	-10	2450	17.4	5.6	10.1	160	184	50	10	2450	17.4	5.4	9.8	160	184
16000	-29	-34	2450	16.1	5.3	9.7	156	180	7	-14	2450	16.1	5.1	9.4	156	180	43	6	2450	16.1	4.9	9.1	155	178

NOTES: 1. Full throttle manifold pressure settings are approximate.  
2. Shaded area represents operation with full throttle.

Figure 9-29. Cruise power setting table.

First, move up the left side of the graph to 5,000 feet and standard temperature. Follow the line straight across the graph until it intersects the 65 percent line under both the reserve and no reserve categories. Draw

a line straight down from both intersections to the bottom of the graph. At 65 percent power with a reserve, the range is approximately 522 miles. At 65 percent power with no reserve, the range should be 581 miles.

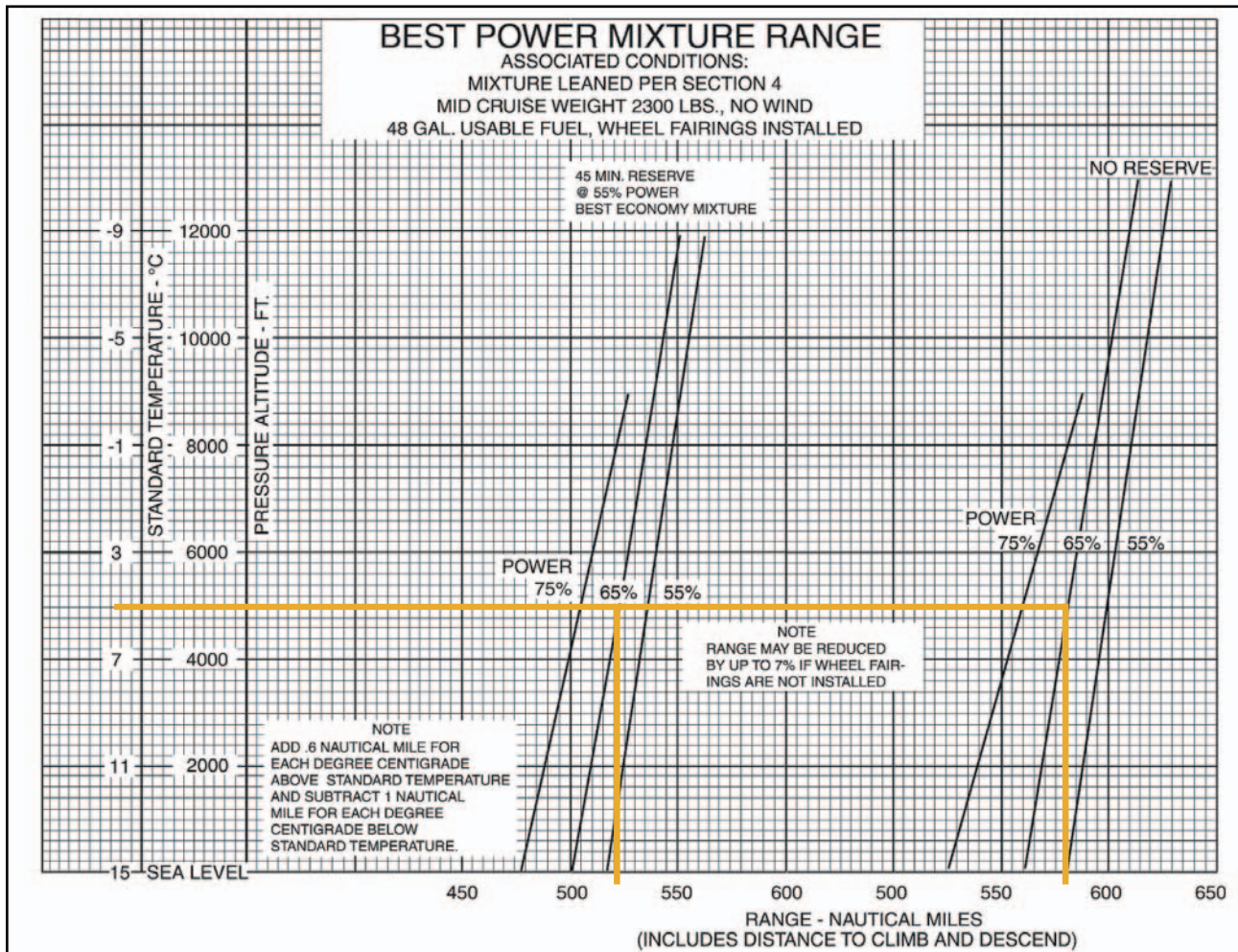

Figure 9-30. Best power mixture range graph.

The last cruise chart referenced is a cruise performance graph. This graph is designed to tell the true airspeed (TAS) performance of the airplane depending on the altitude, temperature, and power setting. Using figure 9-31, find the TAS performance based on the given information.

**Sample Problem 9**

OAT.....16°C  
 Pressure Altitude.....6,000 feet  
 Power Setting.....65 percent, best power  
 Wheel Fairings.....Not installed

Begin by finding the correct OAT on the bottom, left-hand side of the graph. Move up that line until it intersects the pressure altitude of 6,000 feet. Draw a line straight across to the 65 percent, best power line. This is the solid line, not the dashed line, which represents best economy. Draw a line straight down from this intersection to the bottom of the graph. The true airspeed at 65 percent best power is 140 knots. However, it is necessary to subtract 8 knots from the speed since there are no wheel fairings. This note is listed under the title and conditions. The true airspeed will be 132 knots.

**CROSSWIND AND HEADWIND COMPONENT CHART**

Every airplane is tested according to FAA regulations prior to certification. The airplane is tested by a pilot with average piloting skills in 90° crosswinds with a velocity up to 0.2 V<sub>SO</sub> or two-tenths of the airplane’s stalling speed with power off, gear down, and flaps down. This means that if the stalling speed of the airplane is 45 knots, it must be capable of being landed in a 9 knot, 90° crosswind. The maximum demonstrated crosswind component is published in the AFM/POH. The crosswind and headwind component chart allows for figuring the headwind and crosswind component for any given wind direction and velocity.

**Sample Problem 10**

Runway.....17  
 Wind.....140° @ 25 knots

Refer to figure 9-32 to solve this problem. First, determine how many degrees difference there is between the runway and the wind direction. It is known that runway 17 means a direction of 170° and from that, subtract the wind direction of 140°. This gives a 30° angular difference. This is the wind angle. Next, locate the 30° mark and draw a line from there until it intersects the correct wind velocity of 25

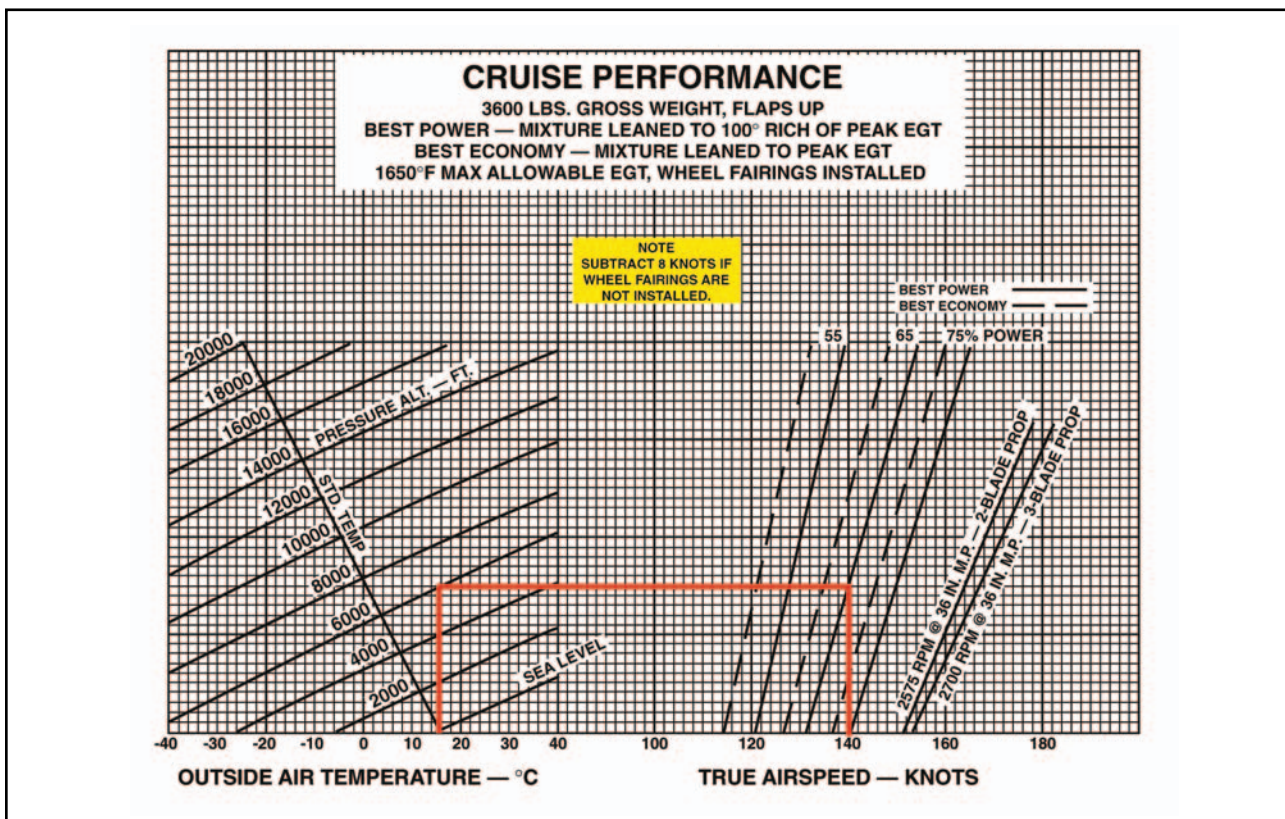

Figure 9-31. Cruise performance graph.

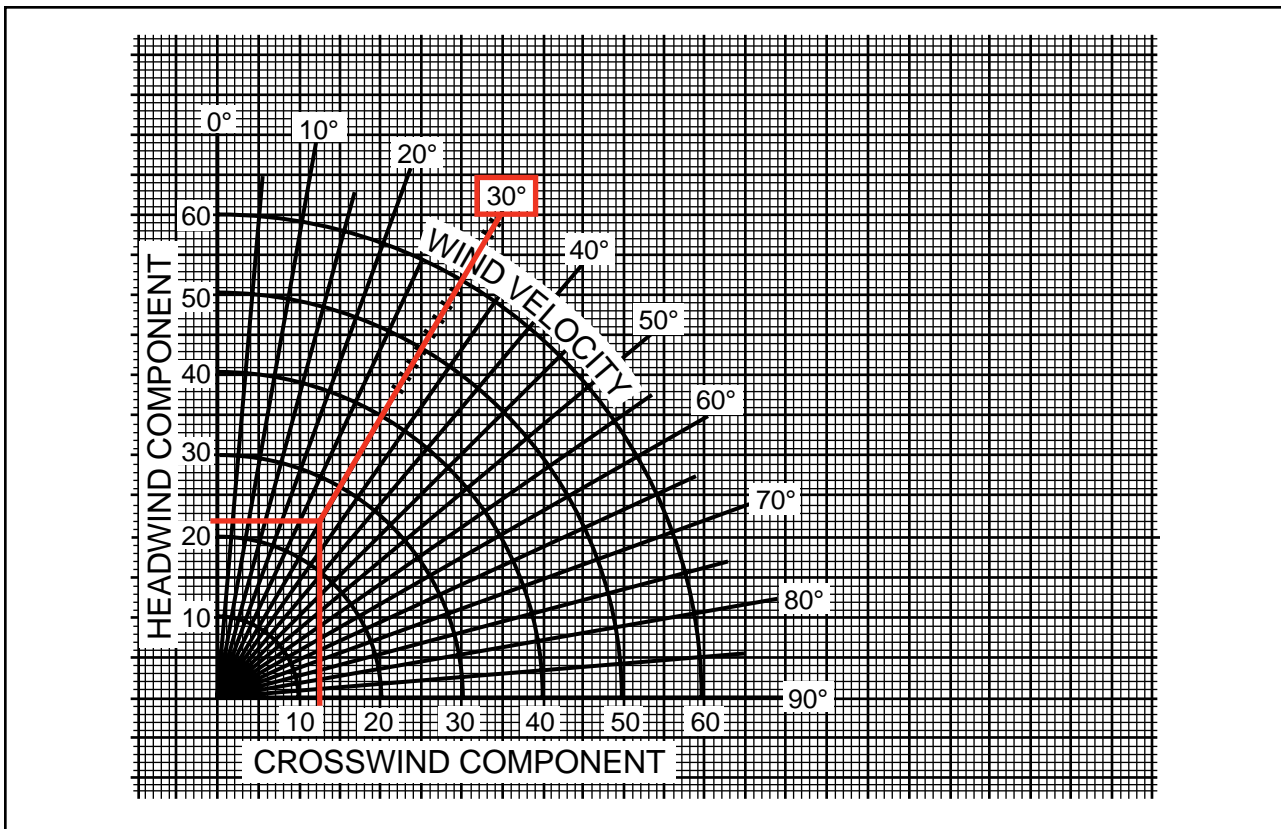

Figure 9-32. Crosswind component chart.

knots. From there, draw a line straight down and a line straight across. The headwind component is 22 knots and the crosswind component is 13 knots. This information is important when taking off and landing so that, first of all, the appropriate runway can be picked if more than one exists at a particular airport, but also so that the airplane is not pushed beyond its tested limits.

### LANDING CHARTS

Landing performance is affected by variables similar to those affecting takeoff performance. It is necessary to compensate for differences in density altitude, weight of the airplane, and headwinds. Like takeoff performance charts, landing distance information is available as normal landing information as well as landing distance over a 50-foot obstacle. As usual, read the associated conditions and notes in order to

ascertain the basis of the chart information. Remember, when calculating landing distance that the landing weight will not be the same as the takeoff weight. The weight must be recalculated to compensate for the fuel that was used during the flight.

### Sample Problem 11

Pressure Altitude.....1,250 feet  
 Temperature.....Standard

Refer to figure 9-33. This example makes use of a landing distance table. Notice that the altitude of 1,250 feet is not on this table. It is therefore necessary to use interpolation skills to find the correct landing distance. The pressure altitude of 1,250 is halfway between sea level and 2,500 feet. First, find the column for sea level and the column for 2,500 feet. Take the total distance of 1,075 for sea level and the total

LANDING DISTANCE										FLAPS LOWERED TO 40° - POWER OFF HARD SURFACE RUNWAY - ZERO WIND	
GROSS WEIGHT LB	APPROACH SPEED IAS, MPH	AT SEA LEVEL & 59 °F		AT 2500 FT & 50 °F		AT 5000 FT & 41 °F		AT 7500 FT & 32 °F			
		GROUND ROLL	TOTAL TO CLEAR 50 FT OBS	GROUND ROLL	TOTAL TO CLEAR 50 FT OBS	GROUND ROLL	TOTAL TO CLEAR 50 FT OBS	GROUND ROLL	TOTAL TO CLEAR 50 FT OBS		
1600	60	445	1075	470	1135	495	1195	520	1255		

NOTES: 1. Decrease the distances shown by 10% for each 4 knots of headwind.  
 2. Increase the distance by 10% for each 60 °F temperature increase above standard.  
 3. For operation on a dry, grass runway, increase distances (both "ground roll" and "total to clear 50 ft obstacle") by 20% of the "total to clear 50 ft obstacle" figure.

Figure 9-33. Landing distance table.

distance of 1,135 for 2,500 and add them together. Divide the total by two to obtain the distance for 1,250 feet. The distance is 1,105 feet total landing distance to clear a 50-foot obstacle. Repeat this process to obtain the ground roll distance for the pressure altitude. The ground roll should be 457.5 feet.

**Sample Problem 12**

OAT.....57°F  
 Pressure Altitude.....4,000 feet  
 Landing Weight.....2,400 pounds  
 Headwind.....6 knots  
 Obstacle Height.....50 foot

Using the given conditions and figure 9-34, determine the landing distance for the airplane. This graph is an example of a combined landing distance graph and allows compensation for temperature, weight, headwinds, tailwinds, and varying obstacle height. Begin by finding the correct OAT on the Fahrenheit scale on the left-hand side of the chart. Move up in a straight line to the correct pressure altitude of 4,000 feet. From this intersection, move straight across to the first dark reference line. Follow the lines in the same diagonal fashion until the correct landing weight is reached. At 2,400 pounds, continue in a straight line across to the second dark reference line. Once again, draw a line in a

diagonal manner to the correct wind component and then straight across to the third dark reference line. From this point, draw a line in two separate directions: one straight across to figure the ground roll and one in a diagonal manner to the correct obstacle height. This should be 900 feet for the total ground roll and 1,300 feet for the total distance over a 50-foot obstacle.

**STALL SPEED PERFORMANCE CHARTS**

Stall speed performance charts are designed to give an understanding of the speed at which the airplane will stall in a given configuration. This type of chart will typically take into account the angle of bank, the position of the gear and flaps, and the throttle position. Use figure 9-35 and the accompanying conditions to find the speed at which the airplane will stall.

**Sample Problem 13**

Power.....OFF  
 Flaps.....Down  
 Gear.....Down  
 Angle of Bank.....45°

First, locate the correct flap and gear configuration. The bottom half of the chart should be used since the gear and flaps are down. Next, choose the row corresponding to a power-off situation. Now find the correct

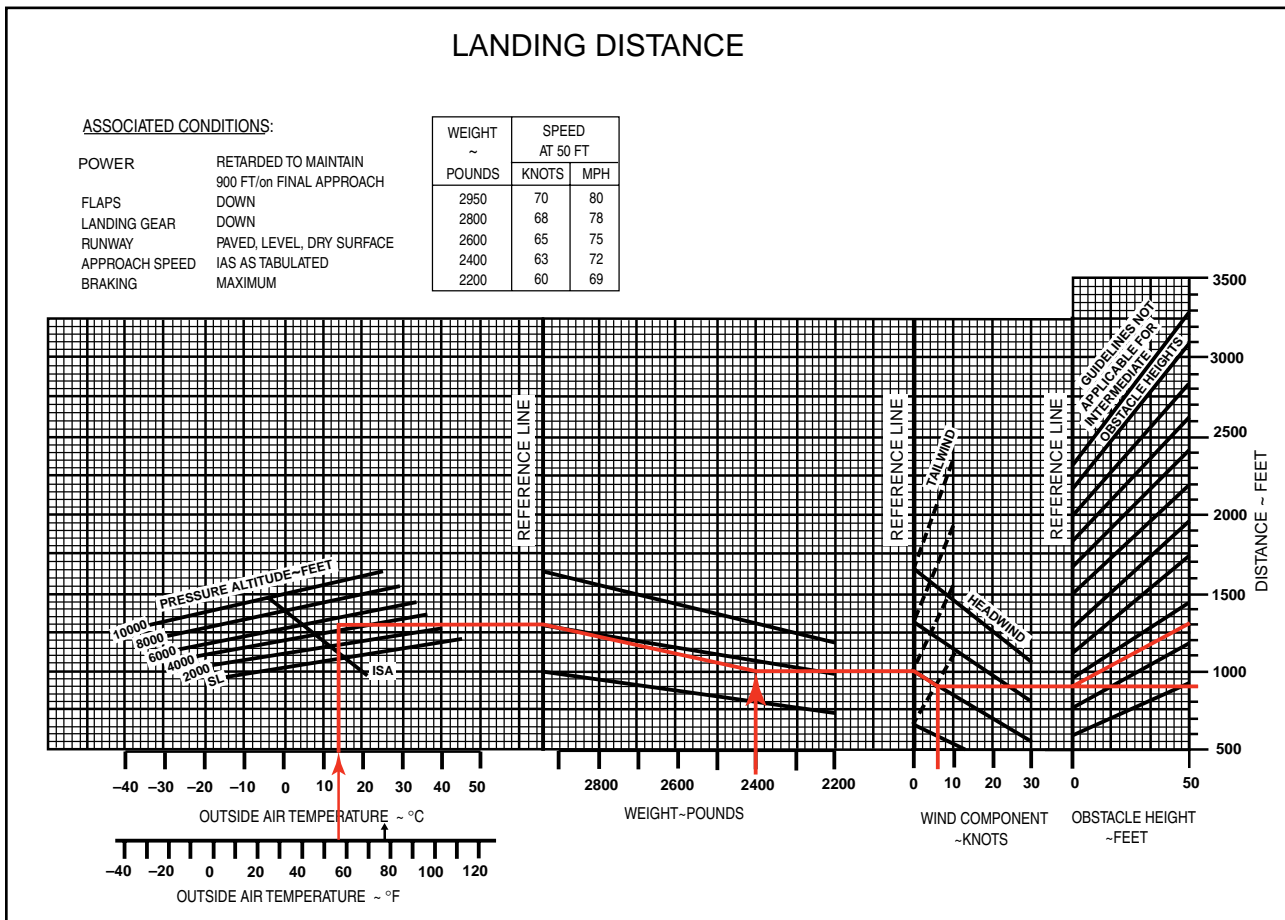

Figure 9-34. Landing distance graph.

GROSS WEIGHT 2750 LBS		ANGLE OF BANK			
		LEVEL	30°	45°	60°
POWER		GEAR AND FLAPS UP			
ON	MPH	62	67	74	88
	KTS	54	58	64	76
OFF	MPH	75	81	89	106
	KTS	65	70	77	92
		GEAR AND FLAPS DOWN			
ON	MPH	54	58	64	76
	KTS	47	50	56	66
OFF	MPH	66	71	78	93
	KTS	57	62	68	81

Figure 9-35. Stall speed table.

angle of bank column, which is 45°. The stall speed in miles per hour (m.p.h.) is 78 m.p.h., and the stall speed in knots would be 68 knots.

Performance charts provide valuable information to the pilot. Take advantage of these charts. A pilot can predict the performance of the airplane under most flying conditions, and this enables a better plan for every flight. The Code of Federal Regulations (CFR) requires that a pilot be familiar with all information available prior to any flight. Pilots should use the information to their advantage as it can only contribute to safety in flight.

## TRANSPORT CATEGORY AIRPLANE PERFORMANCE

Transport category airplanes are certificated under Title 14 of the Code of Federal Regulations (14 CFR) part 25. The airworthiness certification standards of part 25 require proven levels of performance and guaranteed safety margins for these airplanes, regardless of the specific operating regulations under which they are employed.

### MAJOR DIFFERENCES IN TRANSPORT CATEGORY VERSUS NON-TRANSPORT CATEGORY PERFORMANCE REQUIREMENTS

- **Full Temperature Accountability**  
All of the performance charts for the transport category airplanes require that takeoff and climb

performance be computed with the full effects of temperature considered.

- **Climb Performance Expressed as Percent Gradient of Climb**  
The transport category airplane's climb performance is expressed as a percent gradient of climb rather than a figure calculated in feet per minute of climb. This percent gradient of climb is a much more practical expression of performance since it is the airplane's angle of climb that is critical in an obstacle clearance situation.
- **Change in Lift-off Technique**  
Lift-off technique in transport category airplanes allows the reaching of  $V_2$  (takeoff safety speed) after the airplane is airborne. This is possible because of the excellent acceleration and reliability characteristics of the engines on these airplanes and also because of the larger surplus of power.
- **Performance Requirements Applicable to all Segments of Aviation**  
All airplanes certificated by the FAA in the transport category, whatever the size, must be operated in accordance with the same performance criteria. This applies to both commercial and non-commercial operations.

## PERFORMANCE REQUIREMENTS

The performance requirements that the transport category airplane must meet are as follows:

### TAKEOFF

- Takeoff speeds
- Takeoff runway required
- Takeoff climb required
- Obstacle clearance requirements

### LANDING

- Landing speeds
- Landing runway required
- Landing climb required

### TAKEOFF PLANNING

The following are the speeds that affect the transport category airplane's takeoff performance. The flight crew must be thoroughly familiar with each of these speeds and how they are used in takeoff planning.

Speed	Definition
$V_S$	Stalling speed or the minimum steady flight speed at which the airplane is controllable.
$V_{MCG}$	Minimum control speed on the ground, with one engine inoperative, (critical engine on two-engine airplanes) takeoff power on other engine(s), using aerodynamic controls only for directional control. (Must be less than $V_1$ ).
$V_{MCA}$	Minimum control speed in the air, with one engine inoperative, (critical engine on two-engine airplanes) operating engine(s) at take off power, maximum of 5° bank into the good engine(s).
$V_1$	Critical engine failure speed or decision speed. Engine failure below this speed shall result in an aborted takeoff; above this speed the take off run should be continued.
$V_R$	Speed at which the rotation of the airplane is initiated to takeoff attitude. This speed cannot be less than $V_1$ or less than 1.05 times VMC. With an engine failure, it must also allow for the acceleration to $V_2$ at the 35-foot height at the end of the runway.
$V_{LO}$	Lift-off speed. The speed at which the airplane first becomes airborne.
$V_2$	The takeoff safety speed which must be attained at the 35-foot height at the end of the required runway distance. This is essentially the best one-engine inoperative angle of climb speed for the airplane and should be held until clearing obstacles after takeoff, or until at least 400 feet above the ground.
$V_{FS}$	Final segment climb speed, which is based upon one-engine inoperative climb, clean configuration, and maximum continuous power setting.

All of the above V speeds should be considered during every takeoff. The  $V_1$ ,  $V_R$ ,  $V_2$  and  $V_{FS}$  speeds should be visibly posted in the cockpit for reference during the takeoff.

Takeoff speeds vary with airplane weight. Before takeoff speeds can be computed, the pilot must first determine the maximum allowable takeoff weight. The three items that can limit takeoff weight are runway require-

ments, takeoff climb requirements, and obstacle clearance requirements.

## RUNWAY REQUIREMENTS

The runway requirements for takeoff will be affected by the following:

- Pressure altitude
- Temperature
- Headwind component
- Runway gradient or slope
- Airplane weight

The runway required for takeoff must be based upon the possible loss of an engine at the most critical point, which is at  $V_1$  (decision speed). By regulation, the airplane's takeoff weight has to accommodate the longest of three distances:

### 1. Accelerate-Go Distance

The distance required to accelerate to  $V_1$  with all engines at takeoff power, experience an engine failure at  $V_1$  and continue the takeoff on the remaining engine(s). The runway required includes the distance required to climb to 35 feet by which time  $V_2$  speed must be attained.

### 2. Accelerate-Stop Distance

The distance required to accelerate to  $V_1$  with all engines at takeoff power, experience an engine failure at  $V_1$ , and abort the takeoff and bring the airplane to a stop using braking action only (use of thrust reversing is not considered).

### 3. Takeoff Distance

The distance required to complete an all-engines operative takeoff to the 35-foot height. It must be at least 15 percent less than the distance required for a one-engine inoperative engine takeoff. This distance is not normally a limiting factor as it is usually less than the one-engine inoperative takeoff distance.

These three required takeoff runway considerations are shown in figure 9-36.

## BALANCED FIELD LENGTH

In most cases, the pilot will be working with a performance chart for takeoff runway required, which will give "balanced field length" information. This means that the distance shown for the takeoff will include both the accelerate-go and accelerate-stop distances. One

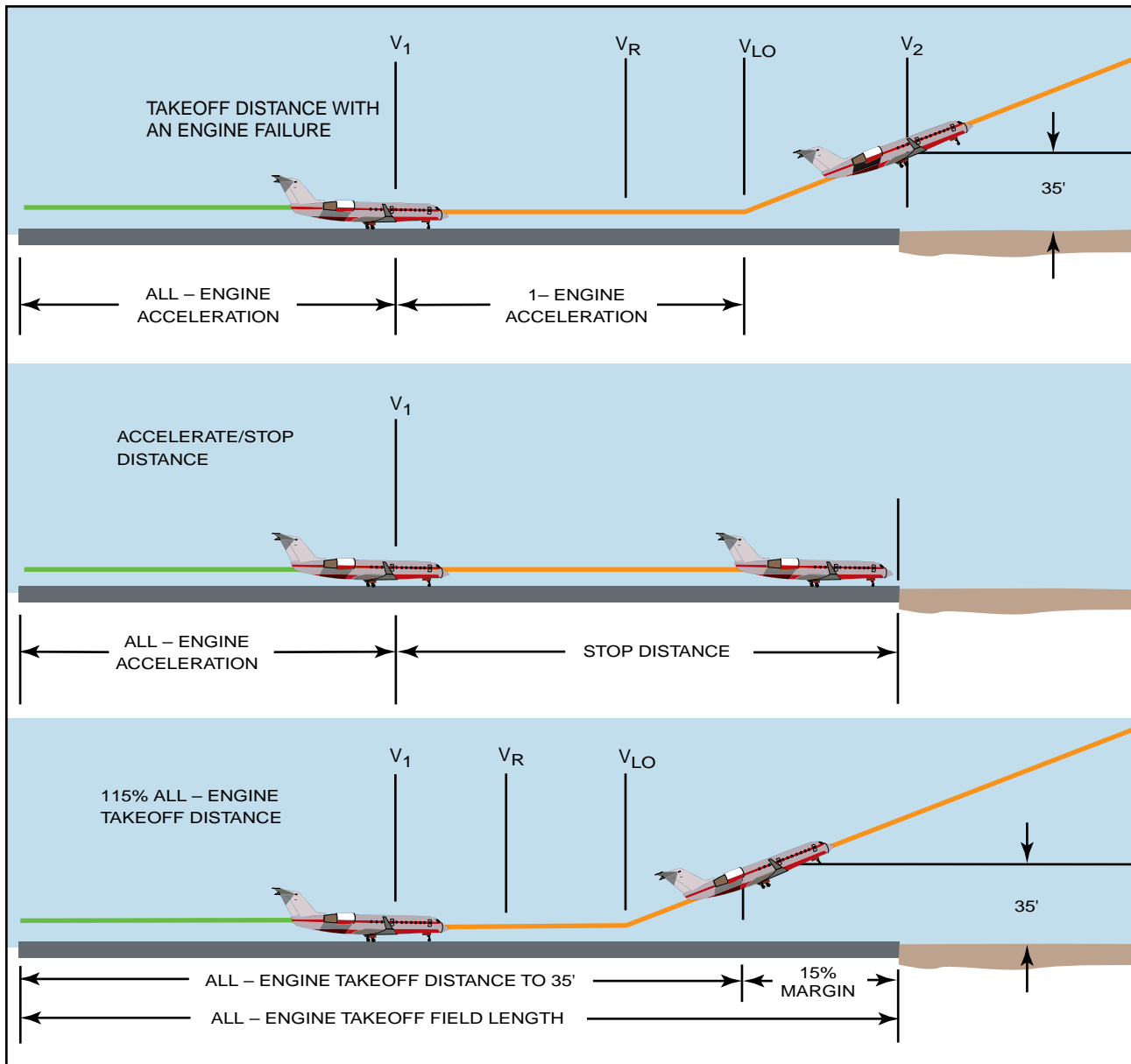

Figure 9-36. Minimum required takeoff runway lengths.

effective means of presenting the normal takeoff data is shown in the tabulated chart in figure 9-37.

The chart in figure 9-37 shows the runway distance required under normal conditions and is useful as a quick reference chart for the standard takeoff. The V speeds for the various weights and conditions are also shown.

For other than normal takeoff conditions, such as with engine anti-ice, anti-skid brakes inoperative, or extremes in temperature or runway slope, the pilot should consult the appropriate takeoff performance

charts in the performance section of the Airplane Flight Manual.

There are other occasions of very high weight and temperature where the runway requirement may be dictated by the maximum brake kinetic energy limits that affect the airplane's ability to stop. Under these conditions, the accelerate-stop distance may be greater than the accelerate-go. The procedure to bring performance back to a balanced field takeoff condition is to limit the  $V_1$  speed so that it does not exceed the maximum brake kinetic energy speed (sometimes called VBE). This procedure also results in a reduction in allowable takeoff weight.



TAKE-OFF RUNWAY REQUIREMENTS  
Standard ISA Conditions  
Cabin Pressurization ON  
Zero slope runway  
No Flaps – Anti-ice RAM air inlets OFF  
Anti-skid ON  
Distances – 100 feet ( $V_1$  – KIAS)

TAKE-OFF GROSS WT. AT BRAKE RELEASE	TEMP		PRESSURE ALTITUDE – FEET							Head- wind (Knots)
	°F	°C	SEA LEVEL ( $V_1$ )	1000 ( $V_1$ )	2000 ( $V_1$ )	3000 ( $V_1$ )	4000 ( $V_1$ )	5000 ( $V_1$ )	6000 ( $V_1$ )	
19,612  $V_R = 126$	30	-1.1	47 (121)	48 (121)	50 (120)	53 (121)	57 (122)	62 (123)	70 (123)	0
	50	10	48 (121)	51 (121)	55 (121)	60 (122)	63 (123)	69 (124)	77 (125)	
	70	21	53 (122)	56 (122)	60 (123)	65 (124)	70 (125)	77 (125)	85 (126)	
	90	32	58 (123)	62 (124)	68 (124)	73 (125)	78 (126)	85 (127)	95 (129)	
$V_1 = 134$	30	-1.1	43 (121)	43 (121)	45 (120)	48 (121)	52 (122)	56 (123)	64 (123)	20
	50	10	43 (121)	46 (121)	50 (121)	55 (122)	57 (123)	63 (124)	70 (125)	
	70	21	48 (122)	51 (122)	55 (123)	59 (124)	63 (125)	70 (125)	77 (126)	
	90	32	53 (123)	57 (124)	62 (124)	66 (125)	71 (126)	77 (127)	85 (129)	
19,000  $V_R = 124$	30	-1.1	45 (118)	45 (118)	47 (117)	50 (118)	54 (119)	59 (120)	66 (120)	0
	50	10	46 (118)	48 (118)	51 (118)	56 (119)	59 (120)	65 (121)	73 (121)	
	70	21	50 (118)	53 (119)	57 (120)	66 (121)	66 (121)	72 (122)	80 (123)	
	90	32	55 (120)	59 (121)	64 (121)	73 (122)	73 (123)	80 (124)	90 (124)	
$V_1 = 131$	30	-1.1	40 (118)	41 (118)	43 (117)	45 (118)	49 (119)	54 (120)	60 (120)	20
	50	10	42 (118)	44 (118)	46 (118)	51 (119)	54 (120)	59 (121)	66 (121)	
	70	21	45 (118)	48 (119)	52 (120)	56 (121)	60 (121)	65 (122)	72 (123)	
	90	32	50 (120)	54 (121)	58 (121)	63 (122)	66 (123)	73 (124)	81 (124)	
18,000  $V_R = 119$	30	-1.1	40 (114)	41 (114)	42 (113)	45 (113)	49 (114)	53 (115)	60 (115)	0
	50	10	41 (115)	43 (114)	46 (114)	50 (115)	53 (115)	59 (116)	66 (117)	
	70	21	45 (114)	48 (115)	51 (115)	56 (116)	59 (116)	65 (116)	72 (117)	
	90	32	50 (115)	53 (116)	58 (116)	62 (117)	66 (118)	73 (118)	80 (119)	
$V_1 = 127$	30	-1.1	36 (114)	37 (114)	38 (113)	41 (113)	45 (114)	48 (115)	54 (115)	20
	50	10	37 (115)	39 (114)	42 (114)	46 (115)	48 (115)	54 (116)	60 (117)	
	70	21	41 (114)	44 (115)	46 (115)	51 (116)	56 (116)	59 (116)	65 (117)	
	90	32	46 (115)	48 (116)	53 (116)	56 (117)	60 (118)	66 (118)	73 (119)	
17,000  $V_R = 115$	30	-1.1	36 (108)	37 (108)	38 (107)	40 (108)	44 (109)	48 (110)	53 (111)	0
	50	10	37 (110)	39 (108)	41 (109)	45 (110)	48 (110)	53 (111)	59 (112)	
	70	21	40 (108)	43 (110)	46 (111)	50 (111)	53 (112)	58 (111)	65 (113)	
	90	32	45 (111)	46 (112)	52 (112)	56 (113)	59 (114)	65 (114)	72 (114)	
$V_1 = 124$	30	-1.1	32 (108)	33 (108)	34 (107)	36 (108)	40 (109)	44 (110)	48 (111)	20
	50	10	34 (110)	35 (108)	37 (109)	41 (110)	44 (110)	48 (111)	54 (112)	
	70	21	36 (108)	39 (110)	42 (111)	45 (111)	48 (112)	53 (111)	59 (113)	
	90	32	41 (111)	44 (112)	47 (112)	51 (113)	54 (114)	59 (114)	65 (114)	
16,000  $V_R = 111$	30	-1.1	32 (104)	33 (103)	34 (103)	36 (103)	39 (105)	43 (106)	48 (106)	0
	50	10	34 (105)	35 (103)	37 (104)	41 (105)	43 (106)	47 (107)	53 (107)	
	70	21	36 (104)	38 (105)	41 (105)	45 (106)	48 (107)	52 (107)	58 (108)	
	90	32	41 (106)	43 (107)	46 (107)	50 (108)	53 (108)	58 (109)	64 (110)	
$V_1 = 120$	30	-1.1	29 (104)	30 (103)	31 (103)	32 (103)	35 (105)	39 (106)	44 (106)	20
	50	10	31 (105)	32 (103)	33 (104)	37 (105)	39 (106)	43 (107)	48 (107)	
	70	21	32 (104)	34 (105)	37 (105)	41 (106)	44 (107)	47 (107)	53 (108)	
	90	32	37 (106)	39 (107)	42 (107)	45 (108)	48 (108)	53 (109)	58 (110)	
15,000  $V_R = 106$	30	-1.1	28 (98)	30 (98)	30 (98)	32 (98)	35 (99)	38 (101)	42 (101)	0
	50	10	30 (100)	31 (98)	33 (99)	36 (100)	38 (101)	42 (102)	46 (102)	
	70	21	32 (99)	34 (100)	37 (101)	40 (102)	42 (102)	46 (102)	51 (103)	
	90	32	36 (101)	38 (102)	41 (102)	44 (103)	47 (104)	51 (104)	56 (105)	
$V_1 = 116$	30	-1.1	25 (98)	27 (98)	27 (98)	29 (98)	32 (99)	34 (101)	38 (101)	20
	50	10	27 (100)	29 (98)	30 (99)	32 (100)	34 (101)	38 (102)	42 (102)	
	70	21	29 (99)	31 (100)	33 (101)	36 (102)	38 (102)	42 (102)	46 (103)	
	90	32	32 (101)	34 (102)	37 (102)	40 (103)	43 (104)	46 (104)	51 (105)	

Note: Shaded area indicates conditions that do not meet second segment climb requirements.  
Refer to F.M. for takeoff limitations.

Figure 9-37. Normal takeoff runway required.

## CLIMB REQUIREMENTS

After the airplane has reached the 35-foot height with one engine inoperative, there is a requirement that it be able to climb at a specified climb gradient. This is known as the takeoff flightpath requirement. The airplane's performance must be considered based upon a one-engine inoperative climb up to 1,500 feet above the ground.

The takeoff flightpath profile with required gradients of climb for the various segments and configurations is shown in figure 9-38.

Note: Climb gradient can best be described as being a certain gain of vertical height for a given distance covered horizontally. For instance, a 2.4 percent gradient means that 24 feet of altitude would be gained for each

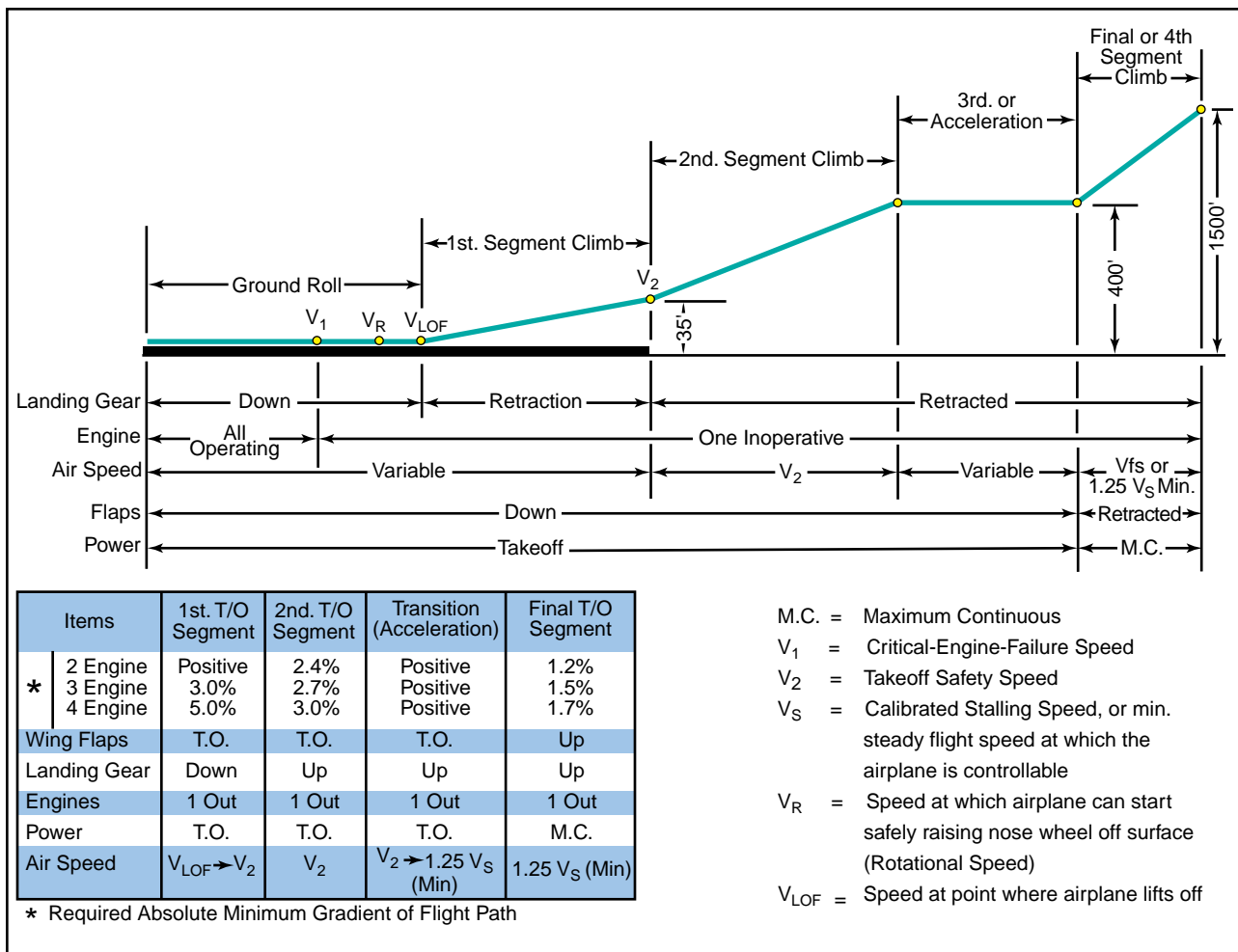

Figure 9-38. One-engine inoperative takeoff flightpath.

1,000 feet of distance covered horizontally across the ground.

The following brief explanation of the one-engine inoperative climb profile may be helpful in understanding the chart in figure 9-38.

### FIRST SEGMENT

This segment is included in the takeoff runway required charts and is measured from the point at which the airplane becomes airborne until it reaches the 35-foot height at the end of the runway distance required. Speed initially is  $V_{LO}$  and must be  $V_2$  at the 35-foot height.

### SECOND SEGMENT

This is the most critical segment of the profile. The second segment is the climb from the 35-foot height to 400 feet above the ground. The climb is done at full takeoff power on the operating engine(s), at  $V_2$  speed, and with the flaps in the takeoff configuration. The required climb gradient in this segment is 2.4 percent for two-engine airplanes, 2.7 percent for three-engine airplanes, and 3.0 percent for four-engine airplanes.

### THIRD OR ACCELERATION SEGMENT

During this segment, the airplane is considered to be maintaining the 400 feet above the ground and accelerating from the  $V_2$  speed to the  $V_{FS}$  speed before the climb profile is continued. The flaps are raised at the beginning of the acceleration segment and power is maintained at the takeoff setting as long as possible (5 minutes maximum).

### FOURTH OR FINAL SEGMENT

This segment is from the 400 to 1,500-foot AGL altitude with power set at maximum continuous. The required climb in this segment is a gradient of 1.2 percent for two-engine airplanes, 1.55 for three-engine airplanes, and 1.7 percent for four-engine airplanes.

### SECOND SEGMENT CLIMB LIMITATIONS

The second segment climb requirements, from 35 to 400 feet, are the most restrictive (or hardest to meet) of the climb segments. The pilot must determine that the second segment climb is met for each takeoff. In order to achieve this performance at the higher density altitude conditions, it may be necessary to limit the takeoff weight of the airplane.

It must be realized that, regardless of the actual available length of the takeoff runway, takeoff weight must be adjusted so that the second segment climb requirements can be met. The airplane may well be capable of lifting off with one engine inoperative, but it must then be able to climb and clear obstacles. Although second segment climb may not present much of a problem at the lower altitudes, at the higher altitude airports and higher temperatures the second segment climb chart should be consulted to determine the effects on maximum takeoff weights before figuring takeoff runway distance required.

## AIR CARRIER OBSTACLE CLEARANCE REQUIREMENTS

Regulations require that large transport category turbine powered airplanes certificated after September 30, 1958, be taken off at a weight that allows a net takeoff flightpath (one engine inoperative) that clears all obstacles either by a height of at least 35 feet vertically, or by at least 200 feet horizontally within the airport boundaries and by at least 300 feet horizontally after passing the boundaries. The takeoff flightpath is considered to begin 35 feet above the takeoff surface at the end of the takeoff distance, and extends to a point in the takeoff at which the airplane is 1,500 feet above the takeoff surface, or at which the transition from the takeoff to the enroute configuration is completed. The net takeoff flightpath is the actual takeoff flightpath reduced at each point by 0.8 percent for two-engine airplanes, 0.9 percent for three-engine airplanes, and 1.0 percent for four-engine airplanes.

Air carrier pilots therefore are responsible not only for determining that there is enough runway available for an engine inoperative takeoff (balanced field length), and the ability to meet required climb gradients; but

they must also assure that the airplane will be able to safely clear any obstacles that may be in the takeoff flightpath.

The net takeoff flightpath and obstacle clearance required are shown in figure 9-39.

The usual method of computing net takeoff flightpath performance is to add up the total ground distances required for each of the climb segments and/or use obstacle clearance performance charts in the AFM. Although this obstacle clearance requirement is seldom a limitation at the normally used airports, it is quite often an important consideration under critical conditions such as high takeoff weight and/or high-density altitude. Consider that at a 2.4 percent climb gradient (2.4 feet up for every 100 feet forward) a 1,500-foot altitude gain would take a horizontal distance of 10.4 nautical miles to achieve.

## SUMMARY OF TAKEOFF REQUIREMENTS

In order to establish the allowable takeoff weight for a transport category airplane, at any airfield, the following must be considered:

- Airfield pressure altitude
- Temperature
- Headwind component
- Runway length
- Runway gradient or slope
- Obstacles in the flightpath

Once the above details are known and applied to the appropriate performance charts, it is possible to determine the maximum allowable takeoff weight. This

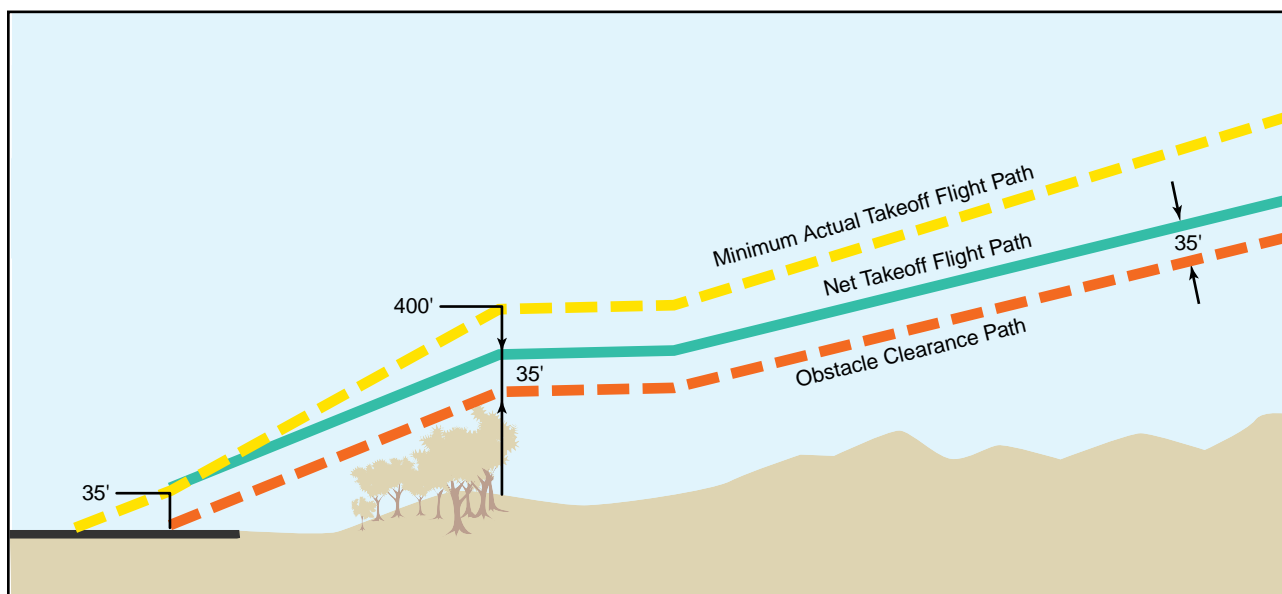

Figure 9-39. Takeoff obstacle clearance requirements.

weight would be the lower of the maximum weights as allowed by:

- Balanced field length required
- Engine inoperative climb ability (second segment limited)
- Obstacle clearance requirement

In practice, restrictions to takeoff weight at low altitude airports are usually due to runway length limitations; engine inoperative climb limitations are most common at the higher altitude airports. All limitations to weight must be observed. Since the combined weight of fuel and payload in the airplane may amount to nearly half the maximum takeoff weight, it is usually possible to reduce fuel weight to meet takeoff limitations. If this is done, however, flight planning must be recalculated in light of reduced fuel and range.

### LANDING PERFORMANCE

As in the takeoff planning, certain speeds must be considered during landing. These speeds are shown below.

#### LEVEL CONDITION

Speed	Definition
$V_{SO}$	Stalling speed or the minimum steady flight speed in the landing configuration.
$V_{REF}$	1.3 times the stalling speed in the landing configuration. This is the required speed at the 50-foot height above the threshold end of the runway.
<b>Approach Climb</b>	The approach climb speed is the speed which would give the best climb performance in the approach configuration, with one engine inoperative, and with maximum takeoff power on the operating engine(s). The required gradient of climb in this configuration is 2.1 percent for two-engine airplanes, 2.4 percent for three-engine airplanes, and 2.7 percent for four-engine airplanes.
<b>Landing Climb</b>	This speed would give the best performance in the full landing configuration with maximum takeoff power on all engines. The gradient of climb required in this configuration is 3.2 percent.

### PLANNING THE LANDING

As in the takeoff, the landing speeds shown above should be precomputed and visible to both pilots prior to the landing. The  $V_{REF}$  speed, or threshold speed, is used as a reference speed throughout the traffic pattern or instrument approach as in the following example:

- $V_{REF}$  plus 30K .....Downwind or procedure turn
- $V_{REF}$  plus 20K .....Base leg or final course inbound to final fix
- $V_{REF}$  plus 10K .....Final or final course inbound from fix (ILS final)
- $V_{REF}$  .....Speed at the 50-foot height above the threshold

### LANDING REQUIREMENTS

The maximum landing weight of an airplane can be restricted by either the approach climb requirements or by the landing runway available.

### APPROACH CLIMB REQUIREMENTS

The approach climb is usually more limiting (or more difficult to meet) than the landing climb, primarily because it is based upon the ability to execute a missed approach with one engine inoperative. The required climb gradient can be affected by pressure altitude and temperature and, as in the second segment climb in the takeoff, airplane weight must be limited as needed in order to comply with this climb requirement.

### LANDING RUNWAY REQUIRED

The runway distance needed for landing can be affected by the following:

- Pressure altitude
- Temperature
- Headwind component
- Runway gradient or slope
- Airplane weight

In computing the landing distance required, some manufacturers do not include all of the above items in their charts, since the regulations state that only pressure altitude, wind, and airplane weight must be considered. Charts are provided for anti-skid on and anti-skid off conditions, but the use of reverse thrust is not used in computing required landing distances.

The landing distance, as required by the regulations, is that distance needed to land and come to a complete stop from a point 50 feet above the threshold end of the runway. It includes the air distance required to travel from the 50-foot height to touchdown (which can consume 1,000 feet of runway distance), plus the stopping

distance, with no margin left over. This is all that is required for 14 CFR part 91 operators (non-air carrier), and all that is shown on some landing distance required charts.

For air carriers and other commercial operators subjected to 14 CFR part 121, a different set of rules applies which states that the required landing distance from the 50-foot height cannot exceed 60 percent of the actual runway length available. In all cases, the minimum airspeed allowed at the 50-foot height must be no less than 1.3 times the airplane's stalling speed in the landing configuration. This speed is commonly called the airplane's VREF speed and will vary with landing weight. Figure 9-40 is a diagram of these landing runway requirements.

**SUMMARY OF LANDING REQUIREMENTS**

In order to establish the allowable landing weight for a transport category airplane, the following details must be considered:

- Airfield pressure altitude
- Temperature
- Headwind component
- Runway length
- Runway gradient or slope
- Runway surface condition

With these details, it is possible to establish the maximum allowable landing weight, which will be the lower of the weights as dictated by:

- Landing runway requirements
- Approach climb requirements

In practice, the approach climb limitations (ability to climb in approach configuration with one engine inoperative) are seldom encountered because the landing weights upon arrival at the destination airport are usually light. However, as in the second segment climb requirement for takeoff, this approach climb gradient must be met and landing weights must be restricted if necessary. The most likely conditions that would make the approach climb critical would be the landings at high weights and high-pressure altitudes and temperatures, which might be encountered if a landing were required shortly after takeoff.

Landing field requirements can more frequently limit an airplane's allowable landing weight than the approach climb limitations. Again, however, unless the runway is particularly short, this is seldom problematic as the average landing weight at the destination seldom approaches the maximum design landing weight due to fuel burn off.

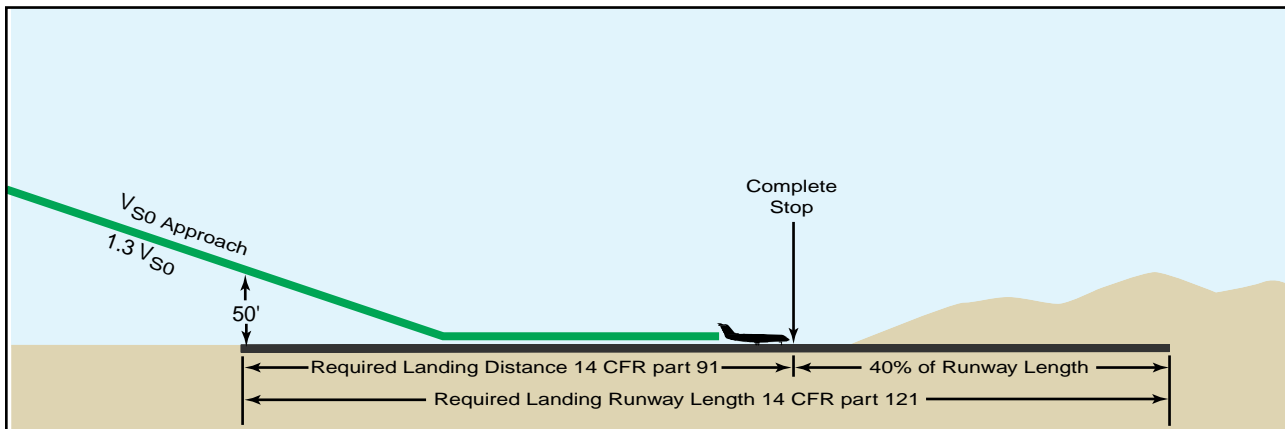

Figure 9-40. Landing runway requirements.

## **EXAMPLES OF PERFORMANCE CHARTS**

Figures 9-41 through 9-62 are examples of charts used for transport category airplanes.

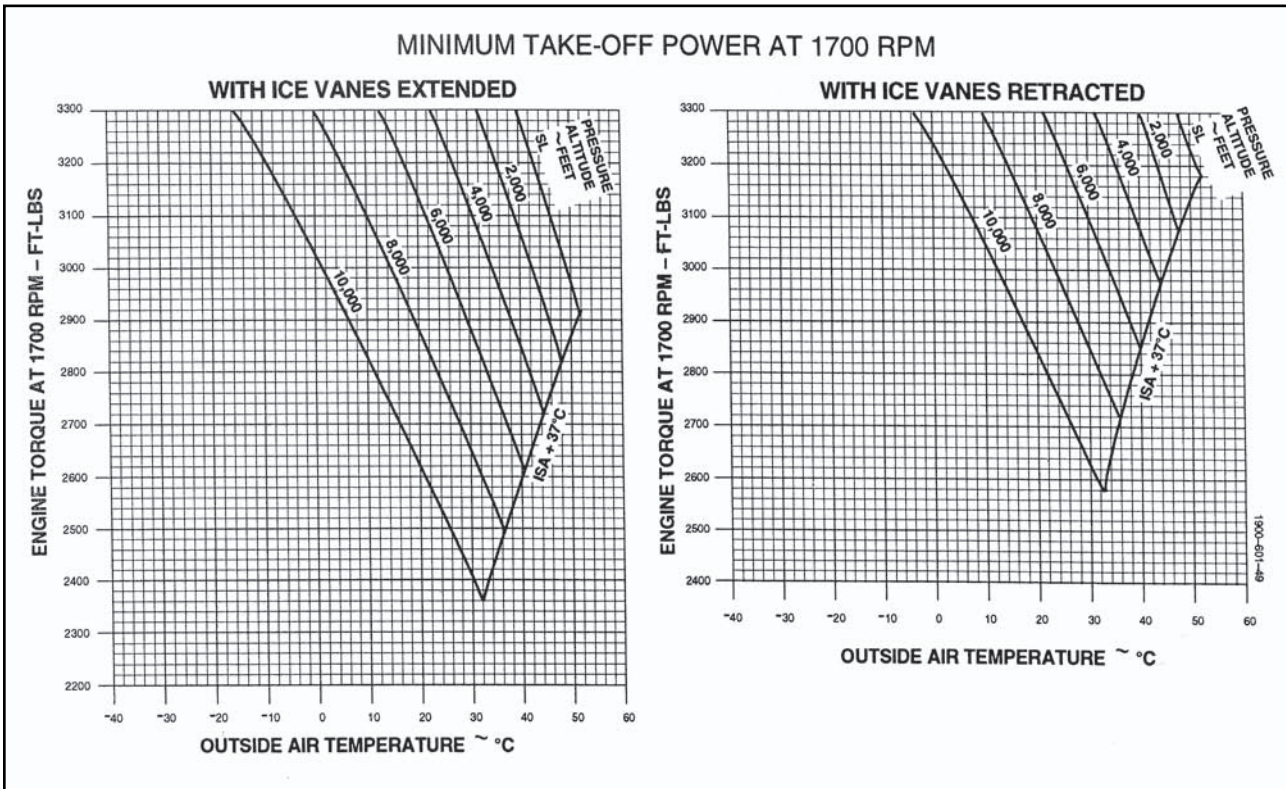

Figure 9-41. Minimum takeoff power at 1700 r.p.m.

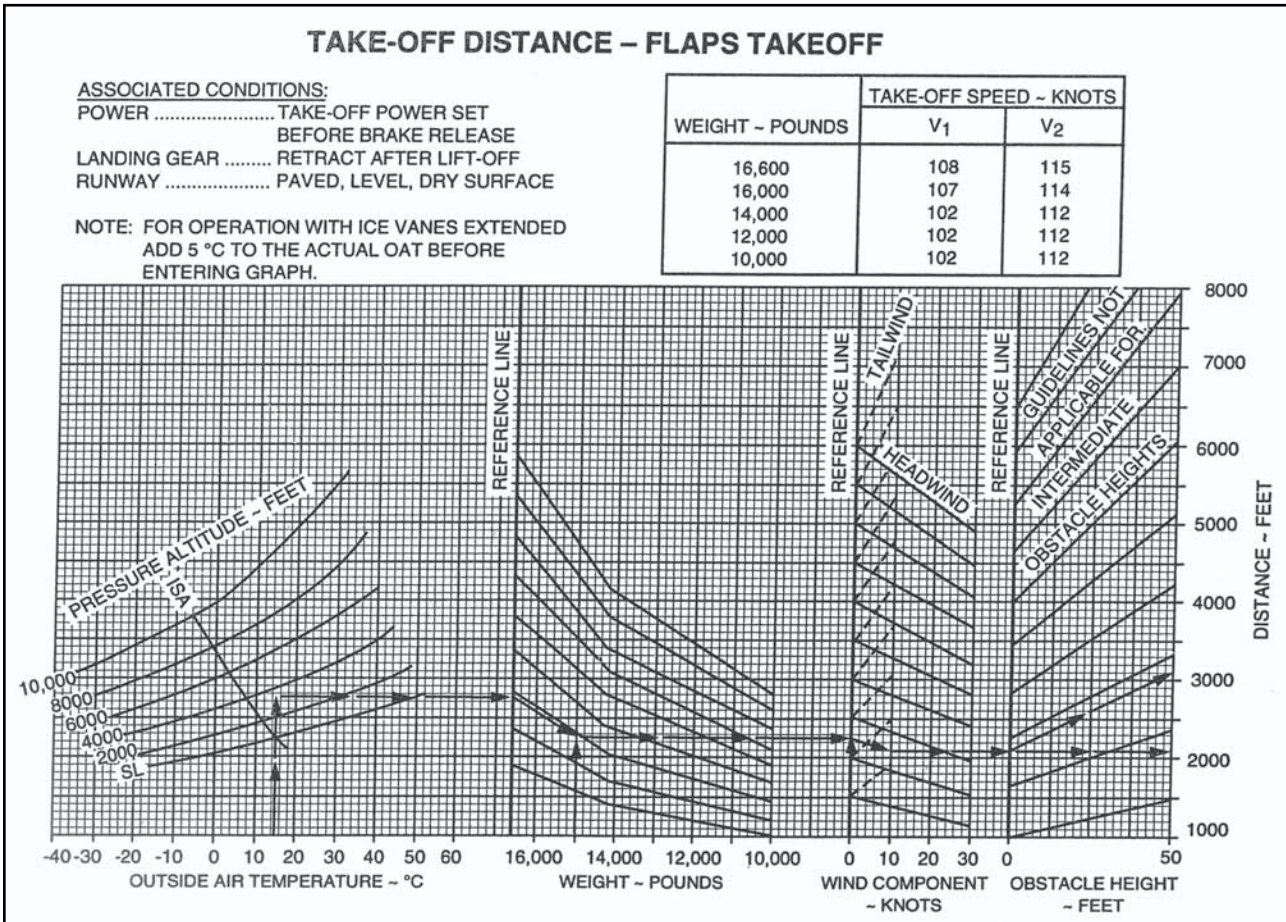

Figure 9-42. Takeoff distance—Flaps takeoff.

# ACCELERATE-STOP — FLAPS TAKEOFF

**ASSOCIATED CONDITIONS:**

- POWER ..... 1. TAKE-OFF POWER SET  
BEFORE BRAKE RELEASE
- ..... 2. BOTH ENGINES IDLE AT  $V_1$  SPEED
- AUTOFEATHER ..... ARMED
- BRAKING ..... MAXIMUM
- RUNWAY ..... PAVED, LEVEL, DRY SURFACE

WEIGHT - POUNDS	$V_1$ - KNOTS
16,600	108
16,000	107
14,000	102
12,000	102
10,000	102

NOTE: FOR OPERATION WITH ICE VANES EXTENDED,  
ADD 3 °C TO THE ACTUAL OAT BEFORE  
ENTERING GRAPH.

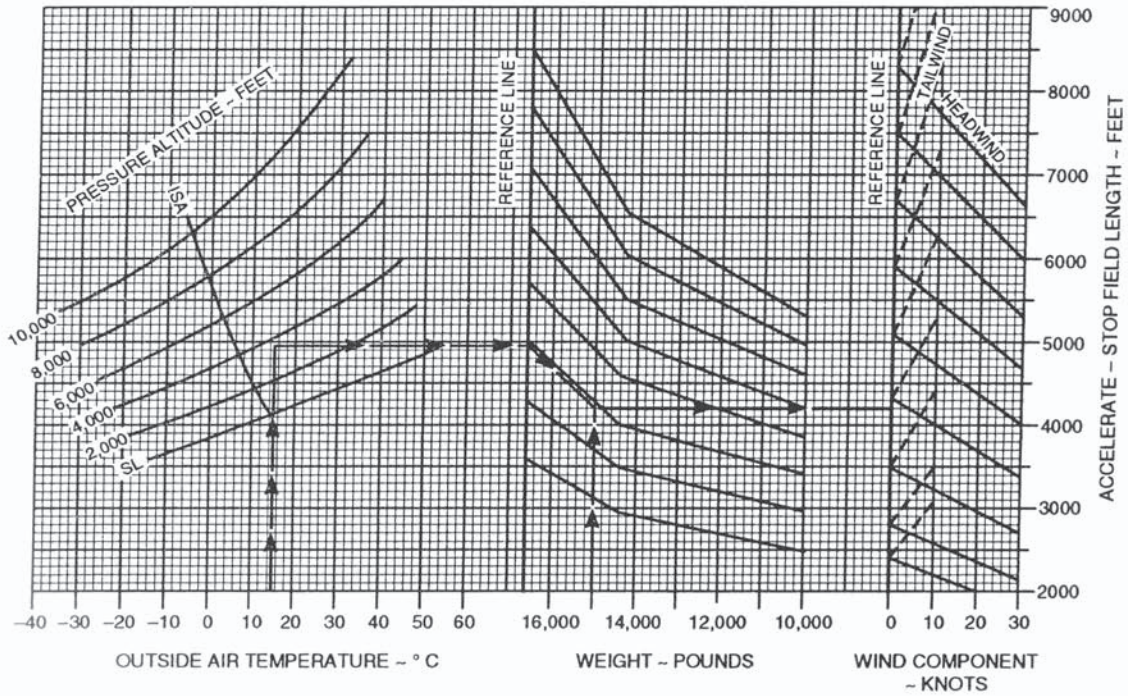

Figure 9-43. Accelerate stop—Flaps takeoff.



## CLIMB — TWO ENGINES — FLAPS UP

**ASSOCIATED CONDITIONS:**

POWER ..... MAXIMUM  
 CONTINUOUS  
 FLAPS ..... UP  
 LANDING GEAR ..... UP

WEIGHT - POUNDS	CLIMB SPEED - KNOTS
16,600	135
16,000	134
14,000	130
12,000	125
10,000	121

**EXAMPLE:**

OAT ..... -4 °C  
 PRESSURE ALTITUDE ..... 9,000 FT  
 WEIGHT ..... 14,500 LBS  
 RATE OF CLIMB ..... 2490 FT/MIN  
 CLIMB GRADIENT ..... 14.7 %  
 CLIMB SPEED ..... 131 KTS

NOTE: DURING OPERATION WITH ICE VANES EXTENDED, RATE OF CLIMB WILL BE REDUCED APPROXIMATELY 240 FEET PER MINUTE.

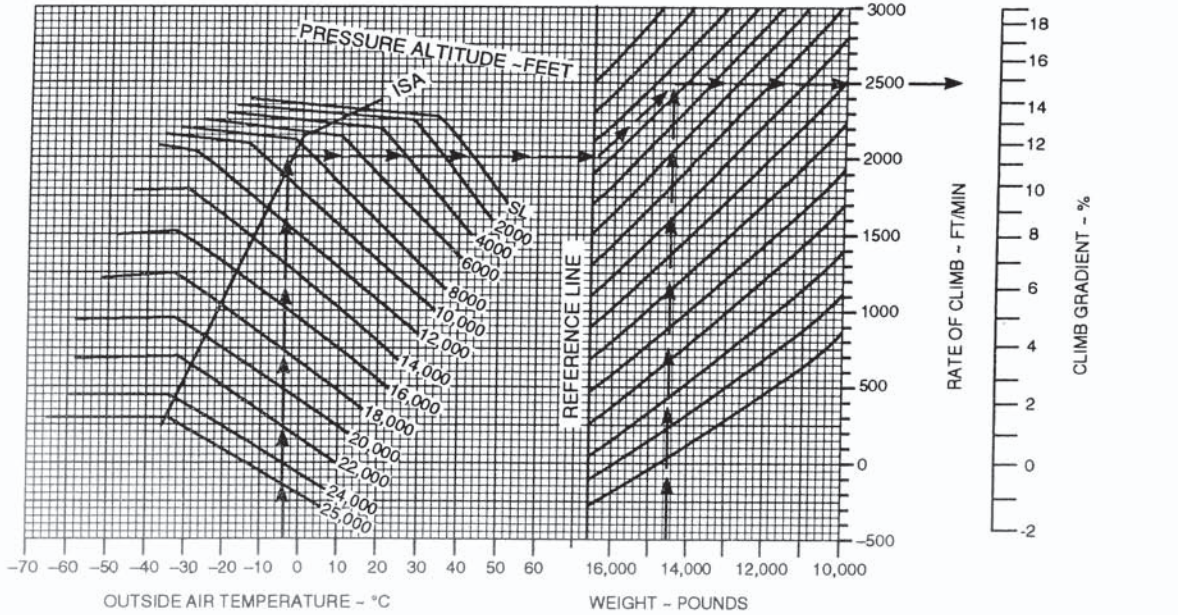

Figure 9-44. Climb – Two engines—Flaps up.

# TIME, FUEL, AND DISTANCE TO CRUISE CLIMB

**ASSOCIATED CONDITIONS:**

PROPELLER SPEED ..... 1550 RPM  
 POWER: ITT ..... 750 °C  
 OR TORQUE ..... 3400 FT-LBS

NOTES: 1. ADD 110 LBS FUEL FOR START, TAXI, AND TAKEOFF

2. FOR OPERATION WITH ICE VANES EXTENDED, ADD 10 °C TO THE ACTUAL OAT BEFORE ENTERING THE GRAPH

ALTITUDE - FEET	CLIMB SPEED - KNOTS
SL TO 10,000	160
10,000 TO 15,000	150
15,000 TO 20,000	140
20,000 TO 25,000	130

**EXAMPLE:**

OAT AT TAKEOFF ..... 15 °C  
 OAT AT CRUISE ..... -10 °C  
 AIRPORT PRESSURE ALTITUDE ..... 3499 FT  
 CRUISE ALTITUDE ..... 11,000 FT  
 INITIAL CLIMB WEIGHT ..... 15,000 LBS  
 TIME TO CLIMB (4.8-8) ..... 4 MIN  
 FUEL TO CLIMB (93-25) ..... 68 LBS  
 DISTANCE TO CLIMB (13-2) ..... 11 NM

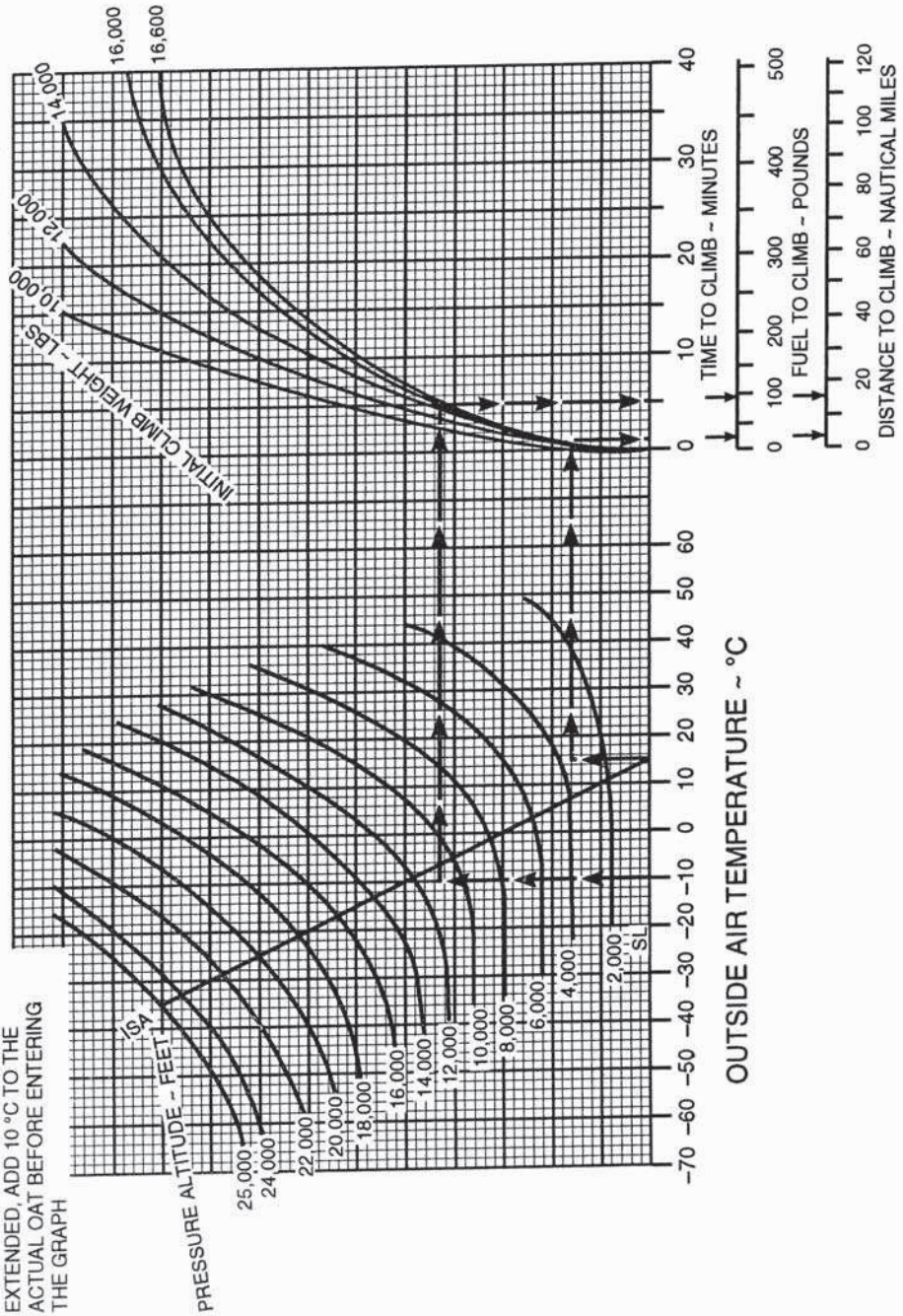

Figure 9-45. Time, fuel, and distance to cruise climb.

# CLIMB — ONE ENGINE INOPERATIVE

## BLEED AIR ON

**ASSOCIATED CONDITIONS:**

POWER ..... MAXIMUM  
 FLAPS ..... CONTINUOUS UP  
 LANDING GEAR ..... UP  
 INOPERATIVE PROPELLER ..... FEATHERED

WEIGHT ~ POUNDS	CLIMB SPEED ~ KNOTS
16,600	125
16,000	124
14,000	119
12,000	116
10,000	112

**EXAMPLE:**

OAT ..... -4 °C  
 PRESSURE ALTITUDE ..... 9,000 FT  
 WEIGHT ..... 14,500 LBS  
 RATE OF CLIMB ..... 450 FT/MIN  
 CLIMB GRADIENT ..... 3.1 %  
 CLIMB SPEED ..... 120 KTS

NOTES: DURING OPERATION WITH ICE VANES EXTENDED, RATE OF CLIMB WILL BE REDUCED APPROXIMATELY 115 FEET PER MINUTE.

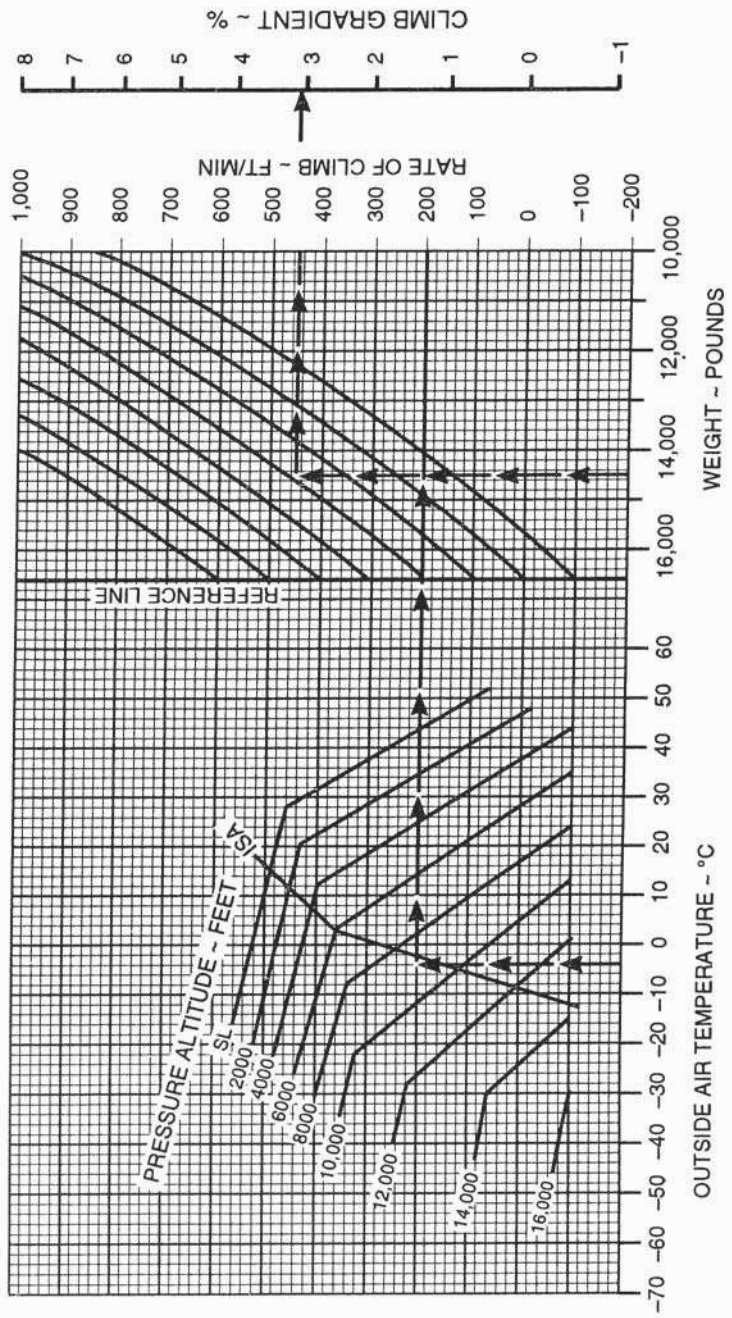

Figure 9-46. Climb—One engine inoperative.

# SERVICE CEILING — ONE ENGINE INOPERATIVE

**BLEED AIR ON**

**BLEED AIR OFF**

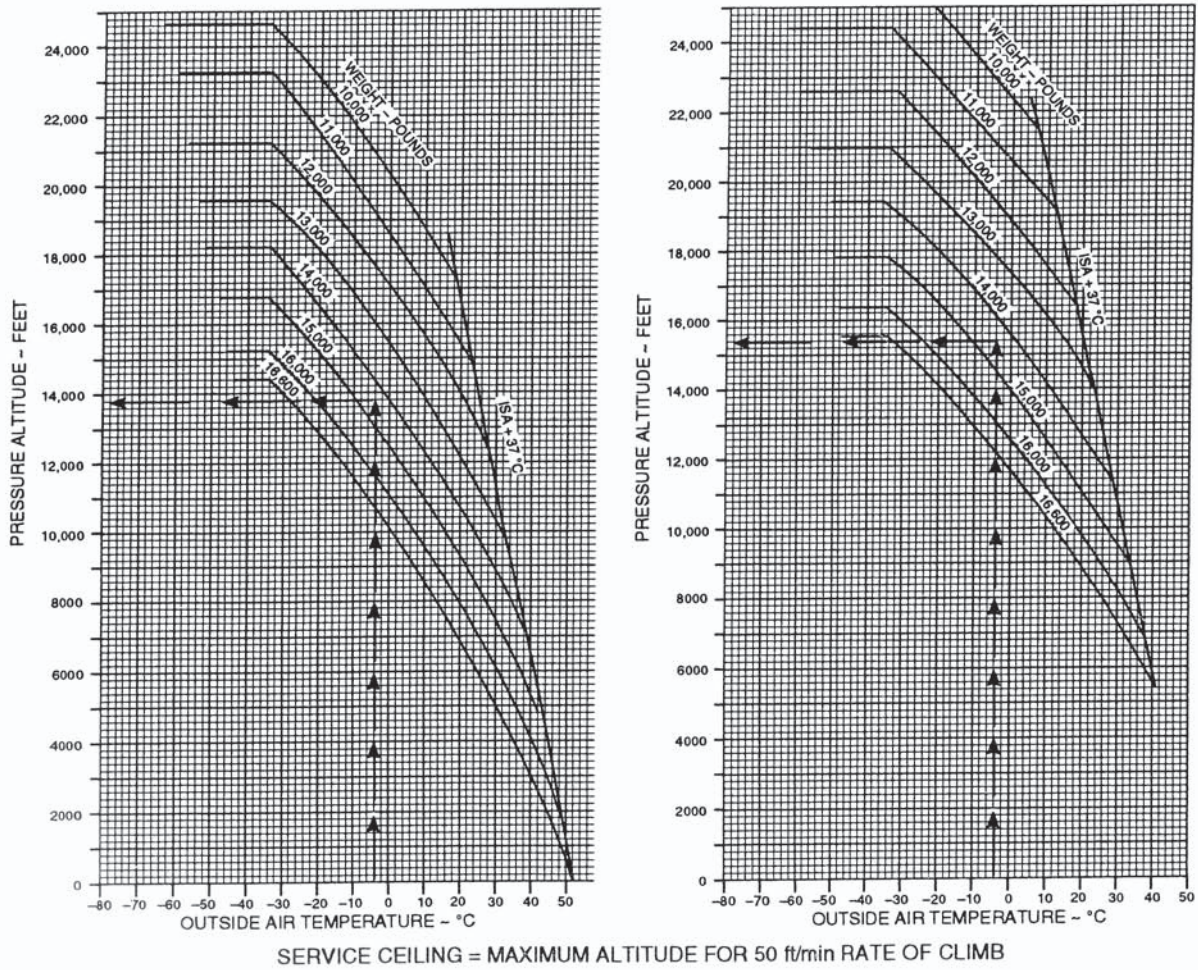

Figure 9-47. Service ceiling—One engine inoperative.

## RECOMMENDED CRUISE POWER

**1550 RPM**

**ISA +10 °C**

WEIGHT			16,000 POUNDS					14,000 POUNDS					12,000 POUNDS					10,000 POUNDS				
PRESSURE ALTITUDE	IOAT	OAT	TORQUE PER ENG	FUEL FLOW PER ENG	TOTAL FUEL FLOW	IAS	TAS	TORQUE PER ENG	FUEL FLOW PER ENG	TOTAL FUEL FLOW	IAS	TAS	TORQUE PER ENG	FUEL FLOW PER ENG	TOTAL FUEL FLOW	IAS	TAS	TORQUE PER ENG	FUEL FLOW PER ENG	TOTAL FUEL FLOW	IAS	TAS
FEET	°C	°C	FT-LBS	LBS/HR	LBS/HR	KTS	KTS	FT-LBS	LBS/HR	LBS/HR	KTS	KTS	FT-LBS	LBS/HR	LBS/HR	KTS	KTS	FT-LBS	LBS/HR	LBS/HR	KTS	KTS
SL	30	25	3294	577	1154	232	239	3301	577	1154	235	241	3307	577	1154	237	243	3312	577	1154	238	245
2000	26	21	3191	551	1102	227	240	3198	551	1102	230	243	3204	552	1104	232	245	3209	552	1104	233	247
4000	22	17	3092	527	1054	222	242	3100	528	1056	224	244	3106	528	1056	227	247	3111	528	1056	228	249
6000	19	13	2992	504	1008	216	243	3000	505	1010	219	246	3006	505	1010	222	249	3012	505	1010	224	251
8000	15	9	2886	481	962	211	244	2896	482	964	214	247	2903	482	964	216	250	2909	482	964	219	253
10,000	11	5	2778	458	916	205	244	2789	458	916	208	248	2797	459	918	211	252	2804	459	918	213	254
12,000	7	1	2636	432	864	198	243	2648	433	866	202	248	2657	433	866	205	252	2664	434	868	207	255
14,000	3	-3	2495	408	816	190	241	2508	409	818	195	247	2518	409	818	198	251	2525	409	818	201	255
16,000	-1	-7	2352	384	768	182	239	2367	385	770	188	246	2378	385	770	192	251	2386	386	772	195	255
18,000	-6	-11	2208	361	722	174	235	2226	362	724	180	243	2239	363	726	185	250	2248	363	726	188	254
20,000	-10	-15	2063	338	676	164	229	2085	340	680	172	240	2100	341	682	177	248	2111	341	682	181	253
22,000	-14	-19	1911	316	632	153	221	1939	317	634	163	235	1957	319	638	169	245	1969	319	638	174	252
24,000	-19	-23	1749	292	584	137	206	1790	295	590	152	229	1812	297	594	161	241	1827	298	596	167	249
25,000	-21	-25	1649	279	558	122	187	1714	284	568	147	224	1739	286	572	156	238	1756	287	574	163	248

Figure 9-48. Recommended cruise power—ISA +10° C

# TIME, FUEL, AND DISTANCE TO DESCEND AT 200 KNOTS

**ASSOCIATED CONDITIONS:**

POWER ..... AS REQUIRED TO  
DESCEND AT  
1500 FT/MIN  
LANDING GEAR ..... UP  
FLAPS ..... UP

**EXAMPLE**

INITIAL ALTITUDE ..... 11,000 FT  
FINAL ALTITUDE ..... 5,998 FT  
TIME TO DESCEND (7.4-4.1) ..... 3.3 MIN  
FUEL TO DESCEND (74-41) ..... 33 LBS  
DISTANCE TO DESCEND (26-13) ..... 13 NM

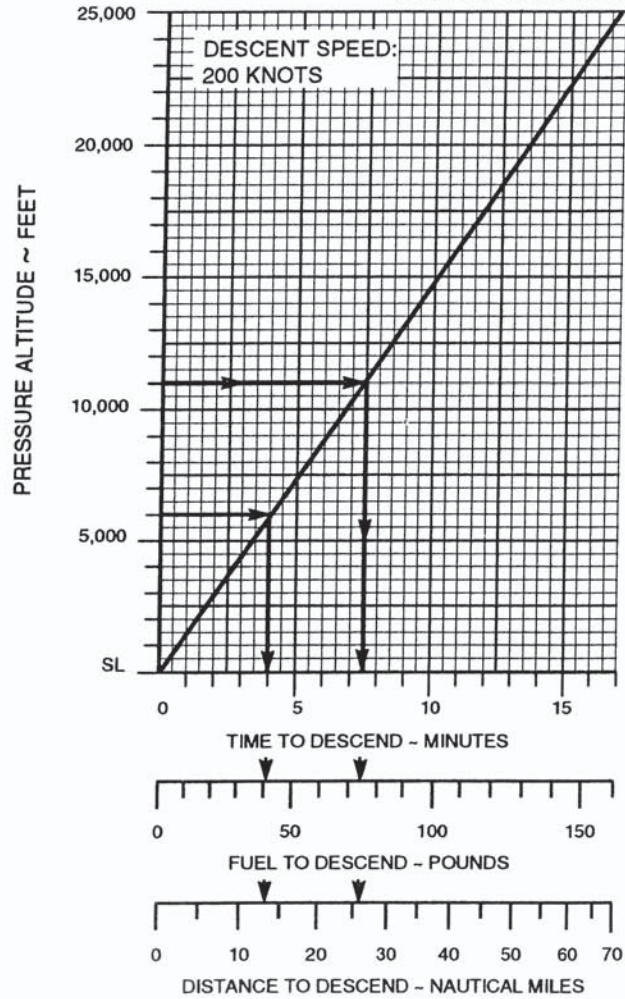

Figure 9-49. Time, fuel, and distance to descend.

# NORMAL LANDING DISTANCE — FLAPS LANDING ANTI-SKID ON

**EXAMPLE:**

OAT ..... 25 °C  
 PRESSURE ALTITUDE ..... 5998 FT  
 LANDING WEIGHT ..... 14,182 LBS  
 HEADWIND COMPONENT ..... 10 KTS  
 GROUND ROLL ..... 1150 FT  
 TOTAL OVER 50-FT OBSTACLE ..... 2195 FT  
 APPROACH SPEED ..... 108 KTS

WEIGHT - POUNDS	APPROACH SPEED - KNOTS
16,100	113
14,000	107
12,000	101
10,000	93

**ASSOCIATED CONDITIONS:**  
 POWER ..... RETARD TO MAINTAIN 800 FT/MIN ON FINAL APPROACH  
 RUNWAY ..... PAVED, LEVEL, DRY SURFACE  
 APPROACH SPEED ..... IAS AS TABULATED  
 BRAKING ..... MAXIMUM

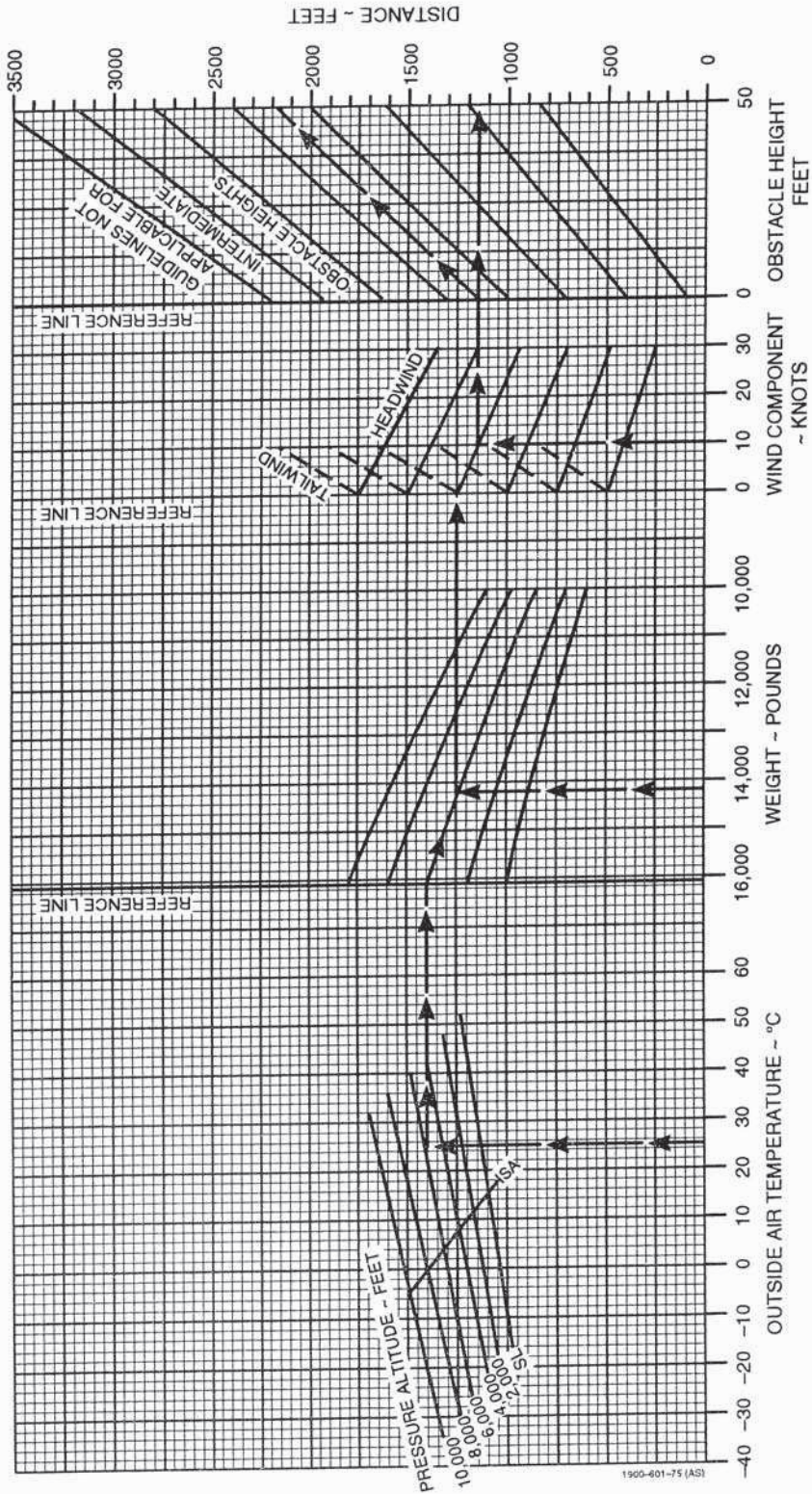

1965-601-75 (AS)

Figure 9-50. Normal landing distance—Flaps landing.

**MODEL DC-9  
TAKEOFF SPEEDS  
JT8D-1 ENGINES**

<b>TAKEOFF SPEED - 20° FLAPS</b>								
EITHER NO ICE PROTECTION OR ENGINE ICE PROTECTION ONLY								
TAKEOFF WEIGHT (1000 LB)	60	65	70	75	80	85	90	95
$V_1$ (KNOTS, IAS)	104.0	110.0	115.0	120.5	125.0	129.5	133.5	136.0
$V_R$ (KNOTS, IAS)	106.5	112.5	118.0	123.5	129.0	134.0	139.0	143.5
$V_2$ (KNOTS, IAS)	117.0	121.5	126.5	130.5	135.0	139.0	143.0	147.0

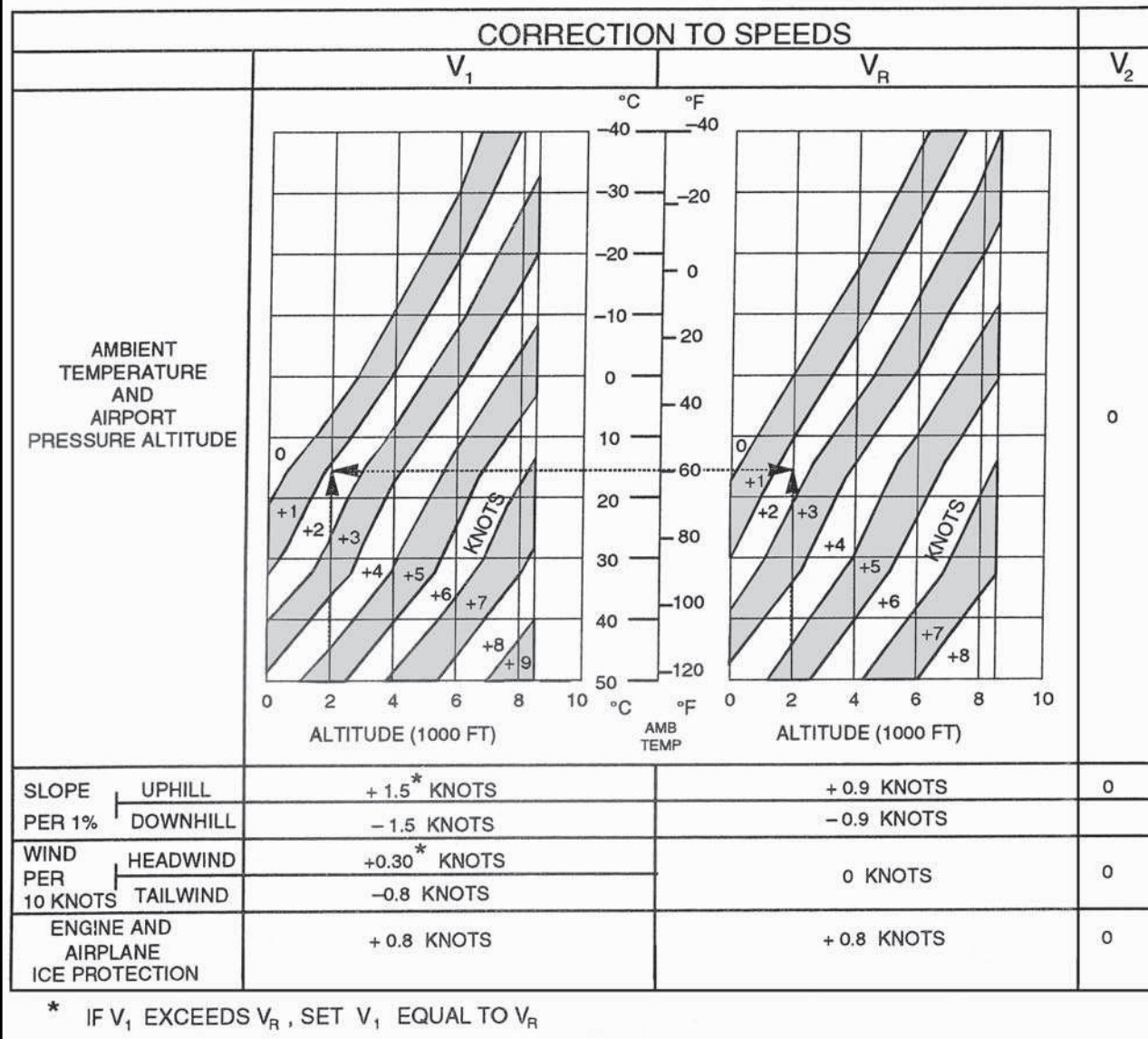

Figure 9-51. DC-9—Takeoff speeds.



**TIME, FUEL, AND DISTANCE TO CLIMB  
JT8D-1 ENGINES - NORMAL BLEED  
DC-9 SERIES 10 - LONG RANGE CLIMB SCHEDULE  
CLIMB AT 290 KNOTS IAS TO 26860 FT ALTITUDE THEN CLIMB AT M .72**

INITIAL WEIGHT = 78000. POUNDS				INITIAL WEIGHT = 82000. POUNDS			
PRES. ALT. FEET	TIME MIN.	FUEL BURNED LB.	DIST. N. MI.	PRES. ALT. FEET	TIME MIN.	FUEL BURNED LB.	DIST. N. MI.
0.	0.	0.	0.	0.	0.	0.	0.
2000.	0.5	113.	2.2	2000.	0.5	120.	2.4
4000.	0.9	227.	4.6	4000.	1.0	241.	4.9
6000.	1.5	342.	7.3	6000.	1.5	363.	7.7
8000.	2.0	457.	10.2	8000.	2.1	486.	10.8
10000.	2.6	574.	13.3	10000.	2.7	610.	14.2
12000.	3.2	693.	16.8	12000.	3.4	737.	17.9
14000.	3.9	815.	20.7	14000.	4.1	868.	22.1
16000.	4.6	941.	25.0	16000.	4.9	1002.	26.7
18000.	5.4	1070.	29.9	18000.	5.7	1141.	31.9
20000.	6.3	1205.	35.4	20000.	6.7	1286.	37.9
22000.	7.2	1347.	41.7	22000.	7.7	1439.	44.6
24000.	8.3	1498.	49.0	24000.	8.9	1602.	52.5
26000.	9.5	1661.	57.6	26000.	10.2	1780.	61.9
26860.	10.1	1736.	61.8	26860.	10.9	1863.	66.5
26860.	10.1	1736.	61.8	26860.	10.9	1863.	66.5
28000.	10.7	1813.	66.2	28000.	11.6	1948.	71.4
30000.	11.9	1953.	74.6	30000.	12.9	2104.	80.8
32000.	13.3	2102.	84.2	32000.	14.4	2274.	91.7
34000.	14.9	2267.	95.4	34000.	16.3	2464.	104.6
36000.	16.9	2456.	109.2	36000.	18.7	2693.	121.3

INITIAL WEIGHT = 80000. POUNDS				INITIAL WEIGHT = 84000. POUNDS			
PRES. ALT. FEET	TIME MIN.	FUEL BURNED LB.	DIST. N. MI.	PRES. ALT. FEET	TIME MIN.	FUEL BURNED LB.	DIST. N. MI.
0.	0.	0.	0.	0.	0.	0.	0.
2000.	0.5	117.	2.3	2000.	0.5	124.	2.4
4000.	1.0	234.	4.8	4000.	1.0	248.	5.1
6000.	1.5	352.	7.5	6000.	1.6	374.	8.0
8000.	2.1	471.	10.5	8000.	2.2	500.	11.1
10000.	2.7	592.	13.7	10000.	2.8	629.	14.6
12000.	3.3	715.	17.4	12000.	3.5	760.	18.5
14000.	4.0	841.	21.4	14000.	4.2	894.	22.8
16000.	4.7	971.	25.9	16000.	5.1	1033.	27.6
18000.	5.6	1105.	30.9	18000.	5.9	1177.	33.0
20000.	6.5	1245.	36.6	20000.	6.9	1327.	39.1
22000.	7.5	1392.	43.2	22000.	8.0	1486.	46.2
24000.	8.6	1549.	50.7	24000.	9.2	1656.	54.4
26000.	9.9	1719.	59.7	26000.	10.6	1841.	64.1
26860.	10.5	1798.	64.1	26860.	11.3	1928.	69.0
26860.	10.5	1798.	64.1	26860.	11.3	1928.	69.0
28000.	11.1	1879.	68.7	28000.	12.0	2018.	74.1
30000.	12.4	2027.	77.7	30000.	13.4	2183.	84.1
32000.	13.8	2186.	87.8	32000.	15.0	2364.	95.7
34000.	15.6	2362.	99.8	34000.	17.1	2570.	109.7
36000.	17.7	2570.	114.9	36000.	19.7	2826.	128.3

Figure 9-52. Long range climb schedule.

### ALTERNATE PLANNING CHART

DIST. - NAM	20	30	40	50	60	70	80	90	100	110	120	130	140
OPTM. ALT.	2000	3000	4000	5000	6000	7000	8000	9000	10000	11000	12000	13000	14000
TIME:	:16	:17	:19	:20	:22	:23	:25	:26	:28	:29	:30	:32	:33
FUEL	2500	2600	2700	2800	2900	3000	3100	3200	3300	3400	3500	3600	3700
TAS	275	280	283	286	289	292	296	300	303	306	309	312	315
DIST. NAM	150	160	170	180	190	200	210	220	230	240	250	260	270
OPTM. ALT.	15000	16000	17000	18000	19000	20000	21000	22000	23000	24000	25000	26000	27000
TIME:	:35	:36	:38	:39	:40	:42	:43	:45	:46	:48	:49	:50	:52
FUEL	3800	3900	4000	4100	4200	4300	4400	4500	4600	4700	4800	4900	5000
TAS	319	323	326	330	334	338	341	345	349	353	357	361	365
DIST. - NAM	280	290	300	310	320	330	340	350	360	370	380	390	400
OPTM. ALT.	27000	28000	28000	29000	29000	30000	30000	31000	31000	31000	31000	31000	31000
TIME:	:53	:55	:56	:58	:59	1:00	1:02	1:03	1:04	1:05	1:07	1:08	1:10
FUEL	5150	5250	5350	5450	5600	5700	5800	5900	6050	6150	6250	6350	6500
TAS	368	372	376	380	385	388	392	397	397	397	397	397	397

**NOTES:**

1. Fuel includes 1/2 climb distance en route credit, fuel to cruise remaining distance at LRC schedule, 15 minutes holding at alternate, and 800 lbs. for descent.
2. Time includes 1/2 climb distance credit, time to cruise distance shown at LRC schedule and 8 minutes for descent. 15 minutes holding is not included in time.

Figure 9-53. Alternate planning chart.

0 TO 60 KTS																							
TAKEOFF EPR																							
A/C ON																							
<table border="1"> <tr> <td>EPR BLEED CORRECTIONS</td> <td>▲ EPR</td> </tr> <tr> <td>AIR CONDITIONING OFF</td> <td>+0.03</td> </tr> <tr> <td>ENGINE ANTI-ICE</td> <td>ZERO</td> </tr> </table>																		EPR BLEED CORRECTIONS	▲ EPR	AIR CONDITIONING OFF	+0.03	ENGINE ANTI-ICE	ZERO
EPR BLEED CORRECTIONS	▲ EPR																						
AIR CONDITIONING OFF	+0.03																						
ENGINE ANTI-ICE	ZERO																						
OAT	°F	-65	-49	-40	-31	-22	-13	-4	5	14	23	32	41	50	59	68	77	86	95	104	120		
	°C	-54	-45	-40	-35	-30	-25	-20	-15	-10	-5	0	5	10	15	20	25	30	35	40	49		
TEMP		2.31	2.31	2.31	2.29	2.27	2.24	2.22	2.19	2.17	2.14	2.11	2.07	2.04	2.01	2.01	2.01	2.00	1.95	1.91	1.82		
LIMIT EPR		← 2.31		← 2.22		← 2.16		← 2.11		← 2.06		← 2.01		← 1.96									
PRESS		ALT 5660 AND ABOVE		4000		3000		2000		1000		S.L.		-1000									
<p>① FIND TEMP LIMIT EPR</p> <p>② FIND PRESS LIMIT EPR</p> <p>③ USE THE SMALLER OF THE TWO LIMITS</p>																							

V <sub>1</sub> , V <sub>R</sub> , V <sub>2</sub>	PRESSURE ALTITUDE 1000 FT	OAT							
		ANTI-SKID ON		F <sup>2</sup> C <sup>2</sup>		F <sup>2</sup> C <sup>2</sup>		F <sup>2</sup> C <sup>2</sup>	
9 to 10	→					-65 to -19 -54 to -28	-18 to 18 -27 to -8	19 to 45 -7 to 7	46 to 86 8 to 30
7 to 9	→					-65 to -21 -54 to -29	-20 to 10 -28 to -23	11 to 39 -22 to 4	40 to 87 5 to 31
5 to 7	→					-65 to -15 -54 to -26	-14 to 15 -27 to -9	16 to 40 -8 to 4	41 to 87 5 to 31
3 to 5	→					-65 to 20 -54 to -8	21 to 42 -7 to 6	43 to 88 7 to 31	89 to 103 32 to 39
1 to 3	→					-65 to 46 -54 to 8	47 to 89 9 to 32	90 to 104 33 to 40	105 to 120 41 to 49
-1 to 1	→					-65 to 91 -54 to 33	92 to 105 34 to 40	106 to 120 41 to 49	

### FLAP RETRACTION/ MANEUVERING SPEED

FLAP POS	KTS IAS
0	210
1	190
2	180
5	170
10	160
15	150
25	140

FOR MANEUVERS IMMEDIATELY AFTER TAKE-OFF EXCEEDING 15° BANK, MAINTAIN AT LEAST V<sub>2</sub> + 15 AT TAKEOFF FLAPS

STAB, TRIM SETTING -UNITS AIRPLANE NOSE UP

CG	FLAPS ALL
6	8
8	7-3/4
10	7-1/2
12	7
14	6-3/4
16	6-1/4
18	5-3/4
20	5-1/2
22	5
24	4-1/2
26	4
28	3-1/2
30	3
32	2-1/2

FLAPS	GROSS WT -1000 LB	V <sub>1</sub>	V <sub>R</sub>	V <sub>2</sub>	V <sub>1</sub>	V <sub>R</sub>	V <sub>2</sub>	V <sub>1</sub>	V <sub>R</sub>	V <sub>2</sub>	V <sub>1</sub>	V <sub>R</sub>	V <sub>2</sub>	V <sub>1</sub>	V <sub>R</sub>	V <sub>2</sub>
1	120	159	161	164	160	162	164									
	110	150	152	155	151	153	155									
	100	141	143	147	142	143	147									
	90	131	133	138	132	134	138									
	80	122	124	130	122	125	130									
5	70	112	116	123	113	117	122									
5	120	153	155	158	154	156	158									
	110	144	146	150	145	147	150									
	100	135	137	142	136	138	142									
	90	126	128	133	127	129	133									
	80	116	118	125	117	119	125									
15	70	106	109	118	107	110	118									
15	100	130	130	135	131	131	135									
	90	120	121	128	121	122	128									
	80	111	112	119	112	113	119									
	70	105	105	112	101	103	112									
25	100	124	126	132	126	127	132									
	90	115	117	124	116	118	124									
	80	105	108	116	107	109	116									
	70	105	105	108	104	104	108									

SHADED AREA INDICATES PERFORMANCE AFFECTED BY MINIMUM CONTROL SPEED, MINIMUM FIELD LENGTH FOR LIGHTEST WEIGHT ABOVE SHADED AREA IS REQUIRED.

SPEEDS NOT VALID WHEN WEIGHTS ARE PREDICTED ON USE OF CLEARWAY, STOPWAY, IMPROVED CLIMB OR ARE LIMITED BY BRAKE ENERGY

V <sub>1</sub> ADJUSTMENTS*	
WIND	SLOPE
ADD 1 KT PER 20 KTS HEADWIND	ADD 1 KT PER 1% UP SLOPE
SUBTRACT 1 KT PER 5 KTS TAILWIND	SUBTRACT 1 KT PER 1% DOWN SLOPE

\*V<sub>1</sub> MUST NOT EXCEED V<sub>R</sub>

Figure 9-54. B-737—Takeoff performance.

## EN ROUTE CLIMB 280/.70 ISA +10 °C

PRESSURE ALTITUDE -FT	UNITS MIN/LB NM/KNOTS	BRAKE RELEASE WEIGHT - LB										
		120000	115000	110000	105000	100000	95000	90000	85000	80000	75000	65000
37000	TIME/FUEL DIST./TAS			42/5700 263/395	34/4700 206/391	29/4100 174/389	25/3700 151/388	23/3300 133/386	20/3000 119/385	18/2700 107/384	16/2500 96/384	13/2100 78/382
36000	TIME/FUEL DIST./TAS		43/5900 266/394	35/5000 211/391	30/4400 179/389	26/3900 156/387	23/3500 138/385	21/3200 123/384	19/2900 111/383	17/2700 100/383	16/2400 90/382	13/2000 74/381
35000	TIME/FUEL DIST./TAS	45/6200 275/394	36/5300 219/390	31/4600 186/388	27/4100 162/386	24/3700 143/385	22/3400 128/384	20/3100 115/383	18/2800 104/382	16/2600 94/381	15/2400 85/380	12/2000 70/379
34000	TIME/FUEL DIST./TAS	38/5600 228/390	32/4900 193/387	28/4400 168/386	25/3900 149/384	23/3600 133/383	21/3300 120/382	19/3000 108/381	17/2700 98/380	16/2500 89/379	14/2300 81/379	12/1900 67/378
33000	TIME/FUEL DIST./TAS	34/5100 200/387	30/4600 174/385	26/4100 154/383	24/3800 138/382	22/3400 124/381	20/3100 113/380	18/2900 102/379	16/2600 93/378	15/2400 85/378	14/2200 77/377	11/1900 64/376
32000	TIME/FUEL DIST./TAS	31/4800 180/384	28/4400 160/382	25/4000 143/381	23/3600 129/379	21/3300 116/378	19/3000 106/378	17/2800 96/377	16/2600 88/376	14/2400 80/376	13/2200 73/375	11/1800 61/374
31000	TIME/FUEL DIST./TAS	29/4600 165/381	26/4200 147/379	23/3800 133/378	21/3500 120/377	20/3200 109/376	18/2900 100/375	16/2700 91/375	15/2500 83/374	14/2300 76/374	13/2100 70/373	11/1800 58/372
30000	TIME/FUEL DIST./TAS	27/4400 152/378	24/4000 137/376	22/3700 124/375	20/3400 113/374	19/3100 103/374	17/2900 94/373	16/2600 86/372	14/2400 79/372	13/2200 72/371	12/2100 66/371	10/1700 55/370
29000	TIME/FUEL DIST./TAS	25/4200 141/375	23/3800 128/374	21/3500 116/373	19/3200 106/372	18/3000 97/371	16/2800 89/370	15/2600 82/370	14/2400 75/369	13/2200 69/369	12/2000 63/369	10/1700 52/368
28000	TIME/FUEL DIST./TAS	24/4000 131/371	22/3700 119/370	20/3400 109/369	18/3100 100/369	17/2900 91/368	16/2700 84/368	14/2500 77/367	13/2300 71/367	12/2100 65/366	11/1900 60/366	9/1600 50/365
27000	TIME/FUEL DIST./TAS	22/3800 121/368	21/3500 111/367	19/3300 102/366	18/3000 93/366	16/2800 86/365	15/2600 79/364	14/2400 73/364	13/2200 67/364	12/2000 61/363	11/1900 56/363	9/1600 47/363
26000	TIME/FUEL DIST./TAS	21/3600 110/363	19/3400 101/362	18/3100 93/362	16/2900 86/361	15/2700 79/361	14/2500 73/360	13/2300 67/360	12/2100 62/360	11/2000 57/359	10/1800 52/359	9/1500 44/359
25000	TIME/FUEL DIST./TAS	19/3400 101/358	18/3200 93/358	17/3000 85/357	15/2800 79/357	14/2600 73/357	13/2400 67/356	12/2200 62/356	11/2000 57/356	10/1900 53/356	10/1700 48/355	8/1500 41/355
24000	TIME/FUEL DIST./TAS	18/3300 92/354	17/3000 85/354	16/2800 78/353	15/2600 72/353	13/2400 67/353	12/2300 62/352	12/2100 57/352	11/1900 53/352	10/1800 49/352	9/1700 45/352	8/1400 38/351
23000	TIME/FUEL DIST./TAS	17/3100 84/350	16/2900 78/350	15/2900 72/350	14/2500 67/349	13/2300 62/349	12/2200 57/349	11/2000 53/349	10/1900 49/348	9/1700 45/348	9/1600 42/348	7/1300 35/348
22000	TIME/FUEL DIST./TAS	16/3000 77/346	15/2800 71/346	14/2600 66/346	13/2400 61/346	12/2200 57/345	11/2100 53/345	10/1900 49/345	10/1800 45/345	9/1700 42/345	8/1500 38/345	7/1300 32/344
6000	TIME/FUEL DIST./TAS	5/1100 10/301	4/1000 10/301	4/900 9/301	4/900 9/301	4/800 8/301	3/800 8/301	3/700 7/301	3/700 7/301	3/600 6/301	3/600 6/301	2/500 5/301
1500	TIME/FUEL	3/600	2/600	2/500	2/500	2/500	2/500	2/400	2/400	2/400	1/300	1/300
FUEL ADJUSTMENT FOR HIGH ELEVATION AIRPORTS						AIRPORT ELEVATION	2000	4000	6000	8000	10000	12000
EFFECT ON TIME AND DISTANCE IS NEGLIGIBLE						FUEL ADJUSTMENT	-100	-300	-400	-500	-600	-800

Figure 9-55. En route climb 280/.70 ISA.

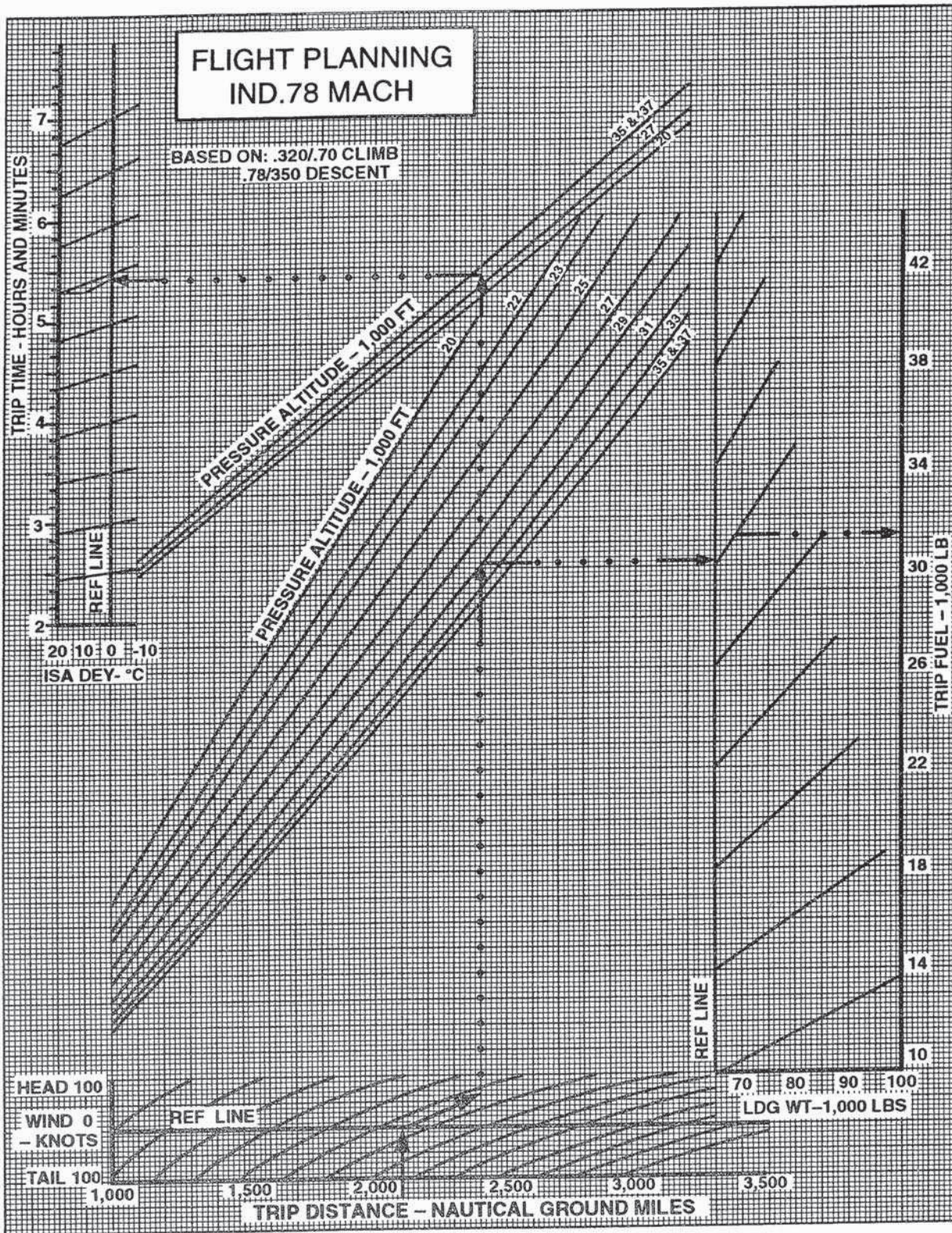

Figure 9-56. B-737—Flight planning .78 mach indicated.

# 1 ENGINE INOP

**ENGINE A/I OFF**

GROSS WEIGHT 1000 LB		OPTIMUM DRIFTDOWN SPEED KIAS	ISA DEV °C			
AT ENGINE FAILURE	AT LEVEL OFF (APPROX)		-10	0	10	20
			APPROX GROSS LEVEL OFF PRESS ALT FT			
80	77	184	27900	26800	25400	22800
90	86	195	25000	23800	21700	20000
100	96	206	22000	20500	20000	18500
110	105	216	20000	19100	17500	15400
120	114	224	18200	16600	14700	12200

**ENGINE A/I ON**

GROSS WEIGHT 1000 LB		OPTIMUM DRIFTDOWN SPEED KIAS	ISA DEV °C			
AT ENGINE FAILURE	AT LEVEL OFF (APPROX)		-10	0	10	20
			APPROX GROSS LEVEL OFF PRESS ALT FT			
80	77	184	25500	24600	22800	20000
90	86	195	23000	21400	20000	19400
100	96	206	20000	19400	18700	15600
110	105	216	18100	16600	14700	12200
120	114	224	15500	13800	11800	8800

**ENGINE AND WING A/I ON**

GROSS WEIGHT 1000 LB		OPTIMUM DRIFTDOWN SPEED KIAS	ISA DEV °C			
AT ENGINE FAILURE	AT LEVEL OFF (APPROX)		-10	0	10	20
			APPROX GROSS LEVEL OFF PRESS ALT FT			
80	77	184	24400	23400	21400	20000
90	86	195	21600	20100	19800	18000
100	96	206	19600	18000	16400	14200
110	105	216	16800	15100	13300	10700
120	114	224	14000	12200	10300	7200

**NOTE:**

WHEN ENGINE BLEED FOR AIR CONDITIONING IS OFF BELOW 17,000 FT., INCREASE LEVEL-OFF ALTITUDE BY 800 FT.

Figure 9-57. Drift-down performance chart.

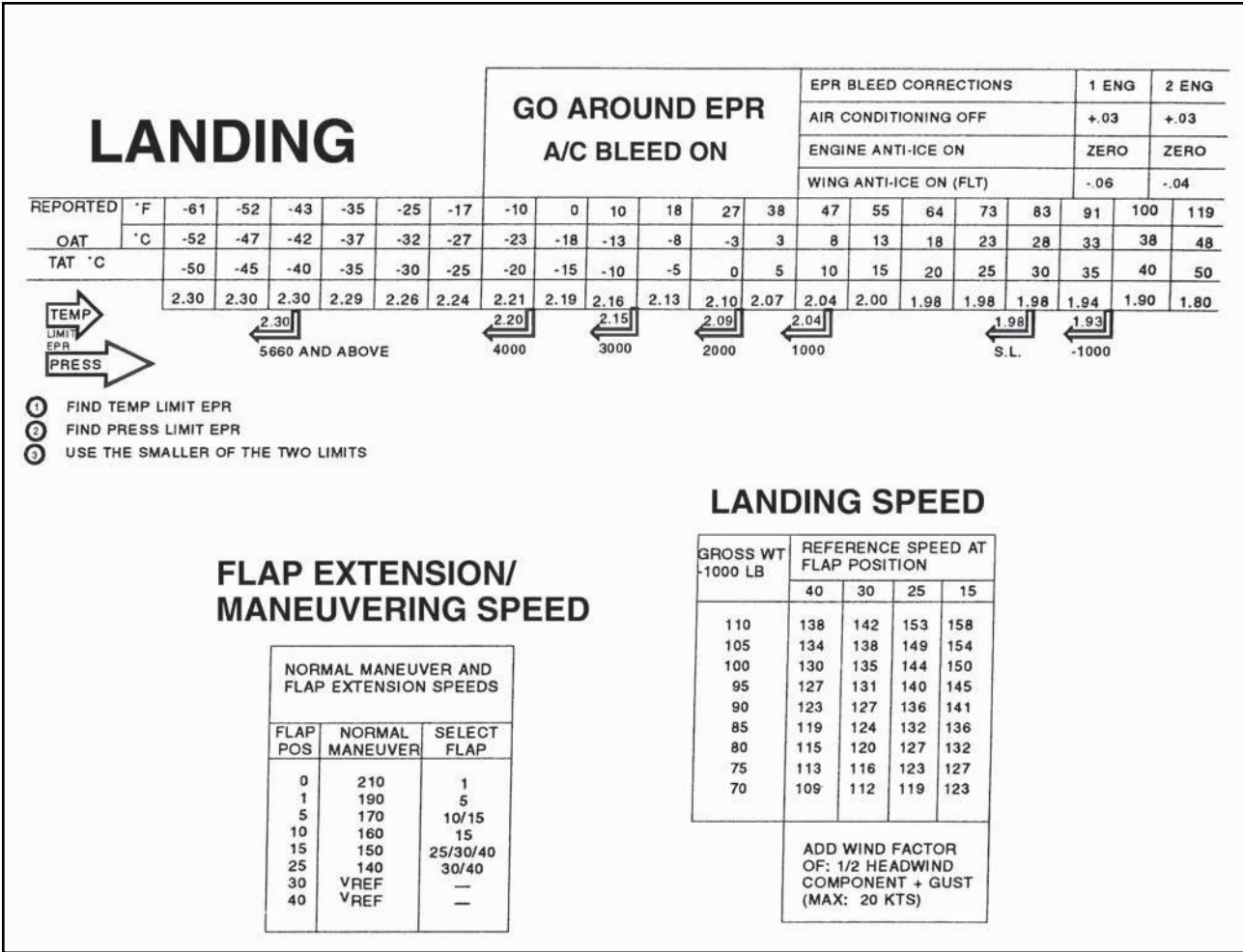

Figure 9-58. Landing performance chart.





### .80M/250 KIAS

FLIGHT LEVEL	TIME MIN	FUEL LB	DISTANCE NAM		
			AT LANDING WEIGHTS		
			120,000 LB	140,000 LB	160,000 LB
410	27	1610	133	137	138
390	27	1600	130	134	136
370	26	1570	123	128	129
350	25	1540	116	120	122
330	24	1510	110	113	115
310	23	1480	103	107	108
290	22	1450	97	100	101
270	21	1420	90	93	95
250	20	1390	84	87	88
230	19	1360	78	80	81
210	18	1320	72	74	75
190	17	1280	66	68	68
170	16	1240	60	62	62
150	14	1190	54	56	56
100	11	1050	39	40	40
050	8	870	24	24	24
015	5	700	12	12	12

### .80M/280/250 KIAS

FLIGHT LEVEL	TIME MIN	FUEL LB	DISTANCE NAM		
			AT LANDING WEIGHTS		
			120,000 LB	140,000 LB	160,000 LB
410	25	1550	123	129	132
390	24	1540	121	127	130
370	24	1520	115	121	125
350	23	1500	111	117	120
330	23	1480	106	111	115
310	22	1450	100	105	108
290	21	1430	94	99	102
270	20	1400	88	93	95
250	19	1370	83	87	89
230	18	1350	77	81	83
210	17	1310	72	75	76
190	16	1280	66	69	70
170	15	1240	61	63	64
150	14	1200	55	57	58
100	12	1080	42	42	42
050	8	870	24	24	24
015	5	700	12	12	12

### .80M/320/250 KIAS

FLIGHT LEVEL	TIME MIN	FUEL LB	DISTANCE NAM		
			AT LANDING WEIGHTS		
			120,000 LB	140,000 LB	160,000 LB
410	22	1490	113	120	123
390	22	1480	111	117	121
370	21	1460	105	112	116
350	21	1440	101	107	111
330	20	1420	96	103	107
310	20	1400	92	98	102
290	19	1390	89	94	98
270	19	1370	85	90	94
250	18	1350	80	85	88
230	17	1330	75	79	82
210	17	1300	71	74	77
190	16	1270	66	69	71
170	15	1240	61	64	65
150	14	1210	56	59	60
100	12	1110	45	46	46
050	8	870	24	24	24
015	5	700	12	12	12

### .80M/350/250 KIAS

FLIGHT LEVEL	TIME MIN	FUEL LB	DISTANCE NAM		
			AT LANDING WEIGHTS		
			120,000 LB	140,000 LB	160,000 LB
410	21	1440	106	112	116
390	21	1430	103	110	114
370	20	1420	99	106	110
350	20	1400	95	101	106
330	19	1390	91	98	102
310	19	1380	88	94	98
290	18	1360	85	90	95
270	18	1350	82	87	91
250	17	1330	78	83	87
230	17	1310	74	78	81
210	16	1290	70	74	76
190	16	1270	65	69	71
170	15	1240	61	64	66
150	14	1210	57	60	61
100	13	1130	47	48	49
050	8	870	24	24	24
015	5	700	12	12	12

NOTE: FUEL FOR A STRAIGHT-IN APPROACH IS INCLUDED

Figure 9-60. Descent performance chart.

LANDING DISTANCE COMPARISON

FLAPS 0  
 FLAPS 5  
 FLAPS 15

TOUCHDOWN AT 1000 FEET FROM RUNWAY THRESHOLD  
 SPOILERS AND BRAKES APPLIED 2 SECONDS AFTER TOUCHDOWN  
 REVERSE THRUST APPLIED 3 SECONDS AFTER TOUCHDOWN  
 MAIN AND NOSE BRAKES  
 SEA LEVEL, STANDARD DAY  
 ZERO WIND, DRY RUNWAY  
 ANTI-SKID OPERATIVE

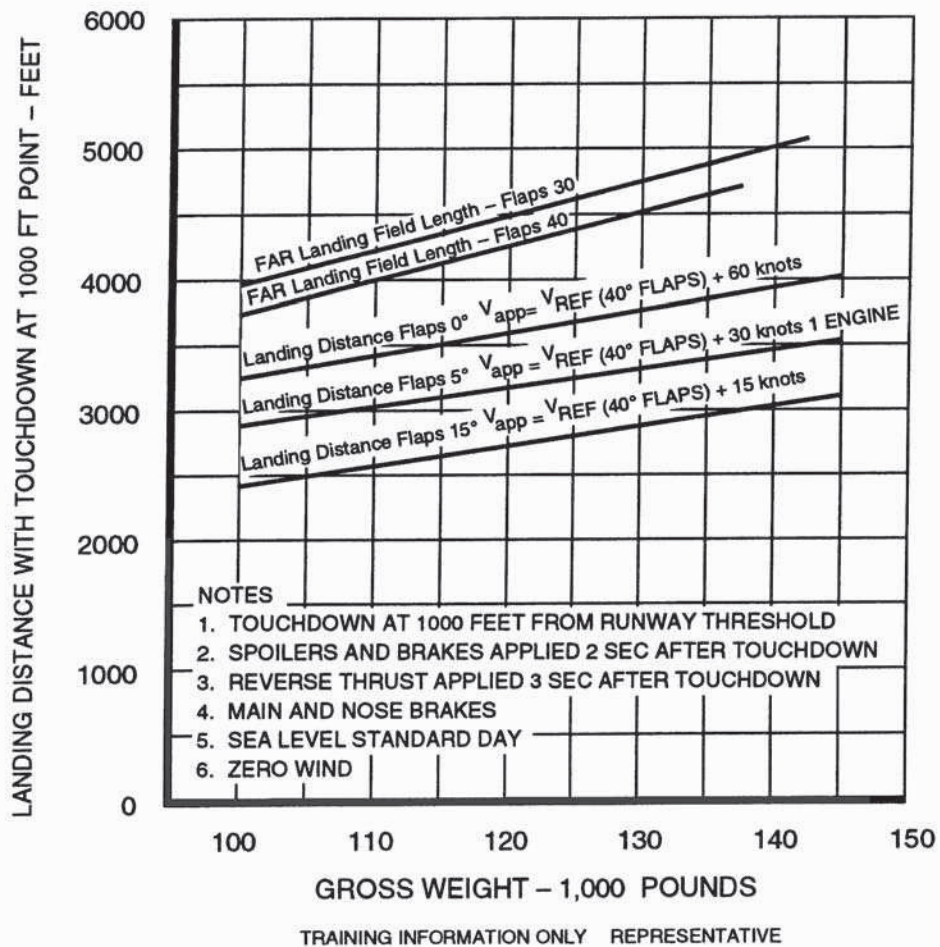

**NORMAL LANDING**

Figure 9-61. B-727—Normal landing distance comparison.

**THRUST REQUIRED**  
**— 3 ENGINES —**

GROSS WEIGHT — 140,000 LBS.  
SEA LEVEL

———— LEVEL FLIGHT  
- - - - 3° GLIDE SLOPE  
⊕ V<sub>REF</sub>

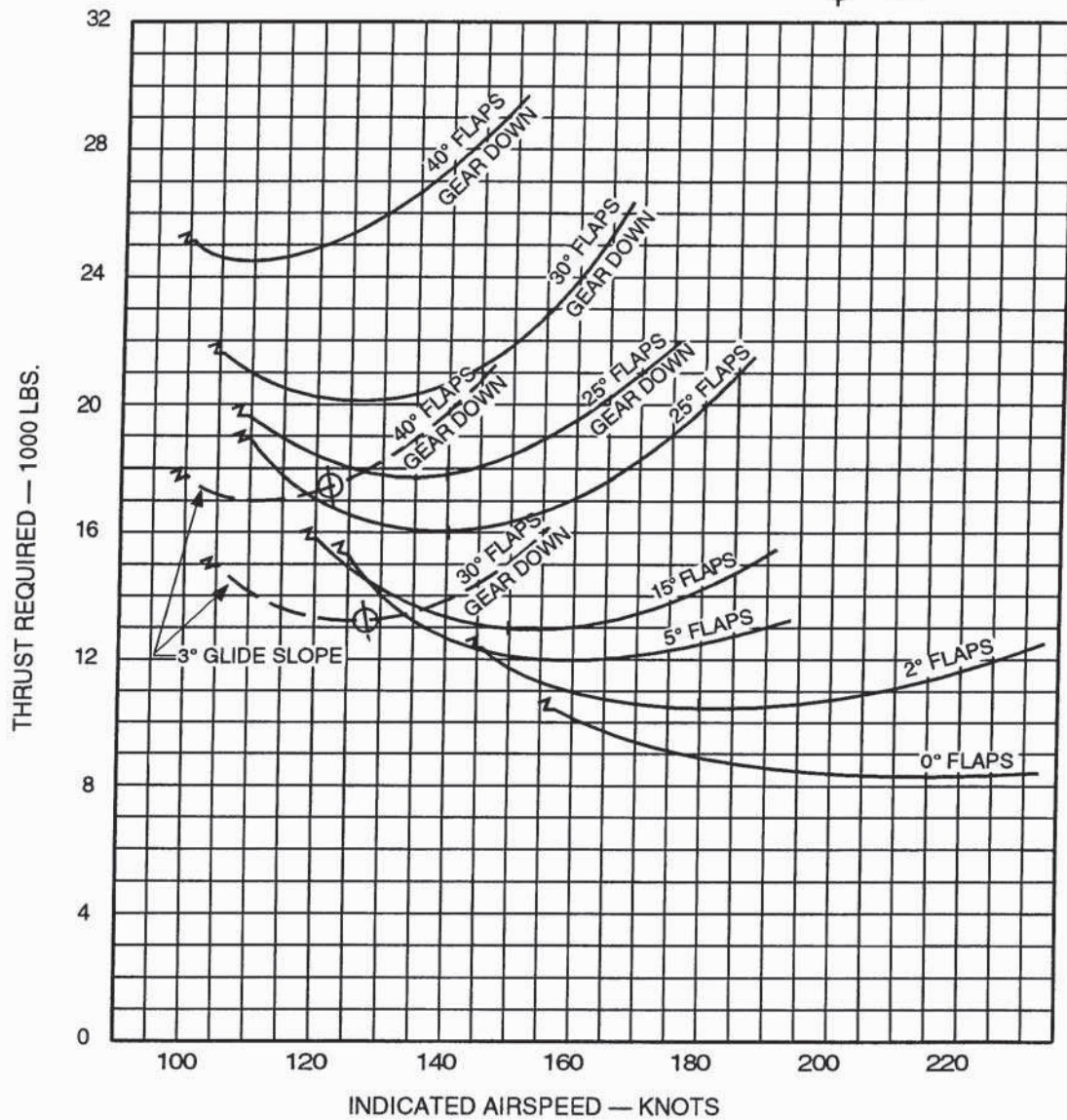

TRAINING INFORMATION ONLY REPRESENTATIVE

**NORMAL LANDING**

Figure 9-62. B-727—Landing thrust—140,000 pounds.

# Chapter 10

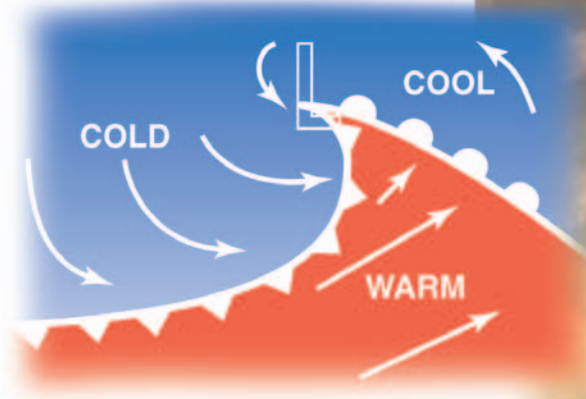

# Weather Theory

Whether preparing for a local flight or a long cross-country, flight-planning decisions based on weather can dramatically affect the safety of the flight. A solid understanding of weather theory provides the tools necessary to understand the reports and forecasts obtained from a Flight Service Station weather specialist and other aviation weather services.

This chapter is designed to help pilots acquire the background knowledge of weather principles necessary to develop sound decision making skills relating to weather. It is important to note, however, that there is no substitute for experience.

## NATURE OF THE ATMOSPHERE

The atmosphere is a mixture of gases that surround the Earth. This blanket of gases provides protection from ultraviolet rays as well as supporting human, animal, and plant life on the planet. Nitrogen accounts for 78 percent of the gases that comprise the atmosphere, while oxygen makes up 21 percent. Argon, carbon dioxide, and traces of other gases make up the remaining 1 percent. [Figure 10-1]

Within this envelope of gases, there are several recognizable layers of the atmosphere that are defined not only by altitude, but also by the specific characteristics of that level. [Figure 10-2]

The first layer, known as the **troposphere**, extends from sea level up to 20,000 feet (8 km) over the northern and southern poles and up to 48,000 feet (14.5 km) over the equatorial regions. The vast majority of weather, clouds, storms, and temperature variances

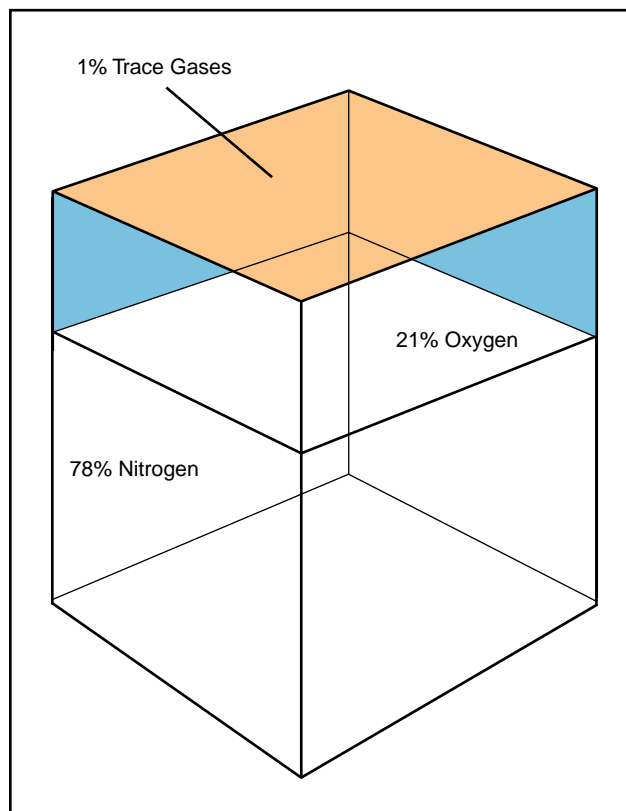

Figure 10-1. Composition of the atmosphere.

**Troposphere**—The layer of the atmosphere extending from the surface to a height of 20,000 to 60,000 feet depending on latitude.

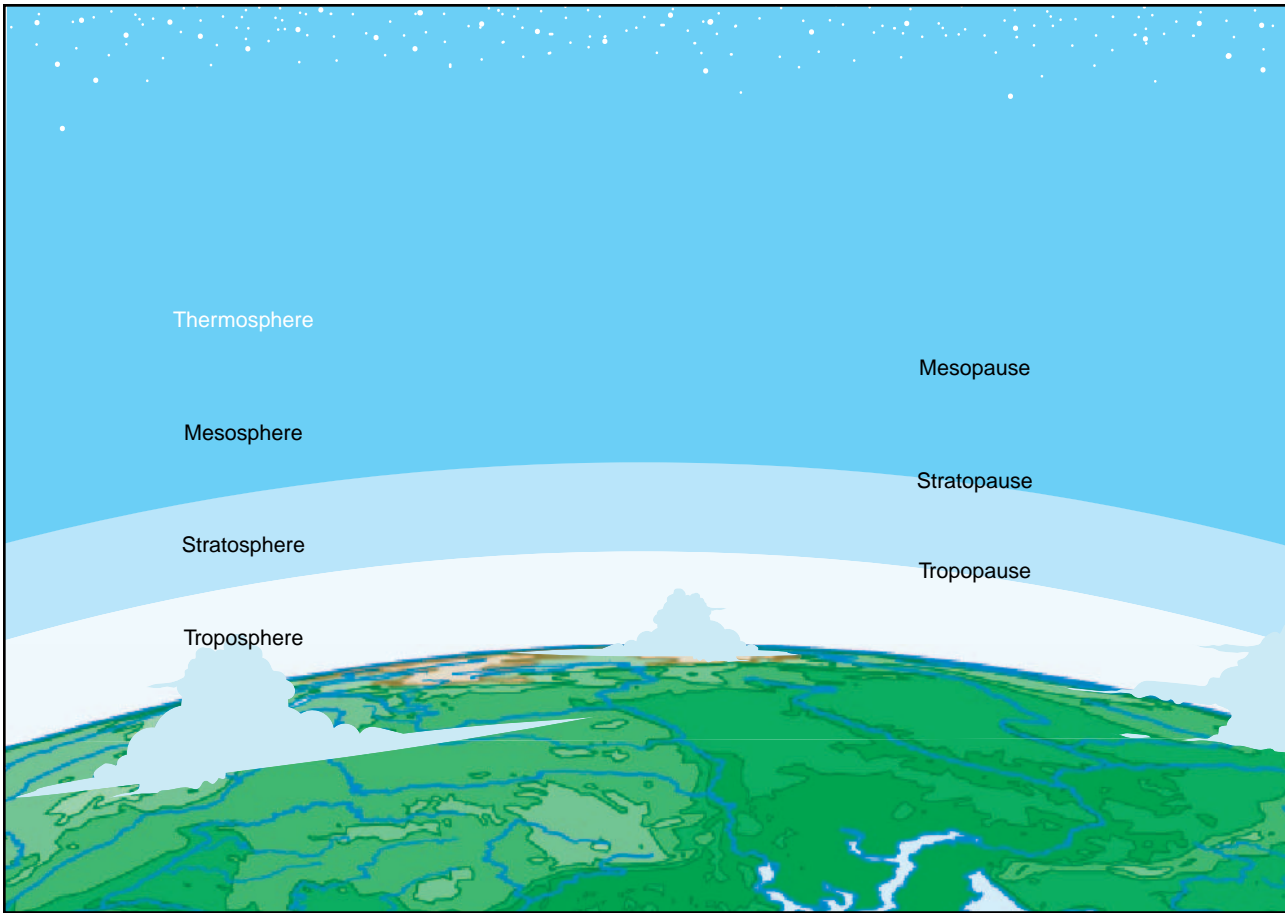

Figure 10-2. Layers of the atmosphere.

occur within this first layer of the atmosphere. Inside the troposphere, the temperature decreases at a rate of about 2° Celsius every 1,000 feet of altitude gain, and the pressure decreases at a rate of about 1 inch per 1,000 feet of altitude gain. At the top of the troposphere is a boundary known as the **tropopause**, which traps moisture, and the associated weather, in the troposphere. The altitude of the tropopause varies with latitude and with the season of the year; therefore, it takes on an elliptical shape, as opposed to round. Location of the tropopause is important because it is commonly associated with the location of the **jetstream** and possible clear air turbulence.

The atmospheric level above the tropopause is the **stratosphere**, which extends from the tropopause to a height of about 160,000 feet (50 km). Little weather exists in this layer and the air remains stable. At the top of the stratosphere is another boundary known as the stratopause, which exists at approximately 160,000 feet. Directly above this is the **mesosphere**, which extends to the mesopause boundary at about 280,000 feet (85 km). The temperature in the mesosphere decreases rapidly with an increase in altitude and can be as cold as -90°C. The last layer of the atmosphere is the **thermosphere**. It starts above the mesosphere and gradually fades into outer space.

## OXYGEN AND THE HUMAN BODY

As discussed earlier, nitrogen and other trace gases make up 79 percent of the atmosphere, while the remaining 21 percent is life sustaining, atmospheric oxygen. At sea level, atmospheric pressure is great enough to support normal growth, activity, and life. At 18,000 feet, however, the partial pressure of oxygen is significantly reduced to the point that it adversely affects the normal activities and functioning of the human body. In fact, the reactions of the average person begin to be impaired at an altitude of about 10,000 feet and for some people as low as 5,000 feet. The physiological reactions to oxygen deprivation are insidious and affect people in different ways. These symptoms range from mild disorientation to total incapacitation, depending on body tolerance and altitude.

**Tropopause**—The boundary between the troposphere and the stratosphere which acts as a lid to confine most of the water vapor, and the associated weather, to the troposphere.

**Jetstream**—A narrow band of wind with speeds of 100 to 200 m.p.h. usually associated with the tropopause.

**Stratosphere**—A layer of the atmosphere above the tropopause extending to a height of approximately 160,000 feet.

**Mesosphere**—A layer of the atmosphere directly above the stratosphere.

**Thermosphere**—The last layer of the atmosphere that begins above the mesosphere and gradually fades away into space.

By using supplemental oxygen or cabin pressurization systems, pilots can fly at higher altitudes and overcome the ill effects of oxygen deprivation.

### SIGNIFICANCE OF ATMOSPHERIC PRESSURE

At sea level, the atmosphere exerts pressure on the Earth at a force of 14.7 pounds per square inch. This means a column of air 1-inch square, extending from the surface up to the upper atmospheric limit, weighs about 14.7 pounds. [Figure 10-3] A person standing at sea level also experiences the pressure of the atmosphere; however, the pressure is not a downward force, but rather a force of pressure over the entire surface of the skin.

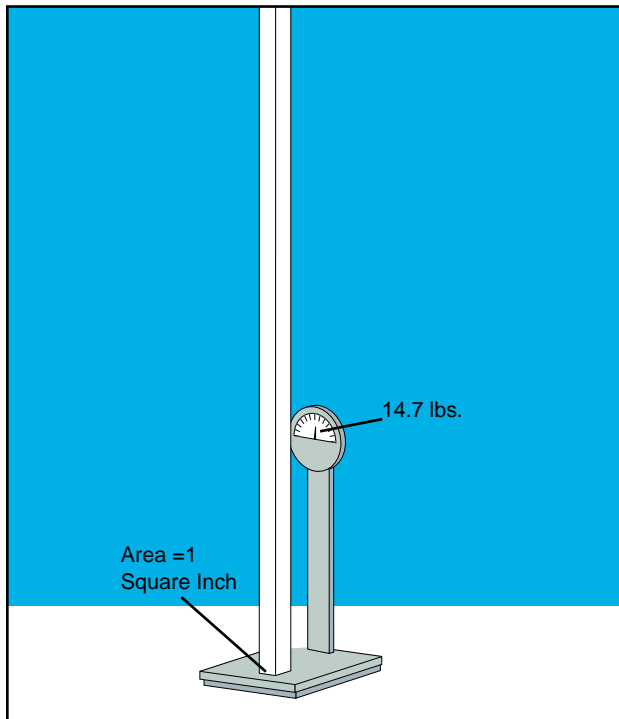
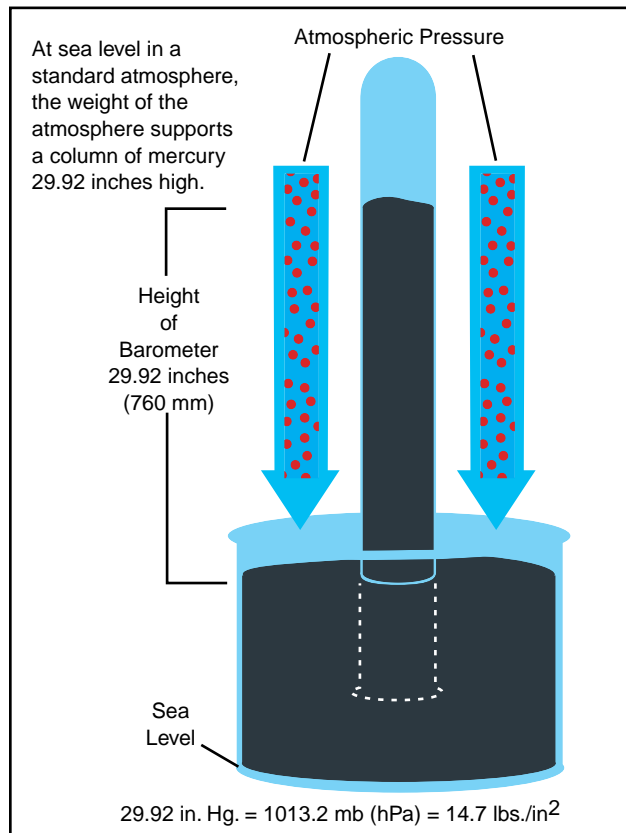

**Figure 10-3.** One square inch of atmosphere weighs approximately 14.7 pounds.

The actual pressure at a given place and time will differ with altitude, temperature, and density of the air. These conditions also affect aircraft performance, especially with regard to takeoff, rate of climb, and landings.

### MEASUREMENT OF ATMOSPHERIC PRESSURE

Atmospheric pressure is typically measured in inches of mercury (in. Hg.) by a mercurial barometer. [Figure 10-4] The barometer measures the height of a column of mercury inside a glass tube. A section of the mercury is exposed to the pressure of the atmosphere, which exerts a force on the mercury. An increase in pressure forces the mercury to rise inside the tube; as pressure drops, mercury drains out of the tube, decreasing the height of the column. This type of barometer is typically used in a lab or weather observation station, is not easily transported, and is a bit difficult to read.



**Figure 10-4.** Mercurial barometer.

An aneroid barometer is an alternative to a mercurial barometer; it is easier to read and transport. [Figure 10-5] The aneroid barometer contains a closed vessel, called an aneroid cell, that contracts or expands with changes in pressure. The aneroid cell attaches to a pressure indicator with a mechanical linkage to provide pressure readings. The pressure sensing part of an aircraft altimeter is essentially an aneroid barometer. It is important to note that due to the linkage mechanism of an aneroid barometer, it is not as accurate as a mercurial barometer.

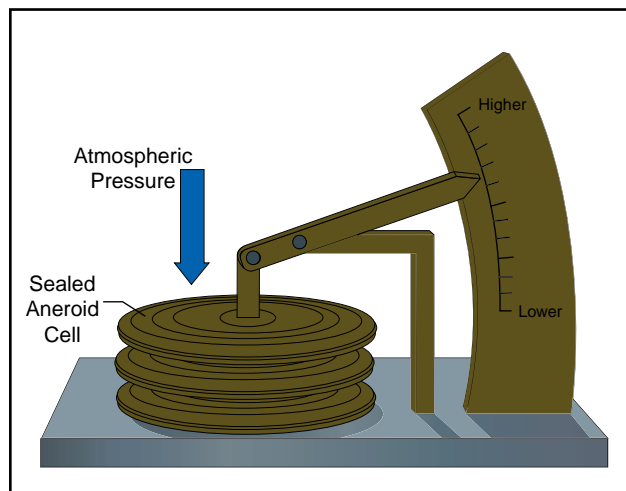

**Figure 10-5.** Aneroid barometer.

To provide a common reference for temperature and pressure the International Standard Atmosphere (ISA) has been established. These standard conditions are the basis for certain flight instruments and most airplane performance data. Standard sea level pressure is defined as 29.92 in. Hg. at 59°F (15°C). Atmospheric pressure is also reported in millibars, with 1 inch of mercury equaling approximately 34 millibars and standard sea level equaling 1013.2 millibars. Typical millibar pressure readings range from 950.0 to 1040.0 millibars. Constant pressure charts and hurricane pressure reports are written using millibars.

Since weather stations are located around the globe, all local barometric pressure readings are converted to a sea level pressure to provide a standard for records and reports. To achieve this, each station converts its barometric pressure by adding approximately 1 inch of mercury for every 1,000 feet of elevation gain. For example, a station at 5,000 feet above sea level, with a reading of 24.92 inches of mercury, reports a sea level pressure reading of 29.92 inches. [Figure 10-6] Using common sea level pressure readings helps ensure aircraft altimeters are set correctly, based on the current pressure readings.

By tracking barometric pressure trends across a large area, weather forecasters can more accurately predict movement of pressure systems and the associated weather. For example, tracking a pattern of rising pressure at a single weather station generally indicates the approach of fair weather. Conversely, decreasing or rapidly falling pressure usually indicates approaching bad weather and possibly, severe storms.

## EFFECT OF ALTITUDE ON ATMOSPHERIC PRESSURE

As altitude increases, pressure diminishes, as the weight of the air column decreases. On average, with every 1,000 feet of altitude increase, the atmospheric pressure decreases 1 inch of mercury. This decrease in pressure (increase in density altitude) has a pronounced effect on aircraft performance.

## EFFECT OF ALTITUDE ON FLIGHT

Altitude affects every aspect of flight from aircraft performance to human performance. At higher altitudes, with a decreased atmospheric pressure, takeoff and landing distances are increased, as are climb rates.

When an aircraft takes off, lift must be developed by the flow of air around the wings. If the air is thin, more speed is required to obtain enough lift for takeoff; therefore, the ground run is longer. An aircraft that requires a 1,000-foot ground run at sea level will require almost double that at an airport 5,000 feet above sea level [Figure 10-7]. It is also true that at higher altitudes, due to the decreased density of the air, aircraft engines and propellers are less efficient. This leads to reduced rates of climb and a greater ground run for obstacle clearance.

**ISA—International Standard Atmosphere: Standard atmospheric conditions consisting of a temperature of 59°F (15°C), and a barometric pressure of 29.92 in. Hg. (1013.2 mb) at sea level. ISA values can be calculated for various altitudes using standard lapse rate.**

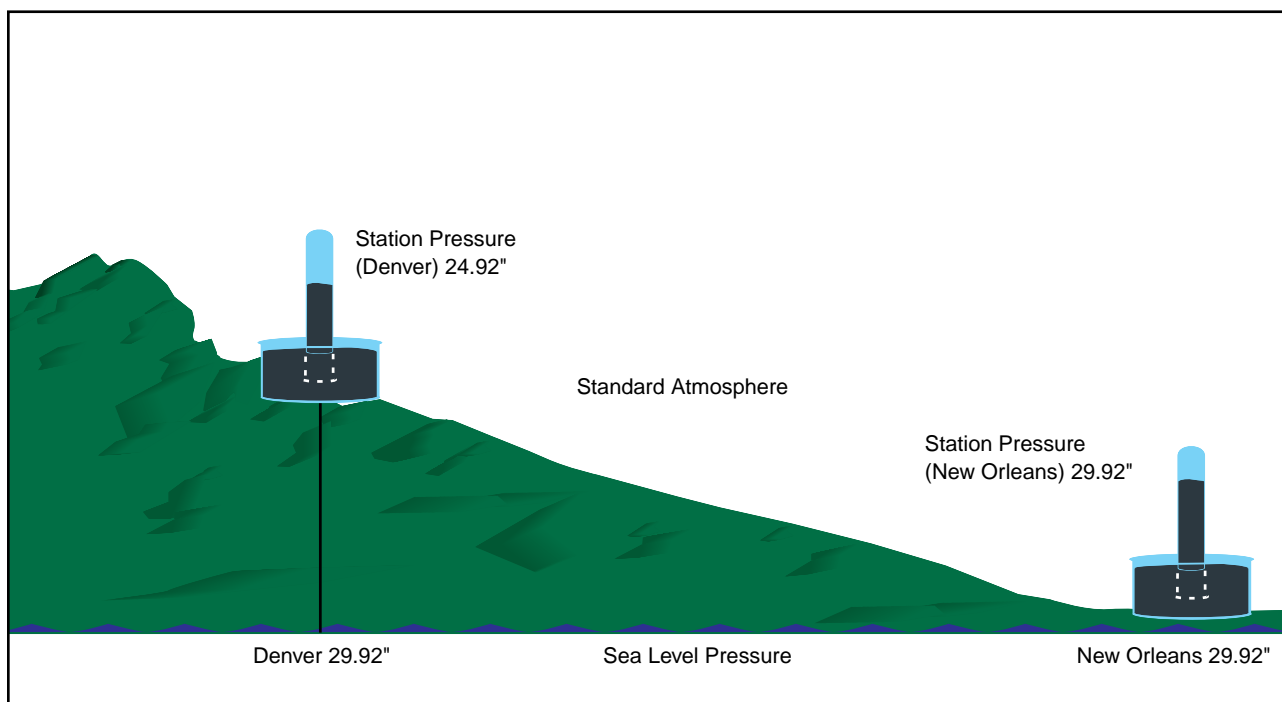

Figure 10-6. Station pressure is converted to, and reported in, sea level pressure.

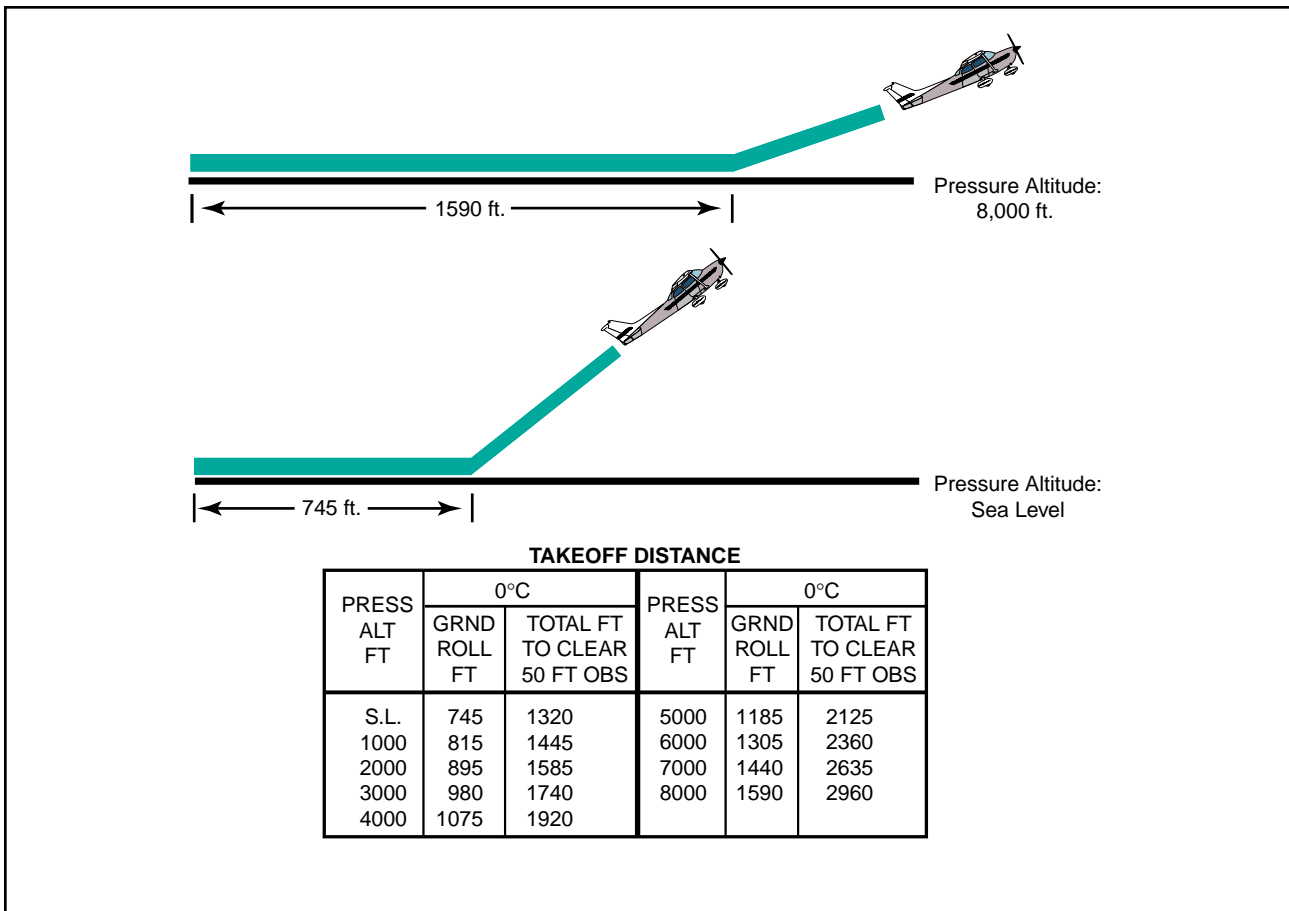

Figure 10-7. Takeoff distance increases with increased altitude.

### EFFECT OF DIFFERENCES IN AIR DENSITY

Differences in air density caused by changes in temperature result in changes in pressure. This, in turn, creates motion in the atmosphere, both vertically and horizontally, in the form of currents and wind. Motion in the atmosphere, combined with moisture, produces clouds and precipitation otherwise known as weather.

### WIND

Pressure and temperature changes produce two kinds of motion in the atmosphere—vertical movement of ascending and descending currents, and horizontal movement in the form of wind. Both types of motion in the atmosphere are important as they affect the takeoff, landing, and cruise flight operations. More important, however, is that these motions in the atmosphere, otherwise called atmospheric circulation, cause weather changes.

### THE CAUSE OF ATMOSPHERIC CIRCULATION

Atmospheric circulation is the movement of air around the surface of the Earth. It is caused by uneven heating of the Earth’s surface and upsets the equilibrium of the atmosphere, creating changes in air movement and atmospheric pressure. Because the Earth has a curved

surface that rotates on a tilted axis while orbiting the sun, the equatorial regions of the Earth receive a greater amount of heat from the sun than the polar regions. The amount of sun that heats the Earth depends upon the time of day, time of year, and the latitude of the specific region. All of these factors affect the length of time and the angle at which sunlight strikes the surface.

In general circulation theory, areas of low pressure exist over the equatorial regions, and areas of high pressure exist over the polar regions due to a difference in temperature. Solar heating causes air to become less dense and rise in equatorial areas. The resulting low pressure allows the high-pressure air at the poles to flow along the planet’s surface toward the equator. As the warm air flows toward the poles, it cools, becoming more dense, and sinks back toward the surface. [Figure 10-8] This pattern of air circulation is correct in theory; however, the circulation of air is modified by several forces, most importantly the rotation of the Earth.

The force created by the rotation of the Earth is known as Coriolis force. This force is not perceptible to us as we walk around because we move so slowly and travel relatively short distances compared to the size and rotation rate of the Earth. However, it does significantly affect bodies that move over great distances, such as an



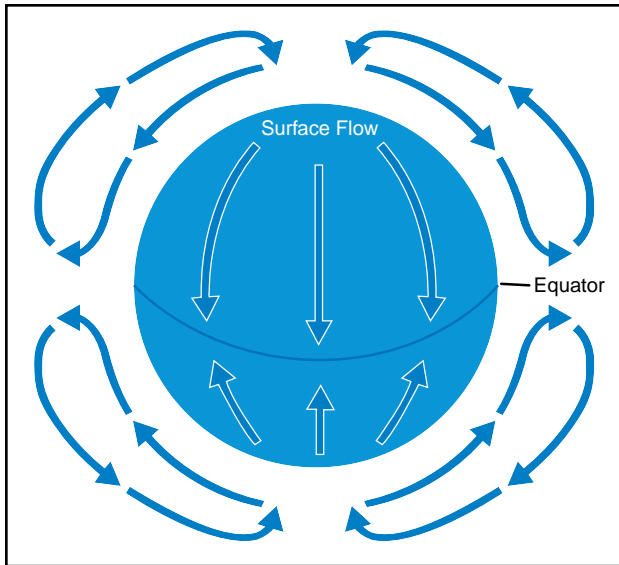

Figure 10-8. Circulation pattern in a static environment.

air mass or body of water. The Coriolis force deflects air to the right in the Northern Hemisphere, causing it to follow a curved path instead of a straight line. The amount of deflection differs depending on the latitude. It is greatest at the poles, and diminishes to zero at the equator. The magnitude of Coriolis force also differs with the speed of the moving body—the faster the speed, the greater the deviation. In the Northern Hemisphere, the rotation of the Earth deflects moving air to the right and changes the general circulation pattern of the air.

The speed of the Earth's rotation causes the general flow to break up into three distinct cells in each hemisphere. [Figure 10-9] In the Northern Hemisphere, the warm air at the equator rises upward from the surface, travels northward, and is deflected eastward by the rotation of the Earth. By the time it has traveled one-third of the distance from the equator to the North Pole, it is no longer moving northward, but eastward. This air cools and sinks in a belt-like area at about 30° latitude, creating an area of high pressure as it sinks toward the surface. Then it flows southward along the surface back toward the equator. Coriolis force bends the flow to the right, thus creating the northeasterly trade winds that prevail from 30° latitude to the equator. Similar forces create circulation cells that encircle the Earth between 30° and 60° latitude, and between 60° and the poles. This circulation pattern results in the prevailing westerly winds in the conterminous United States.

Circulation patterns are further complicated by seasonal changes, differences between the surfaces of continents and oceans, and other factors.

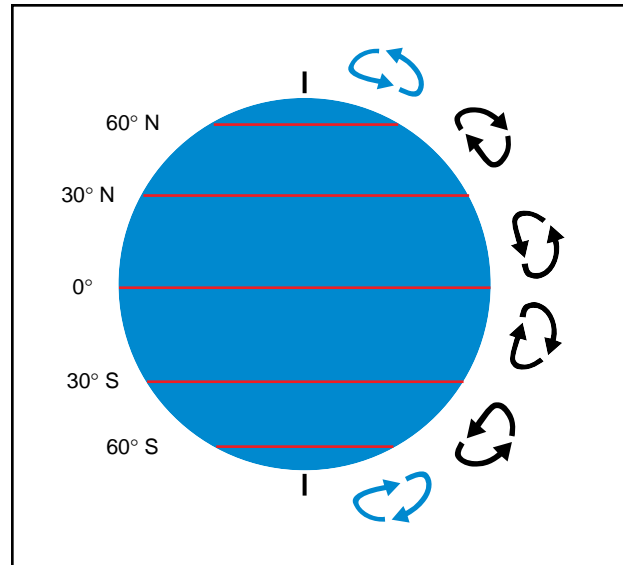

Figure 10-9. Three-cell circulation pattern due to the rotation of the Earth.

Frictional forces caused by the topography of the Earth's surface modify the movement of the air in the atmosphere. Within 2,000 feet of the ground, the friction between the surface and the atmosphere slows the moving air. The wind is diverted from its path because the frictional force reduces the Coriolis force. This is why the wind direction at the surface varies somewhat from the wind direction just a few thousand feet above the Earth.

### WIND PATTERNS

Air flows from areas of high pressure into those of low pressure because air always seeks out lower pressure. In the Northern Hemisphere, this flow of air from areas of high to low pressure is deflected to the right; producing a clockwise circulation around an area of high pressure. This is also known as anti-cyclonic circulation. The opposite is true of low-pressure areas; the air flows toward a low and is deflected to create a counter-clockwise or cyclonic circulation. [Figure 10-10]

High-pressure systems are generally areas of dry, stable, descending air. Good weather is typically associated with high-pressure systems for this reason. Conversely, air flows into a low-pressure area to replace rising air. This air tends to be unstable, and usually brings increasing cloudiness and precipitation. Thus, bad weather is commonly associated with areas of low pressure.

A good understanding of high- and low-pressure wind patterns can be of great help when planning a flight, because a pilot can take advantage of beneficial tailwinds. [Figure 10-11] When planning a flight from west to east, favorable winds would be encountered

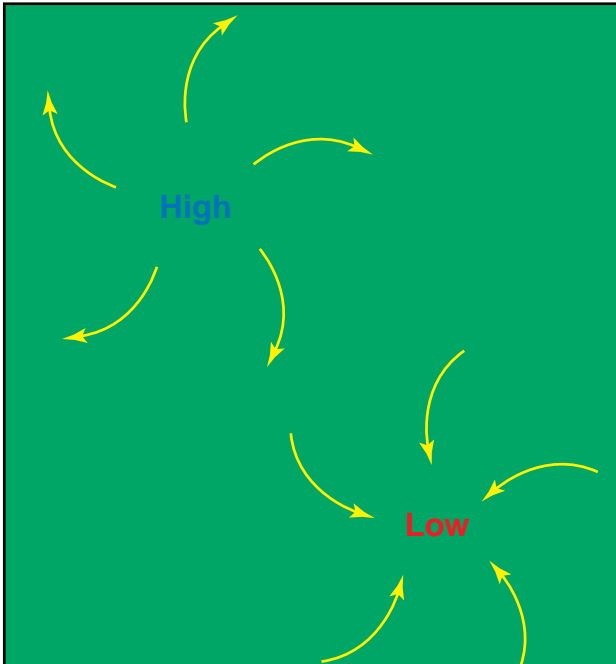

**Figure 10-10.** Circulation pattern about areas of high and low pressure.

along the northern side of a high-pressure system or the southern side of a low-pressure system. On the return flight, the most favorable winds would be along the southern side of the same high-pressure system or the northern side of a low-pressure system. An added advantage is a better understanding of what type of weather to expect in a given area along a route of flight based on the prevailing areas of highs and lows.

The theory of circulation and wind patterns is accurate for large-scale atmospheric circulation; however, it does not take into account changes to the circulation on a local scale. Local conditions, geological features, and other anomalies can change the wind direction and speed close to the Earth's surface.

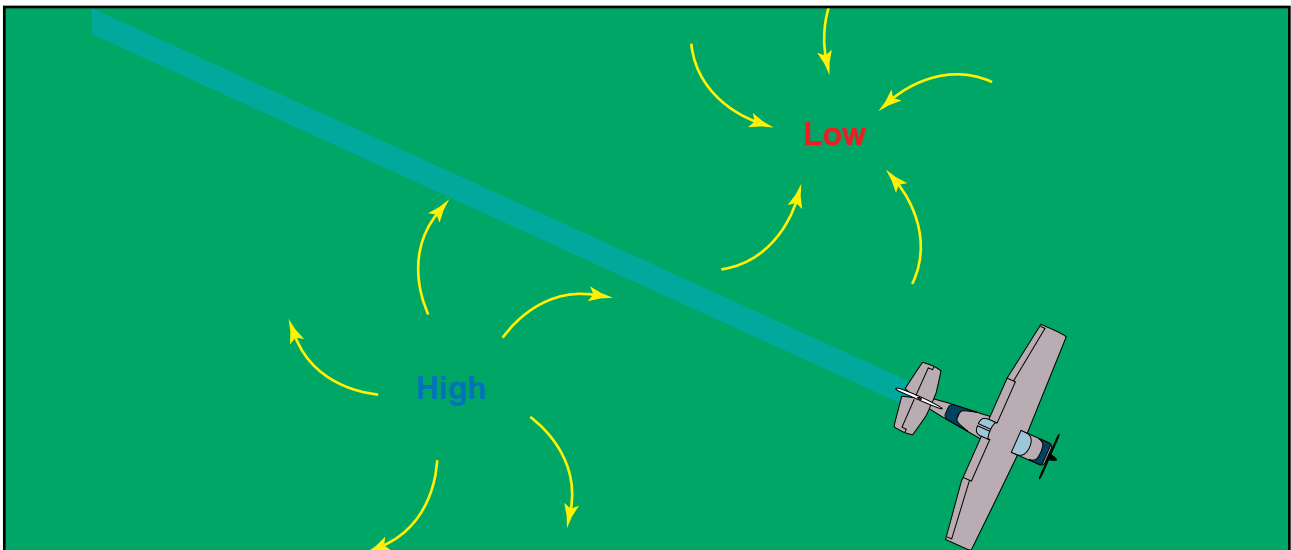

**Figure 10-11.** Favorable winds near a high-pressure system.

## CONVECTIVE CURRENTS

Different surfaces radiate heat in varying amounts. Plowed ground, rocks, sand, and barren land give off a large amount of heat; water, trees, and other areas of vegetation tend to absorb and retain heat. The resulting uneven heating of the air creates small areas of local circulation called convective currents.

Convective currents cause the bumpy, turbulent air sometimes experienced when flying at lower altitudes during warmer weather. On a low altitude flight over varying surfaces, updrafts are likely to occur over pavement or barren places, and downdrafts often occur over water or expansive areas of vegetation like a group of trees. Typically, these turbulent conditions can be avoided by flying at higher altitudes, even above cumulus cloud layers. [Figure 10-12]

Convective currents are particularly noticeable in areas with a landmass directly adjacent to a large body of water, such as an ocean, large lake, or other appreciable area of water. During the day, land heats faster than water, so the air over the land becomes warmer and less dense. It rises and is replaced by cooler, denser air flowing in from over the water. This causes an onshore wind, called a **sea breeze**. Conversely, at night land cools faster than water, as does the corresponding air. In this case, the warmer air over the water rises and is replaced by the cooler, denser air from the land, creating an offshore wind called a **land breeze**. This reverses the local wind circulation pattern. Convective currents can occur anywhere there is an uneven heating of the Earth's surface. [Figure 10-13]

**Sea Breeze**—A coastal breeze blowing from sea to land caused by the temperature difference when the land surface is warmer than the sea surface. The sea breeze usually occurs during the day.

**Land Breeze**—A coastal breeze flowing from land to sea caused by the temperature difference when the sea surface is warmer than the adjacent land. The land breeze usually occurs at night.

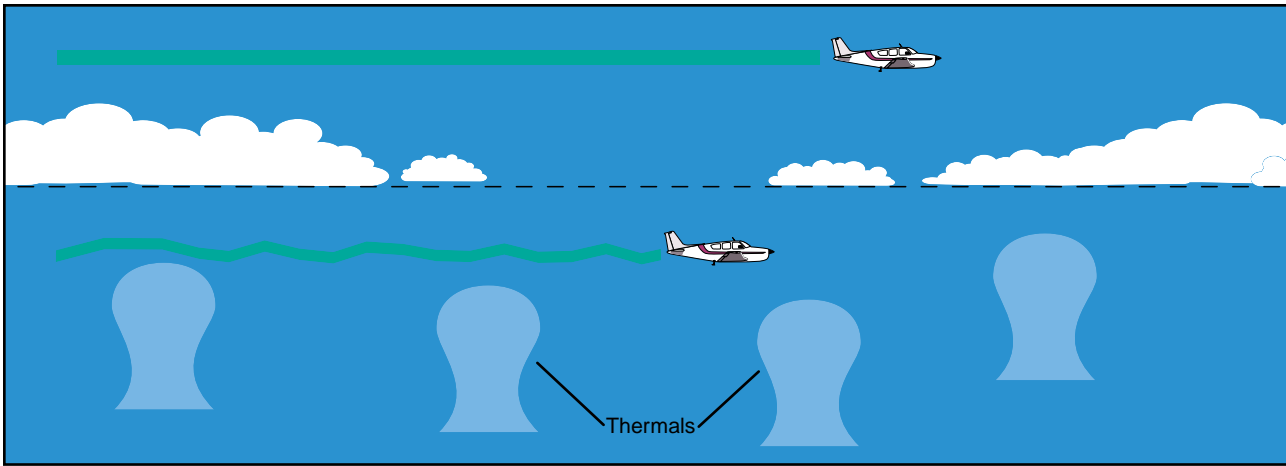

Figure 10-12. Convective turbulence avoidance.

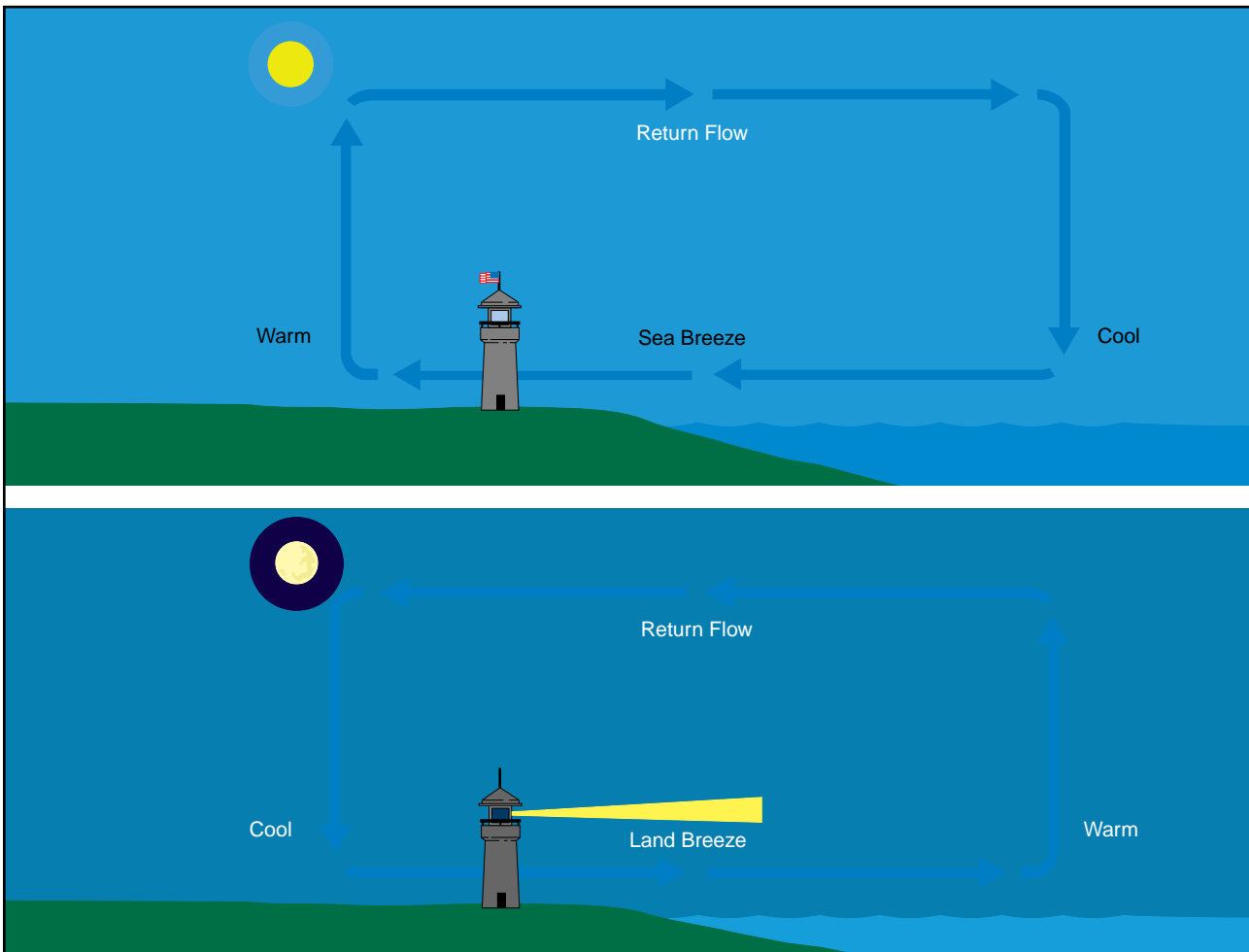

Figure 10-13. Sea breeze and land breeze wind circulation patterns.

Convection currents close to the ground can affect a pilot's ability to control the aircraft. On final approach, for example, the rising air from terrain devoid of vegetation sometimes produces a ballooning effect that can cause a pilot to overshoot the intended landing spot. On the other hand, an approach over a large body of water or an area of thick vegetation tends to create a sinking effect that can cause an unwary pilot to land short of the intended landing spot. [Figure 10-14]

### EFFECT OF OBSTRUCTIONS ON WIND

Another atmospheric hazard exists that can create problems for pilots. Obstructions on the ground affect the flow of wind and can be an unseen danger. Ground topography and large buildings can break up the flow of the wind and create wind gusts that change rapidly in direction and speed. These obstructions range from manmade structures like hangars to large natural obstructions, such as mountains, bluffs, or canyons. It

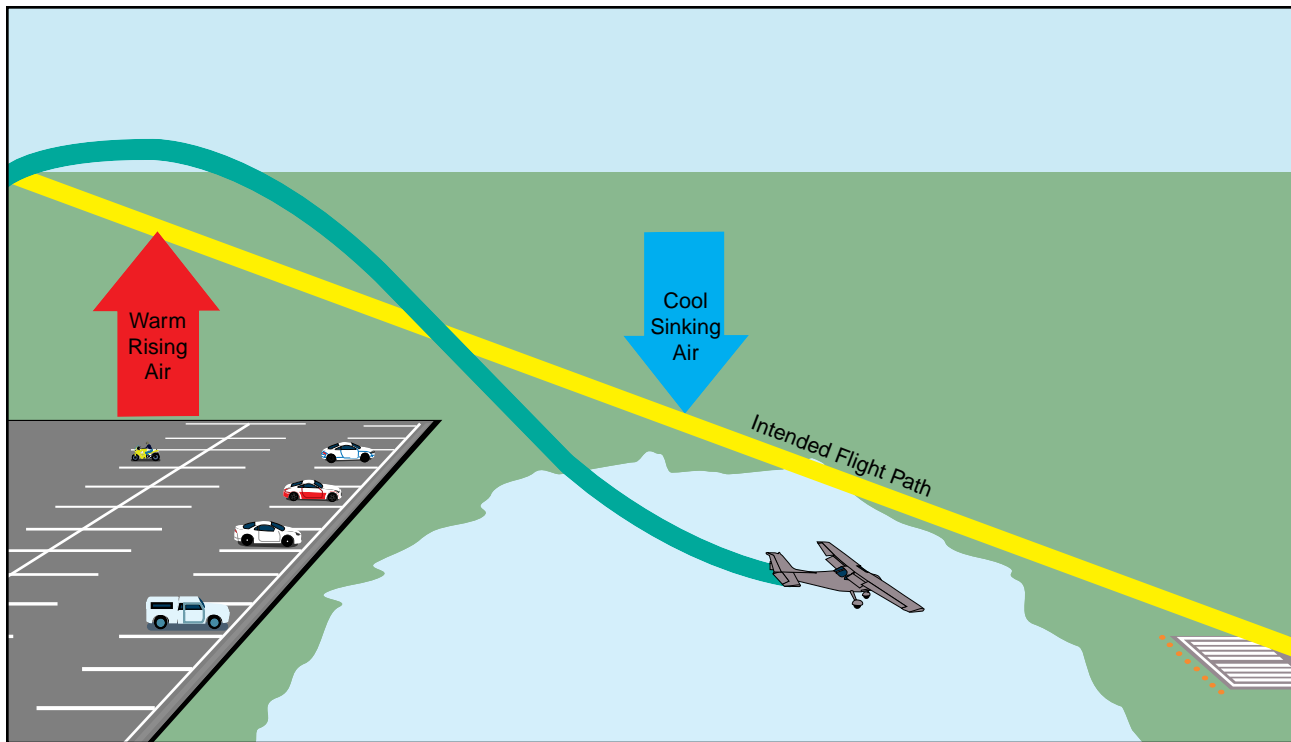

Figure 10-14. Currents generated by varying surface conditions.

is especially important to be vigilant when flying in or out of airports that have large buildings or natural obstructions located near the runway. [Figure 10-15]

The intensity of the turbulence associated with ground obstructions depends on the size of the obstacle and the primary velocity of the wind. This can affect the takeoff and landing performance of any aircraft and can present a very serious hazard. During the landing phase of flight, an aircraft may “drop in” due to the turbulent air and be too low to clear obstacles during the approach.

This same condition is even more noticeable when flying in mountainous regions. [Figure 10-16] While the wind flows smoothly up the windward side of the mountain and the upward currents help to carry an aircraft over the peak of the mountain, the wind on the leeward side does not act in a similar manner. As the air flows down the leeward side of the mountain, the air follows the contour of the terrain and is increasingly turbulent. This tends to push an aircraft into the side of a mountain. The stronger the wind, the greater the downward pressure and turbulence become.

Due to the effect terrain has on the wind in valleys or canyons, downdrafts can be severe. Thus, a prudent pilot is well advised to seek out a mountain qualified flight instructor and get a mountain checkout before conducting a flight in or near mountainous terrain.

## LOW-LEVEL WIND SHEAR

**Wind shear** is a sudden, drastic change in windspeed and/or direction over a very small area. Wind shear can subject an aircraft to violent updrafts and downdrafts as well as abrupt changes to the horizontal movement of the aircraft. While wind shear can occur at any altitude, low-level wind shear is especially hazardous due to the proximity of an aircraft to the ground. Directional wind changes of 180° and speed changes of 50 knots or more are associated with low-level wind shear. Low-level wind shear is commonly associated with passing frontal systems, thunderstorms, and temperature inversions with strong upper level winds (greater than 25 knots).

Wind shear is dangerous to an aircraft for several reasons. The rapid changes in wind direction and velocity changes the wind’s relation to the aircraft disrupting the normal flight attitude and performance of the aircraft. During a wind shear situation, the effects can be subtle or very dramatic depending on windspeed and direction of change. For example, a tailwind that quickly changes to a headwind will cause an increase in airspeed and performance. Conversely, when a headwind changes to a tailwind, the airspeed will rapidly decrease and there will be a corresponding decrease in performance. In either case, a pilot must be prepared to react immediately to the changes to maintain control of the aircraft.

**Wind Shear**—A sudden, drastic shift in windspeed, direction, or both that may occur in the horizontal or vertical plane.

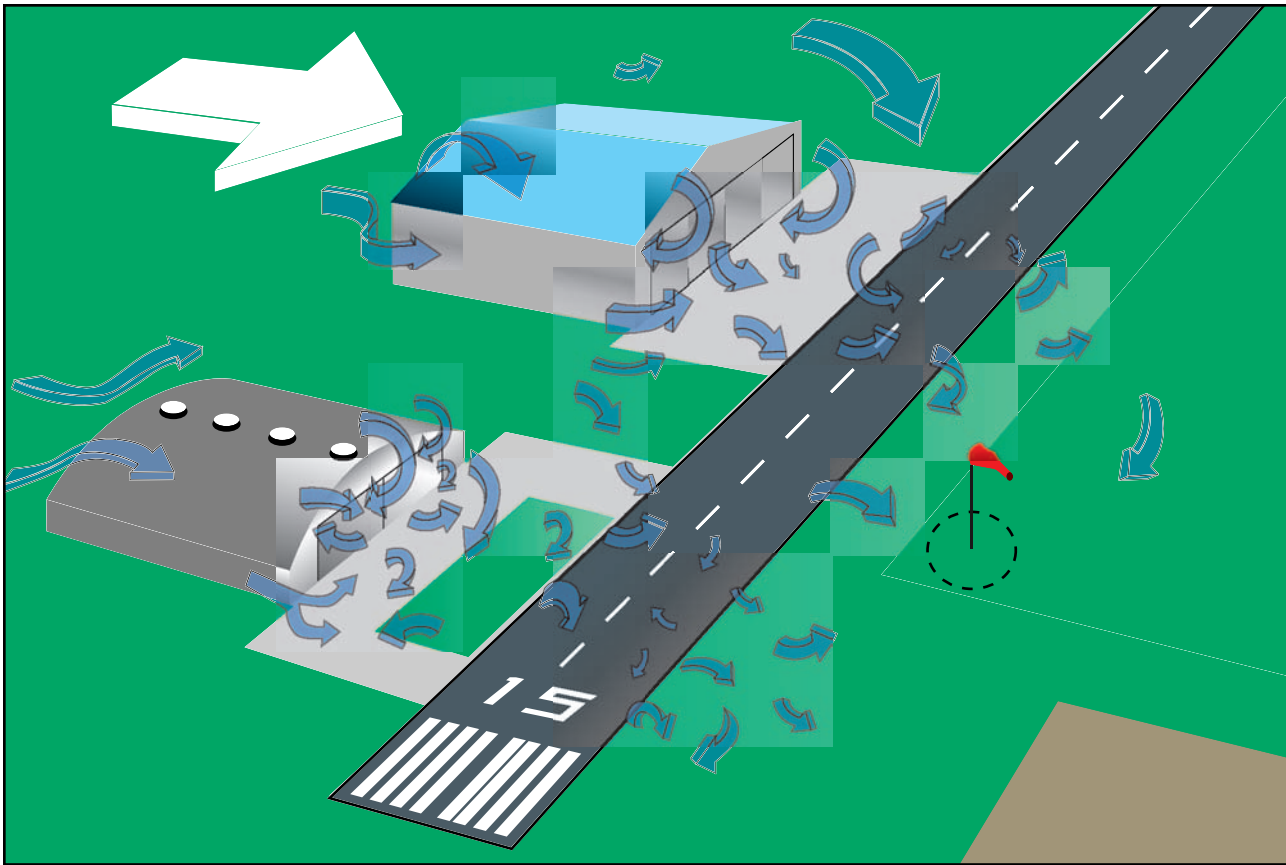

Figure 10-15. Turbulence caused by manmade obstructions.

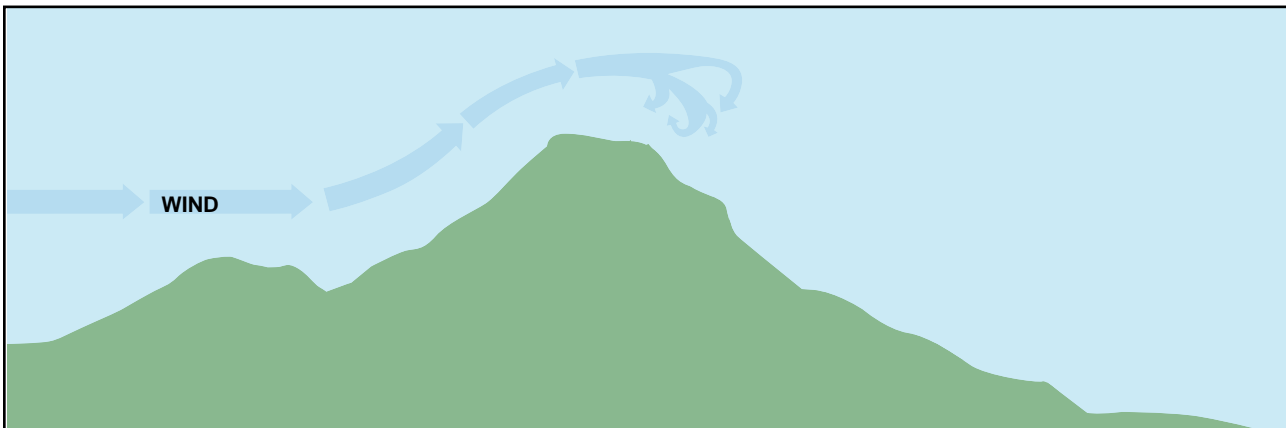

Figure 10-16. Turbulence encountered over and around mountainous regions.

In general, the most severe type of low-level wind shear is associated with convective precipitation or rain from thunderstorms. One critical type of shear associated with convective precipitation is known as a **microburst**. A typical microburst occurs in a space of less than 1 mile horizontally and within 1,000 feet vertically. The lifespan of a microburst is about 15 minutes during which it can produce downdrafts of up to 6,000 feet per minute. It can also produce a hazardous wind direction change of 45 knots or more, in a matter of seconds. When encountered close to the ground, these excessive downdrafts and rapid changes

in wind direction can produce a situation in which it is difficult to control the aircraft. [Figure 10-17] During an inadvertent takeoff into a microburst, the plane first experiences a performance-increasing headwind (#1), followed by performance-decreasing downdrafts (#2). Then the wind rapidly shears to a tailwind (#3), and can result in terrain impact or flight dangerously close to the ground (#4).

**Microburst**—A strong downdraft which normally occurs over horizontal distances of 1 NM or less and vertical distances of less than 1,000 feet. In spite of its small horizontal scale, an intense microburst could induce windspeeds greater than 100 knots and downdrafts as strong as 6,000 feet per minute.

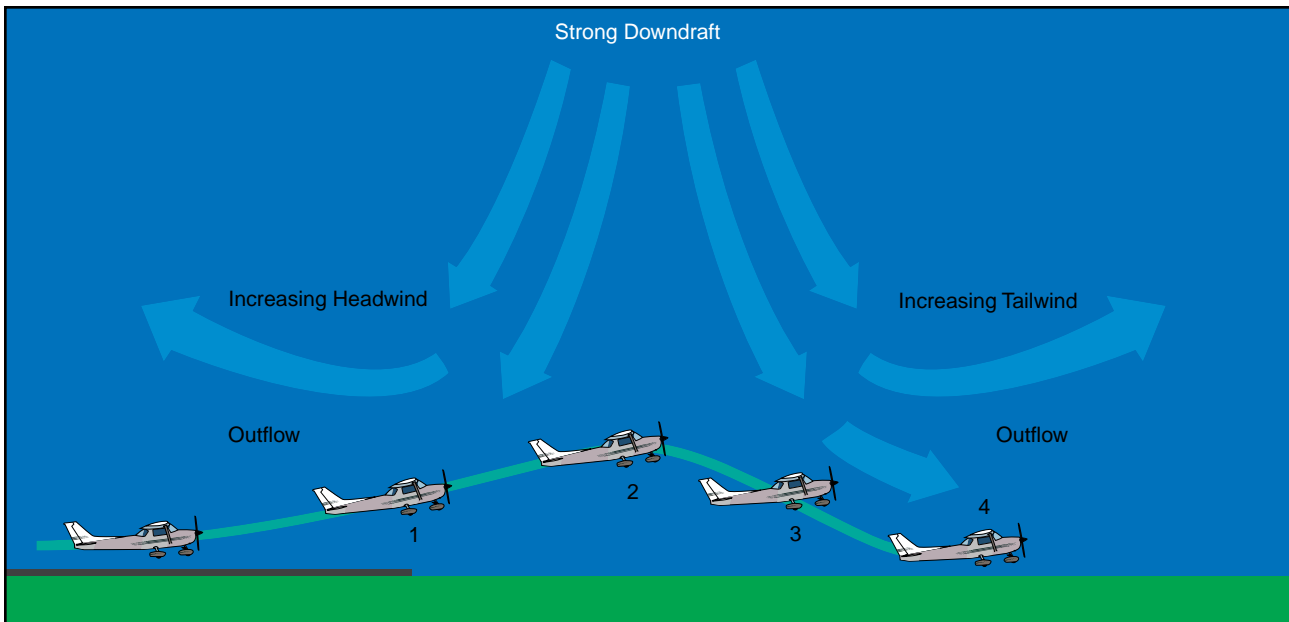

Figure 10-17. Effect of a microburst wind.

Microbursts are often difficult to detect because they occur in a relatively confined area. In an effort to warn pilots of low-level wind shear, alert systems have been installed at several airports around the country. A series of anemometers, placed around the airport, form a net to detect changes in windspeeds. When windspeeds differ by more than 15 knots, a warning for wind shear is given to pilots. This system is known as the low-level wind shear alert system, or LLWAS.

It is important to remember that wind shear can affect any flight and any pilot at any altitude. While wind shear may be reported, it often remains undetected and is a silent danger to aviation. Always be alert to the possibility of wind shear, especially when flying in and around thunderstorms and frontal systems.

### WIND AND PRESSURE REPRESENTATION ON SURFACE WEATHER MAPS

Surface weather maps provide information about fronts, areas of high and low pressure, and surface winds and pressures for each station. This type of weather map allows pilots to see the locations of fronts and pressure systems, but more importantly, it depicts the wind and pressure at the surface for each location. For more information on surface analysis and weather depiction charts see Chapter 11.

Wind conditions are reported by an arrow attached to the station location circle. [Figure 10-18] The station circle represents the head of the arrow, with the arrow pointing in the direction from which the wind is blowing. Winds are described by the direction from which they blow, thus a northwest wind means that the wind is blowing from the northwest toward the southeast. The speed of the wind is depicted by bars

or pennants placed on the wind line. Each barb represents a speed of 10 knots, while half a barb is equal to 5 knots and a pennant is equal to 50 knots.

The pressure for each station is recorded on the weather chart and is shown in millibars. **Isobars** are lines drawn on the chart to depict areas of equal pressure. These lines result in a pattern that reveals the pressure gradient or change in pressure over distance. [Figure 10-19] Isobars are similar to contour lines on a topographic map that indicate terrain altitudes and slope steepness. For example, isobars that are closely spaced indicate a steep wind gradient and strong winds prevail. Shallow gradients, on the other hand, are represented by isobars that are spaced far apart, and are indicative of light winds. Isobars help identify low- and high-pressure systems as well as the location of ridges, troughs, and cols. A high is an area of high pressure

**Isobars**—Lines which connect points of equal barometric pressure.

Examples of wind speed and direction plots		
Calm 	NW / 5 kts 	SW / 20 kts 
E / 35 kts 	N / 50 kts 	W / 105 kts 

Figure 10-18. Depiction of winds on a surface weather chart.

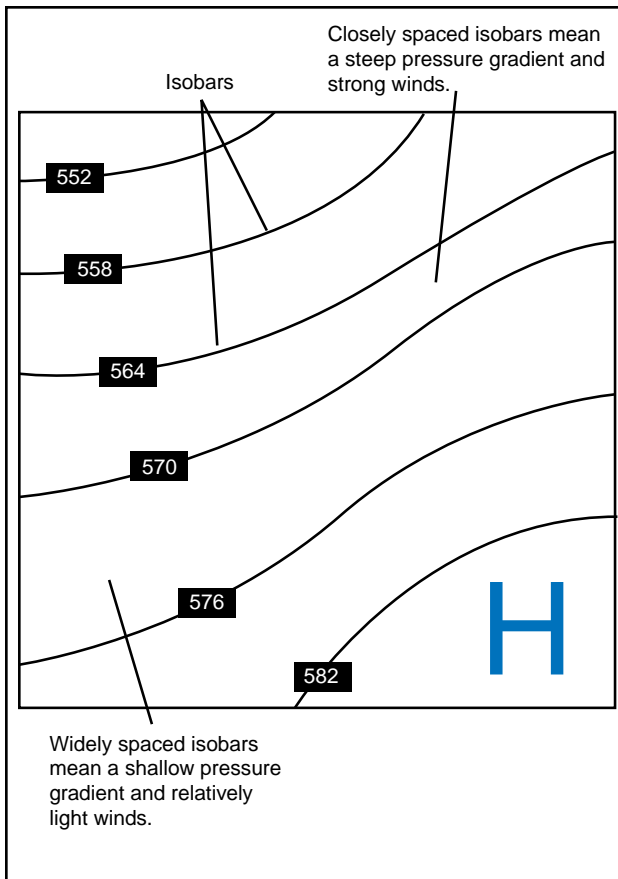

**Figure 10-19. Isobars reveal the pressure gradient of an area of high- or low-pressure areas.**

surrounded by lower pressure; a low is an area of low pressure surrounded by higher pressure. A ridge is an elongated area of high pressure, and a trough is an elongated area of low pressure. A col is the intersection between a ridge and a trough, or an area of neutrality between two highs or two lows.

Isobars furnish valuable information about winds in the first few thousand feet above the surface. Close to the ground, wind direction is modified by the surface and windspeed decreases due to friction with the surface. At levels 2,000 to 3,000 feet above the surface, however, the speed is greater and the direction becomes more parallel to the isobars. Therefore, the surface winds are shown on the weather map as well as the winds at a slightly higher altitude.

Generally, the wind 2,000 feet above the ground will be 20° to 40° to the right of surface winds, and the wind-speed will be greater. The change of wind direction is greatest over rough terrain and least over flat surfaces, such as open water. In the absence of winds aloft information, this rule of thumb allows for a rough estimate of the wind conditions a few thousand feet above the surface.

## ATMOSPHERIC STABILITY

The stability of the atmosphere depends on its ability to resist vertical motion. A stable atmosphere makes vertical movement difficult, and small vertical disturbances dampen out and disappear. In an unstable atmosphere, small vertical air movements tend to become larger, resulting in turbulent airflow and convective activity. Instability can lead to significant turbulence, extensive vertical clouds, and severe weather.

Rising air expands and cools due to the decrease in air pressure as altitude increases. The opposite is true of descending air; as atmospheric pressure increases, the temperature of descending air increases as it is compressed. **Adiabatic heating**, or **adiabatic cooling**, are the terms used to describe this temperature change.

The adiabatic process takes place in all upward and downward moving air. When air rises into an area of lower pressure, it expands to a larger volume. As the molecules of air expand, the temperature of the air lowers. As a result, when a parcel of air rises, pressure decreases, volume increases, and temperature decreases. When air descends, the opposite is true. The rate at which temperature decreases with an increase in altitude is referred to as its lapse rate. As air ascends through the atmosphere, the average rate of temperature change is 2°C (3.5°F) per 1,000 feet.

Since water vapor is lighter than air, moisture decreases air density, causing it to rise. Conversely, as moisture decreases, air becomes denser and tends to sink. Since moist air cools at a slower rate, it is generally less stable than dry air since the moist air must rise higher before its temperature cools to that of the surrounding air. The dry adiabatic lapse rate (unsaturated air) is 3°C (5.4°F) per 1,000 feet. The moist adiabatic lapse rate varies from 1.1°C to 2.8°C (2°F to 5°F) per 1,000 feet.

The combination of moisture and temperature determine the stability of the air and the resulting weather. Cool, dry air is very stable and resists vertical movement, which leads to good and generally clear weather. The greatest instability occurs when the air is moist and warm, as it is in the tropical regions in the summer. Typically, thunderstorms appear on a daily basis in these regions due to the instability of the surrounding air.

**Adiabatic heating**—A process of heating dry air through compression. As air moves downward it is compressed, resulting in a temperature increase.

**Adiabatic cooling**—A process of cooling the air through expansion. For example, as air moves upward, it expands with the reduction of atmospheric pressure and cools as it expands.

## INVERSION

As air rises and expands in the atmosphere, the temperature decreases. There is an atmospheric anomaly that can occur, however, that changes this typical pattern of atmospheric behavior. When the temperature of the air rises with altitude, a temperature inversion exists. **Inversion** layers are commonly shallow layers of smooth, stable air close to the ground. The temperature of the air increases with altitude to a certain point, which is the top of the inversion. The air at the top of the layer acts as a lid, keeping weather and pollutants trapped below. If the relative humidity of the air is high, it can contribute to the formation of clouds, fog, haze, or smoke, resulting in diminished visibility in the inversion layer.

Surface based temperature inversions occur on clear, cool nights when the air close to the ground is cooled by the lowering temperature of the ground. The air within a few hundred feet of the surface becomes cooler than the air above it. Frontal inversions occur when warm air spreads over a layer of cooler air, or cooler air is forced under a layer of warmer air.

## MOISTURE AND TEMPERATURE

The atmosphere, by nature, contains moisture in the form of water vapor. The amount of moisture present in the atmosphere is dependent upon the temperature of the air. Every 20°F increase in temperature doubles the amount of moisture the air can hold. Conversely, a decrease of 20°F cuts the capacity in half.

Water is present in the atmosphere in three states: liquid, solid, and gaseous. All three forms can readily change to another, and all are present within the temperature ranges of the atmosphere. As water changes from one state to another, an exchange of heat takes place. These changes occur through the processes of **evaporation**, **sublimation**, **condensation**, **deposition**, melting, or freezing. However, water vapor is added into the atmosphere only by the processes of evaporation and sublimation.

Evaporation is the changing of liquid water to water vapor. As water vapor forms, it absorbs heat from the nearest available source. This heat exchange is known as the latent heat of evaporation. A good example of this is when the body's perspiration evaporates. The net effect is a cooling sensation as heat is extracted from the body. Similarly, sublimation is the changing of ice directly to water vapor, completely bypassing the liquid stage. Though dry ice is not made of water, but rather carbon dioxide, it demonstrates the principle of sublimation, when a solid turns directly into vapor.

## RELATIVE HUMIDITY

Humidity refers to the amount of water vapor present in the atmosphere at a given time. Relative humidity is

the actual amount of moisture in the air compared to the total amount of moisture the air could hold at that temperature. For example, if the current relative humidity is 65 percent, the air is holding 65 percent of the total amount of moisture that it is capable of holding at that temperature and pressure. While much of the western United States rarely sees days of high humidity, relative humidity readings of 75 to 90 percent are not uncommon in the southern United States during warmer months. [Figure 10-20]

## TEMPERATURE/DEWPOINT RELATIONSHIP

The relationship between **dewpoint** and temperature defines the concept of relative humidity. The dewpoint, given in degrees, is the temperature at which the air can hold no more moisture. When the temperature of the air is reduced to the dewpoint, the air is completely saturated and moisture begins to condense out of the air in the form of fog, dew, frost, clouds, rain, hail, or snow.

As moist, unstable air rises, clouds often form at the altitude where temperature and dewpoint reach the same value. When lifted, unsaturated air cools at a rate of 5.4°F per 1,000 feet and the dewpoint temperature decreases at a rate of 1°F per 1,000 feet. This results in a convergence of temperature and dewpoint at a rate of 4.4°F. Apply the convergence rate to the reported temperature and dewpoint to determine the height of the cloud base.

### Given:

$$\text{Temperature (T)} = 85^{\circ}\text{F}$$

$$\text{Dewpoint (DP)} = 71^{\circ}\text{F}$$

$$\text{Convergence Rate (CR)} = 4.4^{\circ}$$

$$\text{T} - \text{DP} = \text{Temperature Dewpoint Spread (TDS)}$$

$$\text{TDS} \div \text{CR} = \text{X}$$

$$\text{X} \times 1,000 \text{ feet} = \text{height of cloud base AGL}$$

### Example:

$$85^{\circ}\text{F} - 71^{\circ}\text{F} = 14^{\circ}\text{F}$$

$$14^{\circ}\text{F} \div 4.4^{\circ}\text{F} = 3.18$$

$$3.18 \times 1,000 = 3,180 \text{ feet AGL}$$

The height of the cloud base is 3,180 feet AGL.

**Inversion**—An increase in temperature with altitude.

**Evaporation**—The transformation of a liquid to a gaseous state, such as the change of water to water vapor.

**Sublimation**—Process by which a solid is changed to a gas without going through the liquid state.

**Condensation**—A change of state of water from a gas (water vapor) to a liquid.

**Deposition**—The direct transformation of a gas to a solid state, in which the liquid state is bypassed. Some sources use the term sublimation to describe this process instead of deposition.

**Dewpoint**—The temperature at which air reaches a state where it can hold no more water.



## AT SEA LEVEL PRESSURE, AIR CAN HOLD

9 grams H<sub>2</sub>O/Cubic Meter of Air at 10°C  
17 grams H<sub>2</sub>O/Cubic Meter of Air at 20°C  
30 grams H<sub>2</sub>O/Cubic Meter of Air at 30°C

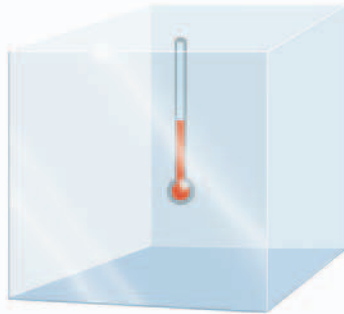

A cubic meter of air with 17g of water vapor at 20°C is at saturation, or 100% relative humidity. Any further cooling will cause condensation (fog, clouds, dew) to form. Thus, 20°C is the dewpoint for this situation.

If the temperature is lowered to 10°C, the air can only hold 9g of water vapor, and 8g of water will condense as water droplets. The relative humidity will still be at 100%.

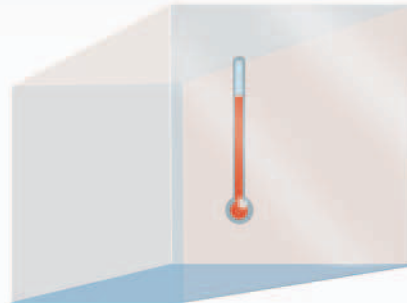

If the same cubic meter of air warms to 30°C, the 17g of water vapor will produce a relative humidity of 56%. (17g is 56% of the 30g the air could hold at this temperature.)

Figure 10-20. The relationship between relative humidity, temperature, and dewpoint.

### Explanation:

With an outside air temperature (OAT) of 85°F at the surface, and dewpoint at the surface of 71°F, the spread is 14°. Divide the temperature dewpoint spread by the convergence rate of 4.4°F, and multiply by 1,000 to determine the approximate height of the cloud base.

### METHODS BY WHICH AIR REACHES THE SATURATION POINT

If air reaches the saturation point while temperature and dewpoint are close together, it is highly likely that fog, low clouds, and precipitation will form. There are four methods by which air can reach the complete saturation point. First, when warm air moves over a cold surface, the air's temperature drops and reaches the saturation point. Second, the saturation point may be reached when cold air and warm air mix. Third, when air cools at night through contact with the cooler ground, air reaches its saturation point. The fourth method occurs when air is lifted or is forced upward in the atmosphere.

As air rises, it uses heat energy to expand. As a result, the rising air loses heat rapidly. Unsaturated air loses heat at a rate of 3.0°C (5.4°F) for every 1,000 feet of

altitude gain. No matter what causes the air to reach its saturation point, saturated air brings clouds, rain, and other critical weather situations.

### DEW AND FROST

On cool, calm nights, the temperature of the ground and objects on the surface can cause temperatures of the surrounding air to drop below the dewpoint. When this occurs, the moisture in the air condenses and deposits itself on the ground, buildings, and other objects like cars and aircraft. This moisture is known as dew and sometimes can be seen on grass in the morning. If the temperature is below freezing, the moisture will be deposited in the form of frost. While dew poses no threat to an aircraft, frost poses a definite flight safety hazard. Frost disrupts the flow of air over the wing and can drastically reduce the production of lift. It also increases drag, which, when combined with lowered lift production, can eliminate the ability to take off. An aircraft must be thoroughly cleaned and free of frost prior to beginning a flight.

### FOG

Fog, by definition, is a cloud that begins within 50 feet of the surface. It typically occurs when the temperature of air near the ground is cooled to the air's dewpoint.

At this point, water vapor in the air condenses and becomes visible in the form of fog. Fog is classified according to the manner in which it forms and is dependent upon the current temperature and the amount of water vapor in the air.

On clear nights, with relatively little to no wind present, radiation fog may develop. [Figure 10-21] Usually, it forms in low-lying areas like mountain valleys. This type of fog occurs when the ground cools rapidly due to terrestrial radiation, and the surrounding air temperature reaches its dewpoint. As the sun rises and the temperature increases, radiation fog will lift and eventually burn off. Any increase in wind will also speed the dissipation of radiation fog. If radiation fog is less than 20 feet thick, it is known as ground fog.



Figure 10-21. Radiation fog.

When a layer of warm, moist air moves over a cold surface, advection fog is likely to occur. Unlike radiation fog, wind is required to form advection fog. Winds of up to 15 knots allow the fog to form and intensify; above a speed of 15 knots, the fog usually lifts and forms low stratus clouds. Advection fog is common in coastal areas where sea breezes can blow the air over cooler landmasses.

In these same coastal areas, upslope fog is likely as well. Upslope fog occurs when moist, stable air is forced up sloping land features like a mountain range. This type of fog also requires wind for formation and continued existence. Upslope and advection fog, unlike radiation fog, may not burn off with the morning sun, but instead can persist for days. They also can extend to greater heights than radiation fog.

Steam fog, or sea smoke, forms when cold, dry air moves over warm water. As the water evaporates, it rises and resembles smoke. This type of fog is common over bodies of water during the coldest times of the year. Low-level turbulence and icing are commonly associated with steam fog.

Ice fog occurs in cold weather when the temperature is much below freezing and water vapor forms directly into ice crystals. Conditions favorable for its formation are the same as for radiation fog except for cold temperature, usually  $-25^{\circ}\text{F}$  or colder. It occurs mostly in the arctic regions, but is not unknown in middle latitudes during the cold season.

## CLOUDS

Clouds are visible indicators and are often indicative of future weather. For clouds to form, there must be adequate water vapor and condensation nuclei, as well as a method by which the air can be cooled. When the air cools and reaches its saturation point, the invisible water vapor changes into a visible state. Through the processes of deposition (also referred to as sublimation) and condensation, moisture condenses or sublimates onto miniscule particles of matter like dust, salt, and smoke known as **condensation nuclei**. The nuclei are important because they provide a means for the moisture to change from one state to another.

Cloud type is determined by its height, shape, and behavior. They are classified according to the height of their bases as low, middle, or high clouds, as well as clouds with vertical development. [Figure 10-22]

Low clouds are those that form near the Earth's surface and extend up to 6,500 feet AGL. They are made primarily of water droplets, but can include supercooled water droplets that induce hazardous aircraft icing. Typical low clouds are stratus, stratocumulus, and nimbostratus. Fog is also classified as a type of low cloud formation. Clouds in this family create low ceilings, hamper visibility, and can change rapidly. Because of this, they influence flight planning and can make VFR flight impossible.

Middle clouds form around 6,500 feet AGL and extend up to 20,000 feet AGL. They are composed of water, ice crystals, and **supercooled water droplets**. Typical middle-level clouds include altostratus and altocumulus. These types of clouds may be encountered on cross-country flights at higher altitudes. Altostratus clouds can produce turbulence and may contain moderate icing. Altocumulus clouds, which usually form when altostratus clouds are breaking apart, also may contain light turbulence and icing.

**Condensation Nuclei**—Small particles of solid matter in the air on which water vapor condenses.

**Supercooled Water Droplets**—Water droplets that have been cooled below the freezing point, but are still in a liquid state.

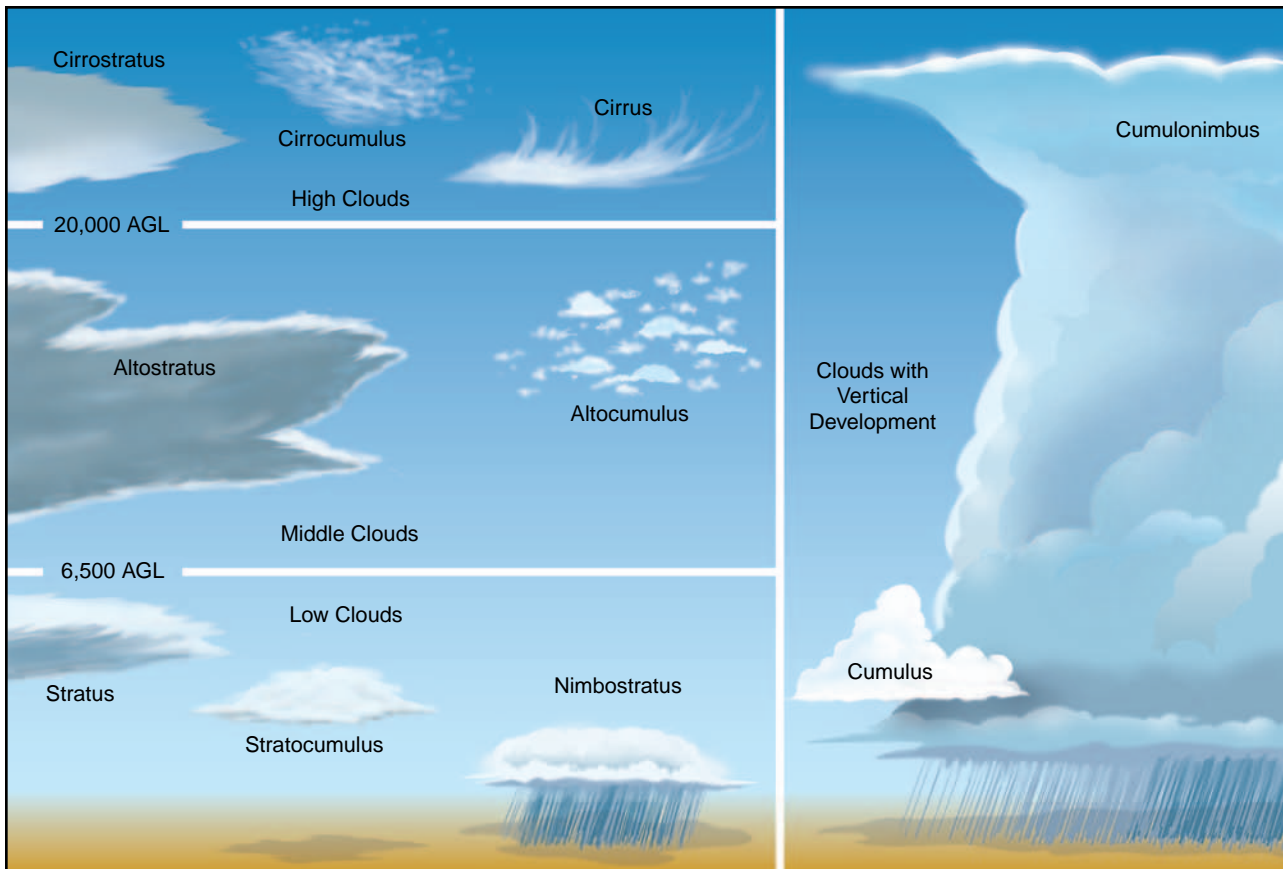

Figure 10-22. Basic cloud types.

High clouds form above 20,000 feet AGL and usually form only in stable air. They are made up of ice crystals and pose no real threat of turbulence or aircraft icing. Typical high-level clouds are cirrus, cirrostratus, and cirrocumulus.

Clouds with extensive vertical development are cumulus clouds that build vertically into towering cumulus or cumulonimbus clouds. The bases of these clouds form in the low to middle cloud base region but can extend into high altitude cloud levels. Towering cumulus clouds indicate areas of instability in the atmosphere, and the air around and inside them is turbulent. These types of clouds often develop into cumulonimbus clouds or thunderstorms. Cumulonimbus clouds contain large amounts of moisture and unstable air, and usually produce hazardous weather phenomena such as lightning, hail, tornadoes, gusty winds, and wind shear. These extensive vertical clouds can be obscured by other cloud formations and are not always visible from the ground or while in flight. When this happens, these clouds are said to be embedded, hence the term, embedded thunderstorms.

Cloud classification can be further broken down into specific cloud types according to the outward

appearance and cloud composition. Knowing these terms can help identify visible clouds.

The following is a list of cloud classifications:

- Cumulus—Heaped or piled clouds.
- Stratus—Formed in layers.
- Cirrus—Ringlets; fibrous clouds; also high-level clouds above 20,000 feet.
- Castellanus—Common base with separate vertical development; castle-like.
- Lenticularus—Lens shaped; formed over mountains in strong winds.
- Nimbus—Rain bearing clouds.
- Fracto—Ragged or broken.
- Alto—Meaning high; also middle-level clouds existing at 5,000 to 20,000 feet.

To pilots, the cumulonimbus cloud is perhaps the most dangerous cloud type. It appears individually or in groups and is known as either an air mass or orographic thunderstorm. Heating of the air near the Earth's surface creates an air mass thunderstorm; the upslope

motion of air in the mountainous regions causes orographic thunderstorms. Cumulonimbus clouds that form in a continuous line are nonfrontal bands of thunderstorms or squall lines.

Since rising air currents cause cumulonimbus clouds, they are extremely turbulent and pose a significant hazard to flight safety. For example, if an aircraft enters a thunderstorm, the aircraft could experience updrafts and downdrafts that exceed 3,000 feet per minute. In addition, thunderstorms can produce large hailstones, damaging lightning, tornadoes, and large quantities of water, all of which are potentially hazardous to aircraft.

A thunderstorm makes its way through three distinct stages before dissipating. It begins with the cumulus stage, in which lifting action of the air begins. If sufficient moisture and instability are present, the clouds continue to increase in vertical height. Continuous, strong updrafts prohibit moisture from falling. The updraft region grows larger than the individual thermals feeding the storm. Within approximately 15 minutes, the thunderstorm reaches the mature stage, which is the most violent time period of the thunderstorm's life cycle. At this point, drops of moisture, whether rain or ice, are too heavy for the cloud to support and begin falling in the form of rain or hail. This creates a downward motion of the air. Warm, rising air; cool, precipitation-induced descending air; and violent turbulence all exist within and near the cloud. Below the cloud, the down-rushing air increases surface winds and decreases the temperature. Once the

vertical motion near the top of the cloud slows down, the top of the cloud spreads out and takes on an anvil-like shape. At this point, the storm enters the dissipating stage. This is when the downdrafts spread out and replace the updrafts needed to sustain the storm. [Figure 10-23]

It is impossible to fly over thunderstorms in light aircraft. Severe thunderstorms can punch through the tropopause and reach staggering heights of 50,000 to 60,000 feet depending on latitude. Flying under thunderstorms can subject aircraft to rain, hail, damaging lightning, and violent turbulence. A good rule of thumb is to circumnavigate thunderstorms by at least 5 nautical miles (NM) since hail may fall for miles outside of the clouds. If flying around a thunderstorm is not an option, stay on the ground until it passes.

### CEILING

A **ceiling**, for aviation purposes, is the lowest layer of clouds reported as being broken or overcast, or the vertical visibility into an obscuration like fog or haze. Clouds are reported as broken when five-eighths to seven-eighths of the sky is covered with clouds. Overcast means the entire sky is covered with clouds. Current ceiling information is reported by the aviation routine weather report (METAR) and automated weather stations of various types.

**Ceiling**—The height above the Earth's surface of the lowest layer of clouds reported as broken or overcast, or the vertical visibility into an obscuration.

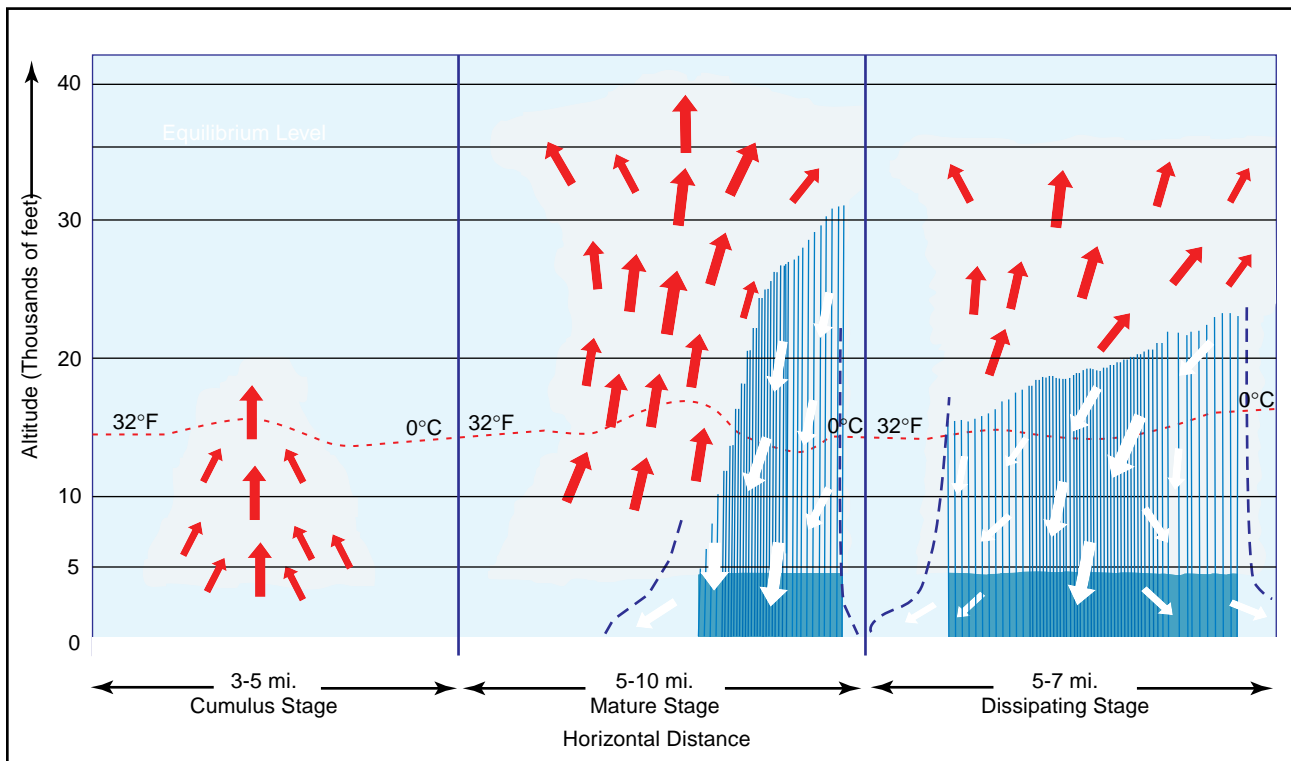

Figure 10-23. Life cycle of a thunderstorm.

## VISIBILITY

Closely related to cloud cover and reported ceilings is visibility information. Visibility refers to the greatest horizontal distance at which prominent objects can be viewed with the naked eye. Current visibility is also reported in METAR and other aviation weather reports, as well as automated weather stations. Visibility information, as predicted by meteorologists, is available during a preflight weather briefing.

## PRECIPITATION

Precipitation refers to any form of water particles that form in the atmosphere and fall to the ground. It has a profound impact on flight safety. Depending on the form of precipitation, it can reduce visibility, create icing situations, and affect landing and takeoff performance of an aircraft.

Precipitation occurs because water or ice particles in clouds grow in size until the atmosphere can no longer support them. It can occur in several forms as it falls toward the Earth, including drizzle, rain, ice pellets, hail, and ice.

Drizzle is classified as very small water droplets, smaller than 0.02 inches in diameter. Drizzle usually accompanies fog or low stratus clouds. Water droplets of larger size are referred to as rain. Rain that falls through the atmosphere but evaporates prior to striking the ground is known as virga. Freezing rain and freezing drizzle occur when the temperature of the surface is below freezing; the rain freezes on contact with the cooler surface.

If rain falls through a temperature inversion, it may freeze as it passes through the underlying cold air and fall to the ground in the form of ice pellets. Ice pellets are an indication of a temperature inversion and that freezing rain exists at a higher altitude. In the case of hail, freezing water droplets are carried up and down by drafts inside clouds, growing larger in size as they come in contact with more moisture. Once the updrafts can no longer hold the freezing water, it falls to the Earth in the form of hail. Hail can be pea-sized, or it can grow as large as 5 inches in diameter, larger than a softball.

Snow is precipitation in the form of ice crystals that falls at a steady rate or in snow showers that begin, change in intensity, and end rapidly. Falling snow also varies in size, being very small grains or large flakes. Snow grains are the equivalent of drizzle in size.

Precipitation in any form poses a threat to safety of flight. Often, precipitation is accompanied by low ceilings and reduced visibility. Aircraft that have ice, snow, or frost on their surfaces must be carefully

cleaned prior to beginning a flight because of the possible airflow disruption and loss of lift. Rain can contribute to water in the fuel tanks. Precipitation can create hazards on the runway surface itself, making takeoffs and landings difficult, if not impossible, due to snow, ice, or pooling water and very slick surfaces.

## AIR MASSES

Air masses are large bodies of air that take on the characteristics of the surrounding area, or source region. A source region is typically an area in which the air remains relatively stagnant for a period of days or longer. During this time of stagnation, the **air mass** takes on the temperature and moisture characteristics of the source region. Areas of stagnation can be found in polar regions, tropical oceans, and dry deserts. Air masses are classified based on their region of origination:

- Polar or Tropical
- Maritime or Continental

A continental polar air mass forms over a polar region and brings cool, dry air with it. Maritime tropical air masses form over warm tropical waters like the Caribbean Sea and bring warm, moist air. As the air mass moves from its source region and passes over land or water, the air mass is subjected to the varying conditions of the land or water, and these modify the nature of the air mass. [Figure 10-24]

An air mass passing over a warmer surface will be warmed from below, and convective currents form, causing the air to rise. This creates an unstable air mass with good surface visibility. Moist, unstable air causes cumulus clouds, showers, and turbulence to form. Conversely, an air mass passing over a colder surface does not form convective currents, but instead creates a stable air mass with poor surface visibility. The poor surface visibility is due to the fact that smoke, dust, and other particles cannot rise out of the air mass and are instead trapped near the surface. A stable air mass can produce low stratus clouds and fog.

## FRONTS

As air masses move across bodies of water and land, they eventually come in contact with another air mass with different characteristics. The boundary layer between two types of air masses is known as a front. An approaching front of any type always means changes to the weather are imminent.

**Air Mass**—An extensive body of air having fairly uniform properties of temperature and moisture.

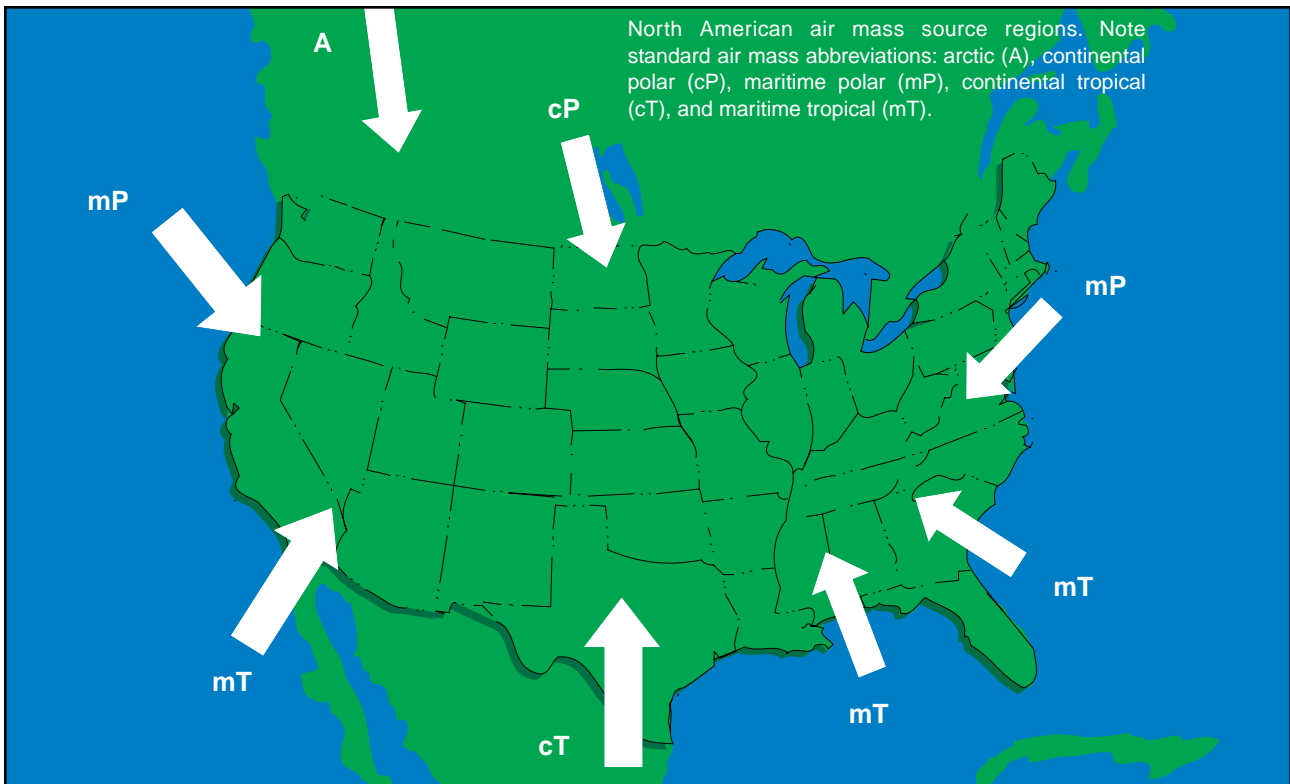

Figure 10-24. Air mass source regions.

There are four types of fronts, which are named according to the temperature of the advancing air as it relates to the temperature of the air it is replacing. [Figure 10-25]

- Warm Front
- Cold Front
- Stationary Front
- Occluded Front

Any discussion of frontal systems must be tempered with the knowledge that no two fronts are the same. However, generalized weather conditions are associated with a specific type of front that helps identify the front.

**WARM FRONT**

A **warm front** occurs when a warm mass of air advances and replaces a body of colder air. Warm fronts move slowly, typically 10 to 25 miles per hour (m.p.h.). The slope of the advancing front slides over the top of the cooler air and gradually pushes it out of the area. Warm fronts contain warm air that often has very high humidity. As the warm air is lifted, the temperature drops and condensation occurs.

**Warm Front**—The boundary between two air masses where warm air is replacing cold air.

Generally, prior to the passage of a warm front, cirriform or stratiform clouds, along with fog, can be expected to form along the frontal boundary. In the summer months, cumulonimbus clouds (thunderstorms) are likely to develop. Light to moderate precipitation is probable, usually in the form of rain, sleet, snow, or drizzle, punctuated by poor visibility. The wind blows from the south-southeast, and the outside temperature is cool or cold, with increasing dewpoint. Finally, as the warm front approaches, the barometric pressure continues to fall until the front passes completely.

Table A	
<b>Symbols for Surface Fronts and Other Significant Lines Shown on the Surface Analysis Chart</b>	
	Warm Front (red)*
	Cold Front (blue)*
	Stationary Front (red/blue)*
	Occluded Front (purple)*
* Note : Fronts may be black and white or color, depending on their source. Also, fronts shown in color code will not necessarily show frontal symbols.	

Figure 10-25. Common chart symbology to depict weather front location.

During the passage of a warm front, stratiform clouds are visible and drizzle may be falling. The visibility is generally poor, but improves with variable winds. The temperature rises steadily from the inflow of relatively warmer air. For the most part, the dewpoint remains steady and the pressure levels off.

After the passage of a warm front, stratocumulus clouds predominate and rain showers are possible. The visibility eventually improves, but hazy conditions may exist for a short period after passage. The wind blows from the south-southwest. With warming temperatures, the dewpoint rises and then levels off. There is generally a slight rise in barometric pressure, followed by a decrease of barometric pressure.

### FLIGHT TOWARD AN APPROACHING WARM FRONT

By studying a typical warm front, much can be learned about the general patterns and atmospheric conditions that exist when a warm front is encountered in flight. Figure 10-26 depicts a warm front advancing eastward from St. Louis, Missouri, toward Pittsburgh, Pennsylvania.

At the time of departure from Pittsburgh, the weather is good VFR with a scattered layer of cirrus clouds at 15,000 feet. As the flight progresses westward to Columbus and closer to the oncoming warm front, the

clouds deepen and become increasingly stratiform in appearance with a ceiling of 6,000 feet. The visibility decreases to 6 miles in haze with a falling barometric pressure. Approaching Indianapolis, the weather deteriorates to broken clouds at 2,000 feet with 3 miles visibility and rain. With the temperature and dewpoint the same, fog is likely. At St. Louis, the sky is overcast with low clouds and drizzle and the visibility is 1 mile. Beyond Indianapolis, the ceiling and visibility would be too low to continue VFR. Therefore, it would be wise to remain in Indianapolis until the warm front had passed, which might require a day or two.

### COLD FRONT

A **cold front** occurs when a mass of cold, dense, and stable air advances and replaces a body of warmer air. Cold fronts move more rapidly than warm fronts, progressing at a rate of 25 to 30 m.p.h. However, extreme cold fronts have been recorded moving at speeds of up to 60 m.p.h. A typical cold front moves in a manner opposite that of a warm front; because it is so dense, it stays close to the ground and acts like a snowplow, sliding under the warmer air and forcing the less dense air aloft. The rapidly ascending air causes

**Cold Front**—The boundary between two air masses where cold air is replacing warm air.

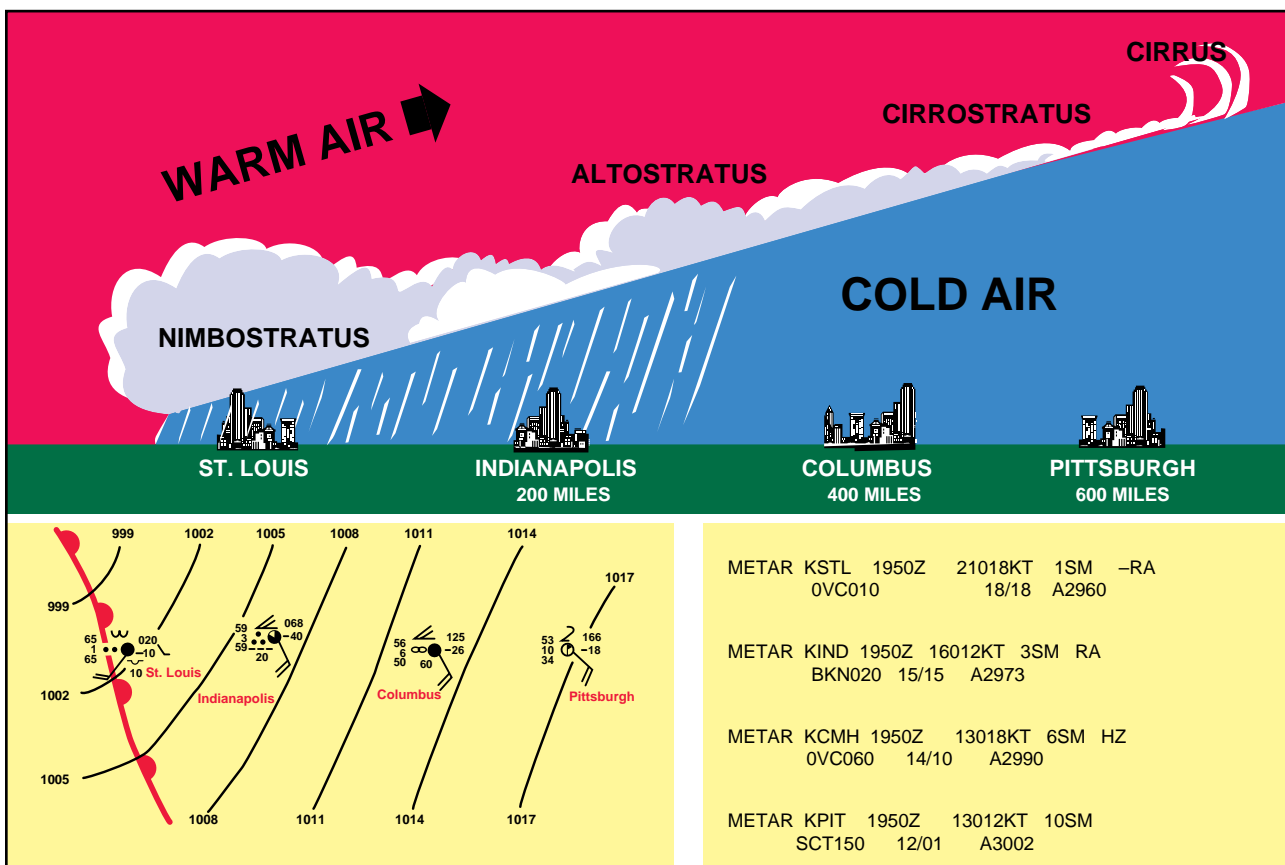

Figure 10-26. Warm front cross-section with surface weather chart depiction and associated METAR.

the temperature to decrease suddenly, forcing the creation of clouds. The type of clouds that form depends on the stability of the warmer air mass. A cold front in the Northern Hemisphere is normally oriented in a northeast to southwest manner and can be several hundred miles long, encompassing a large area of land.

Prior to the passage of a typical cold front, cirriform or towering cumulus clouds are present, and cumulonimbus clouds are possible. Rain showers and haze are possible due to the rapid development of clouds. The wind from the south-southwest helps to replace the warm temperatures with the relative colder air. A high dewpoint and falling barometric pressure are indicative of imminent cold front passage.

As the cold front passes, towering cumulus or cumulonimbus clouds continue to dominate the sky. Depending on the intensity of the cold front, heavy rain showers form and might be accompanied by lightning, thunder, and/or hail. More severe cold fronts can also produce tornadoes. During cold front passage, the visibility will be poor, with winds variable and gusty, and the temperature and dewpoint drop rapidly. A quickly falling barometric pressure bottoms out during frontal passage, then begins a gradual increase.

After frontal passage, the towering cumulus and cumulonimbus clouds begin to dissipate to cumulus clouds with a corresponding decrease in the precipitation. Good visibility eventually prevails with the winds from the west-northwest. Temperatures remain cooler and the barometric pressure continues to rise.

### **FAST-MOVING COLD FRONT**

Fast-moving cold fronts are pushed by intense pressure systems far behind the actual front. The friction between the ground and the cold front retards the movement of the front and creates a steeper frontal surface. This results in a very narrow band of weather, concentrated along the leading edge of the front. If the warm air being overtaken by the cold front is relatively stable, overcast skies and rain may occur for some distance ahead of the front. If the warm air is unstable, scattered thunderstorms and rain showers may form. A continuous line of thunderstorms, or a squall line, may form along or ahead of the front. Squall lines present a serious hazard to pilots as squall type thunderstorms are intense and move quickly. Behind a fast moving cold front, the skies usually clear rapidly and the front leaves behind gusty, turbulent winds and colder temperatures.

### **FLIGHT TOWARD AN APPROACHING COLD FRONT**

Like warm fronts, not all cold fronts are the same. Examining a flight toward an approaching cold front,

pilots can get a better understanding of the type of conditions that can be encountered in flight. Figure 10-27 shows a flight from Pittsburgh, Pennsylvania, toward St. Louis, Missouri.

At the time of departure from Pittsburgh, the weather is VFR with 3 miles visibility in smoke and a scattered layer of clouds at 3,500 feet. As the flight progresses westward to Columbus and closer to the oncoming cold front, the clouds show signs of vertical development with a broken layer at 2,500 feet. The visibility is 6 miles in haze with a falling barometric pressure. Approaching Indianapolis, the weather has deteriorated to overcast clouds at 1,000 feet, and 3 miles visibility with thunderstorms and heavy rain showers. At St. Louis, the weather gets better with scattered clouds at 1,000 feet and a 10 mile visibility.

A pilot using sound judgment based on the knowledge of frontal conditions, would most likely remain in Indianapolis until the front had passed. Trying to fly below a line of thunderstorms or a squall line is hazardous and foolish, and flight over the top of or around the storm is not an option. Thunderstorms can extend up to well over the capability of small airplanes and can extend in a line for 300 to 500 miles.

### **COMPARISON OF COLD AND WARM FRONTS**

Warm fronts and cold fronts are very different in nature as are the hazards associated with each front. They vary in speed, composition, weather phenomenon, and prediction. Cold fronts, which move at 20 to 35 m.p.h., move very quickly in comparison to warm fronts, which move at only 10 to 25 m.p.h. Cold fronts also possess a steeper frontal slope. Violent weather activity is associated with cold fronts and the weather usually occurs along the frontal boundary, not in advance. However, squall lines can form during the summer months as far as 200 miles in advance of a severe cold front. Whereas warm fronts bring low ceilings, poor visibility, and rain, cold fronts bring sudden storms, gusty winds, turbulence, and sometimes hail or tornadoes.

Cold fronts are fast approaching with little or no warning, and they make a complete weather change in just a few hours. The weather clears rapidly after passage and drier air with unlimited visibilities prevail. Warm fronts, on the other hand, provide advance warning of their approach and can take days to pass through a region.

### **WIND SHIFTS**

Wind around a high-pressure system rotates in a clockwise fashion, while low-pressure winds rotate in a counter-clockwise manner. When two high-pressure systems are adjacent, the winds are almost in direct



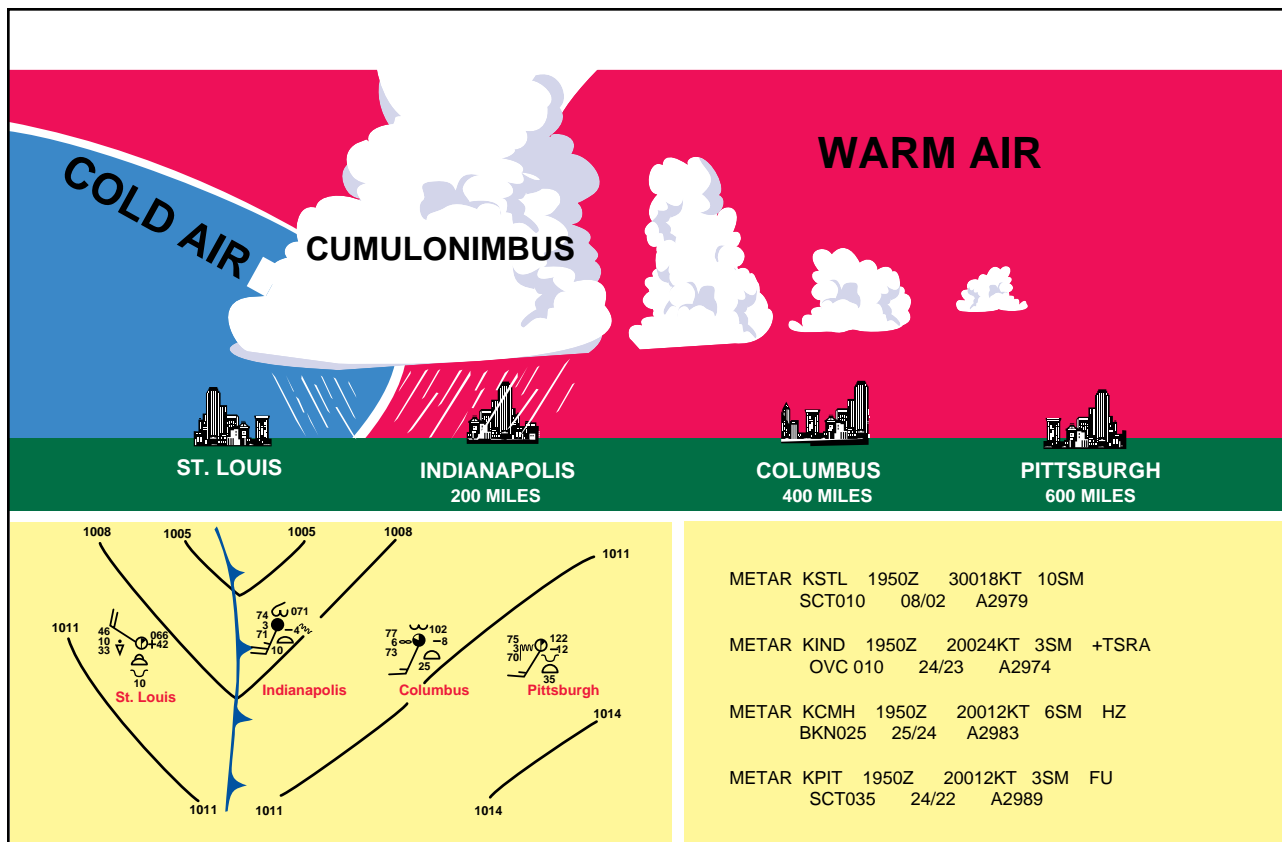

Figure 10-27. Cold front cross-section with surface weather chart depiction and associated METAR.

opposition to each other at the point of contact. Fronts are the boundaries between two areas of pressure, and therefore, wind shifts are continually occurring within a front. Shifting wind direction is most pronounced in conjunction with cold fronts.

### STATIONARY FRONT

When the forces of two air masses are relatively equal, the boundary or front that separates them remains stationary and influences the local weather for days. This front is called a **stationary front**. The weather associated with a stationary front is typically a mixture that can be found in both warm and cold fronts.

### OCCLUDED FRONT

An **occluded front** occurs when a fast-moving cold front catches up with a slow-moving warm front. As the occluded front approaches, warm front weather prevails, but is immediately followed by cold front weather. There are two types of occluded fronts that can occur, and the temperatures of the colliding frontal systems play a large part in defining the type of front and the resulting weather. A cold front occlusion occurs when a fast-moving cold front is colder than the air ahead of the slow-moving warm front. When this occurs, the cold air replaces the cool air and forces the warm front aloft into the atmosphere. Typically, the cold front occlusion creates a mixture of weather found in both warm and cold fronts, providing the air is

relatively stable. A warm front occlusion occurs when the air ahead of the warm front is colder than the air of the cold front. When this is the case, the cold front rides up and over the warm front. If the air forced aloft by the warm front occlusion is unstable, the weather will be more severe than the weather found in a cold front occlusion. Embedded thunderstorms, rain, and fog are likely to occur.

Figure 10-28 depicts a cross-section of a typical cold front occlusion. The warm front slopes over the prevailing cooler air and produces the warm front type weather. Prior to the passage of the typical occluded front, cirriform and stratiform clouds prevail, light to heavy precipitation is falling, visibility is poor, dewpoint is steady, and barometric pressure is falling. During the passage of the front, nimbostratus and cumulonimbus clouds predominate, and towering cumulus may also be possible. Light to heavy precipitation is falling, visibility is poor, winds are variable, and the barometric pressure is leveling off. After the passage of the front, nimbostratus and altostratus clouds are visible, precipitation is decreasing and clearing, and visibility is improving.

**Stationary Front**—A boundary between two air masses that are relatively balanced.

**Occluded Front**—A frontal occlusion occurs when a fast-moving cold front catches up with a slow-moving warm front. The difference in temperature within each frontal system is a major factor in determining whether a cold or warm front occlusion occurs.

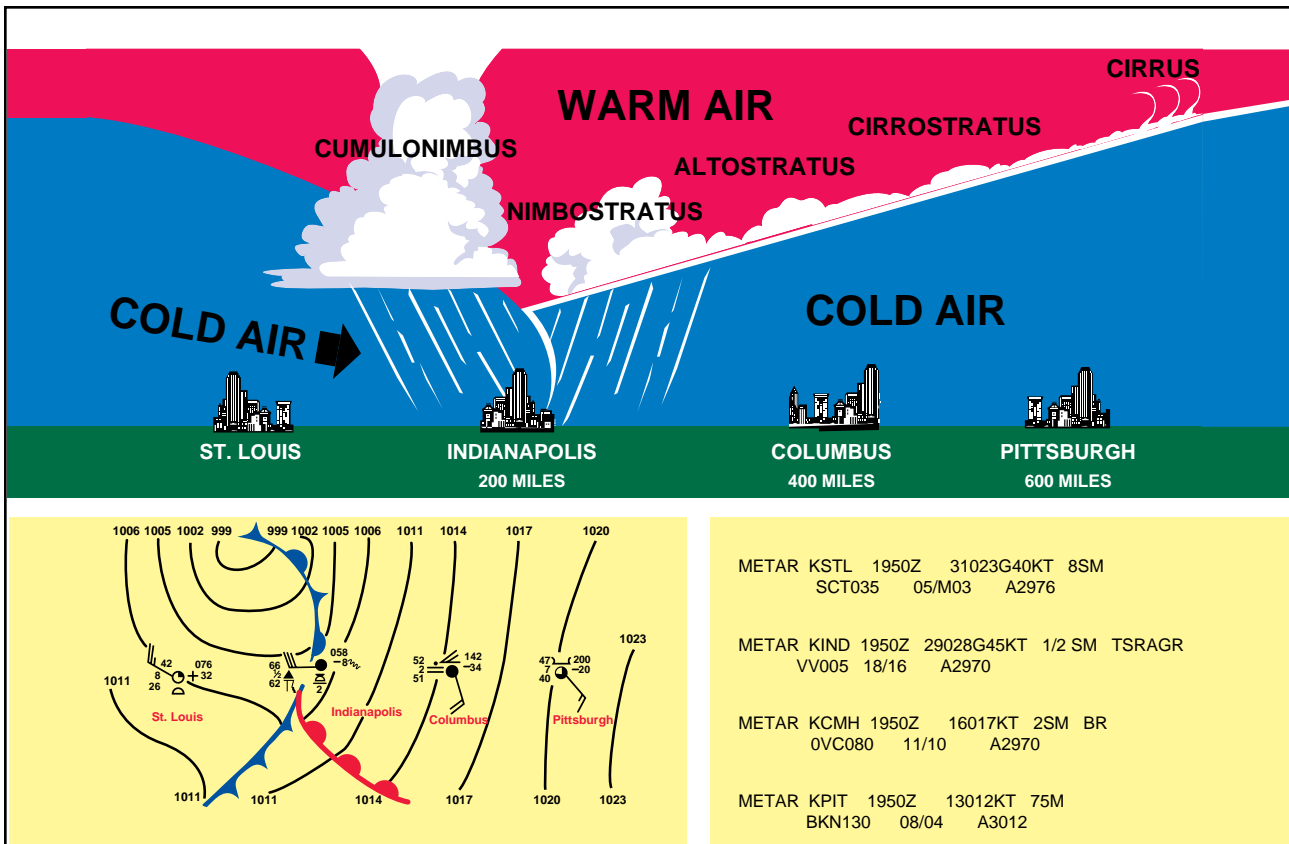

Figure 10-28. Occluded front cross-section with a weather chart depiction and associated METAR.



# Chapter 11



## Weather Reports, Forecasts, and Charts

In aviation, weather service is a combined effort of the National Weather Service (NWS), the Federal Aviation Administration (FAA), the Department of Defense (DOD), and other aviation groups and individuals. Because of the increasing need for worldwide weather services, foreign weather organizations also provide vital input.

While weather forecasts are not 100 percent accurate, meteorologists, through careful scientific study and computer modeling, have the ability to predict the weather patterns, trends, and characteristics with increasing accuracy. Through a complex system of weather services, government agencies, and independent weather observers, pilots and other aviation professionals receive the benefit of this vast knowledge base in the form of up-to-date weather reports and forecasts. These reports and forecasts enable pilots to make informed decisions regarding weather and flight safety.

### OBSERVATIONS

The data gathered from surface and upper altitude observations form the basis of all weather forecasts, advisories, and briefings. There are three types of weather observations: surface, upper air, and radar.

### SURFACE AVIATION WEATHER OBSERVATIONS

Surface aviation weather observations (METARs) are a compilation of weather elements of the current weather at ground stations across the United States. The network is made up of government run facilities and privately contracted facilities that provide up-to-date

weather information. Automated weather sources such as **automated weather observing systems** (AWOS) and **automated surface observing systems** (ASOS), as well as other automated facilities, also play a major role in the gathering of surface observations.

Surface observations provide local weather conditions and other relevant information. This information includes the type of report, station identifier, date and time, modifier (as required), wind, visibility, runway visual range (RVR), weather phenomena, sky condition, temperature/dewpoint, altimeter reading, and applicable remarks. The information gathered for the surface observation may be from a person, an automated station, or an automated station that is updated or enhanced by a weather observer. In any form, the surface observation provides valuable information about airports around the country.

### UPPER AIR OBSERVATIONS

Observations of upper air weather prove to be more challenging than surface observations. There are only two methods by which upper air weather phenomena can be observed: **radiosonde** observations and pilot

**Automated Weather Observing System (AWOS)**—Automated weather reporting system consisting of various sensors, a processor, a computer-generated voice subsystem, and a transmitter to broadcast weather data.

**Automated Surface Observation System (ASOS)**—Weather reporting system which provides surface observations every minute via digitized voice broadcasts and printed reports.

**Radiosonde**—A weather instrument that observes and reports meteorological conditions from the upper atmosphere. This instrument is typically carried into the atmosphere by some form of weather balloon.

weather reports (PIREPs). Using radio telemetry, radiosonde observations are made by sounding balloons from which weather data is received twice daily. These upper air observations provide temperature, humidity, pressure, and wind data for heights up to and above 100,000 feet. In addition to this, pilots provide vital information regarding upper air weather observations. Pilots remain the only real-time source of information regarding turbulence, icing, and cloud heights, which is gathered from pilots in flight, through the filing of pilot weather reports or PIREPs. Together, pilot reports and radiosonde observations provide information on upper air conditions important for flight planning. Many U.S. and international airlines have equipped their aircraft with instrumentation that automatically transmits in-flight weather observations through the DataLink system to the airline dispatcher who disseminates the data to appropriate weather forecasting authorities.

### **RADAR OBSERVATIONS**

Weather observers use three types of radar to provide information about precipitation, wind, and weather systems. The WSR-88D NEXRAD radar, commonly called Doppler radar, provides in-depth observations that inform surrounding communities of impending weather. FAA terminal doppler weather radar (TDWR), installed at some major airports around the country, also aids in providing severe weather alerts and warnings to airport traffic controllers. Terminal radar ensures pilots are aware of wind shear, gust fronts, and heavy precipitation, all of which are dangerous to arriving and departing aircraft. The third type of radar commonly used in the detection of precipitation is the FAA airport surveillance radar. This radar is used primarily to detect aircraft; however, it also detects the location and intensity of precipitation which is used to route aircraft traffic around severe weather in an airport environment.

### **SERVICE OUTLETS**

Service outlets are government or private facilities that provide aviation weather services. Several different government agencies, including the Federal Aviation Administration (FAA), National Oceanic and Atmospheric Administration (NOAA), and the National Weather Service (NWS) work in conjunction with private aviation companies to provide different means of accessing weather information.

### **FAA FLIGHT SERVICE STATION**

The FAA Flight Service Station (FSS) is the primary source for preflight weather information. A preflight weather briefing from an automated FSS (AFSS) can be obtained 24 hours a day by calling 1-800-WX BRIEF almost anywhere in the U.S. In areas not served by an AFSS, National Weather Service facilities may

provide pilot weather briefings. Telephone numbers for NWS facilities and additional numbers for FSSs/AFSSs can be found in the *Airport/Facility Directory (A/FD)* or in the U.S. Government section of the telephone book.

Flight Service Stations also provide in-flight weather briefing services, as well as scheduled and unscheduled weather broadcasts. An FSS may also furnish weather advisories to flights within the FSS region of authority.

### **TRANSCRIBED INFORMATION BRIEFING SERVICE (TIBS)**

The Transcribed Information Briefing Service (TIBS) is a service which is prepared and disseminated by selected Automated Flight Service Stations. It provides continuous telephone recordings of meteorological and aeronautical information. Specifically, TIBS provides area and route briefings, airspace procedures, and special announcements. It is designed to be a preliminary briefing tool and is not intended to replace a standard briefing from an FSS specialist.

The TIBS service is available 24 hours a day and is updated when conditions change, but it can only be accessed by a TOUCH-TONE<sup>®</sup> phone. The phone numbers for the TIBS service are listed in the A/FD.

### **DIRECT USER ACCESS TERMINAL SERVICE (DUATS)**

The Direct User Access Terminal Service, which is funded by the FAA, allows any pilot with a current medical certificate to access weather information and file a flight plan via computer. Two methods of access are available to connect with DUATS. The first is on the Internet through DynCorp at <http://www.duats.com> or Data Transformation Corporation at <http://www.duat.com>. The second method requires a modem and a communications program supplied by a DUATS provider. To access the weather information and file a flight plan by this method, pilots use a toll free telephone number to connect the user's computer directly to the DUATS computer. The current vendors of DUATS service and the associated phone numbers are listed in Chapter 7 of the *Aeronautical Information Manual (AIM)*.

### **ENROUTE FLIGHT ADVISORY SERVICE**

A service specifically designed to provide timely enroute weather information upon pilot request is known as the enroute flight advisory service (EFAS), or Flight Watch. EFAS provides a pilot with weather advisories tailored to the type of flight, route, and cruising altitude. EFAS can be one of the best sources for current weather information along the route of flight.

A pilot can usually contact an EFAS specialist from 6 a.m. to 10 p.m. anywhere in the conterminous U.S. and

Puerto Rico. The common EFAS frequency, 122.0 MHz, is established for pilots of aircraft flying between 5,000 feet AGL and 17,500 feet MSL.

## HAZARDOUS IN-FLIGHT WEATHER ADVISORY (HIWAS)

HIWAS is a national program for broadcasting hazardous weather information continuously over selected nav aids. The broadcasts include advisories such as **AIRMETS**, **SIGMETS**, **convective SIGMETS**, and **urgent PIREPs**. These broadcasts are only a summary of the information, and pilots should contact an FSS or EFAS for detailed information. Nav aids that have HIWAS capability are depicted on sectional charts with an “H” in the upper right corner of the identification box. [Figure 11-1]

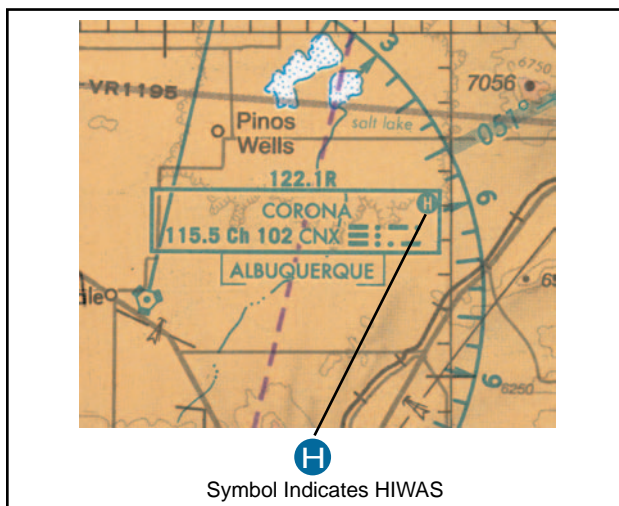

Figure 11-1. HIWAS availability is shown on sectional chart.

## TRANSCRIBED WEATHER BROADCAST (TWEB)

A transcribed weather broadcast is a weather report transmitted continuously over selected nav aids. On a sectional chart, a “T” in the upper right-hand corner of the navaid box indicates TWEB availability. TWEB weather usually consists of route-orientated data

**AIRMET**—In-flight weather advisory concerning moderate icing, moderate turbulence, sustained winds of 30 knots or more at the surface, and widespread areas of ceilings less than 1,000 feet and/or visibility less than 3 miles.

**SIGMET**—An in-flight weather advisory that is considered significant to all aircraft. SIGMET criteria include severe icing, severe and extreme turbulence, duststorms, sandstorms, volcanic eruptions, and volcanic ash that lower visibility to less than 3 miles.

**Convective SIGMET**—A weather advisory concerning convective weather significant to the safety of all aircraft. Convective SIGMETs are issued for tornadoes, lines of thunderstorms, thunderstorms over a wide area, embedded thunderstorms, wind gusts to 50 knots or greater, and/or hail  $\frac{3}{4}$  inch in diameter or greater.

**Urgent PIREP**—Any pilot report that contains any of the following weather phenomena: tornadoes, funnel clouds, or waterspouts; severe or extreme turbulence, including clear air turbulence; severe icing; hail; volcanic ash; or low-level wind shear.

including route forecasts, forecast outlook, winds aloft, and other selected weather reports for an area within 50 nautical miles (NM) of the FSS or for a 50-mile wide corridor along a specific route. A TWEB forecast is valid for 12 hours and is updated four times a day.

## WEATHER BRIEFINGS

Prior to every flight, pilots should gather all information vital to the nature of the flight. This includes an appropriate weather briefing obtained from a specialist at an FSS, AFSS, or NWS.

For weather specialists to provide an appropriate weather briefing, they need to know which of the three types of briefings is needed—a standard briefing, an abbreviated briefing, or an outlook briefing. Other helpful information is whether the flight is visual flight rule (VFR) or instrument flight rule (IFR), aircraft identification and type, departure point, estimated time of departure (ETD), flight altitude, route of flight, destination, and estimated time en route (ETE).

This information is recorded in the flight plan system, and a note is made regarding the type of weather briefing provided. If necessary, it can be referenced later to file or amend a flight plan. It is also used when an aircraft is overdue or is reported missing.

## STANDARD BRIEFING

A standard briefing is the most complete report and provides the overall weather picture. This type of briefing should be obtained prior to the departure of any flight and should be used during flight planning. A standard briefing provides the following information in sequential order if it is applicable to the route of flight.

1. **Adverse Conditions**—This includes information about adverse conditions that may influence a decision to cancel or alter the route of flight. Adverse conditions includes significant weather, such as thunderstorms or aircraft icing, or other important items such as airport closings.
2. **VFR Flight NOT RECOMMENDED**—If the weather for the route of flight is below VFR minimums, or if it is doubtful the flight could be made under VFR conditions due to the forecast weather, the briefer may state that VFR is not recommended. It is the pilot’s decision whether or not to continue the flight under VFR, but this advisory should be weighed carefully.
3. **Synopsis**—The synopsis is an overview of the larger weather picture. Fronts and major weather systems that affect the general area are provided.

4. **Current Conditions**—This portion of the briefing contains the current ceilings, visibility, winds, and temperatures. If the departure time is more than 2 hours away, current conditions will not be included in the briefing.
5. **En Route Forecast**—The en route forecast is a summary of the weather forecast for the proposed route of flight.
6. **Destination Forecast**—The destination forecast is a summary of the expected weather for the destination airport at the estimated time of arrival (ETA).
7. **Winds and Temperatures Aloft**—Winds and temperatures aloft is a report of the winds at specific altitudes for the route of flight. However, the temperature information is provided only on request.
8. **Notices to Airmen**—This portion supplies NOTAM information pertinent to the route of flight which has not been published in the Notice to Airmen publication. Published NOTAM information is provided during the briefing only when requested.
9. **ATC Delays**—This is an advisory of any known air traffic control (ATC) delays that may affect the flight.
10. **Other Information**—At the end of the standard briefing, the FSS specialist will provide the radio frequencies needed to open a flight plan and to contact en route flight advisory service (EFAS). Any additional information requested is also provided at this time.

### ABBREVIATED BRIEFING

An abbreviated briefing is a shortened version of the standard briefing. It should be requested when a departure has been delayed or when specific weather information is needed to update the previous briefing. When this is the case, the weather specialist needs to know the time and source of the previous briefing so the necessary weather information will not be omitted inadvertently.

### OUTLOOK BRIEFING

An outlook briefing should be requested when a planned departure is 6 or more hours away. It provides initial forecast information that is limited in scope due to the timeframe of the planned flight. This type of briefing is a good source of flight planning information that can influence decisions regarding route of flight, altitude, and ultimately the go, no-go decision. A

follow-up briefing prior to departure is advisable since an outlook briefing generally only contains information based on weather trends and existing weather in geographical areas at or near the departure airport.

## AVIATION WEATHER REPORTS

Aviation weather reports are designed to give accurate depictions of current weather conditions. Each report provides current information that is updated at different times. Some typical reports are aviation routine weather reports (METAR), pilot weather reports (PIREPs), and radar weather reports (SDs).

### AVIATION ROUTINE WEATHER REPORT (METAR)

An aviation routine weather report, or METAR, is an observation of current surface weather reported in a standard international format. While the METAR code has been adopted worldwide, each country is allowed to make modifications to the code. Normally, these differences are minor but necessary to accommodate local procedures or particular units of measure. This discussion of METAR will cover elements used in the United States.

#### Example:

```
METAR KGGG 161753Z AUTO 14021G26 3/4SM
+TSRA BR BKN008 OVC012CB 18/17 A2970 RMK
PRESFR
```

A typical METAR report contains the following information in sequential order:

1. **Type of Report**—There are two types of METAR reports. The first is the routine METAR report that is transmitted every hour. The second is the aviation selected special weather report (SPECI). This is a special report that can be given at any time to update the **METAR** for rapidly changing weather conditions, aircraft mishaps, or other critical information.
2. **Station Identifier**—Each station is identified by a four-letter code as established by the International Civil Aviation Organization (ICAO). In the 48 contiguous states, a unique three-letter identifier is preceded by the letter “K.” For example, Gregg County Airport in Longview, Texas, is identified by the letters “**KGGG**,” K being the country designation and GGG being the airport identifier. In other regions of the world, including Alaska and Hawaii, the first two letters of the four-letter ICAO identifier indicate the region, country,

or state. Alaska identifiers always begin with the letters “PA” and Hawaii identifiers always begin with the letters “PH.” A list of station identifiers can be found at an FSS or NWS office.

3. **Date and Time of Report**—The date and time (**161753Z**) are depicted in a six-digit group. The first two digits of the six-digit group are the date. The last four digits are the time of the METAR, which is always given in Coordinated Universal Time (UTC). A “Z” is appended to the end of the time to denote the time is given in **Zulu time** (UTC) as opposed to local time.
4. **Modifier**—Modifiers denote that the METAR came from an automated source or that the report was corrected. If the notation “**AUTO**” is listed in the METAR, the report came from an automated source. It also lists “**AO1**” or “**AO2**” in the remarks section to indicate the type of precipitation sensors employed at the automated station.

When the modifier “**COR**” is used, it identifies a corrected report sent out to replace an earlier report that contained an error.

**Example:**

METAR KGGG 161753Z COR

5. **Wind**—Winds are reported with five digits (**14021**) unless the speed is greater than 99 knots, in which case the wind is reported with six digits. The first three digits indicate the direction the wind is blowing in tens of degrees. If the wind is variable, it is reported as “**VRB**.” The last two digits indicate the speed of the wind in knots (KT) unless the wind is greater than 99 knots, in which case it is indicated by three digits. If the winds are gusting, the letter “**G**” follows the windspeed (**G26**). After the letter “**G**,” the peak gust recorded is provided. If the wind varies more than 60° and the windspeed is greater than 6 knots, a separate group of numbers, separated by a “**V**,” will indicate the extremes of the wind directions.
6. **Visibility**—The prevailing visibility (**3/4 SM**) is reported in statute miles as denoted by the letters “**SM**.” It is reported in both miles and fractions of miles. At times, RVR, or runway visual range is reported following the

prevailing visibility. RVR is the distance a pilot can see down the runway in a moving aircraft. When RVR is reported, it is shown with an R, then the runway number followed by a slant, then the visual range in feet. For example, when the RVR is reported as **R17L/1400FT**, it translates to a visual range of 1,400 feet on runway 17 left.

7. **Weather**—Weather can be broken down into two different categories: qualifiers and weather phenomenon (**+TSRA BR**). First, the qualifiers of intensity, proximity, and the descriptor of the weather will be given. The intensity may be light (-), moderate ( ), or heavy (+). Proximity only depicts weather phenomena that are in the airport vicinity. The notation “**VC**” indicates a specific weather phenomenon is in the vicinity of 5 to 10 miles from the airport. Descriptors are used to describe certain types of precipitation and obscurations. Weather phenomena may be reported as being precipitation, obscurations, and other phenomena such as squalls or funnel clouds. Descriptions of weather phenomena as they begin or end, and hailstone size are also listed in the remarks sections of the report. [Figure 11-2]
8. **Sky Condition**—Sky condition (**BKN008 OVC012CB**) is always reported in the sequence of amount, height, and type or indefinite ceiling/height (vertical visibility). The heights of the cloud bases are reported with a three-digit number in hundreds of feet above the ground. Clouds above 12,000 feet are not detected or reported by an automated station. The types of clouds, specifically towering cumulus (TCU) or cumulonimbus (CB) clouds, are reported with their height. Contractions are used to describe the amount of cloud coverage and obscuring phenomena. The amount of sky coverage is reported in eighths of the sky from horizon to horizon. [Figure 11-3]
9. **Temperature and Dewpoint**—The air temperature and dewpoint are always given in degrees Celsius (**18/17**). Temperatures below 0°C are preceded by the letter “**M**” to indicate minus.
10. **Altimeter Setting**—The altimeter setting is reported as inches of mercury in a four-digit number group (**A2970**). It is always preceded by the letter “**A**.” Rising or falling pressure may also be denoted in the remarks sections as “**PRESRR**” or “**PRESFR**” respectively.

**Zulu Time**—A term used in aviation for coordinated universal time (UTC) which places the entire world on one time standard.



Qualifier		Weather Phenomena		
Intensity or Proximity 1	Descriptor 2	Precipitation 3	Obscuration 4	Other 5
- Light  Moderate (no qualifier)  + Heavy  VC in the vicinity	<b>MI</b> Shallow <b>BC</b> Patches <b>DR</b> Low Drifting <b>BL</b> Blowing <b>SH</b> Showers <b>TS</b> Thunderstorms <b>FZ</b> Freezing <b>PR</b> Partial	<b>DZ</b> Drizzle <b>RA</b> Rain <b>SN</b> Snow <b>SG</b> Snow grains <b>IC</b> Ice Crystals (diamond dust) <b>PL</b> Ice Pellets <b>GR</b> Hail <b>GS</b> Small hail or snow pellets <b>UP</b> *Unknown Precipitation	<b>BR</b> Mist <b>FG</b> Fog <b>FU</b> Smoke <b>DU</b> Dust <b>SA</b> Sand <b>HZ</b> Haze <b>PY</b> Spray <b>VA</b> Volcanic ash	<b>PO</b> Dust/sand whirls <b>SQ</b> Squalls <b>FC</b> Funnel cloud <b>+FC</b> Tornado or Waterspout <b>SS</b> Sandstorm <b>DS</b> Dust storm
<p>The weather groups are constructed by considering columns 1-5 in this table, in sequence; i.e., intensity, followed by descriptor, followed by weather phenomena; i.e., heavy rain showers(s) is coded as +SHRA.</p> <p>* Automated stations only</p>				

Figure 11-2. Descriptors and weather phenomena used in a typical METAR.

Sky Cover	Less than 1/8 (Clear)	1/8 - 2/8 (Few)	3/8 - 4/8 (Scattered)	5/8 - 7/8 (Broken)	8/8 or Overcast (Overcast)
Contraction	<b>SKC</b> <b>CLR</b> <b>FEW</b>	<b>FEW</b>	<b>SCT</b>	<b>BKN</b>	<b>OVC</b>

Figure 11-3. Reportable contractions for sky condition.

**11. Remarks**—Comments may or may not appear in this section of the METAR. The information contained in this section may include wind data, variable visibility, beginning and ending times of particular phenomenon, pressure information, and various other information deemed necessary. An example of a remark regarding weather phenomenon that does not fit in any other category would be: OCNL LTGICCG. This translates as occasional lightning in the clouds, and from cloud to ground. Automated stations also use the remarks section to indicate the equipment needs maintenance. The remarks section always begins with the letters “**RMK.**”

**Example:**

METAR BTR 161753Z 14021G26 3/4SM -RA BR BKN008 OVC012 18/17 A2970 RMK PRESFR

**Explanation:**

Type of Report: .....Routine METAR  
 Location: .....Baton Rouge, Louisiana  
 Date: .....16<sup>th</sup> day of the month  
 Time: .....1753 Zulu  
 Modifier: .....None shown  
 Wind Information: .....Winds 140° at 21 knots gusting to 26 knots  
 Visibility: .....3/4 statute mile  
 Weather: .....light rain and mist  
 Sky Conditions: .....Skies broken 800 feet, overcast 1,200  
 Temperature: .....Temperature 18°C, dewpoint 17°C  
 Altimeter: .....29.70 in. Hg.  
 Remarks: .....Barometric pressure is falling.

## PILOT WEATHER REPORTS (PIREPs)

Pilot weather reports provide valuable information regarding the conditions as they actually exist in the air, which cannot be gathered from any other source. Pilots can confirm the height of bases and tops of clouds, locations of wind shear and turbulence, and the location of in-flight icing. If the ceiling is below 5,000 feet, or visibility is at or below 5 miles, ATC facilities are required to solicit PIREPs from pilots in the area. When unexpected weather conditions are encountered, pilots are encouraged to make a report to an FSS or ATC. When a **pilot weather report** is filed, the ATC facility or FSS will add it to the distribution system to brief other pilots and provide in-flight advisories.

PIREPs are easy to file and a standard reporting form outlines the manner in which they should be filed. Figure 11-4 shows the elements of a PIREP form. Item numbers one through five are required information when making a report, as well as at least one weather phenomenon encountered. PIREPs are normally transmitted as an individual report, but may be

**Pilot Weather Report**—A report, generated by pilots, concerning meteorological phenomenon encountered in flight.

appended to a surface report. Pilot reports are easily decoded and most contractions used in the reports are self-explanatory.

### Example:

UA/OV GGG 090025/ M 1450/ FL 060/ TP C182/ SK 080 OVC/ WX FV 04R/ TA 05/ WV 270030/ TB LGT/ RM HVY RAIN

### Explanation:

Type: .....Routine pilot report  
 Location: .....25 NM out on the 090° radial, Gregg County VOR  
 Time: .....1450 Zulu  
 Altitude or Flight Level: 6,000 feet  
 Aircraft Type: .....Cessna 182  
 Sky Cover: .....8,000 overcast  
 Visibility/Weather: .....4 miles in rain  
 Temperature: .....5° Celsius  
 Wind: .....270° at 30 knots  
 Turbulence: .....Light  
 Icing: .....None reported  
 Remarks: .....Rain is heavy.

ENCODING PILOT WEATHER REPORTS (PIREPS)		
1. UA	Routine PIREP, UUA-Urgent PIREP.	
2. /OV	Location:	Use 3-letter NAVAID idents only. a. Fix: /OV ABC, /OV ABC 090025. b. Fix: /OV ABC 045020-DEF, /OV ABC-DEF-GHI.
3. /TM	Time:	4 digits in UTC: /TM 0915.
4. /FL	Altitude/Flight Level:	3 digits for hundreds of feet. If not known use UNKN: /FL095, /FL310, /FLUNKN.
5. /TP	Type Aircraft:	4 digits maximum, if not known use UNKN: /TP L329, /TP B727, /TP UNKN.
6. /SK	Cloud Layers:	Describe as follows: a. Height of cloud base in hundreds of feet. If unknown, use UNKN. b. Cloud cover symbol. c. Height of cloud tops in hundreds of feet.
7. /WX	Weather:	Flight visibility reported first: Use standard weather symbols, Intensity is not reported: /WX FV02 R H, /WX FV01 TRW.
8. /TA	Air Temperature in Celsius:	If below zero, prefix with a hyphen: /TA 15, /TA -06.
9. /WV	Wind:	Direction and speed in six digits: /WV 270045, /WV 280110.
10. /TB	Turbulence:	Use standard contractions for intensity and type (use CAT or CHOP when appropriate). Include altitude only if different from /FL, /TB EXTREME, /TB LGT-MDT BLO 090.
11. /IC	Icing:	Describe using standard intensity and type contractions. Include altitude only if different than /FL: /IC LGT-MDT RIME, /IC SVR CLR 028-045.
12. /RM	Remarks:	Use free form to clarify the report and type hazardous elements first: /RM LLWS -15 KT SFC-030 DURC RNWY 22 JFK.

Figure 11-4. PIREP encoding and decoding.

## RADAR WEATHER REPORTS (SD)

Areas of precipitation and thunderstorms are observed by radar on a routine basis. Radar weather reports are issued by radar stations at 35 minutes past the hour, with special reports issued as needed.

Radar weather reports provide information on the type, intensity, and location of the echo top of the precipitation. [Figure 11-5] These reports may also include direction and speed of the area of precipitation as well as the height and base of the precipitation in hundreds of feet MSL. RAREPs are especially valuable for preflight planning to help avoid areas of severe weather. However, radar only detects objects in the atmosphere that are large enough to be considered precipitation. Cloud bases and tops, ceilings, and visibility are not detected by radar.

A typical RAREP will include:

- Location identifier and time of radar observation.

SYMBOL	MEANING
R	Rain
RW	Rain Shower
S	Snow
SW	Snow Shower
T	Thunderstorm
SYMBOL	INTENSITY
-	Light
(none)	Moderate
+	Heavy
++	Very Heavy
X	Intense
XX	Extreme
CONTRACTION	OPERATIONAL STATUS
PPINE	Radar is operating normally but there are no echoes being detected.
PPINA	Radar observation is not available.
PPIOM	Radar is inoperative or out of service.
AUTO	Automated radar report from WSR-88D.

Figure 11-5. Radar weather report codes.

- Echo pattern:
  1. Line (LN)—A line of precipitation echoes at least 30 miles long, at least four times as long as it is wide, and at least 25 percent coverage within the line.
  2. Area (AREA)—A group of echoes of similar type and not classified as a line.
  3. Single Cell (CELL)—A single isolated convective echo such as a rain shower.
- Area coverage in tenths.
- Type and intensity of weather.
- Azimuth, referenced to true north, and range, in nautical miles, from the radar site, of points defining the echo pattern. For lines and areas, there will be two azimuth and range sets that define the pattern. For cells, there will be only one azimuth and range set.
- Dimension of echo pattern—The dimension of an echo pattern is given when the azimuth and range define only the center line of the pattern.
- Cell movement—Movement is only coded for cells; it will not be coded for lines or areas.
- Maximum top of precipitation and location. Maximum tops may be coded with the symbols “MT” or “MTS.” If it is coded with “MTS,” it means that satellite data as well as radar information was used to measure the top of the precipitation.
- If the word “AUTO” appears in the report, it means the report is automated from WSR-88D weather radar data.
- The last section is primarily used to prepare radar summary charts, but can be used during preflight to determine the maximum precipitation intensity within a specific grid box. The higher the number, the greater the intensity. Two or more numbers appearing after a grid box reference, such as PM34, indicates precipitation in consecutive grid boxes.

### Example:

TLX 1935 LN 8 TRW++ 86/40 199/115  
 20W C2425 MTS 570 AT 159/65 AUTO  
 ^MO1 NO2 ON3 PM34 QM3 RL2=

### **Explanation:**

The radar report gives the following information: The report is automated from Oklahoma City and was made at 1935 UTC. The echo pattern for this radar report indicates a line of echos covering 8/10ths of the area. Thunderstorms and very heavy rain showers are indicated. The next set of numbers indicate the azimuth that defines the echo (86° at 40 NM and 199° at 115 NM). Next, the dimension of this echo is given as 20 nautical miles wide (10 nautical miles on either side of the line defined by the azimuth and range). The cells within the line are moving from 240° at 25 knots. The maximum top of the precipitation, as determined by radar and satellite, is 57,000 feet and it is located on the 159° radial, 65 NM out. The last line indicates the intensity of the precipitation, for example in grid QM the intensity is 3 or heavy precipitation. (1 is light and 6 is extreme.)

## **AVIATION FORECASTS**

Observed weather condition reports are often used in the creation of forecasts for the same area. A variety of different forecast products are produced and designed to be used in the preflight planning stage. The printed forecasts that pilots need to be familiar with are the terminal aerodrome forecast (TAF), aviation area forecast (FA), in-flight weather advisories (SIGMET, AIRMET), and the winds and temperatures aloft forecast (FD).

### **TERMINAL AERODROME FORECASTS (TAF)**

A terminal aerodrome forecast is a report established for the 5 statute mile radius around an airport. TAF reports are usually given for larger airports. Each TAF is valid for a 24-hour time period, and is updated four times a day at 0000Z, 0600Z, 1200Z, and 1800Z. The TAF utilizes the same descriptors and abbreviations as used in the METAR report.

The terminal forecast includes the following information in sequential order:

- 1. Type of Report**—A TAF can be either a routine forecast (TAF) or an amended forecast (TAF AMD).
- 2. ICAO Station Identifier**—The station identifier is the same as that used in a METAR.
- 3. Date and Time of Origin**—Time and date of TAF origination is given in the six-number code with the first two being the date, the last four being the time. Time is always given in UTC as denoted by the Z following the number group.
- 4. Valid Period Date and Time**—The valid forecast time period is given by a six-digit number group. The first two numbers indicate the date, followed by the two-digit beginning time for the valid period, and the last two digits are the ending time.
- 5. Forecast Wind**—The wind direction and speed forecast are given in a five-digit number group. The first three indicate the direction of the wind in reference to true north. The last two digits state the windspeed in knots as denoted by the letters “KT.” Like the METAR, winds greater than 99 knots are given in three digits.
- 6. Forecast Visibility**—The forecast visibility is given in statute miles and may be in whole numbers or fractions. If the forecast is greater than 6 miles, it will be coded as “P6SM.”
- 7. Forecast Significant Weather**—Weather phenomenon is coded in the TAF reports in the same format as the METAR. If no significant weather is expected during the forecast time period, the denotation “NSW” will be included in the “becoming” or “temporary” weather groups.
- 8. Forecast Sky Condition**—Forecast sky conditions are given in the same manner as the METAR. Only cumulonimbus (CB) clouds are forecast in this portion of the TAF report as opposed to CBs and towering cumulus in the METAR.
- 9. Forecast Change Group**—For any significant weather change forecast to occur during the TAF time period, the expected conditions and time period are included in this group. This information may be shown as From (FM), Becoming (BECMG), and Temporary (TEMPO). “From” is used when a rapid and significant change, usually within an hour, is expected. “Becoming” is used when a gradual change in the weather is expected over a period of no more than 2 hours. “Temporary” is used for temporary fluctuations of weather, expected to last for less than an hour.
- 10. Probability Forecast**—The probability forecast is given percentage that describes the probability of thunderstorms and precipitation occurring in the coming hours. This forecast is not used for the first 6 hours of the 24-hour forecast.

**Example:**

TAF  
 KPIR 111130Z 111212 15012KT P6SM BKN090  
 TEMPO 1214 5SM BR  
 FM1500 16015G25KT P6SM SCT040 BKN250  
 FM0000 14012KT P6SM BKN080 OVC150 PROB40  
 0004 3SM TSRA BKN030CB  
 FM0400 1408KT P6SM SCT040 OVC080 TEMPO  
 0408 3SM TSRA OVC030CB  
 BECMG 0810 32007KT=

**Explanation:**

Routine TAF for Pierre, South Dakota...on the 11<sup>th</sup> day of the month, at 1130Z...valid for 24 hours from 1200Z on the 11<sup>th</sup> to 1200Z on the 12<sup>th</sup>...wind from 150° at 12 knots...visibility greater than 6 statute miles...broken clouds at 9,000 feet...temporarily, between 1200Z and 1400Z, visibility 5 statute miles in mist...from 1500Z winds from 160° at 15 knots, gusting to 25 knots visibility greater than 6 statute miles...clouds scattered at 4,000 feet and broken at 25,000 feet...from 0000Z wind from 140° at 12 knots...visibility greater than 6 statute miles...clouds broken at 8,000 feet, overcast at 15,000 feet...between 0000Z and 0400Z, there is 40 percent probability of visibility 3 statute miles...thunderstorm with moderate rain showers...clouds broken at 3,000 feet with cumulonimbus clouds...from 0400Z...winds from 140° at 8 knots...visibility greater than 6 miles...clouds at 4,000 scattered and overcast at 8,000...temporarily between 0400Z and 0800Z...visibility 3 miles...thunderstorms with moderate rain showers...clouds overcast at 3,000 feet with cumulonimbus clouds...becoming between 0800Z and 1000Z...wind from 320° at 7 knots...end of report (=).

**AREA FORECASTS (FA)**

The aviation area forecast (FA) gives a picture of clouds, general weather conditions, and visual meteorological conditions (VMC) expected over a large area encompassing several states. There are six areas for which area forecasts are published in the contiguous 48 states. Area forecasts are issued three times a day and are valid for 18 hours. This type of forecast gives information vital to en route operations as well as forecast information for smaller airports that do not have terminal forecasts.

Area forecasts are typically disseminated in four sections and include the following information:

- 1. Header**—This gives the location identifier of the source of the FA, the date and time of issuance, the valid forecast time, and the area of coverage.

**Example:**

DFWC FA 120945  
 SYNOPSIS AND VFR CLDS/WX  
 SYNOPSIS VALID UNTIL 130400  
 CLDS/WX VALID UNTIL 122200...OTLK VALID  
 122200-130400  
 OK TX AR LA MS AL AND CSTL WTRS

**Explanation:**

The area forecast shows information given by Dallas Fort Worth, for the region of Oklahoma, Texas, Arkansas, Louisiana, Mississippi, and Alabama, as well as a portion of the gulf coastal waters. It was issued on the 12<sup>th</sup> day of the month at 0945. The synopsis is valid from the time of issuance until 0400 hours on the 13<sup>th</sup>. VFR clouds and weather information on this area forecast is valid until 2200 hours on the 12<sup>th</sup> and the outlook is valid until 0400 hours on the 13<sup>th</sup>.

- 2. Precautionary Statements**—IFR conditions, mountain obscurations, and thunderstorm hazards are described in this section. Statements made here regarding height are given in MSL, and if given otherwise, AGL or CIG (ceiling) will be noted.

**Example:**

SEE AIRMET SIERRA FOR IFR CONDS AND  
 MTN OBSCN.  
 TS IMPLY SEV OR GTR TURB SEV ICE LLWS  
 AND IFR CONDS.  
 NON MSL HGTS DENOTED BY AGL OR CIG.

**Explanation:**

The area forecast covers VFR clouds and weather, so the precautionary statement warns that AIRMET Sierra should be referenced for IFR conditions and mountain obscuration. The code TS indicates the possibility of thunderstorms and implies there may be an occurrence of severe or greater turbulence, severe icing, low-level wind shear, and IFR conditions. The final line of the precautionary statement alerts the user that heights, for the most part, are mean sea level (MSL). Those that are not MSL will be above ground level (AGL) or ceiling (CIG).

- 3. Synopsis**—The synopsis gives a brief summary identifying the location and movement of pressure systems, fronts, and circulation patterns.

**Example:**

SYNOPSIS...LOW PRES TROF 10Z OK/TX PNHDL AREA FCST MOV EWD INTO CNTRL-SWRN OK BY 04Z. WRMFNT 10Z CNTRL OK-SRN AR-NRN MS FCST LIFT NWD INTO NERN OK-NRN AR EXTRM NRN MS BY 04Z.

**OK**

PNDL AND NW...AGL SCT030 SCT-BKN100. TOPS FL200. 15Z AGL SCT040 SCT100. AFT 20Z SCT TSRA DVLPG..FEW POSS SEV. CB TOPS FL450. OTLK...VFR

**Explanation:**

As of 1000 Zulu, there is a low pressure trough over the Oklahoma and Texas panhandle area, which is forecast to move eastward into central southwestern Oklahoma by 0400 Zulu. A warm front located over central Oklahoma, southern Arkansas, and northern Mississippi at 1000 Zulu is forecast to lift northwestward into northeastern Oklahoma, northern Arkansas, and extreme northern Mississippi by 0400 Zulu.

**Explanation:**

In south central and southeastern Texas, there is a scattered to broken layer of clouds from 1,000 feet AGL with tops at 3,000 feet, visibility is 3 to 5 statute miles in mist. Between 1400 Zulu and 1600 Zulu, the cloud bases are expected to increase to 3,000 feet AGL. After 1900 Zulu, the cloud bases are expected to continue to increase to 5,000 feet AGL and the outlook is VFR.

- 4. **VFR Clouds and Weather**—This section lists expected sky conditions, visibility, and weather for the next 12 hours and an outlook for the following 6 hours.

In northwestern Oklahoma and panhandle, the clouds are scattered at 3,000 feet with another scattered to broken layer at 10,000 feet AGL, with the tops at 20,000 feet. At 1500 Zulu, the lowest cloud base is expected to increase to 4,000 feet AGL with a scattered layer at 10,000 feet AGL. After 2000 Zulu, the forecast calls for scattered thunderstorms with rain developing and a few becoming severe; the cumulonimbus clouds will have tops at flight level 450 or 45,000 feet MSL.

**Example:**

S CNTRL AND SERN TX AGL SCT-BKN010. TOPS 030. VIS 3-5SM BR. 14-16Z BECMG AGL SCT030. 19Z AGL SCT050. OTLK...VFR

It should be noted that when information is given in the area forecast, locations may be given by states, regions, or specific geological features such as mountain ranges. Figure 11-6 shows an area forecast chart with

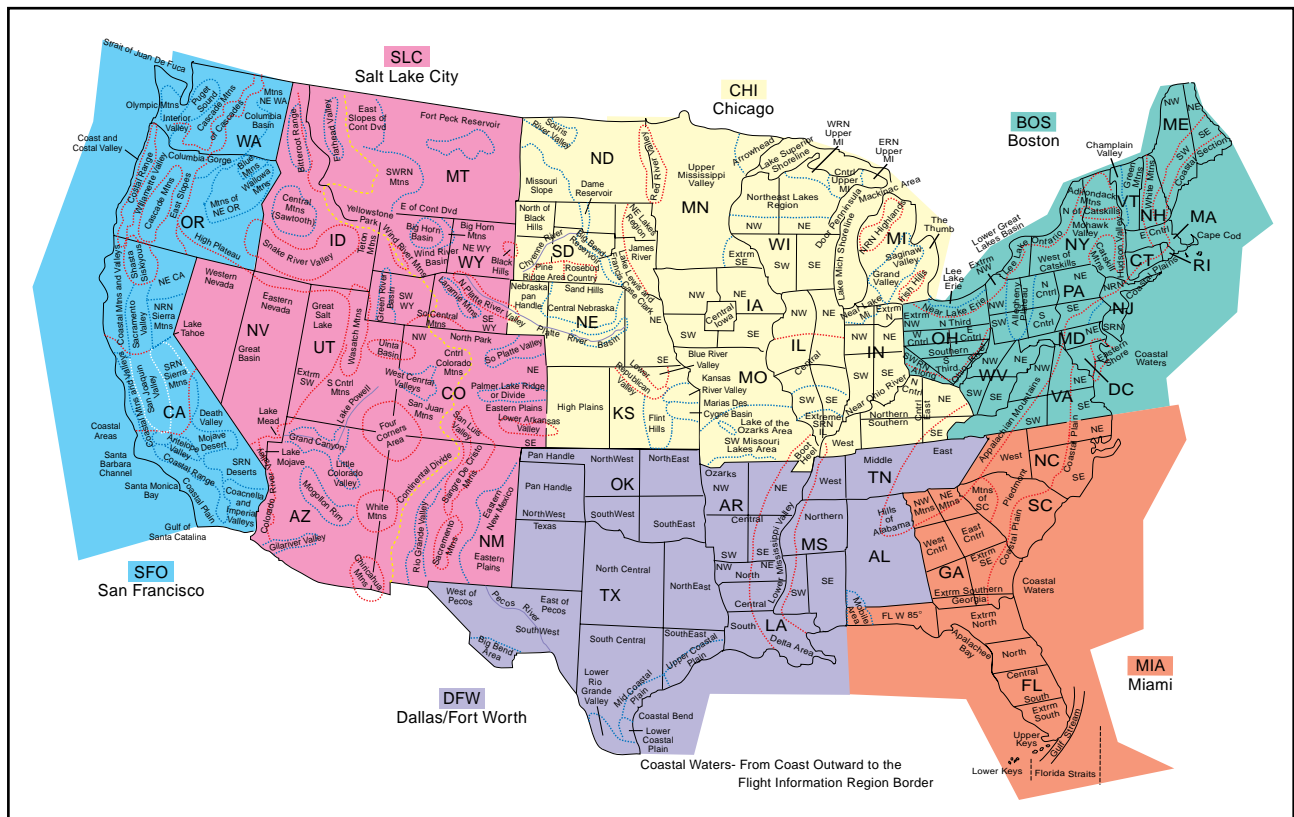

Figure 11-6. Area forecast region map.

six regions of forecast, states, regional areas, and common geographical features.

### **IN-FLIGHT WEATHER ADVISORIES**

In-flight weather advisories, which are provided to en route aircraft, are forecasts that detail potentially hazardous weather. These advisories are also available to pilots prior to departure for flight planning purposes. An in-flight weather advisory is issued in the form of either an AIRMET, SIGMET, or Convective SIGMET.

### **AIRMAN'S METEOROLOGICAL INFORMATION (AIRMET)**

AIRMETs (WAs) are examples of in-flight weather advisories that are issued every 6 hours with intermediate updates issued as needed for a particular area forecast region. The information contained in an AIRMET is of operational interest to all aircraft, but the weather section concerns phenomena considered potentially hazardous to light aircraft and aircraft with limited operational capabilities.

An AIRMET includes forecast of moderate icing, moderate turbulence, sustained surface winds of 30 knots or greater, widespread areas of ceilings less than 1,000 feet and/or visibilities less than 3 miles, and extensive mountain obscurement.

Each AIRMET bulletin has a fixed alphanumeric designator, numbered sequentially for easy identification, beginning with the first issuance of the day. SIERRA is the AIRMET code used to denote instrument flight rules (IFR) and mountain obscuration; TANGO is used to denote turbulence, strong surface winds, and low-level wind shear; and ZULU is used to denote icing and freezing levels.

#### **Example:**

```
DFWT WA 241650
AIRMET TANGO UPDT 3 FOR TURBC... STG
SFC WINDS AND LLWS VALID UNTIL 242000

AIRMET TURBC... OK TX...UPDT
FROM OKC TO DFW TO SAT TO MAF TO CDS
TO OKC OCNL MDT TURBC BLO 60 DUE TO
STG AND GUSTY LOW LVL WINDS. CONDS
CONTG BYD 2000Z
```

#### **Explanation:**

This AIRMET was issued by Dallas Fort Worth on the 24<sup>th</sup> day of the month, at 1650 Zulu time. On this third update, the AIRMET Tango is issued for turbulence, strong surface winds, and low-level wind shear until 2000 Zulu on the same day. The turbulence section of the AIRMET is an update for Oklahoma and Texas. It

defines an area from Oklahoma City to Dallas, Texas, to San Antonio, to Midland, Texas, to Childress, Texas, to Oklahoma City that will experience occasional moderate turbulence below 6,000 feet due to strong and gusty low-level winds. It also notes that these conditions are forecast to continue beyond 2000 Zulu.

### **SIGNIFICANT METEOROLOGICAL INFORMATION (SIGMET)**

SIGMETs (WSs) are in-flight advisories concerning non-convective weather that is potentially hazardous to all aircraft. They report weather forecasts that include severe icing not associated with thunderstorms, severe or extreme turbulence or clear air turbulence (CAT) not associated with thunderstorms, dust storms or sandstorms that lower surface or in-flight visibilities to below 3 miles, and volcanic ash.

SIGMETs are unscheduled forecasts that are valid for 4 hours, but if the SIGMET relates to hurricanes, it is valid for 6 hours.

A SIGMET is issued under an alphabetic identifier, from November through Yankee, excluding Sierra and Tango. The first issuance of a SIGMET is designated as a UWS, or Urgent Weather SIGMET. Re-issued SIGMETs for the same weather phenomenon are sequentially numbered until the weather phenomenon ends.

#### **Example:**

```
SFOR WS 100130
SIGMET ROME02 VALID UNTIL 100530
OR WA
FROM SEA TO PDT TO EUG TO SEA
OCNL MOGR CAT BTN 280 AND 350 EXPCD
DUE TO JTSTR.
CONDS BGNG AFT 0200Z CONTG BYD 0530Z .
```

#### **Explanation:**

This is SIGMET Romeo 2, the second issuance for this weather phenomenon. It is valid until the 10th day of the month at 0530 Zulu time. This SIGMET is for Oregon and Washington, for a defined area from Seattle to Portland to Eugene to Seattle. It calls for occasional moderate or greater clear air turbulence between 28,000 and 35,000 feet due to the location of the jetstream. These conditions will be beginning after 0200 Zulu and will continue beyond the forecast scope of this SIGMET of 0530 Zulu.

### **CONVECTIVE SIGNIFICANT METEOROLOGICAL INFORMATION (WST)**

A Convective SIGMET (WST) is an in-flight weather advisory issued for hazardous convective weather that affects the safety of every flight. Convective SIGMETs

are issued for severe thunderstorms with surface winds greater than 50 knots, hail at the surface greater than or equal to 3/4 inch in diameter, or tornadoes. They are also issued to advise pilots of embedded thunderstorms, lines of thunderstorms, or thunderstorms with heavy or greater precipitation that affect 40 percent or more of a 3,000 square foot or greater region.

Convective SIGMETs are issued for each area of the contiguous 48 states but not Alaska or Hawaii. Convective SIGMETs are issued for the eastern (E), western (W), and central (C) United States. Each report is issued at 55 minutes past the hour, but special reports can be issued during the interim for any reason. Each forecast is valid for 2 hours. They are numbered sequentially each day from 1-99, beginning at 00 Zulu time. If no hazardous weather exists, the Convective SIGMET will still be issued; however, it will state "CONVECTIVE SIGMET.... NONE."

**Example:**

MKCC WST 221855  
 CONVECTIVE SIGMET 21C  
 VALID UNTIL 2055  
 KS OK TX  
 VCNTY GLD-CDS LINE  
 NO SGFNT TSTMS RPRTD  
 LINE TSTMS DVLPG BY 1955Z WILL MOV EWD  
 30-35 KT THRU 2055Z  
 HAIL TO 2 IN PSBL

**Explanation:**

This Convective SIGMET provides the following information: The WST indicates this report is a Convective SIGMET. The current date is the 22<sup>nd</sup> of the month and it was issued at 1855 Zulu. It is Convective SIGMET number 21C, indicating that it is the 21st consecutive report issued for the central United States. This report is valid for 2 hours until 2055 Zulu time. The Convective SIGMET is for an area from Kansas to Oklahoma to Texas, in the vicinity of a line from Goodland, Kansas, to Childress, Texas. No significant thunderstorms are being reported, but a line of thunderstorms will develop by 1955 Zulu time and will move eastward at a rate of 30-35 knots through 2055 Zulu. Hail up to 2 inches in size is possible with the developing thunderstorms.

**WINDS AND TEMPERATURE ALOFT FORECAST (FD)**

Winds and temperatures aloft forecasts provide wind and temperature forecasts for specific locations in the contiguous United States, including network locations in Hawaii and Alaska. The forecasts are made twice a day based on the radiosonde upper air observations taken at 0000Z and 1200Z.

Through 12,000 feet are true altitudes and above 18,000 feet are pressure altitudes. Wind direction is always in reference to true north and windspeed is given in knots. The temperature is given in degrees Celsius. No winds are forecast when a given level is within 1,500 feet of the station elevation. Similarly, temperatures are not forecast for any station within 2,500 feet of the station elevation.

If the windspeed is forecast to be greater than 100 knots but less than 199 knots, the computer adds 50 to the direction and subtracts 100 from the speed. To decode this type of data group, the reverse must be accomplished. For example, when the data appears as "731960," subtract 50 from the 73 and add 100 to the 19, and the wind would be 230° at 119 knots with a temperature of -60°C. If the windspeed is forecast to be 200 knots or greater, the wind group is coded as 99 knots. For example, when the data appears as "7799," subtract 50 from 77 and add 100 to 99, and the wind is 270° at 199 knots or greater. When the forecast windspeed is calm or less than 5 knots, the data group is coded "9900," which means light and variable. [Figure 11-7]

FD KWBC 151640							
BASED ON 151200Z DATA							
VALID 151800Z FOR USE 1700-2100Z							
TEMPS NEGATIVE ABV 24000							
FD	3000	6000	9000	12000	18000	24000	30000
AMA		2714	2725+00	2625-04	2531-15	2542-27	265842
DEN			2321-04	2532-08	2434-19	2441-31	235347

Figure 11-7. Winds and temperatures aloft forecast.

**Explanation of figure 11-7:**

The heading indicates that this FD was transmitted on the 15th of the month at 1640Z and is based on the 1200 Zulu radiosonde. The valid time is 1800 Zulu on the same day and should be used for the period between 1700Z and 2100Z. The heading also indicates that the temperatures above 24,000 feet MSL are negative. Since the temperatures above 24,000 feet are negative, the minus sign is omitted.

A 4-digit data group shows the wind direction in reference to true north, and the windspeed in knots. The elevation at Amarillo, TX (AMA) is 3,605 feet, so the lowest reportable altitude is 6,000 feet for the forecast winds. In this case, "2714" means the wind is forecast to be from 270° at a speed of 14 knots.

A 6-digit group includes the forecast temperature aloft. The elevation at Denver (DEN) is 5,431 feet, so the lowest reportable altitude is 9,000 feet for the winds and temperature forecast. In this case, "2321-04" indicates the wind is forecast to be from 230° at a speed of 21 knots with a temperature of -4°C.



## WEATHER CHARTS

Weather charts are graphic charts that depict current or forecast weather. They provide an overall picture of the United States and should be used in the beginning stages of flight planning. Typically, weather charts show the movement of major weather systems and fronts. Surface analysis, weather depiction, and radar summary charts are sources of current weather information. Significant weather prognostic charts provide an overall forecast weather picture.

### SURFACE ANALYSIS CHART

The surface analysis chart, depicts an analysis of the current surface weather. [Figure 11-8] This chart is a computer prepared report that is transmitted every 3 hours and covers the contiguous 48 states and adjacent areas. A surface analysis chart shows the areas of high and low pressure, fronts, temperatures, dewpoints, wind directions and speeds, local weather, and visual obstructions.

Surface weather observations for reporting points across the United States are also depicted on this chart. Each of these reporting points is illustrated by a station model. [Figure 11-9] A station model will include:

- **Type of Observation**—A round model indicates an official weather observer made the observation. A square model indicates the

observation is from an automated station. Stations located offshore give data from ships, buoys, or offshore platforms.

- **Sky Cover**—The station model depicts total sky cover and will be shown as clear, scattered, broken, overcast, or obscured/partially obscured.
- **Clouds**—Cloud types are represented by specific symbols. Low cloud symbols are placed beneath the station model, while middle and high cloud symbols are placed directly above the station model. Typically, only one type of cloud will be depicted with the station model.
- **Sea Level Pressure**—Sea level pressure given in three digits to the nearest tenth of a millibar. For 1000 mbs or greater, prefix a 10 to the three digits. For less than 1000 mbs, prefix a 9 to the three digits.
- **Pressure Change/Tendency**—Pressure change in tenths of millibars over the past 3 hours. This is depicted directly below the sea level pressure.
- **Precipitation**—A record of the precipitation that has fallen over the last 6 hours to the nearest hundredth of an inch.
- **Dewpoint**—Dewpoint is given in degrees Fahrenheit.

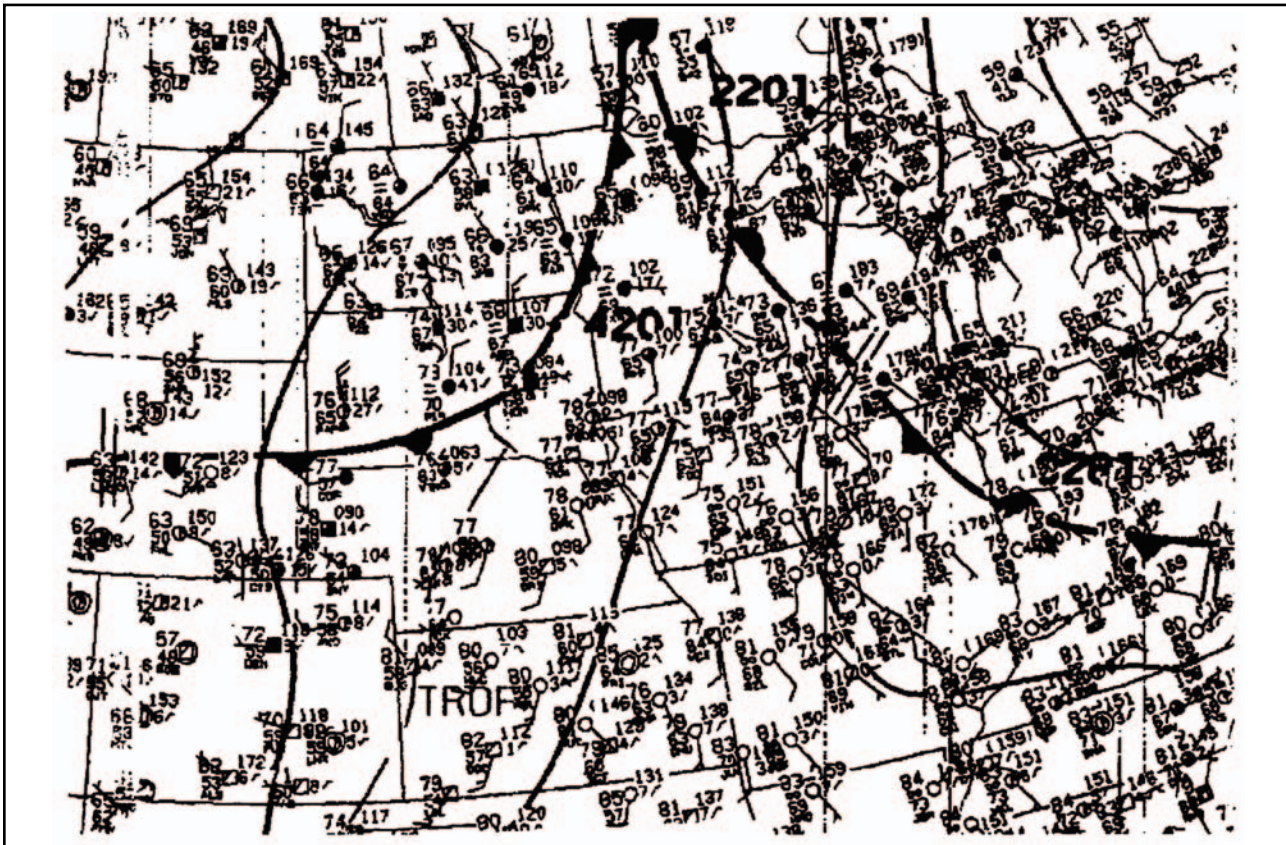

Figure 11-8. Surface analysis chart.

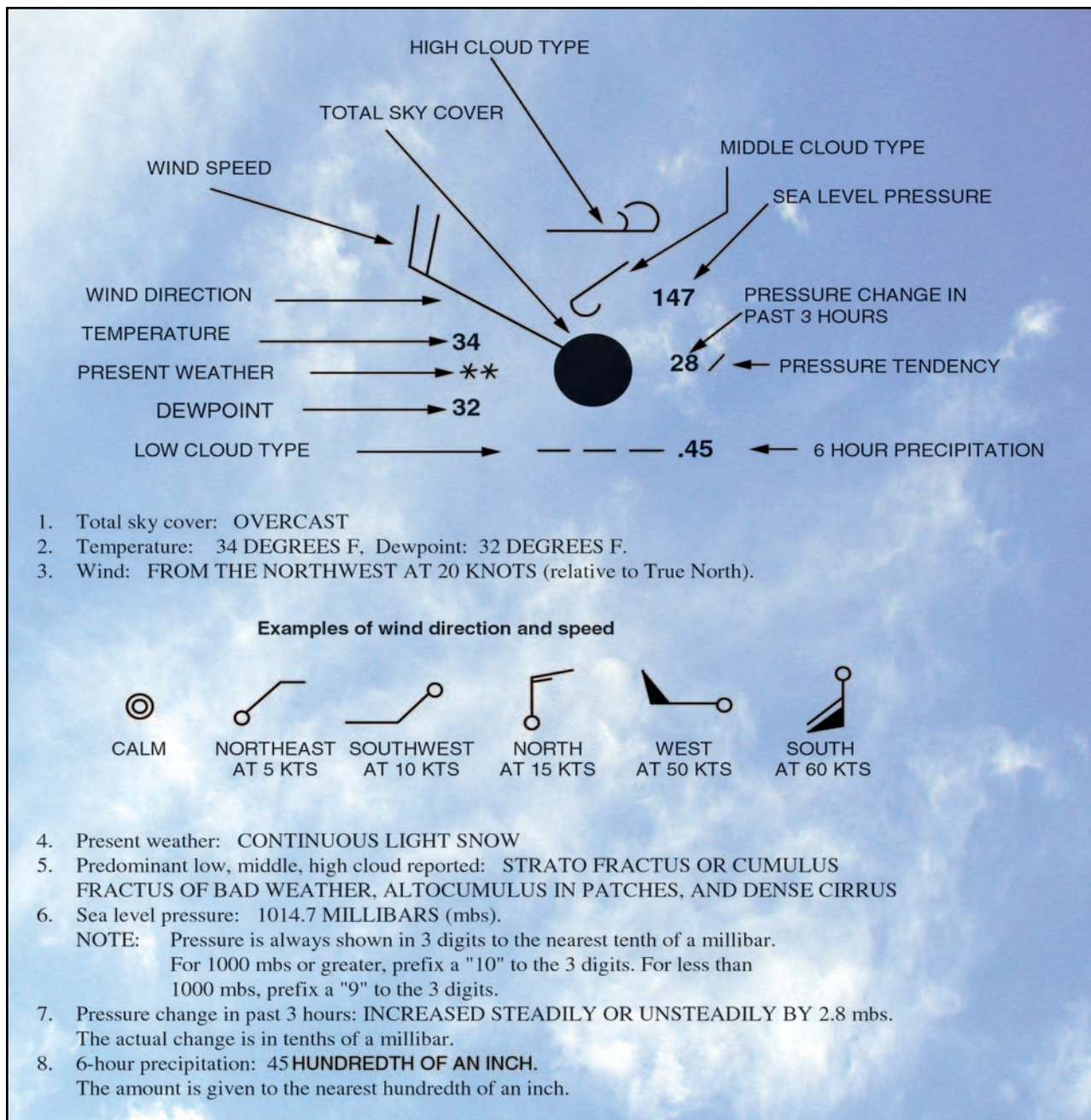

Figure 11-9. Sample station model and weather chart symbols.

- **Present Weather**—Over 100 different weather symbols are used to describe the current weather.
- **Temperature**—Temperature is given in degrees Fahrenheit.
- **Wind**—True direction of wind is given by the wind pointer line, indicating the direction from which the wind is coming. A short barb is equal to 5 knots of wind, a long barb is equal to 10 knots of wind, and a pennant is equal to 50 knots.

### WEATHER DEPICTION CHART

A weather depiction chart details surface conditions as derived from METAR and other surface observations.

The weather depiction chart is prepared and transmitted by computer every 3 hours beginning at 0100 Zulu time, and is valid at the time of the plotted data. It is designed to be used for flight planning by giving an overall picture of the weather across the United States. [Figure 11-10]

This type of chart typically displays major fronts or areas of high and low pressure. The weather depiction chart also provides a graphic display of IFR, VFR, and MVFR (marginal VFR) weather. Areas of IFR conditions (ceilings less than 1,000 feet and visibility less than 3 miles) are shown by a hatched area outlined by a smooth line. MVFR regions (ceilings 1,000 to 3,000 feet, visibility 3 to 5 miles) are shown by a

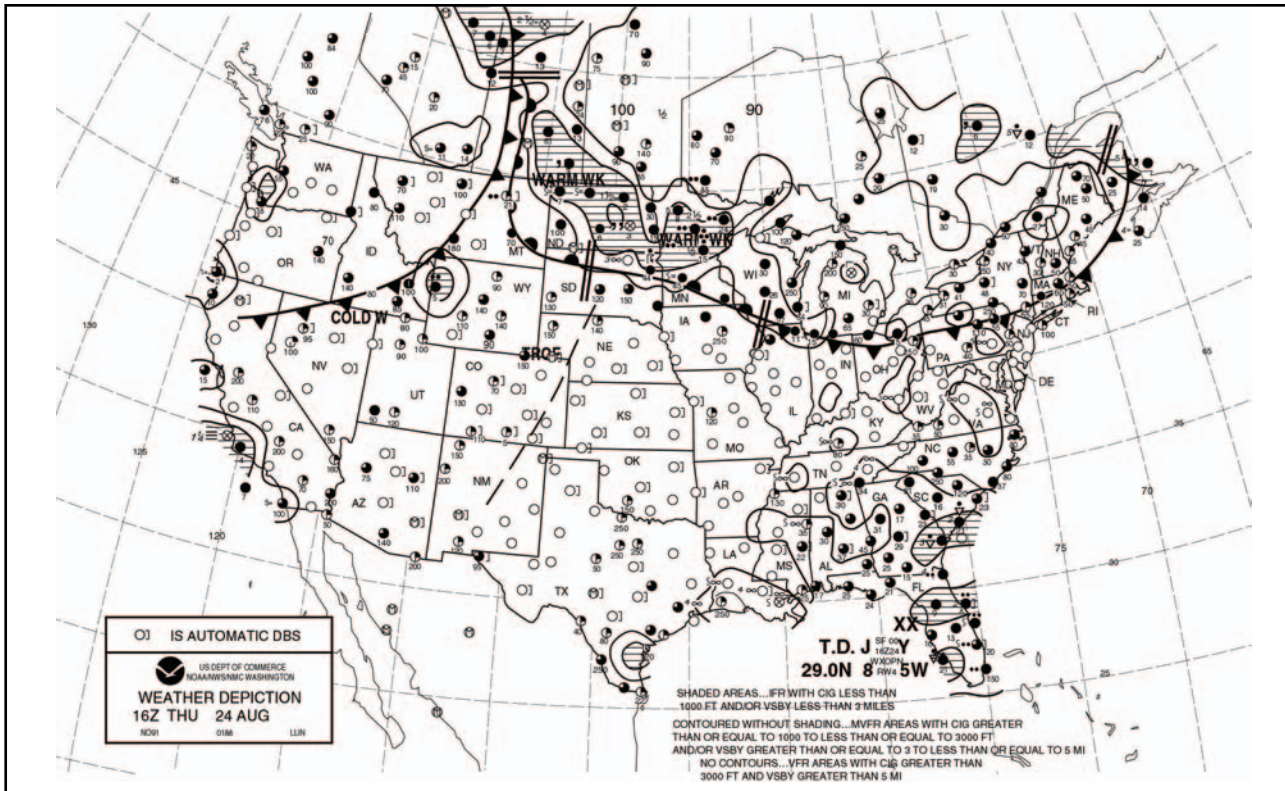

Figure 11-10. Weather depiction chart.

non-hatched area outlined by a smooth line. Areas of VFR (no ceiling or ceiling greater than 3,000 feet and visibility greater than 5 miles) are not outlined.

Weather depiction charts show a modified station model that provides sky conditions in the form of total sky cover, cloud height or ceiling, weather, and obstructions to visibility, but does not include winds or pressure readings like the surface analysis chart. A bracket ( ] ) symbol to the right of the station indicates the observation was made by an automated station. A detailed explanation of a station model is depicted in the previous discussion of surface analysis charts.

**RADAR SUMMARY CHART**

A radar summary chart is a graphically depicted collection of radar weather reports (SDs). [Figure 11-11] The chart is published hourly at 35 minutes past the hour. It displays areas of precipitation as well as information regarding the characteristics of the precipitation. [Figure 11-12] A radar summary chart includes:

- **No information**—If information is not reported, the chart will say “NA.” If no echoes are detected, the chart will say “NE.”
- **Precipitation intensity contours**—Intensity can be described as one of six levels and is shown on the chart by three contour intervals.

- **Height of tops**—The heights of the echo tops are given in hundreds of feet MSL.
- **Movement of cells**—Individual cell movement is indicated by an arrow pointing in the direction of movement. The speed of movement in knots is the number at the top of the arrow head. “LM” indicates little movement.
- **Type of precipitation**—The type of precipitation is marked on the chart using specific symbols. These symbols are not the same as used on the METAR charts.
- **Echo configuration**—Echoes are shown as being areas, cells, or lines.
- **Weather watches**—Severe weather watch areas for tornadoes and severe thunderstorms are depicted by boxes outlined with heavy dashed lines.

The radar summary chart is a valuable tool for preflight planning. It does, however, contain several limitations for the usage of the chart. This chart depicts only areas of precipitation. It will not show areas of clouds and fog with no appreciable precipitation, or the height of the tops and bases of the clouds. Radar summary charts are a depiction of current precipitation and should be used in conjunction with current METAR and weather forecasts.

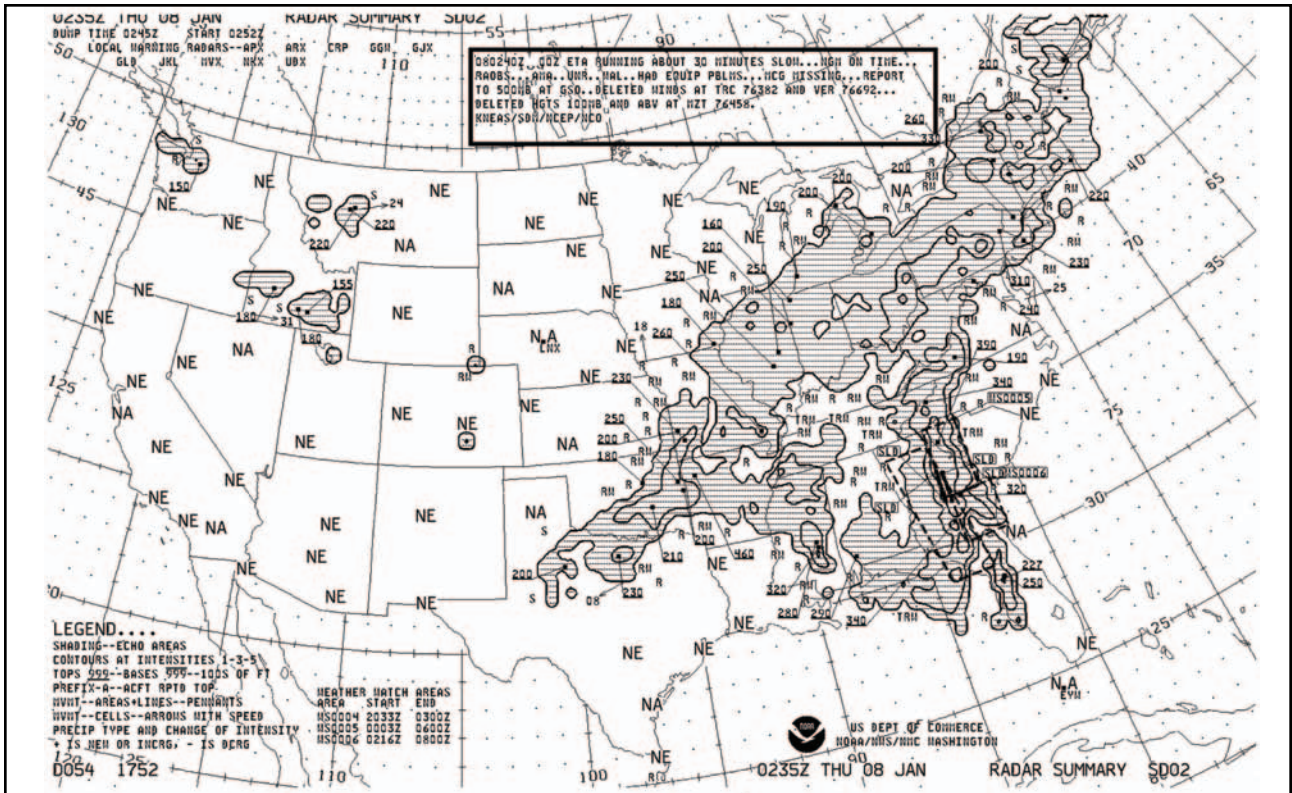

Figure 11-11. Radar summary chart.

<u>Symbol Meaning</u>		<u>Symbol Meaning</u>	
R	Rain	35	Cell movement to the northeast at 35 knots
RW	Rain shower	LM	Little movement
S	Snow	WS999	Severe thunderstorm watch number 999
SW	Snow shower	WT210	Tornado watch number 210
T	Thunderstorm	SLD	8/10 or greater coverage in a line
NA	Not available		Line of echoes
NE	No echoes		
OM	Out for maintenance		

Figure 11-12. Intensity levels and contours, and precipitation type symbols.

## SIGNIFICANT WEATHER PROGNOSTIC CHARTS

Significant Weather Prognostic Charts are available for low-level significant weather from the surface to FL240 (24,000 feet), also referred to as the 400 millibar level, and high-level significant weather from FL250 to FL600 (25,000 to 60,000 feet). The primary concern of this discussion is the low-level significant weather prognostic chart.

The low-level chart comes in two forms: the 12- and 24-hour forecast chart, and the 36 and 48 surface only forecast chart. The first chart is a four-panel chart that includes 12- and 24-hour forecasts for significant weather and surface weather. Charts are issued four times a day at 0000Z, 0600Z, 1200Z, and 1800Z. The valid time for the chart is printed on the lower left-hand corner of each panel.

The upper two panels show forecast significant weather, which may include nonconvective turbulence, freezing levels, and IFR or MVFR weather. Areas of moderate or greater turbulence are enclosed in dashed lines. Numbers within these areas give the height of the turbulence in hundreds of feet MSL. Figures below the line show the anticipated base, while figures above the line show the top of the zone of turbulence. Also shown on this panel are areas of VFR, IFR, and MVFR. IFR areas are enclosed by solid lines, MVFR areas are enclosed by scalloped lines, and the remaining, unenclosed area is designated VFR. Zigzag lines and the letters "SFC" indicate freezing levels in that area

are at the surface. Freezing level height contours for the highest freezing level are drawn at 4,000-foot intervals with dashed lines.

The lower two panels show the forecast surface weather and depicts the forecast locations and characteristics of pressure systems, fronts, and precipitation. Standard symbols are used to show fronts and pressure centers. Direction of movement of the pressure center is depicted by an arrow. The speed, in knots, is shown next to the arrow. In addition, areas of forecast precipitation and thunderstorms are outlined. Areas of precipitation that are shaded indicate at least one-half of the area is being affected by the precipitation. Unique symbols indicate the type of precipitation and the manner in which it occurs.

Figure 11-13 depicts a typical significant weather prognostic chart as well as the symbols typically used to depict precipitation. Prognostic charts are an excellent source of information for preflight planning; however, this chart should be viewed in light of current conditions and specific local area forecasts.

The 36- and 48-hour significant weather prognostic chart is an extension of the 12- and 24-hour forecast. It provides information regarding only surface weather forecasts and includes a discussion of the forecast. This chart is issued only two times a day. It typically contains forecast positions and characteristics of pressure patterns, fronts, and precipitation. An example of a 36- and 48-hour surface prognostic chart is shown in figure 11-14.

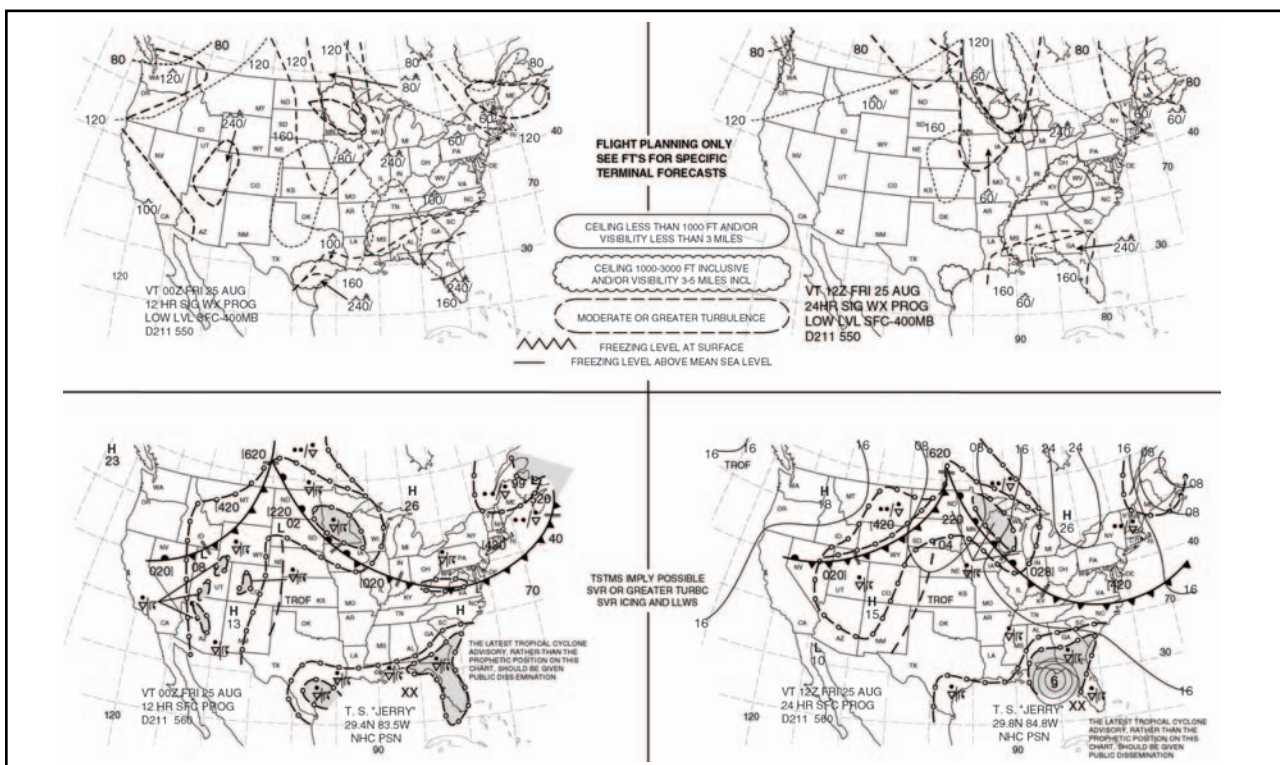

Figure 11-13. Significant weather prognostic chart.

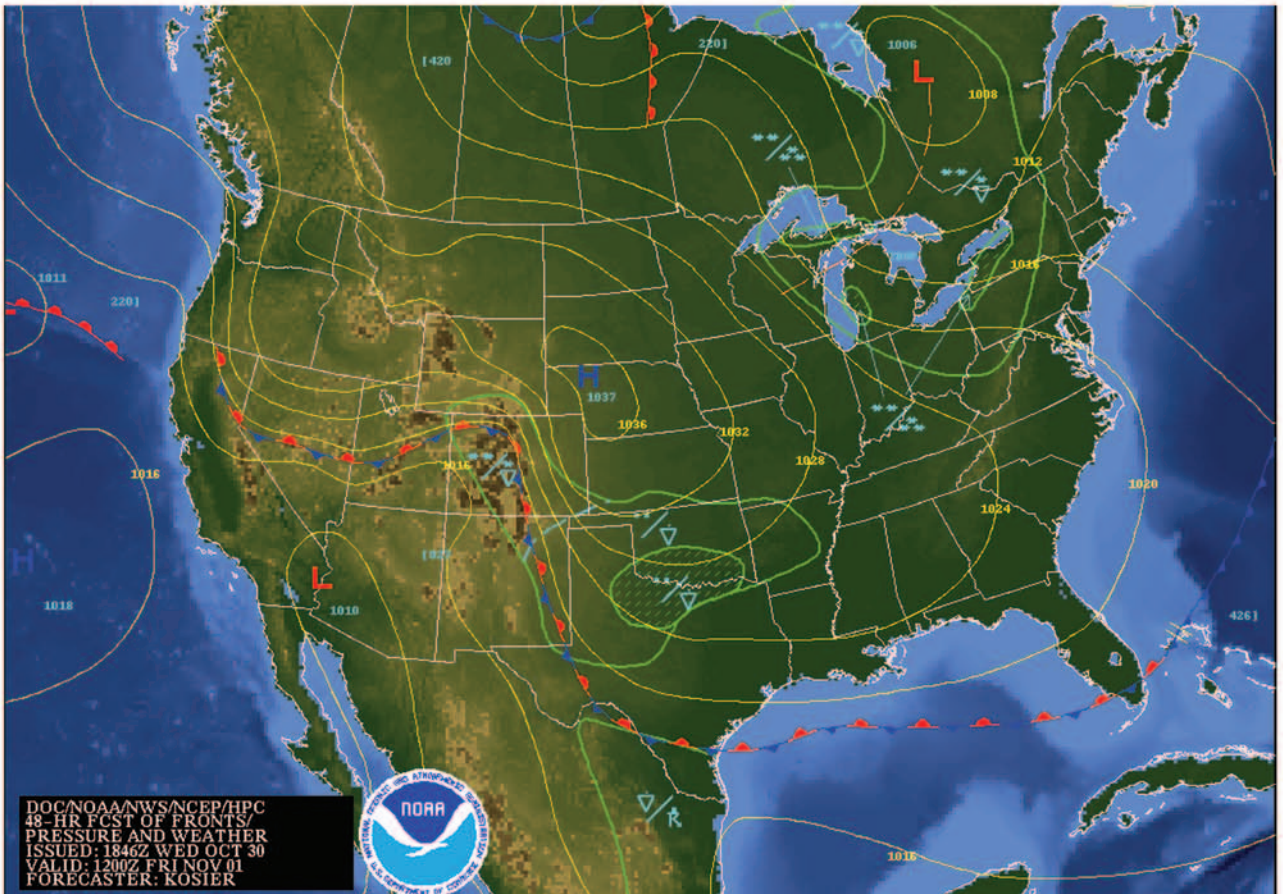
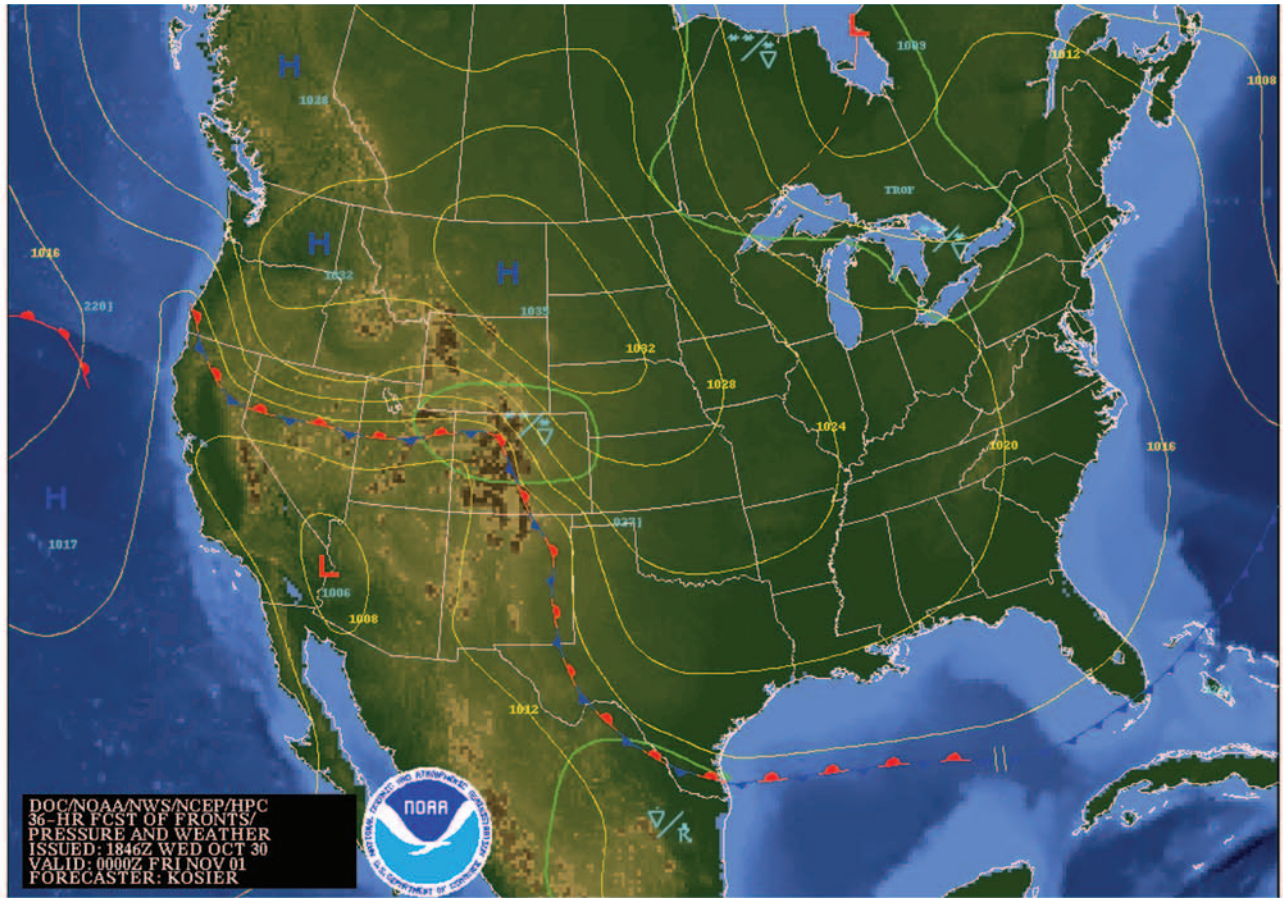

Figure 11-14. 36- and 48-hour surface prognostic chart.



# Chapter 12



## Airport Operations

Each time a pilot operates an airplane, the flight normally begins and ends at an airport. An airport may be a small sod field or a large complex utilized by air carriers. This chapter discusses airport operations and identifies features of an airport complex, as well as provides information on operating on or in the vicinity of an airport.

### TYPES OF AIRPORTS

There are two types of airports.

- Controlled Airport
- Uncontrolled Airport

#### CONTROLLED AIRPORT

A controlled airport has an operating control tower. Air traffic control (ATC) is responsible for providing for the safe, orderly, and expeditious flow of air traffic at airports where the type of operations and/or volume of traffic requires such a service. Pilots operating from a controlled airport are required to maintain two-way radio communication with air traffic controllers, and to acknowledge and comply with their instructions.

Pilots must advise ATC if they cannot comply with the instructions issued and request amended instructions. A pilot may deviate from an air traffic instruction in an emergency, but must advise ATC of the deviation as soon as possible.

#### UNCONTROLLED AIRPORT

An uncontrolled airport does not have an operating control tower. Two-way radio communications are not required, although it is a good operating practice for pilots to transmit their intentions on the specified frequency for the benefit of other traffic in the area. Figure 12-1 lists recommended communication procedures.

More information on radio communications will be discussed later in this chapter.

### SOURCES FOR AIRPORT DATA

When a pilot flies into a different airport, it is important to review the current data for that airport. This data can provide the pilot with information, such as communication frequencies, services available, closed runways, or airport construction. Three common sources of information are:

- Aeronautical Charts
- *Airport/Facility Directory* (A/FD)
- Notices to Airmen (NOTAMs)

#### AERONAUTICAL CHARTS

Aeronautical charts provide specific information on airports. Chapter 14 contains an excerpt from an aeronautical chart and an aeronautical chart legend, which provides guidance on interpreting the information on the chart.

#### AIRPORT/FACILITY DIRECTORY

The *Airport/Facility Directory* (A/FD) provides the most comprehensive information on a given airport. It contains information on airports, heliports, and seaplane bases that are open to the public. The A/FDs are contained in seven books, which are organized by regions. These A/FDs are revised every 8 weeks. Figure 12-2 contains an excerpt from a directory. For a complete listing of information provided in an A/FD and how the information may be decoded, refer to the “Directory Legend Sample” located in the front of each A/FD.

In the back of each A/FD, there is information such as special notices, parachute jumping areas, and facility



FACILITY AT AIRPORT	FREQUENCY USE	COMMUNICATION/BROADCAST PROCEDURES		
		OUTBOUND	INBOUND	PRACTICE INSTRUMENT APPROACH
UNICOM (No Tower or FSS)	Communicate with UNICOM station on published CTAF frequency (122.7, 122.8, 122.725, 122.975, or 123.0). If unable to contact UNICOM station, use self-announce procedures on CTAF.	Before taxiing and before taxiing on the runway for departure.	10 miles out. Entering downwind, base, and final. Leaving the runway.	
No Tower, FSS, or UNICOM	Self-announce on MULTICOM frequency 122.9	Before taxiing and before taxiing on the runway for departure.	10 miles out. Entering downwind, base, and final. Leaving the runway.	Departing final approach fix (name) or on final approach segment inbound.
No Tower in operation, FSS open	Communicate with FSS on CTAF frequency.	Before taxiing and before taxiing on the runway for departure.	10 miles out. Entering downwind, base, and final. Leaving the runway.	Approach completed/terminated.
FSS closed (No Tower)	Self-announce on CTAF.	Before taxiing and before taxiing on the runway for departure.	10 miles out. Entering downwind, base, and final. Leaving the runway.	
Tower or FSS not in operation	Self-announce on CTAF.	Before taxiing and before taxiing on the runway for departure.	10 miles out. Entering downwind, base, and final. Leaving the runway.	

Figure 12-1. Recommended communication procedures.

**ARKANSAS** 27

---

**FORREST CITY MUNI** (FCY) 4 S UTC-6(-5DT) N34°56.52' W90°46.50'

249 B FUEL 100LL, JET A

RWY 18-36: H3014X50 (ASPH) S-20 MIRL

RWY 36: Trees.

AIRPORT REMARKS: Attended Mon-Fri 1400-2300Z. 494 ft lgtd twr 3 miles north on centerline. Numerous glider ops launched by air tow sunrise-sunset.

COMMUNICATIONS: CTAF/UNICOM 122.8

JONESBORO FSS (JBR) TF 1-800-WX-BRIEF. NOTAM FILE JBR.

MEMPHIS CENTER APP/DEP CON 135.3

RADIO AIDS TO NAVIGATION: NOTAM FILE JBR.

GILMORE (L) VOR/DME 113.0 GQE Chan 77 N35°20.82' W90°28.69' 207° 28.3 NM to fld. 211/4E.

NDB (MHW) 332 FCY N34°56.46' W90°46.42' at fld.

Unmonitored Sun, and Mon-Sat 2300-1400Z.

MEMPHIS  
L-14F  
IAP

---

**FORT SMITH REGIONAL** (FSM) 3 SE UTC-6(-5DT) N35°20.20' W94°22.05'

469 B S4 FUEL 100LL, JET A ARFF Index A

RWY 07-25: H8000X150 (ASPH-GRVD) S-75, D-175, DT-295 HIRL 0.6% up W

RWY 07: MALSR. Tree. Arresting device.

RWY 25: MALSR. VASI(V4L)—GA 2.9° TCH 60'. Tree. Arresting device.

RWY 01-19: H5002X150 (ASPH-GRVD) S-55, D-70, DT-120 MIRL

RWY 01: Railroad. RWY 19: PAPI(P4L)—GA 3.0° TCH 40'. Tree.

**RUNWAY DECLARED DISTANCE INFORMATION**

RWY 01: TORA-5002 TODA-5002 ASDA-5002 LDA-5002

RWY 19: TORA-5002 TODA-5002 ASDA-5002 LDA-5002

RWY 07: TORA-8000 TODA-8000 ASDA-8000 LDA-8000

RWY 25: TORA-8000 TODA-8000 ASDA-8000 LDA-8000

AIRPORT REMARKS: Attended continuously. Rwy 01-19 restricted to prop acft unless crosswinds on Rwy 07-25 exceed acft safe operating capability. Acft training prohibited on Rwy 01-19 (including practice approaches, touch and

MEMPHIS  
H-46, L-6H, 130  
IAP, AD

Figure 12-2. Airport/Facility Directory excerpt.

telephone numbers. It would be helpful to review an A/FD to become familiar with the information it contains.

## NOTICES TO AIRMEN

Notices to Airmen (NOTAMs) provide the most current information available. They provide time-critical information on airports and changes that affect the national airspace system and are of concern to instrument flight rule (IFR) operations. NOTAM information is classified into three categories. These are NOTAM-D or distant, NOTAM-L or local, and flight data center (FDC) NOTAMs. NOTAM-Ds are attached to hourly weather reports and are available at flight service stations (AFSS/FSS). NOTAM-Ls include items of a local nature, such as taxiway closures or construction near a runway. These NOTAMs are maintained at the FSS nearest the airport affected. NOTAM-Ls must be requested from an FSS other than the one nearest the local airport for which the NOTAM was issued. FDC NOTAMs are issued by the National Flight Data Center and contain regulatory information, such as temporary flight restrictions or an amendment to instrument approach procedures. The NOTAM-Ds and FDC NOTAMs are contained in the Notices to Airmen publication, which is issued every 28 days. Prior to any flight, pilots should check for any NOTAMs that could affect their intended flight.

## AIRPORT MARKINGS AND SIGNS

There are markings and signs used at airports, which provide directions and assist pilots in airport operations. Some of the most common markings and signs will be discussed. Additional information may be found in the *Aeronautical Information Manual* (AIM).

### RUNWAY MARKINGS

Runway markings vary depending on the type of operations conducted at the airport. Figure 12-3 shows a runway that is approved as a precision instrument approach runway and also shows some other common runway markings. A basic VFR runway may only have centerline markings and runway numbers.

Since aircraft are affected by the wind during takeoffs and landings, runways are laid out according to the local prevailing winds. Runway numbers are in reference to magnetic north. Certain airports have two or even three runways laid out in the same direction. These are referred to as parallel runways and are distinguished by a letter being added to the runway number. Examples are runway 36L (left), 36C (center), and 36R (right).

Another feature of some runways is a displaced threshold. A threshold may be displaced because of an obstruction near the end of the runway. Although this

portion of the runway is not to be used for landing, it may be available for taxiing, takeoff, or landing rollout.

Some airports may have a blast pad/stopway area. The blast pad is an area where a propeller or jet blast can dissipate without creating a hazard. The stopway area is paved in order to provide space for an airplane to decelerate and stop in the event of an aborted takeoff. These areas cannot be used for takeoff or landing.

### TAXIWAY MARKINGS

Airplanes use taxiways to transition from parking areas to the runway. Taxiways are identified by a continuous yellow centerline stripe. A taxiway may include edge markings to define the edge of the taxiway. This is usually done when the taxiway edge does not correspond with the edge of the pavement. If an edge marking is a continuous line, the paved shoulder is not intended to be used by an airplane. If it is a dashed marking, an airplane may use that portion of the pavement. Where a taxiway approaches a runway, there may be a holding position marker. These consist of four yellow lines (two solid and two dashed). The solid lines are where the airplane is to hold. At some controlled airports, holding position markings may be found on a runway. They are used when there are intersecting runways, and air traffic control issues instructions such as “cleared to land—hold short of runway 30.”

### OTHER MARKINGS

Some of the other markings found on the airport include vehicle roadway markings, VOR receiver checkpoint markings, and non-movement area boundary markings.

Vehicle roadway markings are used when necessary to define a pathway for vehicle crossing areas that are also intended for aircraft. These markings usually consist of a solid white line to delineate each edge of the roadway and a dashed line to separate lanes within the edges of the roadway.

A VOR receiver checkpoint marking consists of a painted circle with an arrow in the middle. The arrow is aligned in the direction of the checkpoint azimuth. This allows pilots to check aircraft instruments with navigational aid signals.

A non-movement area boundary marking delineates a movement area under air traffic control. These markings are yellow and located on the boundary between the movement and non-movement area. They normally consist of two yellow lines (one solid and one dashed).

### AIRPORT SIGNS

There are six types of signs that may be found at airports. The more complex the layout of an airport, the

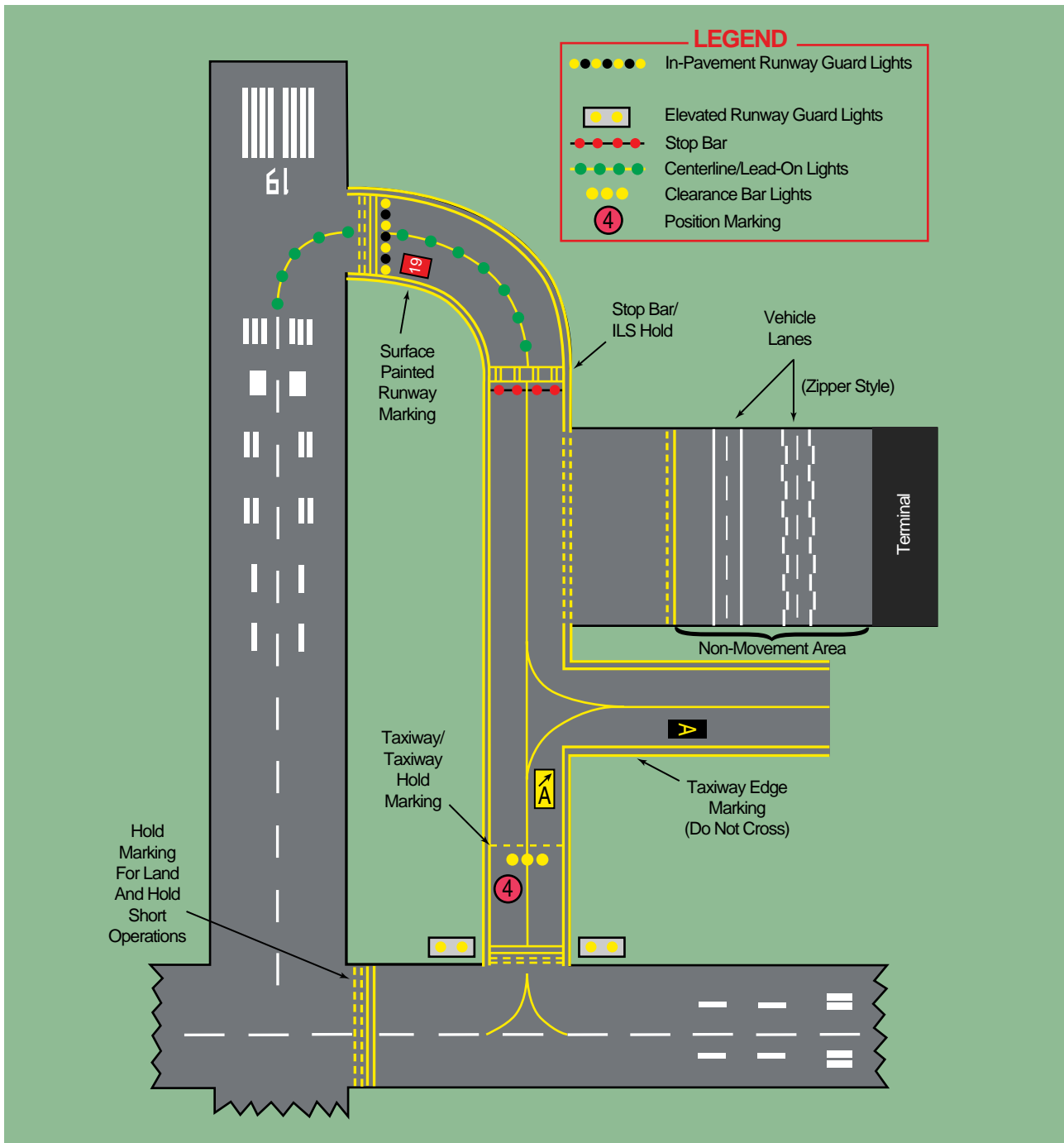

Figure 12-3. Selected airport markings and surface lighting.

more important the signs become to pilots. Figure 12-4 shows examples of signs, their purpose, and appropriate pilot action. The six types of signs are:

- **Mandatory Instruction Signs**—have a red background with a white inscription. These signs denote an entrance to a runway, a critical area, or a prohibited area.
- **Location Signs**—are black with yellow inscription and a yellow border and do not have arrows. They are used to identify a taxiway or runway location, to identify the boundary of the runway,

or identify an instrument landing system (ILS) critical area.

- **Direction Signs**—have a yellow background with black inscription. The inscription identifies the designation of the intersecting taxiway(s) leading out of an intersection.
- **Destination Signs**—have a yellow background with black inscription and also contain arrows. These signs provide information on locating things, such as runways, terminals, cargo areas, and civil aviation areas.











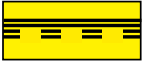

<b>AIRPORT SIGN SYSTEMS</b>	
<i>TYPE OF SIGN AND ACTION OR PURPOSE</i>	<i>TYPE OF SIGN AND ACTION OR PURPOSE</i>
<b>4-22</b> <b>Taxiway/Runway Hold Position:</b> Hold short of runway on taxiway	 <b>Runway Safety Area/Obstacle Free Zone Boundary:</b> Exit boundary of runway protected areas
<b>26-8</b> <b>Runway/Runway Hold Position:</b> Hold short of intersecting runway	 <b>ILS Critical Area Boundary:</b> Exit boundary of ILS critical area
<b>8-APCH</b> <b>Runway Approach Hold Position:</b> Hold short of aircraft on approach	 <b>Taxiway Direction:</b> Defines direction & designation of intersecting taxiway(s)
<b>ILS</b> <b>ILS Critical Area Hold Position:</b> Hold short of ILS approach critical area	 <b>Runway Exit:</b> Defines direction & designation of exit taxiway from runway
 <b>No Entry:</b> Identifies paved areas where aircraft entry is prohibited	 <b>Outbound Destination:</b> Defines directions to takeoff runways
 <b>Taxiway Location:</b> Identifies taxiway on which aircraft is located	 <b>Inbound Destination:</b> Defines directions for arriving aircraft
 <b>Runway Location:</b> Identifies runway on which aircraft is located	 <b>Taxiway Ending Marker</b> Indicates taxiway does not continue
 <b>Runway Distance Remaining</b> Provides remaining runway length in 1,000 feet increments	 <b>Direction Sign Array:</b> Identifies location in conjunction with multiple intersecting taxiways

Figure 12-4. Airport signs.

- Information Signs**—have a yellow background with black inscription. These signs are used to provide the pilot with information on such things as areas that cannot be seen from the control tower, applicable radio frequencies, and noise abatement procedures. The airport operator determines the need, size, and location of these signs.
- Runway Distance Remaining Signs**—have a black background with white numbers. The numbers indicate the distance of the remaining runway in thousands of feet.

## AIRPORT LIGHTING

The majority of airports have some type of lighting for night operations. The variety and type of lighting systems depends on the volume and complexity of operations at a given airport. Airport lighting is standardized so that airports use the same light colors for runways and taxiways.

### AIRPORT BEACON

Airport beacons help a pilot identify an airport at night. The beacons are operated from dusk till dawn and sometimes they are turned on if the ceiling is less than 1,000 feet and/or the ground visibility is less than 3 statute miles (visual flight rules minimums). However, there is no requirement for this, so a pilot has the responsibility of determining if the weather is VFR.

The beacon has a vertical light distribution to make it most effective from 1-10° above the horizon, although it can be seen well above or below this spread. The beacon may be an omnidirectional capacitor-discharge device, or it may rotate at a constant speed, which produces the visual effect of flashes at regular intervals. The combination of light colors from an airport beacon indicates the type of airport. [Figure 12-5]

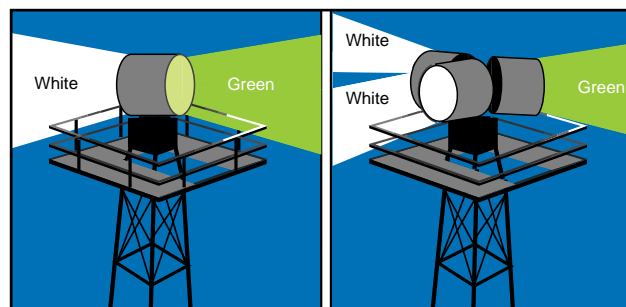

Figure 12-5. Airport rotating beacons.

Some of the most common beacons are:

- Flashing white and green for civilian land airports.
- Flashing white and yellow for a water airport.
- Flashing white, yellow, and green for a heliport.
- Two quick white flashes followed by a green flash identifies a military airport.

## APPROACH LIGHT SYSTEMS

Approach light systems are primarily intended to provide a means to transition from instrument flight to visual flight for landing. The system configuration depends on whether the runway is a precision or nonprecision instrument runway. Some systems include sequenced flashing lights, which appear to the pilot as a ball of light traveling toward the runway at high speed. Approach lights can also aid pilots operating under VFR at night.

## VISUAL GLIDESLOPE INDICATORS

Visual glideslope indicators provide the pilot with glidepath information that can be used for day or night approaches. By maintaining the proper glidepath as provided by the system, a pilot should have adequate obstacle clearance and should touch down within a specified portion of the runway.

## VISUAL APPROACH SLOPE INDICATOR

Visual approach slope indicator (VASI) installations are the most common visual glidepath systems in use. The VASI provides obstruction clearance within 10° of the runway extended runway centerline, and to 4 nautical miles (NM) from the runway threshold.

A VASI consists of light units arranged in bars. There are 2-bar and 3-bar VASIs. The 2-bar VASI has near and far light bars and the 3-bar VASI has near, middle, and far light bars. Two-bar VASI installations provide one visual glidepath which is normally set at 3°. The 3-bar system provides two glidepaths with the lower glidepath normally set at 3° and the upper glidepath one-fourth degree above the lower glidepath.

The basic principle of the VASI is that of color differentiation between red and white. Each light unit projects a beam of light having a white segment in the upper part of the beam and a red segment in the lower part of the beam. The lights are arranged so the pilot will see the combination of lights shown in figure 12-6 to indicate below, on, or above the glidepath.

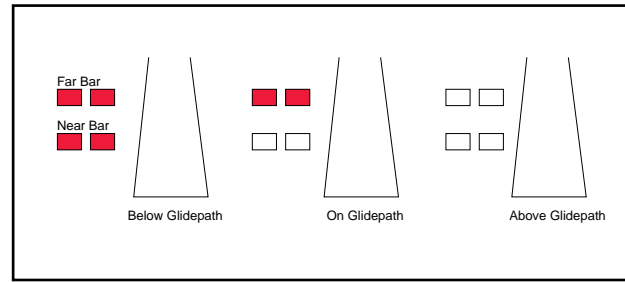

Figure 12-6. 2-Bar VASI system.

## OTHER GLIDESLOPE SYSTEMS

A precision approach path indicator (PAPI) uses lights similar to the VASI system except they are installed in a single row, normally on the left side of the runway. [Figure 12-7]

A tri-color system consists of a single light unit projecting a three-color visual approach path. A below the glidepath indication is red, on the glidepath color is green, and above the glidepath is indicated by amber. When descending below the glidepath, there is a small area of dark amber. Pilots should not mistake this area for an “above the glidepath” indication. [Figure 12-8]

There are also pulsating systems, which consist of a single light unit projecting a two-color visual approach path. A below the glidepath indication is shown by a steady red light, slightly below is indicated by pulsating red, on the glidepath is indicated by a steady white light, and a pulsating white light indicates above the glidepath. [Figure 12-9]

## RUNWAY LIGHTING

There are various lights that identify parts of the runway complex. These assist a pilot in safely making a takeoff or landing during night operations.

## RUNWAY END IDENTIFIER LIGHTS

Runway end identifier lights (REIL) are installed at many airfields to provide rapid and positive identifi-

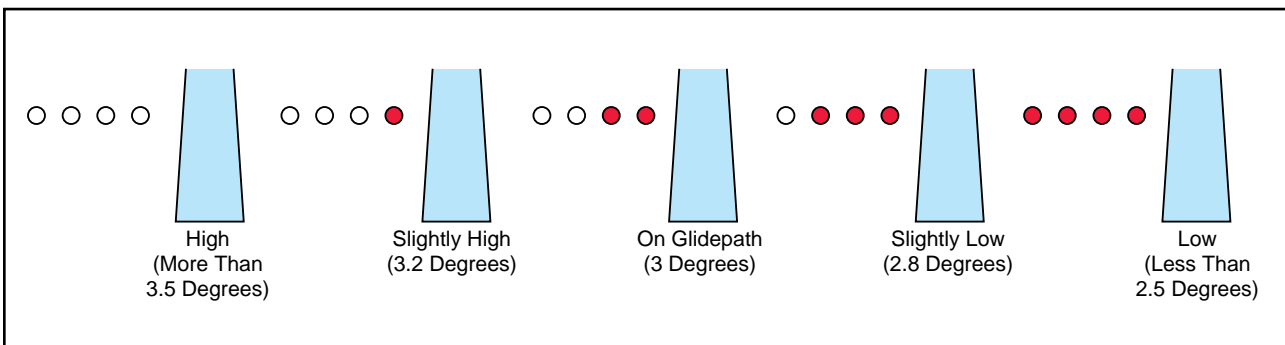

Figure 12-7. Precision approach path indicator.

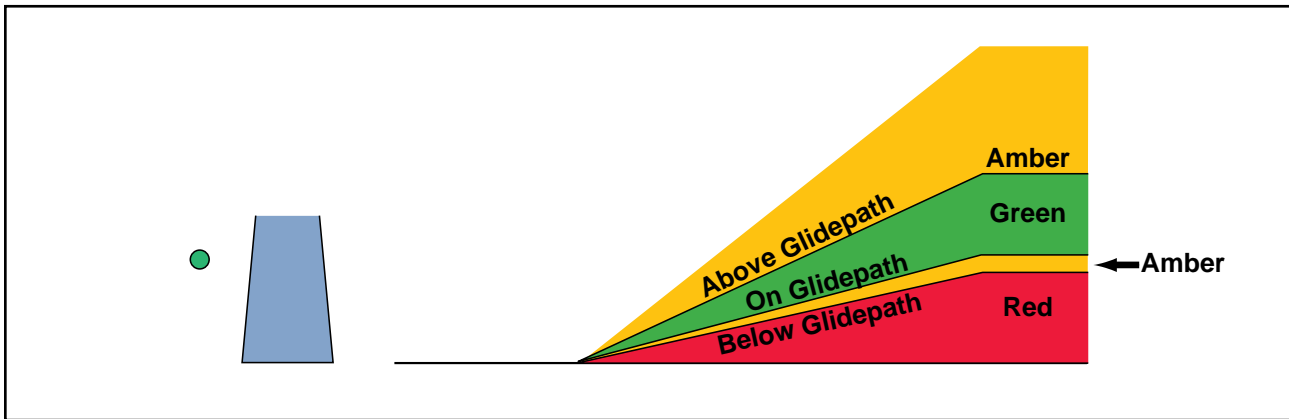

Figure 12-8. Tri-color visual approach slope indicator.

cation of the approach end of a particular runway. The system consists of a pair of synchronized flashing lights located laterally on each side of the runway threshold. REILs may be either omnidirectional or unidirectional facing the approach area.

### RUNWAY EDGE LIGHTS

Runway edge lights are used to outline the edges of runways at night or during low visibility conditions. These lights are classified according to the intensity they are capable of producing. They are classified as high intensity runway lights (HIRL), medium intensity runway lights (MIRL), or low intensity runway lights (LIRL). The HIRL and MIRL have variable intensity settings. These lights are white, except on instrument runways, where amber lights are used on the last 2,000 feet or half the length of the runway, whichever is less. The lights marking the end of the runway are red.

### IN-RUNWAY LIGHTING

Touchdown zone lights (TDZL), runway centerline lights (RCLS), and taxiway turnoff lights are installed

on some precision runways to facilitate landing under adverse visibility conditions. TDZLs are two rows of transverse light bars disposed symmetrically about the runway centerline in the runway touchdown zone. RCLS consists of flush centerline lights spaced at 50 foot intervals beginning 75 feet from the landing threshold. Taxiway turnoff lights are flush lights, which emit a steady green color.

### CONTROL OF AIRPORT LIGHTING

Airport lighting is controlled by air traffic controllers at controlled airports. At uncontrolled airports, the lights may be on a timer, or where an FSS is located at an airport, the FSS personnel may control the lighting. A pilot may request various light systems be turned on or off and also request a specified intensity, if available, from ATC or FSS personnel. At selected uncontrolled airports, the pilot may control the lighting by using the radio. This is done by selecting a specified frequency and clicking the radio microphone. For information on pilot controlled lighting at

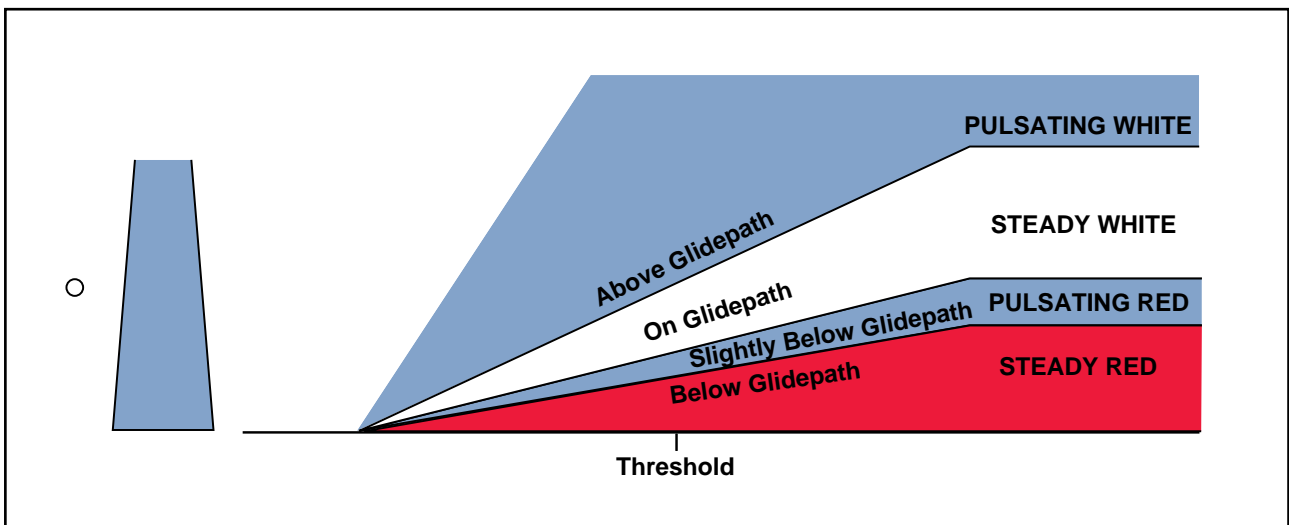

Figure 12-9. Pulsating visual approach slope indicator.

various airports, refer to the *Airport/Facility Directory*. [Figure 12-10]

KEY MIKE	FUNCTION
7 times within 5 seconds	Highest intensity available
5 times within 5 seconds	Medium or lower intensity (Lower REIL or REIL off)
3 times within 5 seconds	Lowest intensity available (Lower REIL or REIL off)

Figure 12-10. Radio control runway lighting.

## TAXIWAY LIGHTS

Omnidirectional taxiway lights outline the edges of the taxiway and are blue in color. At many airports, these edge lights may have variable intensity settings that may be adjusted by an air traffic controller when deemed necessary or when requested by the pilot. Some airports also have taxiway centerline lights that are green in color.

## OBSTRUCTION LIGHTS

Obstructions are marked or lighted to warn pilots of their presence during daytime and nighttime conditions. Obstruction lighting can be found both on and off an airport to identify obstructions. They may be marked or lighted in any of the following conditions.

- **Red Obstruction Lights**—either flash or emit a steady red color during nighttime operations, and the obstructions are painted orange and white for daytime operations.
- **High Intensity White Obstruction Light**—flashes high intensity white lights during the daytime with the intensity reduced for nighttime.
- **Dual Lighting**—is a combination of flashing red beacons and steady red lights for nighttime operation, and high intensity white lights for daytime operations.

## WIND DIRECTION INDICATORS

It is important for a pilot to know the direction of the wind. At facilities with an operating control tower, this information is provided by ATC. Information may also be provided by FSS personnel located at a particular airport or by requesting information on a common traffic advisory frequency (CTAF) at airports that have the capacity to receive and broadcast on this frequency.

When none of these services is available, it is possible to determine wind direction and runway in use by visual wind indicators. A pilot should check these wind indicators even when information is provided on the CTAF at a given airport because there is no assurance that the information provided is accurate.

Wind direction indicators include a wind sock, wind tee, or tetrahedron. These are usually located in a central location near the runway and may be placed in the center of a segmented circle, which will identify the traffic pattern direction, if it is other than the standard left-hand pattern. [Figures 12-11 and 12-12]

The wind sock is a good source of information since it not only indicates wind direction, but allows the pilot to estimate the wind velocity and gusts or factor. The wind sock extends out straighter in strong winds and will tend to move back and forth when the wind is gusty. Wind tees and tetrahedrons can swing freely, and will align themselves with the wind direction. The wind tee and tetrahedron can also be manually set to align with the runway in use; therefore, a pilot should also look at the wind sock, if available.

## RADIO COMMUNICATIONS

Operating in and out of a controlled airport, as well as in a good portion of the airspace system, requires that an aircraft have two-way radio communication capability. For this reason, a pilot should be knowledgeable of radio station license requirements and radio communications equipment and procedures.

## RADIO LICENSE

There is no license requirement for a pilot operating in the United States; however, a pilot who operates internationally is required to hold a restricted radiotelephone permit issued by the Federal Communications Commission (FCC). There is also no station license requirement for most general aviation aircraft operating in the United States. A station license is required however for an aircraft which is operating internationally, which uses other than a very high frequency (VHF) radio, and which meets other criteria.

## RADIO EQUIPMENT

In general aviation, the most common types of radios are VHF. A VHF radio operates on frequencies between 118.0 and 136.975 and is classified as 720 or 760 depending on the number of channels it can accommodate. The 720 and 760 uses .025 spacing (118.025, 118.050) with the 720 having a frequency range up to 135.975 and the 760 going up to 136.975. VHF radios are limited to line of sight transmissions;

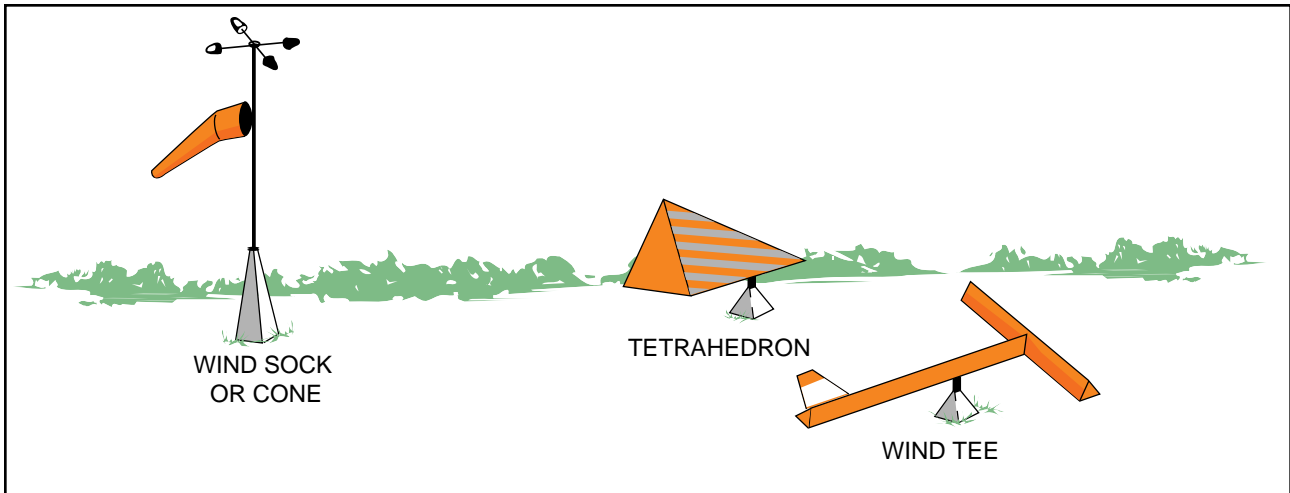

Figure 12-11. Wind direction indicators.

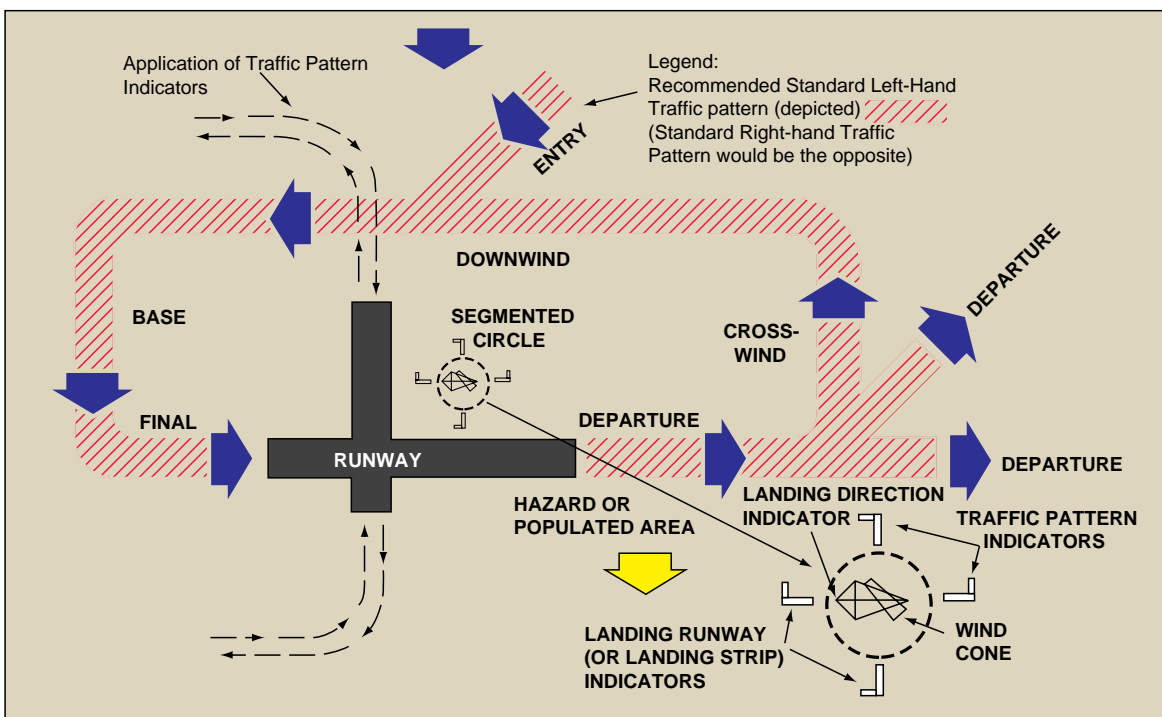

Figure 12-12. Segmented circle and airport traffic pattern.

therefore, aircraft at higher altitudes are able to transmit and receive at greater distances.

Using proper radio phraseology and procedures will contribute to a pilot's ability to operate safely and efficiently in the airspace system. A review of the Pilot/Controller Glossary contained in the *Aeronautical Information Manual (AIM)* will assist a pilot in the use and understanding of standard terminology. The AIM also contains many examples of radio communications, which should be helpful.

The International Civil Aviation Organization (ICAO) has adopted a phonetic alphabet, which should be used in radio communications. When communicating with

ATC, pilots should use this alphabet to identify their aircraft. [Figure 12-13]

### LOST COMMUNICATION PROCEDURES

It is possible that a pilot might experience a malfunction of the radio. This might cause the transmitter, receiver, or both to become inoperative. If a receiver becomes inoperative and a pilot needs to land at a controlled airport, it is advisable to remain outside or above Class D airspace until the direction and flow of traffic is determined. A pilot should then advise the tower of the aircraft type, position, altitude, and intention to land. The pilot should continue, enter the pattern, report a position as appropriate, and watch



CHARACTER	MORSE CODE	TELEPHONY	PHONIC (PRONUNCIATION)
A	•-	Alfa	(AL-FAH)
B	-•••	Bravo	(BRAH-VOH)
C	-••	Charlie	(CHAR-LEE) OR (SHAR-LEE)
D	-••	Delta	(DELL-TAH)
E	•	Echo	(ECK-OH)
F	•••	Foxtrot	(FOKS-TROT)
G	--•	Golf	(GOLF)
H	••••	Hotel	(HOH-TEL)
I	••	India	(IN-DEE-AH)
J	•---	Juliet	(JEW-LEE-ETT)
K	-•-	Kilo	(KEY-LOH)
L	•••	Lima	(LEE-MAH)
M	--	Mike	(MIKE)
N	-•	November	(NO-VEM-BER)
O	---	Oscar	(OSS-CAH)
P	•••	Papa	(PAH-PAH)
Q	--••	Quebec	(KEH-BECK)
R	••-	Romeo	(ROW-ME-OH)
S	•••	Sierra	(SEE-AIR-RAH)
T	-	Tango	(TANG-GO)
U	••-	Uniform	(YOU-NEE-FORM) OR (OO-NEE-FORM)
V	•••-	Victor	(VIK-TAH)
W	••-	Whiskey	(WISS-KEY)
X	-••-	Xray	(ECKS-RAY)
Y	-••	Yankee	(YANG-KEY)
Z	--••	Zulu	(ZOO-LOO)
1	•----	One	(WUN)
2	••---	Two	(TOO)
3	•••--	Three	(TREE)
4	••••-	Four	(FOW-ER)
5	•••••	Five	(FIFE)
6	-••••	Six	(SIX)
7	--•••	Seven	(SEV-EN)
8	----•	Eight	(AIT)
9	-----	Nine	(NIN-ER)
0	-----	Zero	(ZEE-RO)

Figure 12-13. Phonetic alphabet.

for light signals from the tower. Light signal colors and their meanings are contained in figure 12-14.

If the transmitter becomes inoperative, a pilot should follow the previously stated procedures and also monitor the appropriate air traffic control frequency. During daylight hours air traffic control transmissions may be acknowledged by rocking the wings, and at night by blinking the landing light.

When both receiver and transmitter are inoperative, the pilot should remain outside of Class D airspace until the flow of traffic has been determined and then enter the pattern and watch for light signals.

If a radio malfunctions prior to departure, it is advisable to have it repaired, if possible. If this is not possible, a

call should be made to air traffic control and the pilot should request authorization to depart without two-way radio communications. If authorization is given to depart, the pilot will be advised to monitor the appropriate frequency and/or watch for light signals as appropriate.

## AIR TRAFFIC CONTROL SERVICES

Besides the services provided by FSS as discussed in Chapter 11, there are numerous other services provided by ATC. In many instances a pilot is required to have contact with air traffic control, but even when not required, a pilot will find it helpful to request their services.

## PRIMARY RADAR

Radar is a method whereby radio waves are transmitted into the air and are then received when they have been reflected by an object in the path of the beam. Range is







LIGHT GUN SIGNALS			
COLOR AND TYPE OF SIGNAL	MOVEMENT OF VEHICLES, EQUIPMENT AND PERSONNEL	AIRCRAFT ON THE GROUND	AIRCRAFT IN FLIGHT
<b>STEADY GREEN</b> 	Cleared to cross, proceed or go	Cleared for takeoff	Cleared to land
<b>FLASHING GREEN</b> 	Not applicable	Cleared for taxi	Return for landing (to be followed by steady green at the proper time)
<b>STEADY RED</b> 	STOP	STOP	Give way to other aircraft and continue circling
<b>FLASHING RED</b> 	Clear the taxiway/runway	Taxi clear of the runway in use	Airport unsafe, do not land
<b>FLASHING WHITE</b> 	Return to starting point on airport	Return to starting point on airport	Not applicable
<b>ALTERNATING RED AND GREEN</b> 	Exercise Extreme Caution!!!!	Exercise Extreme Caution!!!!	Exercise Extreme Caution!!!!

Figure 12-14. Light gun signals.

determined by measuring the time it takes (at the speed of light) for the radio wave to go out to the object and then return to the receiving antenna. The direction of a detected object from a radar site is determined by the position of the rotating antenna when the reflected portion of the radio wave is received.

Modern radar is very reliable and there are seldom outages. This is due to reliable maintenance and improved equipment. There are, however, some limitations which may affect air traffic control services and prevent a controller from issuing advisories concerning aircraft which are not under their control and cannot be seen on radar.

The characteristics of radio waves are such that they normally travel in a continuous straight line unless they are “bent” by atmospheric phenomena such as temperature inversions, reflected or attenuated by dense objects such as heavy clouds and precipitation, or screened by high terrain features.

### AIR TRAFFIC CONTROL RADAR BEACON SYSTEM

The air traffic control radar beacon system (ATCRBS) is often referred to as “secondary surveillance radar.” This system consists of three components and helps in alleviating some of the limitations associated with primary radar. The three components are an interrogator, transponder, and radarscope. The advantages of ATCRBS are the reinforcement of radar targets, rapid target identification, and a unique display of selected codes.

### TRANSPONDER

The transponder is the airborne portion of the secondary surveillance radar system and a system with which a pilot should be familiar. The ATCRBS cannot display the secondary information unless an aircraft is equipped with a transponder. A transponder is also required to operate in certain controlled airspace. Airspace is discussed in chapter 13.

A transponder code consists of four numbers from zero to seven (4,096 possible codes). There are some standard codes, or ATC may issue a four-digit code to an aircraft. When a controller requests a code or function on the transponder, the word “squawk” may be used. Figure 12-15 lists some standard transponder phraseology.

### RADAR TRAFFIC INFORMATION SERVICE

Radar equipped air traffic control facilities provide radar assistance to VFR aircraft provided the aircraft can communicate with the facility and are within radar coverage. This basic service includes safety alerts, traffic advisories, limited vectoring when requested, and sequencing at locations where this procedure has been established. In addition to basic radar service, terminal radar service area (TRSA) has been implemented at certain terminal locations. The purpose of this service is to provide separation between all participating VFR aircraft and all IFR aircraft operating within the TRSA. Class C service provides approved separation between IFR and VFR aircraft, and sequencing of VFR aircraft to the primary airport. Class B service provides approved separation of aircraft based on IFR, VFR,

<b>RADAR BEACON PHRASEOLOGY</b>	
SQUAWK (number)	Operate radar beacon transponder on designated code in MODE A/3
IDENT	Engage the "IDENT" feature (military I/P) of the transponder.
SQUAWK (number) and IDENT	Operate transponder on specified code in MODE A/3 and engage the "IDENT" (military I/P) feature.
SQUAWK STANDBY	Switch transponder to standby position.
SQUAWK LOW/NORMAL	Operate transponder on low or normal sensitivity as specified. Transponder is operated in "NORMAL" position unless ATC specifies "LOW" ("ON" is used instead of "NORMAL" as a master control label on some types of transponders).
SQUAWK ALTITUDE	Activate MODE C with automatic altitude reporting.
STOP ALTITUDE SQUAWK	Turn off altitude reporting switch and continue transmitting MODE C framing pulses. If your equipment does not have this capability, turn off MODE C.
STOP SQUAWK (mode in use)	Switch off specified mode. (Used for military aircraft when the controller is unaware of military service requirements for the aircraft to continue operation on another MODE.)
STOP SQUAWK	Switch off transponder.
SQUAWK MAYDAY	Operate transponder in the emergency position (MODE A Code 7700 for civil transponder. MODE 3 Code 7700 and emergency feature for military transponder.)
SQUAWK VFR	Operate radar beacon transponder on Code 1200 in the MODE A/3, or other appropriate VFR code.

**Figure 12-15. Transponder phraseology.**

and/or weight, and sequencing of VFR arrivals to the primary airport(s).

ATC issues traffic information based on observed radar targets. The traffic is referenced by azimuth from the aircraft in terms of the 12-hour clock. Also the distance in nautical miles, direction in which the target is moving, and the type and altitude of the aircraft, if known, are given. An example would be: "Traffic 10 o'clock 5 miles east bound, Cessna 152, 3,000 feet." The pilot should note that traffic position is based on the aircraft track, and that wind correction can affect the clock position at which a pilot locates traffic. [Figure 12-16]

## WAKE TURBULENCE

All aircraft generate a wake while in flight. This disturbance is caused by a pair of counter-rotating vortices trailing from the wingtips. The vortices from larger aircraft pose problems to encountering aircraft. The wake of these aircraft can impose rolling moments exceeding the roll-control authority of the encountering aircraft. Also, the turbulence generated within the vortices can damage

aircraft components and equipment if encountered at close range. For this reason, a pilot must envision the location of the vortex wake and adjust the flightpath accordingly.

During ground operations and during takeoff, jet-engine blast (thrust stream turbulence) can cause damage and upsets at close range. For this reason, pilots of small aircraft should consider the effects of

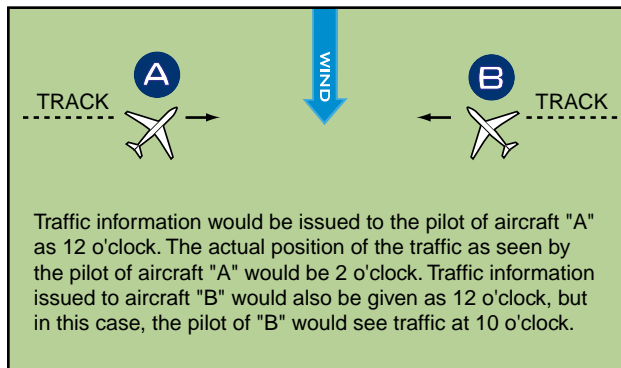

**Figure 12-16. Traffic advisories.**

jet-engine blast and maintain adequate separation. Also, pilots of larger aircraft should consider the effects of their aircraft's jet-engine blast on other aircraft and equipment on the ground.

### VORTEX GENERATION

Lift is generated by the creation of a pressure differential over the wing surface. The lowest pressure occurs over the upper wing surface, and the highest pressure under the wing. This pressure differential triggers the rollup of the airflow aft of the wing resulting in swirling air masses trailing downstream of the wingtips. After the rollup is completed, the wake consists of two counter-rotating cylindrical vortices. Most of the energy is within a few feet of the center of each vortex, but pilots should avoid a region within about 100 feet of the vortex core. [Figure 12-17]

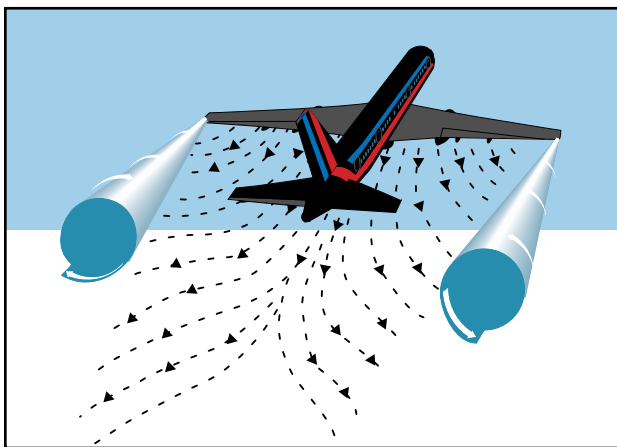

Figure 12-17. Vortex generation.

### VORTEX STRENGTH

The strength of the vortex is governed by the weight, speed, and shape of the wing of the generating aircraft. The vortex characteristics of any given aircraft can also be changed by the extension of flaps or other wing configuration devices as well as by a change in speed. The greatest vortex strength occurs when the generating aircraft is heavy, clean, and slow.

### VORTEX BEHAVIOR

Trailing vortices have certain behavioral characteristics that can help a pilot visualize the wake location and take avoidance precautions.

Vortices are generated from the moment an aircraft leaves the ground, since trailing vortices are the by-product of wing lift. The vortex circulation is outward, upward, and around the wingtips when viewed from either ahead or behind the aircraft. Tests have shown that vortices remain spaced a bit less than a wingspan apart, drifting with the wind, at altitudes greater than a wingspan from the ground. Tests have also shown that the vortices sink at a rate of several hundred feet per minute, slowing their descent and diminishing in strength with time and distance behind the generating aircraft. [Figure 12-18]

When the vortices of larger aircraft sink close to the ground (within 100 to 200 feet), they tend to move laterally over the ground at a speed of 2 or 3 knots. A crosswind will decrease the lateral movement of the upwind vortex and increase the movement of the downwind vortex. A tailwind condition can move the vortices of the preceding aircraft forward into the touchdown zone.

### VORTEX AVOIDANCE PROCEDURES

- Landing behind a larger aircraft on the same runway—stay at or above the larger aircraft's approach flightpath and land beyond its touchdown point.
- Landing behind a larger aircraft on a parallel runway closer than 2,500 feet—consider the possibility of drift and stay at or above the larger aircraft's final approach flightpath and note its touchdown point.
- Landing behind a larger aircraft on crossing runway—cross above the larger aircraft's flightpath.

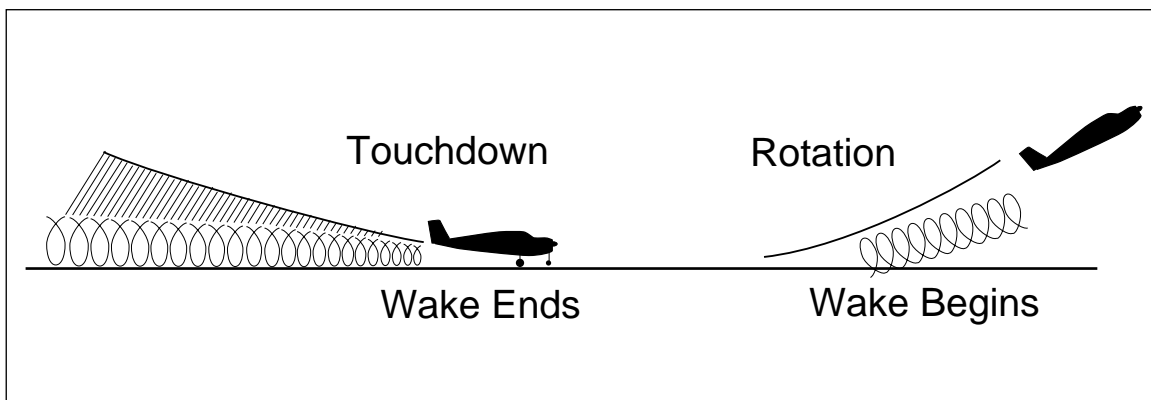

Figure 12-18. Vortex behavior.

- Landing behind a departing aircraft on the same runway—land prior to the departing aircraft’s rotating point.
- Landing behind a larger aircraft on a crossing runway—note the aircraft’s rotation point and if past the intersection, continue and land prior to the intersection. If the larger aircraft rotates prior to the intersection, avoid flight below its flight-path. Abandon the approach unless a landing is ensured well before reaching the intersection.
- Departing behind a large aircraft, rotate prior to the large aircraft’s rotation point and climb above its climb path until turning clear of the wake.
- For intersection takeoffs on the same runway, be alert to adjacent larger aircraft operations, particularly upwind of the runway of intended use. If an intersection takeoff clearance is received, avoid headings that will cross below the larger aircraft’s path.
- If departing or landing after a large aircraft executing a low approach, missed approach, or touch and go landing (since vortices settle and move laterally near the ground, the vortex hazard may exist along the runway and in the flightpath, particularly in a quartering tailwind), it is prudent to wait 2 minutes prior to a takeoff or landing.
- En route it is advisable to avoid a path below and behind a large aircraft, and if a large aircraft is observed above on the same track, change the aircraft position laterally and preferably upwind.

## COLLISION AVOIDANCE

Title 14 of the Code of Federal Regulations (14 CFR) part 91 has established right-of-way rules, minimum safe altitudes, and VFR cruising altitudes to enhance flight safety. The pilot can contribute to collision avoidance by being alert and scanning for other aircraft. This is particularly important in the vicinity of an airport.

Effective scanning is accomplished with a series of short, regularly spaced eye movements that bring successive areas of the sky into the central visual field. Each movement should not exceed 10°, and each should be observed for at least 1 second to enable detection. Although back and forth eye movements seem preferred by most pilots, each pilot should develop a scanning pattern that is most comfortable and then adhere to it to assure optimum scanning.

Even if entitled to the right-of-way, a pilot should give way if it is felt another aircraft is too close.

## CLEARING PROCEDURES

The following procedures and considerations should assist a pilot in collision avoidance under various situations.

- **Before Takeoff**—Prior to taxiing onto a runway or landing area in preparation for takeoff, pilots should scan the approach area for possible landing traffic, executing appropriate maneuvers to provide a clear view of the approach areas.
- **Climbs and Descents**—During climbs and descents in flight conditions which permit visual detection of other traffic, pilots should execute gentle banks left and right at a frequency which permits continuous visual scanning of the air-space.
- **Straight and Level**—During sustained periods of straight-and-level flight, a pilot should execute appropriate clearing procedures at periodic intervals.
- **Traffic Patterns**—Entries into traffic patterns while descending should be avoided.
- **Traffic at VOR Sites**—Due to converging traffic, sustained vigilance should be maintained in the vicinity of VORs and intersections.
- **Training Operations**—Vigilance should be maintained and clearing turns should be made prior to a practice maneuver. During instruction, the pilot should be asked to verbalize the clearing procedures (call out “clear left, right, above, and below”).

High-wing and low-wing aircraft have their respective blind spots. High-wing aircraft should momentarily raise their wing in the direction of the intended turn and look for traffic prior to commencing the turn. Low-wing aircraft should momentarily lower the wing.

## RUNWAY INCURSION AVOIDANCE

It is important to give the same attention to operating on the surface as in other phases of flights. Proper planning can prevent runway incursions and the possibility of a ground collision. A pilot should be aware of the airplane’s position on the surface at all times and be aware of other aircraft and vehicle operations on the airport. At times controlled airports can be busy and taxi instructions complex. In

this situation it may be advisable to write down taxi instructions. The following are some practices to help prevent a runway incursion.

- Read back all runway crossing and/or hold instructions.
- Review airport layouts as part of preflight planning and before descending to land, and while taxiing as needed.
- Know airport signage.
- Review Notices to Airmen (NOTAM) for information on runway/taxiway closures and construction areas.
- Request progressive taxi instructions from ATC when unsure of the taxi route.
- Check for traffic before crossing any Runway Hold Line and before entering a taxiway.
- Turn on aircraft lights and the rotating beacon or strobe lights while taxiing.
- When landing, clear the active runway as soon as possible, then wait for taxi instructions before further movement.
- Study and use proper phraseology in order to understand and respond to ground control instructions.
- Write down complex taxi instructions at unfamiliar airports.

For more detailed information, refer to Advisory Circular (AC) 91-73, Part 91 Pilot and Flightcrew Procedures During Taxi Operations and Part 135 Single-Pilot Operations.



# Chapter 13

## Airspace



This chapter introduces the various classifications of airspace and provides information on the requirements to operate in such airspace. For further information, consult the *Aeronautical Information Manual* (AIM) and 14 CFR parts 71, 73, and 91.

The two categories of airspace are: regulatory and non-regulatory. Within these two categories there are four types: controlled, uncontrolled, special use, and other airspace.

Figure 13-1 presents a profile view of the dimensions of various classes of airspace. Figure 13-2 gives the basic weather minimums for operating in the different classes of airspace. Figure 13-3 lists the operational and equipment requirements. It will be helpful to refer to these figures as this chapter is studied. Also there are excerpts from sectional charts in Chapter 14—Navigation, that will show how airspace is depicted.

### CONTROLLED AIRSPACE

Controlled airspace is a generic term that covers the different classifications of airspace and defined dimensions within which air traffic control service is provided in accordance with the airspace classification. Controlled airspace consists of:

- Class A
- Class B
- Class C
- Class D
- Class E

### CLASS A AIRSPACE

Class A airspace is generally the airspace from 18,000 feet mean sea level (MSL) up to and including FL600, including the airspace overlying the waters within 12 nautical miles (NM) of the coast of the 48 contiguous states and Alaska. Unless otherwise authorized, all operation in Class A airspace will be conducted under instrument flight rules (IFR).

### CLASS B AIRSPACE

Class B airspace is generally the airspace from the surface to 10,000 feet MSL surrounding the nation's busiest airports. The configuration of Class B airspace is individually tailored to the needs of a particular area and consists of a surface area and two or more layers. Some Class B airspace resembles an upside-down wedding cake. At least a private pilot certificate is required to operate in Class B airspace; however, there is an exception to this requirement. Student pilots or recreational pilots seeking private pilot certification may operate in the airspace and land at other than specified primary airports within the airspace if they have received training and had their logbook endorsed by a certified flight instructor in accordance with Title 14 of the Code of Federal Regulations (14 CFR) part 61.

### CLASS C AIRSPACE

Class C airspace generally extends from the surface to 4,000 feet above the airport elevation surrounding those airports having an operational control tower, that are serviced by a radar approach control, and with a certain number of IFR operations or passenger enplanements. This airspace is charted in feet



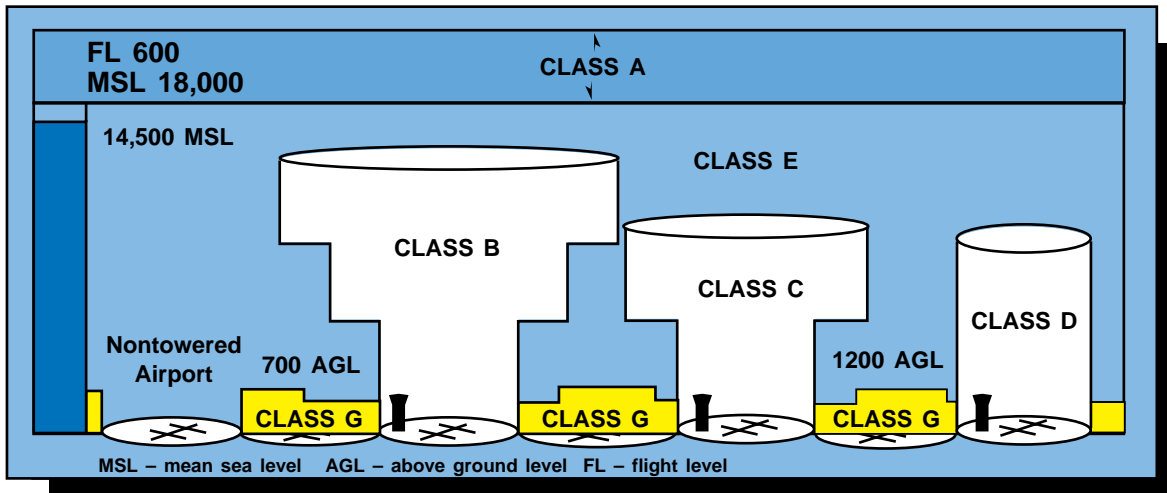

Figure 13-1. Airspace profile.

BASIC VFR WEATHER MINIMUMS		
Airspace	Flight Visibility	Distance from Clouds
Class A .....	Not Applicable	Not Applicable
Class B .....	3 statute miles	Clear of Clouds
Class C .....	3 statute miles	500 feet below 1,000 feet above 2,000 feet horizontal
Class D .....	3 statute miles	500 feet below 1,000 feet above 2,000 feet horizontal
Class E Less than 10,000 feet MSL .....	3 statute miles	500 feet below 1,000 feet above 2,000 feet horizontal
At or above 10,000 feet MSL .....	5 statute miles	1,000 feet below 1,000 feet above 1 statute mile horizontal
Class G 1,200 feet or less above the surface (regardless of MSL altitude). Day, except as provided in section 91.155(b). .....	1 statute mile	Clear of Clouds
Night, except as provided in section 91.155(b). .....	3 statute miles	500 feet below 1,000 feet above 2,000 feet horizontal
More than 1,200 feet above the surface but less than 10,000 feet MSL. Day .....	1 statute mile	500 feet below 1,000 feet above 2,000 feet horizontal
Night .....	3 statute miles	500 feet below 1,000 feet above 2,000 feet horizontal
More than 1,200 feet above the surface and at or above 10,000 feet MSL. ....	5 statute miles	1,000 feet below 1,000 feet above 1 statute mile horizontal

Figure 13-2. Visual flight rule weather minimums.

Class Airspace	Entry Requirements	Equipment	Minimum Pilot Certificate
A	ATC Clearance	IFR Equipped	Instrument Rating
B	ATC Clearance	Two-Way Radio, Transponder with Altitude Reporting Capability	Private—Except a student or recreational pilot may operate at other than the primary airport if seeking private pilot certification and if regulatory requirements are met.
C	Two-Way Radio Communications Prior to Entry	Two-Way Radio, Transponder with Altitude Reporting Capability	No Specific Requirement
D	Two-Way Radio Communications Prior to Entry	Two-Way Radio	No Specific Requirement
E	None for VFR	No Specific Requirement	No Specific Requirement
G	None	No Specific Requirement	No Specific Requirement

**Figure 13-3. Requirements for airspace operations.**

MSL, and is generally of a 5 NM radius surface area that extends from the surface to 4,000 feet above the airport elevation, and a 10 NM radius area that extends from 1,200 feet to 4,000 feet above the airport elevation. There is also an outer area with a 20 NM radius, which extends from the surface to 4,000 feet above the primary airport, and this area may include one or more satellite airports.

### CLASS D AIRSPACE

Class D airspace generally extends from the surface to 2,500 feet above the airport elevation surrounding those airports that have an operational control tower. The configuration of Class D airspace will be tailored to meet the operational needs of the area.

### CLASS E AIRSPACE

Class E airspace is generally controlled airspace that is not designated A, B, C, or D. Except for 18,000 feet MSL, Class E airspace has no defined vertical limit, but rather it extends upward from either the surface or a designated altitude to the overlying or adjacent controlled airspace.

## UNCONTROLLED AIRSPACE

### CLASS G AIRSPACE

Uncontrolled airspace or Class G airspace is the portion of the airspace that has not been designated as Class A, B, C, D, or E. It is therefore designated uncontrolled airspace. Class G airspace extends from the surface to the base of the overlying Class E airspace. Although air traffic control (ATC) has no authority or responsibility to control air traffic,

pilots should remember there are VFR minimums which apply to Class G airspace.

## SPECIAL USE AIRSPACE

Special use airspace exists where activities must be confined because of their nature. In special use airspace, limitations may be placed on aircraft that are not a part of the activities. Special use airspace usually consists of:

- Prohibited Areas
- Restricted Areas
- Warning Areas
- Military Operation Areas
- Alert Areas
- Controlled Firing Areas

### PROHIBITED AREAS

Prohibited areas are established for security or other reasons associated with the national welfare. Prohibited areas are published in the Federal Register and are depicted on aeronautical charts.

### RESTRICTED AREAS

Restricted areas denote the existence of unusual, often invisible hazards to aircraft such as artillery firing, aerial gunnery, or guided missiles. An aircraft may not enter a restricted area unless permission has been obtained from the controlling agency. Restricted areas are depicted on aeronautical charts and are published in the Federal Register.

## **WARNING AREAS**

Warning areas consist of airspace which may contain hazards to nonparticipating aircraft in international airspace. The activities may be much the same as those for a restricted area. Warning areas are established beyond the 3-mile limit. Warning areas are depicted on aeronautical charts.

## **MILITARY OPERATION AREAS**

Military operation areas (MOA) consist of airspace of defined vertical and lateral limits established for the purpose of separating certain military training activity from IFR traffic. There is no restriction against a pilot operating VFR in these areas; however, a pilot should be alert since training activities may include acrobatic and abrupt maneuvers. MOAs are depicted on aeronautical charts.

## **ALERT AREAS**

Alert areas are depicted on aeronautical charts and are to advise pilots that a high volume of pilot training or unusual aerial activity is taking place.

## **CONTROLLED FIRING AREAS**

Controlled firing areas contain activities, which, if not conducted in a controlled environment, could be hazardous to nonparticipating aircraft. The difference between controlled firing areas and other special use airspace is that activities must be suspended when a spotter aircraft, radar, or ground lookout position indicates an aircraft might be approaching the area.

## **OTHER AIRSPACE AREAS**

“Other airspace areas” is a general term referring to the majority of the remaining airspace. It includes:

- Airport Advisory Areas
- Military Training Routes (MTR)
- Temporary Flight Restrictions
- Parachute Jump Areas
- Published VFR Routes
- Terminal Radar Service Areas
- National Security Areas

## **AIRPORT ADVISORY AREAS**

An airport advisory area is an area within 10 statute miles (SM) of an airport where a control tower is not operating, but where a flight service station (FSS) is located. At these locations, the FSS provides advisory service to arriving and departing aircraft.

## **MILITARY TRAINING ROUTES**

Military training routes (MTR) are developed to allow the military to conduct low-altitude, high-speed training. The routes above 1,500 feet AGL are developed to be flown primarily under IFR, and the routes 1,500 feet and less are for VFR flight. The routes are identified on sectional charts by the designation “instrument (IR) or visual (VR).”

## **TEMPORARY FLIGHT RESTRICTIONS**

An FDC NOTAM will be issued to designate a temporary flight restriction (TFR). The NOTAM will begin with the phrase “FLIGHT RESTRICTIONS” followed by the location of the temporary restriction, effective time period, area defined in statute miles, and altitudes affected. The NOTAM will also contain the FAA coordination facility and telephone number, the reason for the restriction, and any other information deemed appropriate. The pilot should check the NOTAMs as part of flight planning.

Some of the purposes for establishing a temporary restriction are:

- Protect persons and property in the air or on the surface from an existing or imminent hazard.
- Provide a safe environment for the operation of disaster relief aircraft.
- Prevent an unsafe congestion of sightseeing aircraft above an incident or event, which may generate a high degree of public interest.
- Protect declared national disasters for humanitarian reasons in the State of Hawaii.
- Protect the President, Vice President, or other public figures.
- Provide a safe environment for space agency operations.

## **PARACHUTE JUMP AREAS**

Parachute jump areas are published in the *Airport/Facility Directory*. Sites that are used frequently are depicted on sectional charts.

## **PUBLISHED VFR ROUTES**

Published VFR routes are for transitioning around, under, or through some complex airspace. Terms such as VFR flyway, VFR corridor, Class B airspace, VFR transition route, and terminal area VFR route have been applied to such routes. These routes are generally found on VFR terminal area planning charts.

## **TERMINAL RADAR SERVICE AREAS**

Terminal Radar Service Areas (TRSA) are areas where participating pilots can receive additional radar services. The purpose of the service is to provide separation between all IFR operations and participating VFR aircraft.

The primary airport(s) within the TRSA become(s) Class D airspace. The remaining portion of the TRSA overlies other controlled airspace, which is normally Class E airspace beginning at 700 or 1,200 feet and established to transition to/from the en route terminal environment. TRSAs are depicted on VFR sectional charts and terminal area charts with a solid black line

and altitudes for each segment. The Class D portion is charted with a blue segmented line.

Participation in TRSA services is voluntary; however, pilots operating under VFR are encouraged to contact the radar approach control and take advantage of TRSA service.

## **NATIONAL SECURITY AREAS**

National security areas consist of airspace of defined vertical and lateral dimensions established at locations where there is a requirement for increased security and safety of ground facilities. Pilots are requested to voluntarily avoid flying through these depicted areas. When necessary, flight may be temporarily prohibited.



# Chapter 14



## Navigation

This chapter provides an introduction to cross-country flying under visual flight rules (VFR). It contains practical information for planning and executing cross-country flights for the beginning pilot.

Air navigation is the process of piloting an airplane from one geographic position to another while monitoring one's position as the flight progresses. It introduces the need for planning, which includes plotting the course on an aeronautical chart, selecting checkpoints, measuring distances, obtaining pertinent weather information, and computing flight time, headings, and fuel requirements. The methods used in this chapter include pilotage—navigating by reference to visible landmarks, dead reckoning—computations of direction and distance from a known position, and radio navigation—by use of radio aids.

### AERONAUTICAL CHARTS

An aeronautical chart is the road map for a pilot flying under VFR. The chart provides information which allows pilots to track their position and provides available information which enhances safety. The three aeronautical charts used by VFR pilots are:

- Sectional Charts
- VFR Terminal Area Charts
- World Aeronautical Charts

A free catalog listing aeronautical charts and related publications including prices and instructions for

ordering is available at the National Aeronautical Charting Office (NACO) Web site: [www.naco.faa.gov](http://www.naco.faa.gov).

### SECTIONAL CHARTS

Sectional charts are the most common charts used by pilots today. The charts have a scale of 1:500,000 (1 inch = 6.86 nautical miles or approximately 8 statute miles) which allows for more detailed information to be included on the chart.

The charts provide an abundance of information, including airport data, navigational aids, airspace, and topography. Figure 14-1 on the next page is an excerpt from the legend of a sectional chart. By referring to the chart legend, a pilot can interpret most of the information on the chart. A pilot should also check the chart for other legend information, which includes air traffic control frequencies and information on airspace. These charts are revised semiannually except for some areas outside the conterminous United States where they are revised annually.

### VISUAL FLIGHT RULE TERMINAL AREA CHARTS

Visual flight rule (VFR) terminal area charts are helpful when flying in or near Class B airspace. They have a scale of 1:250,000 (1 inch = 3.43 nautical miles or approximately 4 statute miles). These charts provide a more detailed display of topographical information and are revised semiannually, except for several Alaskan and Caribbean charts.

### WORLD AERONAUTICAL CHARTS

World aeronautical charts are designed to provide a standard series of aeronautical charts, covering land

areas of the world, at a size and scale convenient for navigation by moderate speed aircraft. They are produced at a scale of 1:1,000,000 (1 inch = 13.7 nautical miles or approximately 16 statute miles). These charts are similar to sectional charts and the symbols are the same except there is less detail due to the smaller scale. These charts are revised annually except several Alaskan charts and the Mexican/Caribbean charts which are revised every 2 years.

## LATITUDE AND LONGITUDE (MERIDIANS AND PARALLELS)

The Equator is an imaginary circle equidistant from the poles of the Earth. Circles parallel to the Equator (lines running east and west) are parallels of latitude. They are used to measure degrees of latitude north or south of the Equator. The angular distance from the Equator

to the pole is one-fourth of a circle or 90°. The 48 conterminous states of the United States are located between 25° and 49° N. latitude. The arrows in figure 14-2 labeled “LATITUDE” point to lines of latitude.

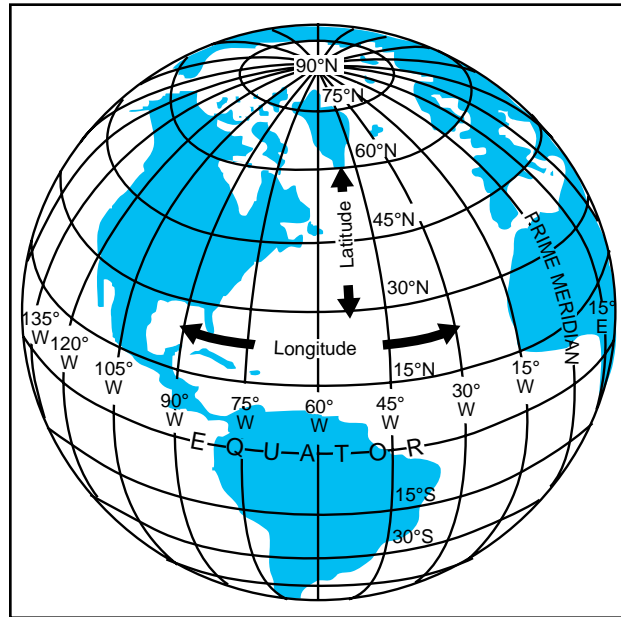

Figure 14-2. Meridians and parallels—the basis of measuring time, distance, and direction.

Meridians of longitude are drawn from the North Pole to the South Pole and are at right angles to the Equator. The “Prime Meridian” which passes through Greenwich, England, is used as the zero line from which measurements are made in degrees east and west to 180°. The 48 conterminous states of the United States are between 67° and 125° W. Longitude. The arrows in figure 14-2 labeled “LONGITUDE” point to lines of longitude.

Any specific geographical point can thus be located by reference to its longitude and latitude. Washington, DC for example, is approximately 39° N. latitude, 77° W. longitude. Chicago is approximately 42° N. latitude, 88° W. longitude.

## TIME ZONES

The meridians are also useful for designating time zones. A day is defined as the time required for the Earth to make one complete rotation of 360°. Since the day is divided into 24 hours, the Earth revolves at the rate of 15° an hour. Noon is the time when the Sun is directly above a meridian; to the west of that meridian is morning, to the east is afternoon.

The standard practice is to establish a time zone for each 15° of longitude. This makes a difference of exactly 1 hour between each zone. In the United States, there are four time zones. The time zones are Eastern (75°), Central (90°), Mountain (105°), and Pacific (120°). The dividing lines are somewhat irregular

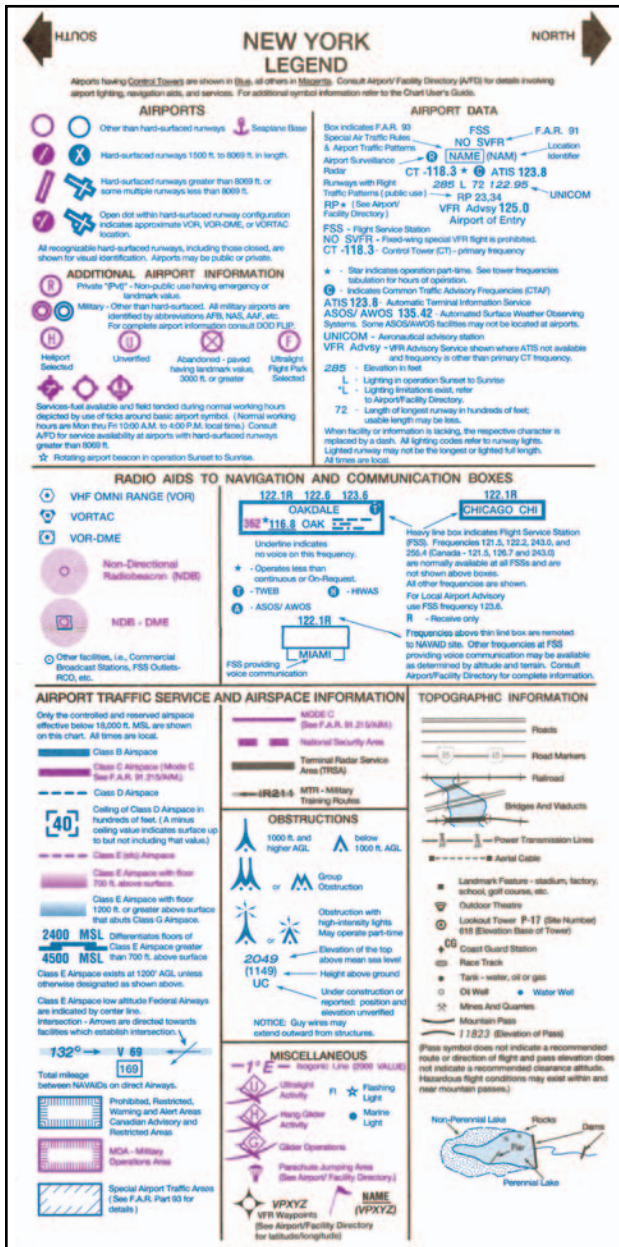

Figure 14-1. Sectional chart legend.

because communities near the boundaries often find it more convenient to use time designations of neighboring communities or trade centers.

Figure 14-3 shows the time zones in the United States. When the Sun is directly above the 90th meridian, it is noon Central Standard Time. At the same time, it will be 1 p.m. Eastern Standard Time, 11 a.m. Mountain Standard Time, and 10 a.m. Pacific Standard Time. When “daylight saving” time is in effect, generally between the last Sunday in April and the last Sunday in October, the Sun is directly above the 75th meridian at noon, Central Daylight Time.

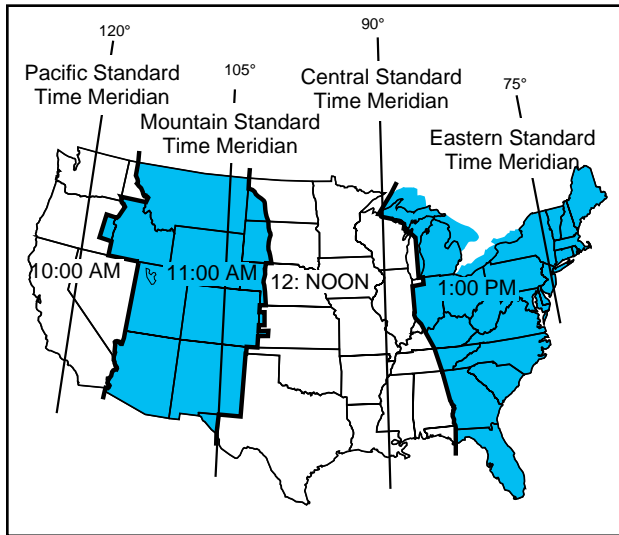

Figure 14-3. Time zones.

These time zone differences must be taken into account during long flights eastward—especially if the flight must be completed before dark. Remember, an hour is lost when flying eastward from one time zone to another, or perhaps even when flying from the western edge to the eastern edge of the same time zone. Determine the time of sunset at the destination by consulting the flight service stations (AFSS/FSS) or National Weather Service (NWS) and take this into account when planning an eastbound flight.

In most aviation operations, time is expressed in terms of the 24-hour clock. Air traffic control instructions, weather reports and broadcasts, and estimated times of arrival are all based on this system. For example: 9 a.m. is expressed as 0900, 1 p.m. is 1300, and 10 p.m. is 2200.

Because a pilot may cross several time zones during a flight, a standard time system has been adopted. It is called Universal Coordinated Time (UTC) and is often referred to as Zulu time. UTC is the time at the 0° line of longitude which passes through Greenwich,

England. All of the time zones around the world are based on this reference. To convert to this time, a pilot should do the following:

- Eastern Standard Time.....Add 5 hours
- Central Standard Time..... Add 6 hours
- Mountain Standard Time..... Add 7 hours
- Pacific Standard Time..... Add 8 hours

For daylight saving time, 1 hour should be subtracted from the calculated times.

### MEASUREMENT OF DIRECTION

By using the meridians, direction from one point to another can be measured in degrees, in a clockwise direction from true north. To indicate a course to be followed in flight, draw a line on the chart from the point of departure to the destination and measure the angle which this line forms with a meridian. Direction is expressed in degrees, as shown by the compass rose in figure 14-4.

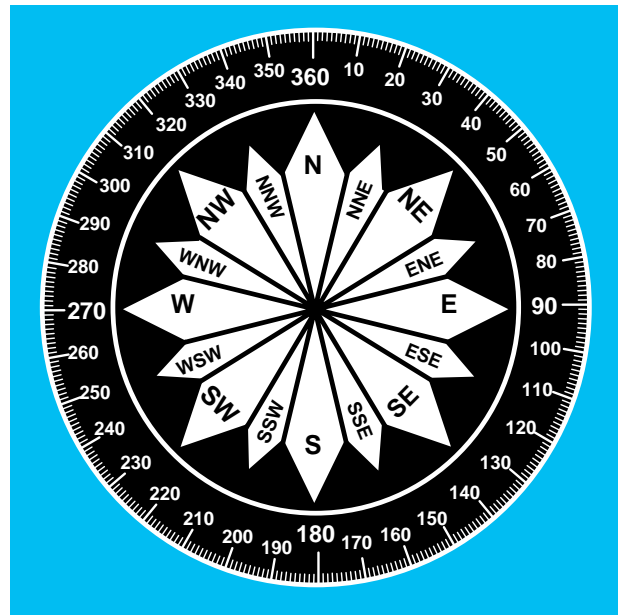

Figure 14-4. Compass rose.

Because meridians converge toward the poles, course measurement should be taken at a meridian near the midpoint of the course rather than at the point of departure. The course measured on the chart is known as the true course. This is the direction measured by reference to a meridian or true north. It is the direction of intended flight as measured in degrees clockwise from true north.



As shown in figure 14-5, the direction from A to B would be a true course of  $065^\circ$ , whereas the return trip (called the reciprocal) would be a true course of  $245^\circ$ .

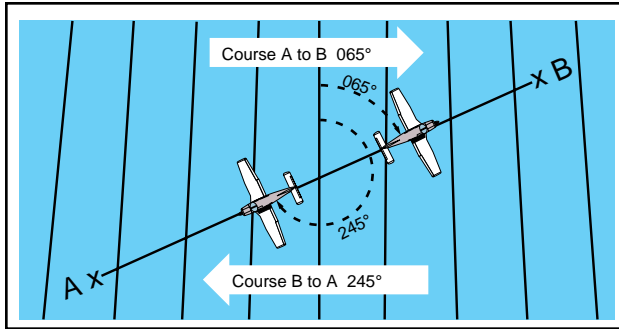

Figure 14-5. Courses are determined by reference to meridians on aeronautical charts.

The true heading is the direction in which the nose of the airplane points during a flight when measured in degrees clockwise from true north. Usually, it is necessary to head the airplane in a direction slightly different from the true course to offset the effect of wind. Consequently, numerical value of the true heading may not correspond with that of the true course. This will be discussed more fully in subsequent sections in this chapter. For the purpose of this discussion, assume a no-wind condition exists under which heading and course would coincide. Thus, for a true course of  $065^\circ$ , the true heading would be  $065^\circ$ . To use the compass accurately, however, corrections must be made for magnetic variation and compass deviation.

## VARIATION

Variation is the angle between true north and magnetic north. It is expressed as east variation or west variation depending upon whether magnetic north (MN) is to the east or west of true north (TN).

The north magnetic pole is located close to  $71^\circ$  N. latitude,  $96^\circ$  W. longitude and is about 1,300 miles from the geographic or true north pole, as indicated in figure 14-6. If the Earth were uniformly magnetized, the compass needle would point toward the magnetic pole, in which case the variation between true north (as shown by the geographical meridians) and magnetic north (as shown by the magnetic meridians) could be measured at any intersection of the meridians.

Actually, the Earth is not uniformly magnetized. In the United States, the needle usually points in the general direction of the magnetic pole, but it may vary in certain geographical localities by many degrees. Consequently, the exact amount of variation at thousands of selected locations in the United States has been carefully determined. The amount and the direction of variation, which change slightly from time to time, are shown on most aeronautical charts as broken magenta lines, called isogonic lines, which connect points of equal magnetic

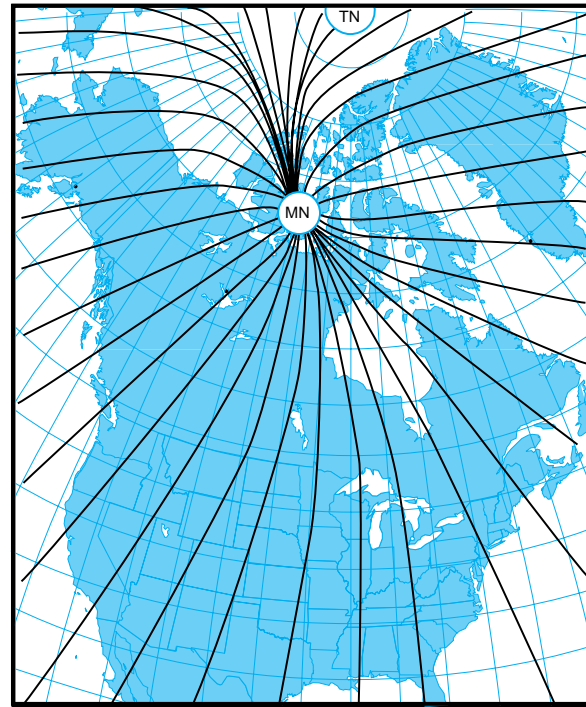

Figure 14-6. Isogonic chart. Magnetic meridians are in black; geographic meridians and parallels are in blue. Variation is the angle between a magnetic and geographic meridian.

variation. (The line connecting points at which there is no variation between true north and magnetic north is the agonic line.) An isogonic chart is shown in figure 14-6. Minor bends and turns in the isogonic and agonic lines are caused by unusual geological conditions affecting magnetic forces in these areas.

On the west coast of the United States, the compass needle points to the east of true north; on the east coast, the compass needle points to the west of true north. Zero degree variation exists on the agonic line, where magnetic north and true north coincide. This line runs roughly west of the Great Lakes, south through Wisconsin, Illinois, western Tennessee, and along the border of Mississippi and Alabama. [Compare figures 14-7 and 14-8.]

Because courses are measured in reference to geographical meridians which point toward true north, and these courses are maintained by reference to the compass which points along a magnetic meridian in the general direction of magnetic north, the true direction must be converted into magnetic direction for the purpose of flight. This conversion is made by adding or subtracting the variation which is indicated by the nearest isogonic line on the chart. The true heading, when corrected for variation, is known as magnetic heading.

If the variation is shown as " $9^\circ$ E," this means that magnetic north is  $9^\circ$  east of true north. If a true heading of  $360^\circ$  is to be flown,  $9^\circ$  must be subtracted from  $360^\circ$ , which results in a magnetic heading of  $351^\circ$ . To fly

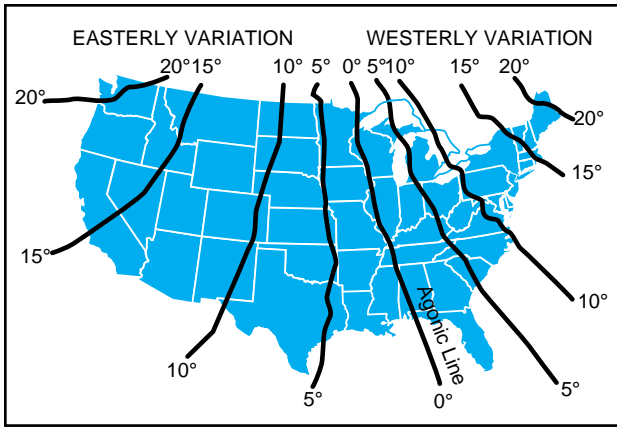

Figure 14-7. A typical isogonic chart. The black lines are isogonic lines which connect geographic points with identical magnetic variation.

east, a magnetic heading of  $081^\circ$  ( $090^\circ - 9^\circ$ ) would be flown. To fly south, the magnetic heading would be  $171^\circ$  ( $180^\circ - 9^\circ$ ). To fly west, it would be  $261^\circ$  ( $270^\circ - 9^\circ$ ). To fly a true heading of  $060^\circ$ , a magnetic heading of  $051^\circ$  ( $060^\circ - 9^\circ$ ) would be flown.

Remember, to convert true course or heading to magnetic course or heading, note the variation shown by the nearest isogonic line. If variation is west, add; if east, subtract. One method for remembering whether to add or subtract variation is the phrase “east is least (subtract) and west is best (add).”

## DEVIATION

Determining the magnetic heading is an intermediate step necessary to obtain the correct compass heading for the flight. To determine compass heading, a correction for deviation must be made. Because of magnetic influences within the airplane such as electrical circuits, radio, lights, tools, engine, and magnetized metal parts, the compass needle is frequently deflected from its normal reading. This deflection is deviation. The deviation is different for each airplane, and it also may vary for different headings in the same airplane. For

instance, if magnetism in the engine attracts the north end of the compass, there would be no effect when the plane is on a heading of magnetic north. On easterly or westerly headings, however, the compass indications would be in error, as shown in figure 14-9. Magnetic attraction can come from many other parts of the airplane; the assumption of attraction in the engine is merely used for the purpose of illustration.

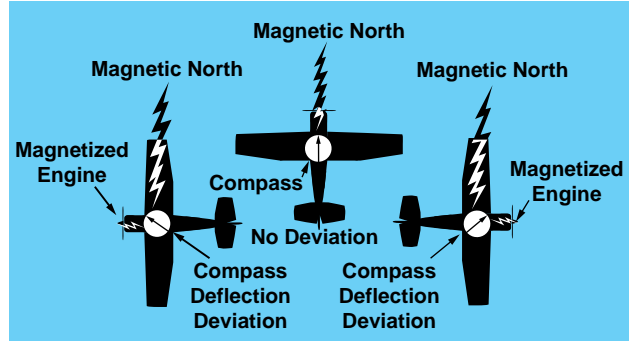

Figure 14-9. Magnetized portions of the airplane cause the compass to deviate from its normal indications.

Some adjustment of the compass, referred to as compensation, can be made to reduce this error, but the remaining correction must be applied by the pilot.

Proper compensation of the compass is best performed by a competent technician. Since the magnetic forces within the airplane change, because of landing shocks, vibration, mechanical work, or changes in equipment, the pilot should occasionally have the deviation of the compass checked. The procedure used to check the deviation (called “swinging the compass”) is briefly outlined.

The airplane is placed on a magnetic compass rose, the engine started, and electrical devices normally used (such as radio) are turned on. Tailwheel-type airplanes should be jacked up into flying position. The airplane is aligned with magnetic north indicated on the compass

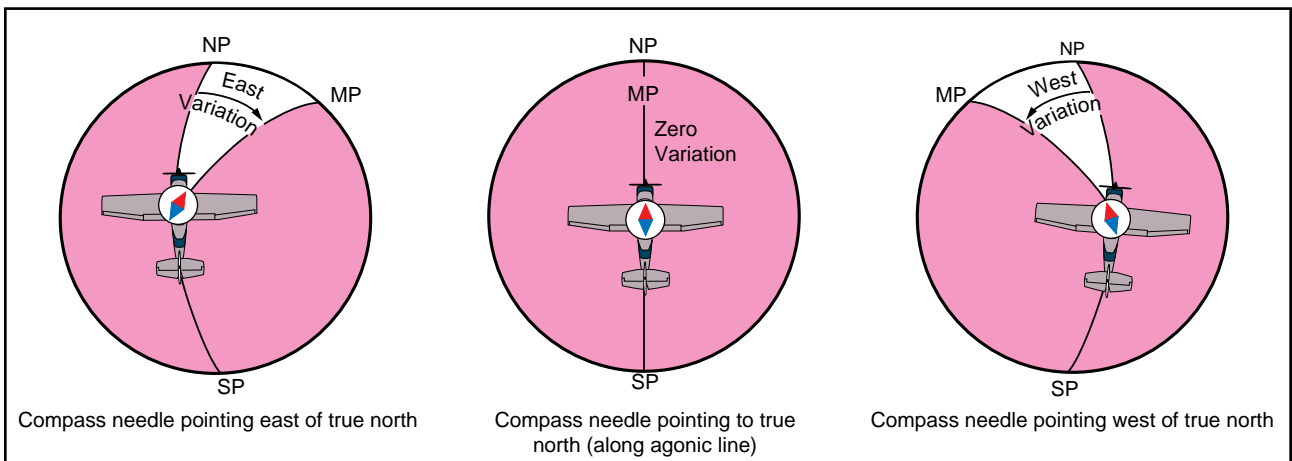

Figure 14-8. Effect of variation on the compass.

rose and the reading shown on the compass is recorded on a deviation card. The airplane is then aligned at 30° intervals and each reading is recorded. If the airplane is to be flown at night, the lights are turned on and any significant changes in the readings are noted. If so, additional entries are made for use at night.

The accuracy of the compass can also be checked by comparing the compass reading with the known runway headings.

A deviation card, similar to figure 14-10, is mounted near the compass, showing the addition or subtraction required to correct for deviation on various headings, usually at intervals of 30°. For intermediate readings, the pilot should be able to interpolate mentally with sufficient accuracy. For example, if the pilot needed the correction for 195° and noted the correction for 180° to be 0° and for 210° to be +2°, it could be assumed that the correction for 195° would be +1°. The magnetic heading, when corrected for deviation, is known as compass heading.

FOR (MAGNETIC).....	N	30	60	E	120	150
STEER (COMPASS).....	0	28	57	86	117	148
FOR (MAGNETIC).....	S	210	240	W	300	330
STEER (COMPASS).....	180	212	243	274	303	332

Figure 14-10. Compass deviation card.

The following method is used by many pilots to determine compass heading: After the true course (TC) is measured, and wind correction applied resulting in a true heading (TH), the sequence  $TH \pm \text{variation (V)} = MH \pm \text{deviation (D)} = \text{compass heading (CH)}$  is followed to arrive at compass heading. [Figure 14-11]

## EFFECT OF WIND

The preceding discussion explained how to measure a true course on the aeronautical chart and how to make corrections for variation and deviation, but one important factor has not been considered—wind. As discussed in the study of the atmosphere, wind is a mass of air moving over the surface of the Earth in a definite direction. When the wind is blowing from the north at 25 knots, it simply means that air is moving southward over the Earth’s surface at the rate of 25 nautical miles (NM) in 1 hour.

Under these conditions, any inert object free from contact with the Earth will be carried 25 NM southward in 1 hour. This effect becomes apparent when such things as clouds, dust, and toy balloons are observed being blown along by the wind. Obviously, an airplane flying within the moving mass of air will be similarly affected. Even though the airplane does not float freely

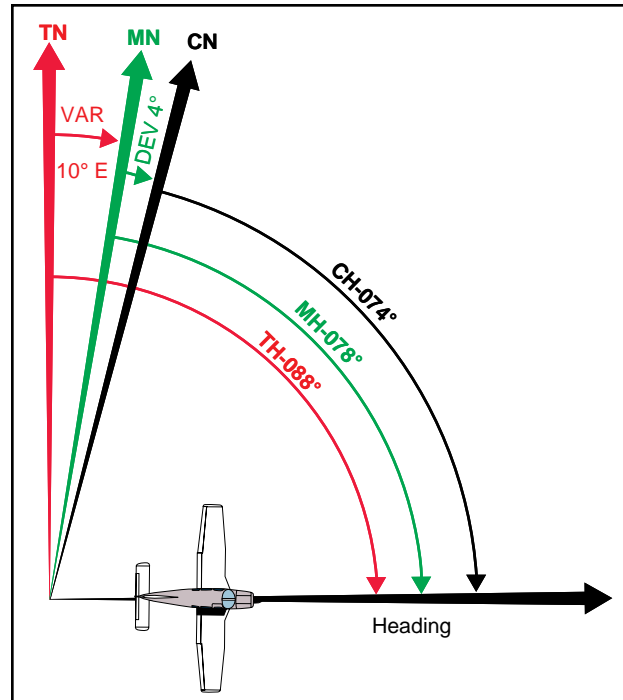

Figure 14-11. Relationship between true, magnetic, and compass headings for a particular instance.

with the wind, it moves through the air at the same time the air is moving over the ground, thus is affected by wind. Consequently, at the end of 1 hour of flight, the airplane will be in a position which results from a combination of these two motions:

- the movement of the air mass in reference to the ground, and
- the forward movement of the airplane through the air mass.

Actually, these two motions are independent. So far as the airplane’s flight through the air is concerned, it makes no difference whether the mass of air through which the airplane is flying is moving or is stationary. A pilot flying in a 70-knot gale would be totally unaware of any wind (except for possible turbulence) unless the ground were observed. In reference to the ground, however, the airplane would appear to fly faster with a tailwind or slower with a headwind, or to drift right or left with a crosswind.

As shown in figure 14-12, an airplane flying eastward at an airspeed of 120 knots in still air, will have a groundspeed exactly the same—120 knots. If the mass of air is moving eastward at 20 knots, the airspeed of the airplane will not be affected, but the progress of the airplane over the ground will be 120 plus 20, or a groundspeed of 140 knots. On the other hand, if the mass of air is moving westward at 20 knots, the airspeed of the airplane still remains the same, but groundspeed becomes 120 minus 20 or 100 knots.

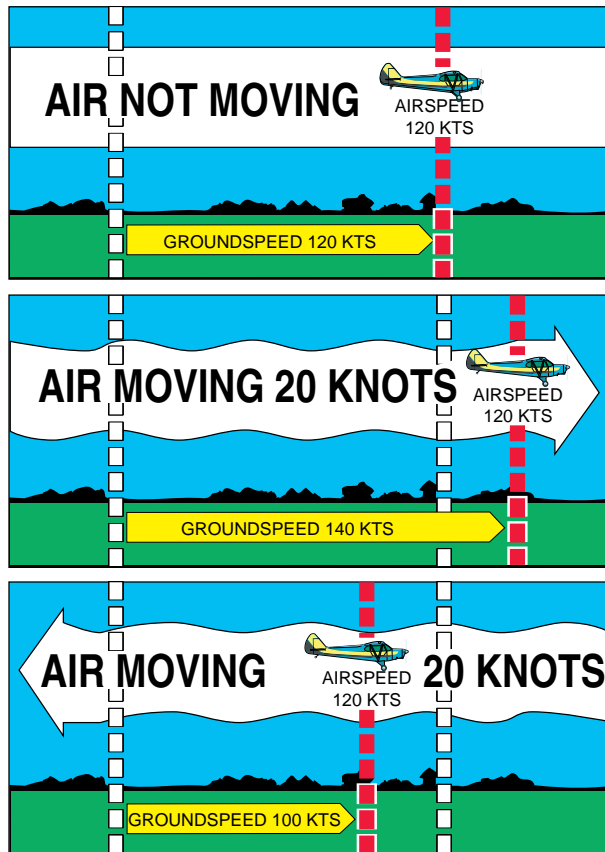

Figure 14-12. Motion of the air affects the speed with which airplanes move over the Earth's surface. Airspeed, the rate at which an airplane moves through the air, is not affected by air motion.

Assuming no correction is made for wind effect, if the airplane is heading eastward at 120 knots, and the air mass moving southward at 20 knots, the airplane at the end of 1 hour will be almost 120 miles east of its point of departure because of its progress through the air. It will be 20 miles south because of the motion of the air. Under these circumstances, the airspeed remains 120 knots, but the groundspeed is determined by combining the movement of the airplane with that of the air mass. Groundspeed can be measured as the distance from the point of departure to the position of the airplane at the end of 1 hour. The groundspeed can be computed by the time required to fly between two points a known distance apart. It also can be determined before flight by constructing a wind triangle, which will be explained later in this chapter. [Figure 14-13]

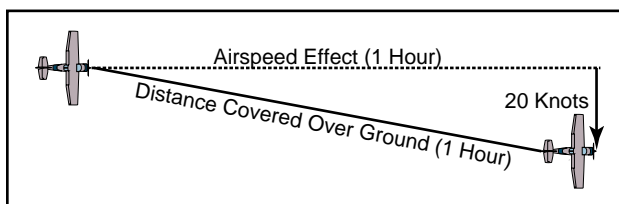

Figure 14-13. Airplane flightpath resulting from its airspeed and direction, and the windspeed and direction.

The direction in which the plane is pointing as it flies is heading. Its actual path over the ground, which is a combination of the motion of the airplane and the motion of the air, is track. The angle between the heading and the track is drift angle. If the airplane's heading coincides with the true course and the wind is blowing from the left, the track will not coincide with the true course. The wind will drift the airplane to the right, so the track will fall to the right of the desired course or true course. [Figure 14-14]

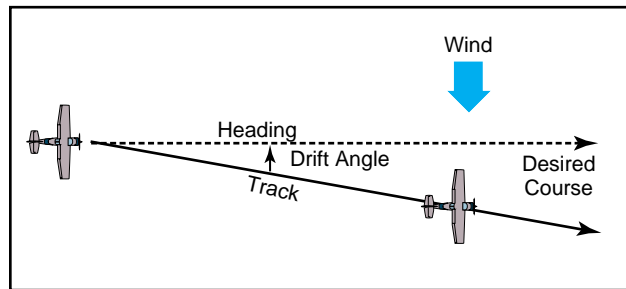

Figure 14-14. Effects of wind drift on maintaining desired course.

By determining the amount of drift, the pilot can counteract the effect of the wind and make the track of the airplane coincide with the desired course. If the mass of air is moving across the course from the left, the airplane will drift to the right, and a correction must be made by heading the airplane sufficiently to the left to offset this drift. To state in another way, if the wind is from the left, the correction will be made by pointing the airplane to the left a certain number of degrees, therefore correcting for wind drift. This is wind correction angle and is expressed in terms of degrees right or left of the true course. [Figure 14-15]

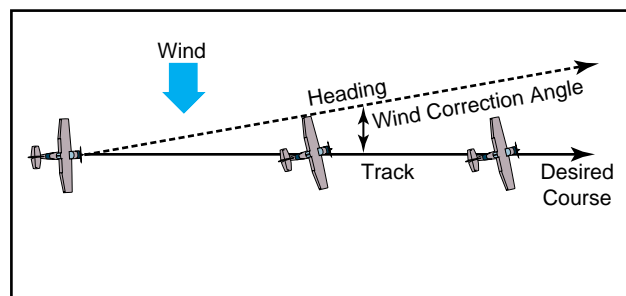

Figure 14-15. Establishing a wind correction angle that will counteract wind drift and maintain the desired course.

To summarize:

- **COURSE**—is the intended path of an airplane over the ground; or the direction of a line drawn on a chart representing the intended airplane path, expressed as the angle measured from a specific reference datum clockwise from 0° through 360° to the line.

- **HEADING**—is the direction in which the nose of the airplane points during flight.
- **TRACK**—is the actual path made over the ground in flight. (If proper correction has been made for the wind, track and course will be identical.)
- **DRIFT ANGLE**—is the angle between heading and track.
- **WIND CORRECTION ANGLE**—is correction applied to the course to establish a heading so that track will coincide with course.
- **AIRSPEED**—is the rate of the airplane's progress through the air.
- **GROUNDSPEED**—is the rate of the airplane's in-flight progress over the ground.

## BASIC CALCULATIONS

Before a cross-country flight, a pilot should make common calculations for time, speed, and distance, and the amount of fuel required.

### CONVERTING MINUTES TO EQUIVALENT HOURS

It frequently is necessary to convert minutes into equivalent hours when solving speed, time, and distance problems. To convert minutes to hours, divide by 60 (60 minutes = 1 hour). Thus, 30 minutes  $30/60 = 0.5$  hour. To convert hours to minutes, multiply by 60. Thus, 0.75 hour equals  $0.75 \times 60 = 45$  minutes.

#### Time T = D/GS

To find the **time** (T) in flight, divide the **distance** (D) by the **groundspeed** (GS). The time to fly 210 nautical miles at a groundspeed of 140 knots is 210 divided by 140, or 1.5 hours. (The 0.5 hour multiplied by 60 minutes equals 30 minutes.) Answer: 1:30.

#### Distance D = GS X T

To find the distance flown in a given time, multiply groundspeed by time. The distance flown in 1 hour 45 minutes at a groundspeed of 120 knots is  $120 \times 1.75$ , or 210 nautical miles.

#### Groundspeed GS = D/T

To find the groundspeed, divide the distance flown by the time required. If an airplane flies 270 nautical miles in 3 hours, the groundspeed is 270 divided by 3 = 90 knots.

### CONVERTING KNOTS TO MILES PER HOUR

Another conversion is that of changing knots to miles per hour. The aviation industry is using knots more frequently than miles per hour, but it might be well to

discuss the conversion for those who do use miles per hour when working with speed problems. The National Weather Service reports both surface winds and winds aloft in knots. However, airspeed indicators in some airplanes are calibrated in miles per hour (although many are now calibrated in both miles per hour and knots). Pilots, therefore, should learn to convert windspeeds in knots to miles per hour.

A knot is 1 nautical mile per hour. Because there are 6,076.1 feet in a nautical mile and 5,280 feet in a statute mile, the conversion factor is 1.15. To convert knots to miles per hour, multiply knots by 1.15. For example: a windspeed of 20 knots is equivalent to 23 miles per hour.

Most flight computers or electronic calculators have a means of making this conversion. Another quick method of conversion is to use the scales of nautical miles and statute miles at the bottom of aeronautical charts.

### FUEL CONSUMPTION

Airplane fuel consumption is computed in gallons per hour. Consequently, to determine the fuel required for a given flight, the time required for the flight must be known. Time in flight multiplied by rate of consumption gives the quantity of fuel required. For example, a flight of 400 NM at a groundspeed of 100 knots requires 4 hours. If the plane consumes 5 gallons an hour, the total consumption will be  $4 \times 5$ , or 20 gallons.

The rate of fuel consumption depends on many factors: condition of the engine, propeller pitch, propeller r.p.m., richness of the mixture, and particularly the percentage of horsepower used for flight at cruising speed. The pilot should know the approximate consumption rate from cruise performance charts, or from experience. In addition to the amount of fuel required for the flight, there should be sufficient fuel for reserve.

### FLIGHT COMPUTERS

Up to this point, only mathematical formulas have been used to determine such items as time, distance, speed, and fuel consumption. In reality, most pilots will use a mechanical or electronic flight computer. These devices can compute numerous problems associated with flight planning and navigation. The mechanical or electronic computer will have an instruction book and most likely sample problems so the pilot can become familiar with its functions and operation. [Figure 14-16]

### PLOTTER

Another aid in flight planning is a plotter, which is a protractor and ruler. The pilot can use this when determining true course and measuring distance. Most plotters have a ruler which measures in both

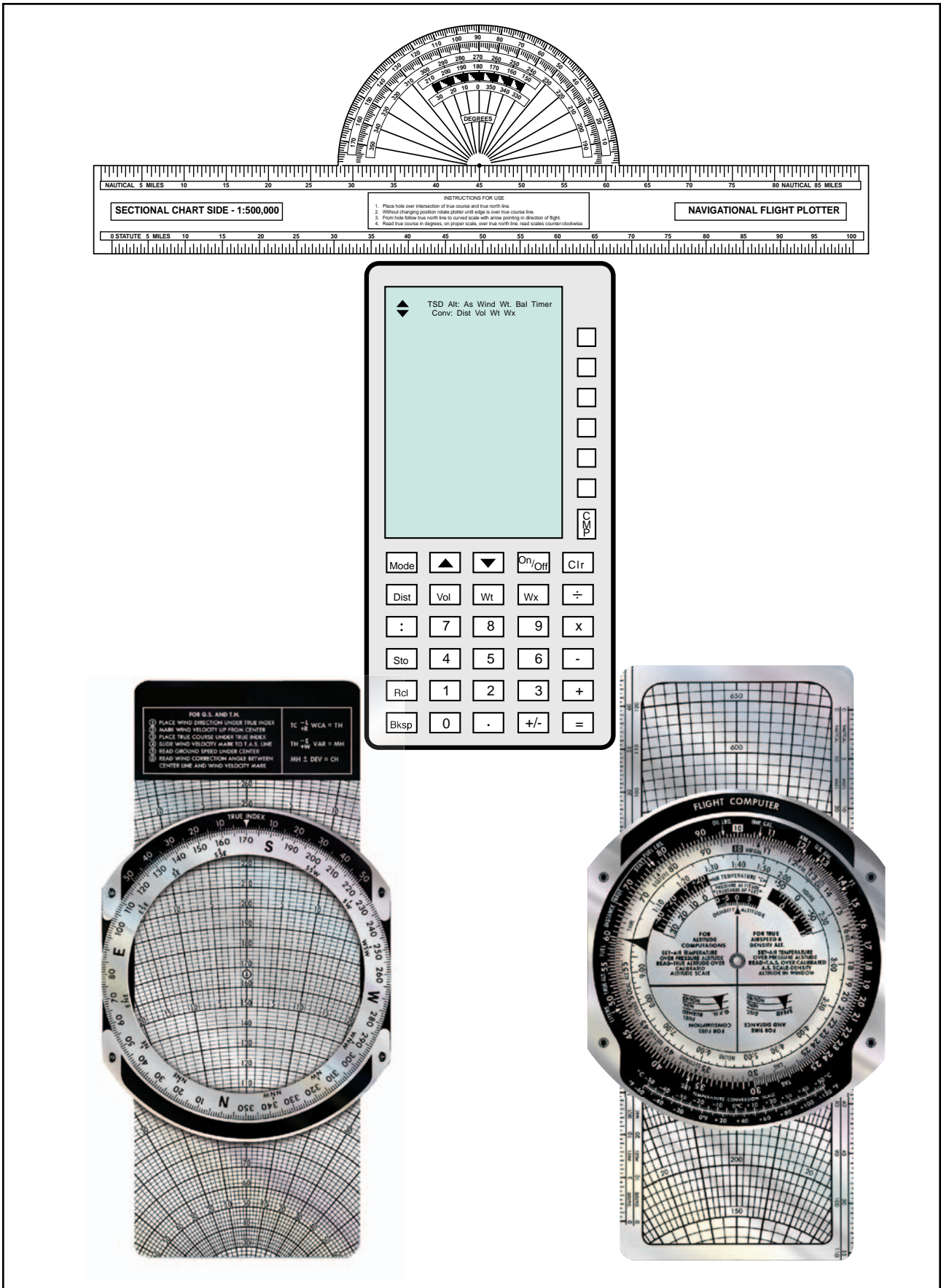

Figure 14-16. A picture of the computational and wind side of a common mechanical computer, an electronic computer, and plotter.

nautical and statute miles and has a scale for a sectional chart on one side and a world aeronautical chart on the other. [Figure 14-16]

## PILOTAGE

Pilotage is navigation by reference to landmarks or checkpoints. It is a method of navigation that can be used on any course that has adequate checkpoints, but it is more commonly used in conjunction with dead reckoning and VFR radio navigation.

The checkpoints selected should be prominent features common to the area of the flight. Choose checkpoints that can be readily identified by other features such as roads, rivers, railroad tracks, lakes, and power lines. If possible, select features that will make useful boundaries or brackets on each side of the course, such as highways, rivers, railroads, and mountains. A pilot can keep from drifting too far off course by referring to and not crossing the selected brackets. Never place complete reliance on any single checkpoint. Choose ample checkpoints. If one is missed, look for the next one while maintaining the heading. When determining position from checkpoints, remember that the scale of a sectional chart is 1 inch = 8 statute miles or 6.86 nautical miles. For example, if a checkpoint selected was approximately one-half inch from the course line on the chart, it is 4 statute miles or 3.43 nautical miles from the course on the ground. In the more congested areas, some of the smaller features are not included on the chart. If confused, hold the heading. If a turn is made away from the heading, it will be easy to become lost.

Roads shown on the chart are primarily the well-traveled roads or those most apparent when viewed from the air. New roads and structures are constantly being built, and may not be shown on the chart until the next chart is issued. Some structures, such as antennas may be difficult to see. Sometimes TV antennas are grouped together in an area near a town. They are supported by almost invisible guy wires. Never approach an area of antennas less than 500 feet above the tallest one. Most of the taller structures are marked with strobe lights to make them more visible to a pilot. However, some weather conditions or background lighting may make them difficult to see. Aeronautical charts display the best information available at the time of printing, but a pilot should be cautious for new structures or changes that have occurred since the chart was printed.

## DEAD RECKONING

Dead reckoning is navigation solely by means of computations based on time, airspeed, distance, and direction. The products derived from these variables, when adjusted by windspeed and velocity, are heading and groundspeed. The predicted heading will guide the airplane along the intended path and the

groundspeed will establish the time to arrive at each checkpoint and the destination. Except for flights over water, dead reckoning is usually used with pilotage for cross-country flying. The heading and groundspeed as calculated is constantly monitored and corrected by pilotage as observed from checkpoints.

## THE WIND TRIANGLE OR VECTOR ANALYSIS

If there is no wind, the airplane's ground track will be the same as the heading and the groundspeed will be the same as the true airspeed. This condition rarely exists. A wind triangle, the pilot's version of vector analysis, is the basis of dead reckoning.

The wind triangle is a graphic explanation of the effect of wind upon flight. Groundspeed, heading, and time for any flight can be determined by using the wind triangle. It can be applied to the simplest kind of cross-country flight as well as the most complicated instrument flight. The experienced pilot becomes so familiar with the fundamental principles that estimates can be made which are adequate for visual flight without actually drawing the diagrams. The beginning student, however, needs to develop skill in constructing these diagrams as an aid to the complete understanding of wind effect. Either consciously or unconsciously, every good pilot thinks of the flight in terms of wind triangle.

If a flight is to be made on a course to the east, with a wind blowing from northeast, the airplane must be headed somewhat to the north of east to counteract drift. This can be represented by a diagram as shown in figure 14-17. Each line represents direction and speed. The long dotted line shows the direction the plane is heading, and its length represents the airspeed for 1 hour. The short dotted line at the right shows the wind direction, and its length represents the wind velocity

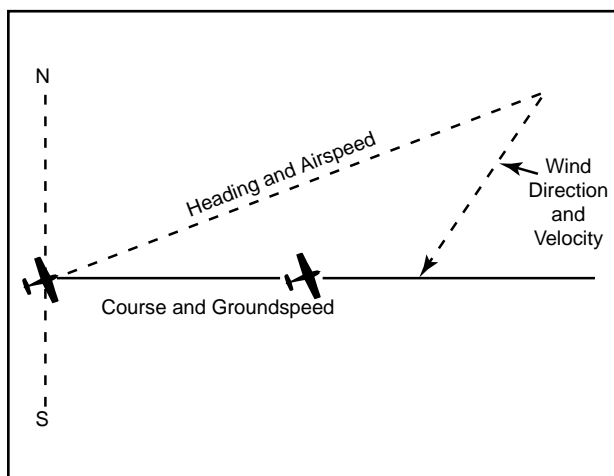
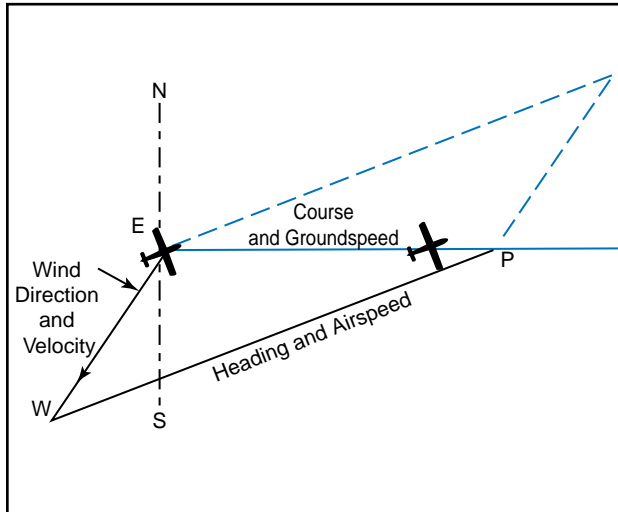

Figure 14-17. Principle of the wind triangle.

for 1 hour. The solid line shows the direction of the track, or the path of the airplane as measured over the Earth, and its length represents the distance traveled in 1 hour, or the groundspeed.

In actual practice, the triangle illustrated in figure 14-17 is not drawn; instead, construct a similar triangle as shown by the black lines in figure 14-18, which is explained in the following example.



**Figure 14-18.** The wind triangle as is drawn in navigation practice. Dashed lines show the triangle as drawn in figure 14-17.

Suppose a flight is to be flown from E to P. Draw a line on the aeronautical chart connecting these two points; measure its direction with a protractor, or plotter, in reference to a meridian. This is the true course, which in this example is assumed to be 090° (east). From the National Weather Service, it is learned that the wind at the altitude of the intended flight is 40 knots from the northeast (045°). Since the National Weather Service reports the windspeed in knots, if the true airspeed of the airplane is 120 knots, there is no need to convert speeds from knots to miles per hour or vice versa.

Now on a plain sheet of paper draw a vertical line representing north and south. (The various steps are shown in figure 14-19.)

Place the protractor with the base resting on the vertical line and the curved edge facing east. At the center point of the base, make a dot labeled “E” (point of departure), and at the curved edge, make a dot at 90° (indicating the direction of the true course) and another at 45° (indicating wind direction).

With the ruler, draw the true course line from E, extending it somewhat beyond the dot by 90°, and labeling it “TC 090°.”

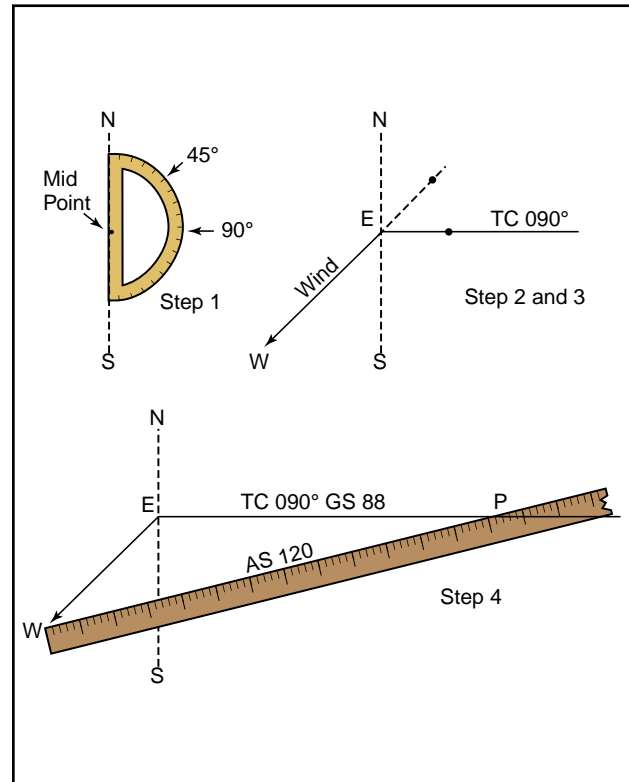

**Figure 14-19.** Steps in drawing the wind triangle.

Next, align the ruler with E and the dot at 45°, and draw the wind arrow from E, not toward 045°, but downwind in the direction the wind is blowing, making it 40 units long, to correspond with the wind velocity of 40 knots. Identify this line as the wind line by placing the letter “W” at the end to show the wind direction. Finally, measure 120 units on the ruler to represent the airspeed, making a dot on the ruler at this point. The units used may be of any convenient scale or value (such as 1/4 inch = 10 knots), but once selected, the same scale must be used for each of the linear movements involved. Then place the ruler so that the end is on the arrowhead (W) and the 120-knot dot intercepts the true course line. Draw the line and label it “AS 120.” The point “P” placed at the intersection represents the position of the airplane at the end of 1 hour. The diagram is now complete.

The distance flown in 1 hour (groundspeed) is measured as the numbers of units on the true course line (88 nautical miles per hour or 88 knots).

The true heading necessary to offset drift is indicated by the direction of the airspeed line, which can be determined in one of two ways:

- By placing the straight side of the protractor along the north-south line, with its center point at



the intersection of the airspeed line and north-south line, read the true heading directly in degrees (076°). [Figure 14-20]

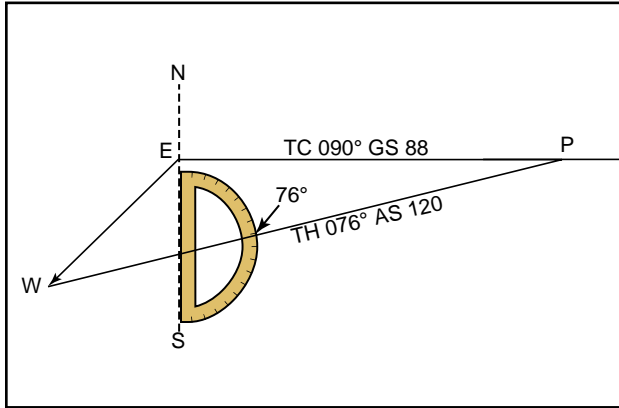

Figure 14-20. Finding true heading by direct measurement.

- By placing the straight side of the protractor along the true course line, with its center at P, read the angle between the true course and the airspeed line. This is the wind correction angle (WCA) which must be applied to the true course to obtain the true heading. If the wind blows from the right of true course, the angle will be added; if from the left, it will be subtracted. In the example given, the WCA is 14° and the wind is from the left; therefore, subtract 14° from true course of 090°, making the true heading 076°. [Figure 14-21]

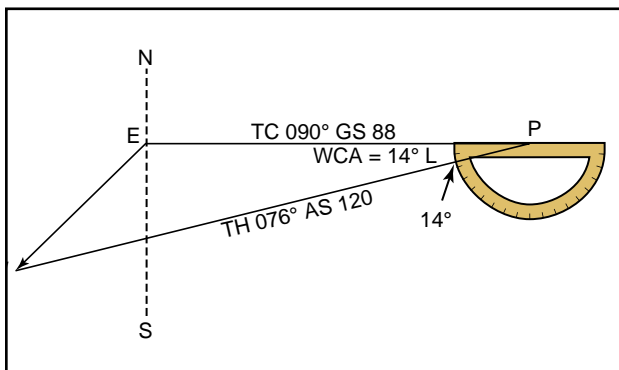

Figure 14-21. Finding true heading by the wind correction angle.

After obtaining the true heading, apply the correction for magnetic variation to obtain magnetic heading, and the correction for compass deviation to obtain a compass heading. The compass heading can be used to fly to the destination by dead reckoning.

To determine the time and fuel required for the flight, first find the distance to destination by measuring the length of the course line drawn on the aeronautical chart (using the appropriate scale at the bottom of the

chart). If the distance measures 220 NM, divide by the groundspeed of 88 knots, which gives 2.5 hours or (2:30), as the time required. If fuel consumption is 8 gallons an hour, 8 x 2.5 or about 20 gallons will be used. Briefly summarized, the steps in obtaining flight information are as follows:

- TRUE COURSE**—Direction of the line connecting two desired points, drawn on the chart and measured clockwise in degrees from true north on the mid-meridian.
- WIND CORRECTION ANGLE**—Determined from the wind triangle. (Added to TC if the wind is from the right; subtract if wind is from the left.)
- TRUE HEADING**—The direction measured in degrees clockwise from true north, in which the nose of the plane should point to make good the desired course.
- VARIATION**—Obtained from the isogonic line on the chart. (Added to TH if west; subtract if east.)
- MAGNETIC HEADING**—An intermediate step in the conversion. (Obtained by applying variation to true heading.)
- DEVIATION**—Obtained from the deviation card on the airplane. (Added to MH or subtracted from, as indicated.)
- COMPASS HEADING**—The reading on the compass (found by applying deviation to MH) which will be followed to make good the desired course.
- TOTAL DISTANCE**—Obtained by measuring the length of the TC line on the chart (using the scale at the bottom of the chart).
- GROUND SPEED**—Obtained by measuring the length of the TC line on the wind triangle (using the scale employed for drawing the diagram).
- ESTIMATED TIME EN ROUTE (ETE)**—Total distance divided by groundspeed.
- FUEL RATE**—Predetermined gallons per hour used at cruising speed.

**NOTE:** Additional fuel for adequate reserve should be added as a safety measure.

## FLIGHT PLANNING

Title 14 of the Code of Federal Regulations (14 CFR) part 91 states, in part, that before beginning a flight, the pilot in command of an aircraft shall become familiar with all available information concerning that flight. For flights not in the vicinity of an airport, this must include information on available current weather reports and forecasts, fuel requirements, alternatives available if the planned flight cannot be completed, and any known traffic delays of which the pilot in command has been advised by air traffic control (ATC).

## ASSEMBLING NECESSARY MATERIAL

The pilot should collect the necessary material well before the flight. An appropriate current sectional chart and charts for areas adjoining the flight route should be among this material if the route of flight is near the border of a chart.

Additional equipment should include a flight computer or electronic calculator, plotter, and any other item appropriate to the particular flight—for example, if a night flight is to be undertaken, carry a flashlight; if a flight is over desert country, carry a supply of water and other necessities.

## WEATHER CHECK

It may be wise to check the weather before continuing with other aspects of flight planning to see, first of all, if the flight is feasible and, if it is, which route is best. Chapter 11 on weather discusses obtaining a weather briefing.

## USE OF THE AIRPORT/FACILITY DIRECTORY

Study available information about each airport at which a landing is intended. This should include a study of the *Notices to Airmen* (NOTAMs) and the *Airport/Facility Directory*. [Figure 14-22] This includes location, elevation, runway and lighting facilities, available services, availability of aeronautical advisory station frequency (UNICOM), types of fuel available (use to decide on refueling stops), AFSS/FSS located on the airport, control tower and ground control frequencies, traffic information, remarks, and other pertinent information. The NOTAMs, issued every 28 days, should be checked for additional information on hazardous conditions or changes that have been made since issuance of the *Airport/Facility Directory*.

The sectional chart bulletin subsection should be checked for major changes that have occurred since the last publication date of each sectional chart being used. Remember, the chart may be up to 6 months old. The effective date of the chart appears at the top of the front of the chart.

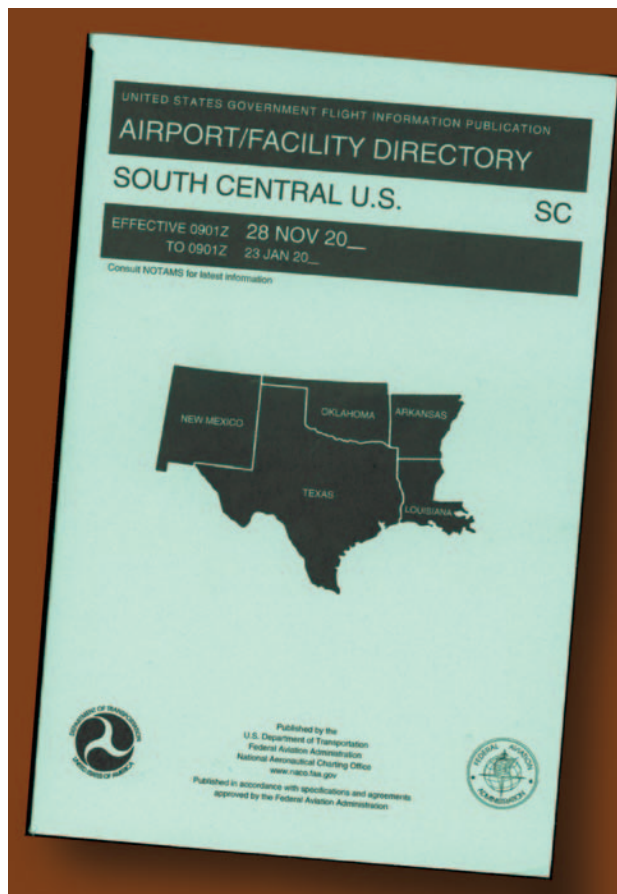

Figure 14-22. Airport Facility Directory.

The *Airport/Facility Directory* will generally have the latest information pertaining to such matters and should be used in preference to the information on the back of the chart, if there are differences.

## AIRPLANE FLIGHT MANUAL OR PILOT'S OPERATING HANDBOOK

The Airplane Flight Manual or Pilot's Operating Handbook (AFM/POH) should be checked to determine the proper loading of the airplane (weight and balance data). The weight of the usable fuel and drainable oil aboard must be known. Also, check the weight of the passengers, the weight of all baggage to be carried, and the empty weight of the airplane to be sure that the total weight does not exceed the maximum allowable. The distribution of the load must be known to tell if the resulting center of gravity is within limits. Be sure to use the latest weight and balance information in the FAA-approved Airplane Flight Manual or other permanent airplane records, as appropriate, to obtain empty weight and empty weight center-of-gravity information.

Determine the takeoff and landing distances from the appropriate charts, based on the calculated load, elevation of the airport, and temperature; then compare these distances with the amount of runway available. Remember, the heavier the load and the higher the

elevation, temperature, or humidity, the longer the takeoff roll and landing roll and the lower the rate of climb.

Check the fuel consumption charts to determine the rate of fuel consumption at the estimated flight altitude and power settings. Calculate the rate of fuel consumption, and then compare it with the estimated time for the flight so that refueling points along the route can be included in the plan.

## CHARTING THE COURSE

Once the weather has been checked and some preliminary planning done, it is time to chart the course and determine the data needed to accomplish the flight. The following sections will provide a logical sequence to follow in charting the course, filling out a flight log, and filing a flight plan. In the following example, a trip is planned based on the following data and the sectional chart excerpt in figure 14-23.

Route of flight: Chickasha Airport direct to Guthrie Airport

True Airspeed (TAS).....	115 knots
Winds Aloft.....	360° at 10 knots
Usable fuel.....	38 gallons
Fuel Rate.....	8 GPH
Deviation.....	+2°

## STEPS IN CHARTING THE COURSE

The following is a suggested sequence for arriving at the pertinent information for the trip. As information is determined, it may be noted as illustrated in the example of a flight log in figure 14-24. Where calculations are required, the pilot may use a mathematical formula or a manual or electronic flight computer. If unfamiliar with how to use a manual or electronic computer competently, it would be advantageous to read the operation manual and work several practice problems at this point.

First draw a line from Chickasha Airport (point A) directly to Guthrie Airport (point F). The course line should begin at the center of the airport of departure and end at the center of the destination airport. If the route is direct, the course line will consist of a single straight line. If the route is not direct, it will consist of two or more straight line segments—for example, a VOR station which is off the direct route, but which will make navigating easier, may be chosen (radio navigation is discussed later in this chapter).

Appropriate checkpoints should be selected along the route and noted in some way. These should be easy-to-locate points such as large towns, large lakes and rivers, or combinations of recognizable points such as towns with an airport, towns with a network of highways, and railroads entering and departing. Normally, choose only towns indicated by splashes of yellow on the

chart. Do not choose towns represented by a small circle—these may turn out to be only a half-dozen houses. (In isolated areas, however, towns represented by a small circle can be prominent checkpoints.) For this trip, four checkpoints have been selected. Checkpoint 1 consists of a tower located east of the course and can be further identified by the highway and railroad track, which almost parallels the course at this point. Checkpoint 2 is the obstruction just to the west of the course and can be further identified by Will Rogers Airport which is directly to the east. Checkpoint 3 is Wiley Post Airport, which the airplane should fly directly over. Checkpoint 4 is a private non-surfaced airport to the west of the course and can be further identified by the railroad track and highway to the east of the course.

The course and areas on either side of the planned route should be checked to determine if there is any type of airspace with which the pilot should be concerned or which has special operational requirements. For this trip, it should be noted that the course will pass through a segment of the Class C airspace surrounding Will Rogers Airport where the floor of the airspace is 2,500 feet mean sea level (MSL) and the ceiling is 5,300 feet MSL (point B). Also, there is Class D airspace from the surface to 3,800 feet MSL surrounding Wiley Post Airport (point C) during the time the control tower is in operation.

Study the terrain and obstructions along the route. This is necessary to determine the highest and lowest elevations as well as the highest obstruction to be encountered so that an appropriate altitude which will conform to part 91 regulations can be selected. If the flight is to be flown at an altitude more than 3,000 feet above the terrain, conformance to the cruising altitude appropriate to the direction of flight is required. Check the route for particularly rugged terrain so it can be avoided. Areas where a takeoff or landing will be made should be carefully checked for tall obstructions. TV transmitting towers may extend to altitudes over 1,500 feet above the surrounding terrain. It is essential that pilots be aware of their presence and location. For this trip, it should be noted that the tallest obstruction is part of a series of antennas with a height of 2,749 feet MSL (point D). The highest elevation should be located in the northeast quadrant and is 2,900 feet MSL (point E).

Since the wind is no factor and it is desirable and within the airplane's capability to fly above the Class C and D airspace to be encountered, an altitude of 5,500 feet MSL will be chosen. This altitude also gives adequate clearance of all obstructions as well as conforms to the part 91 requirement to fly at an altitude of odd thousand plus 500 feet when on a magnetic course between 0 and 179°.

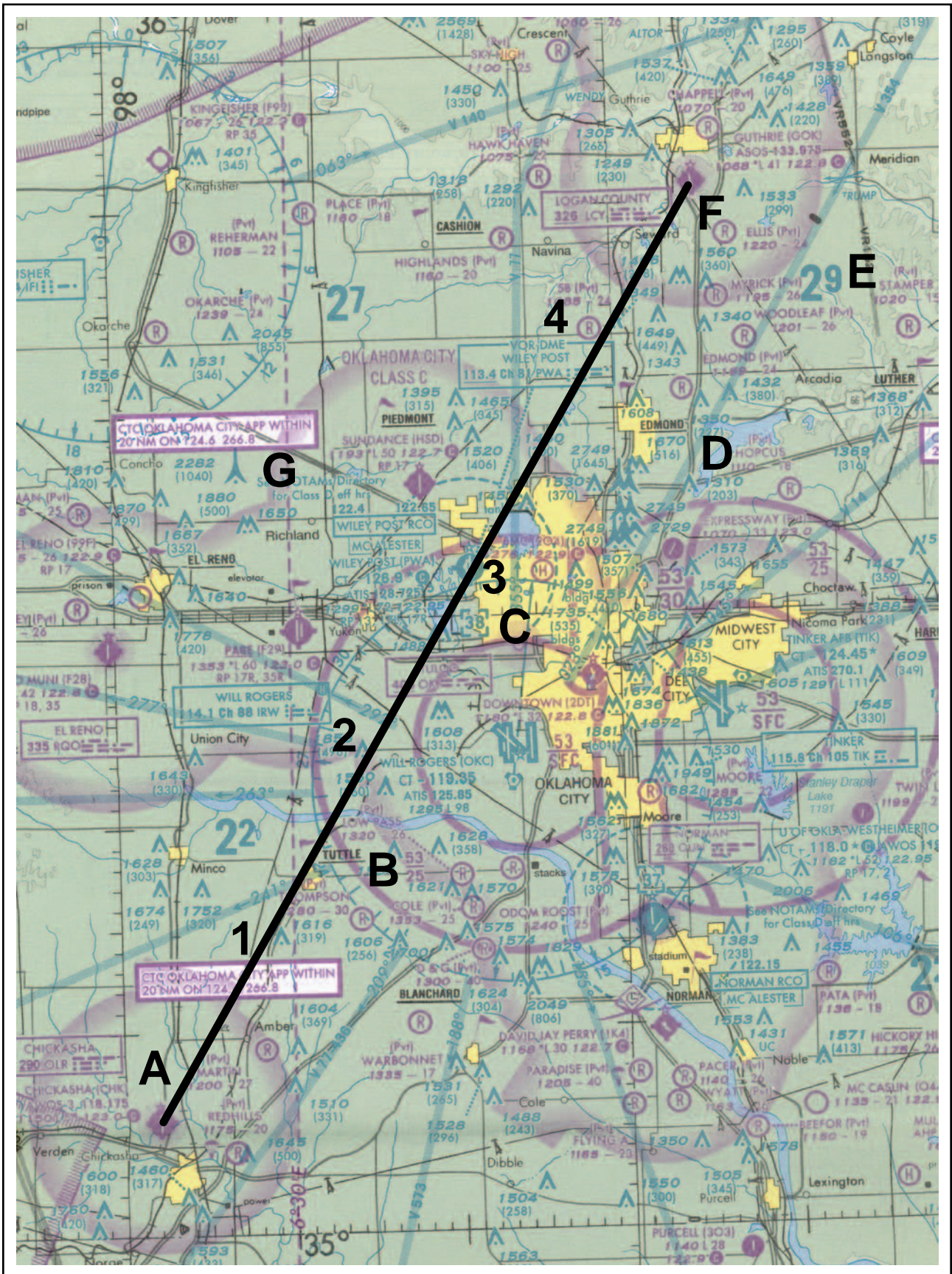

Figure 14-23. Sectional chart excerpt.

Next, the pilot should measure the total distance of the course as well as the distance between checkpoints. The total distance is 53 NM and the distance between checkpoints is as noted on the flight log in figure 14-24.

After determining the distance, the true course should be measured. If using a plotter, follow the directions on the plotter. The true course is 031°. Once the true heading is established, the pilot can determine the compass heading. This is done by following the formula given earlier in this chapter. The formula is:

$$TC \pm WCA = TH \pm VAR = MH \pm DEV = CH$$

The wind correction angle can be determined by using a manual or electronic flight computer. Using a wind of 360° at 10 knots, it is determined the WCA is 3° left. This is subtracted from the TC making the TH 28°. Next, the pilot should locate the isogonic line closest to the route of the flight to determine variation. Point G in figure 14-23 shows the variation to be 6° 30'E (rounded to 7°E), which means it should be subtracted from the TH, giving an MH of 21°. Next, add 2° to the MH for the deviation correction. This gives the pilot the compass heading which is 23°.

Next, the groundspeed should be determined. This can be done using a manual or electronic calculator. It is determined the GS is 106 knots. Based on this information, the total trip time, as well as time between checkpoints, and the fuel burned can be determined. These calculations can be done mathematically or by using a manual or electronic calculator.

For this trip, the GS is 106 knots and the total time is 35 minutes (30 minutes plus 5 minutes for climb) with a fuel burn of 4.7 gallons. Refer to the flight log in figure 14-24 for the time between checkpoints.

As the trip progresses, the pilot can note headings and time and make adjustments in heading, groundspeed, and time.

## FILING A VFR FLIGHT PLAN

Filing a flight plan is not required by regulations; however, it is a good operating practice, since the information contained in the flight plan can be used in search and rescue in the event of an emergency.

Flight plans can be filed in the air by radio, but it is best to file a flight plan either in person at the FSS or by phone just before departing. After takeoff, contact the FSS by radio and give them the takeoff time so the flight plan can be activated.

PILOT'S PLANNING SHEET														
PLANE IDENTIFICATION										DATE				
N123DB														
COURSE	TC	WIND		WCA R+ L-	TH	VAR W+ E-	MH	DEV	CH	TOTAL MILES	GS	TOTAL TIME	FUEL RATE	TOTAL FUEL
		KNOTS	FROM											
From: Chickasha To: Guthrie	031°	10	360°	3° L	28	7° E	21°	+2°	23	53	106kts	35 min	8 GPH	38 gal
From:														
To:														

VISUAL FLIGHT LOG							
TIME OF DEPARTURE	NAVIGATION AIDS	COURSE	DISTANCE	ELAPSED TIME	GS	CH	REMARKS
POINT OF DEPARTURE Chickasha Airport	NAVAID IDENT. FREQ.	TO FROM	POINT TO POINT CUMULATIVE	ESTIMATED ACTUAL	ESTIMATED ACTUAL	ESTIMATED ACTUAL	WEATHER AIRSPACE ETC.
CHECKPOINTS #1			11 NM	6 MIN +5	106 kts	023°	
#2			10NM 21 NM	6 MIN	106 kts	023°	
#3			10.5 NM 31.5 NM	6 MIN	106 kts	023°	
#4			13 NM 44.5 NM	7 MIN	106 kts	023°	
DESTINATION Guthrie Airport			8.5 NM 53 NM	5 MIN			

Figure 14-24. Pilot's planning sheet and visual flight log.

When a VFR flight plan is filed, it will be held by the FSS until 1 hour after the proposed departure time and then canceled unless: the actual departure time is received; or a revised proposed departure time is received; or at the time of filing, the FSS is informed that the proposed departure time will be met, but actual time cannot be given because of inadequate communication. The FSS specialist who accepts the flight plan will not inform the pilot of this procedure, however.

Figure 14-25 shows the flight plan form a pilot files with the Flight Service Station. When filing a flight plan by telephone or radio, give the information in the order of the numbered spaces. This enables the FSS specialist to copy the information more efficiently. Most of the spaces are either self-explanatory or non-applicable to the VFR flight plan (such as item 13). However, some spaces may need explanation.

Item 3 asks for the airplane type and special equipment. An example would be C-150/X, which means the airplane has no transponder. A listing of special equipment codes is listed in the *Aeronautical Information Manual* (AIM).

Item 6 asks for the proposed departure time in Universal Coordinated Time (indicated by the “Z”).

Item 7 asks for the cruising altitude. Normally, “VFR” can be entered in this block, since the pilot will choose a cruising altitude to conform to FAA regulations.

Item 8 asks for the route of flight. If the flight is to be direct, enter the word “direct;” if not, enter the actual route to be followed such as via certain towns or navigation aids.

Item 10 asks for the estimated time en route. In the sample flight plan, 5 minutes was added to the total time to allow for the climb.

Item 12 asks for the fuel on board in hours and minutes. This is determined by dividing the total usable fuel aboard in gallons by the estimated rate of fuel consumption in gallons.

Remember, there is every advantage in filing a flight plan; but do not forget to close the flight plan on arrival. Do this by telephone with the nearest FSS, if possible, to avoid radio congestion.

## RADIO NAVIGATION

Advances in navigational radio receivers installed in airplanes, the development of aeronautical charts which show the exact location of ground transmitting stations and their frequencies, along with refined cockpit instrumentation make it possible for pilots to navigate with precision to almost any point desired. Although precision in navigation is obtainable through the proper use of this equipment, beginning pilots should use this equipment to supplement navigation by visual reference to the ground (pilotage). This method provides the pilot with an effective safeguard against disorientation in the event of radio malfunction.

FLIGHT PLAN									
1. TYPE		2. AIRCRAFT IDENTIFICATION	3. AIRCRAFT TYPE/SPECIAL EQUIPMENT	4. TRUE AIRSPEED	5. DEPARTURE POINT	6. DEPARTURE TIME		7. CRUISING ALTITUDE	
X	VFR	N123DB	C150/X	115	CHICKASHA AIRPORT	PROPOSED (Z)    ACTUAL (Z)		5500	
	IFR					1400Z			
	DVFR								
8. ROUTE OF FLIGHT									
Chickasha direct Guthrie									
9. DESTINATION (Name of airport and city)				10. EST. TIME ENROUTE		11. REMARKS			
Guthrie Airport Guthrie, OK				HOURS	MINUTES				
				35					
12. FUEL ON BOARD		13. ALTERNATE AIRPORT(S)			14. PILOT'S NAME, ADDRESS & TELEPHONE NUMBER & AIRCRAFT HOME BASE			15. NUMBER ABOARD	
HOURS	MINUTES				Jane Smith Aero Air Oklahoma City, OK (405) 555-4149			1	
4	45								
16. COLOR OF AIRCRAFT			CLOSE VFR FLIGHT PLAN WITH _____ FSS ON ARRIVAL						
Red/White			CLOSE VFR FLIGHT PLAN WITH <u>McAlester</u> FSS ON ARRIVAL						

Figure 14-25. Flight plan form.

There are four radio navigation systems available for use for VFR navigation. These are:

- VHF Omnidirectional Range (VOR)
- Nondirectional Radiobeacon (NDB)
- Long Range Navigation (LORAN-C)
- Global Positioning System (GPS)

**VERY HIGH FREQUENCY (VHF)  
OMNIDIRECTIONAL RANGE (VOR)**

The VOR system is present in three slightly different navigation aids (NAVAIDs): VOR, VOR/DME, and VORTAC. By itself it is known as a VOR, and it provides magnetic bearing information to and from the station. When DME is also installed with a VOR, the NAVAID is referred to as a VOR/DME. When military tactical air navigation (TACAN) equipment is installed with a VOR, the NAVAID is known as a VORTAC. DME is always an integral part of a VORTAC. Regardless of the type of NAVAID utilized (VOR, VOR/DME or VORTAC), the VOR indicator behaves the same. Unless otherwise noted, in this section, VOR, VOR/DME and VORTAC NAVAIDs will all be referred to hereafter as VORs.

The word “omni” means all, and an omnidirectional range is a VHF radio transmitting ground station that projects straight line courses (radials) from the station in all directions. From a top view, it can be visualized as being similar to the spokes from the hub of a wheel. The distance VOR radials are projected depends upon the power output of the transmitter.

The course or radials projected from the station are referenced to magnetic north. Therefore, a radial is defined as a line of magnetic bearing extending outward from the VOR station. Radials are identified by numbers beginning with 001, which is 1° east of magnetic north, and progress in sequence through all the degrees of a circle until reaching 360. To aid in orientation, a compass rose reference to magnetic north is superimposed on aeronautical charts at the station location.

VOR ground stations transmit within a VHF frequency band of 108.0 – 117.95 MHz. Because the equipment is VHF, the signals transmitted are subject to line-of-sight restrictions. Therefore, its range varies in direct proportion to the altitude of receiving equipment. Generally, the reception range of the signals at an altitude of 1,000 feet above ground level (AGL) is about 40 to 45 miles. This distance increases with altitude. [Figure 14-26]

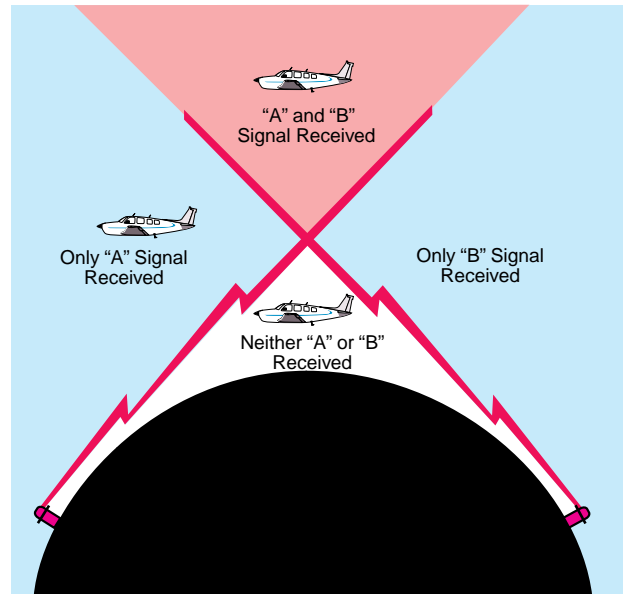

Figure 14-26. VHF transmissions follow a line-of-sight course.

VORs and VORTACs are classed according to operational use. There are three classes:

- T (Terminal)
- L (Low altitude)
- H (High altitude)

The normal useful range for the various classes is shown in the following table:

**VOR/VORTAC NAVAIDS**

Normal Usable Altitudes and Radius Distances

Class	Altitudes	Distance (Miles)
T	12,000' and below	25
L	Below 18,000'	40
H	Below 14,500'	40
H	Within the conterminous 48 states only, between 14,500 and 17,999'	100
H	18,000' – FL 450	130
H	FL 450 – 60,000'	100

The useful range of certain facilities may be less than 50 miles. For further information concerning these restrictions, refer to the Comm/NAVAID Remarks in the *Airport/Facility Directory*.

The accuracy of course alignment of VOR radials is considered to be excellent. It is generally within plus or minus 1°. However, certain parts of the VOR

receiver equipment deteriorate, and this affects its accuracy. This is particularly true at great distances from the VOR station. The best assurance of maintaining an accurate VOR receiver is periodic checks and calibrations. VOR accuracy checks are not a regulatory requirement for VFR flight. However, to assure accuracy of the equipment, these checks should be accomplished quite frequently along with a complete calibration each year. The following means are provided for pilots to check VOR accuracy:

- FAA VOR test facility (VOT);
- certified airborne checkpoints;
- certified ground checkpoints located on airport surfaces.

If dual VOR is installed in the airplane and tuned to the same VOR ground facility, the maximum permissible variation between the two indicated bearings is 4°.

A list of these checkpoints is published in the *Airport/Facility Directory*.

Basically, these checks consist of verifying that the VOR radials the airplane equipment receives are aligned with the radials the station transmits. There are not specific tolerances in VOR checks required for VFR flight. But as a guide to assure acceptable accuracy, the required IFR tolerances can be used which are  $\pm 4^\circ$  for ground checks and  $\pm 6^\circ$  for airborne checks. These checks can be performed by the pilot.

The VOR transmitting station can be positively identified by its Morse code identification or by a recorded voice identification which states the name of the station followed by the word "VOR." Many Flight Service Stations transmit voice messages on the same frequency that the VOR operates. Voice transmissions should not be relied upon to identify stations, because many FSSs remotely transmit over several omniranges, which have different names than the transmitting FSS. If the VOR is out of service for maintenance, the coded identification is removed and not transmitted. This serves to alert pilots that this station should not be used for navigation. VOR receivers are designed with an alarm flag to indicate when signal strength is inadequate to operate the navigational equipment. This happens if the airplane is too far from the VOR or the airplane is too low and therefore, is out of the line-of-sight of the transmitting signals.

### USING THE VOR

In review, for VOR radio navigation, there are two components required: the ground transmitter and the airplane receiving equipment. The ground transmitter is located at a specific position on the ground and trans-

mits on an assigned frequency. The airplane equipment includes a receiver with a tuning device and a VOR or omnirange instrument. The navigation instrument consists of (1) an omnibearing selector (OBS) sometimes referred to as the course selector, (2) a course deviation indicator needle (Left-Right Needle), and (3) a TO-FROM indicator.

The course selector is an azimuth dial that can be rotated to select a desired radial or to determine the radial over which the airplane is flying. In addition, the magnetic course "TO" or "FROM" the station can be determined.

When the course selector is rotated, it moves the course deviation indicator (CDI) or needle to indicate the position of the radial relative to the airplane. If the course selector is rotated until the deviation needle is centered, the radial (magnetic course "FROM" the station) or its reciprocal (magnetic course "TO" the station) can be determined. The course deviation needle will also move to the right or left if the airplane is flown or drifting away from the radial which is set in the course selector.

By centering the needle, the course selector will indicate either the course "FROM" the station or the course "TO" the station. If the flag displays a "TO," the course shown on the course selector must be flown to the station. [Figure 14-27] If "FROM" is displayed and the course shown is followed, the airplane will be flown away from the station.



Figure 14-27. VOR indicator.



## TRACKING WITH VOR

The following describes a step-by-step procedure to use when tracking to and from a VOR station. Figure 14-28 illustrates the discussion:

First, tune the VOR receiver to the frequency of the selected VOR station. For example: 115.0 to receive Bravo VOR. Next, check the identifiers to verify that the desired VOR is being received. As soon as the VOR is properly tuned, the course deviation needle will deflect either left or right; then rotate the azimuth dial to the course selector until the course deviation needle centers and the TO-FROM indicates "TO." If the needle centers with a "FROM" indication, the azimuth should be rotated 180° because, in this case, it is desired to fly "TO" the station. Now, turn the airplane to the heading indicated on the VOR azimuth dial or course selector. In this example 350°.

If a heading of 350° is maintained with a wind from the right as shown, the airplane will drift to the left of the intended track. As the airplane drifts off course, the VOR course deviation needle will gradually move to the right of center or indicate the direction of the desired radial or track.

To return to the desired radial, the airplane heading must be altered to the right. As the airplane returns to the desired track, the deviation needle will slowly return to center. When centered, the airplane will be on the desired radial and a left turn must be made toward, but not to the original heading of 350° because a wind drift correction must be established. The amount of correction depends upon the strength of the wind. If the wind velocity is unknown, a trial and error method can be used to find the correct heading. Assume, for this example, a 10° correction or a heading of 360° is maintained.

While maintaining a heading of 360°, assume that the course deviation begins to move to the left. This means that the wind correction of 10° is too great and the airplane is flying to the right of course. A slight turn to the left should be made to permit the airplane to return to the desired radial.

When the deviation needle centers, a small wind drift correction of 5° or a heading correction of 355° should be flown. If this correction is adequate, the airplane will remain on the radial. If not, small variation in heading should be made to keep the needle centered, and consequently keep the airplane on the radial.

As the VOR station is passed, the course deviation needle will fluctuate, then settle down, and the "TO" indication will change to "FROM." If the airplane passes to

one side of the station, the needle will deflect in the direction of the station as the indicator changes to "FROM."

Generally, the same techniques apply when tracking outbound as those used for tracking inbound. If the intent is to fly over the station and track outbound on the reciprocal of the inbound radial, the course selector should not be changed. Corrections are made in the same manner to keep the needle centered. The only difference is that the omni will indicate "FROM."

If tracking outbound on a course other than the reciprocal of the inbound radial, this new course or radial must be set in the course selector and a turn made to intercept this course. After this course is reached, tracking procedures are the same as previously discussed.

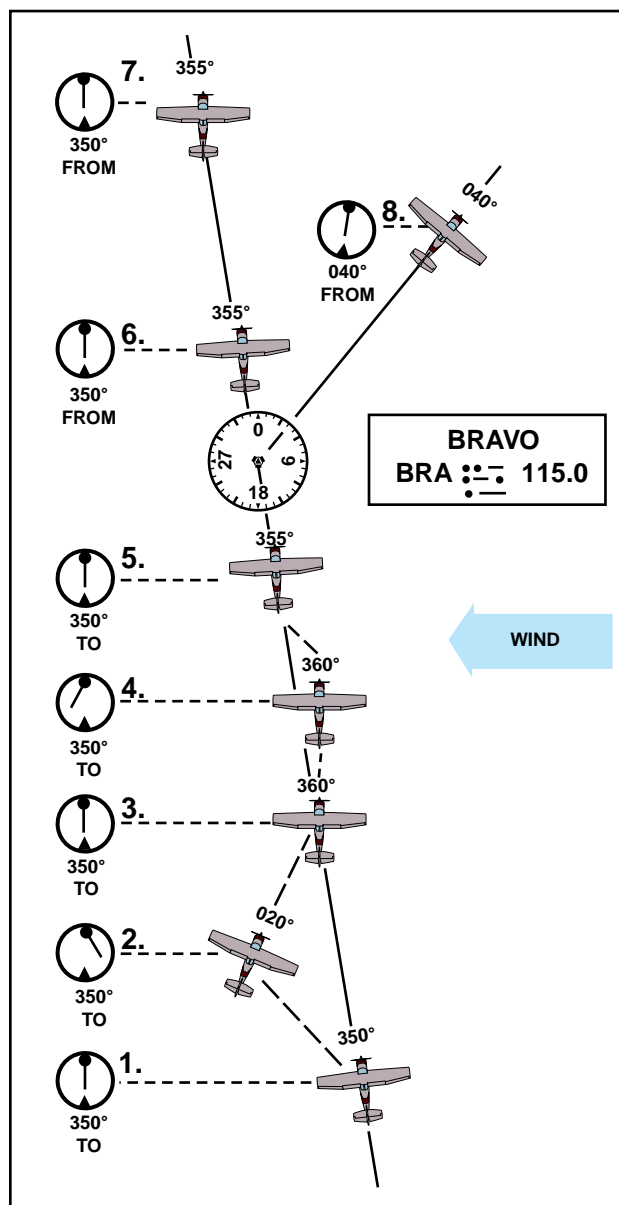

Figure 14-28. Tracking a radial in a crosswind.

## TIPS ON USING THE VOR

- Positively identify the station by its code or voice identification.
- Keep in mind that VOR signals are “line-of-sight.” A weak signal or no signal at all will be received if the airplane is too low or too far from the station.
- When navigating to a station, determine the inbound radial and use this radial. If the airplane drifts, do not reset the course selector, but correct for drift and fly a heading that will compensate for wind drift.
- If minor needle fluctuations occur, avoid changing headings immediately. Wait momentarily to see if the needle recenters; if it doesn’t, then correct.
- When flying “TO” a station, always fly the selected course with a “TO” indication. When flying “FROM” a station, always fly the selected course with a “FROM” indication. If this is not done, the action of the course deviation needle will be reversed. To further explain this reverse action, if the airplane is flown toward a station with a “FROM” indication or away from a station with a “TO” indication, the course deviation needle will indicate in an opposite direction to that which it should. For example, if the airplane drifts to the right of a radial being flown, the needle will move to the right or point away from the radial. If the airplane drifts to the left of the radial being flown, the needle will move left or in the opposite direction of the radial.

## DISTANCE MEASURING EQUIPMENT

Distance measuring equipment (DME) is an ultra high frequency (UHF) navigational aid present with VOR/DMEs and VORTACs. It measures, in nautical miles (NM), the slant range distance of an airplane from a VOR/DME or VORTAC (both hereafter referred to as a VORTAC). Although DME equipment is very popular, not all airplanes are DME equipped.

To utilize DME, the pilot should select, tune, and identify a VORTAC, as previously described. The DME receiver, utilizing what is called a “paired frequency” concept, automatically selects and tunes the UHF DME frequency associated with the VHF VORTAC frequency selected by the pilot. This process is entirely transparent to the pilot. After a brief pause, the DME display will show the slant range distance to or from the VORTAC. Slant range distance is the direct distance between the airplane and the VORTAC, and is therefore affected by airplane altitude. (Station passage

directly over a VORTAC from an altitude of 6,076 feet above ground level (AGL) would show approximately 1.0 NM on the DME.) DME is a very useful adjunct to VOR navigation. A VOR radial alone merely gives line of position information. With DME, a pilot may precisely locate the airplane on that line (radial).

Most DME receivers also provide groundspeed and time-to-station modes of operation. The groundspeed is displayed in knots (NM per hour). The time-to-station mode displays the minutes remaining to VORTAC station passage, predicated upon the present groundspeed. Groundspeed and time-to-station information is only accurate when tracking directly to or from a VORTAC. DME receivers typically need a minute or two of stabilized flight directly to or from a VORTAC before displaying accurate groundspeed or time-to-station information.

Some DME installations have a hold feature that permits a DME signal to be retained from one VORTAC while the course indicator displays course deviation information from an ILS or another VORTAC.

## VOR/DME RNAV

Area navigation (RNAV) permits electronic course guidance on any direct route between points established by the pilot. While RNAV is a generic term that applies to a variety of navigational aids, such as LORAN-C, GPS, and others, this section will deal with VOR/DME-based RNAV. VOR/DME RNAV is not a separate ground-based NAVAID, but a method of navigation using VOR/DME and VORTAC signals specially processed by the airplane’s RNAV computer.

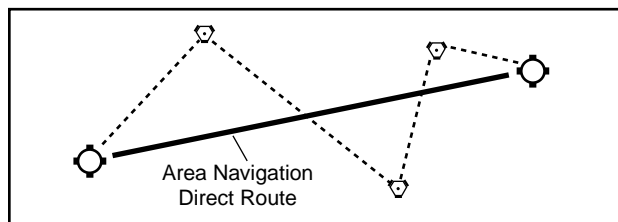

FIGURE 14-29. Flying an RNAV course.

[Figure 14-29] Note: In this section, the term “VORTAC” also includes VOR/DME NAVAIDs.

In its simplest form, VOR/DME RNAV allows the pilot to electronically move VORTACs around to more convenient locations. Once electronically relocated, they are referred to as waypoints. These waypoints are described as a combination of a selected radial and distance within the service volume of the VORTAC to be used. These waypoints allow a straight course to be flown between almost any origin and destination, without regard to the orientation of VORTACs or the existence of airways.

While the capabilities and methods of operation of VOR/DME RNAV units differ, there are basic principals of operation that are common to all. Pilots are urged to study the manufacturer's operating guide and receive instruction prior to the use of VOR/DME RNAV or any unfamiliar navigational system. Operational information and limitations should also be sought from placards and the supplement section of the Airplane Flight Manual and/or Pilot's Operating Handbook (AFM/POH).

VOR/DME-based RNAV units operate in at least three modes: VOR, En Route, and Approach. A fourth mode, VOR Parallel, may also be found on some models. The units need both VOR and DME signals to operate in any RNAV mode. If the NAVAID selected is a VOR without DME, RNAV mode will not function.

In the VOR (or non-RNAV) mode, the unit simply functions as a VOR receiver with DME capability. [Figure 14-30] The unit's display on the VOR indicator is conventional in all respects. For operation on established airways or any other ordinary VOR navigation, the VOR mode is used.



FIGURE 14-30. RNAV controls.

To utilize the unit's RNAV capability, the pilot selects and establishes a waypoint or a series of waypoints to define a course. To operate in any RNAV mode, the unit needs both radial and distance signals; therefore, a VORTAC (or VOR/DME) needs to be selected as a NAVAID. To establish a waypoint, a point somewhere within the service range of a VORTAC is defined on the basis of radial and distance. Once the waypoint is entered into the unit and the RNAV En Route mode is selected, the CDI will display course guidance to the waypoint, not the original VORTAC. DME will also display distance to the waypoint. Many units have the capability to store several waypoints, allowing them to be programmed prior to flight, if desired, and called up in flight.

RNAV waypoints are entered into the unit in magnetic bearings (radials) of degrees and tenths (i.e., 275.5°) and distances in nautical miles and tenths (i.e., 25.2 NM). When plotting RNAV waypoints on an aeronautical chart, pilots will find it difficult to measure to that level of accuracy, and in practical application, it is rarely necessary. A number of flight planning publica-

tions publish airport coordinates and waypoints with this precision and the unit will accept those figures. There is a subtle, but important difference in CDI operation and display in the RNAV modes.

In the RNAV modes, course deviation is displayed in terms of linear deviation. In the RNAV En Route mode, maximum deflection of the CDI typically represents 5 NM on either side of the selected course, without regard to distance from the waypoint. In the RNAV Approach mode, maximum deflection of the CDI typically represents 1 1/4 NM on either side of the selected course. There is no increase in CDI sensitivity as the airplane approaches a waypoint in RNAV mode.

The RNAV Approach mode is used for instrument approaches. Its narrow scale width (one-quarter of the En Route mode) permits very precise tracking to or from the selected waypoint. In visual flight rules (VFR) cross-country navigation, tracking a course in the Approach mode is not desirable because it requires a great deal of attention and soon becomes tedious.

A fourth, lesser-used mode on some units is the VOR Parallel mode. This permits the CDI to display linear (not angular) deviation as the airplane tracks to and from VORTACs. It derives its name from permitting the pilot to offset (or parallel) a selected course or airway at a fixed distance of the pilot's choosing, if desired. The VOR Parallel mode has the same effect as placing a waypoint directly over an existing VORTAC. Some pilots select the VOR Parallel mode when utilizing the navigation (NAV) tracking function of their autopilot for smoother course following near the VORTAC.

Confusion is possible when navigating an airplane with VOR/DME-based RNAV, and it is essential that the pilot become familiar with the equipment installed. It is not unknown for pilots to operate inadvertently in one of the RNAV modes when the operation was not intended by overlooking switch positions or annunciators. The reverse has also occurred with a pilot neglecting to place the unit into one of the RNAV modes by overlooking switch positions or annunciators. As always, the prudent pilot is not only familiar with the equipment used, but never places complete reliance in just one method of navigation when others are available for cross-check.

### AUTOMATIC DIRECTION FINDER

Many general aviation-type airplanes are equipped with automatic direction finder (ADF) radio receiving equipment. To navigate using the ADF, the pilot tunes the receiving equipment to a ground station known as a NONDIRECTIONAL RADIOBEACON (NDB). The NDB stations normally operate in a low or medium frequency band of 200 to 415 kHz. The frequencies are

readily available on aeronautical charts or in the *Airport/Facility Directory*.

All radiobeacons except compass locators transmit a continuous three-letter identification in code except during voice transmissions. A compass locator, which is associated with an Instrument Landing System, transmits a two-letter identification.

Standard broadcast stations can also be used in conjunction with ADF. Positive identification of all radio stations is extremely important and this is particularly true when using standard broadcast stations for navigation.

Nondirectional radiobeacons have one advantage over the VOR. This advantage is that low or medium frequencies are not affected by line-of-sight. The signals follow the curvature of the Earth; therefore, if the airplane is within the range of the station, the signals can be received regardless of altitude.

The following table gives the class of NDB stations, their power, and usable range:

**NONDIRECTIONAL RADIOBEACON (NDB)**  
(Usable Radius Distances for All Altitudes)

<i>Class</i>	<i>Power(Watts)</i>	<i>Distance (Miles)</i>
Compass Locator	Under 25	15
MH	Under 50	25
H	50 – 1999	*50
HH	2000 or more	75

\*Service range of individual facilities may be less than 50 miles.

One of the disadvantages that should be considered when using low frequency for navigation is that low-frequency signals are very susceptible to electrical disturbances, such as lightning. These disturbances create excessive static, needle deviations, and signal fades. There may be interference from distant stations. Pilots should know the conditions under which these disturbances can occur so they can be more alert to possible interference when using the ADF.

Basically, the ADF airplane equipment consists of a tuner, which is used to set the desired station frequency, and the navigational display.

The navigational display consists of a dial upon which the azimuth is printed, and a needle which rotates around the dial and points to the station to which the receiver is tuned.

Some of the ADF dials can be rotated so as to align the azimuth with the airplane heading; others are fixed with 0° representing the nose of the airplane, and 180° representing the tail. Only the fixed azimuth dial will be discussed in this handbook. [Figure 14-31]

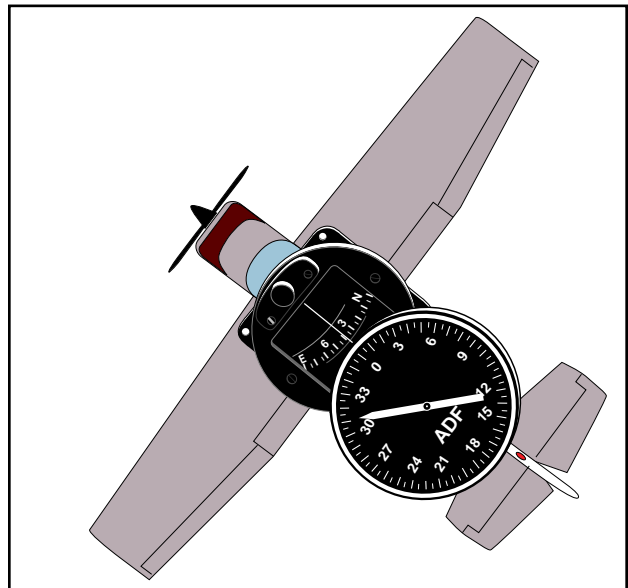

Figure 14-31. ADF with fixed azimuth and magnetic compass.

Figure 14-32 illustrates the following terms that are used with the ADF and should be understood by the pilot.

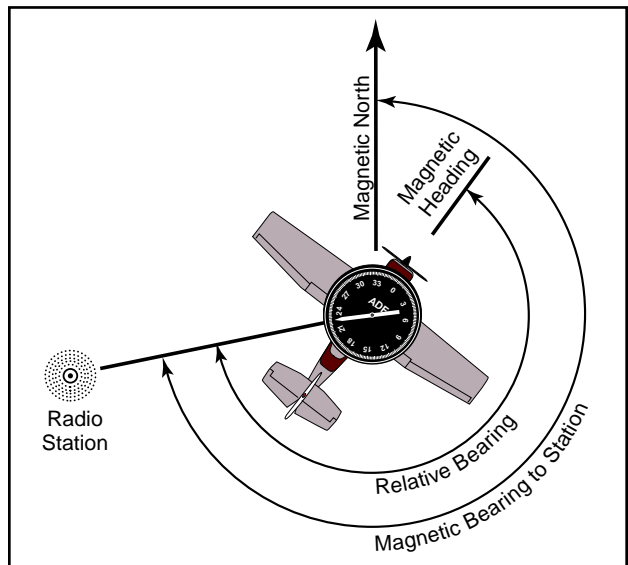

Figure 14-32. ADF terms.

**Relative Bearing**—is the value to which the indicator (needle) points on the azimuth dial. When using a fixed dial, this number is relative to the nose of the airplane and is the angle measured clockwise from the nose of the airplane to a line drawn from the airplane to the station.

**Magnetic Bearing**—“TO” the station is the angle formed by a line drawn from the airplane to the station and a line drawn from the airplane to magnetic north. The magnetic bearing to the station can be determined by adding the relative bearing to the magnetic heading of the airplane. For example, if the relative bearing is 060° and the magnetic heading is 130°, the magnetic bearing to the station is

060° plus 130° or 190°. This means that in still air a magnetic heading of approximately 190° would be flown to the station. If the total is greater than 360°, subtract 360° from the total to obtain the magnetic bearing to the station. For example, if the relative bearing is 270° and magnetic heading is 300°, 360° is subtracted from the total, or  $570° - 360° = 210°$ , which is the magnetic bearing to the station.

To determine the magnetic bearing “FROM” the station, 180° is added to or subtracted from the magnetic bearing to the station. This is the reciprocal bearing and is used when plotting position fixes.

Keep in mind that the needle of fixed azimuth points to the station in relation to the nose of the airplane. If the needle is deflected 30° to the left or a relative bearing of 330°, this means that the station is located 30° left. If the airplane is turned left 30°, the needle will move to the right 30° and indicate a relative bearing of 0° or the airplane will be pointing toward the station. If the pilot continues flight toward the station keeping the needle on 0°, the procedure is called homing to the station. If a crosswind exists, the ADF needle will continue to drift away from zero. To keep the needle on zero, the airplane must be turned slightly resulting in a curved flightpath to the station. Homing to the station is a common procedure, but results in drifting downwind, thus lengthening the distance to the station.

Tracking to the station requires correcting for wind drift and results in maintaining flight along a straight track or bearing to the station. When the wind drift correction is established, the ADF needle will indicate the amount of correction to the right or left. For instance, if the magnetic bearing to the station is 340°, a correction for a left crosswind would result in a magnetic heading of 330°, and the ADF needle would indicate 10° to the right or a relative bearing of 010°. [Figure 14-33]

When tracking away from the station, wind corrections are made similar to tracking to the station, but the ADF needle points toward the tail of the airplane or the 180° position on the azimuth dial. Attempting to keep the ADF needle on the 180° position during winds results in the airplane flying a curved flight leading further and further from the desired track. To correct for wind when tracking outbound, correction should be made in the direction opposite of that in which the needle is pointing.

Although the ADF is not as popular as the VOR for radio navigation, with proper precautions and intelligent use, the ADF can be a valuable aid to navigation.

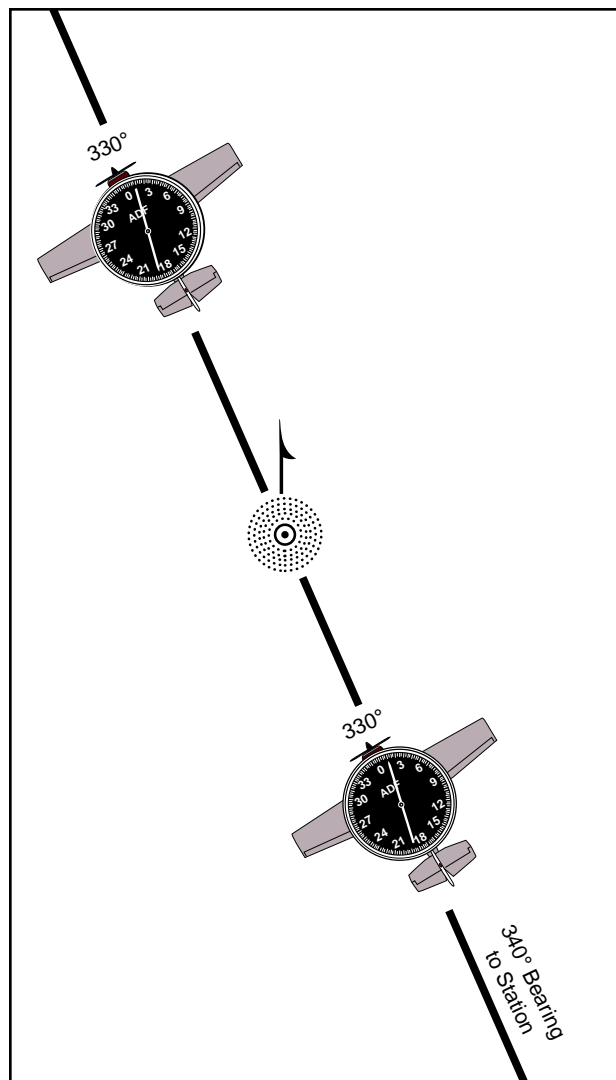

Figure 14-33. ADF tracking.

## LORAN-C NAVIGATION

Long Range Navigation, version C (LORAN-C) is another form of RNAV, but one that operates from chains of transmitters broadcasting signals in the low frequency (LF) spectrum. World Aeronautical Chart (WAC), Sectional Charts, and VFR Terminal Area Charts do not show the presence of LORAN-C transmitters. Selection of a transmitter chain is either made automatically by the unit, or manually by the pilot using guidance information provided by the manufacturer. LORAN-C is a highly accurate, supplemental form of navigation typically installed as an adjunct to VOR and ADF equipment. Databases of airports, NAVAIDs, and air traffic control facilities are frequently features of LORAN-C receivers.

LORAN-C is an outgrowth of the original LORAN-A developed for navigation during World War II. The LORAN-C system is used extensively in maritime applications. It experienced a dramatic growth in popularity with pilots with the advent of the small, panel-mounted LORAN-C receivers available at

relatively low cost. These units are frequently very sophisticated and capable, with a wide variety of navigational functions.

With high levels of LORAN-C sophistication and capability, a certain complexity in operation is an unfortunate necessity. Pilots are urged to read the operating handbooks and to consult the supplements section of the AFM/POH prior to utilizing LORAN-C for navigation. Many units offer so many features that the manufacturers often publish two different sets of instructions: (1) a brief operating guide and (2) in-depth operating manual.

While coverage is not global, LORAN-C signals are suitable for navigation in all of the conterminous United States, and parts of Canada and Alaska. Several foreign countries also operate their own LORAN-C systems. In the United States, the U.S. Coast Guard operates the LORAN-C system. LORAN-C system status is available from: USCG Navigation Center, Alexandria, VA (703) 313-5900.

LORAN-C absolute accuracy is excellent—position errors are typically less than .25 NM. Repeatable accuracy, or the ability to return to a waypoint previously visited, is even better. While LORAN-C is a form of RNAV, it differs significantly from VOR/DME-based RNAV. It operates in a 90 – 110 kHz frequency range and is based upon measurement of the difference in arrival times of pulses of radio frequency (RF) energy emitted by a chain of transmitters hundreds of miles apart.

Within any given chain of transmitters, there is a master station, and from three to five secondary stations. LORAN-C units must be able to receive at least a master and two secondary stations to provide navigational information. Unlike VOR/DME-based RNAV, where the pilot must select the appropriate VOR/DME or VORTAC frequency, there is not a frequency selection in LORAN-C. The most advanced units automatically select the optimum chain for navigation. Other units rely upon the pilot to select the appropriate chain with a manual entry.

After the LORAN-C receiver has been turned on, the unit must be initialized before it can be used for navigation. While this can be accomplished in flight, it is preferable to perform this task, which can take several minutes, on the ground. The methods for initialization are as varied as the number of different models of receivers. Some require pilot input during the process, such as verification or acknowledgment of the information displayed.

Most units contain databases of navigational information. Frequently, such databases contain not

only airport and NAVAID locations, but also extensive airport, airspace, and ATC information. While the unit will operate with an expired database, the information should be current or verified to be correct prior to use. The pilot can update some databases, while others require removal from the airplane and the services of an avionics technician.

VFR navigation with LORAN-C can be as simple as telling the unit where the pilot wishes to go. The course guidance provided will be a great circle (shortest distance) route to the destination. Older units may need a destination entered in terms of latitude and longitude, but recent designs only need the identifier of the airport or NAVAID. The unit will also permit database storage and retrieval of pilot defined waypoints. LORAN-C signals follow the curvature of the Earth and are generally usable hundreds of miles from their transmitters.

The LORAN-C signal is subject to degradation from a variety of atmospheric disturbances. It is also susceptible to interference from static electricity buildup on the airframe and electrically “noisy” airframe equipment. Flight in precipitation or even dust clouds can cause occasional interference with navigational guidance from LORAN-C signals. To minimize these effects, static wicks and bonding straps should be installed and properly maintained.

LORAN-C navigation information is presented to the pilot in a variety of ways. All units have self-contained displays, and some elaborate units feature built-in moving map displays. Some installations can also drive an external moving map display, a conventional VOR indicator, or a horizontal situation indicator (HSI). Course deviation information is presented as a linear deviation from course—there is no increase in tracking sensitivity as the airplane approaches the waypoint or destination. Pilots must carefully observe placards, selector switch positions, and annunciator indications when utilizing LORAN-C because airplane installations can vary widely. The pilot’s familiarity with unit operation through AFM/POH supplements and operating guides cannot be overemphasized.

LORAN-C *Notices To Airmen* (NOTAMs) should be reviewed prior to relying on LORAN-C for navigation. LORAN-C NOTAMs will be issued to announce outages for specific chains and transmitters. Pilots may obtain LORAN-C NOTAMs from FSS briefers only upon request.

The prudent pilot will never rely solely on one means of navigation when others are available for backup and cross-check. Pilots should never become so dependent upon the extensive capabilities of LORAN-C that other methods of navigation are neglected.

## GLOBAL POSITIONING SYSTEM

The global positioning system (GPS) is a satellite-based radio navigation system. Its RNAV guidance is worldwide in scope. There are no symbols for GPS on aeronautical charts as it is a space-based system with global coverage. Development of the system is underway so that GPS will be capable of providing the primary means of electronic navigation. Portable and yoke mounted units are proving to be very popular in addition to those permanently installed in the airplane. Extensive navigation databases are common features in airplane GPS receivers.

The GPS is a satellite radio navigation and time dissemination system developed and operated by the U.S. Department of Defense (DOD). Civilian interface and GPS system status is available from the U.S. Coast Guard.

It is not necessary to understand the technical aspects of GPS operation to use it in VFR/instrument flight rules (IFR) navigation. It does differ significantly from conventional, ground-based electronic navigation, and awareness of those differences is important. Awareness of equipment approvals and limitations is critical to the safety of flight. The GPS system is composed of three major elements:

1. The space segment is composed of a constellation of 26 satellites orbiting approximately 10,900 NM above the Earth. The operational satellites are often referred to as the GPS constellation. The satellites are not geosynchronous but instead orbit the Earth in periods of approximately 12 hours. Each satellite is equipped with highly stable atomic clocks and transmits a unique code and navigation message. Transmitting in the UHF range means that the signals are virtually unaffected by weather although they are subject to line-of-sight limitations. The satellites must be above the horizon (as seen by the receiver's antenna) to be usable for navigation.
2. The control segment consists of a master control station at Falcon AFB, Colorado Springs, CO, five monitor stations, and three ground antennas. The monitor stations and ground antennas are distributed around the Earth to allow continual monitoring and communications with the satellites. Updates and corrections to the navigational message broadcast by each satellite are uplinked to the satellites as they pass over the ground antennas.

3. The user segment consists of all components associated with the GPS receiver, ranging from portable, hand-held receivers to receivers permanently installed in the airplane. The receiver matches the satellite's coded signal by shifting its own identical code in a matching process to precisely measure the time of arrival. Knowing the speed the signal traveled (approximately 186,000 miles per second) and the exact broadcast time, the distance traveled by the signal can be inferred from its arrival time.

To solve for its location, the GPS receiver utilizes the signals of at least four of the best-positioned satellites to yield a three-dimensional fix (latitude, longitude, and altitude). A two-dimensional fix (latitude and longitude only) can be determined with as few as three satellites. GPS receivers have extensive databases. Databases are provided initially by the receiver manufacturer and updated by the manufacturer or a designated data agency.

A wide variety of GPS receivers with extensive navigation capabilities are available. Panel mounted units permanently installed in the airplane may be used for VFR and may also have certain IFR approvals. Portable hand-held and yoke mounted GPS receivers are also popular, although these are limited to VFR use. Not all GPS receivers on the market are suited for air navigation. Marine, recreational, and surveying units, for example, are not suitable for airplane use. As with LORAN-C receivers, GPS unit features and operating procedures vary widely. The pilot must be familiar with the manufacturer's operating guide. Placards, switch positions, and annunciators should be carefully observed.

Initialization of the unit will require several minutes and should be accomplished prior to flight. If the unit has not been operated for several months or if it has been moved to a significantly different location (by several hundred miles) while off, this may require several additional minutes. During initialization, the unit will make internal integrity checks, acquire satellite signals, and display the database revision date. While the unit will operate with an expired database, the database should be current, or verified to be correct, prior to relying on it for navigation.

VFR navigation with GPS can be as simple as selecting a destination (an airport, VOR, NDB, intersection, or pilot defined waypoint) and placing the unit in the navigation mode. Course guidance provided will be a great circle route (shortest distance) direct to the destination. Many units provide advisory information about special use airspace and minimum safe altitudes,

along with extensive airport data, and ATC services and frequencies. Users having prior experience with LORAN-C receivers will note many similarities in the wealth of navigation information available, although the technical principles of operation are quite different.

All GPS receivers have integral (built into the unit) navigation displays and some feature integral moving map displays. Some panel-mounted units will drive a VOR indicator, HSI, or even an external moving map display. GPS course deviation is linear—there is not an increase in tracking sensitivity as the airplane approaches a waypoint. Pilots must carefully observe placards, selector switch positions, and annunciator indications when utilizing GPS as installations and approvals can vary widely.

The integral GPS navigation display (like most LORAN-C units) uses several additional navigational terms beyond those used in NDB and VOR navigation. Some of these terms, whose abbreviations vary among manufacturers, are shown below. The pilot should consult the manufacturer's operating guide for specific definitions.

NOTAMs should be reviewed prior to relying on GPS for navigation. GPS NOTAMs will be issued to announce outages for specific GPS satellites by pseudorandom noise code (PRN) and satellite vehicle number (SVN). Pilots may obtain GPS NOTAMs from FSS briefers only upon request.

When using any sophisticated and highly capable navigation system, such as LORAN-C or GPS, there is a strong temptation to rely almost exclusively on that unit, to the detriment of using other techniques of position keeping. The prudent pilot will never rely on one means of navigation when others are available for cross-check and backup.

## LOST PROCEDURES

Getting lost in an airplane is a potentially dangerous situation especially when low on fuel. If a pilot becomes lost, there are some good common sense procedures to follow. If a town or city cannot be seen, the first thing to do is climb, being mindful of traffic and weather conditions. An increase in altitude increases radio and navigation reception range, and also increases radar coverage. If flying near a town or city, it might be possible to read the name of the town on a water tower.

If the airplane has a navigational radio, such as a VOR or ADF receiver, it can be possible to determine position by plotting an azimuth from two or more navigational facilities. If GPS is installed, or a pilot has a portable aviation GPS on board, it can be used to determine the position and the location of the nearest airport.

Communicate with any available facility using frequencies shown on the sectional chart. If contact is made with a controller, radar vectors may be offered. Other facilities may offer direction finding (DF) assistance. To use this procedure, the controller will request the pilot to hold down the transmit button for a few seconds and then release it. The controller may ask the pilot to change directions a few times and repeat the transmit procedure. This gives the controller enough information to plot the airplane position and then give vectors to a suitable landing site. If the situation becomes threatening, transmit the situation on the emergency frequency 121.5 MHz and set the transponder to 7700. Most facilities, and even airliners, monitor the emergency frequency.

## FLIGHT DIVERSION

There will probably come a time when a pilot will not be able to make it to the planned destination. This can be the result of unpredicted weather conditions, a system malfunction, or poor preflight planning. In any case, the pilot will need to be able to safely and efficiently divert to an alternate destination. Before any cross-country flight, check the charts for airports or suitable landing areas along or near the route of flight. Also, check for navigational aids that can be used during a diversion.

Computing course, time, speed, and distance information in flight requires the same computations used during preflight planning. However, because of the limited cockpit space, and because attention must be divided between flying the airplane, making calculations, and scanning for other airplanes, take advantage of all possible shortcuts and rule-of-thumb computations.

When in flight, it is rarely practical to actually plot a course on a sectional chart and mark checkpoints and distances. Furthermore, because an alternate airport is usually not very far from your original course, actual plotting is seldom necessary.

A course to an alternate can be measured accurately with a protractor or plotter, but can also be measured with reasonable accuracy using a straightedge and the compass rose depicted around VOR stations. This approximation can be made on the basis of a radial from a nearby VOR or an airway that closely parallels the course to your alternate. However, remember that the magnetic heading associated with a VOR radial or printed airway is outbound from the station. To find the course TO the station, it may be necessary to determine the reciprocal of that heading. It is typically easier to navigate to an alternate airport that has a VOR or NDB facility on the field.



After selecting the most appropriate alternate, approximate the magnetic course to the alternate using a compass rose or airway on the sectional chart. If time permits, try to start the diversion over a prominent ground feature. However, in an emergency, divert promptly toward your alternate. To complete all plotting, measuring, and computations involved before diverting to the alternate may only aggravate an actual emergency.

Once established on course, note the time, and then use the winds aloft nearest to your diversion point to calculate a heading and groundspeed. Once a groundspeed has been calculated, determine a new arrival time and fuel consumption. Give priority to flying the airplane while dividing attention between navigation and planning. When determining an altitude to use while diverting, consider cloud heights, winds, terrain, and radio reception.

# Chapter 15



## Aeromedical Factors

As a pilot, it is important to stay aware of the mental and physical standards required for the type of flying done. This chapter provides information on medical certification and on aeromedical factors related to flying activities.

### **OBTAINING A MEDICAL CERTIFICATE**

Most pilots must have a valid medical certificate to exercise the privileges of their airman certificates. Glider and free balloon pilots are not required to hold a medical certificate. Sport pilots may hold either a medical certificate or a valid state driver's license.

To acquire a medical certificate, an examination by an aviation medical examiner (AME), a physician with training in aviation medicine designated by the Civil Aerospace Medical Institute (CAMI), is required. There are three classes of medical certificates. The class of certificate needed depends on the type of flying the pilot plans to do.

A third-class medical is required for a private or recreational pilot certificate. It is valid for 3 years for those individuals who have not reached the age of 40; otherwise it is valid for 2 years. A commercial pilot certificate requires at least a second-class medical certificate, which is valid for 1 year. First-class medical certificates are required for airline transport pilots, and are valid for 6 months.

The standards are more rigorous for the higher classes of certificates. A pilot with a higher class

medical certificate has met the requirements for the lower classes as well. Since the class of medical required applies only when exercising the privileges of the pilot certificate for which it is required, a first-class medical would be valid for 1 year if exercising the privileges of a commercial certificate, and 2 or 3 years, as appropriate, for exercising the privileges of a private or recreational certificate. The same applies for a second-class medical certificate. The standards for medical certification are contained in Title 14 of the Code of Federal Regulations (14 CFR) part 67, and the requirements for obtaining medical certificates are in 14 CFR part 61.

Students who have physical limitations, such as impaired vision, loss of a limb, or hearing impairment may be issued a medical certificate valid for "student pilot privileges only" while they are learning to fly. Pilots with disabilities may require special equipment installed in the airplane, such as hand controls for pilots with paraplegia. Some disabilities necessitate a limitation on the individual's certificate; for example, impaired hearing would require the limitation "not valid for flight requiring the use of radio." When all the knowledge, experience, and proficiency requirements have been met and a student can demonstrate the ability to operate the airplane with the normal level of safety, a "statement of demonstrated ability" (SODA) can be issued. This waiver or SODA is valid as long as their physical impairment does not worsen. Contact the local Flight Standards District Office (FSDO) for more information on this subject.

## **ENVIRONMENTAL AND HEALTH FACTORS AFFECTING PILOT PERFORMANCE**

A number of health factors and physiological effects can be linked to flying. Some are minor, while others are important enough to require special attention to ensure safety of flight. In some cases, physiological factors can lead to in-flight emergencies. Some important medical factors that a pilot should be aware of include hypoxia, hyperventilation, middle ear and sinus problems, spatial disorientation, motion sickness, carbon monoxide poisoning, stress and fatigue, dehydration, and heatstroke. Other subjects include the effects of alcohol and drugs, anxiety, and excess nitrogen in the blood after scuba diving.

### **HYPOXIA**

Hypoxia means “reduced oxygen” or “not enough oxygen.” Although any tissue will die if deprived of oxygen long enough, usually the most concern is with getting enough oxygen to the brain, since it is particularly vulnerable to oxygen deprivation. Any reduction in mental function while flying can result in life-threatening errors. Hypoxia can be caused by several factors including an insufficient supply of oxygen, inadequate transportation of oxygen, or the inability of the body tissues to use oxygen. The forms of hypoxia are divided into four major groups based on their causes: hypoxic hypoxia, hypemic hypoxia, stagnant hypoxia, and histotoxic hypoxia.

### **HYPOXIC HYPOXIA**

Hypoxic hypoxia is a result of insufficient oxygen available to the lungs. A blocked airway or drowning are obvious examples of how the lungs can be deprived of oxygen, but the reduction in partial pressure of oxygen at high altitude is an appropriate example for pilots. Although the percentage of oxygen in the atmosphere is constant, its partial pressure decreases proportionately as atmospheric pressure decreases. As the airplane ascends during flight, the percentage of each gas in the atmosphere remains the same, but there are fewer molecules available at the pressure required for them to pass between the membranes in the respiratory system. This decrease of oxygen molecules at sufficient pressure can lead to hypoxic hypoxia.

### **HYPEMIC HYPOXIA**

This occurs when the blood is not able to take up and transport a sufficient amount of oxygen to the cells in the body. Hypemic means “not enough blood.” This type of hypoxia is a result of oxygen deficiency in the blood, rather than a lack of inhaled oxygen, and can be caused by a variety of factors. It may be because there is not enough blood volume (due to severe bleeding), or may result from certain blood diseases, such as anemia. More often it is because hemoglobin, the actual blood molecule that transports oxygen, is chemically

unable to bind oxygen molecules. The most common form of hypemic hypoxia is carbon monoxide poisoning. Hypemic hypoxia also can be caused by the loss of blood from a blood donation. Blood can take several weeks to return to normal following a donation. Although the effects of the blood loss are slight at ground level, there are risks when flying during this time.

### **STAGNANT HYPOXIA**

Stagnant means “not flowing,” and stagnant hypoxia results when the oxygen-rich blood in the lungs isn’t moving, for one reason or another, to the tissues that need it. An arm or leg going to sleep because the blood flow has accidentally been shut off is one form of stagnant hypoxia. This kind of hypoxia can also result from shock, the heart failing to pump blood effectively, or a constricted artery. During flight, stagnant hypoxia can occur when pulling excessive positive Gs. Cold temperatures also can reduce circulation and decrease the blood supplied to extremities.

### **HISTOTOXIC HYPOXIA**

The inability of the cells to effectively use oxygen is defined as histotoxic hypoxia. “Histo” refers to tissues or cells, and “toxic” means poison. In this case, plenty of oxygen is being transported to the cells that need it, but they are unable to make use of it. This impairment of cellular respiration can be caused by alcohol and other drugs, such as narcotics and poisons. Research has shown that drinking one ounce of alcohol can equate to about an additional 2,000 feet of physiological altitude.

### **SYMPTOMS OF HYPOXIA**

High-altitude flying can place a pilot in danger of becoming hypoxic. Oxygen starvation causes the brain and other vital organs to become impaired. One particularly noteworthy attribute of the onset of hypoxia is the fact that the first symptoms are euphoria and a carefree feeling. With increased oxygen starvation, the extremities become less responsive and flying becomes less coordinated. The symptoms of hypoxia vary with the individual, but common symptoms include:

- Cyanosis (blue fingernails and lips)
- Headache
- Decreased reaction time
- Impaired judgment
- Euphoria
- Visual impairment
- Drowsiness
- Lightheaded or dizzy sensation
- Tingling in fingers and toes
- Numbness

As hypoxia worsens, the field of vision begins to narrow, and instrument interpretation can become difficult. Even with all these symptoms, the effects of hypoxia can cause a pilot to have a false sense of security and be deceived into believing that everything is normal. The treatment for hypoxia includes flying at lower altitudes and/or using supplemental oxygen.

All pilots are susceptible to the effects of oxygen starvation, regardless of physical endurance or acclimatization. When flying at high altitudes, it is paramount that oxygen be used to avoid the effects of hypoxia. The term “time of useful consciousness” describes the maximum time the pilot has to make rational, life-saving decisions and carry them out at a given altitude without supplemental oxygen. As altitude increases above 10,000 feet, the symptoms of hypoxia increase in severity, and the time of useful consciousness rapidly decreases. [Figure 15-1]

Altitude	Time of Useful Consciousness
45,000 feet MSL	9 to 15 seconds
40,000 feet MSL	15 to 20 seconds
35,000 feet MSL	30 to 60 seconds
30,000 feet MSL	1 to 2 minutes
28,000 feet MSL	2 1/2 to 3 minutes
25,000 feet MSL	3 to 5 minutes
22,000 feet MSL	5 to 10 minutes
20,000 feet MSL	30 minutes or more

Figure 15-1. Time of useful consciousness.

Since symptoms of hypoxia can be different for each individual, the ability to recognize hypoxia can be greatly improved by experiencing and witnessing the effects of it during an altitude chamber “flight.” The Federal Aviation Administration (FAA) provides this opportunity through aviation physiology training, which is conducted at the FAA Civil Aerospace Medical Institute (CAMI) and at many military facilities across the United States. To attend the Physiological Training Program at CAMI, telephone (405) 954-4837 or write:

Mike Monroney Aeronautical Center  
 Airman Education Program  
 CAMI (AAM-400)  
 P.O. Box 25082  
 Oklahoma City, OK 73125

## HYPERVENTILATION

Hyperventilation occurs when an individual is experiencing emotional stress, fright, or pain, and the breathing rate and depth increase, although the carbon dioxide level in the blood is already at a reduced level. The result is an excessive loss of carbon dioxide from the body, which can lead to unconsciousness due to the respiratory system’s overriding mechanism to regain control of breathing.

Pilots encountering an unexpected stressful situation may unconsciously increase their breathing rate. If flying at higher altitudes, either with or without oxygen, a pilot may have a tendency to breathe more rapidly than normal, which often leads to hyperventilation.

Since many of the symptoms of hyperventilation are similar to those of hypoxia, it is important to correctly diagnose and treat the proper condition. If using supplemental oxygen, check the equipment and flow rate to ensure the symptoms are not hypoxia related. Common symptoms of hyperventilation include:

- Headache
- Decreased reaction time
- Impaired judgment
- Euphoria
- Visual impairment
- Drowsiness
- Lightheaded or dizzy sensation
- Tingling in fingers and toes
- Numbness
- Pale, clammy appearance
- Muscle spasms

Hyperventilation may produce a pale, clammy appearance and muscle spasms compared to the cyanosis and limp muscles associated with hypoxia. The treatment for hyperventilation involves restoring the proper carbon dioxide level in the body. Breathing normally is both the best prevention and the best cure for hyperventilation. In addition to slowing the breathing rate, breathing into a paper bag or talking aloud helps to overcome hyperventilation. Recovery is usually rapid once the breathing rate is returned to normal.

## MIDDLE EAR AND SINUS PROBLEMS

Climbs and descents can sometimes cause ear or sinus pain and a temporary reduction in the ability to hear. The physiological explanation for this discomfort is a difference between the pressure of the air outside the

body and that of the air inside the middle ear and nasal sinuses.

The middle ear is a small cavity located in the bone of the skull. It is closed off from the external ear canal by the eardrum. Normally, pressure differences between the middle ear and the outside world are equalized by a tube leading from inside each ear to the back of the throat on each side, called the eustachian tube. These tubes are usually closed, but open during chewing, yawning, or swallowing to equalize pressure. Even a slight difference between external pressure and middle ear pressure can cause discomfort. [Figure 15-2]

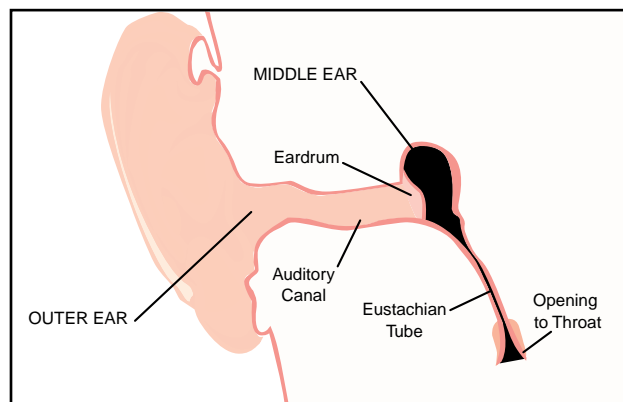

**Figure 15-2. The eustachian tube allows air pressure to equalize in the middle ear.**

During a climb, middle ear air pressure may exceed the pressure of the air in the external ear canal, causing the eardrum to bulge outward. Pilots become aware of this pressure change when they experience alternate sensations of “fullness” and “clearing.” During descent, the reverse happens. While the pressure of the air in the external ear canal increases, the middle ear cavity, which equalized with the lower pressure at altitude, is at lower pressure than the external ear canal. This results in the higher outside pressure, causing the eardrum to bulge inward.

This condition can be more difficult to relieve due to the fact that the partial vacuum tends to constrict the walls of the eustachian tube. To remedy this often painful condition, which also causes a temporary reduction in hearing sensitivity, pinch the nostrils shut, close the mouth and lips, and blow slowly and gently in the mouth and nose.

This procedure forces air through the eustachian tube into the middle ear. It may not be possible to equalize the pressure in the ears if a pilot has a cold, an ear infection, or sore throat. A flight in this condition can be extremely painful, as well as damaging to the eardrums. If experiencing minor congestion, nose drops or nasal sprays may reduce the chance of a painful ear blockage. Before using any medication,

check with an aviation medical examiner to ensure that it will not affect the ability to fly.

In a similar way, air pressure in the sinuses equalizes with the pressure in the cockpit through small openings that connect the sinuses to the nasal passages. An upper respiratory infection, such as a cold or sinusitis, or a nasal allergic condition can produce enough congestion around an opening to slow equalization. As the difference in pressure between the sinus and the cockpit increases, congestion may plug the opening. This “sinus block” occurs most frequently during descent. Slow descent rates can reduce the associated pain. A sinus block can occur in the frontal sinuses, located above each eyebrow, or in the maxillary sinuses, located in each upper cheek. It will usually produce excruciating pain over the sinus area. A maxillary sinus block can also make the upper teeth ache. Bloody mucus may discharge from the nasal passages.

Sinus block can be avoided by not flying with an upper respiratory infection or nasal allergic condition. Adequate protection is usually not provided by decongestant sprays or drops to reduce congestion around the sinus openings. Oral decongestants have side effects that can impair pilot performance. If a sinus block does not clear shortly after landing, a physician should be consulted.

## **SPATIAL DISORIENTATION AND ILLUSIONS**

Spatial disorientation specifically refers to the lack of orientation with regard to the position, attitude, or movement of the airplane in space. The body uses three integrated systems working together to ascertain orientation and movement in space. The eye is by far the largest source of information. Kinesthesia refers to the sensation of position, movement, and tension perceived through the nerves, muscles, and tendons. The vestibular system is a very sensitive motion sensing system located in the inner ears. It reports head position, orientation, and movement in three-dimensional space.

All this information comes together in the brain, and most of the time, the three streams of information agree, giving a clear idea of where and how the body is moving. Flying can sometimes cause these systems to supply conflicting information to the brain, which can lead to disorientation. During flight in visual meteorological conditions (VMC), the eyes are the major orientation source and usually prevail over false sensations from other sensory systems. When these visual cues are taken away, as they are in instrument meteorological conditions (IMC), false sensations can cause a pilot to quickly become disoriented.

The vestibular system in the inner ear allows the pilot to sense movement and determine orientation

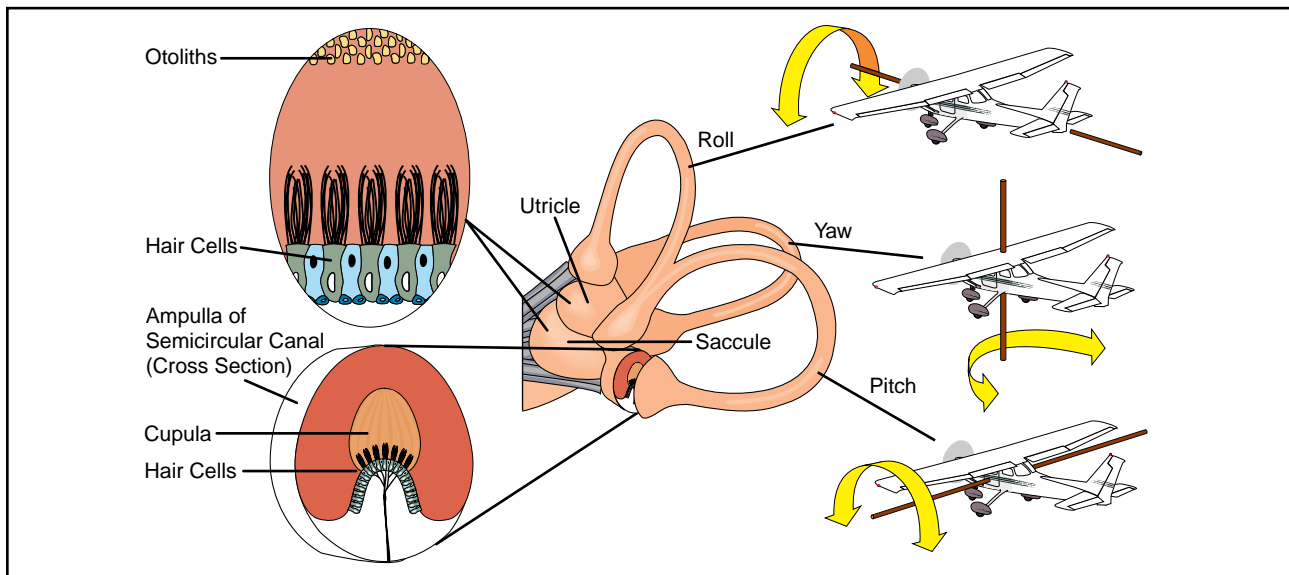

**Figure 15-3.** The semicircular canals lie in three planes, and sense motions of roll, pitch, and yaw.

in the surrounding environment. In both the left and right inner ear, three semicircular canals are positioned at approximate right angles to each other. Each canal is filled with fluid and has a section full of fine hairs. Acceleration of the inner ear in any direction causes the tiny hairs to deflect, which in turn stimulates nerve impulses, sending messages to the brain. The vestibular nerve transmits the impulses from the utricle, saccule, and semicircular canals to the brain to interpret motion. [Figure 15-3]

The postural system sends signals from the skin, joints, and muscles to the brain that are interpreted in relation to the earth's gravitational pull. These signals determine posture. Inputs from each movement update the body's position to the brain on a constant basis. "Seat of the pants" flying is largely dependent upon these signals. Used in conjunction with visual and vestibular clues, these sensations can be fairly reliable. However, the body cannot distinguish between acceleration forces due to gravity and those resulting from maneuvering the aircraft, which can lead to sensory illusions and false impressions of the airplane's orientation and movement.

Under normal flight conditions, when there is a visual reference to the horizon and ground, the sensory system in the inner ear helps to identify the pitch, roll, and yaw movements of the airplane. When visual contact with the horizon is lost, the vestibular system becomes unreliable. Without visual references outside the airplane, there are many situations where combinations of normal motions and forces can create convincing illusions that are difficult to overcome. In a classic example, a pilot may believe the airplane is in level flight, when, in reality, it is in a gradual turn. If the airspeed increases, the pilot may experience a postural sensation of a level dive and

pull back on the stick, which tightens the turn and creates increasing G-loads. If recovery is not initiated, a steep spiral will develop. This is sometimes called the graveyard spiral, because if the pilot fails to recognize that the airplane is in a spiral and fails to return the airplane to wings-level flight, the airplane will eventually strike the ground. If the horizon becomes visible again, the pilot will have an opportunity to return the airplane to straight-and-level flight, and continued visual contact with the horizon will allow the pilot to maintain straight-and-level flight. However, if contact with the horizon is lost again, the inner ear may fool the pilot into thinking the airplane has started a bank in the other direction, causing the graveyard spiral to begin all over again.

Prevention is usually the best remedy for spatial disorientation. Unless a pilot has many hours of training in instrument flight, flight in reduced visibility or at night when the horizon is not visible should be avoided. A pilot can reduce susceptibility to disorienting illusions through training and awareness, and learning to rely totally on flight instruments.

Besides the sensory illusions due to misleading inputs to the vestibular system, a pilot may also encounter various visual illusions during flight. Illusions rank among the most common factors cited as contributing to fatal airplane accidents.

Sloping cloud formations, an obscured horizon, a dark scene spread with ground lights and stars, and certain geometric patterns of ground light can create illusions of not being aligned correctly with the actual horizon. Various surface features and atmospheric conditions encountered in landing can create illusions of being on the wrong approach path. Landing errors from these illusions can be prevented by anticipating them

during approaches, inspecting unfamiliar airports before landing, using electronic glide slope or VASI systems when available, and maintaining proficiency in landing procedures.

A narrower-than-usual runway can create the illusion that the airplane is higher than it actually is, while a wider-than-usual runway can have the opposite effect, causing the pilot to flare too high or overshoot the runway. [Figure 15-4]

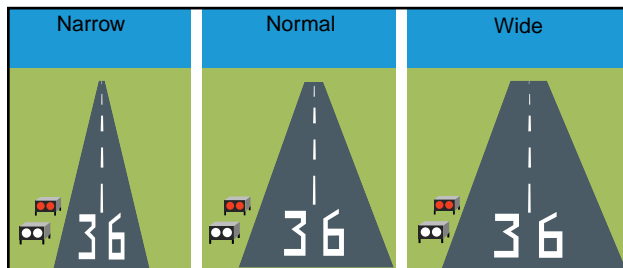

Figure 15-4. Runway Illusions.

A runway that slopes up, or upsloping terrain, can create the illusion that the airplane is at a higher altitude than it actually is, and downsloping runways or terrain can create the opposite effect. Rain on the windshield can create the illusion of greater height, and haze can make distances appear greater than they are.

At sunrise or sunset, a pilot may encounter flicker vertigo. In some individuals, flashing lights at certain frequencies can trigger seizures, nausea, convulsions, or unconsciousness. Seeing the sun through a slow-moving propeller can produce the effect of a flashing light. So can bright light reflecting off the back of the propeller. Symptoms are rare, but be aware of the possibility.

## MOTION SICKNESS

Motion sickness, or airsickness, is caused by the brain receiving conflicting messages about the state of the body. A pilot may experience motion sickness during initial flights, but it generally goes away within the first few lessons. Anxiety and stress, which may be experienced at the beginning of flight training, can contribute to motion sickness. Symptoms of motion sickness include general discomfort, nausea, dizziness, paleness, sweating, and vomiting.

It is important to remember that experiencing airsickness is no reflection on one's ability as a pilot. If prone to motion sickness, let the flight instructor know since there are techniques that can be used to overcome this problem. For example, avoid lessons in turbulent conditions until becoming more comfortable in the airplane, or start with shorter flights and graduate to longer instruction periods. If symptoms of motion sickness are experienced during a lesson,

opening fresh air vents, focusing on objects outside the airplane, and avoiding unnecessary head movements may help alleviate some of the discomfort. Although medications like Dramamine can prevent airsickness in passengers, they are not recommended while flying since they can cause drowsiness and other problems.

## CARBON MONOXIDE POISONING

Carbon monoxide (CO) is a colorless and odorless gas produced by all internal combustion engines. Since it attaches itself to the hemoglobin in the blood about 200 times more easily than oxygen, carbon monoxide prevents the hemoglobin from carrying oxygen to the cells, resulting in hypemic hypoxia. It can take up to 48 hours for the body to dispose of carbon monoxide. If the poisoning is severe enough, it can result in death. Aircraft heater vents and defrost vents may provide carbon monoxide a passageway into the cabin, particularly if the engine exhaust system has a leak or is damaged. If a strong odor of exhaust gases is detected, assume that carbon monoxide is present. However, carbon monoxide may be present in dangerous amounts even if no exhaust odor is detected. Disposable, inexpensive carbon monoxide detectors are widely available. In the presence of carbon monoxide, these detectors change color to alert the pilot of the presence of carbon monoxide. Some effects of carbon monoxide poisoning include headache, blurred vision, dizziness, drowsiness, and/or loss of muscle power. Anytime a pilot smells exhaust odor, or any time that these symptoms are experienced, immediate corrective actions should be taken. These include turning off the heater, opening fresh air vents and windows, and using supplemental oxygen, if available.

Tobacco smoke also causes carbon monoxide poisoning. Smoking at sea level can raise the CO concentration in the blood and result in physiological effects similar to flying at 8,000 feet. Besides hypoxia, tobacco causes diseases and physiological debilitation that are medically disqualifying for pilots.

## STRESS

Stress is defined as the body's response to physical and psychological demands placed upon it. The body's reaction to stress includes releasing chemical hormones (such as adrenaline) into the blood, and increasing metabolism to provide more energy to the muscles. The blood sugar, heart rate, respiration, blood pressure, and perspiration all increase. The term "stressor" is used to describe an element that causes an individual to experience stress. Examples of stressors include physical stress (noise or vibration), physiological stress (fatigue), and psychological stress (difficult work or personal situations).

Stress falls into two broad categories, including acute stress (short term) and chronic stress (long term). Acute

stress involves an immediate threat that is perceived as danger. This is the type of stress that triggers a “fight or flight” response in an individual, whether the threat is real or imagined. Normally, a healthy person can cope with acute stress and prevent stress overload. However, on-going acute stress can develop into chronic stress.

Chronic stress can be defined as a level of stress that presents an intolerable burden, exceeds the ability of an individual to cope, and causes individual performance to fall sharply. Unrelenting psychological pressures, such as loneliness, financial worries, and relationship or work problems can produce a cumulative level of stress that exceeds a person’s ability to cope with the situation. When stress reaches these levels, performance falls off rapidly. Pilots experiencing this level of stress are not safe and should not exercise their airman privileges. Pilots who suspect they are suffering from chronic stress should consult a physician.

## FATIGUE

Fatigue is frequently associated with pilot error. Some of the effects of fatigue include degradation of attention and concentration, impaired coordination, and decreased ability to communicate. These factors can seriously influence the ability to make effective decisions. Physical fatigue can result from sleep loss, exercise, or physical work. Factors such as stress and prolonged performance of cognitive work can result in mental fatigue.

Like stress, fatigue also falls into two broad categories: acute and chronic. Acute fatigue is short term and is a normal occurrence in everyday living. It is the kind of tiredness people feel after a period of strenuous effort, excitement, or lack of sleep. Rest after exertion and 8 hours of sound sleep ordinarily cures this condition.

A special type of acute fatigue is skill fatigue. This type of fatigue has two main effects on performance:

- **Timing disruption**—Appearing to perform a task as usual, but the timing of each component is slightly off. This makes the pattern of the operation less smooth, because the pilot performs each component as though it were separate, instead of part of an integrated activity.
- **Disruption of the perceptual field**—Concentrating attention upon movements or objects in the center of vision and neglecting those in the periphery. This may be accompanied by loss of accuracy and smoothness in control movements.

Acute fatigue has many causes, but the following are among the most important for the pilot:

- Mild hypoxia (oxygen deficiency)
- Physical stress

- Psychological stress
- Depletion of physical energy resulting from psychological stress

Sustained psychological stress accelerates the glandular secretions that prepare the body for quick reactions during an emergency. These secretions make the circulatory and respiratory systems work harder, and the liver releases energy to provide the extra fuel needed for brain and muscle work. When this reserve energy supply is depleted, the body lapses into generalized and severe fatigue.

Acute fatigue can be prevented by a proper diet and adequate rest and sleep. A well-balanced diet prevents the body from having to consume its own tissues as an energy source. Adequate rest maintains the body’s store of vital energy.

Chronic fatigue, extending over a long period of time, usually has psychological roots, although an underlying disease is sometimes responsible. Continuous high stress levels, for example, can produce chronic fatigue. Chronic fatigue is not relieved by proper diet and adequate rest and sleep, and usually requires treatment by a physician. An individual may experience this condition in the form of weakness, tiredness, palpitations of the heart, breathlessness, headaches, or irritability. Sometimes chronic fatigue even creates stomach or intestinal problems and generalized aches and pains throughout the body. When the condition becomes serious enough, it can lead to emotional illness.

If suffering from acute fatigue, stay on the ground. If fatigue occurs in the cockpit, no amount of training or experience can overcome the detrimental effects. Getting adequate rest is the only way to prevent fatigue from occurring. Avoid flying without a full night’s rest, after working excessive hours, or after an especially exhausting or stressful day. Pilots who suspect they are suffering from chronic fatigue should consult a physician.

## DEHYDRATION AND HEATSTROKE

Dehydration is the term given to a critical loss of water from the body. The first noticeable effect of dehydration is fatigue, which in turn makes top physical and mental performance difficult, if not impossible. As a pilot, flying for long periods in hot summer temperatures or at high altitudes increases the susceptibility of dehydration since the dry air at altitude tends to increase the rate of water loss from the body. If this fluid is not replaced, fatigue progresses to dizziness, weakness, nausea, tingling of hands and feet, abdominal cramps, and extreme thirst.



Heatstroke is a condition caused by any inability of the body to control its temperature. Onset of this condition may be recognized by the symptoms of dehydration, but also has been known to be recognized only by complete collapse.

To prevent these symptoms, it is recommended that an ample supply of water be carried and used at frequent intervals on any long flight, whether thirsty or not. If the airplane has a canopy or roof window, wearing light-colored, porous clothing and a hat will help provide protection from the sun. Keeping the cockpit well ventilated aids in dissipating excess heat.

## ALCOHOL

Alcohol impairs the efficiency of the human mechanism. Studies have positively proven that drinking and performance deterioration are closely linked. Pilots must make hundreds of decisions, some of them time-critical, during the course of a flight. The safe outcome of any flight depends on the ability to make the correct decisions and take the appropriate actions during routine occurrences, as well as abnormal situations. The influence of alcohol drastically reduces the chances of completing a flight without incident. Even in small amounts, alcohol can impair judgment, decrease sense of responsibility, affect coordination, constrict visual field, diminish memory, reduce reasoning power, and lower attention span. As little as one ounce of alcohol can decrease the speed and strength of muscular reflexes, lessen the efficiency of eye movements while reading, and increase the frequency at which errors are committed. Impairments in vision and hearing occur at alcohol blood levels as low as .01 percent.

The alcohol consumed in beer and mixed drinks is ethyl alcohol, a central nervous system depressant. From a medical point of view, it acts on the body much like a general anesthetic. The "dose" is generally much lower and more slowly consumed in the case of alcohol, but the basic effects on the system are similar. Alcohol is easily and quickly absorbed by the digestive tract. The bloodstream absorbs about 80 to 90 percent of the alcohol in a drink within 30 minutes on an empty stomach. The body requires about 3 hours to rid itself of all the alcohol contained in *one* mixed drink or *one* beer.

With a hangover, a pilot is still under the influence of alcohol. Although a pilot may think that he or she is functioning normally, the impairment of motor and mental responses still remains. Considerable amounts of alcohol can remain in the body for over 16 hours, so pilots should be cautious about flying too soon after drinking.

Altitude multiplies the effects of alcohol on the brain. When combined with altitude, the alcohol from two

drinks may have the same effect as three or four drinks. Alcohol interferes with the brain's ability to utilize oxygen, producing a form of histotoxic hypoxia. The effects are rapid because alcohol passes so quickly into the bloodstream. In addition, the brain is a highly vascular organ that is immediately sensitive to changes in the blood's composition. For a pilot, the lower oxygen availability at altitude, along with the lower capability of the brain to use what oxygen *is* there, adds up to a deadly combination.

Intoxication is determined by the amount of alcohol in the bloodstream. This is usually measured as a percentage by weight in the blood. 14 CFR part 91 requires that blood alcohol level be less than .04 percent and that 8 hours pass between drinking alcohol and piloting an airplane. A pilot with a blood alcohol level of .04 percent or greater after 8 hours cannot fly until the blood alcohol falls below that amount. Even though blood alcohol may be well below .04 percent, a pilot cannot fly sooner than 8 hours after drinking alcohol. Although the regulations are quite specific, it is a good idea to be more conservative than the regulations.

## DRUGS

Pilot performance can be seriously degraded by both prescribed and over-the-counter medications, as well as by the medical conditions for which they are taken. Many medications, such as tranquilizers, sedatives, strong pain relievers, and cough-suppressants have primary effects that may impair judgment, memory, alertness, coordination, vision, and the ability to make calculations. Others, such as antihistamines, blood pressure drugs, muscle relaxants, and agents to control diarrhea and motion sickness have side effects that may impair the same critical functions. Any medication that depresses the nervous system, such as a sedative, tranquilizer, or antihistamine can make a pilot more susceptible to hypoxia.

Pain-killers can be grouped into two broad categories: analgesics and anesthetics. Analgesics are drugs that reduce pain, while anesthetics are drugs that deaden pain or cause loss of consciousness.

Over-the-counter analgesics, such as acetylsalicylic acid (Aspirin), acetaminophen (Tylenol), and ibuprofen (Advil) have few side effects when taken in the correct dosage. Although some people are allergic to certain analgesics or may suffer from stomach irritation, flying usually is not restricted when taking these drugs. However, flying is almost always precluded while using prescription analgesics, such as Darvon, Percodan, Demerol, and codeine since these drugs may cause side effects such as mental confusion, dizziness, headaches, nausea, and vision problems.

Anesthetic drugs are commonly used for dental and surgical procedures. Most local anesthetics used for minor dental and outpatient procedures wear off within a relatively short period of time. The anesthetic itself may not limit flying so much as the actual procedure and subsequent pain.

Stimulants are drugs that excite the central nervous system and produce an increase in alertness and activity. Amphetamines, caffeine, and nicotine are all forms of stimulants. Common uses of these drugs include appetite suppression, fatigue reduction, and mood elevation. Some of these drugs may cause a stimulant reaction, even though this reaction is not their primary function. In some cases, stimulants can produce anxiety and mood swings, both of which are dangerous when flying.

Depressants are drugs that reduce the body's functioning in many areas. These drugs lower blood pressure, reduce mental processing, and slow motor and reaction responses. There are several types of drugs that can cause a depressing effect on the body, including tranquilizers, motion sickness medication, some types of stomach medication, decongestants, and antihistamines. The most common depressant is alcohol.

Some drugs, which can neither be classified as stimulants nor depressants, have adverse effects on flying. For example, some forms of antibiotics can produce dangerous side effects, such as balance disorders, hearing loss, nausea, and vomiting. While many antibiotics are safe for use while flying, the infection requiring the antibiotic may prohibit flying. In addition, unless specifically prescribed by a physician, do not take more than one drug at a time, and never mix drugs with alcohol, because the effects are often unpredictable.

The dangers of illegal drugs also are well documented. Certain illegal drugs can have hallucinatory effects that occur days or weeks after the drug is taken. Obviously, these drugs have no place in the aviation community.

The Code of Federal Regulations prohibits pilots from performing crewmember duties while using any medication that affects the faculties in any way contrary to safety. The safest rule is not to fly as a crewmember while taking any medication, unless approved to do so by the FAA. If there is any doubt regarding the effects of any medication, consult an aviation medical examiner before flying.

## SCUBA DIVING

Scuba diving subjects the body to increased pressure, which allows more nitrogen to dissolve in body tissues and fluids. The reduction of atmospheric pressure that

accompanies flying can produce physical problems for scuba divers. Reducing the pressure too quickly allows small bubbles of nitrogen to form inside the body as the gas comes out of solution. These bubbles can cause a painful and potentially incapacitating condition called "the bends." (An example is dissolved gas forming bubbles as pressure decreases by slowly opening a transparent bottle of soda.) Scuba training emphasizes how to prevent the bends when rising to the surface, but increased nitrogen concentrations can remain in tissue fluids for several hours after a diver leaves the water. The bends can be experienced from as low as 8,000 feet MSL, with increasing severity as altitude increases. As noted in the *Aeronautical Information Manual* (AIM), the minimum recommended time between scuba diving on nondecompression stop dives and flying is 12 hours, while the minimum time recommended between decompression stop diving and flying is 24 hours. [Figure 15-5]

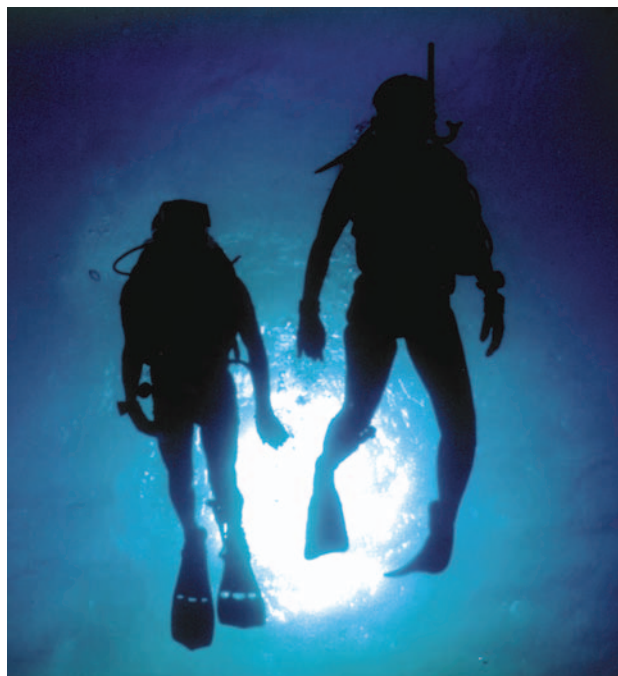

**Figure 15-5. Scuba divers must not fly for specific time periods following dives to avoid the bends.**

## VISION IN FLIGHT

Of all the senses, vision is the most important for safe flight. Most of the things perceived while flying are visual or heavily supplemented by vision. As remarkable and vital as it is, vision is subject to some limitations, such as illusions and blind spots. The more a pilot understands about the eyes and how they function, the easier it is to use vision effectively and compensate for potential problems.

The eye functions much like a camera. Its structure includes an aperture, a lens, a mechanism for focusing, and a surface for registering images. Light enters

through the cornea at the front of the eyeball, travels through the lens and falls on the retina. The retina contains light sensitive cells that convert light energy into electrical impulses that travel through nerves to the brain. The brain interprets the electrical signals to form images. There are two kinds of light sensitive cells in the eyes: rods and cones. [Figure 15-6]

The cones are responsible for all color vision, from appreciating a glorious sunset to discerning the subtle shades in a fine painting. Cones are present throughout the retina, but are concentrated toward the center of the field of vision at the back of the retina. There is a small pit called the fovea where almost all the light sensing cells are cones. This is the area where most “looking” occurs (the center of the visual field where detail, color sensitivity, and resolution are highest).

While the cones and their associated nerves are well suited to detecting fine detail and color in high light levels, the rods are better able to detect movement and provide vision in dim light. The rods are unable to discern color but are very sensitive in low light levels. The trouble with rods is that a large amount of light overwhelms them, and they take a long time to “reset” and adapt to the dark again. There are so many cones in the fovea that the very center of the visual field hardly has any rods at all. So in low light, the middle of the visual field isn’t very sensitive, but farther from the fovea, the rods are more numerous and provide the major portion of night vision.

The area where the optic nerve enters the eyeball has no rods or cones, leaving a blind spot in the field of vision. Normally, each eye compensates for the other’s blind spot. Figure 15-7 provides a dramatic example of the eye’s blind spot. Cover the right eye and hold this

page at arm’s length. Focus the left eye on the X in the right side of the windshield and notice what happens to the airplane while slowly bringing the page closer to the eye.

### EMPTY-FIELD MYOPIA

Another problem associated with flying at night, in instrument meteorological conditions and/or reduced visibility is empty-field myopia, or induced nearsightedness. With nothing to focus on, the eyes automatically focus on a point just slightly ahead of the airplane. Searching out and focusing on distant light sources, no matter how dim, helps prevent the onset of empty-field myopia.

### NIGHT VISION

It is estimated that once fully adapted to darkness, the rods are 10,000 times more sensitive to light than the cones, making them the primary receptors for night vision. Since the cones are concentrated near the fovea, the rods are also responsible for much of the peripheral vision. The concentration of cones in the fovea can make a night blind spot in the center of the field of vision. To see an object clearly at night, the pilot must expose the rods to the image. This can be done by looking 5° to 10° off center of the object to be seen. This can be tried in a

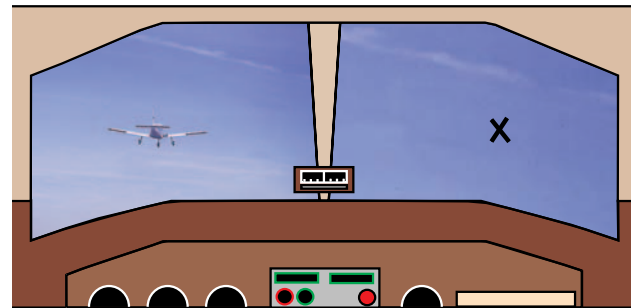

Figure 15-7. The eye's blind spot.

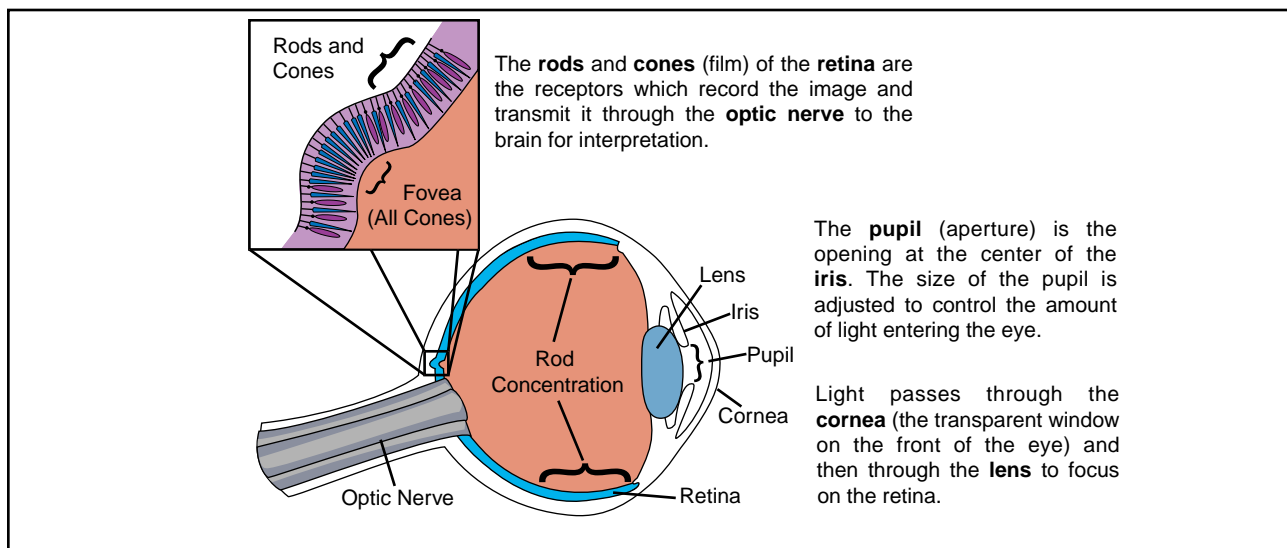

Figure 15-6. The eye.

dim light in a darkened room. When looking directly at the light, it dims or disappears altogether. When looking slightly off center, it becomes clearer and brighter.

Refer to figure 15-8. When looking directly at an object, the image is focused mainly on the fovea, where detail is best seen. At night, the ability to see an object in the center of the visual field is reduced as the cones lose much of their visual acuity and the rods become more sensitive. Looking off center can help compensate for this night blind spot. Along with the loss of sharpness and color at night, depth perception and judgment of size may be lost.

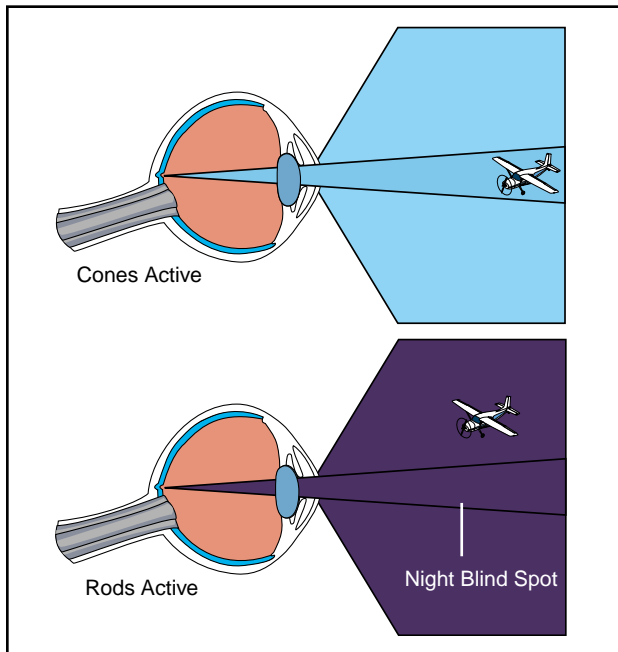

Figure 15-8. Night blind spot.

While the cones adapt rapidly to changes in light intensities, the rods take much longer. Walking from bright sunlight into a dark movie theater is an example of this dark adaptation period experience. The rods can take approximately 30 minutes to fully adapt to the dark. A bright light, however, can completely destroy night adaptation, leaving night vision severely compromised while the adaptation process is repeated.

Several things can be done to keep the eyes adapted to the dark. The first is obvious: avoid bright lights before and during the flight. For 30 minutes before a night flight, avoid any bright light sources, such as headlights, landing lights, strobe lights, or flashlights. If a bright light is encountered, close one eye to keep it light sensitive. This allows the use of that eye to see again once the light is gone.

Red cockpit lighting also helps preserve night vision, but red light severely distorts some colors and completely washes out the color red. This makes reading an aeronautical chart difficult. A dim white light or a carefully

directed flashlight can enhance night reading ability. While flying at night, keep the instrument panel and interior lights turned up no higher than necessary. This helps to see outside references more easily. If the eyes become blurry, blinking more frequently often helps.

Diet and general physical health have an impact on how well a pilot can see in the dark. Deficiencies in vitamins A and C have been shown to reduce night acuity. Other factors, such as carbon monoxide poisoning, smoking, alcohol, certain drugs, and a lack of oxygen also can greatly decrease night vision.

## NIGHT VISUAL ILLUSIONS

There are many different types of visual illusions that commonly occur at night. Anticipating and staying aware of them is usually the best way to avoid them.

### AUTOKINESIS

Autokinesis is caused by staring at a single point of light against a dark background for more than a few seconds. After a few moments, the light appears to move on its own. To prevent this illusion, focus the eyes on objects at varying distances and avoid fixating on one target. Be sure to maintain a normal scan pattern.

### FALSE HORIZON

A false horizon can occur when the natural horizon is obscured or not readily apparent. It can be generated by confusing bright stars and city lights. It can also occur while flying toward the shore of an ocean or a large lake. Because of the relative darkness of the water, the lights along the shoreline can be mistaken for stars in the sky. [Figure 15-9]

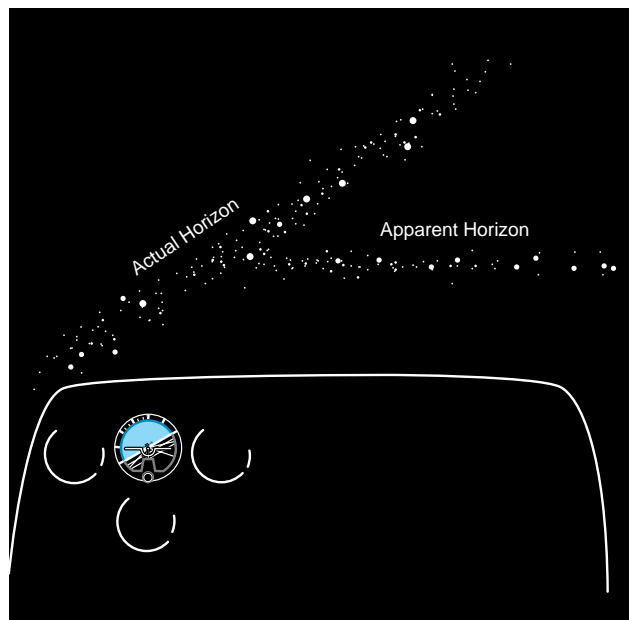

Figure 15-9. At night, the horizon may be hard to discern due to dark terrain and misleading light patterns on the ground.

## **NIGHT LANDING ILLUSIONS**

Landing illusions occur in many forms. Above featureless terrain at night, there is a natural tendency to fly a lower-than-normal approach. Elements that cause any type of visual obscuration, such as rain, haze, or a dark runway environment also can cause low approaches. Bright lights, steep surrounding terrain, and a wide runway can produce the illusion of being too low, with a

tendency to fly a higher-than-normal approach. Often a set of regularly spaced lights along a road or highway can appear to be runway lights. Pilots have even mistaken the lights on moving trains as runway or approach lights. Bright runway or approach lighting systems can create the illusion that the airplane is closer to the runway, especially where few lights illuminate the surrounding terrain.

## Chapter 16

# Aeronautical Decision Making

Aeronautical decision making (ADM) is a systematic approach to the mental process used by airplane pilots to consistently determine the best course of action in response to a given set of circumstances. The importance of learning effective ADM skills cannot be overemphasized. While progress is continually being made in the advancement of pilot training methods, airplane equipment and systems, and services for pilots, accidents still occur. Despite all the changes in technology to improve flight safety, one factor remains the same—the human factor. It is estimated that approximately 75 percent of all aviation accidents are **human factors** related.

Historically, the term “pilot error” has been used to describe the causes of these accidents. Pilot error means that an action or decision made by the pilot was the cause, or a contributing factor that led to the accident. This definition also includes the pilot’s failure to make a decision or take action. From a broader perspective, the phrase “human factors related” more aptly describes these accidents since it is usually not a single decision that leads to an accident, but a chain of events triggered by a number of factors.

The poor judgment chain, sometimes referred to as the “error chain,” is a term used to describe this concept of contributing factors in a human factors-related acci-

**Human Factors**—The study of how people interact with their environments. In the case of general aviation, it is the study of how pilot performance is influenced by such issues as the design of cockpits, the function of the organs of the body, the effects of emotions, and the interaction and communication with the other participants of the aviation community, such as other crewmembers and air traffic control personnel.

dent. Breaking one link in the chain normally is all that is necessary to change the outcome of the sequence of events. The following is an example illustrating the poor judgment chain.

*A private pilot with around 350 hours was ferrying an airplane cross-country to a new owner. Due to time constraints, the pilot skipped dinner the night before and had no breakfast on the morning of the flight. The pilot planned to have lunch around noon at a fuel stop.*

*A descent was begun from 9,500 feet, about 20 miles from the chosen fuel stop, due to haze and unfamiliarity with the area. When the airplane arrived at pattern altitude, the pilot could not find the airport. The pilot then circled north of the town, then back over the town, then flew to the west, then turned back to the east.*

*The pilot decided to check for airport information in the Airport/Facility Directory, which was on the rear seat and not readily available.*

*Power had not been increased since the descent to pattern altitude, and the pilot had been holding back pressure on the yoke. While attempting to retrieve the Airport/Facility Directory, a loud “bang” was heard. Looking up, the pilot discovered the airplane was only about 200 feet above ground level. Increasing power, the pilot climbed and located the airport. After landing, it was discovered a fiberglass antenna had been hit, which damaged the leading edge of the left wing.*

By discussing the events that led to this accident, it can be understood how a series of judgmental errors

contributed to the final outcome of this flight. For example, one of the first elements that affected the pilot's flight was fatigue. The pilot understood that fatigue and hunger could affect the ability to fly safely, but let the desire to stay on schedule override the concern for a safe flight.

Next, the rush to get airborne led the pilot to skip or postpone necessary aspects of preflight planning. Research before takeoff, with a quick review before descent, could have ensured a clear mental picture of the location of the airport in relation to the town. Copying relevant information from flight guides and other information sources is part of careful preflight planning. Studying the aeronautical charts and checking the Notices to Airmen (NOTAM) beforehand would have alerted the pilot to towers, terrain, and other obstructions in the vicinity of the airport.

Even without proper planning before the flight, good cockpit resource management and organization would have had the flight guide and any other necessary information near at hand, perhaps with the relevant pages flagged. Approaching the airport environment and flying around the area at traffic pattern altitude in hazy conditions could have interfered with other air traffic, and the potential for a midair collision is obvious.

In all circumstances, the pilot's first duty is to fly the airplane. Clearly that would include adjusting the power, setting the trim, and keeping track of altitude. This pilot was extremely fortunate—the outcome could easily have been fatal.

On numerous occasions during the flight, the pilot could have made effective decisions that would have broken the chain of error and prevented this accident. Making sound decisions is the key to preventing accidents. Traditional pilot training has emphasized flying skills, knowledge of the airplane, and familiarity with regulations. ADM training focuses on the decision-making process and the factors that affect a pilot's ability to make effective choices.

## ORIGINS OF ADM TRAINING

The airlines developed some of the first training programs that focused on improving aeronautical decision making. Human factors-related accidents motivated the airline industry to implement crew resource management (CRM) training for flight crews. The focus of CRM programs is the effective use of all available resources; human resources, hardware, and information. Human resources include all groups routinely working with the cockpit crew (or pilot) who are involved in decisions that are required to operate a flight safely. These groups include, but are not limited to: dispatchers, cabin crewmembers, maintenance personnel, and

air traffic controllers. Although the CRM concept originated as airlines developed ways of facilitating crew cooperation to improve decision making in the cockpit, CRM principles, such as workload management, situational awareness, communication, the leadership role of the captain, and crewmember coordination have direct application to the general aviation cockpit. This also includes single pilot operations since pilots of small airplanes, as well as crews of larger airplanes, must make effective use of all available resources—human resources, hardware, and information. AC 60-22, *Aeronautical Decision Making*, provides background references, definitions, and other pertinent information about ADM training in the general aviation environment. [Figure 16-1]

## THE DECISION-MAKING PROCESS

An understanding of the decision-making process provides a pilot with a foundation for developing ADM skills. Some situations, such as engine failures, require a pilot to respond immediately using established procedures with little time for detailed analysis. Traditionally, pilots have been well trained to react to emergencies, but are not as well prepared to make decisions requiring a more reflective response. Typically during a flight, there is time to examine any changes that occur, gather information, and assess risk before reaching a decision. The steps leading to this conclusion constitute the decision-making process.

## DEFINING THE PROBLEM

Problem definition is the first step in the decision-making process. Defining the problem begins with recognizing that a change has occurred or that an expected change did not occur. A problem is perceived first by the senses, then is distinguished through insight and experience. These same abilities, as well as an objective analysis of all available information, are used to determine the exact nature and severity of the problem.

One critical error that can be made during the decision-making process is incorrectly defining the problem. For example, a low oil pressure reading could indicate that the engine is about to fail and an emergency landing should be planned, or it could mean that the oil pressure sensor has failed. The actions to be taken in each of these circumstances would be significantly different. Fixating on a problem that does not exist can divert attention from important tasks. The pilot's failure to maintain an awareness of the circumstances regarding the flight now becomes the problem. This is why once an initial assumption is made regarding the problem, other sources must be used to verify that the conclusion is correct.

## DEFINITIONS

**AERONAUTICAL DECISION MAKING (ADM)** is a systematic approach to the mental process used by pilots to consistently determine the best course of action in response to a given set of circumstances.

**ATTITUDE** is a personal motivational predisposition to respond to persons, situations, or events in a given manner that can, nevertheless, be changed or modified through training as sort of a mental shortcut to decision making.

**ATTITUDE MANAGEMENT** is the ability to recognize hazardous attitudes in oneself and the willingness to modify them as necessary through the application of an appropriate antidote thought.

**CREW RESOURCE MANAGEMENT (CRM)** is the application of team management concepts in the flight deck environment. It was initially known as cockpit resource management, but as CRM programs evolved to include cabin crews, maintenance personnel, and others, the phrase crew resource management was adopted. This includes single pilots, as in most general aviation aircraft. Pilots of small aircraft, as well as crews of larger aircraft, must make effective use of all available resources; human resources, hardware, and information. A current definition includes all groups routinely working with the cockpit crew who are involved in decisions required to operate a flight safely. These groups include, but are not limited to: pilots, dispatchers, cabin crewmembers, maintenance personnel, and air traffic controllers. CRM is one way of addressing the challenge of optimizing the human/machine interface and accompanying interpersonal activities.

**HEADWORK** is required to accomplish a conscious, rational thought process when making decisions. Good decision making involves risk identification and assessment, information processing, and problem solving.

**JUDGMENT** is the mental process of recognizing and analyzing all pertinent information in a particular situation, a rational evaluation of alternative actions in response to it, and a timely decision on which action to take.

**PERSONALITY** is the embodiment of personal traits and characteristics of an individual that are set at a very early age and extremely resistant to change.

**POOR JUDGMENT CHAIN** is a series of mistakes that may lead to an accident or incident. Two basic principles generally associated with the creation of a poor judgment chain are: (1) One bad decision often leads to another; and (2) as a string of bad decisions grows, it reduces the number of subsequent alternatives for continued safe flight. ADM is intended to break the poor judgment chain before it can cause an accident or incident.

**RISK ELEMENTS IN ADM** take into consideration the four fundamental risk elements: the pilot, the aircraft, the environment, and the type of operation that comprise any given aviation situation.

**RISK MANAGEMENT** is the part of the decision making process which relies on situational awareness, problem recognition, and good judgment to reduce risks associated with each flight.

**SITUATIONAL AWARENESS** is the accurate perception and understanding of all the factors and conditions within the four fundamental risk elements that affect safety before, during, and after the flight.

**SKILLS and PROCEDURES** are the procedural, psychomotor, and perceptual skills used to control a specific aircraft or its systems. They are the airmanship abilities that are gained through conventional training, are perfected, and become almost automatic through experience.

**STRESS MANAGEMENT** is the personal analysis of the kinds of stress experienced while flying, the application of appropriate stress assessment tools, and other coping mechanisms.

Figure 16-1. These terms are used in AC 60-22 to explain concepts used in ADM training.

*While on a cross-country flight, a pilot discovered that fuel consumption was significantly higher than predicted during flight planning. By noticing this discrepancy, change has been recognized. Based on insight, cross-country flying experience, and knowledge of airplane systems, the pilot considers the possibility that there might be enough fuel to reach the destination. Factors that may increase the fuel burn rate could include environmental factors, such as higher-than-expected headwinds and lower-than-expected groundspeed. To determine the severity of the problem, recalculate the fuel consumption and reassess fuel requirements.*

### CHOOSING A COURSE OF ACTION

After the problem has been identified, the pilot must evaluate the need to react to it and determine the actions that may be taken to resolve the situation in the

time available. The expected outcome of each possible action should be considered and the risks assessed before deciding on a response to the situation.

*The pilot determines there is insufficient fuel to reach the destination, and considers other options, such as turning around and landing at a nearby airport that has been passed, diverting off course, or landing prior to the destination at an airport on the route. The expected outcome of each possible action must be considered along with an assessment of the risks involved. After studying the aeronautical chart, the pilot concludes that there is an airport that has fueling services within the remaining fuel range along the route. The time expended for the extra fuel stop is a worthwhile investment to ensure a safe completion of the flight.*



## IMPLEMENTING THE DECISION AND EVALUATING THE OUTCOME

Although a decision may be reached and a course of action implemented, the decision-making process is not complete. It is important to think ahead and determine how the decision could affect other phases of the flight. As the flight progresses, the pilot must continue to evaluate the outcome of the decision to ensure that it is producing the desired result.

*To implement the decision, the pilot determines the necessary course changes and calculates a new estimated time of arrival, as well as contacts the nearest flight service station to amend the flight plan and check weather conditions at the fuel stop. Proceeding to the airport, continue to monitor the groundspeed, fuel status, and the weather conditions to ensure that no additional steps need to be taken to guarantee the safety of the flight.*

The decision-making process normally consists of several steps before choosing a course of action. To help remember the elements of the decision-making process, a six-step model has been developed using the acronym “DECIDE.” [Figure 16-2]

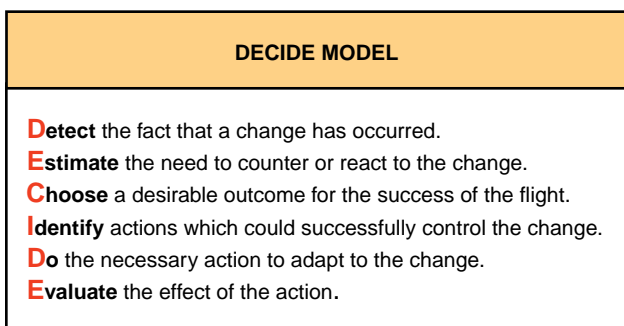

Figure 16-2. The DECIDE model can provide a framework for effective decision making.

## RISK MANAGEMENT

During each flight, decisions must be made regarding events involving interactions between the four **risk elements**—the pilot in command, the airplane, the environment, and the operation. The decision-making process involves an evaluation of each of these risk elements to achieve an accurate perception of the flight situation. [Figure 16-3]

One of the most important decisions that a pilot in command must make is the go/no-go decision. Evaluating each of these risk elements can help in deciding whether a flight should be conducted or continued. Below is a review of the four risk elements and how they affect decision making regarding the following situations.

**Pilot**—A pilot must continually make decisions about competency, condition of health, mental and emotional state, level of fatigue, and many other variables. For example, a pilot may be called early in the morning to make a long flight. If a pilot has had only a few hours of sleep and is concerned that the congestion being experienced could be the onset of a cold, it would be prudent to consider if the flight could be accomplished safely.

*A pilot had only 4 hours of sleep the night before. The boss then asked the pilot to fly to a meeting in a city 750 miles away. The reported weather was marginal and not expected to improve. After assessing fitness as a pilot, it was decided that it would not be wise to make the flight. The boss was initially unhappy, but later convinced by the pilot that the risks involved were unacceptable.*

**Airplane**—A pilot will frequently base decisions on the evaluations of the airplane, such as performance, equipment, or airworthiness.

**Risk Elements**—The four components of a flight that make up the overall situation.

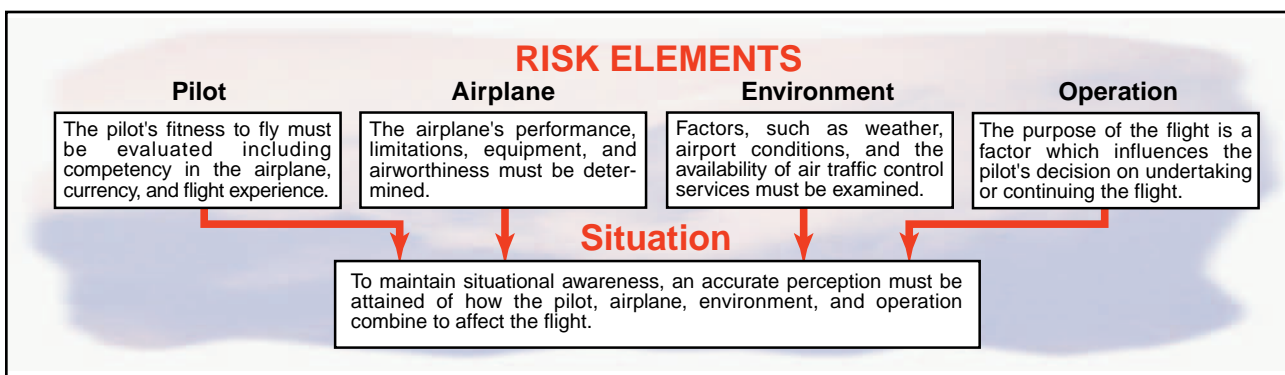

Figure 16-3. When situationally aware, the pilot has an overview of the total operation and is not fixated on one perceived significant factor.

During a preflight, a pilot noticed a small amount of oil dripping from the bottom of the cowling. Although the quantity of oil seemed insignificant at the time, the pilot decided to delay the takeoff and have a mechanic check the source of the oil. The pilot's good judgment was confirmed when the mechanic found that one of the oil cooler hose fittings was loose.

**Environment**—This encompasses many elements not pilot or airplane related. It can include such factors as weather, air traffic control, nav aids, terrain, takeoff and landing areas, and surrounding obstacles. Weather is one element that can change drastically over time and distance.

A pilot was landing a small airplane just after a heavy jet had departed a parallel runway. The pilot assumed that wake turbulence would not be a problem since landings had been performed under similar circumstances. Due to a combination of prevailing winds and wake turbulence from the heavy jet drifting across the landing runway, the airplane made a hard landing. The pilot made an error when assessing the flight environment.

**Operation**—The interaction between the pilot, airplane, and the environment is greatly influenced by the purpose of each flight operation. The pilot must evaluate the three previous areas to decide on the desirability of undertaking or continuing the flight as planned. It is worth asking why the flight is being made, how critical is it to maintain the schedule, and is the trip worth the risks?

On a ferry flight to deliver an airplane from the factory, in marginal weather conditions, the pilot calculated the groundspeed and determined that the airplane would arrive at the destination with only 10 minutes of fuel remaining. The pilot was determined to keep on schedule by trying to “stretch” the fuel supply instead of landing to refuel. After landing with low fuel state, the pilot realized that this could have easily resulted in an emergency landing in deteriorating weather conditions. This was a chance that was not worth taking to keep the planned schedule.

### ASSESSING RISK

Examining National Transportation Safety Board (NTSB) reports and other accident research can help assess risk more effectively. For example, the accident rate during night VFR decreases by nearly 50 percent once a pilot obtains 100 hours, and continues to decrease until the 1,000-hour level. The data suggest that for the first 500 hours, pilots flying VFR at night might want to establish higher personal limitations than are required by the regulations and, if applicable, apply instrument flying skills in this environment. [Figure 16-4]

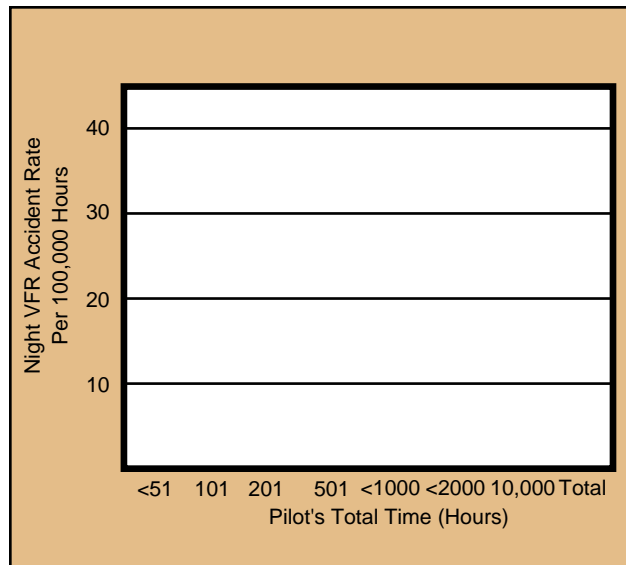

Figure 16-4. Statistical data can identify operations that have more risk involved.

Studies also indicate the types of flight activities that are likely to result in the most serious accidents. The majority of fatal general aviation accidents fall under the categories of takeoff/initial climb, maneuvering flight, approaches, and weather. Delving deeper into accident statistics can provide some important details that can help in understanding the risks involved with specific flying situations. For example, maneuvering flight is one of the largest single producers of fatal accidents. In the approach phase, fatal accidents often happen at night or in IFR conditions. Takeoff/initial climb accidents frequently are due to the pilot's lack of awareness of the effects of density altitude on airplane performance or other improper takeoff planning resulting in loss of control during, or shortly after takeoff. The majority of weather-related accidents occur after attempted VFR flight into IFR conditions.

## FACTORS AFFECTING DECISION MAKING

It is important to point out the fact that being familiar with the decision-making process does not ensure the good judgment to be a safe pilot. The ability to make effective decisions as pilot in command depends on a number of factors. Some circumstances, such as the time available to make a decision may be beyond a pilot's control. However, one can learn to recognize those factors that can be managed, and learn skills to improve decision-making ability and judgment.

### PILOT SELF-ASSESSMENT

The pilot in command of an airplane is directly responsible for, and is the final authority as to, the operation of that airplane. To effectively exercise that responsibility and make effective decisions regarding the outcome of a flight, a pilot should be aware of personal limitations. Performance during a flight is

affected by many factors, such as health, recency of experience, knowledge, skill level, and attitude.

Exercising good judgment begins prior to taking the controls of an airplane. Often, pilots thoroughly check their airplane to determine airworthiness, yet do not evaluate their own fitness for flight. Just as a checklist is used when preflighting an airplane, a personal checklist based on such factors as experience, currency, and comfort level can help determine if a pilot is prepared for a particular flight. Specifying when refresher training should be accomplished and designating weather minimums that may be higher than those listed in Title 14 of the Code of Federal Regulations (14 CFR) part 91 are elements that may be included on a personal checklist. In addition to a review of personal limitations, use the I'M SAFE Checklist to further evaluate fitness for flight. [Figure 16-5]

### RECOGNIZING HAZARDOUS ATTITUDES

Being fit to fly depends on more than just a pilot's physical condition and recency of experience. For example, attitude will affect the quality of decisions. Attitude can be defined as a personal motivational predisposition to respond to persons, situations, or events in a given manner. Studies have identified five hazardous attitudes that can interfere with the ability to make sound decisions and exercise authority properly. [Figure 16-6]

Hazardous attitudes can lead to poor decision making and actions that involve unnecessary risk. The pilot must examine decisions carefully to ensure that the choices have not been influenced by hazardous attitudes and be familiar with positive alternatives to counteract the hazardous attitudes. These substitute



Figure 16-5. Prior to flight, pilot fitness should be assessed the same as the airplane's airworthiness is evaluated.

attitudes are referred to as antidotes. During a flight operation, it is important to be able to recognize a hazardous attitude, correctly label the thought, and then recall its antidote. [Figure 16-7]

### STRESS MANAGEMENT

Everyone is stressed to some degree almost all the time. A certain amount of stress is good since it keeps a person alert and prevents complacency. However, effects of stress are cumulative and, if not coped with adequately, they eventually add up to an intolerable burden. Performance generally increases with the onset of stress, peaks, and then begins to fall off rap-

THE FIVE HAZARDOUS ATTITUDES	
<p><b>1. Anti-Authority:</b> "Don't tell me."</p>	<p>This attitude is found in people who do not like anyone telling them what to do. In a sense, they are saying, "No one can tell me what to do." They may be resentful of having someone tell them what to do, or may regard rules, regulations, and procedures as silly or unnecessary. However, it is always your prerogative to question authority if you feel it is in error.</p>
<p><b>2. Impulsivity:</b> "Do it quickly."</p>	<p>This is the attitude of people who frequently feel the need to do something, anything, immediately. They do not stop to think about what they are about to do; they do not select the best alternative, and they do the first thing that comes to mind.</p>
<p><b>3. Invulnerability:</b> "It won't happen to me."</p>	<p>Many people feel that accidents happen to others, but never to them. They know accidents can happen, and they know that anyone can be affected. They never really feel or believe that they will be personally involved. Pilots who think this way are more likely to take chances and increase risk.</p>
<p><b>4. Macho:</b> "I can do it."</p>	<p>Pilots who are always trying to prove that they are better than anyone else are thinking, "I can do it—I'll show them." Pilots with this type of attitude will try to prove themselves by taking risks in order to impress others. While this pattern is thought to be a male characteristic, women are equally susceptible.</p>
<p><b>5. Resignation:</b> "What's the use?"</p>	<p>Pilots who think, "What's the use?" do not see themselves as being able to make a great deal of difference in what happens to them. When things go well, the pilot is apt to think that it is good luck. When things go badly, the pilot may feel that someone is out to get me, or attribute it to bad luck. The pilot will leave the action to others, for better or worse. Sometimes, such pilots will even go along with unreasonable requests just to be a "nice guy."</p>

Figure 16-6. The pilot should examine decisions carefully to ensure that the choices have not been influenced by a hazardous attitude.

HAZARDOUS ATTITUDES	ANTIDOTES
<p><b>Anti-Authority</b> — Although he knows that flying so low to the ground is prohibited by the regulations, he feels that the regulations are too restrictive in some circumstances.</p>	<p><b>Follow the rules. They are usually right.</b></p>
<p><b>Impulsivity</b> — As he is buzzing the park, the airplane does not climb as well as Steve had anticipated and without thinking, Steve pulls back hard on the yoke. The airspeed drops and the airplane is close to a stalling attitude as the wing brushes a power line.</p>	<p><b>Not so fast. Think first.</b></p>
<p><b>Invulnerability</b> — Steve is not worried about an accident since he has flown this low many times before and he has not had any problems.</p>	<p><b>It could happen to me.</b></p>
<p><b>Macho</b> — Steve often brags to his friends about his skills as a pilot and how close to the ground he flies. During a local pleasure flight in his single-engine airplane, he decides to buzz some friends barbecuing at a nearby park.</p>	<p><b>Taking chances is foolish.</b></p>
<p><b>Resignation</b> — Although Steve manages to recover, the wing sustains minor damage. Steve thinks to himself, "It's dangerous for the power company to put those lines so close to a park. If somebody finds out about this I'm going to be in trouble, but it seems like no matter what I do, somebody's always going to criticize."</p>	<p><b>I'm not helpless. I can make a difference.</b></p>

**Figure 16-7.** The pilot must be able to identify hazardous attitudes and apply the appropriate antidote when needed.

idly as stress levels exceed a person's ability to cope. The ability to make effective decisions during flight can be impaired by stress. Factors, referred to as stressors, can increase a pilot's risk of error in the cockpit. [Figure 16-8]

STRESSORS	
<p><b>Physical Stress</b>—Conditions associated with the environment, such as temperature and humidity extremes, noise, vibration, and lack of oxygen.</p>	
<p><b>Physiological Stress</b>—Physical conditions, such as fatigue, lack of physical fitness, sleep loss, missed meals (leading to low blood sugar levels), and illness.</p>	
<p><b>Psychological Stress</b>—Social or emotional factors, such as a death in the family, a divorce, a sick child, or a demotion at work. This type of stress may also be related to mental workload, such as analyzing a problem, navigating an aircraft, or making decisions.</p>	

**Figure 16-8.** The three types of stressors that can affect a pilot's performance.

There are several techniques to help manage the accumulation of life stresses and prevent stress overload. For example, including relaxation time in a busy schedule and maintaining a program of physical fitness can help reduce stress levels. Learning to manage time more effectively can help avoid heavy pressures imposed by getting behind schedule and not meeting deadlines. Take a self-assessment to determine capabilities and limitations and then set realistic goals. In addition, avoiding stressful situations and encounters can help to cope with stress.

### USE OF RESOURCES

To make informed decisions during flight operations, a pilot must become aware of the resources found both inside and outside the cockpit. Since useful tools and sources of information may not always be readily apparent, learning to recognize these resources is an essential part of ADM training. Resources must not only be identified, but a pilot must develop the skills to evaluate whether there is time to use a particular resource and the impact that its use will have upon the safety of flight. For example, the assistance of air traffic control (ATC) may be very useful if a pilot becomes lost. However, in an emergency situation when action needs to be taken quickly, time may not be available to contact ATC immediately.

### INTERNAL RESOURCES

Internal resources are found in the cockpit during flight. Since some of the most valuable internal resources are ingenuity, knowledge, and skill, a pilot can expand cockpit resources immensely by improving these capabilities. This can be accomplished by frequently reviewing flight information publications, such as the CFRs and the *Aeronautical Information Manual* (AIM), as well as by pursuing additional training.

A thorough understanding of all the equipment and systems in the airplane is necessary to fully utilize all resources. For example, advanced navigation and autopilot systems are valuable resources. However, if pilots do not fully understand how to use this equipment,

or they rely on it so much that they become complacent, it can become a detriment to safe flight.

Checklists are essential cockpit resources for verifying that the airplane instruments and systems are checked, set, and operating properly, as well as ensuring that the proper procedures are performed if there is a system malfunction or in-flight emergency. In addition, the Airplane Flight Manual/Pilot's Operating Handbook (AFM/POH), which is required to be carried on board the airplane, is essential for accurate flight planning and for resolving in-flight equipment malfunctions. Other valuable cockpit resources include current aeronautical charts and publications, such as the *Airport/Facility Directory*.

Passengers can also be a valuable resource. Passengers can help watch for traffic and may be able to provide information in an irregular situation, especially if they are familiar with flying. A strange smell or sound may alert a passenger to a potential problem. A pilot in command should brief passengers before the flight to make sure that they are comfortable voicing any concerns.

### EXTERNAL RESOURCES

Possibly the greatest external resources during flight are air traffic controllers and flight service specialists. ATC can help decrease pilot workload by providing traffic advisories, radar vectors, and assistance in emergency situations. Flight service stations can provide updates on weather, answer questions about airport conditions, and may offer direction-finding assistance. The services provided by ATC can be invaluable in enabling a pilot to make informed in-flight decisions.

### WORKLOAD MANAGEMENT

Effective workload management ensures that essential operations are accomplished by planning, prioritizing, and sequencing tasks to avoid work overload. As experience is gained, a pilot learns to recognize future workload requirements and can prepare for high workload periods during times of low workload. Reviewing the appropriate chart and setting radio frequencies well in advance of when they are needed helps reduce workload as the flight nears the airport. In addition, a pilot should listen to ATIS, ASOS, or AWOS, if available, and then monitor the tower frequency or CTAF to get a good idea of what traffic conditions to expect. Checklists should be performed well in advance so there is time to focus on traffic and ATC instructions. These procedures are especially important prior to entering a high-density traffic area, such as Class B airspace.

To manage workload, items should be prioritized. During any situation, and especially in an emergency, remember the phrase "aviate, navigate, and communicate." This means that the first thing the pilot should do is to make sure the airplane is under control. Then begin flying to an acceptable landing area. Only after

the first two items are assured should the pilot try to communicate with anyone.

Another important part of managing workload is recognizing a work overload situation. The first effect of high workload is that the pilot begins to work faster. As workload increases, attention cannot be devoted to several tasks at one time, and the pilot may begin to focus on one item. When a pilot becomes task saturated, there is no awareness of inputs from various sources, so decisions may be made on incomplete information, and the possibility of error increases. [Figure 16-9]

When becoming overloaded, stop, think, slow down, and prioritize. It is important to understand options that may be available to decrease workload. For example, tasks such as locating an item on a chart or setting a radio frequency may be delegated to another pilot or passenger; an autopilot, if available, may be used; or ATC may be enlisted to provide assistance.

### SITUATIONAL AWARENESS

Situational awareness is the accurate perception of the operational and environmental factors that affect the airplane, pilot, and passengers during a specific period of time. Maintaining situational awareness requires an understanding of the relative significance of these factors and their future impact on the flight. When situationally aware, the pilot has an overview of the total operation and is not fixated on one perceived significant factor. Some of the elements inside the airplane to be considered are the status of airplane systems, and also the pilot and passengers. In addition, an awareness of the environmental conditions of the flight, such as spatial orientation of the airplane, and its relationship to terrain, traffic, weather, and airspace must be maintained.

To maintain situational awareness, all of the skills involved in aeronautical decision making are used. For

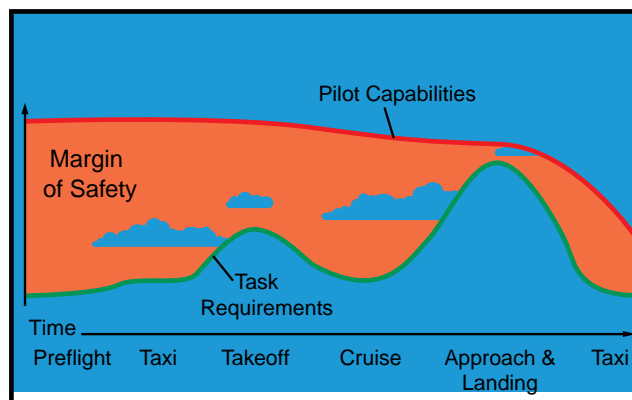

**Figure 16-9. Accidents often occur when flying task requirements exceed pilot capabilities. The difference between these two factors is called the margin of safety. Note that in this idealized example, the margin of safety is minimal during the approach and landing. At this point, an emergency or distraction could overtax pilot capabilities, causing an accident.**

example, an accurate perception of pilot fitness can be achieved through self-assessment and recognition of hazardous attitudes. A clear assessment of the status of navigation equipment can be obtained through workload management, and establishing a productive relationship with ATC can be accomplished by effective resource use.

### **OBSTACLES TO MAINTAINING SITUATIONAL AWARENESS**

Fatigue, stress, and work overload can cause a pilot to fixate on a single perceived important item rather than maintaining an overall awareness of the flight situation. A contributing factor in many accidents is a distraction that diverts the pilot's attention from monitoring the instruments or scanning outside the airplane. Many cockpit distractions begin as a minor problem, such as a gauge that is not reading correctly, but result in accidents as the pilot diverts attention to the perceived problem and neglects to properly control the airplane.

Complacency presents another obstacle to maintaining situational awareness. When activities become routine, there is a tendency to relax and not put as much effort into performance. Like fatigue, complacency reduces a pilot's effectiveness in the cockpit. However, complacency is harder to recognize than fatigue, since everything is per-

ceived to be progressing smoothly. For example, a pilot has not bothered to calculate the CG of the airplane because it has never been a problem. Without the pilot realizing it, a passenger loads a heavy piece of equipment in the nose baggage compartment. The pilot notices severe nose heaviness during climb-out after takeoff, and finds it necessary to use full nose-up trim to maintain level flight. As the pilot flares for landing, the elevator reaches the stop without raising the nose enough, and the nose-first landing results in loss of the nose gear and extensive damage to the airplane.

### **OPERATIONAL PITFALLS**

There are a number of classic behavioral traps into which pilots have been known to fall. Pilots, particularly those with considerable experience, as a rule, always try to complete a flight as planned, please passengers, and meet schedules. The basic drive to meet or exceed goals can have an adverse effect on safety, and can impose an unrealistic assessment of piloting skills under stressful conditions. These tendencies ultimately may bring about practices that are dangerous and often illegal, and may lead to a mishap. A pilot will develop awareness and learn to avoid many of these operational pitfalls through effective ADM training. [Figure 16-10]

<b>OPERATIONAL PITFALLS</b>
<p><b>Peer Pressure</b>—Poor decision making may be based upon an emotional response to peers, rather than evaluating a situation objectively.</p> <p><b>Mind Set</b>—A pilot displays mind set through an inability to recognize and cope with changes in a given situation.</p> <p><b>Get-There-Itis</b>—This disposition impairs pilot judgment through a fixation on the original goal or destination, combined with a disregard for any alternative course of action.</p> <p><b>Duck-Under Syndrome</b>—A pilot may be tempted to make it into an airport by descending below minimums during an approach. There may be a belief that there is a built-in margin of error in every approach procedure, or a pilot may want to admit that the landing cannot be completed and a missed approach must be initiated.</p> <p><b>Scud Running</b>—This occurs when a pilot tries to maintain visual contact with the terrain at low altitudes while instrument conditions exist.</p> <p><b>Continuing Visual Flight Rules (VFR) into Instrument Conditions</b>—Spatial disorientation or collision with ground/obstacles may occur when a pilot continues VFR into instrument conditions. This can be even more dangerous if the pilot is not instrument-rated or current.</p> <p><b>Getting Behind the Aircraft</b>—This pitfall can be caused by allowing events or the situation to control pilot actions. A constant state of surprise at what happens next may be exhibited when the pilot is getting behind the aircraft.</p> <p><b>Loss of Positional or Situational Awareness</b>—In extreme cases, when a pilot gets behind the aircraft, a loss of positional or situational awareness may result. The pilot may not know the aircraft's geographical location, or may be unable to recognize deteriorating circumstances.</p> <p><b>Operating Without Adequate Fuel Reserves</b>—Ignoring minimum fuel reserve requirements is generally the result of overconfidence, lack of flight planning, or disregarding applicable regulations.</p> <p><b>Descent Below the Minimum En Route Altitude</b>—The duck-under syndrome, as mentioned above, can also occur during the en route portion of an IFR flight.</p> <p><b>Flying Outside the Envelope</b>—The assumed high performance capability of a particular aircraft may cause a mistaken belief that it can meet the demands imposed by a pilot's overestimated flying skills.</p> <p><b>Neglect of Flight Planning, Preflight Inspections, and Checklists</b>—A pilot may rely on short- and long-term memory, regular flying skills, and familiar routes instead of established procedures and published checklists. This can be particularly true of experienced pilots.</p>

**Figure 16-10.** All experienced pilots have fallen prey to, or have been tempted by, one or more of these tendencies in their flying careers.



# Glossary



**100-HOUR INSPECTION** — An inspection, identical in scope to an annual inspection. Conducted every 100 hours of flight on aircraft of under 12,500 pounds that are used to carry passengers for hire.

**ABSOLUTE ALTITUDE**—The vertical distance of an airplane above the terrain, or above ground level (AGL).

**ACCELERATION**—Force involved in overcoming inertia, and which may be defined as a change in velocity per unit of time.

**ACCELERATION ERROR** — Fluctuation of the magnetic compass during acceleration. In the Northern Hemisphere, the compass swings toward the north during acceleration.

**ACCELERATE-GO DISTANCE** — The distance required to accelerate to  $V_1$  with all engines at takeoff power, experience an engine failure at  $V_1$  and continue the takeoff on the remaining engine(s). The runway required includes the distance required to climb to 35 feet by which time  $V_2$  speed must be attained.

**ACCELERATE-STOP DISTANCE** — The distance required to accelerate to  $V_1$  with all engines at takeoff power, experience an engine failure at  $V_1$ , and abort the takeoff and bring the airplane to a stop using braking action only (use of thrust reversing is not considered).

**ADF**—See AUTOMATIC DIRECTION FINDER.

**ADIABATIC COOLING** — A process of cooling the air through expansion. For example, as air moves

up slope it expands with the reduction of atmospheric pressure and cools as it expands.

**ADIABATIC HEATING** — A process of heating dry air through compression. For example, as air moves down a slope it is compressed, which results in an increase in temperature.

**ADJUSTABLE-PITCH PROPELLER**—A propeller with blades whose pitch can be adjusted on the ground with the engine not running, but which cannot be adjusted in flight. Also referred to as a ground adjustable propeller. Sometimes also used to refer to constant-speed propellers that are adjustable in flight.

**ADJUSTABLE STABILIZER**—A stabilizer that can be adjusted in flight to trim the airplane, thereby allowing the airplane to fly hands-off at any given airspeed.

**ADVECTION FOG**—Fog resulting from the movement of warm, humid air over a cold surface.

**ADVERSE YAW**—A condition of flight in which the nose of an airplane tends to yaw toward the outside of the turn. This is caused by the higher induced drag on the outside wing, which is also producing more lift. Induced drag is a by-product of the lift associated with the outside wing.

**AERODYNAMICS**—The science of the action of air on an object, and with the motion of air on other gases. Aerodynamics deals with the production of lift by the aircraft, the relative wind, and the atmosphere.

**AERONAUTICAL CHART** — A map used in air navigation containing all or part of the following: topo-

graphic features, hazards and obstructions, navigation aids, navigation routes, designated airspace, and airports.

**AERONAUTICAL DECISION MAKING (ADM)**—A systematic approach to the mental process used by pilots to consistently determine the best course of action in response to a given set of circumstances.

**AGONIC LINE**—Line along which the variation between true and magnetic values is zero.

**AILERONS**—Primary flight control surfaces mounted on the trailing edge of an airplane wing, near the tip. Ailerons control roll about the longitudinal axis.

**AIRCRAFT** — A device that is used, or intended to be used, for flight.

**AIRCRAFT ALTITUDE**—The actual height above sea level at which the aircraft is flying.

**AIRFOIL**—Any surface, such as a wing, propeller, rudder, or even a trim tab, which provides aerodynamic force when it interacts with a moving stream of air.

**AIR MASS**—An extensive body of air having fairly uniform properties of temperature and moisture.

**AIRMET**—In-flight weather advisory concerning moderate icing, moderate turbulence, sustained winds of 30 knots or more at the surface, and widespread areas of ceilings less than 1,000 feet and/or visibility less than 3 miles.

**AIRPLANE**—An engine-driven, fixed-wing aircraft heavier than air that is supported in flight by the dynamic reaction of air against its wings.



**AIRPLANE FLIGHT MANUAL (AFM)**—A document developed by the airplane manufacturer and approved by the Federal Aviation Administration (FAA). It is specific to a particular make and model airplane by serial number and it contains operating procedures and limitations.

**AIRPLANE OWNER/ INFORMATION MANUAL** — A document developed by the airplane manufacturer containing general information about the make and model of an airplane. The airplane owner's manual is not FAA-approved and is not specific to a particular serial numbered airplane. This manual is not kept current, and therefore cannot be substituted for the AFM/POH.

**AIRPORT ADVISORY AREA**—An area within 10 statute miles (SM) of an airport where a control tower is not operating, but where a flight service station (FSS) is located. At these locations, the FSS provides advisory service to arriving and departing aircraft.

**AIRPORT/FACILITY DIRECTORY** — A publication designed primarily as a pilot's operational manual containing all airports, seaplane bases, and heliports open to the public including communications data, navigational facilities, and certain special notices and procedures. This publication is issued in seven volumes according to geographical area.

**AIRSPEED**—Rate of the aircraft's progress through the air.

**AIRSPEED INDICATOR** — An instrument that is a sensitive, differential pressure gauge which measures and shows promptly the difference between pitot or impact pressure, and static pressure, the undisturbed atmospheric pressure at level flight.

**AIRWORTHINESS CERTIFICATE** — A certificate issued by the FAA to all aircraft that have been proven to meet the minimum standards set down by the Code of Federal Regulations.

**AIRWORTHINESS DIRECTIVE**—A regulatory notice sent out by the FAA to the registered owner of an aircraft informing the owner of a condition that prevents the aircraft from continuing to meet its conditions for airworthiness. Airworthiness Directives (AD notes) are to be complied with within the required time limit, and the fact of compliance, the date of compliance, and the method of compliance are recorded in the aircraft's maintenance records.

**ALERT AREAS**—Areas depicted on aeronautical charts to advise pilots that a high volume of pilot training or unusual aerial activity is taking place.

**ALTIMETER**—A flight instrument that indicates altitude by sensing pressure changes.

**ALTITUDE ENGINE**—A reciprocating aircraft engine having a rated takeoff power that is producible from sea level to an established higher altitude.

**AMBIENT PRESSURE**—The pressure in the area immediately surrounding the aircraft.

**AMBIENT TEMPERATURE**—The temperature in the area immediately surrounding the aircraft.

**ANEROID**—A sealed flexible container that expands or contracts in relation to the surrounding air pressure. It is used in an altimeter or a barometer to measure the pressure of the air.

**ANGLE OF ATTACK**—The acute angle between the chord line of the airfoil and the direction of the relative wind. It is important in the production of lift.

**ANGLE OF INCIDENCE**—The angle formed by the chord line of the wing and a line parallel to the longitudinal axis of the airplane.

**ANHEDRAL**—A downward slant from root to tip of an aircraft's wing or horizontal tail surface.

**ANNUAL INSPECTION**—A complete inspection of an aircraft and engine, required by the Code of Federal Regulations, to be accomplished every 12 calendar months on all certificated aircraft. Only an A&P technician holding an Inspection Authorization can conduct an annual inspection.

**ANTISERVO TAB**—An adjustable tab attached to the trailing edge of a stabilator that moves in the same direction as the primary control. It is used to make the stabilator less sensitive.

**AREA FORECAST (FA)**—A report that gives a picture of clouds, general weather conditions, and visual meteorological conditions (VMC) expected over a large area encompassing several states.

**AREA NAVIGATION (RNAV)**—A system that provides enhanced navigational capability to the pilot. RNAV equipment can compute the airplane position, actual track and groundspeed and then provide meaningful information relative to a route of flight selected by the pilot. Typical equipment will provide the pilot with distance, time, bearing and crosstrack error relative to the selected "TO" or "active" waypoint and the selected route. Several distinctly different navigational systems with different navigational performance characteristics are capable of providing area navigational functions. Present day RNAV includes INS, LORAN, VOR/DME, and GPS systems.

**ARM**—The horizontal distance in inches from the reference datum line to the center of gravity of an item. The algebraic sign is plus (+) if measured aft of the datum, and minus (-) if measured forward of the datum.

**ASPECT RATIO**—Span of a wing divided by its average chord.

**ASYMMETRIC THRUST**—Also known as P-factor. A tendency for an aircraft to yaw to the left due to the descending propeller blade on the right producing more thrust than the

ascending blade on the left. This occurs when the aircraft's longitudinal axis is in a climbing attitude in relation to the relative wind. The P-factor would be to the right if the aircraft had a counterclockwise rotating propeller.

**ATTITUDE**—A personal motivational predisposition to respond to persons, situations, or events in a given manner that can, nevertheless, be changed or modified through training as sort of a mental shortcut to decision making.

**ATTITUDE INDICATOR** — An instrument that uses an artificial horizon and miniature airplane to depict the position of the airplane in relation to the true horizon. The attitude indicator senses roll as well as pitch, which is the up and down movement of the airplane's nose.

**ATTITUDE MANAGEMENT**—The ability to recognize hazardous attitudes in oneself and the willingness to modify them as necessary through the application of an appropriate antidote thought.

**AUTOKINESIS**—This is caused by staring at a single point of light against a dark background for more than a few seconds. After a few moments, the light appears to move on its own.

**AUTOMATED SURFACE OBSERVATION SYSTEM (ASOS)**—Weather reporting system which provides surface observations every minute via digitized voice broadcasts and printed reports.

**AUTOMATED WEATHER OBSERVING SYSTEM (AWOS)** — Automated weather reporting system consisting of various sensors, a processor, a computer-generated voice subsystem, and a transmitter to broadcast weather data.

**AUTOMATIC DIRECTION FINDER (ADF)**—An aircraft radio navigation system which senses and indicates the direction to an L/MF nondirectional radio beacon (NDB) ground transmitter. Direction is

indicated to the pilot as a magnetic bearing or as a relative bearing to the longitudinal axis of the aircraft depending on the type of indicator installed in the aircraft. In certain applications, such as military, ADF operations may be based on airborne and ground transmitters in the VHF/UHF frequency spectrum.

**AUTOMATIC TERMINAL INFORMATION SERVICE (ATIS)**—The continuous broadcast of recorded noncontrol information in selected terminal areas. Its purpose is to improve controller effectiveness and to relieve frequency congestion by automating the repetitive transmission of essential but routine information.

**AUTOPILOT**—An automatic flight control system which keeps an aircraft in level flight or on a set course. Automatic pilots can be directed by the pilot, or they may be coupled to a radio navigation signal.

**AVIATION ROUTINE WEATHER REPORT (METAR)**—Observation of current surface weather reported in a standard international format.

**AXES OF AN AIRCRAFT**—Three imaginary lines that pass through an aircraft's center of gravity. The axes can be considered as imaginary axles around which the aircraft turns. The three axes pass through the center of gravity at 90° angles to each other. The axis from nose to tail is the longitudinal axis, the axis that passes from wingtip to wingtip is the lateral axis and the axis that passes vertically through the center of gravity is the vertical axis.

**AXIAL FLOW COMPRESSOR**—A type of compressor used in a turbine engine in which the airflow through the compressor is essentially linear. An axial-flow compressor is made up of several stages of alternate rotors and stators. The compressor ratio is determined by the decrease in area of the succeeding stages.

**BALANCE TAB**—An auxiliary control mounted on a primary control

surface, which automatically moves in the direction opposite the primary control to provide an aerodynamic assist in the movement of the control. Sometimes referred to as a servo tab.

**BASIC EMPTY WEIGHT (GAMA)**—Basic empty weight includes the standard empty weight plus optional and special equipment that has been installed.

**BERNOULLI'S PRINCIPLE**—A principle that explains how the pressure of a moving fluid varies with its speed of motion. An increase in the speed of movement causes a decrease in the fluid's pressure.

**BIPLANES**—Airplanes with two sets of wings.

**BYPASS RATIO**—The ratio of the mass airflow in pounds per second through the fan section of a turbofan engine to the mass airflow that passes through the gas generator portion of the engine.

**CABIN ALTITUDE**—Cabin pressure in terms of equivalent altitude above sea level.

**CALIBRATED AIRSPEED (CAS)**—Indicated airspeed corrected for installation error and instrument error. Although manufacturers attempt to keep airspeed errors to a minimum, it is not possible to eliminate all errors throughout the airspeed operating range. At certain airspeeds and with certain flap settings, the installation and instrument errors may total several knots. This error is generally greatest at low airspeeds. In the cruising and higher airspeed ranges, indicated airspeed and calibrated airspeed are approximately the same. Refer to the airspeed calibration chart to correct for possible airspeed errors.

**CAMBER**—The camber of an airfoil is the characteristic curve of its upper and lower surfaces. The upper camber is more pronounced, while the lower camber is comparatively flat. This causes the velocity of the airflow immediately above the wing to be much higher than that below the wing.

**CANARD**—A horizontal surface mounted ahead of the main wing to provide longitudinal stability and control. It may be a fixed, movable, or variable geometry surface, with or without control surfaces.

**CANARD CONFIGURATION**—A configuration in which the span of the forward wings is substantially less than that of the main wing.

**CANTILEVER**—A wing designed to carry the loads without external struts.

**CEILING**—The height above the earth's surface of the lowest layer of clouds, which is reported as broken or overcast, or the vertical visibility into an obscuration.

**CENTER OF GRAVITY (CG)**—The point at which an airplane would balance if it were possible to suspend it at that point. It is the mass center of the airplane, or the theoretical point at which the entire weight of the airplane is assumed to be concentrated. It may be expressed in inches from the reference datum, or in percent of mean aerodynamic chord (MAC). The location depends on the distribution of weight in the airplane.

**CENTER-OF-GRAVITY LIMITS**—The specified forward and aft points within which the CG must be located during flight. These limits are indicated on pertinent airplane specifications.

**CENTER-OF-GRAVITY RANGE**—The distance between the forward and aft CG limits indicated on pertinent airplane specifications.

**CENTER OF PRESSURE**—A point along the wing chord line where lift is considered to be concentrated. For this reason, the center of pressure is commonly referred to as the center of lift.

**CENTRIFUGAL FLOW COMPRESSOR**—An impeller shaped device that receives air at its center and slings the air outward at high velocity into a diffuser for increased pressure. Also referred to as a radial outflow compressor.

**CENTRIFUGAL FORCE** — An outward force, that opposes centripetal force, resulting from the effect of inertia during a turn.

**CENTRIPETAL FORCE**—A center-seeking force directed inward toward the center of rotation created by the horizontal component of lift in turning flight.

**CHORD LINE**—An imaginary straight line drawn through an airfoil from the leading edge to the trailing edge.

**COEFFICIENT OF LIFT**—The ratio between lift pressure and dynamic pressure.

**COLD FRONT**—The boundary between two air masses where cold air is replacing warm air.

**COMPLEX AIRCRAFT**—An aircraft with retractable landing gear, flaps, and a controllable-pitch propeller.

**COMPRESSOR PRESSURE RATIO**—The ratio of compressor discharge pressure to compressor inlet pressure.

**COMPRESSOR STALL**—In gas turbine engines, a condition in an axial-flow compressor in which one or more stages of rotor blades fail to pass air smoothly to the succeeding stages. A stall condition is caused by a pressure ratio that is incompatible with the engine r.p.m. Compressor stall will be indicated by a rise in exhaust temperature or r.p.m. fluctuation, and if allowed to continue, may result in flameout and physical damage to the engine.

**CONDENSATION**—A change of state of water from a gas (water vapor) to a liquid.

**CONDENSATION NUCLEI**—Small particles of solid matter in the air on which water vapor condenses.

**CONFIGURATION**—This is a general term, which normally refers to the position of the landing gear and flaps.

## **CONSTANT-SPEED**

**PROPELLER**—A controllable-pitch propeller whose pitch is automatically varied in flight by a governor to maintain a constant r.p.m. in spite of varying air loads.

**CONTINUOUS FLOW OXYGEN SYSTEM**—System that supplies a constant supply of pure oxygen to a rebreather bag that dilutes the pure oxygen with exhaled gases and thus supplies a healthy mix of oxygen and ambient air to the mask. Primarily used in passenger cabins of commercial airliners.

**CONTROLLABILITY**—A measure of the response of an aircraft relative to the pilot's flight control inputs.

**CONTROLLED AIRPORT**—An airport that has an operating control tower.

**CONTROLLED AIRSPACE**—A generic term that covers the different classifications of airspace and defined dimensions within which air traffic control service is provided in accordance with the airspace classification. Controlled airspace consists of Class A, B, C, D, and E airspace.

## **CONVECTIVE**

**SIGMET**—A weather advisory concerning convective weather significant to the safety of all aircraft. Convective SIGMETs are issued for tornadoes, lines of thunderstorms, thunderstorms over a wide area, embedded thunderstorms, wind gusts to 50 knots or greater, and/or hail 3/4 inch in diameter or greater.

## **CONVENTIONAL**

**LANDING GEAR**—Landing gear employing a third rear-mounted wheel. These airplanes are also sometimes referred to as tailwheel airplanes.

**COUPLED AILERONS AND RUDDER**—Rudder and ailerons are connected with interconnect springs in order to counteract adverse yaw. Can be overridden if it becomes necessary to slip the aircraft.

**COURSE**—The intended direction of flight in the horizontal plane measured in degrees from north.

**COWL FLAPS** — Shutter-like devices arranged around certain air-cooled engine cowlings, which may be opened or closed to regulate the flow of air around the engine.

**CREW RESOURCE MANAGEMENT (CRM)**—The application of team management concepts in the flight deck environment. It was initially known as cockpit resource management, but as CRM programs evolved to include cabin crews, maintenance personnel, and others, the phrase “crew resource management” was adopted. This includes single pilots, as in most general aviation aircraft. Pilots of small aircraft, as well as crews of larger aircraft, must make effective use of all available resources; human resources, hardware, and information. A current definition includes all groups routinely working with the cockpit crew who are involved in decisions required to operate a flight safely. These groups include, but are not limited to: pilots, dispatchers, cabin crewmembers, maintenance personnel, and air traffic controllers. CRM is one way of addressing the challenge of optimizing the human/machine interface and accompanying interpersonal activities.

**CRITICAL ALTITUDE** — The maximum altitude under standard atmospheric conditions at which a turbocharged engine can produce its rated horsepower.

**CRITICAL ANGLE OF ATTACK**—The angle of attack at which a wing stalls regardless of airspeed, flight attitude, or weight.

**DATUM (REFERENCE DATUM)**—An imaginary vertical plane or line from which all measurements of arm are taken. The datum is established by the manufacturer. Once the datum has been selected, all moment arms and the location of CG range are measured from this point.

**DEAD RECKONING**—Navigation of an airplane solely by means of computations based on airspeed,

course, heading, wind direction, and speed, groundspeed, and elapsed time.

**DECELERATION ERROR**—Fluctuation of the magnetic compass during acceleration. In the Northern Hemisphere, the compass swings toward the south during deceleration.

**DELTA**—A Greek letter expressed by the symbol  $\Delta$  to indicate a change of values. As an example,  $\Delta$ CG indicates a change (or movement) of the CG.

**DENSITY ALTITUDE**—This altitude is pressure altitude corrected for variations from standard temperature. When conditions are standard, pressure altitude and density altitude are the same. If the temperature is above standard, the density altitude is higher than pressure altitude. If the temperature is below standard, the density altitude is lower than pressure altitude. This is an important altitude because it is directly related to the airplane’s performance.

**DEPOSITION**—The direct transformation of a gas to a solid state, in which the liquid state is bypassed. Some sources use sublimation to describe this process instead of deposition.

**DETONATION** — The sudden release of heat energy from fuel in an aircraft engine caused by the fuel-air mixture reaching its critical pressure and temperature. Detonation occurs as a violent explosion rather than a smooth burning process.

**DEVIATION** — A compass error caused by magnetic disturbances from electrical and metal components in the airplane. The correction for this error is displayed on a compass correction card placed near the magnetic compass in the airplane.

**DEW**—Moisture that has condensed from water vapor. Usually found on cooler objects near the ground, such as grass, as the near-surface layer of air cools faster than the layers of air above it.

**DEWPOINT**—The temperature at which air reaches a state where it can hold no more water.

**DIFFERENTIAL AILERONS** — Control surface rigged such that the aileron moving up moves a greater distance than the aileron moving down. The up aileron produces extra parasite drag to compensate for the additional induced drag caused by the down aileron. This balancing of the drag forces helps minimize adverse yaw.

**DIFFERENTIAL PRESSURE**—A difference between two pressures. The measurement of airspeed is an example of the use of differential pressure.

**DIHEDRAL**—The positive acute angle between the lateral axis of an airplane and a line through the center of a wing or horizontal stabilizer. Dihedral contributes to the lateral stability of an airplane.

**DILUTER-DEMAND OXYGEN SYSTEM**—An oxygen system that delivers oxygen mixed or diluted with air in order to maintain a constant oxygen partial pressure as the altitude changes.

**DIRECT USER ACCESS TERMINAL SERVICE (DUATS)**—A computer-based program providing NWS and FAA weather products that are normally used in pilot weather briefings.

**DIRECTIONAL STABILITY**—Stability about the vertical axis of an aircraft, whereby an aircraft tends to return, on its own, to flight aligned with the relative wind when disturbed from that equilibrium state. The vertical tail is the primary contributor to directional stability, causing an airplane in flight to align with the relative wind.

**DISTANCE MEASURING EQUIPMENT (DME)**—Equipment (airborne and ground) to measure, in nautical miles, the slant range distance of an aircraft from the DME navigation aid.

**DRAG**—An aerodynamic force on a body acting parallel and opposite to the relative wind. The resistance of the atmosphere to the relative motion of an aircraft. Drag opposes thrust and limits the speed of the airplane.

**DRIFT ANGLE**—Angle between heading and track.

**DUATS** — See DIRECT USER ACCESS TERMINAL SERVICE.

**DUTCH ROLL**—A combination of rolling and yawing oscillations that normally occurs when the dihedral effects of an aircraft are more powerful than the directional stability. Usually dynamically stable but objectionable in an airplane because of the oscillatory nature.

**DYNAMIC HYDROPLANING**—A condition that exists when landing on a surface with standing water deeper than the tread depth of the tires. When the brakes are applied, there is a possibility that the brake will lock up and the tire will ride on the surface of the water, much like a water ski. When the tires are hydroplaning, directional control and braking action are virtually impossible. An effective anti-skid system can minimize the effects of hydroplaning.

**DYNAMIC STABILITY** — The property of an aircraft that causes it, when disturbed from straight-and-level flight, to develop forces or moments that restore the original condition of straight and level.

**EDDY CURRENT DAMPING**—The decreased amplitude of oscillations by the interaction of magnetic fields. In the case of a vertical card magnetic compass, flux from the oscillating permanent magnet produces eddy currents in a damping disk or cup. The magnetic flux produced by the eddy currents opposes the flux from the permanent magnet and decreases the oscillations.

**ELEVATOR**—The horizontal, movable primary control surface in the tail section, or empennage, of an airplane. The elevator is hinged to the trailing edge of the fixed horizontal stabilizer.

**EMPENNAGE**—The section of the airplane that consists of the vertical stabilizer, the horizontal stabilizer, and the associated control surfaces.

**EMPTY-FIELD MYOPIA**—Induced nearsightedness that is

associated with flying at night, in instrument meteorological conditions and/or reduced visibility. With nothing to focus on, the eyes automatically focus on a point just slightly ahead of the airplane.

**ENGINE PRESSURE RATIO (EPR)**—The ratio of turbine discharge pressure divided by compressor inlet pressure, which is used as an indication of the amount of thrust being developed by a turbine engine.

**EN ROUTE FLIGHT ADVISORY SERVICE (EFAS)**—A service specifically designed to provide, upon pilot request, timely weather information pertinent to the type of flight, intended route of flight and altitude. The FSSs providing this service are listed in the Airport/Facility Directory. Also known as Flight Watch.

**EQUILIBRIUM**—A condition that exists within a body when the sum of the moments of all of the forces acting on the body is equal to zero. In aerodynamics, equilibrium is when all opposing forces acting on an aircraft are balanced (steady, unaccelerated flight conditions).

**EQUIVALENT AIRSPEED**—The airspeed indicator reading corrected for position (or installation), or instrument error, and for adiabatic compressible flow for the particular altitude. (EAS is equal to CAS at sea level in standard atmosphere.)

**EVAPORATION**—The transformation of a liquid to a gaseous state, such as the change of water to water vapor.

**EXHAUST GAS TEMPERATURE (EGT)**—The temperature of the exhaust gases as they leave the cylinders of a reciprocating engine or the turbine section of a turbine engine.

**EXPLOSIVE**

**DECOMPRESSION**—A change in cabin pressure faster than the lungs can decompress. Lung damage is possible.

**FIXED-PITCH PROPELLERS**—Propellers with fixed blade angles.

Fixed-pitch propellers are designed as climb propellers, cruise propellers, or standard propellers.

**FIXED SLOT**—A fixed, nozzle-shaped opening near the leading edge of a wing that ducts air onto the top surface of the wing. Its purpose is to increase lift at higher angles of attack.

**FLAMEOUT**—A condition in the operation of a gas turbine engine in which the fire in the engine goes out due to either too much or too little fuel sprayed into the combustors.

**FLAPS**—Hinged portion of the trailing edge between the ailerons and fuselage. In some aircraft ailerons and flaps are interconnected to produce full-span “flaperons.” In either case, flaps change the lift and drag on the wing.

**FLOOR LOAD LIMIT**—The maximum weight the floor can sustain per square inch/foot as provided by the manufacturer.

**FOG**—Cloud consisting of numerous minute water droplets and based at the surface; droplets are small enough to be suspended in the earth’s atmosphere indefinitely. (Unlike drizzle, it does not fall to the surface; differs from cloud only in that a cloud is not based at the surface; distinguished from haze by its wetness and gray color.)

**FORCE (F)**—The energy applied to an object that attempts to cause the object to change its direction, speed, or motion. In aerodynamics, it is expressed as F, T (thrust), L (lift), W (weight), or D (drag), usually in pounds.

**FOREIGN OBJECT DAMAGE (FOD)**—Damage to a gas turbine engine caused by some object being sucked into the engine while it is running. Debris from runways or taxiways can cause foreign object damage during ground operations, and the ingestion of ice and birds can cause FOD in flight.

**FRISE-TYPE AILERON**—Aileron having the nose portion projecting ahead of the hinge line. When the

trailing edge of the aileron moves up, the nose projects below the wing's lower surface and produces some parasite drag, decreasing the amount of adverse yaw.

**FRONT**—The boundary between two different air masses.

**FROST**—Ice crystal deposits formed by sublimation when temperature and dewpoint are below freezing.

**FUEL LOAD**—The expendable part of the load of the airplane. It includes only usable fuel, not fuel required to fill the lines or that which remains trapped in the tank sumps.

**FUSELAGE**—The section of the airplane that consists of the cabin and/or cockpit, containing seats for the occupants and the controls for the airplane.

**GIMBAL RING**—A type of support that allows an object, such as a gyroscope, to remain in an upright condition when its base is tilted.

**GPS (GLOBAL POSITIONING SYSTEM)**—A satellite-based radio positioning, navigation, and time-transfer system.

**GROUND ADJUSTABLE TRIM TAB**—Non-movable metal trim tab on a control surface. Bent in one direction or another while on the ground to apply trim forces to the control surface.

**GROUND EFFECT**—The condition of slightly increased air pressure below an airplane wing or helicopter rotor system that increases the amount of lift produced. It exists within approximately one wing span or one rotor diameter from the ground. It results from a reduction in upwash, downwash, and wingtip vortices, and provides a corresponding decrease in induced drag.

**GROUNDSPEED (GS)**—The actual speed of the airplane over the ground. It is true airspeed adjusted for wind. Groundspeed decreases with a headwind, and increases with a tailwind.

**GYROSCOPIC PRECESSION**—An inherent quality of rotating bodies, which causes an applied force to be manifested 90° in the direction of rotation from the point where the force is applied.

**HAZARDOUS ATTITUDES**—These can lead to poor decision making and actions that involve unnecessary risk. Pilots must examine decisions carefully to ensure they have not been influenced by hazardous attitudes.

**HAZARDOUS INFLIGHT WEATHER ADVISORY SERVICE (HIWAS)** — Continuous recorded hazardous inflight weather forecasts broadcasted to airborne pilots over selected VOR outlets defined as an HIWAS Broadcast Area.

**HEADING**—The direction in which the nose of the aircraft is pointing during flight.

**HEADING INDICATOR** — An instrument which senses airplane movement and displays heading based on a 360° azimuth, with the final zero omitted. The heading indicator, also called a directional gyro (DG), is fundamentally a mechanical instrument designed to facilitate the use of the magnetic compass. The heading indicator is not affected by the forces that make the magnetic compass difficult to interpret.

**HEADWORK** — Required to accomplish a conscious, rational thought process when making decisions. Good decision making involves risk identification and assessment, information processing, and problem solving.

**HIGH PERFORMANCE AIRCRAFT**—An aircraft with an engine of more than 200 horsepower.

**HISTOTOXIC HYPOXIA** — The inability of the cells to effectively use oxygen. Plenty of oxygen is being transported to the cells that need it, but they are unable to make use of it.

**HORSEPOWER**—The term, originated by inventor James Watt, means the amount of work a horse could do in one second. One horsepower equals 550 foot-pounds per second, or 33,000 foot-pounds per minute.

**HOT START**—In gas turbine engines, a start which occurs with normal engine rotation, but exhaust temperature exceeds prescribed limits. This is usually caused by an excessively rich mixture in the combustor. The fuel to the engine must be terminated immediately to prevent engine damage.

**HUMAN FACTORS**—The study of how people interact with their environments. In the case of general aviation, it is the study of how pilot performance is influenced by such issues as the design of cockpits, the function of the organs of the body, the effects of emotions, and the interaction and communication with the other participants of the aviation community, such as other crewmembers and air traffic control personnel.

**HUNG START**— In gas turbine engines, a condition of normal light off but with r.p.m. remaining at some low value rather than increasing to the normal idle r.p.m. This is often the result of insufficient power to the engine from the starter. In the event of a hung start, the engine should be shut down.

**HYDROPLANING**—A condition that exists when landing on a surface with standing water deeper than the tread depth of the tires. When the brakes are applied, there is a possibility that the brake will lock up and the tire will ride on the surface of the water, much like a water ski. When the tires are hydroplaning, directional control and braking action are virtually impossible. An effective anti-skid system can minimize the effects of hydroplaning.

**HYPEMIC HYPOXIA**—A type of hypoxia that is a result of oxygen deficiency in the blood, rather than a lack of inhaled oxygen. It can be caused by a variety of factors. Hypemic means “not enough blood.”

**HYPERVENTILATION**—Occurs when an individual is experiencing emotional stress, fright, or pain, and the breathing rate and depth increase, although the carbon dioxide level in the blood is already at a reduced level. The result is an excessive loss of carbon dioxide from the body, which can lead to unconsciousness due to the respiratory system's overriding mechanism to regain control of breathing.

**HYPOXIA**—Hypoxia means "reduced oxygen" or "not enough oxygen." Hypoxia can be caused by several factors including an insufficient supply of oxygen, inadequate transportation of oxygen, or the inability of the body tissues to use oxygen.

**HYPOXIC HYPOXIA**—This type of hypoxia is a result of insufficient oxygen available to the lungs. A decrease of oxygen molecules at sufficient pressure can lead to hypoxic hypoxia.

**IFR (INSTRUMENT FLIGHT RULES)**—Rules that govern the procedure for conducting flight in weather conditions below VFR weather minimums. The term IFR also is used to define weather conditions and the type of flight plan under which an aircraft is operating.

**ILS (INSTRUMENT LANDING SYSTEM)**—A precision instrument approach system, which normally consists of the following electronic components and visual aids—localizer, glide slope, outer marker, and approach lights.

**INCLINOMETER**—An instrument consisting of a curved glass tube, housing a glass ball, and damped with a fluid similar to kerosene. It may be used to indicate inclination, as a level, or, as used in the turn indicators, to show the relationship between gravity and centrifugal force in a turn.

**INDICATED AIRSPEED (IAS)**—The direct instrument reading obtained from the airspeed indicator, uncorrected for variations in atmos-

pheric density, installation error, or instrument error. Manufacturers use this airspeed as the basis for determining airplane performance. Takeoff, landing, and stall speeds listed in the AFM or POH are indicated airspeeds and do not normally vary with altitude or temperature.

**INDICATED ALTITUDE** — The altitude read directly from the altimeter (uncorrected) when it is set to the current altimeter setting.

**INDUCED DRAG**—That part of total drag which is created by the production of lift. Induced drag increases with a decrease in airspeed.

**INTERCOOLER**—A device used to reduce the temperatures of the compressed air before it enters the fuel metering device. The resulting cooler air has a higher density, which permits the engine to be operated with a higher power setting.

**INTERPOLATION**—The estimation of an intermediate value of a quantity that falls between marked values in a series. Example: In a measurement of length, with a rule that is marked in 1/8's of an inch, the value falls between 3/8 inch and 1/2 inch. The estimated (interpolated) value might then be said to be 7/16 inch.

**INVERSION**—An increase in temperature with altitude.

**ISA (INTERNATIONAL STANDARD ATMOSPHERE)**—Standard atmospheric conditions consisting of a temperature of 59°F (15°C), and a barometric pressure of 29.92 in. Hg. (1013.2 mb) at sea level. ISA values can be calculated for various altitudes using a standard lapse rate of approximately 2°C per 1,000 feet.

**ISOBARS**—Lines which connect points of equal barometric pressure.

**ISOGONIC LINES**—Lines on charts that connect points of equal magnetic variation.

**JETSTREAM**—A narrow band of wind with speeds of 100 to 200 m.p.h. usually co-located with the tropopause.

**JUDGMENT**—The mental process of recognizing and analyzing all pertinent information in a particular situation, a rational evaluation of alternative actions in response to it, and a timely decision on which action to take.

**LAND BREEZE**—A coastal breeze flowing from land to sea caused by temperature differences when the sea surface is warmer than the adjacent land. The land breeze usually occurs at night and alternates with the sea breeze that blows in the opposite direction by day.

**LATERAL AXIS**—An imaginary line passing through the center of gravity of an airplane and extending across the airplane from wingtip to wingtip.

**LATERAL STABILITY (ROLLING)**—The stability about the longitudinal axis of an aircraft. Rolling stability or the ability of an airplane to return to level flight due to a disturbance that causes one of the wings to drop.

**LATITUDE**—Measurement north or south of the equator in degrees, minutes, and seconds. Lines of latitude are also referred to as parallels.

**LEADING EDGE**—The part of an airfoil that meets the airflow first.

**LEADING EDGE DEVICES** — High lift devices which are found on the leading edge of the airfoil. The most common types are fixed slots, movable slats, and leading edge flaps.

**LEADING EDGE FLAP**—A portion of the leading edge of an airplane wing that folds downward to increase the camber, lift, and drag of the wing. The leading-edge flaps are extended for takeoffs and landings to increase the amount of aerodynamic lift that is produced at any given airspeed.

**LICENSED EMPTY WEIGHT**—The empty weight that consists of the airframe, engine(s), unusable fuel, and undrainable oil plus standard and optional equipment as specified in the equipment list. Some manufacturers used this term prior to GAMA standardization.

**LIFT**—One of the four main forces acting on an aircraft. On a fixed-wing aircraft, an upward force created by the effect of airflow as it passes over and under the wing.

**LIMIT LOAD FACTOR**—Amount of stress, or load factor, that an aircraft can withstand before structural damage or failure occurs.

**LOAD FACTOR**—The ratio of the load supported by the airplane's wings to the actual weight of the aircraft and its contents. Also referred to as G-loading.

**LONGITUDE**—Measurement east or west of the Prime Meridian in degrees, minutes, and seconds. The Prime Meridian is 0° longitude and runs through Greenwich, England. Lines of longitude are also referred to as meridians.

**LONGITUDINAL AXIS**—An imaginary line through an aircraft from nose to tail, passing through its center of gravity. The longitudinal axis is also called the roll axis of the aircraft. Movement of the ailerons rotates an airplane about its longitudinal axis.

**LONGITUDINAL STABILITY (PITCHING)**—Stability about the lateral axis. A desirable characteristic of an airplane whereby it tends to return to its trimmed angle of attack after displacement.

**LORAN-C**—A radio navigation system that utilizes master and slave stations transmitting timed pulses. The time difference in reception of pulses from several stations establishes a hyperbolic line of position, which can be identified on a LORAN chart. A fix in position is obtained by utilizing signals from two or more stations.

**MAGNETIC BEARING**—The magnetic course to go direct to an NDB station.

**MAGNETIC COMPASS**—A device for determining direction measured from magnetic north.

**MAGNETIC DIP**—A vertical attraction between a compass needle and the magnetic poles. The closer the aircraft is to the pole, the more severe the effect. In the Northern Hemisphere, a weight is placed on the south-facing end of the compass needle; in the Southern Hemisphere, a weight is placed on the north-facing end of the compass needle to somewhat compensate for this effect.

**MAGNETO**—A self-contained, engine-driven unit that supplies electrical current to the spark plugs; completely independent of the airplane's electrical system. Normally there are two magnetos per engine.

**MAGNUS EFFECT**—Lifting force produced when a rotating cylinder produces a pressure differential. This is the same effect that makes a baseball curve or a golf ball slice.

**MANEUVERABILITY**—Ability of an aircraft to change directions along a flightpath and withstand the stresses imposed upon it.

**MANEUVERING SPEED ( $V_A$ )**—The maximum speed where full, abrupt control movement can be used without overstressing the airframe.

**MANIFOLD ABSOLUTE PRESSURE (MAP)**—The absolute pressure of the fuel/air mixture within the intake manifold, usually indicated in inches of mercury.

**MASS**—The amount of matter in a body.

**MAXIMUM LANDING WEIGHT**—The greatest weight that an airplane normally is allowed to have at landing.

**MAXIMUM RAMP WEIGHT**—The total weight of a loaded aircraft, including all fuel. It is greater than the takeoff weight due to the fuel that will be burned during the taxi and runup operations. Ramp weight may also be referred to as taxi weight.

**MAXIMUM TAKEOFF WEIGHT**—The maximum allowable weight for takeoff.

**MAXIMUM WEIGHT**—The maximum authorized weight of the aircraft and all of its equipment as specified in the Type Certificate Data Sheets (TCDS) for the aircraft.

**MAXIMUM ZERO FUEL WEIGHT (GAMA)**—The maximum weight, exclusive of usable fuel.

**MEAN AERODYNAMIC CHORD (MAC)**—The average distance from the leading edge to the trailing edge of the wing.

**MERIDIANS**—Lines of longitude.

**MESOSPHERE**—A layer of the atmosphere directly above the stratosphere.

**METAR**—See AVIATION ROUTINE WEATHER REPORT.

**MICROBURST**—A strong downdraft which normally occurs over horizontal distances of 1 NM or less and vertical distances of less than 1,000 feet. In spite of its small horizontal scale, an intense microburst could induce windspeeds greater than 100 knots and downdrafts as strong as 6,000 feet per minute.

**MILITARY OPERATION AREAS (MOA)**—Airspace that consists of defined vertical and lateral limits established for the purpose of separating certain military training activity from IFR traffic. These are depicted on aeronautical charts.

**MILITARY TRAINING ROUTES (MTR)**—Routes developed to allow the military to conduct low-altitude, high-speed training. These routes are identified on sectional charts.



**MINIMUM DRAG**—The point on the total drag curve where the lift-to-drag ratio is the greatest. At this speed, total drag is minimized.

**MINIMUM EQUIPMENT LIST (MEL)**—A list developed for larger aircraft that outlines equipment that can be inoperative for various types of flight including IFR and icing conditions. This list is based on the master minimum equipment list (MMEL) developed by the FAA and must be approved by the FAA for use. It is specific to an individual aircraft make and model.

**MOMENT**—The product of the weight of an item multiplied by its arm. Moments are expressed in pound-inches (lb-in). Total moment is the weight of the airplane multiplied by the distance between the datum and the CG.

**MOMENT ARM**—The distance from a datum to the applied force.

**MOMENT INDEX (OR INDEX)**—A moment divided by a constant such as 100, 1,000, or 10,000. The purpose of using a moment index is to simplify weight and balance computations of airplanes where heavy items and long arms result in large, unmanageable numbers.

**MONOCOQUE**—A shell-like fuselage design in which the stressed outer skin is used to support the majority of imposed stresses. Monocoque fuselage design may include bulkheads but not stringers.

**MONOPLANES**—Airplanes with a single set of wings.

**MOVABLE SLAT**—A movable auxiliary airfoil on the leading edge of a wing. It is closed in normal flight but extends at high angles of attack. This allows air to continue flowing over the top of the wing and delays airflow separation.

**N<sub>1</sub>**—Rotational speed of the low pressure compressor in a turbine engine.

**N<sub>2</sub>**—Rotational speed of the high pressure compressor in a turbine engine.

**NACELLE**—A streamlined enclosure on an aircraft in which an engine is mounted. On multiengine propeller-driven airplanes, the nacelle is normally mounted on the leading edge of the wing.

**NATIONAL SECURITY AREAS**—Airspace that consists of defined vertical and lateral dimensions established at locations where there is a requirement for increased security and safety of ground facilities.

**NDB**—See NONDIRECTIONAL RADIO BEACON.

**NEGATIVE STATIC STABILITY**—The initial tendency of an aircraft to continue away from the original state of equilibrium after being disturbed.

**NEUTRAL STATIC STABILITY**—The initial tendency of an aircraft to remain in a new condition after its equilibrium has been disturbed.

**NONDIRECTIONAL RADIO BEACON (NDB)**—An L/MF or UHF radio beacon transmitting nondirectional signals whereby the pilot of an aircraft equipped with direction finding equipment can determine the bearing to or from the radio beacon and “home” on or track to or from the station. When the radio beacon is installed in conjunction with the Instrument Landing System marker, it is normally called a Compass Locator.

**NOTICES TO AIRMEN (NOTAM)**—A notice containing time-critical information that is either of a temporary nature or is not known far enough in advance to permit publication on aeronautical charts or other operation publications. This can include the establishment, condition, or change in any facility, service, procedure, or hazard in the National Airspace System.

**OBSTRUCTION LIGHTS**—Lights that can be found both on and off an airport to identify obstructions.

**OCCLUDED FRONT**—A frontal occlusion occurs when a fast-moving cold front catches up with a slow-moving warm front. The difference in temperature within each frontal system is a major factor in determining whether a cold or warm front occlusion occurs.

**OUTSIDE AIR TEMPERATURE (OAT)**—The measured or indicated air temperature (IAT) corrected for compression and friction heating. Also referred to as true air temperature.

**OVERBOOST**—A condition in which a reciprocating engine has exceeded the maximum manifold pressure allowed by the manufacturer. Can cause damage to engine components.

**PARALLELS**—Lines of latitude.

**PARASITE DRAG**—That part of total drag created by the form or shape of airplane parts. Parasite drag increases with an increase in airspeed.

**PAYLOAD (GAMA)**—The weight of occupants, cargo, and baggage.

**PERSONALITY**—The embodiment of personal traits and characteristics of an individual that are set at a very early age and extremely resistant to change.

**P-FACTOR**—A tendency for an aircraft to yaw to the left due to the descending propeller blade on the right producing more thrust than the ascending blade on the left. This occurs when the aircraft’s longitudinal axis is in a climbing attitude in relation to the relative wind. The P-factor would be to the right if the aircraft had a counterclockwise rotating propeller.

**PHUGOID OSCILLATIONS**—Long-period oscillations of an aircraft around its lateral axis. It is a slow change in pitch accompanied by equally slow changes in airspeed. Angle of attack remains constant, and the pilot often corrects for phugoid oscillations without even being aware of them.

**PILOTAGE**—Navigation by visual reference to landmarks.

**PILOT'S OPERATING HANDBOOK (POH)**—A document developed by the airplane manufacturer and contains the FAA-approved Airplane Flight Manual (AFM) information.

**PILOT WEATHER REPORT (PIREP)**—A report, generated by pilots, concerning meteorological phenomena encountered in flight.

**PLANFORM**—The shape or form of a wing as viewed from above. It may be long and tapered, short and rectangular, or various other shapes.

**PNEUMATIC**—Operation by the use of compressed air.

**POOR JUDGMENT CHAIN**—A series of mistakes that may lead to an accident or incident. Two basic principles generally associated with the creation of a poor judgment chain are: (1) One bad decision often leads to another; and (2) as a string of bad decisions grows, it reduces the number of subsequent alternatives for continued safe flight. ADM is intended to break the poor judgment chain before it can cause an accident or incident.

**POSITIVE STATIC STABILITY**—The initial tendency to return to a state of equilibrium when disturbed from that state.

**POWER**—Implies work rate or units of work per unit of time, and as such, it is a function of the speed at which the force is developed. The term, power required, is generally associated with reciprocating engines.

**POWERPLANT**—A complete engine and propeller combination with accessories.

**PRECESSION**—The tilting or turning of a gyro in response to deflective forces causing slow drifting and erroneous indications in gyroscopic instruments.

**PRECIPITATION**—Any or all forms of water particles (rain, sleet, hail, or snow), that fall from the atmosphere and reach the surface.

**PREIGNITION**—Ignition occurring in the cylinder before the time of normal ignition. Preignition is often caused by a local hot spot in the combustion chamber igniting the fuel-air mixture.

**PRESSURE ALTITUDE**—The altitude indicated when the altimeter setting window (barometric scale) is adjusted to 29.92. This is the altitude above the standard datum plane, which is a theoretical plane where air pressure (corrected to 15°C) equals 29.92 in. Hg. Pressure altitude is used to compute density altitude, true altitude, true airspeed, and other performance data.

**PRESSURE DEMAND OXYGEN SYSTEM**—A demand oxygen system that supplies 100 percent oxygen at sufficient pressure above the altitude where normal breathing is adequate. Also referred to as a pressure breathing system.

**PREVENTIVE MAINTENANCE**—Simple or minor preservative operations and the replacement of small standard parts not involving complex assembly operation as listed in Appendix A of 14 CFR part 43. Certificated pilots may perform preventive maintenance on any aircraft that is owned or operated by them provided that the aircraft is not used in air carrier service.

**PROHIBITED AREAS**—Areas that are established for security or other reasons associated with the national welfare.

**PROPELLER**—A device for propelling an aircraft that, when rotated, produces by its action on the air, a thrust approximately perpendicular to its plane of rotation. It includes the control components normally supplied by its manufacturer.

**RADAR SERVICES**—Radar is a method whereby radio waves are transmitted into the air and are then received when they have been

reflected by an object in the path of the beam. Range is determined by measuring the time it takes (at the speed of light) for the radio wave to go out to the object and then return to the receiving antenna. The direction of a detected object from a radar site is determined by the position of the rotating antenna when the reflected portion of the radio wave is received.

**RADAR SUMMARY CHART**—A weather product derived from the national radar network that graphically displays a summary of radar weather reports.

**RADAR WEATHER REPORT (SD)**—A report issued by radar stations at 35 minutes after the hour, and special reports as needed. Provides information on the type, intensity, and location of the echo tops of the precipitation.

**RADIOSONDE**—A weather instrument that observes and reports meteorological conditions from the upper atmosphere. This instrument is typically carried into the atmosphere by some form of weather balloon.

**RAM RECOVERY**—The increase in thrust as a result of ram air pressures and density on the front of the engine caused by air velocity.

**RAPID DECOMPRESSION**—The almost instantaneous loss of cabin pressure in aircraft with a pressurized cockpit or cabin.

**REGION OF REVERSE COMMAND**—Flight regime in which flight at a higher airspeed requires a lower power setting and a lower airspeed requires a higher power setting in order to maintain altitude.

**RELATIVE BEARING**—An angular relationship between two objects measured in degrees clockwise from the twelve o'clock position of the first object.

**RELATIVE HUMIDITY** — The ratio of the existing amount of water vapor in the air at a given temperature to the maximum amount that could exist at that temperature; usually expressed in percent.

**RELATIVE WIND**—The direction of the airflow with respect to the wing. If a wing moves forward horizontally, the relative wind moves backward horizontally. Relative wind is parallel to and opposite the flightpath of the airplane.

**RESTRICTED AREAS**—Areas that denote the existence of unusual, often invisible hazards to aircraft such as artillery firing, aerial gunnery, or guided missiles. An aircraft may not enter a restricted area unless permission has been obtained from the controlling agency.

**RIGGING**—The final adjustment and alignment of an aircraft and its flight control system that provides the proper aerodynamic characteristics.

**RIGIDITY IN SPACE**—The principle that a wheel with a heavily weighted rim spun rapidly will remain in a fixed position in the plane in which it is spinning.

**RISK ELEMENTS**—There are four fundamental risk elements: the pilot, the aircraft, the environment, and the type of operation that comprise any given aviation situation.

**RISK MANAGEMENT**—The part of the decision making process which relies on situational awareness, problem recognition, and good judgment to reduce risks associated with each flight.

**RNAV**—See AREA NAVIGATION.

**RUDDER**—The movable primary control surface mounted on the trailing edge of the vertical fin of an airplane. Movement of the rudder rotates the airplane about its vertical axis.

**RUDDERVATOR**—A pair of control surfaces on the tail of an aircraft arranged in the form of a V. These surfaces, when moved together by the control wheel, serve as elevators, and when moved differentially by the rudder pedals, serve as a rudder.

**RUNWAY CENTERLINE LIGHTS**—Runway lighting which consists of flush centerline lights

spaced at 50-foot intervals beginning 75 feet from the landing threshold.

**RUNWAY EDGE LIGHTS**—A component of the runway lighting system that is used to outline the edges of runways at night or during low visibility conditions. These lights are classified according to the intensity they are capable of producing.

**RUNWAY END IDENTIFIER LIGHTS (REIL)**—One component of the runway lighting system. These lights are installed at many airfields to provide rapid and positive identification of the approach end of a particular runway.

**SEA BREEZE**—A coastal breeze blowing from sea to land caused by the temperature difference when the land surface is warmer than the sea surface. The sea breeze usually occurs during the day and alternates with the land breeze that blows in the opposite direction at night.

**SEA-LEVEL ENGINE**—A reciprocating aircraft engine having a rated takeoff power that is producible only at sea level.

**SECTIONAL AERONAUTICAL CHARTS (1:500,000)**—Designed for visual navigation of slow or medium speed aircraft. Topographic information on these charts features the portrayal of relief, and a judicious selection of visual check points for VFR flight. Aeronautical information includes visual and radio aids to navigation, airports, controlled airspace, restricted areas, obstructions and related data.

**SEMI-MONOCOQUE**—A fuselage design that includes a substructure of bulkheads and/or formers, along with stringers, to support flight loads and stresses imposed on the fuselage.

**SERVICE CEILING**—The maximum density altitude where the best rate-of-climb airspeed will produce a 100 feet-per-minute climb at maximum weight while in a clean configuration with maximum continuous power.

**SERVO**—A motor or other form of actuator which receives a small signal from the control device and exerts a large force to accomplish the desired work.

**SERVO TAB**—An auxiliary control mounted on a primary control surface, which automatically moves in the direction opposite the primary control to provide an aerodynamic assist in the movement of the control.

**SIGMET**—An in-flight weather advisory that is considered significant to all aircraft. SIGMET criteria include severe icing, severe and extreme turbulence, duststorms, sandstorms, volcanic eruptions, and volcanic ash that lower visibility to less than 3 miles.

**SIGNIFICANT WEATHER PROGNOSTIC CHART**—Presents four panels showing forecast significant weather and forecast surface weather.

**SITUATIONAL AWARENESS**—The accurate perception and understanding of all the factors and conditions within the four fundamental risk elements that affect safety before, during, and after the flight.

**SKILLS AND PROCEDURES**—The procedural, psychomotor, and perceptual skills used to control a specific aircraft or its systems. They are the airmanship abilities that are gained through conventional training, are perfected, and become almost automatic through experience.

**SPATIAL DISORIENTATION**—Specifically refers to the lack of orientation with regard to the position, attitude, or movement of the airplane in space.

**SPECIAL FLIGHT PERMIT**—A flight permit issued to an aircraft that does not meet airworthiness requirements but is capable of safe flight. A special flight permit can be issued to move an aircraft for the purposes of maintenance or repair, buyer delivery, manufacturer flight tests, evacuation from danger, or customer demonstration. Also referred to as a ferry permit.

**SPECIAL USE AIRSPACE**—Airspace that exists where activities must be confined because of their nature.

**SPECIFIC FUEL CONSUMPTION**—The amount of fuel in pounds per hour consumed or required by an engine per brake horsepower or per pound of thrust.

**SPEED**—The distance traveled in a given time.

**SPIN**—An aggravated stall that results in an airplane descending in a helical, or corkscrew path.

**SPIRAL INSTABILITY**—A condition that exists when the static directional stability of the airplane is very strong as compared to the effect of its dihedral in maintaining lateral equilibrium.

**SPIRALING SLIPSTREAM**—The slipstream of a propeller-driven airplane rotates around the airplane. This slipstream strikes the left side of the vertical fin, causing the aircraft to yaw slightly. Rudder offset is sometimes used by aircraft designers to counteract this tendency.

**SPOILERS**—High-drag devices that can be raised into the air flowing over an airfoil, reducing lift and increasing drag. Spoilers are used for roll control on some aircraft. Deploying spoilers on both wings at the same time allows the aircraft to descend without gaining speed. Spoilers are also used to shorten the ground roll after landing.

**STABILATOR**—A single-piece horizontal tail surface on an airplane that pivots around a central hinge point. A stabilator serves the purposes of both the horizontal stabilizer and the elevators.

**STABILITY**—The inherent quality of an airplane to correct for conditions that may disturb its equilibrium, and to return or to continue on the original flightpath. It is primarily an airplane design characteristic.

**STAGNANT HYPOXIA**—A type of hypoxia that results when the oxygen-rich blood in the lungs isn't moving,

for one reason or another, to the tissues that need it.

**STALL**—A rapid decrease in lift caused by the separation of airflow from the wing's surface brought on by exceeding the critical angle of attack. A stall can occur at any pitch attitude or airspeed.

**STANDARD ATMOSPHERE**—At sea level, the standard atmosphere consists of a barometric pressure of 29.92 inches of mercury (in. Hg.) or 1013.2 millibars, and a temperature of 15°C (59°F). Pressure and temperature normally decrease as altitude increases. The standard lapse rate in the lower atmosphere for each 1,000 feet of altitude is approximately 1 in. Hg. and 2°C (3.5°F). For example, the standard pressure and temperature at 3,000 feet mean sea level (MSL) is 26.92 in. Hg. (29.92 - 3) and 9°C (15°C - 6°C).

**STANDARD EMPTY WEIGHT (GAMA)**—This weight consists of the airframe, engines, and all items of operating equipment that have fixed locations and are permanently installed in the airplane; including fixed ballast, hydraulic fluid, unusable fuel, and full engine oil.

**STANDARD-RATE-TURN**—A turn at the rate of 3° per second which enables the airplane to complete a 360° turn in 2 minutes.

**STANDARD WEIGHTS**—These have been established for numerous items involved in weight and balance computations. These weights should not be used if actual weights are available.

**STATIC STABILITY**—The initial tendency an aircraft displays when disturbed from a state of equilibrium.

**STATION**—A location in the airplane that is identified by a number designating its distance in inches from the datum. The datum is, therefore, identified as station zero. An item located at station +50 would have an arm of 50 inches.

**STATIONARY FRONT**—A front that is moving at a speed of less than 5 knots.

**STRATOSPHERE**—A layer of the atmosphere above the tropopause extending to a height of approximately 160,000 feet.

**STRESS MANAGEMENT**—The personal analysis of the kinds of stress experienced while flying, the application of appropriate stress assessment tools, and other coping mechanisms.

**SUBLIMATION**—Process by which a solid is changed to a gas without going through the liquid state.

**SUPERCHARGER**—An engine- or exhaust-driven air compressor used to provide additional pressure to the induction air so the engine can produce additional power.

**SUPERCOOLED WATER DROPLETS**—Water droplets that have been cooled below the freezing point, but are still in a liquid state.

**SURFACE ANALYSIS CHART**—A report that depicts an analysis of the current surface weather. Shows the areas of high and low pressure, fronts, temperatures, dewpoints, wind directions and speeds, local weather, and visual obstructions.

**TAKEOFF DISTANCE** — The distance required to complete an all-engines operative takeoff to the 35-foot height. It must be at least 15 percent less than the distance required for a one-engine inoperative engine takeoff. This distance is not normally a limiting factor as it is usually less than the one-engine inoperative takeoff distance.

**TAXIWAY LIGHTS**—Omnidirectional lights that outline the edges of the taxiway and are blue in color.

**TAXIWAY TURNOFF LIGHTS**—Flush lights which emit a steady green color.

## **TELEPHONE INFORMATION BRIEFING SERVICE**

**(TIBS)**—Telephone recording of area and/or route meteorological briefings, airspace procedures, and special aviation-oriented announcements.

## **TERMINAL AERODROME**

**FORECAST (TAF)**—A report established for the 5 statute mile radius around an airport. Utilizes the same descriptors and abbreviations as the METAR report.

## **TERMINAL RADAR SERVICE AREAS (TRSA)**

—Areas where participating pilots can receive additional radar services. The purpose of the service is to provide separation between all IFR operations and participating VFR aircraft.

**THERMOSPHERE**—The last layer of the atmosphere that begins above the mesosphere and gradually fades away into space.

**THRUST**—The force which imparts a change in the velocity of a mass. This force is measured in pounds but has no element of time or rate. The term, thrust required, is generally associated with jet engines. A forward force which propels the airplane through the air.

**THRUST LINE**—An imaginary line passing through the center of the propeller hub, perpendicular to the plane of the propeller rotation.

**TORQUE**—**1.** A resistance to turning or twisting. **2.** Forces that produce a twisting or rotating motion. **3.** In an airplane, the tendency of the aircraft to turn (roll) in the opposite direction of rotation of the engine and propeller. **4.** In helicopters with a single, main rotor system, the tendency of the helicopter to turn in the opposite direction of the main rotor rotation.

**TORQUEMETER**—An instrument used with some of the larger reciprocating engines and turboprop or turboshaft engines to measure the reaction between the propeller reduction gears and the engine case.

**TOTAL DRAG**—The sum of the parasite and induced drag.

## **TOUCHDOWN ZONE LIGHTS**

—Two rows of transverse light bars disposed symmetrically about the runway centerline in the runway touchdown zone.

**TRACK**—The actual path made over the ground in flight.

**TRAILING EDGE**—The portion of the airfoil where the airflow over the upper surface rejoins the lower surface airflow.

## **TRANSCRIBED WEATHER**

**BROADCAST (TWEB)**—A continuous recording of weather and aeronautical information broadcast over selected NDB or VOR stations.

**TRANSPONDER**—The airborne portion of the secondary surveillance radar system.

**TRICYCLE GEAR**—Landing gear employing a third wheel located on the nose of the aircraft.

**TRIM TAB**—A small auxiliary hinged portion of a movable control surface that can be adjusted during flight to a position resulting in a balance of control forces.

**TROPOPAUSE**—The boundary layer between the troposphere and the mesosphere which acts as a lid to confine most of the water vapor, and the associated weather, to the troposphere.

**TROPOSPHERE**—The layer of the atmosphere extending from the surface to a height of 20,000 to 60,000 feet depending on latitude.

## **TRUE AIRSPEED (TAS)**

—Calibrated airspeed corrected for altitude and nonstandard temperature. Because air density decreases with an increase in altitude, an airplane has to be flown faster at higher altitudes to cause the same pressure difference between pitot impact pressure and static pressure. Therefore, for a given

calibrated airspeed, true airspeed increases as altitude increases; or for a given true airspeed, calibrated airspeed decreases as altitude increases.

**TRUE ALTITUDE**—The vertical distance of the airplane above sea level—the actual altitude. It is often expressed as feet above mean sea level (MSL). Airport, terrain, and obstacle elevations on aeronautical charts are true altitudes.

**TRUSS**—A fuselage design made up of supporting structural members that resist deformation by applied loads. The truss-type fuselage is constructed of steel or aluminum tubing. Strength and rigidity is achieved by welding the tubing together into a series of triangular shapes, called trusses.

**T-TAIL**—An aircraft with the horizontal stabilizer mounted on the top of the vertical stabilizer, forming a T.

## **TURBINE DISCHARGE**

**PRESSURE**—The total pressure at the discharge of the low-pressure turbine in a dual-turbine axial-flow engine.

**TURBINE ENGINE**—An aircraft engine which consists of an air compressor, a combustion section, and a turbine. Thrust is produced by increasing the velocity of the air flowing through the engine.

**TURBOCHARGER**—An air compressor driven by exhaust gases, which increases the pressure of the air going into the engine through the carburetor or fuel injection system.

**TURBOFAN ENGINE**—A fanlike turbojet engine designed to create additional thrust by diverting a secondary airflow around the combustion chamber.

**TURBOJET ENGINE**—A turbine engine which produces its thrust entirely by accelerating the air through the engine.

**TURBOPROP ENGINE**—A turbine engine which drives a propeller through a reduction gearing arrangement. Most of the energy in the

exhaust gases is converted into torque, rather than using its acceleration to drive the aircraft.

**TURBOSHAFT ENGINE**—A gas turbine engine that delivers power through a shaft to operate something other than a propeller.

**TURN-AND-SLIP INDICATOR**—A flight instrument consisting of a rate gyro to indicate the rate of yaw and a curved glass inclinometer to indicate the relationship between gravity and centrifugal force. The turn-and-slip indicator indicates the relationship between angle of bank and rate of yaw. Also called a turn-and-bank indicator.

**TURN COORDINATOR**—A rate gyro that senses both roll and yaw due to the gimbal being canted. Has largely replaced the turn-and-slip indicator in modern aircraft.

**TURNING ERROR**—One of the errors inherent in a magnetic compass caused by the dip compensating weight. It shows up only on turns to or from northerly headings in the Northern Hemisphere and southerly headings in the Southern Hemisphere. Turning error causes the compass to lead turns to the north or south and lag turns away from the north or south.

**ULTIMATE LOAD FACTOR**—In stress analysis, the load that causes physical breakdown in an aircraft or aircraft component during a strength test, or the load that according to computations, should cause such a breakdown.

**UNCONTROLLED AIRPORT**—An airport that does not have an operating control tower. Two-way radio communications are not required at uncontrolled airports, although it is good operating practice for pilots to transmit their intentions on the specified frequency.

**UNCONTROLLED AIRSPACE**—Class G airspace that has not been designated as Class A, B, C, D, or E. It is airspace in which air traffic control has no authority or responsibility to control air traffic; however, pilots

should remember there are VFR minimums which apply to this airspace.

**USEFUL LOAD**—The weight of the pilot, copilot, passengers, baggage, usable fuel, and drainable oil. It is the basic empty weight subtracted from the maximum allowable gross weight. This term applies to general aviation aircraft only.

**V<sub>A</sub>**—The design maneuvering speed. This is the “rough air” speed and the maximum speed for abrupt maneuvers. If during flight, rough air or severe turbulence is encountered, reduce the airspeed to maneuvering speed or less to minimize stress on the airplane structure. It is important to consider weight when referencing this speed. For example, V<sub>A</sub> may be 100 knots when an airplane is heavily loaded, but only 90 knots when the load is light.

**VAPOR LOCK**—A condition in which air enters the fuel system and it may be difficult, or impossible, to restart the engine. Vapor lock may occur as a result of running a fuel tank completely dry, allowing air to enter the fuel system. On fuel-injected engines, the fuel may become so hot it vaporizes in the fuel line, not allowing fuel to reach the cylinders.

**VARIATION**—The angular difference between the true, or geographic, poles and the magnetic poles at a given point. The compass magnet is aligned with the magnetic poles, while aeronautical charts are oriented to the geographic poles. This variation must be taken into consideration when determining an aircraft’s actual geographic location. Indicated on charts by isogonic lines, it is not affected by the airplane’s heading.

**VECTOR**—A force vector is a graphic representation of a force and shows both the magnitude and direction of the force.

**VELOCITY**—The speed or rate of movement in a certain direction.

**VERTICAL AXIS**—An imaginary line passing vertically through the center of gravity of an aircraft. The

vertical axis is called the z-axis or the yaw axis.

**VERTICAL CARD COMPASS**—A magnetic compass that consists of an azimuth on a vertical card, resembling a heading indicator with a fixed miniature airplane to accurately present the heading of the aircraft. The design uses eddy current damping to minimize lead and lag during turns.

**VERTICAL SPEED INDICATOR**—An instrument that uses static pressure to display a rate of climb or descent in feet per minute. The VSI can also sometimes be called a vertical velocity indicator (VVI).

**VERTICAL STABILITY**—Stability about an aircraft’s vertical axis. Also called yawing or directional stability.

**VERY HIGH FREQUENCY (VHF) OMNIDIRECTIONAL RANGE (VOR)**—A ground-based electronic navigation aid transmitting very high frequency navigation signals, 360 degrees in azimuth, oriented from magnetic north. Used as the basis for navigation in the National Airspace System. The VOR periodically identifies itself by Morse Code and can have an additional voice identification feature. Voice features can be used by ATC or FSS for transmitting instructions/ information to pilots.

**V<sub>FE</sub>**—The maximum speed with the flaps extended. The upper limit of the white arc.

**VFR TERMINAL AREA CHARTS (1:250,000)**—Depict Class B airspace which provides for the control or segregation of all the aircraft within the Class B airspace. The chart depicts topographic information and aeronautical information which includes visual and radio aids to navigation, airports, controlled airspace, restricted areas, obstructions, and related data.

**V-G DIAGRAM**—A chart that relates velocity to load factor. It is valid only for a specific weight, configuration and altitude and shows the maximum amount of positive or

negative lift the airplane is capable of generating at a given speed. Also shows the safe load factor limits and the load factor that the aircraft can sustain at various speeds.

**VISUAL APPROACH SLOPE INDICATOR (VASI)**—The most common visual glidepath system in use. The VASI provides obstruction clearance within 10° of the extended runway centerline, and to 4 nautical miles (NM) from the runway threshold.

**V<sub>LE</sub>**—Landing gear extended speed. The maximum speed at which an airplane can be safely flown with the landing gear extended.

**V<sub>LO</sub>**—Landing gear operating speed. The maximum speed for extending or retracting the landing gear if using an airplane equipped with retractable landing gear.

**V<sub>MC</sub>**—Minimum control airspeed. This is the minimum flight speed at which a light, twin-engine airplane can be satisfactorily controlled when an engine suddenly becomes inoperative and the remaining engine is at takeoff power.

**V<sub>NE</sub>**—The never-exceed speed. Operating above this speed is prohibited since it may result in damage or structural failure. The red line on the airspeed indicator.

**V<sub>NO</sub>**—The maximum structural cruising speed. Do not exceed this speed except in smooth air. The upper limit of the green arc.

**VOR**—See VERY HIGH FREQUENCY (VHF) OMNIDIRECTIONAL RANGE.

**V<sub>S0</sub>**—The stalling speed or the minimum steady flight speed in the landing configuration. In small airplanes, this is the power-off stall speed at the maximum landing weight in the landing configuration (gear and flaps down). The lower limit of the white arc.

**V<sub>SI</sub>**—The stalling speed or the minimum steady flight speed obtained in a

specified configuration. For most airplanes, this is the power-off stall speed at the maximum takeoff weight in the clean configuration (gear up, if retractable, and flaps up). The lower limit of the green arc.

**V-TAIL**—A design which utilizes two slanted tail surfaces to perform the same functions as the surfaces of a conventional elevator and rudder configuration. The fixed surfaces act as both horizontal and vertical stabilizers.

**V<sub>X</sub>**—Best angle-of-climb speed. The airspeed at which an airplane gains the greatest amount of altitude in a given distance. It is used during a short-field takeoff to clear an obstacle.

**V<sub>Y</sub>**—Best rate-of-climb speed. This airspeed provides the most altitude gain in a given period of time.

**V<sub>YSE</sub>**—Best rate of climb speed with one engine inoperative. This airspeed provides the most altitude gain in a given period of time in a light, twin-engine airplane following an engine failure.

**WAKE TURBULENCE**—Wingtip vortices that are created when an airplane generates lift. When an airplane generates lift, air spills over the wingtips from the high pressure areas below the wings to the low pressure areas above them. This flow causes rapidly rotating whirlpools of air called wingtip vortices or wake turbulence.

**WARM FRONT**—The boundary area formed when a warm air mass contacts and flows over a colder air mass. Warm fronts cause low ceilings and rain.

**WARNING AREAS**—Areas that may contain hazards to nonparticipating aircraft in international airspace. These areas are depicted on aeronautical charts.

**WASTE GATE**—A controllable valve in the tailpipe of an aircraft reciprocating engine equipped with a turbocharger. The valve is controlled

to vary the amount of exhaust gases forced through the turbocharger turbine.

## WEATHER DEPICTION

**CHART**—Details surface conditions as derived from METAR and other surface observations.

**WEIGHT**—A measure of the heaviness of an object. The force by which a body is attracted toward the center of the Earth (or another celestial body) by gravity. Weight is equal to the mass of the body times the local value of gravitational acceleration. One of the four main forces acting on an aircraft. Equivalent to the actual weight of the aircraft. It acts downward through the aircraft's center of gravity toward the center of the Earth. Weight opposes lift.

**WIND CORRECTION ANGLE**—Correction applied to the course to establish a heading so that track will coincide with course.

**WIND DIRECTION INDICATORS**—Indicators that include a wind sock, wind tee, or tetrahedron. Visual reference will determine wind direction and runway in use.

**WIND SHEAR**—A sudden, drastic shift in windspeed, direction, or both that may occur in the horizontal or vertical plane.

**WINDS AND TEMPERATURE ALOFT FORECAST (FD)**—A twice daily forecast that provides wind and temperature forecasts for specific locations in the contiguous United States.

**WING AREA**—The total surface of the wing (square feet), which includes control surfaces and may include wing area covered by the fuselage (main body of the airplane), and engine nacelles.

**WINGS**—Airfoils attached to each side of the fuselage and are the main lifting surfaces that support the airplane in flight.

**WING SPAN**—The maximum distance from wingtip to wingtip.

**WINGTIP VORTICES**—The rapidly rotating air that spills over an airplane's wings during flight. The intensity of the turbulence depends on the airplane's weight, speed, and configuration. Also referred to as wake turbulence. Vortices from heavy aircraft may be extremely hazardous to small aircraft.

**WING TWIST**—A design feature incorporated into some wings to

improve aileron control effectiveness at high angles of attack during an approach to a stall.

**WORK**—The product of force and the distance through which the force acts. Usually expressed in foot-pounds.

**WORLD AERONAUTICAL CHARTS (WAC) (1:1,000,000)**—Provide a standard series of aeronautical charts covering land areas of the world at a size and scale convenient for navi-

gation by moderate speed aircraft. Topographic information includes cities and towns, principal roads, railroads, distinctive landmarks, drainage, and relief. Aeronautical information includes visual and radio aids to navigation, airports, airways, restricted areas, obstructions and other pertinent data.

**ZULU TIME**—A term used in aviation for coordinated universal time (UTC) which places the entire world on one time standard.







# Index

100-HOUR INSPECTION 7-7

## A

ABBREVIATED WEATHER BRIEFING 11-4

ABSOLUTE ALTITUDE 6-4

ACCELERATE-GO DISTANCE 9-32

ACCELERATE-STOP DISTANCE 9-32

ADF 14-22

ADIABATIC COOLING 10-12

ADIABATIC HEATING 10-12

ADJUSTABLE-PITCH PROPELLER 5-4

ADVERSE YAW 4-2

AERODYNAMIC FORCES IN FLIGHT

MANEUVERS 3-17

climbs 3-19

descents 3-19

turns 3-17

AERONAUTICAL DECISION MAKING 16-1

origins 16-2

process 16-2

factors 16-5

AILERONS 4-1

differential 4-2

coupled with rudder 4-3

Frise-type 4-2

AIR CARRIER OBSTACLE CLIMB

REQUIREMENTS 9-36

AIR DENSITY 2-2

AIR MASSES 10-18

AIR TRAFFIC CONTROL RADAR BEACON

SYSTEM 12-11

AIR TRAFFIC CONTROL SERVICES 12-10

AIRCRAFT 1-1

AIRCRAFT MAINTENANCE 7-7

AIRCRAFT REGISTRATION 7-5

AIRFOIL 1-3, 2-4

camber 2-4

chord line 2-4

ice controls 5-28

laminar flow 2-5

leading edge 2-4

pressure distribution 2-6

trailing edge 2-4

AIRMAN'S METEOROLOGICAL  
INFORMATION 11-12

AIRMET 11-3, 11-12

AIRPLANE 1-1

AIRPLANE FLIGHT MANUAL 7-1

use of 14-13

AIRPORT ADVISORY AREA 13-4

AIRPORT BEACON 12-5

AIRPORT FACILITY DIRECTORY 12-1

use of 14-13

AIRPORT LIGHTING 12-5

control of 12-7

AIRPORT MARKINGS 12-3

runway 12-3

taxiway 12-3

AIRPORT SIGNS 12-3

AIRPORTS

controlled 12-1

uncontrolled 12-1

AIRSPACE

Class A 13-1

Class B 13-1

Class C 13-1

Class D 13-3

Class E 13-3

Class G 13-3

- controlled 13-1
- uncontrolled 13-3
- AIRSPPEED**
  - calibrated 6-6
  - groundspeed 6-6
  - indicated 6-6
  - limitations 6-7
  - true 6-6
- AIRSPPEED EQUIVALENT** 9-18
- AIRSPPEED INDICATOR** 6-6
  - markings 6-6
- AIRWORTHINESS CERTIFICATE** 7-6
- AIRWORTHINESS DIRECTIVES** 7-10
- ALCOHOL** 15-8
- ALERT AREA** 13-4
- ALTIMETER** 6-2
  - operation 6-4
  - setting 6-3
- ALTIMETER SYSTEM INSPECTION** 7-8
- ALTITUDE**
  - absolute 6-4
  - density 6-5
  - indicated 6-4
  - pressure 6-4
  - true 6-4
- AMMETER** 5-20
- ANNUAL INSPECTION** 7-7
- ANTISERVO TAB** 1-4, 4-8
- APPROACH LIGHT SYSTEMS** 12-6
- AREA FORECAST** 11-10
- ARM** 8-3
- ASOS** 11-1
- ASYMMETRIC LOADING** 3-25
- ATIS** 6-3
- ATMOSPHERE** 10-1
- ATMOSPHERIC CIRCULATION** 10-5
- ATMOSPHERIC PRESSURE** 2-2, 9-1, 10-3
  - effect of differences in air density 10-5
  - effect on altitude 10-4
- ATMOSPHERIC STABILITY** 10-12
- ATTITUDE INDICATOR** 6-12
- AUTOKINESIS** 15-11
- AUTOMATED SURFACE OBSERVING SYSTEM** 11-1
- AUTOMATED WEATHER OBSERVING SYSTEM** 11-1
- AUTOMATIC DIRECTION FINDER** 14-22
- AUTOMATIC TERMINAL INFORMATION SERVICE** 6-3
- AUTOPILOT** 5-23
- AVIATION ROUTINE WEATHER REPORT** 11-4
- AWOS** 11-1
- AXES OF AN AIRPLANE** 3-8

## B

- BALANCE** 8-2
  - adverse effects 8-2

- BALANCE TABS** 4-8
- BALANCED FIELD LENGTH** 9-32
- BASIC EMPTY WEIGHT** 8-3
- BEACON** 12-5
- BERNOULLI'S PRINCIPLE** 2-3
- BIPLANE** 1-3
- BOUNDARY LAYER** 3-36
- BRAKE HORSEPOWER** 5-31, 9-10
- BRAKE SPECIFIC FUEL CONSUMPTION** 9-10
- BRAKES** 5-23
- BUS BAR** 5-20

## C

- CALIBRATED AIRSPEED (CAS)** 6-6
- CANARD** 4-5
- CARBON MONOXIDE POISONING** 15-6
- CARBURETOR** 5-5
  - air temperature gauge 5-8
  - heat 5-7
  - icing 5-6
- CEILING** 10-17
- CENTER OF GRAVITY (CG)** 2-7, 8-2, 8-3
  - determination 8-6
  - limits 8-4
  - range 8-4
- CENTER OF LIFT** 2-7
- CENTER OF PRESSURE** 2-7
- CENTRIFUGAL FORCE** 3-17
- CENTRIPETAL FORCE** 3-17
- CHANDELLES** 3-30
- CHARTING A COURSE** 14-14
- CIRCULAR ARC AIRFOIL** 2-5
- CLASS A AIRSPACE** 13-1
- CLASS B AIRSPACE** 13-1
- CLASS C AIRSPACE** 13-1
- CLASS D AIRSPACE** 13-3
- CLASS E AIRSPACE** 13-3
- CLASS G AIRSPACE** 13-3
- CLEARING PROCEDURES** 12-14
- CLIMB PERFORMANCE** 9-6
- CLIMB REQUIREMENTS, TRANSPORT CATEGORY**
  - first segment 9-35
  - fourth or final segment 9-35
  - second segment 9-35
  - second segment climb limitations 9-35
  - third or acceleration segment 9-35
- CLOUDS** 10-15
- COLD FRONT** 10-20
- COLLISION AVOIDANCE** 12-14
- COMBUSTION** 5-12
- COMPASS ERRORS**
  - acceleration/deceleration 6-16
  - deviation 6-16, 14-5, 14-12
  - magnetic dip 6-16
  - turning 6-16
  - variation 6-15
- COMPASS HEADING** 14-12

COMPRESSOR STALL 5-33  
CONDENSATION 10-13  
    nuclei 10-15  
CONTINUOUS FLOW OXYGEN SYSTEMS 5-27  
CONTROLLED AIRPORT 12-1  
CONTROLLED AIRSPACE 13-1  
CONTROLLED FIRING AREA 13-4  
CONVECTIVE CURRENTS 10-7  
CONVECTIVE SIGMET 11-3  
CONVECTIVE SIGNIFICANT METEOROLOGICAL  
    INFORMATION 11-12  
CONVENTIONAL GEAR 1-4  
COOLING SYSTEMS 5-18  
CORKSCREW EFFECT 3-24  
CREW RESOURCE MANAGEMENT 16-1  
CRM 16-1

## D

DATUM 8-4  
DEAD RECKONING 14-10  
DECIDE MODEL 16-4  
DECISION-MAKING  
    process 16-2  
    resources 16-7  
DEHYDRATION 15-7  
DENSITY ALTITUDE 6-5, 9-3  
DEPOSITION 10-13  
DETONATION 5-12  
DEVIATION 6-16, 14-5, 14-12  
DEW 10-14  
DEWPOINT 10-13  
DIHEDRAL 3-14  
DILUTER DEMAND OXYGEN SYSTEMS 5-27  
DIRECT USER ACCESS TERMINAL SERVICE 11-2  
DISTANCE 14-12  
DISTANCE MEASURING EQUIPMENT 14-21  
DIVERSION 14-27  
DME 14-21  
DRAG 3-1, 3-3  
DRUGS 15-8  
DUATS 11-2  
DUTCH ROLL 3-16  
DYNAMIC STABILITY 3-11

## E

EDDY CURRENT DAMPING 6-17  
EFAS 11-2  
    effect on flight 10-4  
    effect on wind 10-5  
ELECTRICAL SYSTEM 5-19  
ELEVATOR 4-3

EMPENNAGE 1-4  
EMPTY-FIELD MYOPIA 15-10  
ENGINE  
    altitude 5-10  
    cooling system 5-18  
    pressure ratio (EPR) 5-32  
    reciprocating 5-1  
    sea-level 5-9  
    turbine 5-29  
ENROUTE FLIGHT ADVISORY SERVICE 11-2  
EQUILIBRIUM 3-10  
EQUIVALENT AIRSPEED 9-18  
EQUIVALENT SHAFT HORSEPOWER 5-31  
ERROR CHAIN 16-1  
ESTIMATED TIME EN ROUTE 14-12  
ETE 14-12  
EVAPORATION 10-13  
EXHAUST GAS TEMPERATURE 5-32  
EXHAUST SYSTEMS 5-19  
EXPLOSIVE DECOMPRESSION 5-25

## F

FAA FLIGHT SERVICE STATION 11-2  
FALSE HORIZON 15-11  
FATIGUE 15-7  
FILING A FLIGHT PLAN (VFR) 14-16  
FIREWALL 1-4  
FIXED LANDING GEAR 5-23  
FIXED-PITCH PROPELLER 5-3  
FLAMEOUT 5-33  
FLAPS 4-6  
FLIGHT COMPUTERS 14-8  
FLIGHT CONTROLS 4-1  
FLIGHT DIVERSION 14-27  
FLIGHT PLAN FILING (VFR) 14-16  
FLIGHT PLANNING 14-13  
FLIGHT WATCH 11-2  
FLOOR LOAD LIMIT 8-4  
FOG 10-14  
FOREIGN OBJECT DAMAGE (FOD) 5-32  
FORM DRAG 3-3  
FOUR STROKE CYCLE 5-2  
    compression 5-2  
    exhaust 5-2  
    intake 5-2  
    power 5-2  
FRONTS 10-18  
    cold 10-20  
    occluded 10-22  
    stationary 10-22  
    warm 10-19  
FROST 10-14  
FSS 11-2  
FUEL  
    contamination 5-15

drains 5-14  
gauges 5-14  
grades 5-15  
injection 5-8  
load 8-4  
primer 5-14  
pumps 5-14  
rate 14-12  
selectors 5-14  
strainers 5-14  
sumps 5-14  
systems 5-13  
tanks 5-14  
FUSELAGE 1-2

## G

GAS DECOMPRESSION SICKNESS 5-26  
GLOBAL POSITIONING SYSTEM 14-26  
GPS 14-26  
GRAVITY 3-5  
GROUND ADJUSTABLE TABS 4-9  
GROUND EFFECT 3-7, 9-10  
GROUNDSPEED 6-6, 14-12  
GYROSCOPIC  
    action 3-24  
    flight instruments 6-9  
    principles 6-9  
    rigidity in space 6-9

## H

HAZARDOUS ATTITUDES 16-6  
HAZARDOUS IN-FLIGHT WEATHER ADVISORY  
    SERVICE 11-3  
HEADING INDICATOR 6-12  
HEATSTROKE 15-7  
HIGH ALTITUDE PERFORMANCE ENGINE 5-11  
HIGH-SPEED FLIGHT 3-35  
    controls 3-40  
HIWAS 11-3  
HOT START 5-33  
HUMAN FACTORS 16-1  
HUMIDITY 2-2  
HUNG START 5-33  
HYDRAULIC SYSTEMS 5-22  
HYDROPLANING 9-14  
HYPERVENTILATION 15-3  
HYPOXIA 15-2  
    histotoxic 15-2  
    hypemic 15-2  
    hypoxic 15-2  
    stagnant 15-2  
    symptoms 15-2

## I

IAS 6-6, 9-18  
I-BEAM 1-4  
ICE CONTROL SYSTEMS 5-28  
    airfoil 5-28  
    propeller 5-29  
    windscreen 5-29  
IGNITION SYSTEM 5-11  
ILLUSIONS 15-4  
INCLINOMETER 6-11  
INDICATED AIRSPEED 6-6, 9-18  
INDICATED ALTITUDE 6-4  
INDUCED DRAG 3-3  
IN-FLIGHT WEATHER ADVISORIES 11-12  
INOPERATIVE EQUIPMENT OPERATIONS 7-8  
INSPECTIONS  
    100-hour 7-7  
    aircraft 7-7  
    altimeter system 7-8  
    annual 7-7  
    preflight 7-8  
    transponder 7-8  
INTERCOOLER 5-10  
INTERFERENCE DRAG 3-3  
INTERPOLATION 9-20  
INVERSION 10-13

## L

LAMINAR FLOW AIRFOIL 2-5  
LAND BREEZE 10-7  
LANDING GEAR 1-4  
    fixed 5-23  
    retractable 5-23  
    tailwheel 5-23  
    tricycle 5-22  
LANDING PERFORMANCE 9-17, 9-37  
LATERAL STABILITY 3-14  
LATITUDE 14-2  
LAZY EIGHTS 3-30  
LEADING EDGE DEVICES 4-7  
LICENSED EMPTY WEIGHT 8-4  
LIFT 3-1, 3-6  
LOAD FACTORS 3-26  
    flight maneuvers 3-29  
    stalling speeds 3-28  
    steep turns 3-27  
LOADMETER 5-21  
LONGERON 1-2  
LONGITUDE 14-2  
LONGITUDINAL STABILITY 3-11  
LORAN-C 14-24

LOST COMMUNICATION PROCEDURES 12-9  
LOST PROCEDURES 14-27  
LOW-LEVEL WIND SHEAR 10-9

## M

MACH BUFFET BOUNDARIES 3-39  
MACH NUMBER 3-36  
MAGNETIC BEARING 14-23  
MAGNETIC COMPASS 6-14  
MAGNETIC DIP 6-16  
MAGNETIC HEADING 14-12  
MAGNETO 5-12  
MAGNUS EFFECT 2-3  
MANIFOLD ABSOLUTE PRESSURE (MAP) 5-4  
MASTER SWITCH 5-20  
MAXIMUM LANDING WEIGHT 8-4  
MAXIMUM RAMP WEIGHT 8-4  
MAXIMUM TAKEOFF WEIGHT 8-4  
MAXIMUM WEIGHT 8-4  
MAXIMUM ZERO FUEL WEIGHT 8-4  
MEAN AERODYNAMIC CHORD (MAC) 2-8, 8-4  
MEDICAL CERTIFICATE 15-1  
MEL 7-8  
MERIDIANS 14-2  
METAR 11-4  
MICROBURST 10-10  
MIDDLE EAR PROBLEMS 15-3  
MILITARY OPERATION AREA 13-4  
MILITARY TRAINING ROUTE 13-4  
MINIMUM EQUIPMENT LISTS 7-8  
MIXTURE CONTROL 5-5  
MOA 13-4  
MOMENT 3-9, 8-4  
MOMENT INDEX 8-4  
MONOCOQUE 1-2  
MONOPLANE 1-3  
MOTION SICKNESS 15-6

## N

N<sub>1</sub> INDICATOR 5-32  
N<sub>2</sub> INDICATOR 5-32  
NACELLE 1-5  
NATIONAL SECURITY AREAS 13-5  
NAVIGATION  
    calculations 14-8  
    measurement of direction 14-3  
    wind effect 14-6  
NDB 14-22  
NEGATIVE ARM COMPUTATIONS 8-8  
NEGATIVE STATIC STABILITY 3-10  
NEUTRAL STATIC STABILITY 3-10

NEWTON'S LAWS OF MOTION 2-2  
NIGHT VISION 15-10  
    autokinesis 15-11  
    false horizon 15-11  
    illusions 15-11, 15-12  
NITROGEN 2-1  
NONDIRECTIONAL RADIOBEACON 14-22  
NOTAM 12-3  
NOTICES TO AIRMEN 12-3

## O

OBSTRUCTION LIGHTS 12-8  
OCCLUDED FRONT 10-22  
OIL SYSTEMS 5-16  
OPERATIONAL PITFALLS 16-9  
OUTLOOK WEATHER BRIEFING 11-4  
OUTSIDE AIR TEMPERATURE GAUGE 5-8, 6-17  
OVERBOOST 5-11  
OWNER RESPONSIBILITIES 7-11  
OXYGEN 2-1  
OXYGEN AND THE HUMAN BODY 10-2  
OXYGEN MASKS 5-27  
OXYGEN SYSTEMS 5-26  
    continuous flow 5-27  
    diluter demand 5-27  
    pressure demand 5-27  
    servicing 5-28

## P

P FACTOR 3-23, 3-25  
PAPI 12-6  
PARACHUTE JUMP AREAS 13-4  
PARALLELS 14-2  
PARASITE DRAG 3-3  
    form 3-3  
    interference 3-3  
    skin 3-3  
PAYLOAD 8-4  
PERFORMANCE 9-4  
    climb performance 9-6  
    landing 9-17, 9-37  
    range 9-8  
    straight and level flight performance 9-5  
    takeoff 9-15  
PERFORMANCE CHARTS 9-19  
    climb and cruise charts 9-23  
    crosswind and headwind component chart 9-28  
    density altitude charts 9-20  
    landing charts 9-29  
    stall speed performance charts 9-30  
    takeoff charts 9-22  
PILOT SELF-ASSESSMENT 16-5  
PILOT WEATHER REPORT 11-7

PILOTAGE 14-10  
PILOT'S OPERATING HANDBOOK 7-1  
    use of 14-13  
PIREPS 11-7  
PITCH 3-9  
PITOT-STATIC FLIGHT INSTRUMENTS 6-1  
    blocked 6-8  
PLOTTER 14-8  
POWER 9-6  
POWERPLANT 1-5, 5-1  
PRECESSION 6-9  
PRECIPITATION 10-18  
PRECISION APPROACH PATH INDICATOR 12-6  
PREFLIGHT INSPECTIONS 7-8  
PREIGNITION 5-13  
PRESSURE ALTITUDE 6-4, 9-2  
PRESSURE DEMAND OXYGEN SYSTEMS 5-27  
PRESSURIZED AIRPLANES 5-24  
PREVENTIVE MAINTENANCE 7-9  
PRIMARY RADAR 12-10  
PROHIBITED AREA 13-3  
PROPELLER 5-2  
    adjustable-pitch 5-4  
    fixed-pitch 5-3  
    ice control 5-29  
    principles 3-21

## R

RADAR OBSERVATION 11-2  
RADAR SUMMARY CHART 11-16  
RADAR TRAFFIC INFORMATION SYSTEM 12-11  
RADAR WEATHER REPORT 11-8  
RADIO COMMUNICATIONS 12-8  
RADIO EQUIPMENT 12-8  
RADIO LICENSE 12-8  
RADIOSONDE 11-1  
RANGE PERFORMANCE 9-8  
RECIPROCATING ENGINE 5-1  
REFUELING PROCEDURES 5-16  
REGION OF REVERSE COMMAND 9-12  
REIL 12-6  
RELATIVE BEARING 14-23  
RELATIVE HUMIDITY 9-4, 10-13  
REPAIRS AND ALTERATIONS 7-9  
RESTRICTED AREA 13-3  
RETRACTABLE LANDING GEAR 5-23  
RIB 1-3  
RIGIDITY IN SPACE 6-9  
RISK  
    assessing 16-5  
    management 16-4  
RNAV 14-21  
ROLL 3-9  
ROUGH AIR 3-30  
RUDDER 4-5

RUNWAY CENTERLINE LIGHTS 12-7  
RUNWAY EDGE LIGHTS 12-7  
RUNWAY END IDENTIFIER LIGHTS 12-6  
RUNWAY INCURSION AVOIDANCE 12-14  
RUNWAY MARKINGS 12-3  
RUNWAY SURFACE AND GRADIENT 9-13  
RUNWAY VISUAL RANGE 11-1  
RVR 11-1

## S

SCUBA DIVING 15-9  
SEA BREEZE 10-7  
SECTIONAL CHART 14-1  
SELF ASSESSMENT 16-5  
SEMI-MONOCOQUE 1-2  
SHOCK WAVES 3-37  
SIGMET 11-3, 11-12  
SIGNIFICANT METEOROLOGICAL  
    INFORMATION 11-12  
SIGNIFICANT WEATHER PROGNOSTIC  
    CHARTS 11-18  
SINUS PROBLEMS 15-3  
SITUATIONAL AWARENESS 16-8  
SKIN FRICTION DRAG 3-3  
SPAR 1-3  
SPATIAL DISORIENTATION 15-4  
SPECIAL FLIGHT PERMITS 7-9  
SPECIAL USE AIRSPACE 13-3  
    alert areas 13-4  
    controlled firing area 13-4  
    military operation area 13-4  
    prohibited area 13-3  
    restricted area 13-3  
    warning area 13-4  
SPINS 3-29  
SPIRAL INSTABILITY 3-16  
SPOILERS 3-40  
SPOILERS 4-7  
STABILATOR 1-4, 4-4  
STABILITY 3-10, 8-2  
    atmospheric 10-12  
    dynamic 3-11  
    lateral 3-14  
    longitudinal 3-11  
    static 3-10  
    vertical 3-15  
STABILIZER, ADJUSTABLE 4-9  
STALLS 3-20  
    high speed 3-29  
STANDARD EMPTY WEIGHT 8-4  
STANDARD WEATHER BRIEFING 11-3  
STANDARD WEIGHTS 8-4  
STARTING SYSTEM 5-16  
STATIC STABILITY 3-10  
    negative 3-10

neutral 3-10  
positive 3-10  
STATION 8-4  
STATIONARY FRONT 10-22  
STRAIGHT-AND-LEVEL FLIGHT  
PERFORMANCE 9-5  
STRESS 15-6  
STRESS MANAGEMENT 16-6  
STRINGERS 1-3  
SUBLIMATION 10-13  
SUPERCHARGERS 5-9  
SUPERCOOLED WATER DROPLETS 10-15  
SUPERSONIC FLIGHT 3-35  
SURFACE ANALYSIS CHART 11-14  
SURFACE WEATHER MAPS 10-11  
SWEEPBACK WINGS 3-38

## T

TACHOMETER 5-3  
TAF 11-9  
TAS 6-6  
TAILWHEEL LANDING GEAR AIRPLANES 1-4, 5-23  
TAKEOFF PERFORMANCE 9-15  
TAXIWAY LIGHTS 12-8  
TAXIWAY MARKINGS 12-3  
TEMPERATURE/DEWPOINT SPREAD 10-13  
TEMPORARY FLIGHT RESTRICTIONS 13-4  
TERMINAL AERODROME FORECAST 11-9  
TERMINAL RADAR SERVICE AREAS 13-5  
THRUST 3-1, 3-2  
THRUST 9-6  
THRUST HORSEPOWER 5-31  
TIBS 11-2  
TIME ZONES 14-2  
TORQUE 3-23  
TORQUEMETER 5-32  
TOUCHDOWN ZONE LIGHTS 12-7  
TRANSCRIBED INFORMATION BRIEFING  
SERVICE 11-2  
TRANSCRIBED WEATHER BROADCAST 11-3  
TRANSPONDER 12-11  
inspection 7-8  
phraseology 12-12  
TRANSPORT CATEGORY AIRPLANE  
PERFORMANCE 9-31  
TRICYCLE LANDING GEAR AIRPLANES 1-4, 5-22  
TRIM TABS 4-8  
TRUE AIRSPEED 6-6, 9-18  
TRUE ALTITUDE 6-4  
TRUE COURSE 14-12  
TRUE HEADING 14-12  
TRUSS 1-2  
T-TAIL 4-3  
TURBINE ENGINE 5-29  
turbofan 5-30

turbojet engines 5-30  
turboprop engines 5-30  
turboshaft engines 5-31  
TURBINE ENGINE INSTRUMENTS 5-31  
TURBOFAN ENGINES 5-30  
TURBOJET ENGINES 5-30  
TURBOPROP ENGINES 5-30  
TURBOSHAFT ENGINES 5-31  
TURBOSUPERCHARGERS 5-10  
TURN COORDINATOR 6-11  
TURN-AND-SLIP INDICATOR 6-11  
TWEB 11-3  
TWIST 3-23

## U

UNCONTROLLED AIRPORT 12-1  
UNCONTROLLED AIRSPACE 13-3  
URGENT PIREP 11-3  
USEFUL LOAD 8-4

## V

V SPEEDS 6-7, 9-18  
VARIATION 6-15, 14-4, 14-12  
VASI 12-6  
VECTOR ANALYSIS 14-10  
VERTICAL CARD COMPASS 6-17  
VERTICAL SPEED INDICATOR 6-5  
VERTICAL STABILITY 3-15  
VERY HIGH FREQUENCY OMNIDIRECTIONAL  
RANGE 14-18  
VFR ROUTES, PUBLISHED 13-4  
VFR TERMINAL AREA CHART 14-1  
VFR WEATHER MINIMUMS 13-2  
VG DIAGRAM 3-30  
VISIBILITY 10-18  
VISION IN FLIGHT 15-9  
VISUAL APPROACH SLOPE INDICATOR 12-6  
VISUAL GLIDESLOPE INDICATORS 12-6  
VOR 14-18  
tracking 14-20  
use of 14-19  
VOR/DME RNAV 14-21  
V-TAIL 4-6

## W

WAC CHARTS 14-1  
WAKE TURBULENCE 12-12  
WARM FRONT 10-19  
WARNING AREA 13-4  
WARREN TRUSS 1-2  
WASTE GATE 5-10



WEATHER BRIEFING  
    abbreviated 11-4  
    outlook 11-4  
    standard 11-3  
WEATHER DEPICTION CHART 11-15  
WEATHER MINIMUMS 13-2  
WEIGHT 3-1, 3-5  
WEIGHT AND BALANCE  
    computations 8-4  
    effect of load distribution 3-33  
    effect on airplane structure 3-32  
    effect on performance 3-32  
    effect on stability and controllability 3-33  
    management 8-3  
    terms 8-3  
WEIGHT CONTROL 8-1  
WEIGHT SHIFT 8-9  
WIND 10-5  
    effect of obstructions 10-8  
    patterns 10-6  
    shift 10-21  
WIND CORRECTION ANGLE 14-12  
WIND DIRECTION INDICATORS 12-8  
WIND PATTERNS 10-6  
WIND SHEAR 10-9  
WIND SHIFTS 10-21

WIND TRIANGLE 14-10  
WINDS AND TEMPERATURE ALOFT  
    FORECAST 11-13  
WINDSCREEN ICE CONTROL 5-29  
WING DIHEDRAL 3-14  
WINGS 1-3  
WINGTIP VORTICES 3-6, 12-13  
    avoidance procedures 12-13  
    vortex behavior 12-13  
    vortex generation 12-13  
    vortex strength 12-13  
WORK 9-6  
WORKLOAD MANAGEMENT 16-8  
WORLD AERONAUTICAL CHART 14-1

## Y

YAW 3-9  
YAW STABILITY 3-15

## Z

ZERO FUEL WEIGHT COMPUTATIONS 8-9