

The Feasibility of Building-Mounted/Integrated Wind Turbines (BUWTs): Achieving their potential for carbon emission reductions.

part-funded by the Carbon Trust (2002-07-028-1-6)

Final Report

**A G Dutton, J A Halliday, M J Blanch
Energy Research Unit, CCLRC
(with contributions from all partners)**

Final version: 4 May 2005



The Feasibility of Building Mounted/Integrated Wind Turbines (BUWTs)

Document change record

Issue/revision	Date	Pages	Summary of changes
Final report	22-02-2005	107	
Incorporating partners' comments	04-05-2005	109	Minor editorial Revised Executive Summary & Recommendations

The partners in the Feasibility of Building Mounted/Integrated Wind Turbines (BUWTs); Achieving their potential for carbon emission reductions are:

	Contact	Job Title
1. CCLRC	Jim Halliday Geoff Dutton Mike Blanch	Head of Energy Research Unit Senior Research Engineer
2. Altechnica	Derek Taylor	Principal
3. BDSP	Sinisa Stankovic Neil Campbell	Director Associate
4. Hoare Lea	Justin Adcock Andrew Bullmore Terry Wyatt Jerry Barnes	Executive Acoustic Engineer Director of R&D Head of Sustainability
5. Imperial College of Science, Technology and Medicine	Mike Graham	Professor of Unsteady Aerodynamics
6. Marlec	Paul Fitches	Chief Engineer
7. Proven	Gordon Proven	Principal
8. Wind Dam Limited	Derek Miles	Director

The project *The Feasibility of Building Mounted/Integrated Wind Turbines (BUWTs): Achieving their potential for carbon emission reductions* was part-funded by the Carbon Trust (Contract number 2002-07-028-1-6). The project's principal objective was to identify and examine BUWT technologies as a whole and produce recommendations concerning requirements for research, development and demonstration. This report comprises an amalgamation and limited re-editing of the 5 task reports:

1. Assessing the Energy Generation Potential of BUWTs

2. Surveying and Assessing BUWT Technologies

3. Examining the Technical Solutions to the Technical Hurdles

4. Assessing the Economics and CO₂ Emission Savings from BUWTs

5. Producing a Research and Development Pathway to Demonstration

Executive Summary

The energy generation potential and technical feasibility of siting wind turbines in the built environment have been assessed. The study includes various configurations of Building Mounted/Integrated Wind Turbines (BUWTs), considered to be largely but not necessarily exclusively in urban areas: from turbines situated next to buildings, through turbines mounted on buildings, to turbines fully integrated into the building fabric.

It is concluded that wind energy could make a significant contribution to energy requirements in the built environment and that a more detailed evaluation of the resource is justified. In particular, through a combination of new-build with specifically designed wind energy devices and retrofitting of (preferably certified) turbines on existing buildings, it is estimated that the aggregated annual energy production by 2020 from wind turbines in the built environment could be in the range 1.7-5.0 TWh (dependent on the distribution of installations with respect to optimal wind speed)¹ resulting in annual carbon dioxide savings in the range 0.75-2.2 Mt CO₂. These figures represent between 1.5%-4.5% of the UK domestic sector electricity demand in 2000.

This remains an underdeveloped area of technology with potential for the UK to establish considerable, world-leading technical expertise, building on existing strengths in the small wind turbine market and offering good job creation opportunities.

Section 1 of this report briefly reviews the UK wind energy resource, the influence of the built environment on this resource, and the status of conventional wind energy technology, before, in section 2, introducing specific BUWT technologies and their potential advantages and disadvantages. In section 3, the main technical hurdles are reviewed and addressed in terms of whether potential solutions exist or further research and development is required. In section 4, the potential electricity production and carbon dioxide emissions savings are estimated for a range of assumptions about incident wind speed and installation rates. To achieve the estimated levels of penetration and to maximise the effectiveness of individual BUWT installations, it is concluded in section 5 that improved understanding is required in four main areas (reproduced under Recommendations overleaf).

¹ The estimated annual energy production of 1.7-5.0 TWh assumes a BUWT-retrofit penetration of around 1% of domestic properties (1.5% in non-domestic) and 5% penetration in all new-build properties

Recommendations

The successful development of Building Mounted/Integrated Wind Turbines would be assisted by further R&D in four broad areas: assessment of wind regime in urban areas, assessment of the structural implications of BUWTs, optimisation of wind turbine design for BUWT installations, and addressing various non-technical barriers. In addition, the establishment of a national test centre would facilitate the adoption and application of consistent standards for power performance measurement, noise and vibration assessment, and location/mounting and safety. The specific recommendations in each of these areas are as follows:

1. Assessment of the wind regime in urban areas and around isolated buildings

R&D Priority 1.1: Carry out resource assessments for wind energy potential in a range of different urban environments (e.g. major city centre, high density terraced housing and city blocks, suburban semi-detached and detached housing neighbourhoods, shopping centre, etc.).

R&D Priority 1.2: Develop an improved understanding of local air flows around and over buildings through a combination of computational fluid dynamics modelling and in situ measurements.

R&D Priority 1.3: Consider developing a dedicated test facility to evaluate the effect of the wind turbine itself on flow over (or around) the building and to evaluate (and possibly certify) different devices.

2. Assessment of the structural and noise implications of mounting wind turbines on or within a building structure

R&D Priority 2.1: Assess the possible combinations of building mounted turbine attachment methods and wall/roof types to determine installation guidelines on appropriate load-bearing capacities.

R&D Priority 2.2: Re-assess small wind turbine safety standards to ensure that full range of likely turbulence and wind shear conditions are adequately covered.

R&D Priority 2.3: Carry out a comprehensive review of background noise levels in urban environments and the potential additional contribution of various BUWT technologies.

3. Optimisation of wind turbine design for building applications

R&D Priority 3.1: Development work to optimise small wind turbine design for operation in the built environment. Particular attention should be paid to device optimisation for operation in enhanced (ducted) flow, cross flow, and high turbulence conditions. Novel blade designs and comparison of vertical and horizontal axis turbines should be considered.

R&D Priority 3.2: Optimise inverters, inverter controllers, and generators for small, grid-connected renewable energy applications.

R&D Priority 3.3: Develop suitable containment or failsafe methods for failed rotors.

4. Addressing non-technical barriers to BUWT installations

The final set of R&D recommendations refers to non-technical barriers. Firstly and most importantly, the construction type and distribution of the UK building stock is insufficiently documented to allow a more rigorous assessment of potential. Additional studies are recommended to improve the data on building statistics, in particular with respect to high rise buildings which sample the maximum urban wind potential. These studies should also consider capital cost, financial mechanisms, and the social position (e.g. whether owner-occupier or landlord-lessee) of the end-user market.

R&D Priority 4.1: Develop a UK-wide Geographical Information System (GIS) incorporating data on local topography, building topology, morphology, orientation, height, wall construction, and roof-type (clearly the development of such a database would have additional benefits outside this particular field, including, in particular, solar energy potential for buildings).

R&D Priority 4.2: Assess the potential BUWT resource in high-rise buildings and other large structures.

R&D Priority 4.3: Assess non-technical barriers to BUWTs, including capital cost, insurance issues, and end-user finance and social issues.

5. Establishment of national test centre for BUWT technologies

The successful demonstration of BUWT technology and the solving of certain generic questions such as mounting configuration, noise and vibration transmission, optimal location, power performance assessment, and the development of standards could be suitably met by establishing a dedicated BUWT testing facility.

Table of Contents

Executive Summary	3
Recommendations.....	4
1. Assessing the Energy Generation Potential of BUWTs	9
1.1 Introduction.....	9
1.2 The Importance of Wind Turbines.....	9
1.3 The UK Wind Resource.....	11
1.3.1 Wind speeds at 50 m from the European Wind Atlas.....	11
1.3.2 Wind speeds from the NOABL database.....	14
1.3.3 Modelling urban wind speeds?	15
1.3.4 Conclusions on wind resource	15
1.4 Effect of buildings on the wind resource	15
1.4.1 The boundary layers and wind velocities in the vicinity of BUWTs.....	15
1.4.2 Modelling flow fields around buildings.....	17
1.4.3 UWERN Urban Meteorology Programme.....	19
1.4.4 Flows assessed as part of building design.....	19
1.4.5 Conclusions about the effects of buildings on wind resource.....	20
1.5 Wind turbine basics.....	20
1.5.1 Power available in the wind	20
1.5.2 Power produced by a turbine and the power coefficient, C_p	20
1.5.3 Limits on power produced	22
1.5.4 Summary of wind turbine basics.....	22
1.6 Building Integrated/Mounted Wind Turbines (BUWTS).....	22
1.6.1 Building integrated wind turbines.....	23
1.6.2 Building mounted wind turbines.....	23
1.6.3 Building Augmented Wind Turbines (BAWTs).....	23
1.7 Conventionally sited Small/Micro Wind turbines	23
1.8 Influence of external factors in considering the feasibility of BUWTs.....	25
1.8.1 Higher wind speeds so more power	25
1.8.2 Lower energy costs for point of use generation.....	25
1.8.3 Meeting government building energy use targets.....	26
1.8.4 Potential for price reduction.....	27
1.8.5 Clear Skies and Scottish Community and Household Renewables initiatives	27
1.8.6 Support from the Renewables Obligation.....	27
1.8.7 The Climate Change Levy	28
1.8.8 Complementarity to solar power.....	28
1.8.9 Avoidance of the barriers of Large On-shore Wind	29
1.8.10 Clearer planning permission guidance.....	29
1.8.11 Better grid connection standard, G83	29
1.8.12 Interest from architects in fitting wind turbines to buildings.....	29
1.8.13 Value Added Tax (VAT)	30
1.8.14 UK expertise and interest in BUWT technology	30
1.9 Potential disadvantages of BUWTs	30
1.9.1 Turbines failing because they are not robust enough.....	30
1.9.2 Lower than expected performance.....	31
1.9.3 Concern by some Small Wind manufacturers and practitioners.....	32
1.9.4 Insurance	32
1.10 Summary of section	33
2. Surveying and Assessing BUWT Technologies.....	34

The Feasibility of Building Mounted/Integrated Wind Turbines (BUWTs)

2.1	Introduction.....	34
2.2	Historical BUWTs and existing uses of wind power in buildings.....	34
2.2.1	Passive ventilation (no moving parts).....	34
2.2.2	Active wind-powered ventilation systems.....	34
2.3	Survey of BUWT technologies.....	36
2.3.1	Comments on the data tables.....	36
2.3.2	The first BUWT: the Trimblemill.....	36
2.3.3	The late 1990's: The Green Building , Temple Bar, Dublin.....	37
2.3.4	The largest building-mounted turbines from Fortis.....	38
2.3.5	SouthWest Windpower roof-mounted Windseeker and AIR.....	39
2.3.6	WEB Concentrator.....	40
2.3.7	Ducted Wind Turbine Module.....	42
2.3.8	Altechnica's Patented Aeolian Planar Concentrator Wind/Solar Systems™.....	42
2.3.9	Wind Dam's WD1 system.....	44
2.3.10	Ecofys' Neoga.....	45
2.3.11	Wind Amplified Rotor Platform (WARP™) Tower.....	46
2.3.12	Aeromag's Lakota.....	46
2.3.13	Turby.....	47
2.3.14	Prowin's Provane 5 & 7.....	48
2.3.15	Ropatec's WRE range.....	48
2.3.16	Wind Electric Incorporated's Ducted Fan Wind Turbine (DFWT).....	49
2.3.17	Windsave.....	50
2.3.18	Proven.....	50
2.3.19	Marlec.....	52
2.3.20	Renewable Devices.....	52
2.3.21	Zia Solar's Crescent.....	53
2.3.22	The Combined Augmented Technology Turbine (CATT).....	53
2.3.23	The NGUp WindWall.....	54
2.3.24	Robertson and Leaman's Roof Turbine.....	55
2.3.25	Other approaches: the solar chimney.....	55
2.4	Conclusions.....	55
3.	Examining the Technical Solutions to the Technical Hurdles.....	56
3.1	Introduction.....	56
3.2	Ranking of technical hurdles identified.....	57
3.3	Possible solutions to the technical hurdles.....	60
3.3.1	Wind regime in the built environment.....	60
3.3.2	Noise and vibration issues.....	61
3.3.3	Building mounted/integrated wind turbine (BUWT) design.....	66
3.3.4	Installation issues.....	70
3.3.5	Overall systems, operation, and maintenance.....	72
3.4	Conclusions.....	75
4.	Assessing the Economics and Potential CO ₂ Emissions Savings from BUWTs.....	76
4.1	Introduction.....	76
4.2	Economic evaluation of BUWTs.....	76
4.3	Potential CO ₂ Emissions Saving.....	77
4.3.1	Potential CO ₂ Emissions Saving from retrofitting of BUWTs.....	77
4.3.2	Potential CO ₂ Emissions Saving from new-build of BUWTs.....	83
4.3.3	Net Potential CO ₂ Emissions Saving from a BUWTs Programme.....	85
4.4	Conclusions.....	88
5.	Producing a Research and Development Pathway to Demonstration.....	89

The Feasibility of Building Mounted/Integrated Wind Turbines (BUWTs)

5.1	Introduction.....	89
5.2	R&D priorities for introducing wind turbines into the built environment.....	89
5.2.1	Assessment of wind regime in urban areas and around isolated buildings.....	89
5.2.2	Structural/noise implications of mounting wind turbines on/within a building ...	91
5.2.3	Optimisation of wind turbine design for building applications	92
5.2.4	Improved assessments of energy resource, cost, and potential CO ₂ emissions savings	93
5.3	A pathway to BUWT demonstration	94
5.3.1	Evaluating the potential of BUWTs.....	94
5.3.2	Optimising BUWT devices.....	94
5.4	Conclusions.....	95
	Appendix 1: Detailed chart of turbine characteristics.....	97
	Appendix 2: Relative importance assigned to the 25 hurdles.....	98

1. Assessing the Energy Generation Potential of BUWTs

1.1 Introduction

Over 50% of carbon dioxide emissions in the UK come from the heating and operation of buildings²; the energy used in buildings accounts for 70-75% of London's energy needs³. Providing renewable energy directly to buildings would contribute to reducing their carbon dioxide emissions. Consequently, this report assesses the resource available to Building Mounted/Integrated Wind Turbines (BUWTs) to supply some of this energy.

Note : For ease of reference this report uses the term 'Large Wind' to refer to turbines rated above 100 kW, 'Small Wind' to refer to turbines less than 100 kW, and 'Micro Wind' to refer to turbines less than 10 kW.

1.2 The Importance of Wind Turbines

The UK Government's *Energy White Paper* in 2003⁴ set the scene for a major expansion of renewable energy, including substantial investment in large wind farms.

The Carbon Trust's report⁵ *Building Options for UK Renewable Energy* surveyed current prices and price predictions to 2020 for on-shore and off-shore wind. The report observed that Large On-shore Wind is close to being cost competitive today and is likely to be a major contributor to the build up of renewable power capacity over the next ten years. It is acknowledged that the on-shore wind evaluation does not include any consideration of Small or Micro Wind⁶.

The energy balance/pay back period of wind energy is favourable compared with competing technologies, having been calculated for a large wind turbine to be 1 to 2 months⁷. The CO₂ emitted as during a turbine's construction is related to the energy consumed and thus any CO₂ emission from construction activities is also soon recouped.

Figure 1-1 shows that Large On-shore Wind currently costs 3 p/kWh and is forecast to fall to 2.4 p/kWh by 2020. Off-shore Wind currently costs 5 p/kWh, but is forecast to be even cheaper than On-shore wind by 2020 at 2.2 p/kWh.

Figure 1-2 shows that the range of installed costs for small machines varies from £750/kW (1200 €/kW) to £1375/kW (2200 €/kW). Figure 1-2 also shows price estimates in US cents for installed costs of £1180/kW (\$2000/kW) and £880/kW (\$1500/kW) (assuming \$1.7 = £1 = €1.6). For the installed costs of £1180/kW option with a 5 m/s average wind speed at the hub height the Small Wind cost is currently 8 p/kWh. For the installed costs of £880/kW option with 7.5 m/s average wind speed at the hub height the Small Wind cost could be as low as 3 p/kWh (5.1 US c/KWh), which is the current average for Large Wind. The cost for Micro Wind would be expected to be higher than that of Small Wind.

² BRE, <http://www.inreb.org/>, Oct 2003

³ RENEUE, <http://www.renue.org.uk/>, Sept 2003

⁴ Department of Trade and Industry (DTI), *Energy White Paper, Our energy future – creating a low carbon economy*, DTI, 2003

⁵ The Carbon Trust, *Building Options for UK Renewable Energy*, Oct 2003

⁶ Catherine Bremnar, The Carbon Trust, personal correspondence to M J Blanch, Oct 2003

⁷ Wind Power Background Information Note No. 16, Vindmølleindustrien or Danish Wind Industry Association (October 1997)

The Feasibility of Building Mounted/Integrated Wind Turbines (BUWTs)

Estimated cost of renewable & fossil fuel technologies in 2003

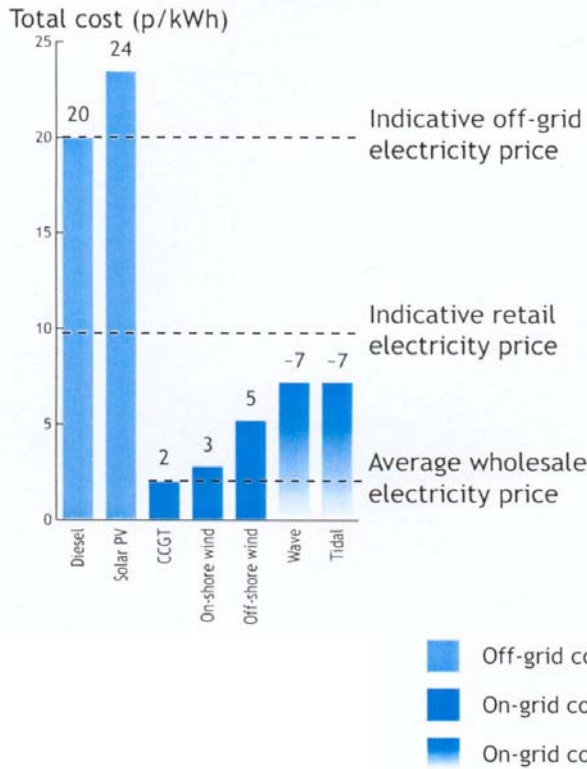

Estimated cost of renewable & fossil fuel technologies in 2020

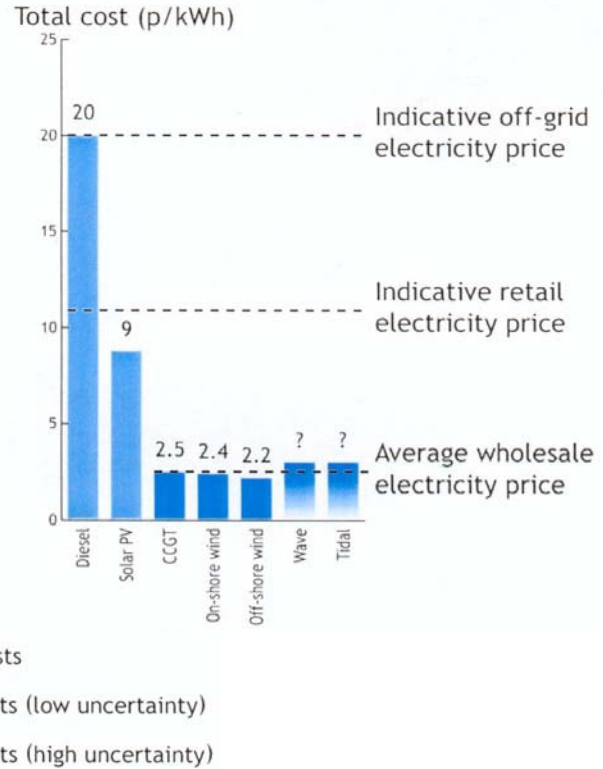

Figure 1-1: The Carbon Trust's current (2003) and 2020 cost estimates

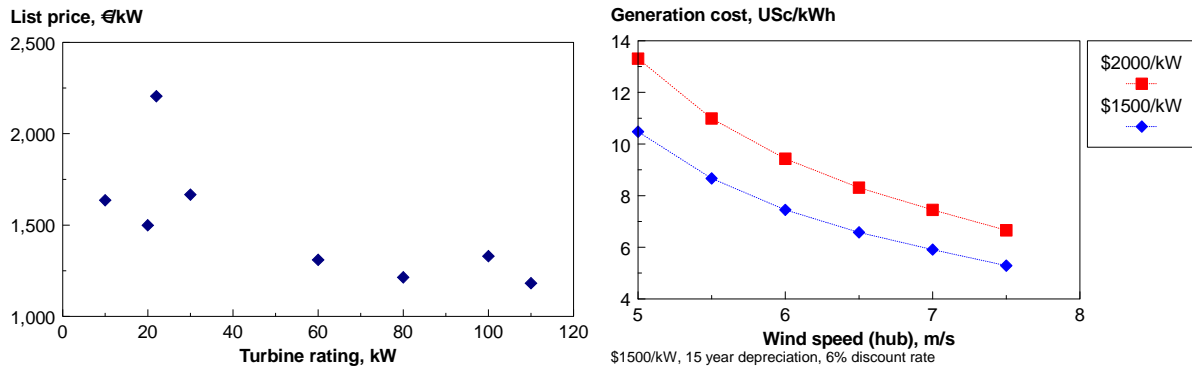

Figure 1-2: Turbine capital costs (left) and generation costs (right) for Small Wind⁸

Solar photovoltaics (PV) is an alternative (but also complementary) technology to Micro Wind, but, at an average cost of 24 p/kWh, the Carbon Trust report concludes that it has “limited potential for UK plc”⁹. Solar PV’s cost is therefore very much higher than grid connected Small Wind’s median cost of 7 p/kWh, making Small Wind technology a viable contender for the building-integrated energy production market.

Wind turbines in the UK tend to be at their most productive during periods of high energy demand, as shown in Figure 1-3. This also contrasts with PV, which is at its most productive in June and least in December, which is actually out of phase with the UK’s energy demand.

⁸ D J Milborrow, *Economics of Wind*, WREN International Seminar 2003, 19-25 August 2003, Figures 4 & 8

⁹ The Carbon Trust, *Building Options for UK Renewable Energy*, Oct 2003., p.16.

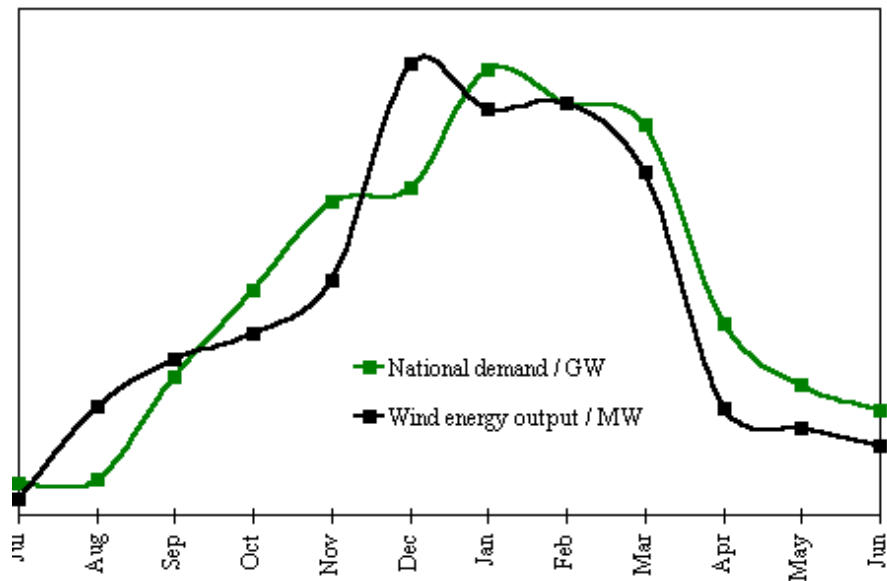

Figure 1-3: Yearly wind energy output and seasonal electricity demand for the UK¹⁰

1.3 The UK Wind Resource

An important step before contemplating a wind energy installation is to assess the likely wind regime and hence power production potential of the site. Two different approaches to wind speed estimation will now be described and the possible role of modelling discussed.

1.3.1 Wind speeds at 50 m from the European Wind Atlas

In the European Wind Atlas¹¹ the wind resource is expressed in mean wind speed classes at 50 m height above ground. As seen from Figure 4, large geographic areas fall within the same class. However, this does not mean that all locations within a given area will have the same wind regime, as the local site-specific wind speed results from modification of the high level wind due to the influence of local topography and ground cover.

Figure 1-4 shows the wind resource class at 50 m above ground level (agl) of the EC countries in 1989¹¹. Within the second highest wind speed class D (red) the range of mean wind speeds at 50 m varies from between 5 to 6 m/s in sheltered terrain to 10 to 11.5 m/s on hills and ridges.

The countries with the largest areas of the highest wind speed class E (purple) are the UK (Scotland and Northern Ireland), Ireland, Denmark and France. The countries with the largest areas of the second highest wind speed class D (red) are the UK (Northern Ireland, England and Wales), France, Ireland and Denmark. The UK has the best wind resource in Europe.

Figure 1-5 is an enlargement of the UK part of Figure 1-4 and thus shares the same key. It also includes shading which indicates the height of the terrain above sea level.

¹⁰ Econnect Ltd, UK, using data from the National Grid Company and wind farms

¹¹ Troen, I. and E. L. Petersen, *European Wind Atlas*, Risø National Laboratory, Roskilde, Denmark 1989

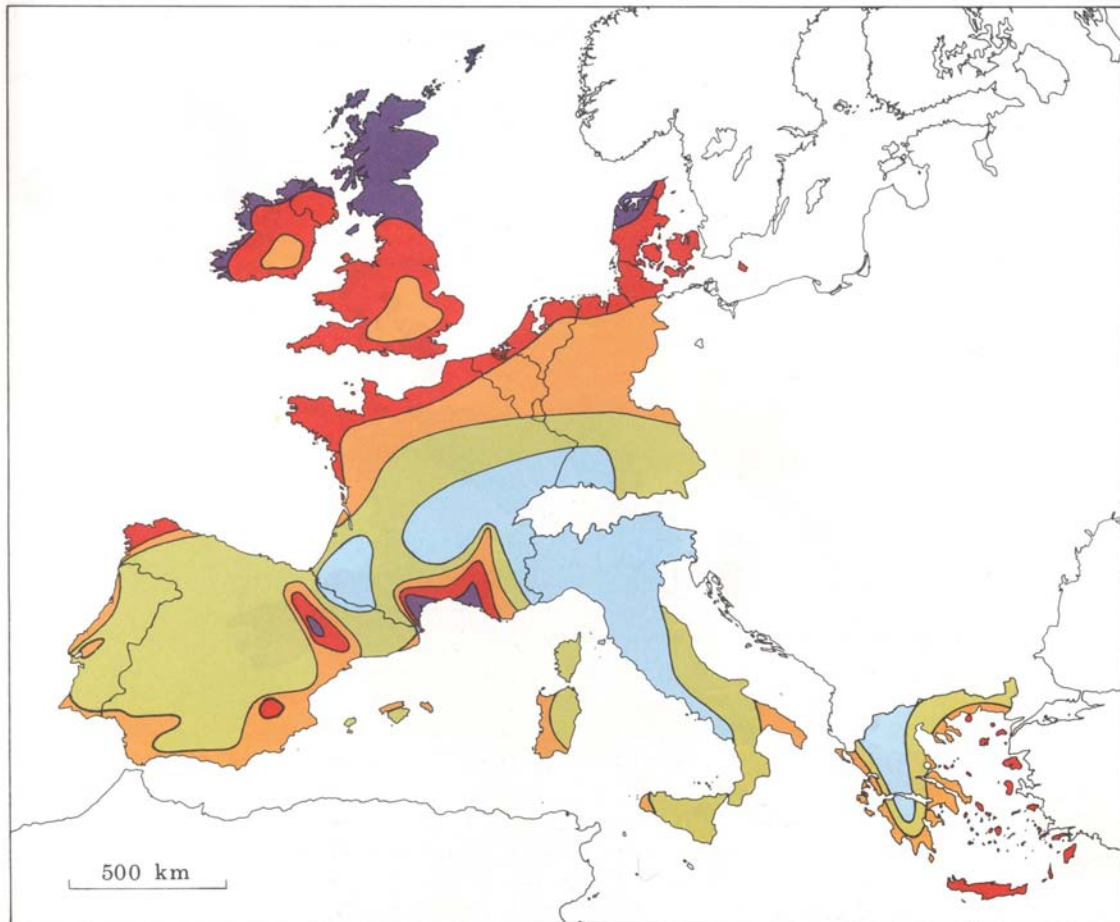

Wind resources ¹ at 50 metres above ground level for five different topographic conditions										
Wind Class	Sheltered terrain ²		Open plain ³		At a sea coast ⁴		Open sea ⁵		Hills and ridges ⁶	
	m s ⁻¹	Wm ⁻²	m s ⁻¹	Wm ⁻²	m s ⁻¹	Wm ⁻²	m s ⁻¹	Wm ⁻²	m s ⁻¹	Wm ⁻²
E	> 6.0	> 250	> 7.5	> 500	> 8.5	> 700	> 9.0	> 800	> 11.5	> 1800
D	5.0-6.0	150-250	6.5-7.5	300-500	7.0-8.5	400-700	8.0-9.0	600-800	10.0-11.5	1200-1800
C	4.5-5.0	100-150	5.5-6.5	200-300	6.0-7.0	250-400	7.0-8.0	400-600	8.5-10.0	700-1200
B	3.5-4.5	50-100	4.5-5.5	100-200	5.0-6.0	150-250	5.5-7.0	200-400	7.0-8.5	400-700
A	< 3.5	< 50	< 4.5	< 100	< 5.0	< 150	< 5.5	< 200	< 7.0	< 400

1. The resources refer to the power present in the wind. A wind turbine can utilize between 20 and 30% of the available resource. The resources are calculated for an air density of 1.23 kg m⁻³, corresponding to standard sea level pressure and a temperature of 15°C. Air density decreases with height but up to 1000 m a.s.l. the resulting reduction of the power densities is less than 10%.
2. Urban districts, forest and farm land with many windbreaks (roughness class 3).
3. Open landscapes with few windbreaks (roughness class 1). In general, the most favourable inland sites on level land are found here.
4. The classes pertain to a straight coastline, a uniform wind rose and a land surface with few windbreaks (roughness class 1). Resources will be higher, and closer to open sea values, if winds from the sea occur more frequently, i.e. the wind rose is not uniform and/or the land protrudes into the sea. Conversely, resources will generally be smaller, and closer to land values, if winds from land occur more frequently.
5. More than 10 km offshore (roughness class 0).
6. The classes correspond to 50% overspeeding and were calculated for a site on the summit of a single axisymmetric hill with a height of 400 metres and a base diameter of 4 km. The overspeeding depends on the height, length and specific setting of the hill.

Figure 1-4: European mean wind speeds at 50 m (European Wind Atlas)

The Feasibility of Building Mounted/Integrated Wind Turbines (BUWTs)

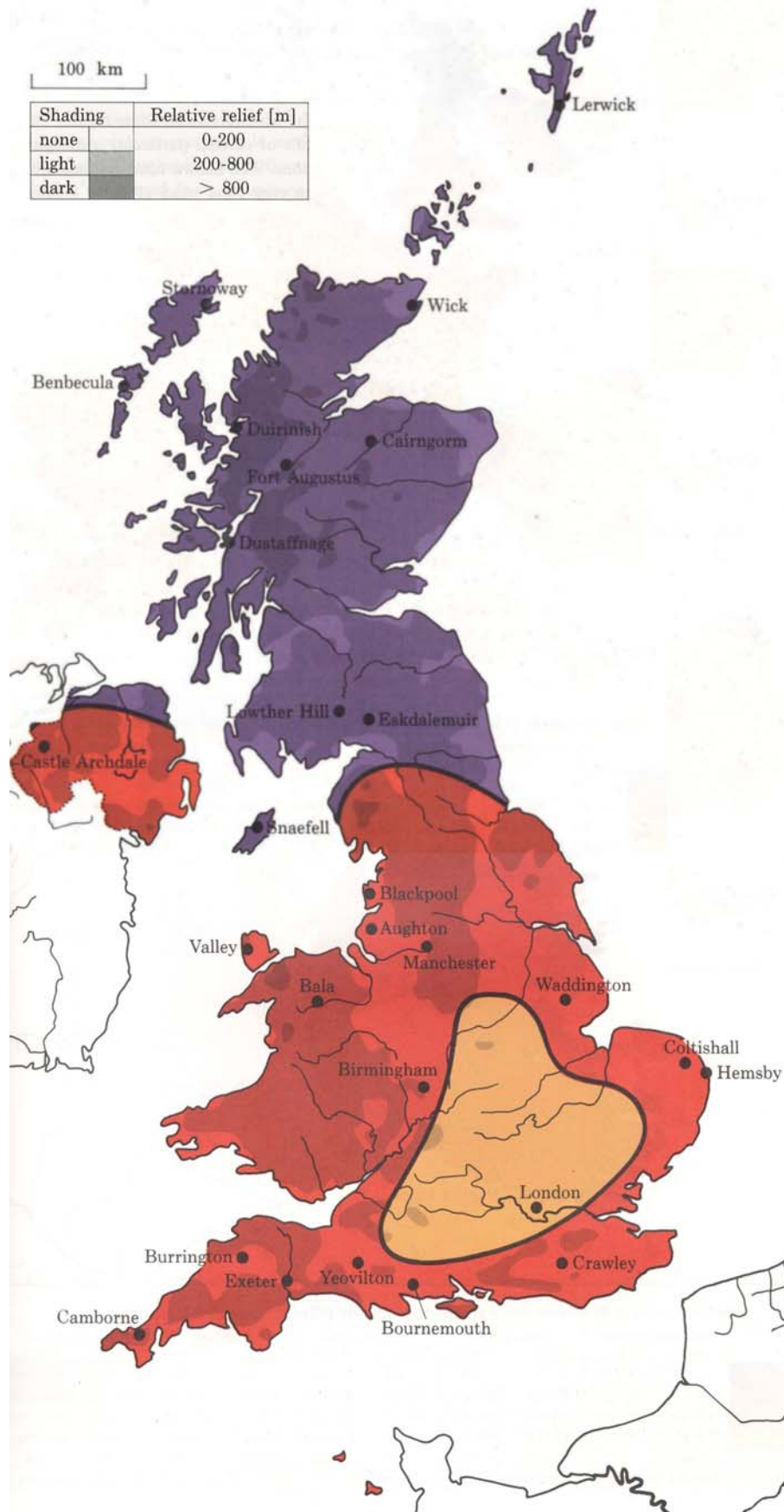

Figure 1-5: UK mean wind resource at 50 m above ground level (European Wind Atlas)

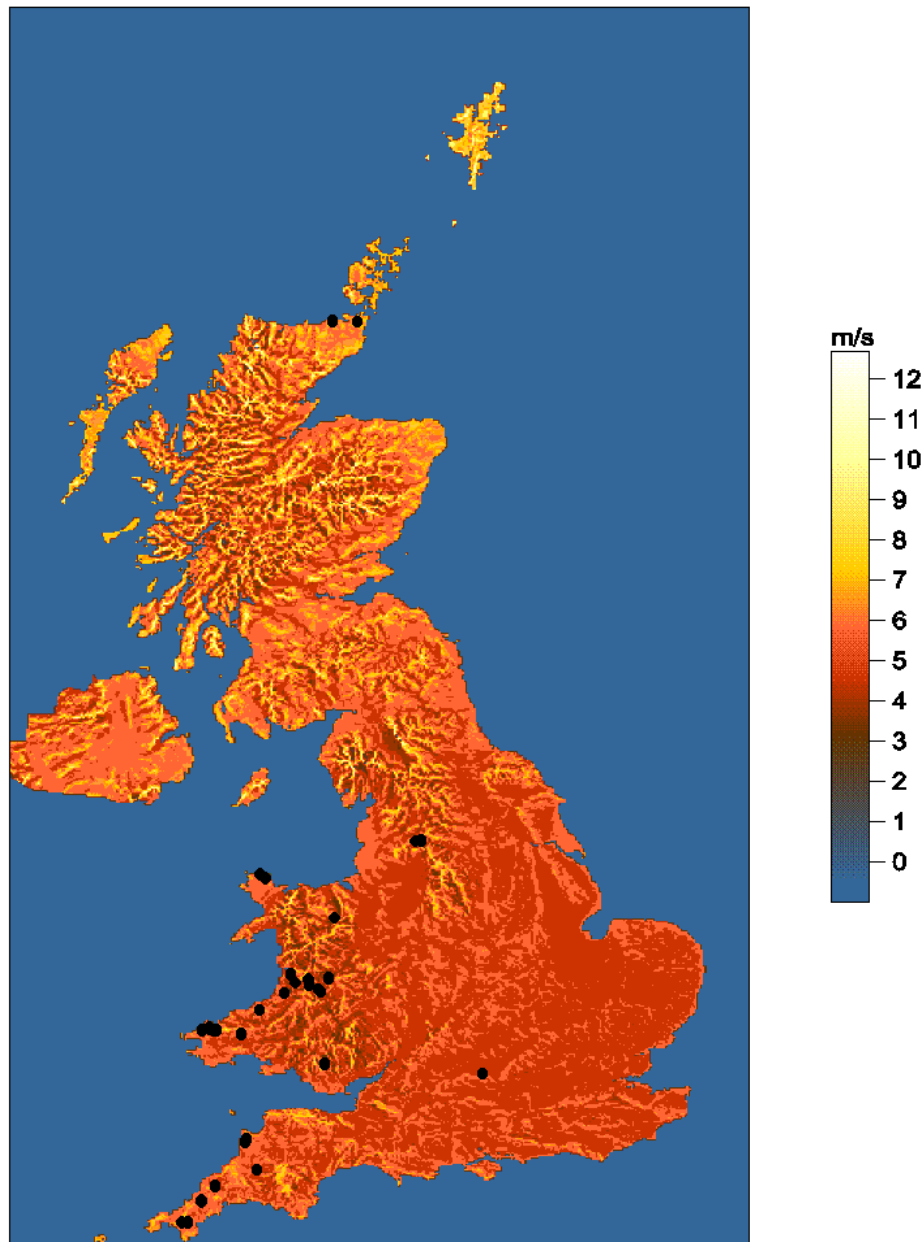

Figure 1-6: The NOABL database of wind speed over the UK and some of the sites used to check its accuracy

1.3.2 Wind speeds from the NOABL database

To assist wind farm developers in selecting suitable wind farm sites, a database of UK wind speeds at 1km x 1km resolution has been published using Met Office data in conjunction with a "mass-consistent" wind flow model, NOABL¹². CCLRC has compared measurements made at prospective wind farm sites with these predictions (see Figure 1-6)¹³. Data measured at the prospective wind farm sites was used to estimate long-term wind speeds for selected 1km by 1

¹² Burch, S.F., Ravenscroft, F., *Computer modelling of the UK wind energy resource: final overview report*, ETSU WN 7055

¹³ Halliday J A et al (1995), *Assessment of the Accuracy of the DTI's Database of UK Wind Speeds*, Final report to the DTI, ETSU report ETSU W/11/00401/REP

km grid squares. It was found that the values from the DTI NOABL database were generally lower than those derived from the actual on-site measurements - the mean difference being 1.47 m/s, with less than 20% of sites having a difference of less than 0.5 m/s. It was considered that the primary cause of the differences was the coarse resolution of the grid originally used to define the topography in the NOABL modelling. The comparison project made a series of detailed recommendations which may be relevant if meteorological models are used to estimate urban wind speeds.

1.3.3 Modelling urban wind speeds?

Physical and statistical estimates of wind speed over complex terrain are often made using flow models, such as WAsP, NOABL, AIOLOS, MS3DJH and MSFD, or the "Measure-Correlate-Predict" (MCP) method in which the target site is compared with a fully monitored site. Flow patterns in the built environment are likely to be more severe than those conventionally dealt with by these models. The developer of WaSP was not aware of the software being applied in the built environment and, given the complicated flow patterns, would not expect good results¹⁴.

It is interesting to note that a number of city planning authorities (e.g. Liverpool) have scale models of city centres which can be laser scanned and converted into virtual models. Such models could be analysed using CFD to identify prime locations for BUWTs and by other software (e.g. program to evaluate solar insolation) to identify the potential of other renewable energy technologies. The results could be useful to planners and developers alike.

1.3.4 Conclusions on wind resource

The UK wind resource is the best in Europe. Within the UK, the highest wind speeds are observed over hills and ridges in the north and west; the south and east have a lower resource, but it is still good by European standards. Even the lowest wind speed areas may have some generation potential, especially if concentration devices can be used. The available wind resource for BUWTs and the potential energy generation is assessed in more detail in section 4.

1.4 Effect of buildings on the wind resource

Wind flow in cities is complex but some general patterns can be identified, starting with the variation of velocity with height as the wind flows over different types of terrain.

1.4.1 The boundary layers and wind velocities in the vicinity of BUWTs

Figure 1-7 shows three simple velocity profiles developed from an initial uniform flow over a representative rural location, a suburban area, and a city centre. The effects of friction in these different terrains results in different boundary layer (volumes of reduced flow) development and these terrains are therefore assigned different roughness classes. A representative 100 m tall building is shown in the plots in Figure 1-7. In the rural location, the building experiences wind speeds of 5 and 5.5 m/s at heights of 50 m and 100 m respectively; in suburbia, wind speeds of 4.1 m/s and 4.8 m/s (20% and 13% lower); and, in the city centre, wind speeds of 3.0 and 3.9 m/s (40% and 29% lower than the rural location). Note the larger reduction in wind speed at the

¹⁴ Lars Landberg, Risø National Laboratory, personal communication to M J Blanch, Sept 2003

lower heights as wind flows over more built up-areas. Since the energy content of the wind is proportional to the cube of the wind speed, this reduction could be very significant.

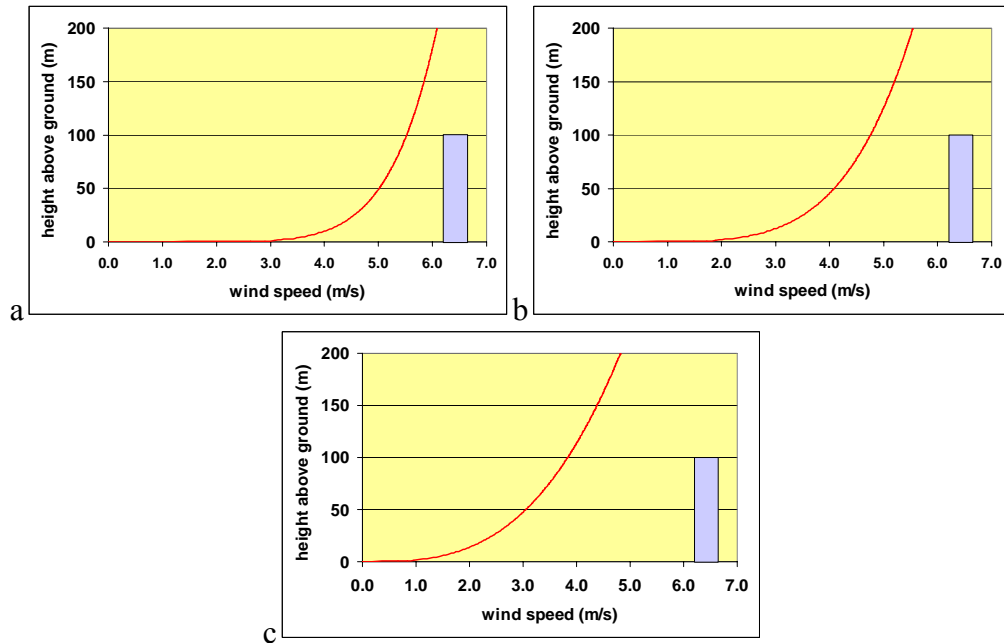

Figure 1-7: Typical velocity profiles showing the relative effect of the frictional slowing of the air in (a) rural location (b) suburban location and (c) city centre location¹⁵

Velocity profiles vary as the wind flows from terrain with one roughness level into another. Figure 1-8 presents the likely modification of the velocity profile¹⁶ as the wind flows from the free field into a new roughness class area representative of flow over buildings. In the model the wind speed was assumed to be zero at a height, d , defined as 0.75 of the average height of buildings in the given area¹⁷. The reduction in mean wind speed depends upon the distance into the urban environment and the height of buildings that the wind has previously encountered.

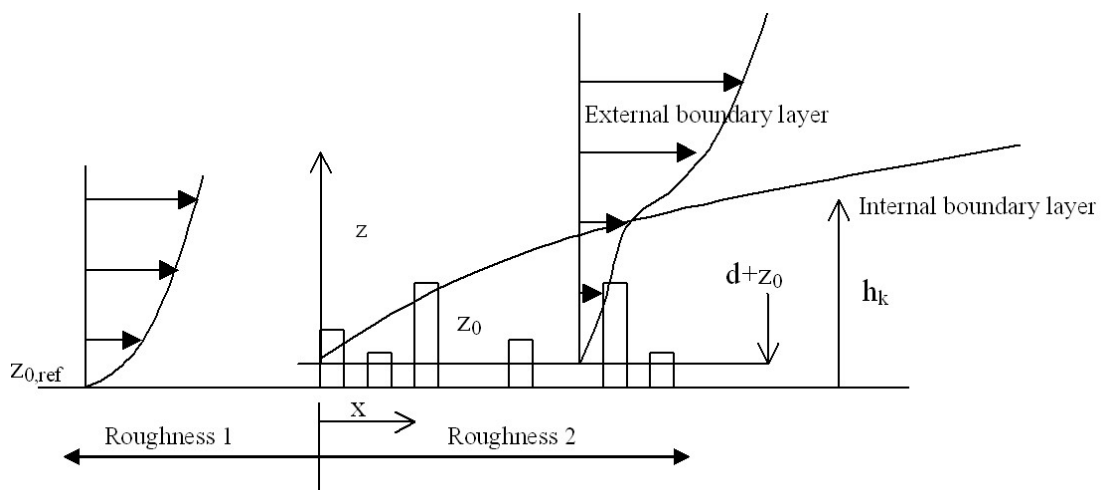

Figure 1-8: Effect of step roughness change into an urban environment

¹⁵ Campbell, N., Stankovic, S - Editors, *Wind energy for the built environment (Project WEB)*, 88 page book, September 2001

¹⁶ Mertens, S., “*The Wind Conditions at flat roofs for small wind turbines*”, Proc EWEC 2003, Madrid, 16-19 June 2003, Fig 1

¹⁷ Ground level in classic boundary layer modelling is assumed to be at the roughness height

1.4.2 Modelling flow fields around buildings

Buildings cause flow separation, which can lead to zones of high turbulence intensity and velocity gradients, which could be problematic for micro wind turbines. To visualise these potential problems, the company Renewable Devices¹⁸ has simulated the wind flow around a building (Figure 1-9) and analysed the turbulence intensity and velocity gradients.

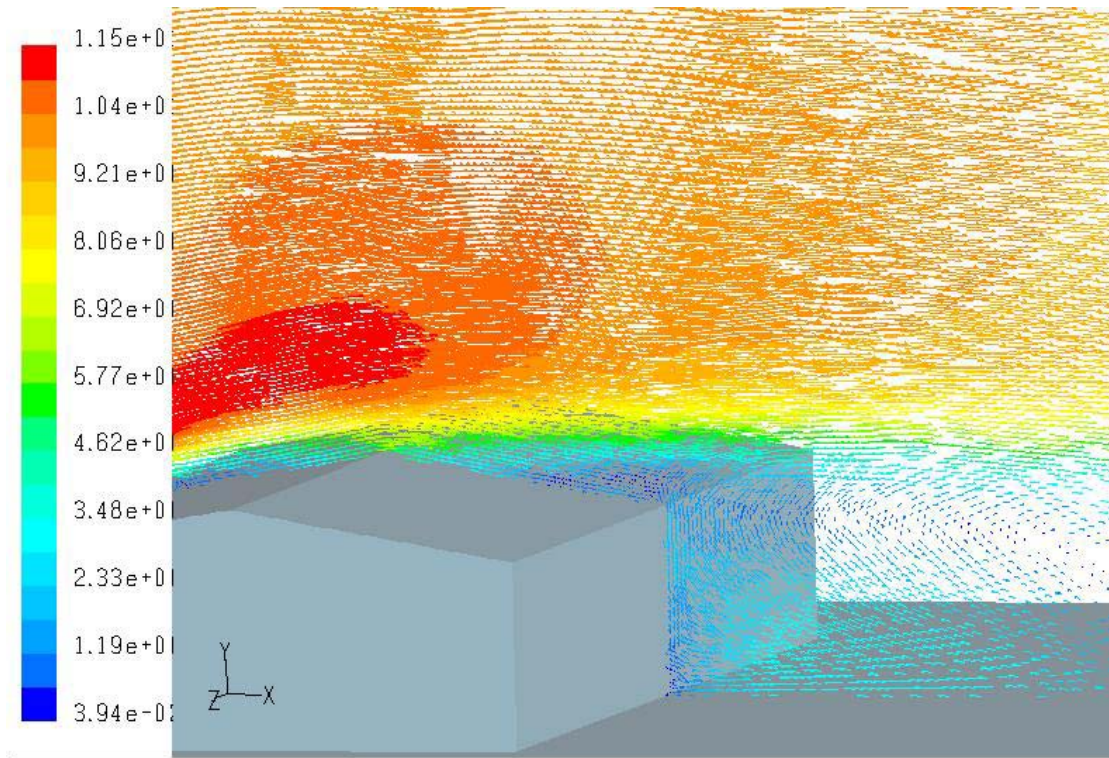

Figure 1-9: Velocity magnitude in the lee of a building

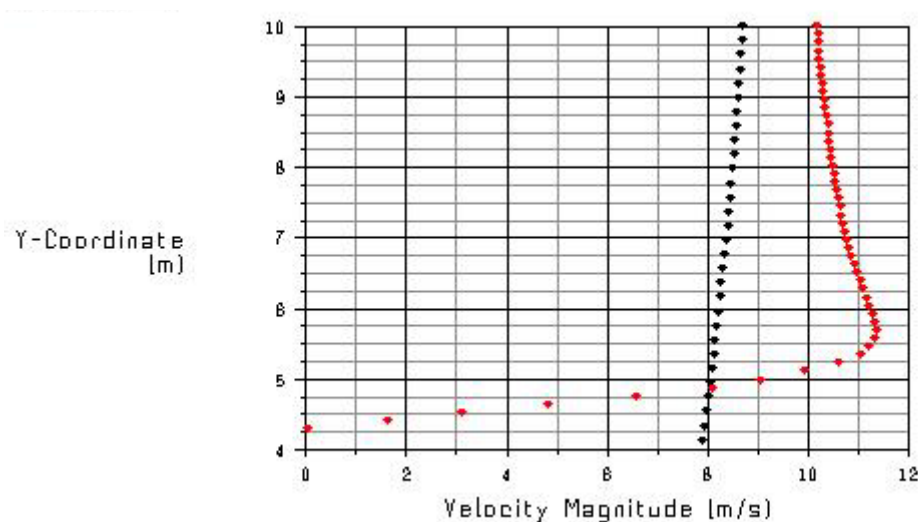

Figure 1-10: Velocity Profile above roof against inlet profile showing the velocity profile with (red points) and without (black points) the building present

¹⁸ Renewable Devices, Rooftop Wind Energy System™, Detailed Wind Energy Assessment, 2003.

Figure 1-10 elucidates the speed up effect (identified by the red region above the building in Figure 1-9). For this specific building, the maximum velocity enhancement was estimated to be from 8 to 11.25 m/s at approximately 5.75 m height (c.f. building height of 4 m) and yields a theoretical percentage increase in power produced at that one location of about 180%.

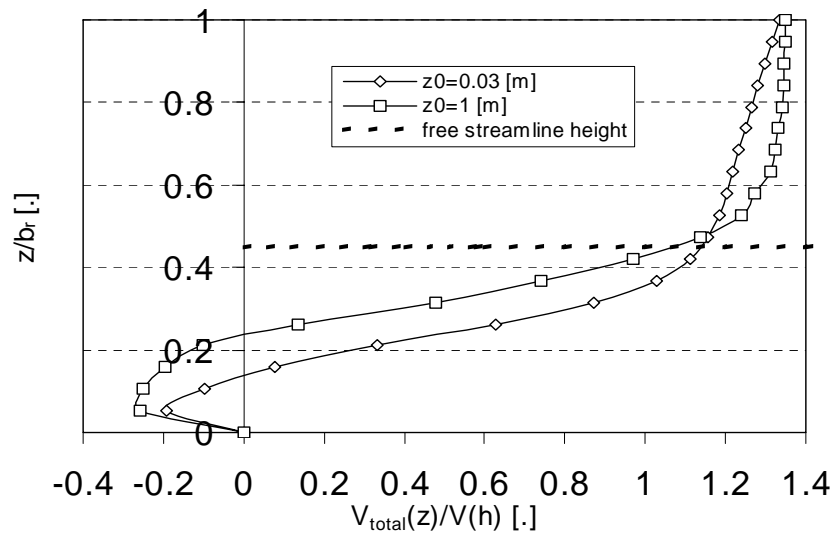

Figure 1-11: Total velocity profiles on the centreline above a flat roof normalised by the undisturbed velocity at building height $V(h)$ and the building breadth, b_r , based on a 2D model. Z_0 is the topography roughness height¹⁹

Mertens has done a similar analysis of the velocity profiles above a roof for different roughness conditions. Figure 1-11 shows the non-dimensionalised velocity profile above the middle of a flat roof. The indicated roughness $z_0 = 0.03$ m is equivalent to the roughness of an open plain and $z_0 = 1$ m is equivalent to that of a city centre. The findings are similar that “above the separating streamline calculated with free streamline theory there exists up to 30 % higher total velocities compared to the undisturbed velocity at building height. Higher above the roof this speed-up effect becomes bigger.”

Mertens²⁰ has further developed this 2D model into a 3D study of a building where $L \times d \times h = 30 \times 10 \times 20$ m. The results ‘are more or less the same compared to the 2D building graphs²¹.

These modelling results indicate that there are regions of flow above roofs where the velocity is significantly enhanced. However, these enhanced wind speed regions are also associated with high wind speed gradients above the roof – an enhancement of natural wind shear, which must be accounted for in the wind turbine design.

Wind Dam independently reached similar conclusions to Renewable Devices on the speed-up zone over the ridge of a roof, noting that “a project that may not have seemed feasible through an initial assessment could be feasible if the turbine was designed to operate in the higher shear velocity at maximum speed-up”²².

¹⁹ Mertens, S., *Wind description for roof location of wind turbines; a design guideline or the required height of a wind turbine on a horizontal roof of a mid- to high-rise building*, Proc Global Windpower, Paris, France, 2-5 April 2002, Fig 5.

²⁰ Mertens, S., *The wind conditions at flat roofs for small wind turbines*, Proc EWEC 2003, Madrid, Spain, 16-19 June 2003.

²¹ Mertens, S., TU Delft, Personal correspondence to M J Blanch, October 2003.

²² Andrew Hunt, Wind Dam, Personal correspondence to M J Blanch, Jan 2004.

1.4.3 UWERN Urban Meteorology Programme

Another approach has been taken by the UWERN Urban Meteorology Programme²³ (http://www.met.rdg.ac.uk/Research/urb_met/) for the assessment and forecasting of air quality, looking particularly at air mixing and transport, fluxes, and energy balance in urban areas.

Omduth Coceal and Stephen Belcher of the Department of Meteorology of the University of Reading are carrying out a project called *Modelling Winds over Urban Areas* to study the effect of urban areas on incident winds. Mean properties of the wind velocity have been computed by treating an urban area as a porous region of distributed drag. In this so-called “urban canopy” model, numerical and analytical computations have been performed with the addition of an extra drag force to the averaged Navier-Stokes equations. The adjustment of a rural boundary layer to an urban canopy has been investigated, and also flow through an inhomogeneous canopy, characterised, for example, by a change in building density. An integral part of the project is to develop numerical closure models of airflow within and above an urban canopy. Applying the canopy model to Los Angeles, Coceal and Belcher found (Figure 1-12) that there is a speed up effect in the inner city (i.e. the ratio of wind speed in Los Angeles, U_2 , to the initial open terrain wind speed, U_1 , is greater than 1) at heights lower than 5 meters.

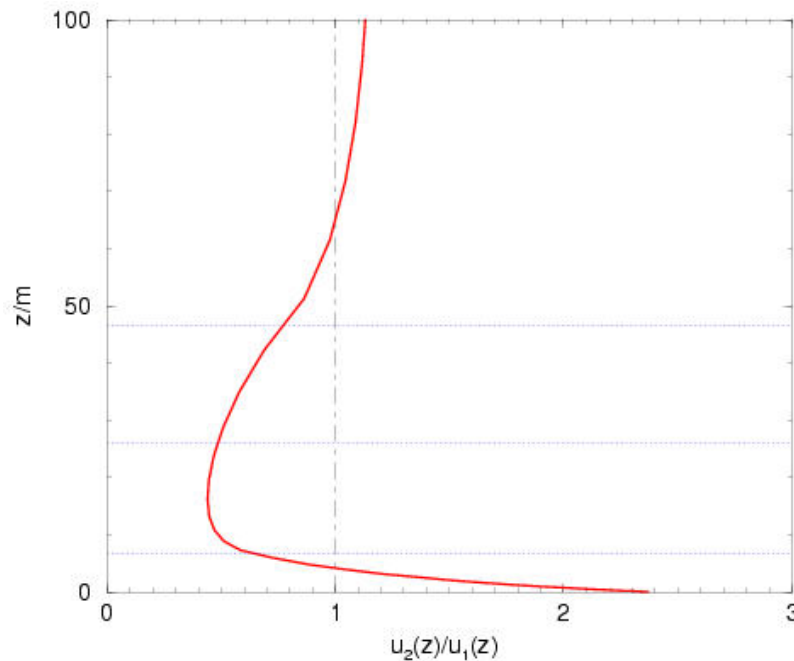

Figure 1-12: An inhomogeneous canopy simulation of Los Angeles, USA (z = height, U_1 = initial velocity, and U_2 = velocity in LA)

1.4.4 Flows assessed as part of building design

Computational Fluid Dynamics (CFD) (e.g. Figure 1-9) and wind tunnel modelling are often used in building design, for example, to assess the impact of a new development on pedestrian wind comfort at ground level. These techniques could be adapted in the context of integrating turbines into a major new building design, but a simpler method is needed for smaller projects.

²³ Belcher, S.E., “Strategy for the UWERN Urban Meteorology Programme Overview”, http://www.met.rdg.ac.uk/Research/urb_met/strategy/overview.html

1.4.5 Conclusions about the effects of buildings on wind resource

Mean wind speed in an urban area depends on distance from the boundary of the urban area, the relative heights and orientations of nearby buildings, and the height and orientation of the building of interest. Buildings taller than their surroundings experience less wind speed reduction at their highest floors since they are much less effected by any internal urban boundary layer.

R&D Priority 1 in section 5 is for further resource assessment in a variety of urban environments.

The local effect of buildings on air flow indicate regions of higher speed flow around and over buildings, often associated with regions of high turbulence wind shear, indicating that wind turbines need to be specifically designed (and certified) to survive the resulting high loadings.

R&D Priorities 2 and 3 in section 5 are concerned with developing a better understanding of flow characteristics around buildings.

Conventional approaches to wind resource assessment are therefore unlikely to be sufficient for estimating likely energy yield. Although the basic exposure of a site may be obtained from meteorological records and generally available surveys, the appropriateness of the site must be studied in detail with consideration of the velocity profile, local roughness height and specific individual features such as nearby buildings, trees, and other possible flow obstacles.

1.5 Wind turbine basics

1.5.1 Power available in the wind

The power in the wind can be expressed as:

$$P_W = 0.5 \rho A v^3 \quad [1]$$

where P_W = power in the wind (W), ρ = air density (kg/m^3), v = wind speed (m/s), A = swept area of rotor (m^2). The power in the wind increases with the cube of the wind speed, which explains why wind turbines tend to be located at relatively windy sites and the trend towards increased tower height to raise the turbine higher into the air stream. Since the power is also proportional to the swept area, the mean diameter of rotors has also been steadily increasing.

1.5.2 Power produced by a turbine and the power coefficient, C_P

The coefficient of power, C_P , is the ratio of power from a turbine (P_T) to the power available in the wind and therefore indicates how effective a turbine is at extracting power:

$$C_P = \frac{P_T}{0.5 \rho A v_1^3} \quad [2]$$

C_P for a particular turbine varies with the ratio of rotor speed to wind speed. The ratio of the speed of the rotor tip to the wind speed is called the tip speed ratio, TSR, or, more commonly, λ .

A wind turbine is only able to remove some of the power available in the wind because the air needs to continue to pass through the turbine for it to operate, limiting the kinetic energy available for extraction. Using actuator disc theory the theoretical (or Betz) maximum limit on the fraction of power that can be removed from the wind by a non-augmented wind turbine is $16/27 = 0.593$ (59.3 %). Glauert determined the ideal efficiency (lower than the Betz limit) for a propeller type wind turbine, shown in Figure 1-13. Practical turbines in real air flows extract less

power than ideally. Figure 1-13 shows performance curves for a range of common wind turbine types²⁴, including Marlec's 2-bladed 1800 turbine, a common ~2 m diameter small wind turbine.

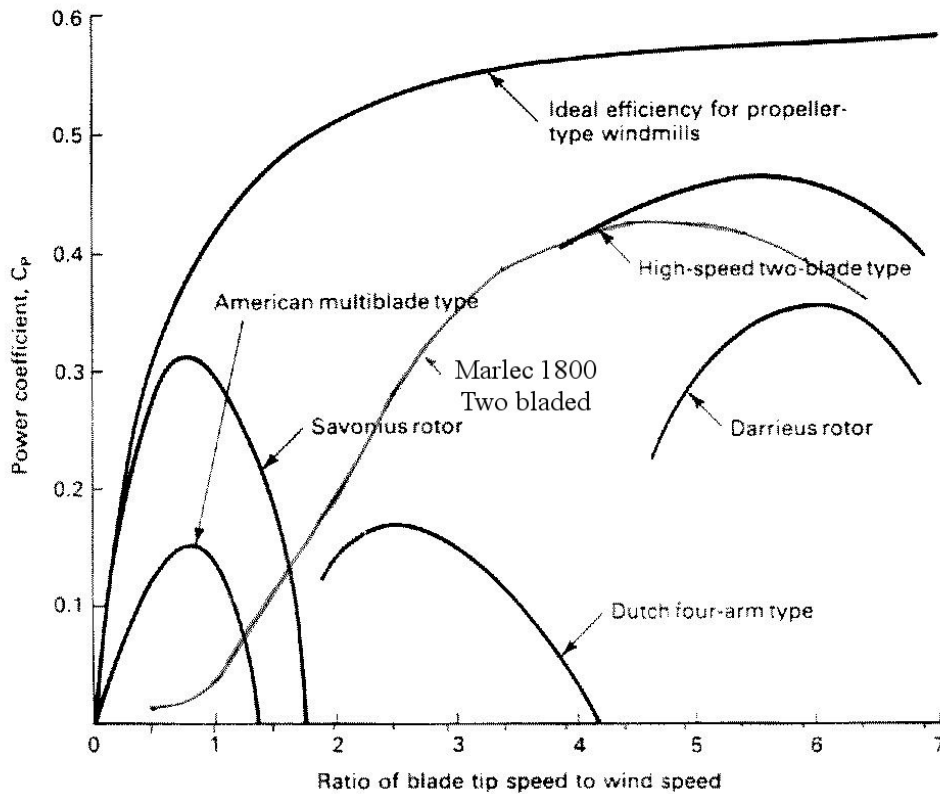

Figure 1-13: C_p vs λ curves for various turbine configurations

By varying the wind speed/rotor speed relationship, some turbines can operate at the highest possible C_p for a range of wind speed. This is called maximum power point tracking. Figure 1-14 shows the power curve for the Renewable Device's Swift²⁵ wind turbine, which is a maximum power point tracking turbine (up to the rated wind speed). C_p also depends on the number of blades, blade plan-form, twist, aerofoil section, Reynolds number, and turbulence level.

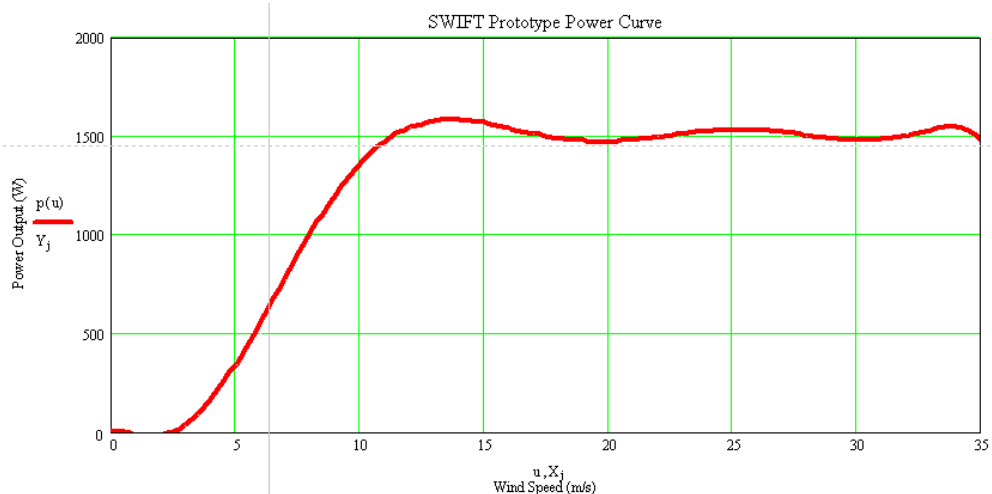

Figure 1-14: Measured power curve for Renewable Devices' Prototype Swift BUWT

²⁴ Gary L Johnson, *Wind Energy Systems*, Prentice-Hall, 1985, Figure 1.8,

²⁵ Adam Steinitz, Renewable Devices Ltd, Personal correspondence to M J Blanch, Nov 2003.

A wind turbine can be tuned to capture maximum energy at a specific site by altering the rated wind speed of operation. A typical guide rule is to make rated wind speed equal to half the site average wind speed.

R&D Priorities 7 to 9 in section 5 are concerned with optimising wind turbine design for the BUWT situation.

1.5.3 Limits on power produced

A wind turbine requires sufficient flow of air for it to start and this is characterised by the cut-in wind speed. Figure 1-14 shows the cut-in wind speed for the Swift to be about 2.5 m/s. The forces on a turbine increase with the square of the wind speed so they can grow to be strong enough to destroy the turbine if they are not accounted for and the level they can reach controlled. For the Swift turbine the power curve flattens out at 1500 W and 12 m/s because it has been designed to turn out of the wind or furl. The Proven WT range regulates power by allowing the turbine blades to deflect which results in a similar power curve shape to the Swift's. Micro Wind turbines tend to continue to generate at high wind speed, by contrast with Large Wind turbines which have a cut out speed when the turbine rotor is stopped to protect the turbine.

1.5.4 Summary of wind turbine basics

The power in the wind is proportional to the cube of the wind velocity. At low wind speeds, wind turbines are designed to perform as close to Glauert's ideal propeller turbine performance as possible, but at higher speeds they are regulated by furling, stalling, or reducing the blade pitch (feathering) to keep the forces at manageable levels. The turbine's performance combined with the available wind regime will determine the annual energy yield and thus the value of the energy generated. The cost effectiveness of the installation is measured by the payback period i.e. how long it takes for the value of the energy produced to exceed the capital and running costs of the turbine system.

1.6 Building Integrated/Mounted Wind Turbines (BUWTS)

Building integrated/mounted wind turbine (BUWT) is a generic term defined to include any wind turbine that can be incorporated within the built environment (i.e. close to or on buildings); this need not necessarily be in an urban environment²⁶.

In both building mounted and building adjacent cases the building shape and/or the turbine location is expected to be designed to maximise cost effective power output within noise and vibration limits.

The idea of integrating wind power and buildings is not new, as historically many windmills, wind-driven saw mills, and wind-driven water pumps doubled as homes and were very important features of the built environment. However, windmills tended to be located in more rural areas and did not include any augmentation techniques other than raising the height of the windmill.

It is not easy to define limits on the size of BUWTs. The EC-funded WEB Concentrator²⁷ project envisaged a new very tall building incorporating one or more 30 m diameter 250 kW turbines.

²⁶ The term Urban Wind Energy Conversion Systems (UWECS) is also sometimes used, but is not as general

²⁷ Campbell, N., Stankovic, S - Editors, *Wind energy for the built environment (Project WEB)*, 88 page book, September 2001

Retrofitting turbines to a building might suggest small 2 meter diameter HAWTs, but for large flat roofs retrofitted turbines could have a considerably larger capacity.

1.6.1 Building integrated wind turbines

Building integrated wind turbines are turbines capable of working close to buildings and exploiting where possible any augmentation that the building causes to the local wind flow. They can be supported independently to the building but will either be accounted for, or be incorporated within, the building design.

1.6.2 Building mounted wind turbines

Building mounted wind turbines are physically linked to the building structure. The building is effectively being used as a tower to place the turbine in a desirable wind flow (e.g. on top of a tower block). Whatever the type of building mounted wind turbine employed, the structure must be able to support the turbine both in terms of loads and within noise and vibration constraints.

1.6.3 Building Augmented Wind Turbines (BAWTs)

Where building mounted wind turbines are integrated in such a way that the building is used to deliberately alter and augment the flow into a turbine they can be referred to as Building Augmented Wind Turbines (BAWTs). For retrofit applications BAWTs can only be positioned to exploit any augmentation afforded by the existing building. For new build applications the building could be specifically designed to augment the flow through the turbines. The building design may require relatively minor modification of the building shape or the use of rather complex 3-D sculpting of the shape of the building.

Examples of BAWTs include the WEB Concentrator, where one or more turbines were envisaged suspended between two kidney-section towers, and Altechnica's various patented planar concentrating building wind systems²⁸. Altechnica's *Aeolian Roof*TM combines a curved or dual pitch roof with a wing-like concentrator, which creates a slot above the ridge within which axial flow or cross flow turbines exploit an enhanced flow region. Similarly, in the case of the *Aeolian Tower*TM/*Corner*TM, wind turbines are inserted in a vertical slot aligned with the corner of a tall building. Altechnica's other variants employ various forms of *Planar Concentrators*TM in close proximity to the building to enhance the wind speed and energy production.

1.7 Conventionally sited Small/Micro Wind turbines

BUWTs include a subset of the Small Wind category and share numerous similarities with conventionally sited turbines less than 100 kW (about 22 m in diameter). However, the mind set for integrating BUWT turbines with buildings is noticeably different, since Small and even Micro Turbines are conventionally installed some distance away from buildings to avoid the flow into the turbine being unduly reduced or disturbed by the buildings. Installing small wind turbines in this way is an established technology and general siting guidelines are specified by, for example, the American Wind Energy Association (AWEA) who suggest that the minimum land requirement for a small wind installation capable of powering a whole house is 1 acre =

²⁸ Derek Taylor, *Using Buildings to Harness Wind Energy*, Building Research and Information, 1998, 26 (3), pp 199-202 & *Altechnica AeroSolar & Aeolian Roof Wind System, Aeolian SolAirfoil*, April 1999.

4047 m² = 64 m x 64 m²⁹. US masts are typically tall and guyed and so need a lot of space; the average US home also uses around 2.5 times as much electricity as the typical UK home³⁰. In the UK, Proven have sited turbines on their self-supporting masts in small gardens and as close as 10 m to the house³¹. In the UK the average household electrical end-use demand is about 4,450 kWh/year, equivalent to a 1.7 kW turbine achieving an average 30% of its rated power per year.

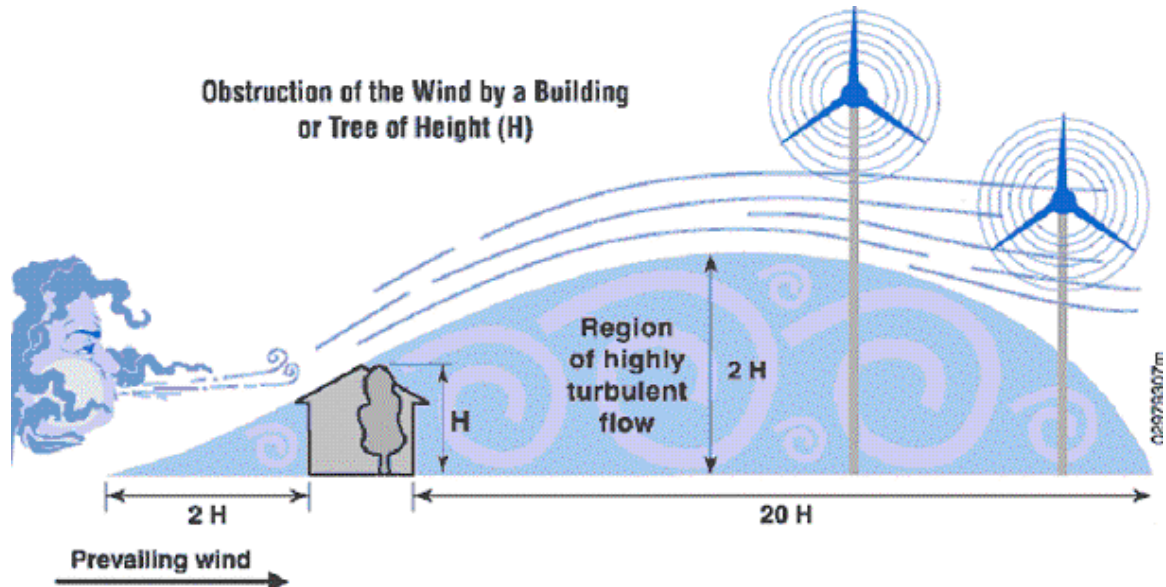

Figure 1-15: Schematic of the effect of obstacles on wind flow³²

Another guideline used by one UK installer is “to place the turbine at a distance from any obstacle (building etc) of at least ten times the height of the obstacle; or on a tower that is at least twice that height”³³. This avoids “locations with excessive gustiness or turbulence, since they will reduce the output from a wind turbine and lead to undue wear and strain on component parts.”

Figure 1-15 from AWEA suggests that a separation distance of 20 times the height of the obstacle is needed. However, increasing the separation distance between the turbine and the point of use of the power also increases the power losses in cables. If this necessitates using a cable with larger cores to reduce these losses then the cost and embodied energy in the system increases and a taller tower becomes more attractive. If there are wind directions from which the wind seldom blows or only blows relatively lightly then the turbines can be nearer buildings in these directions. However without measuring the wind speed and direction at the proposed location and doing a cross comparison with a site with many years of data to account for local topographical effects and the longer term wind pattern, the identification of low wind speed directions retains an element of guesswork. Siting a conventional small wind turbine is a good energy solution provided a large enough plot of land is available; in the UK this means a minimum separation distance of 10 m from the nearest building to the turbine (although a 4 m separation has sometimes been satisfactorily achieved; e.g. a 2.5 kW Proven machine is 4 m from the Hofn Youth Centre, Westray, Orkney on a tower over twice the height of the building

²⁹ AWEA slide show, <http://www.awea.org/pubs/documents/swslides/toc.htm>, Sept 2003

³⁰ 10,519 kWh/year for a US home (www.eia.doe.gov/cneaf/electricity/california/statistics.html); 4,450 kWh/year for a UK home (DTI, *UK Energy in Brief*, July 2003 – see also section 4.3)

³¹ Gordon Proven, Proven, Personal correspondence to M J Blanch, Jan 2004

³² AWEA slide show <http://www.awea.org/pubs/documents/swslides/toc.htm>, Aug 2003

³³ Wind & Sun, <http://www.windandsun.co.uk/>, Oct 2003

where “you can just hear the turbine inside if you listen for it”³⁴). However, even if the 4m distance is applied, for the majority of the population having an 8 m separation between adjacent buildings in order to site a turbine between them is not possible.

Small Wind is itself a significant resource that is often overlooked. AWEA estimates³⁵ that by 2020 small wind turbines could contribute 3% of the USA’s electricity demand.

1.8 Influence of external factors in considering the feasibility of BUWTs

1.8.1 Higher wind speeds so more power

The conventional wind industry typically looks for high wind speed sites on which it installs the largest turbines possible and uses the grid to transport the power to where it is needed. Since the power in the wind is proportional to the cube of the wind speed, comparatively more power can be generated at a windy site than is lost in transporting to an end user at a less windy site. For example, the transmission loss from the North Scotland to the South coast of England is 6%³⁶.

Consideration of a BUWT installation may initially come about given the presence of a building in a high wind speed area. However it may also arise from a consideration of where the highest wind speeds are in a built environment. Buildings themselves can cause local wind speed increases which are routinely considered in the design of large buildings to ensure that the wind speed isn’t increased beyond acceptable levels at street levels and particularly in pedestrian areas. It may be possible to concentrate and utilise these otherwise unwanted increases.

1.8.2 Lower energy costs for point of use generation

For remote off-grid applications the turbine will usually charge a battery when the wind blows and the application can then draw power from the battery as required. One example is Trinity House Lighthouse Service, which needs to power remote systems where wind turbines have proved cost effective.

For an on-grid application fed into the consumer side of the meter, energy generated is worth at least the price charged by the electrical supply company – the retail electricity price. This price is well in excess of that which would be paid for conventional electrical energy by a utility company, since the average wholesale electricity price is about 2 p/kWh (equivalent to the average cost of energy from a Combined Cycle Gas Turbine). In Section 1.2 of this report Small Wind prices were observed to be in the range of 3 to 8 p/kWh in the UK which in some circumstances undercuts the current retail electricity price of 6.5 p/kWh.

For an on-grid application fed directly into the grid itself, which could be used when selling energy at a premium price to someone else, Transmission Network Use of System (TNUoS) charges are not incurred³⁷ provided the buyer is in the same Grid Supply Point (GSP) Group.

³⁴ Bryan Rendall, Bryan J Rendall (Electrical) Ltd, Personal correspondence to M J Blanch, Jan 2004.

³⁵ American Wind Energy Association, *U.S. Small Wind Turbine Industry Roadmap, A 20-year industry plan for small wind turbine technology*, June 2002, <http://www.awea.org/smallwind/documents/31958.pdf>

³⁶ David Milborrow, *The North South Imbalance*, WindPower Monthly, October 2003, pg 48

³⁷ www.ofgem.gov.uk/ofgem/microsites/microtemplate1.jsp?toplevel=/microsites/smallergenerators&assortment=/microsites/smallergenerators/chargesandbenefits

1.8.3 Meeting government building energy use targets

In an attempt to reduce the energy use of the building sector the EU's Energy Performance of Buildings directive³⁸ (EPBD) became law during the course of the project and is currently being transposed into UK Regulations via Part L of the Building Regulations. Specifically, Article 5 of the EPBD calls for an assessment of the feasibility of alternative energy supplied for new buildings in excess of 1000m². It is due to be implemented in January 2006.

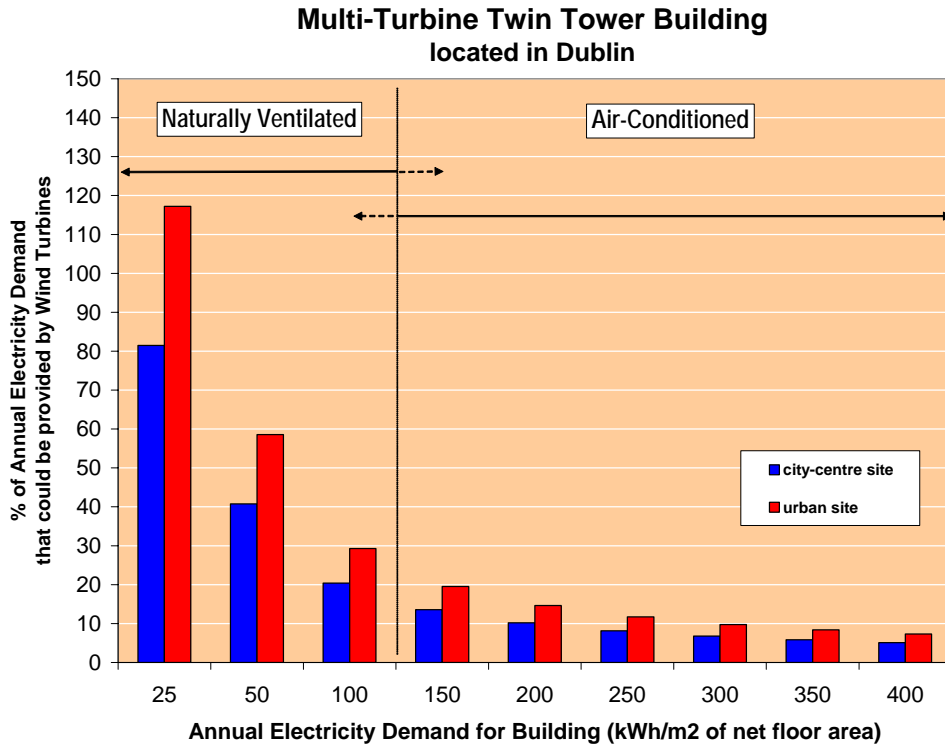

Figure 1-16: Ability of the WEB Concentrator building, if sited in Dublin, to supply its annual electrical needs from wind turbines

The WEB Project found that energy generated by wind turbines incorporated into a WEB Twin Tower building could meet a large percentage of the electricity end-use demand, based on limited real data for different types of commercial office building in the UK from ECON1939.

Figure 1-16 shows the percentage levels of electricity that could be supplied by a BUWT installation of increasing net floor area in Dublin. Dublin has a fairly low average wind speed of 4.57 m/s at 30 m. The graph indicates that, when a turbine is integrated on/in/around a building, the maximum proportional contribution to the building's energy demand depends on the building itself being energy efficient (e.g. well insulated, naturally ventilated). It is perhaps worth noting that if a wind turbine is associated with a naturally ventilated building then it must be sufficiently quiet that it does not conflict with the inhabitants' desire to open the windows or comfort levels may be compromised.

It is difficult to define a typical energy use of a building as a comparator since annual energy demand varies according to building use (e.g. domestic, industrial, commercial etc.) and within

³⁸ EU, Directive 2002/91/EC of the European Parliament and of the Council of 16 December 2002 on the energy performance of buildings, Brussels, 04.01.2003,

http://europa.eu.int/comm/energy/demand/legislation/buildings_en.htm

³⁹ Energy efficiency Best Practise Programme, *Energy Consumption Guide 19 Energy Use in Buildings*, 2000

each of these there can be many sub-categories⁴⁰. For example, in the case shown, if the annual electricity demand is, say, less than 100 kWh/m² (of floor area) then the turbines in this case could supply a reasonable fraction of this (20-30+%) on an annual basis, but if the building were heavily serviced (i.e. fully air-conditioned with lots of computer suites etc.) then the proportion would be lower.

If it had been assumed instead that the WEB tower was residential (i.e. naturally-ventilated flats rather than offices), it is likely that the annual electricity demand could be much less than 100 kWh/m² in which case the turbines would supply a larger fraction (say, 40 to 60+%) on an annual basis. Whether the WEB Twin Tower Building could achieve these energy demands in reality would depend on the detailed design.

1.8.4 Potential for price reduction

Conventional (large) onshore wind energy continues to fall in price and is forecast by Milborrow to be the cheapest option for electricity generation by 2020, even without taking external costs into consideration⁴¹.

AWEA has also identified further technical improvements which could be made to small turbines. The performance of small turbines can be expected to improve and with it their cost effectiveness.

BUWTs can expect to benefit from these falling trends. The main driver for BUWT cost reduction will be mass production supplemented by design improvements and industry maturity.

1.8.5 Clear Skies and Scottish Community and Household Renewables initiatives

The Clear Skies initiative supports renewable energy projects in England, Wales and Northern Ireland, whereas the Scottish Community and Household Renewables Initiative (SCHRI) have a similar remit for Scotland⁴².

Household grants for wind turbines are currently offered by Clear Skies at £1000 per kW_e installed up to a maximum of £5000. Installations must be larger than 0.5 kW_e. There is no maximum size though the grant is capped at £5000. The grant is based on the turbine rating at a wind speed of 12 m/s⁴³. There are currently 22 registered wind turbine installers.

For community grants, the size of the grant is the lower of 50% of the installed cost or £100,000 regardless of the renewable technology.

1.8.6 Support from the Renewables Obligation

The Government has raised the level of the Renewables Obligation (RO) – dictating how much energy suppliers must provide from green power – beyond 2010-11, to 2015-16. This is expected to lead to the development of enough renewable energy to power up to 3 million additional homes⁴⁴.

⁴⁰ Action Energy, *Small Commercial Offices Factsheet* (FSSB003), V1 26/09/03,
<http://www.actionenergy.org.uk/downloads/FSSB003.pdf>

⁴¹ David Milborrow, *On track as the cheapest in town*, Wind Power Monthly, January 2002, pp30-32

⁴² <http://www.est.co.uk/schri>

⁴³ <http://www.clear-skies.org/communities/GrantsAndTechnologies.aspx?intTechnologyID=2>

⁴⁴ DTI, “Government Gives Green Light To Renewable Future”, Press Release 2003

The level of the RO was 3% when it was introduced last year. It now stands at 4.3%, and will increase each year to reach 10.4% in 2010-11. It will then increase beyond 2010-11 as follows:

2011-12: 11.4%

2012-13: 12.4%

2013-14: 13.4%

2014-15: 14.4%

2015-16: 15.4%

Also the Department of Trade and Industry (DTI) has announced a new certification system that will provide a boost for renewable energy generators⁴⁵. The Renewable Energy Guarantee of Origin (REGO) scheme will enable all producers of electricity from renewable energy sources to request electronic certificates, which will be issued by the energy regulator, Ofgen. The scheme will be particularly helpful to small generators which do not generate enough electricity to qualify for Renewable Obligation Certificates (ROCs). The REGOs will be issued in units of 1 kWh and, along with the proposals to relax the qualifying conditions for ROCs, this will make the scheme attractive to smaller generators. The scheme will work alongside the existing ROCs which are only available to generators producing more than 0.5 MWh per month from specified renewable sources.

1.8.7 The Climate Change Levy

The Climate Change Levy is a tax on energy use which was introduced in the UK in April 2001. It is a tax on energy use in UK businesses, covering industry, commerce and agriculture, as well as the public sector, intended to encourage energy saving and the installation of energy saving measures. There are a number of exemptions and discounts available to users who take measures to reduce energy use. Supplies of electricity from renewable sources are also exempt from the levy. The tax is imposed on the supplier, but passed on to the consumer at the rate of 0.43 pence per kilowatt hour (kWh) for electricity, 0.15 pence per kWh for gas, 1.17 pence per kWh for coal, and 0.96 pence per kWh for liquid petroleum gas (LPG).

1.8.8 Complementarity to solar power

Whether the primary energy need is for heat or electricity, BUWTs can be used in parallel with either solar water heating or solar photovoltaics. The obvious benefit of a BUWT is that power can be generated after the sun has set and also that cloudy days do tend to be windier. Wind has a far better seasonal energy demand match than solar (Figure 1-3). Photovoltaics are not supported by the Clear Skies initiative (www.clear-skies.org) but by the major photovoltaic (PV) demonstration programme (<http://www.est.org.uk/solar/>) which has so far supported 569 PV installations and is due to finish in 2006.

Altechnica's *AeroSolar*TM variants of its patented *Aeolian Roof*TM, *Aeolian Tower*TM and its other *Planar Concentrators*TM include solar thermal and/or photovoltaic modules as part of their concentrating surfaces. Also, University of Strathclyde's Ducted Wind Turbine modules can incorporate solar panels. As such these are considered to be wind-solar hybrid technologies intended to take advantage of the complementary nature of the two sources of energy.

⁴⁵ IEE, Engineering for a Sustainable Future News, 2003-10-23.

1.8.9 Avoidance of the barriers of Large On-shore Wind

For onshore wind, the Carbon Trust *Options* report notes that the main barriers to deployment are grid connection and public acceptability⁴⁶. However Small/Micro on-shore wind does not face these barriers. Grid-connected BUWTs are connected into the low voltage distribution network (usually on the customer's side of the meter) and are primarily sized to effectively supply the base load of one user or a small multiple of this. Grid-connection is therefore not such a limiting factor for distributed generation in BUWTs.

Public acceptability of micro turbines is a different issue to that of large turbines because the main visual impact, noise (if there is any), and construction disturbance occurs to the land-owner and possibly the immediate neighbours. In the built environment micro turbines won't be any more man-made than most of their environment and the turbine is likely to be at least at roof level to exploit speed-up effects where it is less likely to appear imposing. In the case of all of Altechnica's patented Aeolian Planar Concentrator™ range of BUWTs, the turbines are enclosed and can be screened such that they would be practically invisible⁴⁷.

1.8.10 Clearer planning permission guidance

Planning Policy Statement 22 (PPS22) was issued in August 2004. Clause 18 states:

“Local planning authorities and developers should consider the opportunity for incorporating renewable energy projects in all new developments. Small scale renewable energy schemes utilising technologies such as solar panels, Biomass heating, small scale wind turbines, photovoltaic cells and combined heat and power schemes can be incorporated both into new developments and some existing buildings. Local planning authorities should specifically encourage such schemes through positively expressed policies in local development documents.”⁴⁸

The company Renewable Devices reports good support from planners⁴⁹.

1.8.11 Better grid connection standard, G83

ERG83 is set to replace ER G77/1 to provide the connection standards for small embedded systems (including wind energy). There was an October 2003 deadline for comments to the Distribution Code Review Panel on the “Engineering Recommendation G83 - Recommendations For The Connection Of Small-Scale Embedded Generators (Up To 16 A Per Phase) In Parallel With Public Low-Voltage Distribution Networks”⁵⁰. These recommendations will make connecting wind turbines to the grid simpler.

1.8.12 Interest from architects in fitting wind turbines to buildings

Architects are showing interest in incorporating wind turbines into buildings. Leading architectural practices such as Richard Rogers Partnership and innovative new architectural practices such as Bill Dunster Associates have included BUWTs in their conceptual designs and

⁴⁶ The Carbon Trust, *Building Options for UK Renewable Energy*, Oct 2003, p.12.

⁴⁷ Derek Taylor, Altechnica, Personal correspondence to M J Blanch, Jan 2004

⁴⁸ Planning Policy Statement 22: Renewable Energy, DTI,
http://www.odpm.gov.uk/stellent/groups/odpm_planning/documents/downloadable/odpm_plan_030335.pdf

⁴⁹ Charlie Silverton, Renewable Devices, Personal Correspondence, Jan 2004

⁵⁰ www.ofgem.gov.uk/temp/ofgem/cache/cmsattach/1331_consult0802B.pdf, Dec 2003

submissions. Lord Foster is also frequently mentioned in the press as the designer of the large ENERCON E-66 turbine. A number of interesting designs for tall buildings incorporating turbines were included in the "Sky High" Exhibition curated by Lord Foster at the Royal Academy in the summer of 2003.

Another example is Ian Ritchie and Partners who proposed two wind power schemes in a report⁵¹ to their client for a shopping centre redevelopment of a large site in the 'White City' area, namely:

- (i) Multi turbine integrated (i.e. on the building): total rated capacity of 380 kW (19 x 20 kW) producing a total of 1.14 MWh/ year,
- (ii) Single large turbine on minor approach roundabout: total rated capacity of 2 MW producing 5.5 MWh/year.

The figures above are based on manufacturers' quotes at estimated wind speeds of 6m/s and 8m/s at the relative hub heights of 55 m and 80 m respectively.

Another example is the company Cole Thompson Associates who have submitted plans to upgrade Glastonbury House – a 22 storey residential tower in Pimlico, London. Level 23 includes a 4 m high wind turbine⁵².

Altechnica (which offers architectural services) has also produced a number of building designs which incorporate its AeroSolar Aeolian RoofTM/TowerTM and its other Aeolian Planar ConcentratorTM Devices combined with high energy efficiency building design standards to approach or achieve zero emission performance buildings.

1.8.13 Value Added Tax (VAT)

VAT is currently charged on consumables and materials used in demonstration and research into sustainability. Thus a company in receipt of a RD&D grant to develop BUWTs finds that a proportion of its budget goes in VAT. Zero rating such activities would enable more of the budget to be spent on actual RD&D.

A case can also be made for levying zero VAT on any installation that reduces carbon emissions.

1.8.14 UK expertise and interest in BUWT technology

UK academics and industry appear to be at the forefront of investigating the feasibility of installing BUWTs. If this international lead is maintained, then this could eventually lead to export potential for UK companies and increased employment opportunities.

1.9 Potential disadvantages of BUWTs

1.9.1 Turbines failing because they are not robust enough

One critical factor is the imperative need to design and test BUWTs to be intrinsically robust and safe. BUWTs need to be more robust than turbines in rural sites since

- (i) turbulence and wind shear will produce a more complex and more severe loading regime,

⁵¹ Yasser Al-Saheal, Ian Ritchie Architects, Personal communication to M J Blanch, June 2001

⁵² *Green Tower Starts to Rise*, HAC (Building Services Engineering), July/Aug 2003, pp 10

- (ii) there will be more people in their vicinity and hence the risk posed by any hazard is thus greater.

Turbine designs must either have an established performance record in turbulent winds or, for new designs, have sufficient safety margins, preferably incorporate measures to reduce the impact of any potential failure, undergo independent design checks, and be subject to accelerated component testing. Any commercial turbine⁵³ fitted to a building must be at least certified to be compliant with BS EN 16400 and be CE marked. Indeed, additional and /or greater factors of safety than those in BS EN 16400 (which covers conventional turbines) could be required. Specific areas identified are the requirement for intrinsic overspeed protection as the currently required electric load speed limiting is not sufficient to avoid runaway if the load, generator, or circuit goes faulty, and an automatic shutdown facility built in, in the event of excess vibration⁵⁴.

An example of an additional structural element which may benefit safety can be found on the Renewable Devices' Swift turbine, which is a HAWT with a ring connecting the blade tips. The blades are therefore anchored at the hub as with a traditional turbine but additionally anchored at their tips. The ring is intended to reduce tip noise, but also means that any damage to the blades is likely to result in the rotor staying intact (though with increased noise drawing attention to the damage). Some BAWTs (such as Altechnica's devices and the WEB Concentrator) have some level of enclosure from the surrounding structure, which can also include protective grilles. Such devices may incur a small negative impact on the power coefficient. The WindWall BUWT has blades constructed from modular elements so the failure of one element would have a much reduced impact compared to the failure of the whole rotor. A course mesh, able to restrain a failed element, also surrounds the WindWall rotor.

R&D Priority 9, described in section 5.2.3, is related to ensuring failsafe operation.

1.9.2 Lower than expected performance

1.9.2.1 Resource assessment basis in urban areas

The wind regime in urban areas is not fully understood. Estimating the resource is thus difficult without much greater knowledge of how the wind regime within urban areas behaves.

1.9.2.2 Resource assessment in practice

On small, low value installations it is unlikely that more than an estimate of the local wind resource will be made. If the wind speed resource is 25% lower than estimated then the power available in the wind may be only 40% of that expected. It will be best to err on the low side when making wind energy yield assumptions for BUWTs.

1.9.2.3 Wind blocking

Further building in the area of a turbine may reduce its exposure to the wind and could also increase the turbulence in the wind. Tree growth may cause a similar reduction in the wind flow. Thus assessment of the stability of the local natural and built environment to ensure no new obstacles appear is required.

⁵³ A prototype will not be expected to be certified but would be expected to be tested in a remote location

⁵⁴ Gordon Proven, Proven, Personal correspondence to M J Blanch, Feb 2004

1.9.2.4 *New Turbine Performance*

Since there is currently no requirement for performance certification of small turbines, the power output of a new turbine has to be accepted largely on the basis of trust or indeed may not be fully known. Unlike larger wind turbines, performance is unlikely to be part of the purchase contract. In addition, performance testing of small battery charging variable speed wind turbines is actually more complex than for a much larger grid connected turbine so it is unlikely that performance testing will be done by other than the manufacturer prior to sale.

Arguably, there is a need for a certification and performance assessment procedure for wind turbines which will be installed in the urban environment. The dedicated test facility proposed in R&D Priority 3 (see section 5) could be tasked with this additional objective. A major pre-requisite would be the development of a suitable performance certification standard for small machines.

1.9.3 **Concern by some Small Wind manufacturers and practitioners**

The founder of the US company Bergey turbines, Mike Bergey, does not recommend mounting turbines on buildings and wishes “people would stop asking us about mounting turbines on buildings”⁵⁵. Bergey turbines have been mounted on the Green Building in Dublin and encountered problems: the blades cracked – probably due to turbulence loading – and were replaced with new ones by Proven⁵⁶. This highlights the imperative need for BUWTs to be designed and tested to be intrinsically robust for high wind shear and turbulent environments. Charlie Robb of Element Engineering⁵⁷ advises that wind turbines should NEVER be mounted on buildings because of:

- (i) likely very poor performance due to turbulence,
- (ii) transmitted noise through building structures,
- (iii) little thought is ever given to building structural issues,
- (iv) most importantly: ANY wind turbine can break down for an unexpected reason whether properly maintained or not, and sometimes the failure can be catastrophic. It is not possible to make an unguarded rotating machine completely safe in the event of a catastrophic failure. If a building-mounted wind turbine falls down or disintegrates there is a serious risk to people and property. (However, it should be pointed out that rotating fans, for applications such as air conditioning, are already often mounted on buildings within suitably designed enclosures and with appropriate safety control features.)

1.9.4 **Insurance**

Fitting a turbine to a building is likely to increase the building’s insurance premium. This could be high in the early years of development of this technology as fitting turbines to buildings presents a largely unknown risk.

Insurance issues go beyond simple building insurance through to Professional Indemnity Insurance for Engineers and other Professionals. In the commercial environment most clients/consultants tend to be cautious and will need assurances and accredited testing evidence

⁵⁵ Mike Bergey, Personal correspondence to M J Blanch, 09/10/2003

⁵⁶ Gordon Proven, personal communication to M J Blanch, January 2004

⁵⁷ Charlie Robb, Element Engineering, Personal correspondence to M J Blanch, Jan 2004

before specifying such products. This is a non-technical barrier to BUWTs that would warrant further evaluation.

1.10 Summary of section

The UK has the pre-eminent European wind resource with many areas having average wind speeds above 7.5 m/s before any further enhancement from a building. However, population tends to be centred in the predominantly lower wind speed areas and substantial decrease in wind velocity and increase in turbulence can be expected in urban areas. This decrease may be ameliorated to some extent by flow enhancement due to building shape or design. The potential BUWT resource is difficult to estimate due to:

- general uncertainty relating to knowledge of wind regime in built up areas,
- lack of knowledge about local flow effects around buildings,
- the need for cataloguing and categorisation of UK building stock in terms of suitability for BUWT systems.

Specific design and testing guidelines are required for wind turbines in the built environment. Special attention is required to safety issues with regard to the loads experienced by the turbine (in its high wind shear and high turbulence environment) and the structural suitability of the building on which it is mounted. The main technical considerations to be taken into account when designing, installing, and operating a BUWT include:

- Location of the BUWT on the building,
- Occurrence of high turbulence levels and veering or swirling winds and the resulting implications for fatigue damage,
- Noise reduction,
- Appropriate wind turbine design – blade design and the influence of Reynold's number, safety (in particular, containment of failed rotors), minimisation of maintenance requirements,
- Mounting arrangements – security of anchoring, vibration isolation,
- Electrical connection,

Capital cost reduction.

2. Surveying and Assessing BUWT Technologies

2.1 Introduction

This section presents the results from a comprehensive survey of BUWT technologies, covering some 41 different devices with detailed descriptions for a selection of these.

A number of new research and prototype turbines had just been, or were about to be, launched at the time of the survey in early 2004. Also, existing turbine manufacturers who had previously only supplied turbines for conventional mounting on a separate mast were starting to market models suitable for mounting on buildings (e.g. Proven, Ropatec, and Fortis).

2.2 Historical BUWTs and existing uses of wind power in buildings

The energy in the wind is currently harnessed in the built environment to achieve passive ventilation, wind-assisted passive ventilation, and power generation. The classical application of wind energy in buildings was, of course, the familiar windmill usually used for water-pumping or corn-grinding.

2.2.1 Passive ventilation (no moving parts).

Passive ventilation is an established technology: buildings have been successfully designed and built incorporating passive ventilation stacks (e.g. Portcullis House⁵⁸, which houses MPs, and the BRE building⁵⁹). These use the wind to suck out (stale, hot, cold) air without forced ventilation. Passive ventilation can be supplemented with occasional fan-assisted or forced ventilation for periods of high load.



Figure 2-1: BRE's environmental buildings at Garston, NE London (left) and Portcullis House in Central London (right) which both incorporate passive stack ventilation towers

2.2.2 Active wind-powered ventilation systems

There are already a number of turbines fitted on and around buildings for assisted ventilation and power generation.

⁵⁸ <http://www.portcullis-house.com/about/roof/index.html>, Nov 2003

⁵⁹ BRE, <http://projects.bre.co.uk/envbuild/index.html>, Nov 2003

2.2.2.1 *Passive ventilation with moving parts*

Passive ventilation with moving parts refers to installations where the wind drives a rotor providing forced ventilation. Such devices are invariably fitted to buildings at and below conventional chimney heights. Fig shows two examples of commercial ventilators.

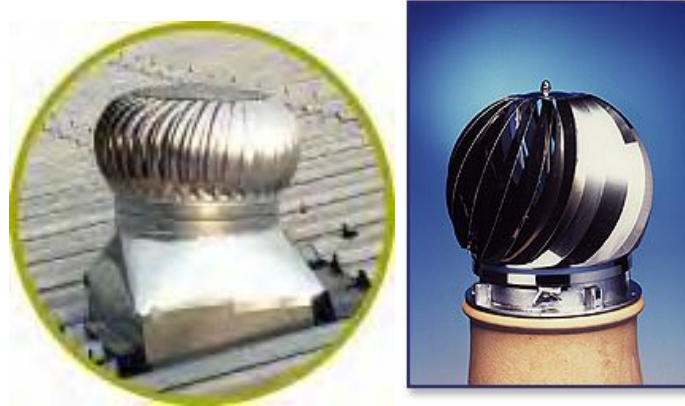

Figure 2-2 : Cowled ventilators from Artith⁶⁰ and Topstakchimneys⁶¹

2.2.2.2 *Passive ventilation with moving parts extended to Air Conditioning*

Arup Zimbabwe's Vertical-Axis Wind Turbine Extractor (VAWTEX)⁶² was voted Innovation of the Year at the Building Services Awards in London in July 2002 and was recognised by the judges as an example of clever innovation with "great international potential". It also won the Engineering Council's Environment Award for Engineers in the Engineering Alternatives class. Standing over 3m high, this rooftop device is designed to start operation at very low wind speed, generates higher pressures for increased natural ventilation of buildings, and has been demonstrated as part of an innovative passive cooling/heating system in the Harare International School in Zimbabwe, which uses buried rock chambers as sequential thermal storage batteries. Excellent comfort levels are achieved whilst incurring minimal energy and maintenance costs. The School also benefits from a pair of periscope-shaped wind-cowls that turn in opposition to each other, providing passive air supply and extraction.



Figure 2-3: ARUP's VAWTEX (left) and periscope-shaped wind-cowl (right)

⁶⁰ http://www.artith.co.th/product/html/18/en_18.htm accessed Jan 2004

⁶¹ <http://www.topstakchimneys.co.uk> accessed Jan 2004

⁶² Arup Press Release, 02 July 2002, <http://www.arup.com/environment/page.cfm?rowid=72>

2.3 Survey of BUWT technologies

Although a few small conventional wind turbines have been mounted to buildings in the past, the year 2004 saw the emergence of specifically marketed BUWT technology.

A thorough search to locate all BUWT technologies, both past and present, was undertaken. It is noteworthy that manufacturers in many countries were contacted, including the UK, The Netherlands, USA, Germany, Finland, Canada, Italy, Japan, France, Czech Republic, New Zealand, Mexico, and Denmark. In total 41 organisations were identified as having a BUWT concept under development with 13 claiming to have commercial turbines already in operation. The entries in the accompanying spreadsheet (see Appendix 1) have been completed/confirmed by the organisations concerned.

2.3.1 Comments on the data tables

- Certification of small turbines is variable: some have obtained BS EN 16400 and CE marking, but others don't claim to meet any particular standard.
- The number of building mounted turbine installations is currently small but expected to expand rapidly.
- A significant number of applications for R&D funding have not been successful, perhaps because many of them originate from very small companies.
- Vertical Axis Wind Turbines (VAWTs) are as common as Horizontal Axis Wind Turbines (HAWTs) in building-mounted applications; whereas HAWTs dominate conventional wind turbine design, VAWTs being mainly restricted to niche environments (e.g. areas prone to icing).
- Several turbine manufacturers were unable (or unwilling) to supply a full technical specification.
- Although Largerwey turbines have been mounted on buildings (e.g. Expo 2000), the company has been taken over and the new owner of the 2.5 kW turbine could not be traced.
- A non-Disclosure Agreement has been signed with Intec, so only limited technical information can be reported.

2.3.2 The first BUWT: the Trimblemill

The Trimblemill⁶³ (pictured in Figure 2-4) was exhibited at the Ideal Home Exhibition 1981 both in the exhibition and on top of the building. The Trimblemill had 2 contra rotating 5 m diameter rotors with the a 3 bladed front rotor and a 5 bladed rear rotor. The blades had an Aluminium frame covered by Terylene sail cloth and the hub height was 9.3 m on standard tower. The power curve is shown in Figure 2-4; the rated power of 12 kW was achieved at 19 m/s (the power at the more usually quoted 15 m/s was 9 kW).

⁶³ Stobart, A. F., *Wind Energy: some notes on its collection, storage and application*, Energy World, May 1983, p 4-6.

The Feasibility of Building Mounted/Integrated Wind Turbines (BUWTs)

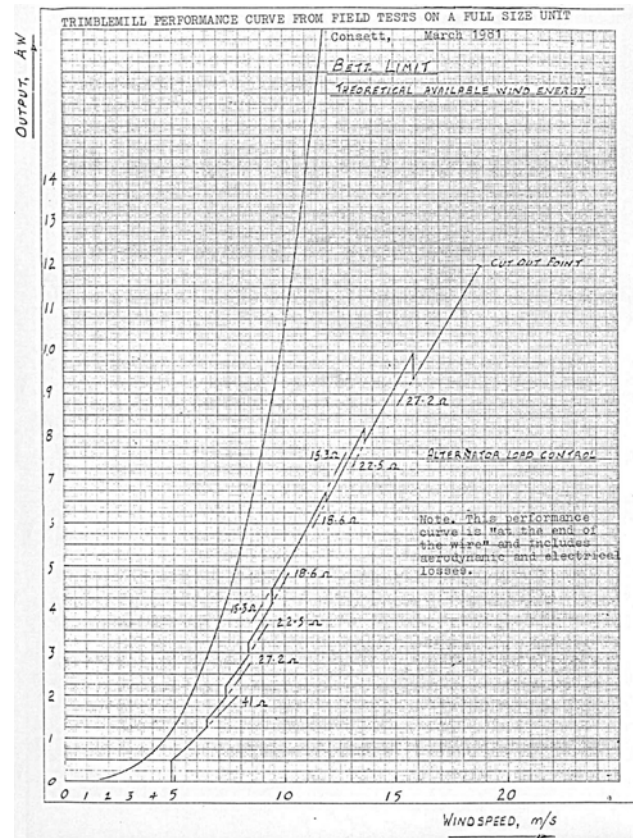
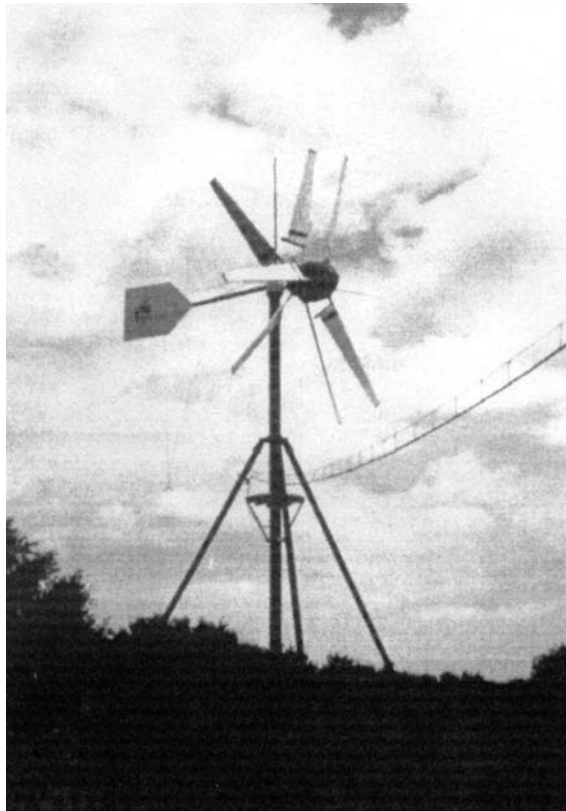

Figure 2-4: The Trimblemill operating in the early 1980s (left) and power curve (right)

2.3.3 The late 1990's: The Green Building , Temple Bar, Dublin

A few conventional wind turbines have been mounted on buildings; until very recently the largest were three 3.2 m diameter Bergey turbines (rated at 1.5 kW at 12 m/s) on the award-winning Green Building, Temple Bar, Dublin in 1995^{64,65}.



Figure 2-5: Three 1.5 kW Turbines on Green Building, Dublin developed by Murray O'Laoire Associates.

⁶⁴ Irish Architect (1994), *The Green Building*, no.103, Sep/Oct 1994, pp25-33

⁶⁵ Blanch, M.J., *Wind Energy Technologies For Use In The Built Environment*, Wind Engineering, Vol 26, No.3, pp. 125-143, 2002, Multi-Science Publishing Co Ltd.

This installation suffered from a vibration problem, which was solved by retro-fitting rubber mounts and weighting the guys to change the resonant frequencies. Despite this the installation has not been copied, possibly because the system was constrained by not being allowed to connect to the grid and instead having to charge batteries in parallel with solar photovoltaic panels⁶⁶. The solar panels were oversized for the task and so the turbines now remain largely unused and in fact have been tethered. It is also reported that the blades on these machines cracked – perhaps due to turbulence from the roof-top environment – and had to be replaced with new ones manufactured by Proven⁶⁷. This underlines the need to use turbines suited to the built environment.

2.3.4 The largest building-mounted turbines from Fortis⁶⁸

Fortis⁶⁹ is an established Dutch wind turbine manufacturer with 25 years experience and over 5000 units (100W-30kW) installed worldwide. Fortis has recently installed three 5 m diameter turbines on a building (Figure 2-6), making them the largest building-mounted turbines to date.



Figure 2-6: 3 x Fortis Montana wind turbines fitted to a factory/office

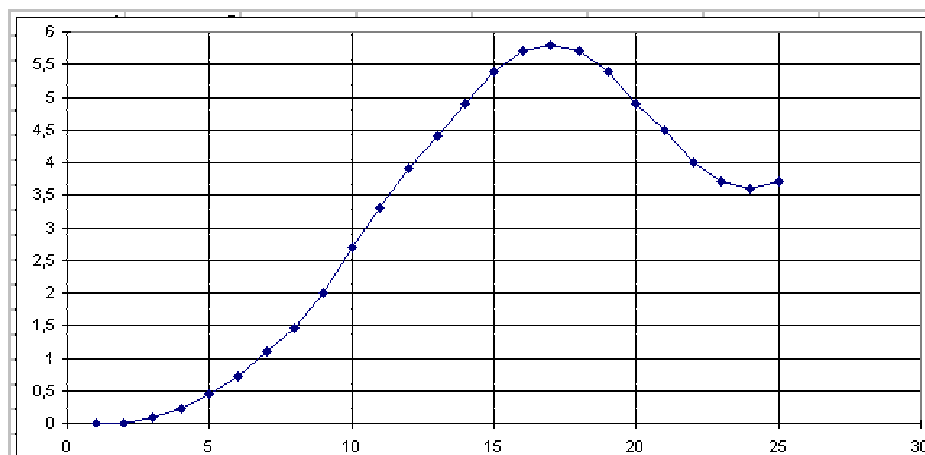

Figure 2-7: Montana power curve; Power (kW) vs wind speed (m/s)

⁶⁶ Gilna, B. (2001), Murray O'Laoire Associates, Personal communication to M J Blanch, October 2001, see also www.murrayolaoire.com

⁶⁷ Gordon Proven, Proven, Personal communication to M J Blanch, Jan 2004

⁶⁸ Johan Kuikman, Fortis, Personal communication to M J Blanch, Jan 2004

⁶⁹ www.fortiswindenergy.com

The turbines were installed on the roof in October 2003 and their performance evaluation is still underway, although Fortis report the energy output to be good and claim that “noise is not a problem”. However, a small problem has been encountered with vibration at high wind speed conditions due to the flexibility of the roof. Normally the Fortis Montana would be rated at 4 kW but for a building application the company rates it at 2 kW.

2.3.5 SouthWest Windpower roof-mounted Windseeker and AIR

Winsund⁷⁰ has retrofitted turbines to fifteen conventional (i.e. not explicitly designed for wind turbines) buildings in the County Durham in the North East of England. The buildings included some 1830-type lime-mortared barns for which Winsund determined that 500 W Windseeker 502 or 503 turbines mounted 6 to 9 m above the building constituted the limiting size⁷¹ before lateral forces would become too great and the turbine begin to shake mortar from the wall. Winsund mounted the turbines on the western (i.e. prevailing wind direction) side of the buildings.



Figure 2-8: SouthWest Windpower AIR 303 turbines installed on a US building⁷² (left) and Windseeker 503 turbine installation on a building in the Kielder Forest

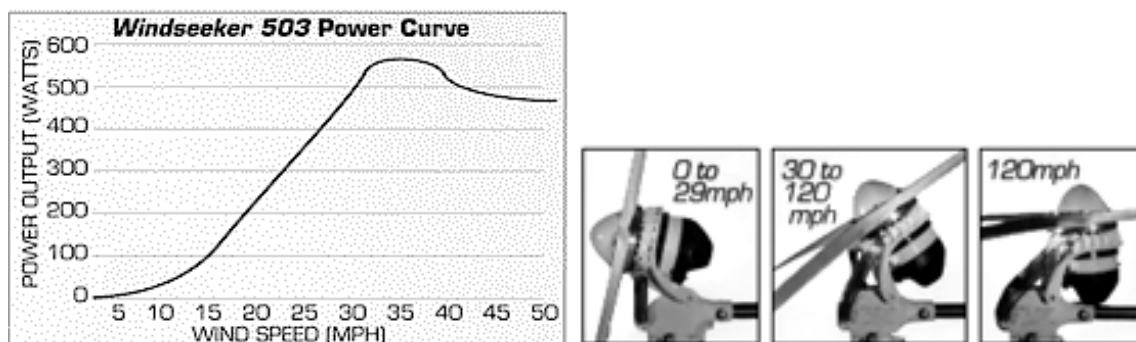

Figure 2-9: SouthWest Windpower Windseeker 503 turbine characteristic and furling control

⁷⁰ Mike Seeley, Winsund, <http://www.winsund.com/>, Personal correspondence to M J Blanch, September 2003.

⁷¹ Personal correspondence to M J Blanch, 24/10/2003

⁷² SouthWest Wind Power sell a kit to attach turbine poles to wooden framed houses.

It is already possible to buy wind turbine roof mount kits including a roof seal for the mounting of the US company Southwest Windpower's AIR series⁷³ of wind turbines (Figure 2-8). In the UK, Winsund has also developed mounting kits⁷⁴ (see Figure 2-8 which shows Windseeker 503 turbines with gable end fixings and mast mounted in the Kielder Forest, Northumberland). The Windseeker 503 turbine – a 1.52 m diameter HAWT, rated at 500 W and weighing 9 kg – is also made by Southwest Windpower. The Windseeker regulates power by furling vertically as illustrated in the bottom right hand side of Figure 2-9.

2.3.6 WEB Concentrator

The WEB Concentrator is an aerodynamically shaped building concept^{75,76} (see Figure 2-10) designed by a consortium including BDSP, Imperial College, Mecal and University of Stuttgart within the EC-funded *Wind Energy in the Built Environment* project.

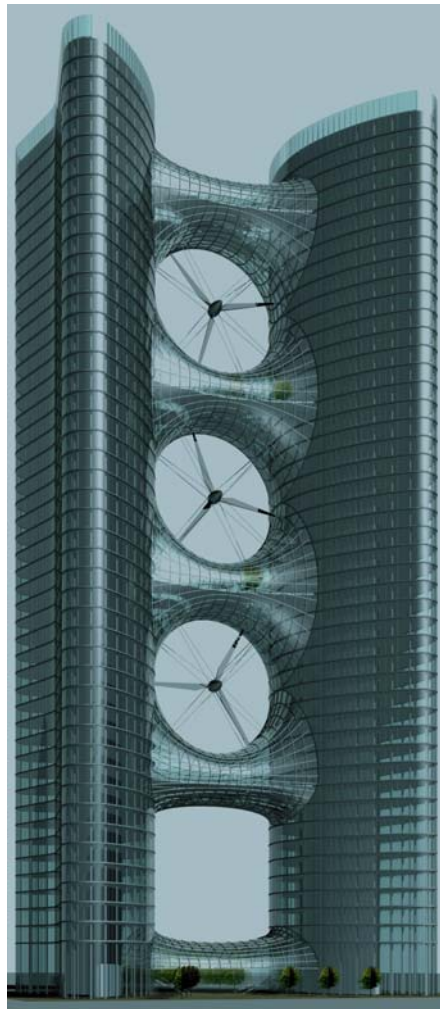

Figure 2-10: Conceptual architectural design of a twin-tower building with three integrated 35m diameter, 250 kW horizontal axis wind turbines

⁷³ Southwest Windpower, http://www.windenergy.com/SUPPORT/download/man/mana_rof.pdf, December 2003.

⁷⁴ <http://www.winsund.com/frame.htm>

⁷⁵ Campbell, N. et al (2001), *Wind Energy for the Built Environment (project WEB)*, PF4.11, EWEC 2001, Copenhagen, 2-6 July 2001.

⁷⁶ Campbell, N.S., Stankovic, S (2001), *Wind Energy For The Built Environment (Project WEB), Assessment of Wind Energy Utilisation Potential in Moderately Windy Built-up Areas*, Contract JOR3-CT98-0270, EU Publishable Final Report, Updated 6 July 2001



Figure 2-11: Photograph of the prototype WEB Concentrator during field-testing at CCLRC Rutherford Appleton Laboratory's Energy Research Unit Test Site.

The WEB Concentrator building's shape was designed with CFD modelling techniques by BDSP and optimised by extensive wind tunnel tests by Imperial College. The prototype (Figure 2-11) was then field-tested at CCLRC Rutherford Appleton Laboratory's Energy Research Unit Test Site using inserted horizontal and vertical axis turbines. The enhanced performance of the HAWT in the concentrator (with fixed yaw), above that of the HAWT stand alone (with free yaw), is summarised in Figure 2-12.

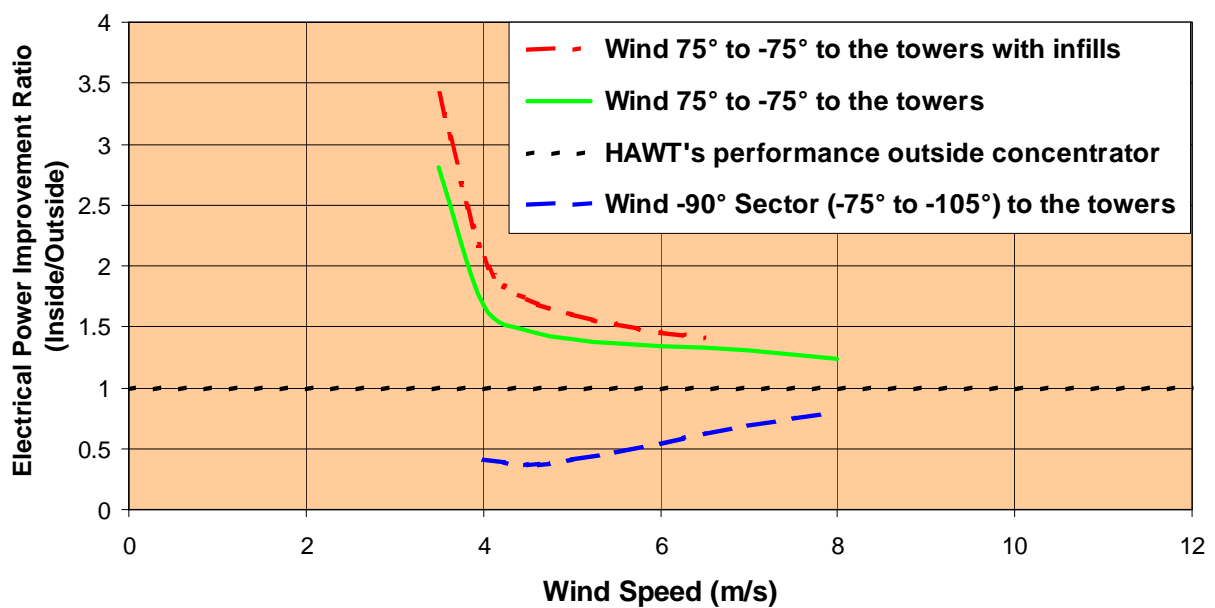

Figure 2-12: The WEB Concentrator model prototype performance for a range of wind speeds

The installation gave surprisingly consistent performance for a wide range of input wind sectors between -75 to $+75$ degrees to the building axis. The performance exceeded that expected from reduced scale measurements in the wind tunnel especially at large wind incidence angles to the principal building axis, probably due to natural variation in the wind direction and scale effects. Figure 2-12 also shows the performance when the wind comes from the 90-degree sector behind the building. The WEB concentrator's enhanced performance at the low wind speeds considerably increases the annual energy yield expected from the turbine. Funding is being sought to develop a HAWT turbine specifically designed for operation in the WEB Concentrator duct.

2.3.7 Ducted Wind Turbine Module

Developed by University of Strathclyde⁷⁷, from a 1979 patent by G.W. Webster, the ducted wind turbine module is designed to be integrated into a conventional high rise building. The design consists of a 90 degree bent duct, with the inlet in line with the wall face of the building and the outlet on the roof. The turbine rotor is hidden from view, since it is mounted just inside the roof outlet and the drive shaft passes through the duct to a generator housed below. Figure 2-13 (left) shows an old test device, located on the roof of Strathclyde University's James Weir Building, whereas Figure 2-13 (right) shows a more recent module photographed with an integral PV panel before installation on Glasgow's Lighthouse Building. The Lighthouse Building trial had not been fully commissioned at the time of the study (early 2004) due to administrative problems.

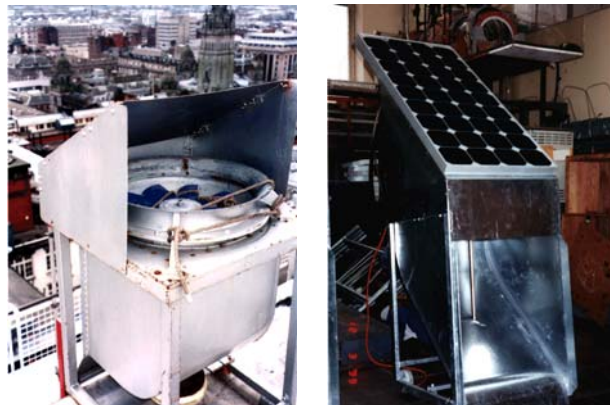

Figure 2-13: Strathclyde's Ducted Wind Turbine Modules

2.3.8 Altechnica's Patented Aeolian Planar Concentrator Wind/Solar Systems™

The Altechnica Aeolian Roof™ is one of a family of patented 'Altechnica Aeolian Planar Concentrator™' devices which can incorporate most types of wind turbine, including axial flow and cross flow turbines. These concentrator devices can be free-standing (fixed or yawable) wing-like devices or building-augmented devices with wing-like appendages attached to appropriate surfaces of buildings or of other appropriate structures or objects.

The 'Altechnica AeroSolar™' variant makes use of SolAirfoils™ which include PV cells or solar panels incorporated into the surface of the 'wing' to enable the device to capture solar energy as

⁷⁷ Dannecker, R, et al (1999), *Development of the Building Integrated Ducted Wind Turbine Module*, Proc 21st British Wind Energy Association Annual Conference, P.Hinson (ed), pp 141-147, MEP Ltd, London

well as wind energy, considerably increasing the productivity of the unit and enabling it to generate electricity on calm sunny days - (see Figure 2-14). Combining wind and solar energy capture into the same device takes advantage of the complementary nature of the two resources and offers almost year round productivity from the same unit which can share common components such as inverters and cabling, where appropriate.

On the wind power side, these devices are intended to augment the wind velocity delivered to the turbine rotor to increase the power and energy output from the turbine, increase the capacity factor, and open up the possibility of exploiting wind energy at low wind speed sites (a 25% increase of wind speed can effectively double the power output of a given size of wind turbine). Computer modelling and wind tunnel testing indicates higher wind speed augmentations are feasible.

If these augmentations are confirmed, these patented devices could in theory substantially increase the UK's potential wind energy resource as locations not previously considered viable would become so, separation or exclusion zones can be considerably reduced or eliminated, higher wind speed sites could become more productive and wind turbines would be productive for a greater proportion of the time. These devices also facilitate on-site generation reducing the need for transmission - again improving the productivity of wind energy by avoiding transmission losses.

The turbines themselves are enclosed and can be screened with grilles or louvers, effectively rendering them invisible. The fact that the rotating element is enclosed also improves device safety – an important factor in the urban environment. They are potentially quiet devices as many of them should not require gearing and they can be acoustically screened or damped.

As the working component is much smaller for a given power rating the other static or semi-static elements could lend themselves to local manufacture using a range of manufacturing approaches and fabrication techniques – increasing the benefits to the local economy and reducing the size and mass of components needed to be transported from the factory compared to conventional turbines and reducing the embodied energy and emissions that this would represent.

These concentrators can be free standing vertically or horizontally configured (or inclined) ‘Altechnica Aeolian Monoplane™’, ‘Altechnica Aeolian Biplane™’ or ‘Altechnica Aeolian Triplane™’ Concentrators which can range from very small devices up to multi-megawatt power ratings by utilising rows or stacks of axial or cross flow turbines. The latter can be extremely large and could be located off-shore though individual turbines housed in these can be relatively small - making them easier to transport and install. The vertically configured devices may appear as ‘sails’ or large tall ‘weather-vanes’ in the landscape which gently yaw to follow the wind rather than have the appearance of conventional wind turbines.

The Building-Augmented variants include the *Aeolian Roof™* in which the *Altechnica Aeolian Planar Concentrator™* is aligned with the apex region of a building roof such that a slot is created inside which a low pressure high wind velocity zone is established where small diameter high power rating wind turbines can be located to extract wind energy. This low pressure zone can also be utilised to induce ventilation of the building in the form of the *Altechnica Aeolian Ventilator™* via valve controlled openings into this region of the roof. The *AeroSolar Aeolian Roof™* generates electricity from solar energy capture from the *Altechnica SolAirfoils™* and from PV arrays incorporated into the roof surface. A structural- and space-efficient curved roof works best, but initial investigations indicate that the wind speed can be augmented at the ridge of shallow pitch roofs with curved eaves. Conventional pitched roofs could also provide some degree of augmentation which, if confirmed, would open up a substantial retrofit opportunity and help to cut the substantial carbon dioxide emissions from buildings otherwise difficult to

improve in terms of energy efficiency. The *AeroSolar Aeolian Roof*TM also facilitates the incorporation of PV onto existing buildings without having to re-clad the roof or mount PV modules on-top-of-the-roof surface. From the simulations carried out on the *Aeolian Roof* it appears to be able to “pull down” winds from higher altitudes than that of the height of the roof; if confirmed this may prove to be an approach to utilise higher level (higher velocity) winds without the need for tall towers and make an additional advantageous feature for utilising wind energy in the built environment.

The *Altechnica Aeolian Tower*TM or *Aeolian Corner*TM building-augmented system is similar to the *Aeolian Roof*TM except in this case the “wing” is aligned with the curved corner of a building or other structure (or with the side of a curved plan building or other structure) exposed to the wind – see Figure 2-14. In this case on tall buildings the device can potentially supply hundreds of kilowatts in the urban environment without large rotating structures.

The *Altechnica Aeolian Canopy*TM is essentially a canopy based version of the *Aeolian Roof*TM and can be used as a free standing canopy/shelter or as over-arching canopy roof over flat roofs or over other buildings.

Another set of building-augmented variants support *Altechnica Aeolian Monoplane*TM, *Altechnica Aeolian Biplane*TM or *Altechnica Aeolian Triplane*TM concentrators projecting out from the roof or from the façade of a building in the form of the *Altechnica Aeolian Winged Building*TM; these projections may be fixed or freely yawing. Alternatively, the same variants can be built into wing-shaped *Altechnica Aeolian Links*TM between adjacent tall buildings.

A further set of building-augmented variants consist of *Altechnica Aeolian U-Top Concentrators*TM or *Aeolian Trident-Top Concentrators*TM for capping tall buildings. These permit high level winds to be captured without large rotating structures.

Whilst ultimately, it is envisaged that these devices could evolve into standard bolt-on components, at the present time they have to be considered bespoke and Altechnica needs to be involved in the design of the building or preferably to be the building’s architect.

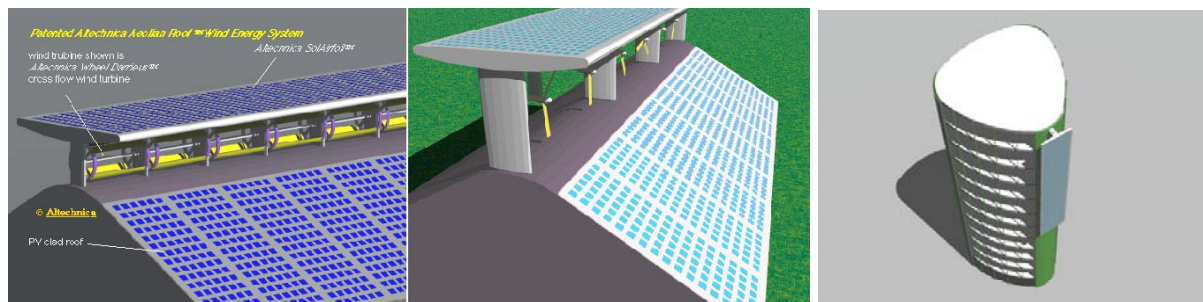

Figure 2-14: Altechnica *Aeolian Roof*TM designs with cross flow turbines (left) and HAWTs (middle) and the *AeroSolar Tower*TM (right)

2.3.9 Wind Dam’s WD1 system

The Wind Dam System uses the inherent strength of the building to intercept and collect wind energy. The concept successfully completed a feasibility study with wind tunnel testing carried out by BRE and favourable overview by Garrad Hassan and Partners. A first model prototype (WD1) has now been built and is shown under test in Figure 2-15. There has been a good reaction to aesthetics, noise level, and the overall market concept. A second model prototype (WD2) was being designed and constructed in early 2004 to refine and improve the turbine

The Feasibility of Building Mounted/Integrated Wind Turbines (BUWTs)

efficiency. Following testing of the second prototype three full size prototypes were planned; two for installation in Cornwall and one for the Dartmoor National Park. Subject to funding, the ongoing design programme, following the installation of the full size prototypes (expected late in 2004), will focus on integration into new buildings, and a separate study will evolve and expand on sustainability of materials and value engineering. In parallel with the turbine development, Wind Dam has developed a wind survey database and computer model for the more accurate assessment of power potential in complex and urban environments, including energy cost predictions and appropriate technology for specific sites, and this service is offered commercially, independent of the Wind Dam technology.



Figure 2-15: The Wind Dam VAWT prototype under test in November 2003.

2.3.10 Ecofys' Neoga

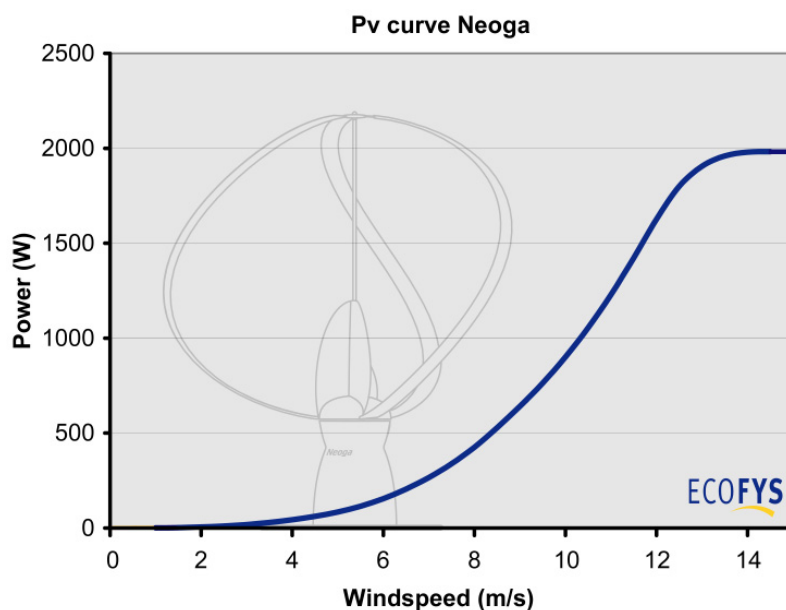

Figure 2-16: Design power curve for the Neoga

The Neoga® is a Vertical Axis Urban Turbine, designed as a landmark for sustainable energy by Ecofys and resulting from their work in this field dating back to 2000. The design consists of a Darrieus-type turbine combined with Savonius blades for start-up. The VAWT design is not sensitive to changes in wind direction or speed, which Ecofys claim is perfect for application in the difficult wind situations commonly found in urban situations.

2.3.11 Wind Amplified Rotor Platform (WARP™) Tower

WARP™ systems were developed in the US by ENECO in conjunction with Rensselaer Polytechnic Institute, primarily for large utility scale power plant use. However their omnidirectional wind energy capture can be incorporated with buildings, as ‘apex crowning’, and on elevator systems or roof mounted HVAC systems.

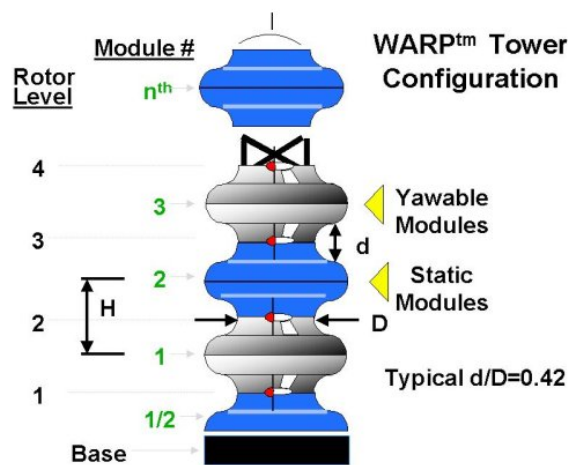

Figure 2-17: The WARP™ Tower

The systems are designed to amplify the wind using modular arrays mounted around simple core towers. The small integrated commodity wind turbines are thus a minor cost item in the system because of the cost of the combined tower and augmentation. This may be compared with conventional wind turbines, where the large rotor-head assemblies make up the bulk cost of the system⁷⁸.

2.3.12 Aeromag's Lakota

Aeromag Corporation has developed the 1 kW Lakota turbine constructed using high performance Aerospace engineered advanced materials and structures technology; two further versions the OB1kW and OB2kW are soon to be produced. Aeromag claims that the Lakota has a near zero radar cross section and the lowest IR signature.

Aeromag's Canadian Distributors website⁷⁹ has published the latest test results of the turbine from the Free Wind Test Center. Aeromag are considering establishing an office in the U.K. in 2004. Aeromag Corporation exclusively licenses all of its technology for sales and distribution via a similarly named associated company called the Aeromax Corporation.

⁷⁸ Weisbrich, Alfred L. (2001), ENECO, Personal communication to M J Blanch, December 2001

⁷⁹ www.truenorthpower.com



Figure 2-18: The Aeromag/Aeromax Corporation's 1 kW Lakota

2.3.13 Turby

The Turby is a Dutch 1.99 m diameter, 3 m tall VAWT, rated at 2.5 kW at 13 m/s, weighing 90 kg, and specifically designed to be mounted on flat roofs. The blades are set at a fixed angle to maximise output from skewed flow on flat roofs, of the kind shown in the flow visualisation of Figure 2-19 where the flow lines above the boundary next to the roof can be seen at about 45 degrees to the horizontal.

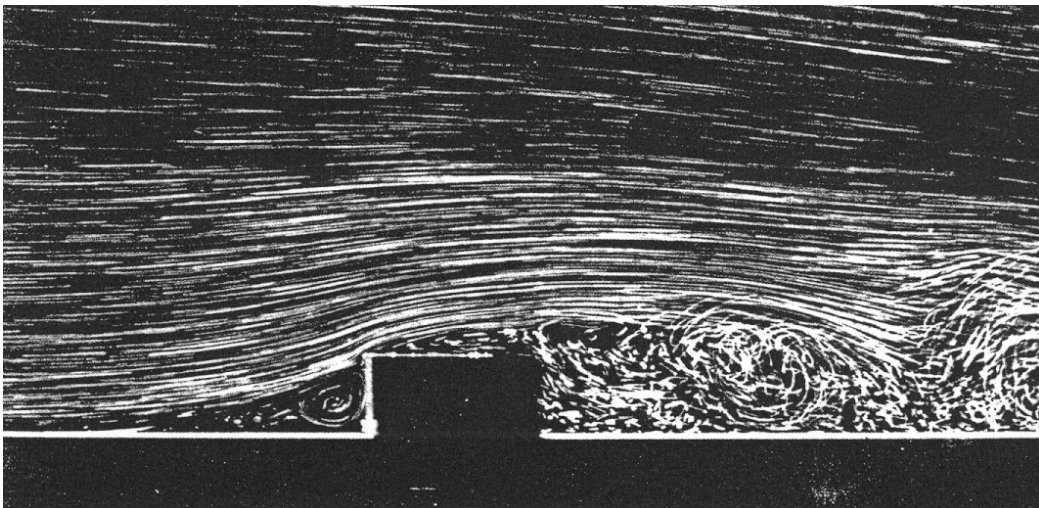

Figure 2-19: Visualisation of the turbulent separation at the leading roof edge of a flat roof⁸⁰

The Turby was aerodynamically designed for CORE International by Sander Mertens and tested in TU Delft's open jet wind tunnel and TU Delft's open air facility (Figure 2-20). A number of prototypes with different blade mounting methods, and structural cross members have been tested. The power curve is shown in Figure 2-20.

⁸⁰ Mertens, S., Henk Krüs, R.P.J.O.M van Rooij, *Wind Description for Roof Location of Wind Turbines, A design guideline on the required height of a wind turbine on a horizontal roof of a mid- to high-rise building*, Proc Global Windpower, Paris, France, 2-5 April 2002

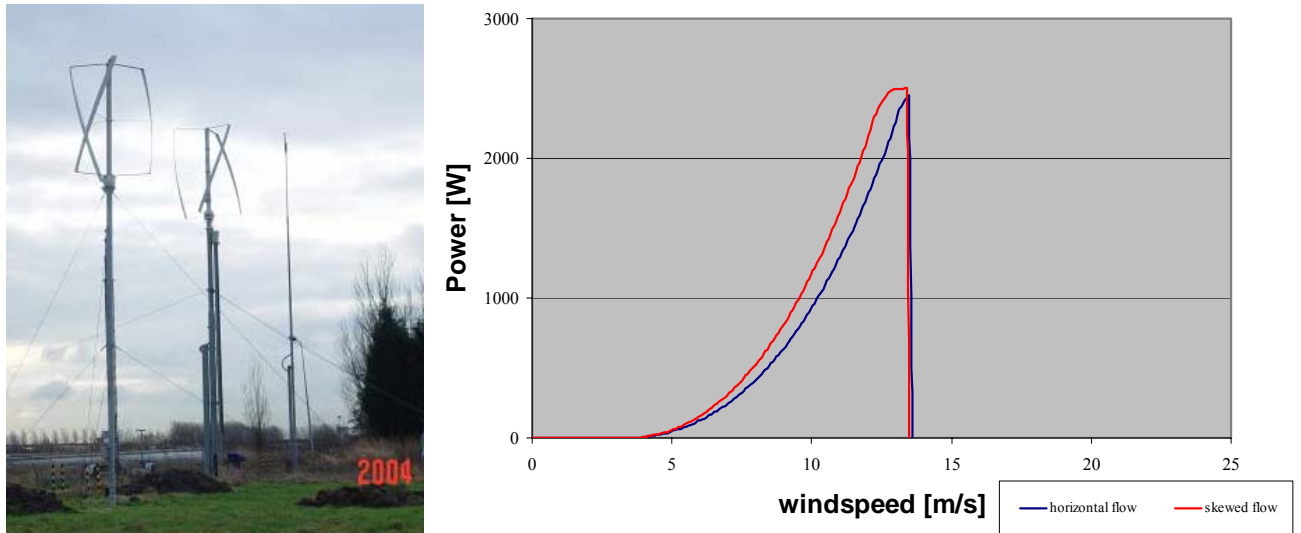

Figure 2-20: Turby prototypes under test at TU Delft (left) and power curve (right)

2.3.14 Prowin's Provane 5 & 7⁸¹

The Provane 5 is a 5 m diameter HAWT, rated at 2.01 kW at 10 m/s, and weighing 720 kg without ballast. Prowin use a maximum load limit of 1.5 kg/cm² for rooftop mounting(the larger Provane 7 currently under development is not intended for roof installation). Due to mass and force considerations, the Provane 5 can only be deployed on flat, not pitched roofs. Prowin claim that no sound can be measured from the turbine. Rubber is used to isolate the concrete ballast to prevent vibration at the rooftop.

The Provane 5 can either be mounted on a tower (12 m high) or on the roof (6 m high). There are two power configurations:

- 4 kWe with compact drive and mechanical brake:
- 2.4 kWe direct drive with electronic brake.

The 2.4 kW direct drive is more efficient design, especially in lower wind speeds and it can generate almost 3 kW, but the inverter cannot currently exceed 2.4 kW. The inverter company is making a 4 kW inverter so the full 3 kW will then be realisable. The Provane's electronic system has been redesigned from a low voltage 25/50 volt (battery charger) to high voltage 125/400 volts which gives improved performance and makes the transport of the power easier.

2.3.15 Ropatec's WRE range

Ropatec have mounted⁸² a WRE.030 - 3000W and a WRE.005 - 500W on their office in Bolzano which can be viewed operating via a web cam (which requires a pan round by 160 degrees to the right to see the turbines). Ropatec developed their roof-mounted product in response to many requests for rooftop installation of their VAWT turbines, which they perceived to be "difficult to undertake". The company developed a new concept of rooftop installation which they tried out on their own office building particularly to study the vibrations induced by the turbine in conjunction with the material of the building.

⁸¹ Hans Hopman, Prowin, Personal correspondence to M J Blanch, Oct 03 and Jan 04. See also www.prowin.nl

⁸² <http://www.ropatec.com/en/news/22.html>



Figure 2-21: A WRE.005 0.5 kW and WRE.030 3 kW installed on the BIC (Business Innovation Centre), Bolzano in February 2003

2.3.16 Wind Electric Incorporated's Ducted Fan Wind Turbine (DFWT)⁸³

The Ducted Fan Wind Turbine (DFWT) is designed for roof top mounting and consists of two turbines mounted in a cowling that is free to rotate (Figure 2-22).

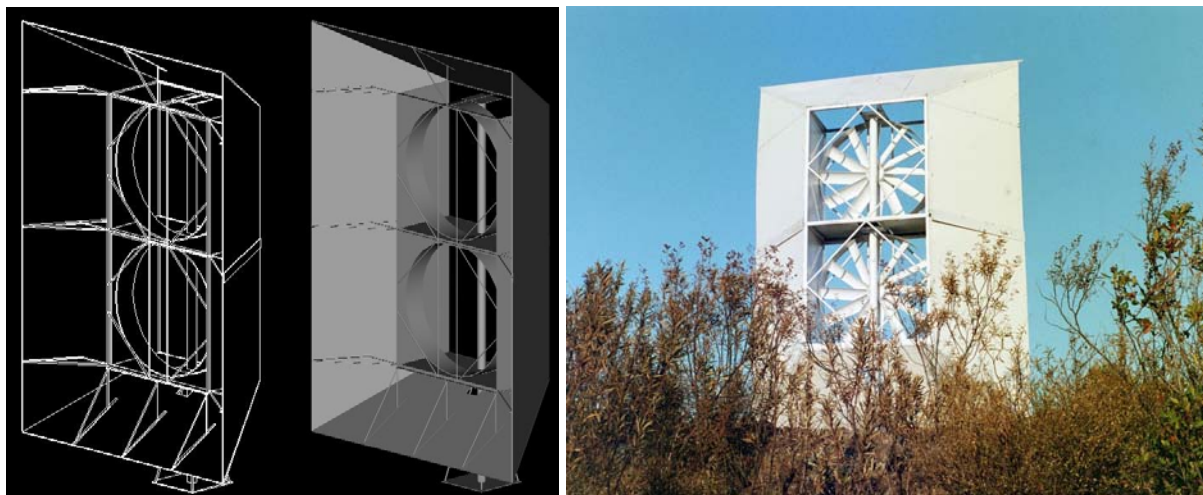

Figure 2-22: The Ducted Fan Wind Turbine (DFWT)

The early designs of the US-based company Wind Electric Incorporated's Ducted Fan Wind Turbine (DFWT) were created in the 1980s by Stanley Marquiss, who updated his designs following the Californian electricity crisis in 2000. After additional aerodynamic work, the Double 5 was created. The challenge has been to make a properly designed duct, and more importantly a successful indexing mechanism, allowing the DFWT system to track gusty, rapidly directional shifting turbulent winds.

The Wind Electric Inc DFWT project, has evolved over around 22 years, into the very simple but high performance, high reliability Three Meter Unit. It includes an improved indexing system, a new, improved turbine fan, and the first iteration of the new leading edge front hinge flap structure. Wind Electric Inc note that "after 15 months of absolutely flawless aerodynamic and mechanical performance, this system was taken down for analysis in January 2004, having survived a series of winter storms with winds above 115 mph [51.5 m/s]".

⁸³ Stanley Marquiss, Wind Electric Incorporated, Personal correspondence to M J Blanch, Feb 2004

In Summer 2003, the design for the Three Meter DFWT unit was completed. Construction began in November, 2003. The finished cell, and welded flap structures are now complete, together with the finished, rolled, turbine fan blades, and outer annulus. As of March 2004 the design had not been formally certified.

2.3.17 Windsave

Windsave has been developing two small turbines to “mount onto almost any roof or wall”. Figure 2-23 shows the working prototype. The WS500 is 1.25 m in diameter and rated at 500 W at 27 mph (12 m/s) and the WS 1000 is 1.75 m in diameter and rated at 1000 W at 27 mph (12 m/s). Both these ratings imply a coefficient of performance (power produced by turbine divided by power in the wind) of about 0.38 which would be an extremely good performance for a micro wind turbine which, at that size, might have been more expected to have maximum coefficient of performance between 0.11 and 0.19.



Figure 2-23: A working prototype of the Windsave turbine

2.3.18 Proven

Proven, and established small wind turbine manufacturer, is now actively selling into the BUWT market (current projects in Ealing and Manchester) using high safety versions of standard downwind wind turbines (see also Figure 2-24). Proven are also active in design and manufacture of a vertical axis ventilation machine as well as conducting in house research on a horizontal axis cross-flow design.

Proven currently manufactures a range of four small wind turbines with rated outputs from 0.6 to 15kW, all of which are available in a Health & Safety (HS) version suitable for installation in public places and on roof tops. The Proven HS turbines are among the few standard production machines on the market today declared suitable for routine installation on roof tops. Proven receives hundreds of inquiries for BUWTs every year from domestic customers, developers and housing associations and claims several advantages for its turbines in the built environment, including:

- flexible blade system featuring fail-safe speed control,

The Feasibility of Building Mounted/Integrated Wind Turbines (BUWTs)

- dissipation of mechanical forces in turbulent wind regimes as often found on building roofs
- no gear box – less maintenance
- low life cycle costs through longevity given by low rpm airfoil and generator design
- very low tip speed ratio of around 5 giving excellent noise performance
- implementation of intelligent optimising energy balancing control

The development of next generation composite blades with improved airfoil characteristic for highest possible energy capture, the development of special blade tips to reduce noise, and a choice of airfoils to minimise noise will help to further optimise the range for this application.



Figure 2-24: Five Proven WT600 (600 W) turbines on roof, Daito Bunka University, Japan (left) and WT2500 (2.5 kW) on a 6.5m tower on roof, Taku High School, Japan (right)

Although all buildings are different, Proven has identified a number of common factors for BUWT installations:

- **Health and safety** of installation, especially of building works at roof level, is non-trivial and may require the appointment of a third party safety consultant to oversee the project
- **Ducting** of wind turbines to enhance flow and improve air flow is unnecessary, except in the unusual case where the whole building is designed to enhance wind flow. It's cheaper, easier, smaller and lighter to fit a slightly larger non ducted turbine instead.
- **Turbulence** tolerance is built into the design of Proven wind turbines which the company claims are among the best in coping with the high mechanical loadings induced by turbulence and operate well in a turbulent environment. However, energy yield may well be reduced due to turbulence. Proven points out that although many people want to fit roof-top wind turbine rotors just above roof-level this is often the highest turbulence zone and is therefore not good for energy capture (or for health and safety in certain situations). Shaped roofs, minimal roof “furniture” or, more usually, a 5 or 6m tower to get above the most turbulent airflow are all possible solutions. These require a reasonably strong fixing point and a structural analysis of the roof is usually needed.
- **Vibration** is not an issue if a strong fixing point into a concrete reinforced beam or similar is available. (Proven uses a soft mount system between tower and roof structure to supply additional damping.)

- **Cost** is high when each project is essentially custom-designed, but this is compensated for by higher energy yields available on top of tall buildings and the ease of grid connection/feeding the energy into the building electrical circuits.

2.3.19 Marlec

Marlec manufactures large volumes of standard small wind turbines which are distributed worldwide by agents and distributors and therefore usually have no contact with the end customer and often have no contact with the final application or installation. All Marlec turbines are designed for mounting on top of a tower in non-turbulent wind flow but the company is aware that the turbines are sometimes installed on buildings, often with bad consequences. Where possible, Marlec discourages the mounting of turbines directly to buildings mainly due to the possibility of noise transmission and the detrimental effect on performance and fatigue life due to wind turbulence. However, Marlec also recognises the growing requirement for building mounting of turbines and encourages further research on turbine design and methods for building mounting or integration.

2.3.20 Renewable Devices

The design engineers of Renewable Devices, Charlie Silverton and David Anderson, who designed the Swift, claim that it is the world's first truly silent wind turbine. Research on the design began in 2002, on the back of a DTI Smart Award. A prototype of the system has been completed and the company has recently started the build of a pre-production batch of between 25 and 50 turbines which will be field-tested in and around the Edinburgh area during 2004, with full mass production to begin at the end of the year.



Figure 2-25: Renewable Devices Swift 1.5 kW Turbine

The Swift has some very advanced aerodynamics which make the rotor more efficient, whilst reducing the noise emissions significantly, a problem which has meant that similar sized turbines cannot be building mounted. A circular rim around the outside of the blades restricts the radial flow of air at the tip of each blade which creates a ripping noise with conventional turbines.

Renewable Devices has also developed an electronic control system which safeguards the turbine in high winds and ensures efficient power extraction under normal operating conditions. In early 2004, the company was seeking commercial partners to manufacture and market its system. The

aim for manufacture of the Swift turbine is to make it harm neutral - that means that it will make more energy in its lifetime than is used to manufacture and install it.

In September 2003, Renewable Devices won a Scottish Power Green Energy Trust Award to fit Swift Rooftop Wind Energy Systems to five selected primary schools in the Fife area to provide electricity hot water, lighting and computing equipment. The company also won the Scottish Green Energy Award for Best New Business in 2003.

2.3.21 Zia Solar's Crescent

Zia Solar is developing a caged vertical axis wind turbine, which the company claims will be suitable for all roofing types provided there is a good wind profile. Zia Solar plans to have two models: a 700 W version for domestic use and a 1 kW version for public utility use. It is unclear how many turbines have been built to date – a prototype is shown in Figure 2-26, although the company is seeking funding to continue further Research and Development.



Figure 2-26: The Crescent 700 W prototype turbine

2.3.22 The Combined Augmented Technology Turbine (CATT)

The small UK company FreeGEN is developing a wind turbine with a novel concentrator design called the Combined Augmented Technology Turbine (CATT). This patent-pending design is specifically intended to be used in moderate wind speeds near buildings; it adds a diffuser with a free rotor to a conventional horizontal axis turbine design, which the designer claims gives the ability to “process” incoming wind of moderate energy density, that may be veering and slightly turbulent, into a smoother, faster, airflow. The propeller is contained, for safety reasons, and the diffuser has the ability of physically blocking strong winds from reaching the propeller. Figure 2-27 shows the CATT; a research model has been constructed and will soon be tested in the free air⁸⁴.

⁸⁴ Gaskell, C., FreeGEN, Personal communication to M J Blanch, March 2004



Figure 2-27: The Combined Augmented Technology Turbine (CATT).

2.3.23 The NGUp WindWall

The Dutch company NGUp has installed a 1.2 m diameter, 9 m long WindWall system with a rated power of 3 kW, on the roof of the head office of the light rail company in the Hague in the Netherlands (Figure 2-28). The WindWall is a modular helical VAWT or cross flow turbine that is designed to be easily be grouped together in a single row or as a “WindWall“ in multiple rows in the horizontal and/or vertical plane.



Figure 2-28: NGUp’s WindWall turbine installed on 15th January 2004 on the roof of the head office of the light rail company in the Hague in the Netherlands⁸⁵

⁸⁵ Rob Roelofs, NGUp, Personal correspondence to M J Blanch, Jan 2004

2.3.24 Robertson and Leaman's Roof Turbine

The Robertson and Leaman roof turbine is designed to hide the turbine from view and thus takes energy from the wind entering the eaves and exhausting at the roof apex. A review by Atkins Research and Development in 1980 concluded that such an energy conversion system "has the potential to provide more power than a conventional horizontal axis wind turbine of equal diameter sited level with the apex of the roof" but cautioned that the effectiveness of sealing was crucial and recommended wind tunnel tests on research models.

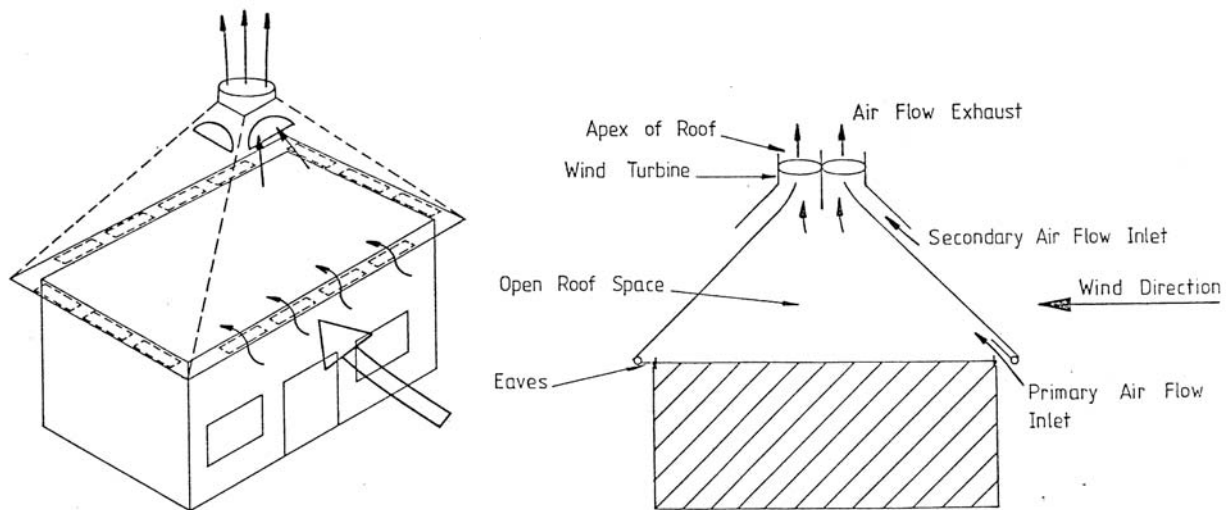

Figure 2-29: Robertson and Leaman's Roof Turbine Concept

To date, the primary objective⁸⁶ has been to overcome planning objections that particularly affect small wind installations. Technical development has therefore been limited to small-scale demonstration models and effort concentrated on preparing detailed architectural plans for a building (which happens to be a football club changing room) for submission to the local planning authority as a test case of wind-device development acceptability.

2.3.25 Other approaches: the solar chimney

A novel approach being developed for larger scale power applications is the idea of combining a wind turbine with a solar chimney [which could be combined/integrated into a building (including a Trombe wall type of approach) or stand as an independent structure]. This technology could conceivably be incorporated into a building, but may not be suited to UK climate.

2.4 Conclusions

This section has presented the results of a comprehensive survey of BUWT technologies – information has been collected about 41 different devices, and detailed descriptions given about a selection of them. A spreadsheet of the models identified can be found in Appendix 1.

⁸⁶ Tom Robertson, Robertson and Leaman Ltd, Personal correspondence to M J Blanch, Jan 2004

3. Examining the Technical Solutions to the Technical Hurdles

3.1 Introduction

A meeting of the project team was held in July 2004 to discuss the technical hurdles arising from the Task 2 report and to identify any hurdles which may have been missed. The meeting was attended by representatives of CCLRC, Altechnica, BDSP, Hoare Lea, Marlec, Imperial College, and Wind Dam Ltd. A list was then circulated for all partners to award ranking points to the hurdles they considered most significant and to comment on potential solutions, either via 'best practice' procedures or future R&D work. Responses were received from: CCLRC, Altechnica, BDSP, Hoare Lea, Marlec, Imperial College, Wind Dam Ltd., and FreeGen. The ranking of the hurdles is presented in this section for the average response and the maximum and minimum grades. The expertise of the partners covers: academia (CCLRC and IC), established manufacturers (Marlec), start-up businesses and consultancies (Altechnica, BDSP, Wind Dam Ltd., FreeGen), and acoustic consultants (Hoare Lea). The individually awarded grades for each hurdle are presented in Appendix 2, normalised to the highest single assigned grade (300).

The most important technical hurdles facing BUWT development can be summarised as:

- the development of suitably understood methods for power augmentation (including the use of building/roof shape or form) and the related question of the use and design of ducting;
- the need to design for high turbulence levels and veering or swirling winds, both critical factors in the location of a BUWT on a building and connected to the issue of the degree of omni-directionality of a BUWT;
- issues relating to the safe containment of any failed rotor, the amelioration of structurally transmitted vibrations (also connected to mounting arrangements) and broad band noise emission; and, finally,
- reliability and capital cost.

Medium priority actions not incorporated in the above were:

- blade design & construction,
- maintenance considerations,
- electronics for automatic synchronisation to 13A.

Finally, the lowest priority hurdles identified were:

- impact on design of new buildings, including ease of access for maintenance,
- technical issues such as elimination of any pitch alteration mechanism, reduced performance, and protections against bat & bird strike or blown debris
- low frequency noise, airborne vibrations, and their comparison with prevailing ambient noise levels.

Current practice in respect of and possible solutions to all these hurdles are elaborated in section 3.3 and the main outcomes summarised in the conclusions (section 3.4).

A number of highly relevant points and recommendations are made. However, it should be noted that the project consortium is a relatively small subset of the wind energy community as a whole, albeit those with a prior interest in the potential of wind energy in buildings. The group is clearly biased towards the smaller machine end of the market, which may not eventually prove to be the most appropriate scale for BUWT development. That said, most of the hurdles identified (e.g.

need for augmentation, noise and vibration suppression, reliability, etc.) are generic in nature and could apply to any scale of machine (though conceivably the weighting might change).

3.2 Ranking of technical hurdles identified

The following groups of specific technical hurdles were identified by the project team:

Wind regime in the built environment:

- Implications of high turbulence levels
- Implications of veering or swirling winds

Noise and vibration issues:

- Noise Reduction - Broad band
- Noise Reduction - Low Frequency
- Low Frequency airborne vibration
- Structurally transmitted vibration
- Minimisation of vibration
- Determining prevailing ambient noise levels

Building mounted/integrated wind turbine (BUWT) design:

- Ducting -need for, design of
- Blade design & construction
- Need for omni-directionality
- Need for augmentation
- Reduced performance
- Elimination of pitch alteration mechanism
- Safety containment of failed rotor

Installation issues:

- Location of BUWT on a building
- Mounting arrangements
- Electronics for automatic synchronisation to 13A
- Impact on design of new buildings

Overall systems, operation, and maintenance:

- Reducing capital costs
- Bat & bird strike
- Blown debris
- Maintenance considerations
- Reliability considerations
- Ease of access

The Feasibility of Building Mounted/Integrated Wind Turbines (BUWTs)

Note that these hurdles are concerned with the *technical implementation* of BUWTs and must be considered in addition to the basic R&D needs identified in section 1, namely:

- general uncertainty relating to knowledge of wind regime in built up areas,
- local flow effects around buildings,
- catalogue and categorisation of UK building stock in terms of suitability for BUWT systems

Having identified the hurdles, the project partners were asked to allocate a total of 1000 points between the items according to the importance they considered should be attached to them. All partners ranked all items they considered important, except for Hoare Lea who only felt qualified to comment on vibration, acoustic, and noise issues. The Hoare Lea responses were then scaled according to the overall priority given to the areas they had scored compared to the other respondents to obtain a comparable average score for each hurdle.

Hurdle	Average score	Maximum	Minimum
Need for augmentation	101	300	0
Implications of high turbulence levels	71	113	10
Ducting - need for, design of	68	200	5
Safety containment of failed rotor	59	100	10
Implications of veering or swirling winds	57	100	10
Location of BUWT on a building	55	150	10
Structurally transmitted vibration	53	100	0
Minimisation of vibration	48	60	20
Reliability considerations	47	100	0
Blade design & construction	46	75	20
Reducing capital costs	45	100	0
Maintenance considerations	42	60	10
Noise Reduction - Broad band	41	100	20
Need for omni-directionality	32	60	0
Electronics for automatic synchronisation to 13A	31	60	0
Mounting arrangements	31	100	0
Ease of access	29	90	0
Impact on design of new buildings	28	50	0
Elimination of pitch alteration mechanism	21	50	0
Noise Reduction - Low Frequency	19	36	0
Reduced performance	18	50	0
Blown debris	18	50	0
Low Frequency airborne vibration	15	36	0
Bat & bird strike	15	25	0
Determining prevailing ambient noise levels	10	25	0

Table 3-1 : Technical hurdles in order of average score

The Feasibility of Building Mounted/Integrated Wind Turbines (BUWTs)

Appendix 2 presents the complete set of scores from all respondents in bar chart format. Table 3-1 shows the hurdles ranked according to the average score with the maximum and minimum scores allocated.

The hurdles can conveniently be sorted into 3 priority groups:

HIGH: one or more partners allocated a score of 100 or more,

INTERMEDIATE: no partner allocated a score of 100 or more, but average score > 30,

LOW: average score < 30.

The **HIGH** priority hurdles (Hoare Lea responses appropriately weighted) were:

- Need for augmentation (Max score 100, 3 scores above 100)
- Implications of high turbulence levels (Max score 113, 5 scores above 100)
- Ducting - need for, design of (Max score 200, 2 scores above 100)
- Safety containment of failed rotor (Max score 100, 2 scores above 100)
- Implications of veering or swirling winds (Max score 100, 2 scores above 100)
- Location of BUWT on a building (Max score 150, 2 scores above 100)
- Structurally transmitted vibration (Max score 100, 2 scores above 100)
- Reliability considerations (Max score 100, 1 score above 100)
- Reducing capital costs (Max score 100, 1 score above 100)
- Noise Reduction - Broad band (Max score 100, 1 score above 100)
- Mounting arrangements (Max score 100, 1 score above 100)

The **MEDIUM** priority hurdles (Hoare Lea responses appropriately weighted) were:

- Minimisation of vibration
- Blade design & construction
- Maintenance considerations
- Need for omni-directionality
- Electronics for automatic synchronisation to 13A

The **LOW** priority hurdles (Hoare Lea responses appropriately weighted) were:

- Ease of access
- Impact on design of new buildings
- Elimination of pitch alteration mechanism
- Noise Reduction - Low Frequency
- Reduced performance
- Blown debris
- Low Frequency airborne vibration
- Bat & bird strike
- Determining prevailing ambient noise levels

3.3 Possible solutions to the technical hurdles

As well as ranking the technical hurdles, each partner was asked to comment on current procedures (if any) to work around the problem and R&D needs which might produce a solution. These comments have been edited and integrated below so as to create a snapshot of opinion across the disciplines represented in the project. Specific, individual comments are colour-coded as follows: academia (CCLRC and IC), established manufacturers (Marlec), start-up businesses and consultancies (Altechnica, BDSP, Wind Dam Ltd.), and acoustic consultants (Hoare Lea).

3.3.1 Wind regime in the built environment

The importance of this area cannot be over-emphasised. The two specific hurdles relating to “Implications of high turbulence levels” and “Implications of veering or swirling winds” both featured as top five priorities. There remains a lot of uncertainty relating to atmospheric boundary layer flows in urban areas and the design implications for wind turbines located in that environment.

Implications of high turbulence levels	Priority: HIGH
Full Description (i.e. amplification of the problem and why it is important) :	
<p>High turbulence levels in regions of high building density and in some regions of isolated buildings in certain wind directions are generally considered to reduce performance and induce excessive stress and fatigue loads, leading to reduced life and high maintenance requirements. However, Wind Dam claims that higher turbulence levels can increase VAWT output. Turbulence levels are also strongly correlated to increased noise generation.</p>	
Current procedures (if any) using to work around the problem :	
<p>Fatigue life and performance: advise customers not to mount onto buildings and then only in non-turbulent locations.</p> <p>Fatigue life: use appropriate materials and lifetime prediction methods.</p> <p>Noise from inflow turbulence: there is no known solution and nor does one seem likely; the best work round may be to use VAWTs.</p>	
R&D tasks which might produce a solution to the hurdle :	
<p>Investigate methods of reducing turbulence locally to the turbine.</p> <p>Strengthening blade design; understanding and measurement of turbulence levels around buildings.</p>	

Implications of veering or swirling winds	Priority: HIGH
Full Description (i.e. amplification of the problem and why it is important) :	

The Feasibility of Building Mounted/Integrated Wind Turbines (BUWTs)

<p>Veering winds can result in yaw errors for HAWTs which in turn lead to impulsive loads (the seriousness of this problem for small machine design is not well quantified). Design must also optimise power output for the full range of wind directions. Swirling winds can increase the output of VAWTs.</p>
<p>Current procedures (if any) using to work around the problem :</p>
<p>Wind tunnel/CFD/Field tests on duct designs and building envelopes. Use of yawing HAWTs or VAWTs in conjunction with building designs.</p> <p>Faster yaw-tracking response.</p>
<p>R&D tasks which might produce a solution to the hurdle :</p>
<p>Continued work on the above which so far is not extensive. Influence of wind direction on flows over generic shapes. Study of effects of ABL shear in these cases.</p> <p>Development of yaw-tracking algorithms.</p>

3.3.2 Noise and vibration issues

“Structurally transmitted vibration” and “Minimisation of vibration” were both highly prioritised and considered more important than noise issues by all partners, including the acoustic engineers from Hoare Lea (except that Hoare Lea also considered “Noise Reduction – broad band” to be of similar importance).

The importance and character of noise and vibration are dependent on the scale/size of building-integrated wind turbines.

Structurally transmitted vibration	Priority: HIGH
Full Description (i.e. amplification of the problem and why it is important) :	
<p>Steady operation of wind turbines causes the turbine to vibrate, subsequently creating the potential for the vibration to transmit via the turbine’s supports into the building structure. The generation of vibration is exacerbated by turbulent wind conditions acting on both the turbine blades and any mast structures associated with the turbine.</p> <p>Vibration has the potential to cause nuisance to the occupants of the building, as well as long term fatigue damage to the building structure. Low frequency vibrations require extensive isolation measures in conjunction with heavy weight structures that may not be practical to implement in all cases, particularly in the case of turbines fitted to existing light weight building structures.</p>	
Current procedures (if any) using to work around the problem :	
<p>Current knowledge of procedures for overcoming the problem is limited as result of the limited extent of BUWT installations across the UK. Procedures that may be adopted</p>	

include:

- Selection of turbine types/sizes according to the type of supporting building structure (ie. construction) as well as the sensitivity of activities occurring within the building.
- Careful design of the building structure and mounting arrangement to minimise rigid connections, and implement isolation measures commensurate with the scale and frequency of expected vibrations. Ultimately this could comprise completely separated supporting foundations for the building and turbine.
- Careful positioning of the turbines to avoid adverse wind conditions that exacerbate the generation of disturbing vibrations.

Vibrations should be addressed at the design stage by careful component selection, measured on prototype BUWTs, and ameliorated where necessary before moving to commercialisation.

Marlec advise customers not to mount turbines onto buildings.

Wind Dam VAWT prototype testing currently taking place with roof-mounted configuration.

R&D tasks which might produce a solution to the hurdle :

As per noise considerations associated with turbines, measured vibration data for the range and scale of available turbine technologies is required to assess the significance of vibration considerations. Similar to noise considerations, the data would be used for the purpose of identifying high and low risk groupings that may establish the types of systems that warrant further design development focused both on reducing the level of vibration generated, and the design of effective isolation mounting systems.

Investigate sources of vibration & methods of minimising this in the machine design.
Investigate methods of isolating vibration from the building structure.

R&D is needed to:

- identify whether vibration is a genuine problem and how it compares to other potential structural vibration sources in the built environment,
- identify whether different building structural forms are affected to different degrees (e.g. masonry, concrete, steel or timber frame structures).
- determine the effect of building design,
- construct an experimental test facility where prototype BUWTs can be tested on a calibrated and instrumented building structure and levels of structurally transmitted vibration identified and the potential ameliorative processes (e.g. those used for fans, pumps, and motors) assessed.

Further evaluation of VAWT noise and vibration characteristics.

Noise Reduction - Broad band

Priority: HIGH

Full Description (i.e. amplification of the problem and why it is important) :

The noise created by a wind turbine may be sufficient to create adverse reaction both at

external locations, and within surrounding buildings (including the building where the turbine is mounted). The total noise produced by a wind turbine is determined by a range of design attributes, but in all instances is influenced by wind speed (and hence, rotational speed) and the characteristics of the flow conditions that the turbine experiences.

The key noise considerations associated with BUWT proposals are:

- BUWT seeks to introduce noise sources in close proximity to potentially noise sensitive areas and buildings, in contrast to more traditional wind farms placed in rural areas at relatively large distances from noise sensitive receivers.
- BUWT seeks to introduce turbines in urban locations where the built environment can significantly influence wind flow characteristics, subsequently creating conditions (such as turbulence or steep wind gradients) with the potential to exacerbate noise levels generated by the turbines.
- BUWT seeks to introduce wind turbines in urban environments where background noise levels may tend to exhibit reduced background noise level changes with wind speed, in contrast to rural environments where wind disturbance of vegetation often assists in providing masking noise during the conditions that the turbine generates the greatest noise output. The absence of this background noise increase may therefore increase the potential prominence of BUWT noise emissions under higher wind conditions. However, the presence of generally higher background noise levels due to traffic noise, for example, may in part counter this problem.

The resolution/management of these considerations is important for several reasons:

- Noise is an increasingly significant amenity consideration, as reflected by community attitudes, planning directives, and noise related legislation. These factors must be taken account of both in terms of planning, and the potential for future community reaction to an installation (with associated social costs in terms of disturbance, as well as financial costs associated with potential restricted/modified operation of the turbine).
- Environmental noise has implications on the types of ventilation strategies can employ whilst maintaining reasonable internal noise levels. The net economic/environmental efficiency of a turbine will be compromised if operational noise levels require the associated building to be mechanically ventilated (where passive systems would otherwise suffice) for the purpose of controlling external noise intrusion.
- Maximising the range and extent of feasible environments in which BUWT can be implemented.
- Maximising the power producing potential of a development site (eg. by enabling more or larger turbines to be implemented at a given development site).

Current procedures (if any) using to work around the problem :

- Current knowledge of procedures for overcoming the problem is limited as result of the limited extent of BUWT installations in the UK. Procedures that may be adopted include:
- Selection of turbines with noise ratings appropriate to the noise climate and proximity/use of surrounding noise-sensitive buildings. This may involve selections based on turbine size and or type.
 - Careful placement of turbines to minimise the likelihood of excess noise generation due to unfavourable wind conditions.
 - Careful placement of turbines in the least sensitive locations and/or in areas experiencing high ambient noise levels where the contribution of a turbine would be less significant.
 - Careful design of new build supporting structures for the turbines, permitting space

The Feasibility of Building Mounted/Integrated Wind Turbines (BUWTs)

planning and insulation design that accounts for noise considerations associated with the turbine.

- Ducted air intake/discharge as a means of sound attenuation.

Little work has been done specific to BUWTs.

Not currently known to be a problem with Marlec wind turbines.

Wind Dam indicates that noise from its VAWT is minimal.

Apply acoustic design procedures, careful component selection and avoid noise-inducing mechanisms. Measure noise levels of BUWT at prototype stage and ameliorate any noise-inducing mechanisms prior to commercial installation.

R&D tasks which might produce a solution to the hurdle :

At present, there is limited noise data available for the range and scale of potential turbine types that may be implemented. Acquisition of this data is the essential element of further research that enables the scale/significance of the hurdles to be quantified. Further analysis of this data would then enable investigation of possible groupings of turbine types according to noise considerations. Possible groupings could be made on the basis of factors such as overall noise emission and the sensitivity of the noise output to wind conditions (speed, stability, profile etc.). The outcome of this analysis could then enable possible identification of preferred turbine types/selections according to the intended application (ie. high or low noise sensitivity development site), and provide a basis for defining designs that may warrant further investigation design development with a view to reducing noise output.

Field measurements at intermediate or full scale. Tests on a prototype?

Further evaluation of VAWT noise and vibration characteristics.

Need for an experimental test facility where prototypes BUWTs can be tested on a test building structure and establish level of broad band noise if any and identify amelioration measures.

Minimisation of vibration	Priority: MEDIUM
Full Description (i.e. amplification of the problem and why it is important) :	
See “Structurally transmitted vibration”.	
Current procedures (if any) using to work around the problem :	
<p>Special mountings to absorb or isolate vibration have been considered.</p> <p>Acoustic design procedures, careful component selection and avoiding vibration inducing mechanisms. Measure vibration levels of BUWT at prototype stage and ameliorate any vibration inducing mechanisms prior to commercial installation.</p>	

See also “Structurally transmitted vibration”.

R&D tasks which might produce a solution to the hurdle :

May not be a difficult hurdle but needs assessment and attention.

Investigate sources of vibration & methods of minimising this in the machine design.
Investigate methods of isolating vibration from the building structure.

R&D is needed to:

- identify whether vibration is a genuine problem,
- establish whether minimisation of vibration techniques applied to other similar devices such as fans, pumps and motors can be successfully applied,
- develop an experimental test facility where prototype BUWTs can be tested on a test building structure and establish level of vibration if any and identify amelioration measures.

Further evaluation of VAWT noise and vibration characteristics.

See also “Structurally transmitted vibration”.

Noise Reduction - Low Frequency

Priority: LOW

Full Description (i.e. amplification of the problem and why it is important) :

The nature of the problems associated with low frequency noise generated by wind turbines are as defined for “Noise reduction – broad band”. These types of problems are of increased significance when the noise contains significant/prominent low frequency components, for the following reasons:

- Low frequency noise tends to exhibit a slower fall of rate with increasing distance from the source, thus increasing the area over which environmental noise may remain a consideration.
- Low frequency noise more readily penetrates building structures, and can dramatically increase the level of facade insulation required to achieve an appropriate internal noise level within surrounding buildings.
- Low frequency noise has a greater likelihood of creating adverse reaction than noise characterised by a more broad band (balanced) spectrum.
- Noise of a sufficiently low frequency can present as felt vibration rather than audible noise, with associated risk of adverse comment from surrounding sensitive receivers.

Current procedures (if any) using to work around the problem :

As for “Noise reduction – broad band” with an emphasis on the characteristics of the incident air flow.

Not currently known to be a problem with Marlec wind turbines.

Wind Dam indicates that noise from its VAWT is minimal.

The Feasibility of Building Mounted/Integrated Wind Turbines (BUWTs)

R&D tasks which might produce a solution to the hurdle :
As for “Noise reduction – broad band”.

Low Frequency airborne vibration	Priority: LOW
Full Description (i.e. amplification of the problem and why it is important) :	
See “Noise reduction – low frequency”.	
Current procedures (if any) using to work around the problem :	
See “Noise reduction – low frequency”.	
Not currently known to be a problem with Marlec wind turbines.	
Wind Dam indicates that noise from its VAWT is minimal.	
R&D tasks which might produce a solution to the hurdle :	
See “Noise reduction – low frequency”.	

Determining prevailing ambient noise levels	Priority: LOW
Full Description (i.e. amplification of the problem and why it is important) :	
The measurement of prevailing background noise levels is a key factor in determining the acceptability of wind farms located in rural environments. There is no reason to suspect why such assessments of prevailing background noise environments should not prove equally important in the assessment of noise impact in the case of building integrated wind turbines.	
Current procedures (if any) using to work around the problem :	
Procedures for the measurement of background noise environments are clearly defined in ETSU-R-97 by the DTI.	
R&D tasks which might produce a solution to the hurdle :	
*	

3.3.3 Building mounted/integrated wind turbine (BUWT) design

Opinions differed widely on the need for additional work on ducting.

Ducting - need for, design of	Priority: HIGH
Full Description (i.e. amplification of the problem and why it is important) :	

The Feasibility of Building Mounted/Integrated Wind Turbines (BUWTs)

<p>Duct design (where used) is capable of augmenting power by accelerating wind speed on approach to the turbine, effectively counteracting adverse effects of low urban winds and sub-optimal wind directions. Ducting might also reduce turbulence levels and the impact of blade “swish” type noise (further investigation is required).</p>
<p>Current procedures (if any) using to work around the problem :</p>
<p style="color: red;">Much is already known from work on ducted turbines and in the EC-funded <i>Wind Energy in Buildings (WEB)</i> project.</p> <p style="color: blue;">Current procedures include: Wind tunnel/ CFD/ Field Tests of designs</p> <p style="color: green;">Annular ducts have tended not to be adopted for conventional turbines on cost grounds. This is not perceived to be a problem in buildings where the ducting can form part of the building structure and gives benefits to the energy collection system (e.g. Altechnica's patented Aeolian Concentrator incorporates essentially 'unwrapped ducts' which are designed to enhance wind velocity, reduce turbulence, provide acoustic shielding, improve safety, and can provide protection to the device during periods of high winds).</p>
<p>R&D tasks which might produce a solution to the hurdle :</p>
<p style="color: blue;">Much more Wind tunnel/ CFD/ Field Tests of designs is required</p> <p style="color: green;">Some additional R&D into structural design, aerodynamic optimisation and suitable manufacturing methods and materials would be useful.</p> <p style="color: green;">Investigate potential of ducting to reduce emanation of blade “swish” type noise.</p>

Blade design & construction	Priority: HIGH
Full Description (i.e. amplification of the problem and why it is important) :	
<p>Blade design and construction is important to improve performance, since small wind turbines have historically tended to have a relatively low efficiency.</p> <p>Blades need to be designed & constructed for maximum reliability and safety for the environment they will be operating in. When integrated into a building there may be factors which need to be considered which currently do not affect turbines operating in open conditions. Turbine operating conditions need to be understood when more is known about how they will be integrated into the building.</p> <p>Blade design is likely to be a particular problem for larger turbines when faced with increased fatigue loads. Optimum aerodynamic design likely to suggest higher blade solidity.</p> <p>Wind Dam prototype uses (sustainable) wood laminate blades.</p>	
Current procedures (if any) using to work around the problem :	

The Feasibility of Building Mounted/Integrated Wind Turbines (BUWTs)

None
R&D tasks which might produce a solution to the hurdle :
<p style="color: blue;">Development of design method (equivalent to BET) to predict blade loads and rotor power when rotor operates in a building duct or adjacent to a building. Validation of method by wind tunnel or intermediate scale field tests</p> <p style="color: green;">R&D into optimisation of blade design for small wind turbines would be useful.</p> <p style="color: grey;">Improved understanding of turbine operating conditions in the built environment.</p>

Need for augmentation	Priority: HIGH
Full Description (i.e. amplification of the problem and why it is important) :	
<p>Augmentation of power is required to counteract the adverse effects of low urban winds and sub-optimal wind directions. Although rated among the most important technical hurdles by three partners, opinion differed sharply among the other respondents. Altechnica considered this the most important issue in BUWT design.</p>	
Current procedures (if any) using to work around the problem :	
<p style="color: red;">Early developments were more likely to be based around modification of existing technologies.</p> <p style="color: purple;">Wind Dam use of stator on current prototypes.</p>	
R&D tasks which might produce a solution to the hurdle :	
<p style="color: green;">Altechnica's designs employ a number of wind augmentation techniques which merit further development through R&D programmes.</p>	

Safety containment of failed rotor	Priority: HIGH
Full Description (i.e. amplification of the problem and why it is important) :	
<p>Safe containment of a failed rotor is clearly important from a public confidence and safety point of view. The requirement for containment is related to the size and mass of the rotor. Altechnica's roof-integrated designs and screens to protect against blown debris or bird/bat strikes on other systems could be developed to fulfil this role. It is important because of the potential danger to users of the building and neighbourhood and the cost of any damage to the building itself.</p> <p>Wind Dam state that this is its number one priority, since any uncontained failure could destroy the BUWT programme.</p>	
Current procedures (if any) using to work around the problem :	

The Feasibility of Building Mounted/Integrated Wind Turbines (BUWTs)

<p>Should be considered during design of ducting & location/integration with building.</p> <p style="color: purple;">Wind Dam prototypes are VAWTS with stators forming a safety cage.</p>
<p>R&D tasks which might produce a solution to the hurdle :</p> <p style="color: blue;">Design and testing of containment methods which minimise adverse aerodynamic and weight/cost implications.</p> <p style="color: purple;">Subject prototypes to severe wind speed testing, possibly to destruction.</p>

Need for omni-directionality	Priority: MEDIUM
Full Description (i.e. amplification of the problem and why it is important) :	
<p>This is really another aspect of understanding wind flow in the built environment (see above). The related issue of directional constraint due to building orientation and/or “wind screening” or “wind shadowing” from surrounding buildings could be more of a constraint.</p>	
Current procedures (if any) using to work around the problem :	
<p>A design advantage for VAWT systems; however, it need not be a disadvantage for suitably designed HAWT systems.</p> <p style="color: purple;">Both Wind Dam prototypes are omni-directional.</p>	
R&D tasks which might produce a solution to the hurdle :	
<p style="color: green;">Understanding of directional constraint due to building orientation and/or “wind screening” or “wind shadowing” from surrounding buildings.</p>	

Reduced performance	Priority: LOW
Full Description (i.e. amplification of the problem and why it is important) :	
<p>Although related to the “Need for augmentation” hurdle this was rated much lower. It was not generally considered a major issue compared to “Reducing capital costs”. The main issue is the ability to obtain power at low wind speeds, since safety will be the over-riding concern at higher wind speeds (and turbulence regimes).</p>	
Current procedures (if any) using to work around the problem :	
<p>None.</p>	
R&D tasks which might produce a solution to the hurdle :	
<p>See “Need for augmentation” and “Ducting – need for, design of”.</p>	

--

Elimination of pitch alteration mechanism	Priority: LOW
Full Description (i.e. amplification of the problem and why it is important) :	
<p>Elimination of the pitch alteration mechanism was not an issue for some partners and generally rated of low importance. Variable speed fixed pitch or a passive pitch system would produce a simpler, lower cost, lower maintenance solution.</p>	
Current procedures (if any) using to work around the problem :	
<p>Only produce fixed pitch turbines.</p>	
R&D tasks which might produce a solution to the hurdle :	
<p>There is a need for research into the potential for small scale fixed pitch stall-controlled rotors and the uses of warping blade methods.</p>	

3.3.4 Installation issues

Location of BUWT on a building	Priority: HIGH
Full Description (i.e. amplification of the problem and why it is important) :	
<p>This hurdle will have differing impact depending on whether the BUWT is part of a new-build operation or is to be retrofitted to an existing building.</p> <p>For externally mounted turbines optimal location of the BUWT on the building can result in power augmentation, effectively counteracting adverse effects of low urban winds and sub-optimal wind directions.</p> <p>The location of wind turbines in areas of high wind shear or high turbulence will result in increased noise radiation and possible increases in character of the noise, such as blade “swish”.</p> <p>If, as for Altechnica’s designs, the turbine is designed as an integrated part of the roof structure, this hurdle is not relevant (although the influence of different roof shapes and configurations would be).</p> <p>The location must also take into account maintenance, ease of installation, ease of access for maintenance, and proximity to the building electrical system.</p>	
Current procedures (if any) using to work around the problem :	
<p>For locating more conventional turbines on existing roofs, information is already available regarding flow over roofs (plus additional on-going work by TU Delft).</p>	

The Feasibility of Building Mounted/Integrated Wind Turbines (BUWTs)

<p style="color: #8B4513;">Turbines should be located in areas of relatively “clean” inflow conditions.</p>
<p>R&D tasks which might produce a solution to the hurdle :</p>
<p style="color: #8B4513;">CFD should be further used to investigate airflow around buildings.</p> <p style="color: #008000;">Different roof shapes and configurations should be investigated on a test building structure.</p>

Mounting arrangements	Priority: HIGH
Full Description (i.e. amplification of the problem and why it is important) :	
<p>Mounting arrangements are considered to be of moderate importance for reasons of aesthetics, vibration and safety. Again this is more an issue for retrofitting conventional turbines on existing buildings (especially where this application was not considered in the turbine design). In some cases (e.g. Altechnica), the integrated design of turbine and augmentation system means that mounting is an inherent part of the design.</p> <p>The most important issue here is to minimise transmission of vibration into the building structure.</p>	
Current procedures (if any) using to work around the problem :	
R&D tasks which might produce a solution to the hurdle :	
<p style="color: #8B4513;">Investigation into the effectiveness of anti-vibration mountings.</p>	

Electronics for automatic synchronisation to 13A	Priority: MEDIUM
Full Description (i.e. amplification of the problem and why it is important) :	
<p>Variable output from the generators needs to connect to the normal building grid supply & meet all requirements for power quality etc.</p>	
Current procedures (if any) using to work around the problem :	
<p>It is currently commonplace to grid connect wind turbines & PV arrays & there are many suitable grid connect inverters on the market.</p>	
R&D tasks which might produce a solution to the hurdle :	
<p>Involve current manufacturers of such equipment.</p>	

Impact on design of new buildings	Priority: LOW
Full Description (i.e. amplification of the problem and why it is important) :	
<p>New buildings for BUWTs will need to consider envelope and siting implications for</p>	

The Feasibility of Building Mounted/Integrated Wind Turbines (BUWTs)

<p>optimal aerodynamic performance. Some structural implications will also be important. Any requirement for ducting should be considered integrally with the building design, particularly if the building shape is used to direct/smooth the air flow. There is a need to protect occupants from noise emanating from wind turbines.</p> <p>It is possible that future building regulations will require mandatory energy saving/generation opportunities in new designs.</p>
<p>Current procedures (if any) using to work around the problem :</p>
<p style="color: red;">There is evidence that designers are already being innovative in creating “good”, potential building designs.</p> <p>Architects need to understand the requirements of the turbines and/or work closely with wind turbine engineers when designing new buildings.</p> <p style="color: brown;">Noise protection may require minimum separation distances between turbines and occupied premises.</p>
<p>R&D tasks which might produce a solution to the hurdle :</p>
<p style="color: green;">Design guidelines should be developed for architects, designers, building services engineers, etc.</p> <p style="color: brown;">Research into noise emission from smaller scale wind turbines.</p>

3.3.5 Overall systems, operation, and maintenance

Reducing capital costs	Priority: HIGH
Full Description (i.e. amplification of the problem and why it is important) :	
<p>The reduction of capital costs (including installation costs) could be the key to widespread take-up of the technology; cost may be more important than optimising (electrical) performance. This is a particular problem for small turbines where the capital cost per kW installed tends to be much greater than for medium or large turbines.</p>	
Current procedures (if any) using to work around the problem :	
<p>Savings may be found in offsetting costs for tower, foundations, and cabling against those of the building.</p> <p style="color: purple;">Value engineering, design, production sourcing.</p>	
R&D tasks which might produce a solution to the hurdle :	
<p style="color: green;">R&D into optimising BUWT designs for mass production may be beneficial.</p>	

The Feasibility of Building Mounted/Integrated Wind Turbines (BUWTs)

--

Reliability considerations	Priority: HIGH
Full Description (i.e. amplification of the problem and why it is important) :	
<p>The operational lifetime for BUWT systems should be at least 20-25 years with simple replacement and upgrade capability (building lifetimes may be 100 years or more). Equipment should be designed for maximum reliability. Reliability could be severely affected by the design of the building/installation so it is important that the turbine requirements are understood by architects and building engineers.</p>	
Current procedures (if any) using to work around the problem :	
<p style="text-align: center;">Standard design practice.</p>	
R&D tasks which might produce a solution to the hurdle :	
<p style="text-align: center; color: magenta;">System testing and evaluation; component lifetime assessment.</p>	

Maintenance considerations	Priority: MEDIUM
Full Description (i.e. amplification of the problem and why it is important) :	
<p>Any rotating machine will inevitably require some maintenance and therefore access to and ease of maintenance should be considered at an early stage in the design of both the turbine and the building. Maintenance must be made relatively easy, cheap, and infrequent.</p>	
Current procedures (if any) using to work around the problem :	
<p style="text-align: center; color: green;">Careful design is required to minimise maintenance requirements and to provide straightforward access to components.</p> <p style="text-align: center;">Design for minimum maintenance and ease of basic maintenance operations.</p>	
R&D tasks which might produce a solution to the hurdle :	
<p style="text-align: center; color: blue;">Studies at full scale on prototypes, early consideration in building/turbine design.</p>	

Bat & bird strike	Priority: LOW
Full Description (i.e. amplification of the problem and why it is important) :	
<p>Bat and bird strike are important for planning, but generally existing guidelines can be used. Wind Dam notes, however, that the causes and incidences of bat strikes are not well understood.</p>	
Current procedures (if any) using to work around the problem :	

The Feasibility of Building Mounted/Integrated Wind Turbines (BUWTs)

<p>Use existing guidelines.</p> <p>The use of screening (also useful to protect from blown debris) could eliminate the problem to all practical purposes.</p>
<p>R&D tasks which might produce a solution to the hurdle :</p>
<p style="color: purple;">Investigation with bat officer to understand probable reasons.</p>

Blown debris	Priority: LOW
Full Description (i.e. amplification of the problem and why it is important) :	
<p>Blown debris is a safety issue, particularly in storms (branches from trees, roof slates, etc.), and is potentially more of an issue for BUWTs than for remote wind farms. In the worst case, blown debris impacting on the rotor could destroy a turbine.</p>	
Current procedures (if any) using to work around the problem :	
None.	
R&D tasks which might produce a solution to the hurdle :	
<p>The location in the building & design of ducting etc could minimise or eliminate the possibility of damage caused by blown debris.</p>	

Ease of access	Priority: LOW
Full Description (i.e. amplification of the problem and why it is important) :	
<p>Ease of access is a scale related issue. Adequate access can be designed into larger, new-build projects. It will be more of a problem in smaller scale, particularly retrofit situations.</p>	
Current procedures (if any) using to work around the problem :	
See “Maintenance considerations”.	
R&D tasks which might produce a solution to the hurdle :	
Not required at this stage.	

3.4 Conclusions

The most important technical hurdles facing BUWT development have been identified and the current best practice procedures and the need for R&D identified.

The most important technical hurdles can be summarised as:

- the development of suitably understood methods for power augmentation (including the use of building/roof shape or form) and the related question of the use and design of ducting;
- the need to design for high turbulence levels and veering or swirling winds, both critical factors in the location of a BUWT on a building and connected to the issue of the degree of omni-directionality of a BUWT;
- issues relating to the safe containment of any failed rotor, the amelioration of structurally transmitted vibrations (also connected to mounting arrangements) and broad band noise emission; and, finally,
- reliability and capital cost.

Medium priority actions not incorporated in the above were:

- blade design & construction,
- maintenance considerations,
- electronics for automatic synchronisation to 13A.

Finally, the lowest priority hurdles identified were:

- impact on design of new buildings, including ease of access for maintenance,
- technical issues such as elimination of any pitch alteration mechanism, reduced performance, and protections against bat & bird strike or blown debris.
- low frequency noise, airborne vibrations, and their comparison with prevailing ambient noise levels.

4. Assessing the Economics and Potential CO₂ Emissions Savings from BUWTs

4.1 Introduction

The small wind turbine market currently caters more for stand-alone, battery-charging systems than for building-integrated mains power supply. The market for medium-sized (< 100 kW) wind turbines is small and suffers from low sales. In these circumstances it is difficult to assess ultimate potential costs. Section 4.2 therefore presents only a brief review of the current costs of manufacture and indicates the potential additional costs of BUWTs.

Section 4.3 examines the potential carbon dioxide savings from BUWT installations. This is inevitably subjective, based on estimates of the potential size of installations (i.e. wind turbine power rating) and the likely penetrations achievable in different sectors of the built environment. Due to the cubic relationship between wind speed and wind power, the extent to which installations can be “encouraged” towards areas with higher wind speed, or to which BUWT designs can be tailored to augment the prevailing wind speed, can make a large difference in the potential energy generation and hence carbon dioxide emissions savings.

In the case of building-augmented wind turbines (BAWTs) such as Altechnica’s *Aeolian Planar Concentrators*TM, there is considerable potential to increase the size of the recognised wind energy resource (and thus the rate of CO₂ abatement achievable) since these designs permit the useful exploitation of the more frequent lower velocity wind speeds and increase the periods of generation, as well as increasing the productivity of good wind sites.

4.2 Economic evaluation of BUWTs

The economics of small wind turbines is difficult to assess since most current models are developed for battery-charging in stand-alone applications rather than for mains electricity supply. Manufacturing companies may supply suitable batteries and inverters, but rarely get involved with installation. Retrofitting a wind turbine into the fabric of a building involves a complex trade-off between the costs of achieving a secure, safe, vibration-free mounting and the possible savings on tower, foundations, and cabling (which themselves can represent a larger proportion of final installed cost for small compared to large turbines).

A full economic assessment should therefore include:

- (i) basic turbine cost,
- (ii) mains inverter and/or power converter cost,
- (iii) structural installation costs,
- (iv) cabling costs,

whereas it is usually just (i) and (ii) which are usually known a priori.

David Milborrow⁸⁷ (Figure 4-1) has assembled data on medium-size wind turbine capital costs and overall generating costs. At the recent European Wind Energy Conference in London (22-25 November 2004), the mains-connectable Windsave WS1000 (1 kW) wind turbine was being marketed for £995 (+5% VAT), exclusive of installation cost.

⁸⁷ D J Milborrow, *The Economics of Wind Energy*, WREN International Seminar 2004, Figures 4 & 9

The Feasibility of Building Mounted/Integrated Wind Turbines (BUWTs)

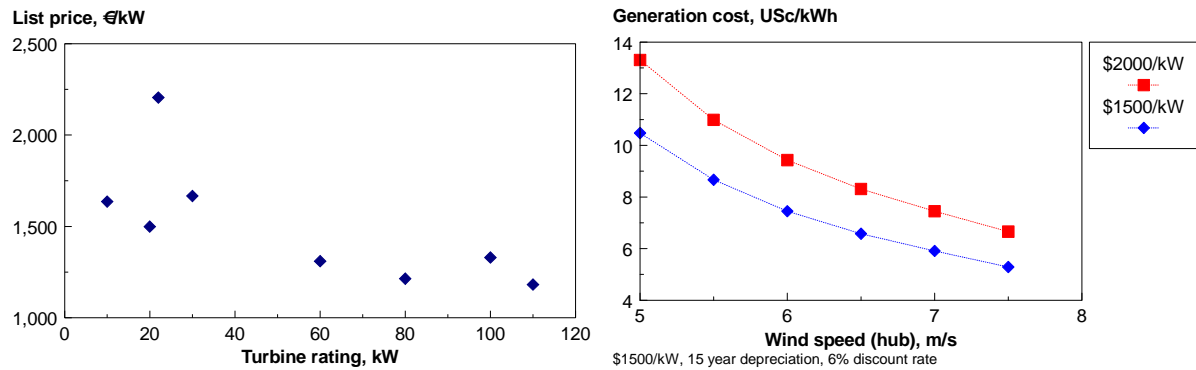

Figure 4-1 : Small-medium-sized wind turbines prices (left) and estimated overall generation costs (right) [Source: Milborrow, 2004]

In the sub-1 kW class, current prices can range up to £3000/kW (including controller/charge regulator and appropriate inverter)⁸⁸, depending on the application. Note that even this is much cheaper than for building-integrated photovoltaic power generation. However, as noted above, these are typically battery-charging turbines adapted to main-supply and it must be assumed there will be considerable scope for cost reduction in BUWTs due to improved system integration and mass-production. Ultimate manufacturing costs below £1000/kW with volume production seem possible.

Installation costs will vary dependent on the scale of the installation, the building construction, specific noise and vibration isolation requirements, cabling, etc.

4.3 Potential CO₂ Emissions Saving

The overall potential carbon dioxide emissions saving from BUWTs is the sum of the individual savings from:

- (i) the retrofitting of BUWTs within the existing building stock,
- (ii) the inclusion of BUWTs in new building construction.

4.3.1 Potential CO₂ Emissions Saving from retrofitting of BUWTs

The potential carbon dioxide emissions saving from the retrofitting of BUWTs in existing buildings depends on:

- (i) the identification of suitable turbine types for different building configurations (particularly wall and roof types),
- (ii) the distribution of these different building types relative to high wind speed areas,
- (iii) the general wind speed deficit within urban areas,
- (iv) possible local wind speed augmentation due to specific configurations of buildings for specific wind directions (e.g. so-called “urban canyon” effects) or specific shapes of buildings (e.g. WEB urban concentrator, Altechnica *Aeolian Roof*TM and related concepts).

⁸⁸ P Fitches, Marlec Engineering, private communication to M J Blanch

The Feasibility of Building Mounted/Integrated Wind Turbines (BUWTs)

Unfortunately there is no single comprehensive database to refer to for the UK building stock. Data is collected separately, in different years, and in different formats for England, Wales, Scotland, and Northern Ireland. For example, while the Scottish House Condition Survey 2002 clearly tabulates wall and roof type, the English House Condition Survey 2001 does not seem to. In addition, domestic buildings are treated separately from commercial buildings (though there will be some overlap, e.g. flats built over shops, which are difficult or impossible to disentangle from the statistics).

The most comprehensive data is collected for council tax rating purposes and so is listed in terms of domestic “dwellings” and commercial “hereditaments”, rather than distinct buildings, which must then be inferred later.

The English House Condition Survey and the Survey of English Housing, published by the Office of the Deputy Prime Minister, are, by their nature, extrapolated upwards from interview surveys. Large blocks of flats have many dwellings and so prevent a dwelling-based survey being easily converted to the total number of buildings. However, it is possible to separate out flats from the rest of the building stock, so a reasonable estimate of the non-flats stock can be made.

The roof area on the top of blocks of flats must be considered as rich potential for the siting of BUWTs, either using multiple guyed towers on the existing roof, or possibly retrofitting the entire roof with a more elaborate installation such as an *Aeolian Roof™* or *Aeolian Tower™* retrofit, but it is impossible to estimate reliably the possible resource from the available data on stock. In addition, issues of roof ownership and liability may well limit penetration. Consequently, a low unit rating per dwelling (i.e. single flat) and low overall penetration level have been assumed.

As already noted, the statistics for Wales, Scotland, and Northern Ireland are presented in slightly different formats than for England, resulting in blurring of the outlines when trying to produce disaggregated totals for different building types across the United Kingdom. The result is the overall view of the UK housing stock presented in Table 4-1.

DOMESTIC BUILDINGS (RETROFIT CAPACITY)	ENGLAND (x10⁶)	WALES (x10⁶)	SCOTLAND (x10⁶)	NI (x10⁶)	TOTAL (x10⁶)
	(1)	(2)	(3)	(4)	
Small terraced house	2.661	0.405	0.495	0.200	7.106
Medium/large terraced house	3.345				
Semi-detached house	5.853	0.387	0.459	0.124	6.823
Detached house	3.273	0.264	0.412	0.115	4.064
Bungalow	2.054	0.101	0.000	0.157	2.246
Converted flat	0.691		0.269	0.052	4.899
Low-rise purpose flat	2.928		0.497		
High-rise purpose flat	0.336		0.060		
TOTAL	21.141	1.157	2.192	0.648	25.138

Table 4-1 : Estimated numbers of dwellings in the United Kingdom

- (1) English House Condition Survey 2001, Office of the Deputy Prime Minister;
- (2) Welsh House Condition Survey 1998, National Assembly for Wales;
- (3) Scottish House Condition Survey, 2002, Communities Scotland, Scottish Executive;
- (4) Northern Ireland Housing Statistics (2002-03), Department for Social Development, NI;

The purposes of these surveys mean that data is recorded about whether repairs have been necessary in the last few years, rather than on the distribution of different types of roof construction. An accurate estimate of the potential for retrofitting BUWTs would need to consider roof structure (e.g. lattice truss, beam, portal frame, vault, or flat roof) and materials (e.g. slate, timber decking) for roof-mounted systems and basic wall construction and material for guyed towers or retrofitting of entire roofs. This is clearly beyond the scope of the available statistics.

It is now necessary to make some assumptions about the appropriate size of installations and the likely penetration level.

For an average detached dwelling, a peak rating of around 1 kW would seem appropriate⁸⁹, either from a single large turbine (around 2m diameter) or from several smaller devices. The expected annual energy output from a 1 kW turbine located in major metropolitan areas can be estimated using wind speed data from the European Wind Energy Atlas (Figure 1-5). This data is presented in the form of wind speed contours at 50m height, with tabulations of supporting anemometer measurements at 10m height for specific sites. As the legend describes, the wind speed indicated at any given geographical location depends on the terrain type. Since most dwellings are in urban or suburban settings, their settings will usually correspond to the “sheltered terrain” category.

From Figure 1-5, therefore, the mean (50m height) wind speeds applying to most UK dwellings will lie in the 4.5-6.0 m/s range. If it is assumed that the average building height is 10m, then the relative wind speed at roof-height is given by⁹⁰:

$$\frac{U(10)}{U(50)} = \frac{\ln(10/z_0)}{\ln(50/z_0)}$$

where z_0 is roughness length. For suburbs, z_0 is in the range 1 to 2 and for a city 1 to 4. Taking the optimistic case ($z_0 = 1$), wind speed at roof-height will be 60% of that indicated at 50m height, suggesting that in most areas (highland, coastal, and large parts of Scotland excepted) the wind resource (before any enhancement from the building) is likely to be less than 4 m/s. The use of building augmentation of wind flow may be able to enhance this to above 5 m/s, depending on building form and wind direction.

What this means in terms of energy generation can be seen from Figure 4-2, which shows the variation in annual energy production from a nominal idealised wind turbine rated at 1 kW at 12 m/s and with a power coefficient of 0.4. In this case measured (10m height) wind speed data from meteorological stations in Manchester, Birmingham, London, Wick, Valley, and Cairngorm have been used (with no building amplification assumed).

⁸⁹ Larger rated capacities, up to 2-4 kW, would appear to be permitted under *Engineering Recommendation G83 - Recommendations For The Connection Of Small-Scale Embedded Generators (Up To 16 A Per Phase) In Parallel With Public Low-Voltage Distribution Networks* (see section 1.8.11). There are potential problems from voltage flicker with higher power systems; installation will be more of a (structural and electrical) engineering challenge; and on good wind speed sites such devices would produce considerably more than the average domestic energy requirement, giving rise to potential grid integration problems from a concentration of such devices (moving “domestic” BUWTs into the commercial distributed generation field).

⁹⁰ Freris, L.L. (ed.), *Wind energy conversion systems*, Prentice Hall, 1990 (p. 16)

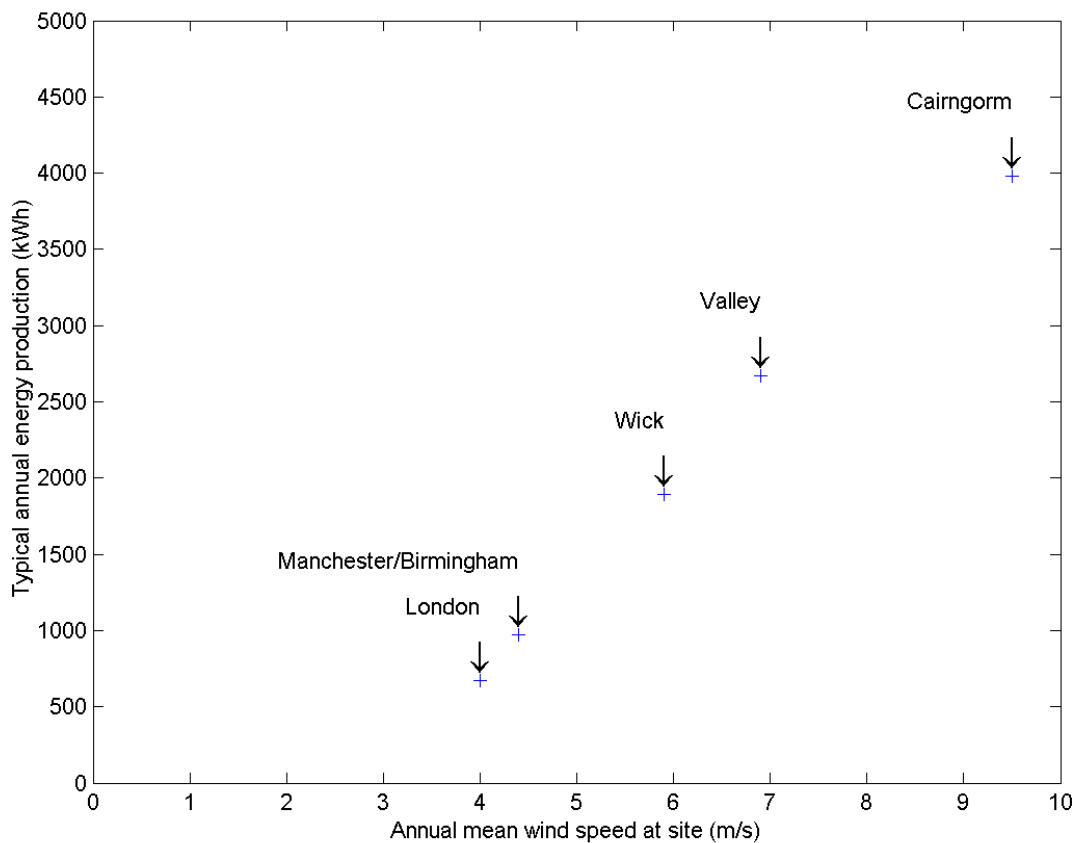

Figure 4-2 : Variation of typical annual energy production to be expected from a 1 kW wind turbine as a function of annual mean wind speed.

Thus, a 1 kW device located in the country's largest cities can be expected to produce between 675 kWh (London) and around 1000 kWh (Manchester/Birmingham), assuming no enhancement effects from the building. However, Mertens⁹¹ has calculated that enhancements of up to 30% higher velocity can be achieved above a flat-roofed building, which, in the Manchester case could improve the annual energy capture to 1750 kWh (i.e. an increase of 75%). Similar augmentation of wind speed has been calculated for the *Aeolian Roof*TM design, indicating the importance of building shape and design. Since a 25% increase in wind speed corresponds to a doubling of the power available for extraction, it is clear that there is much to be gained from further research into wind flow around buildings and the optimal location of small roof-mounted wind turbines.

If higher rated power installations are considered viable, then, for any given site, the expected annual energy production from Figure 4-2 can simply be factored upwards by the power ratio (e.g. a 3 kW device could be expected to produce 2000 kWh per year in London or 3000 kWh in Manchester or Birmingham).

⁹¹ Mertens, S., *Wind Description for Roof Location of Wind Turbines; A design guideline or the required height of a wind turbine on a horizontal roof of a mid- to high-rise building*, Proc Global Windpower, Paris, France, 2-5 April 2002

The Feasibility of Building Mounted/Integrated Wind Turbines (BUWTs)

UK domestic electricity end-use demand⁹² in 2000 was 111.8 TWh, which, between 25.1 million households, amounts to an average end-use demand of 4450 kWh per home. Thus, a 1 kW BUWT could provide a substantial fraction of a UK householder's electricity demand.

Since detailed site monitoring and wind resource assessment are not likely before the deployment of domestic wind power systems, it must be expected that many would be deployed in sub-optimal sites. However, take up can be expected to be higher in rural locations, where exposure is greater and the wind speed conditions more appropriate. The key unknown is the level of penetration that might be achieved and the speed-up enhancement that might be achieved under real conditions with a full wind-rose of wind directions.

For flats, semi-detached, and terraced houses where the average individual household demand will be lower, it is likely that lower capacity turbines would be preferred. Therefore, a lower capacity device (500W for terrace and semi-detached, 250 W for a single flat) has been assumed for these properties. The potential to more systematically exploit the higher wind regime at the tops of domestic tower blocks and high rise flats (which may each be able to accommodate tens or even hundreds of kilowatts rated capacity) has not been considered due to lack of data on building distribution and structural suitability. The suggested capacities for this investigation, together with a distribution of penetration levels starting from suggested baseline targets in the range 0.5% to 2.0% are shown in Table 4-2.

DOMESTIC BUILDINGS (RETROFIT)	No. of buildings (x10 ⁶)	Power of turbine (kW)	Assumed penetration (%)	Total installed capacity (MW)
Terraced house	7.106	0.50	0.50	18
Semi-detached house	6.823	0.50	1.00	34
Detached house	4.064	1.00	2.00	81
Bungalow	2.246	1.00	2.00	45
Flat	4.899	0.25	0.50	6
TOTAL DOMESTIC	25.138		1.0	184

Table 4-2 : Assumed distribution of BUWT turbine capacity and penetration level in the domestic buildings (retrofit) sector

The possible contribution of domestic (retrofit) BUWTs to annual energy production and the resulting reductions in carbon dioxide emissions are shown in Figure 4-3 under different wind regimes. Note that the additional energy production and carbon dioxide emissions savings from building augmentation can be included by interpolating appropriately between the plotted lines. At 10% (retrofit) penetration into the UK building stock, excluding new-build and assuming some building augmentation, BUWTs could be expected to provide 2%-4% of UK domestic electricity demand (111.8 TWh in 2000).

For industrial and commercial buildings, larger installations might be considered. Again, data relating to building type is sparse and in any case does not relate to the availability of structures to support a BUWT structure. The Office of the Deputy Prime Minister publishes data (Table 4-3) on commercial hereditaments in England and Wales. There was insufficient time to locate similar data from either the Scottish Executive or the Northern Ireland administration (however, given the generally smaller number of buildings – around 12% – compared to England and Wales and the speculative nature of the possible penetration figures, this omission does not significantly effect the estimate presented here). Note that the hereditaments data does not explicitly distinguish separate buildings and excludes schools and hospitals. It might be expected that factories and warehouses will have more available land to install a larger turbine, possibly

⁹² DTI, *UK Energy in Brief*, July 2003, p. 15

The Feasibility of Building Mounted/Integrated Wind Turbines (BUWTs)

close to rather than integrated into the building. A typical machine size of 20 kW and low penetration has been assumed for general retail (0.1%) and office (2.0%) premises, rising to 50 kW for factories (5.0% penetration) and other building types (1.0%) and 100 kW for warehouses (1.0% penetration)⁹³. This would result in a broad penetration of 1.5% across the non-domestic building stock, as presented in Table 4-4.

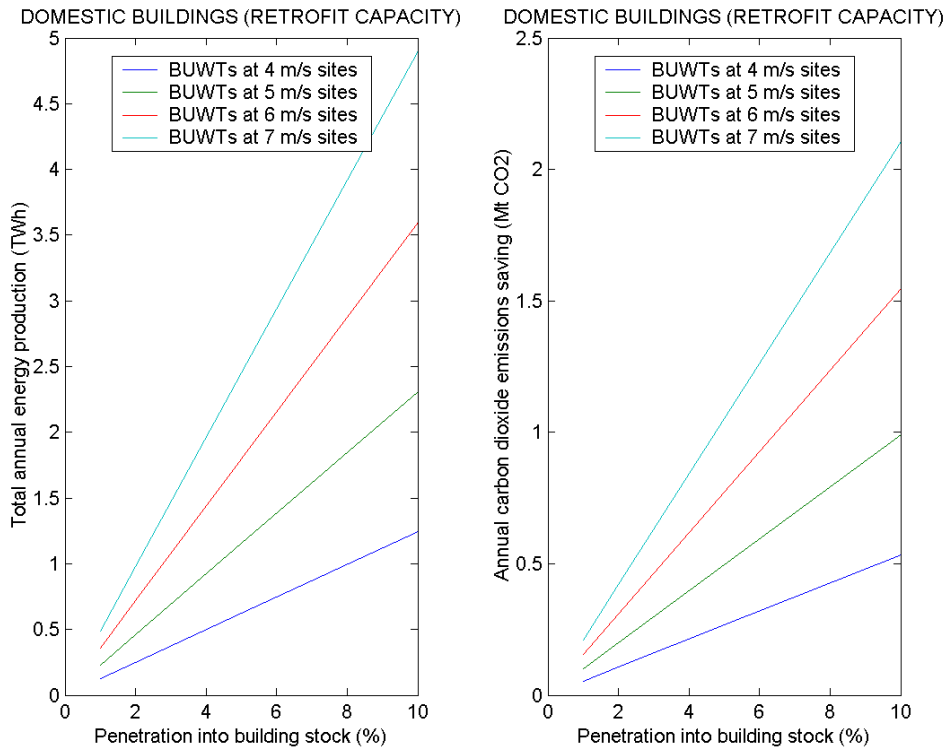

Figure 4-3 : Annual carbon dioxide emissions reduction capacity from domestic buildings for varying penetration of BUWT devices under different wind regimes

NON-DOMESTIC BUILDINGS (RETROFIT CAPACITY)	ENGLAND (x10 ⁶)	WALES (x10 ⁶)	SCOTLAND (x10 ⁶)	NI (x10 ⁶)	TOTAL
	(1)		(2)	(3)	
Retail premises	0.565				0.565
Offices	0.319				0.319
Factories	0.265				0.265
Warehouses	0.201				0.201
Other	0.400				0.400
TOTAL	1.750				1.750

Table 4-3 : Estimated numbers of commercial hereditaments in the United Kingdom
 (1) ODPM, Commercial and Industrial Floorspace and Rateable Value Statistics 2003;
 (2) no data located
 (3) no data located

⁹³ One commercial partner has suggested that these power ratings should be higher (up to 200 kW for general retail, 500 kW for factories, and 1000 kW for warehouses). It must be recognised that the suggested rated capacity figures constitute assumed average installations across a broad range of property types. Although large installations will certainly be possible, they are perhaps better considered on a case by case basis.

The Feasibility of Building Mounted/Integrated Wind Turbines (BUWTs)

NON-DOMESTIC BUILDINGS (RETROFIT)	No. of buildings (x10 ⁶)	Power of turbine (kW)	Assumed penetration (%)	Total installed capacity (MW)
Retail premises	0.565	20	0.1	11
Offices	0.319	20	2.0	128
Factories	0.265	50	5.0	663
Warehouses	0.201	100	1.0	201
Other	0.400	50	1.0	200
TOTAL NON-DOMESTIC	1.750		1.50	1203

Table 4-4 : Assumed distribution of BUWT turbine capacity and penetration level in the non-domestic buildings (retrofit) sector

Figure 4-4 shows the effect on energy production and carbon dioxide emissions reduction of various overall penetrations up to 20%. As with the domestic retrofit sector, it is unlikely that the *average* installation will be in 7 m/s sites, so the ranges shown in the graphs can be assumed to include some (unspecified) degree of wind speed augmentation.

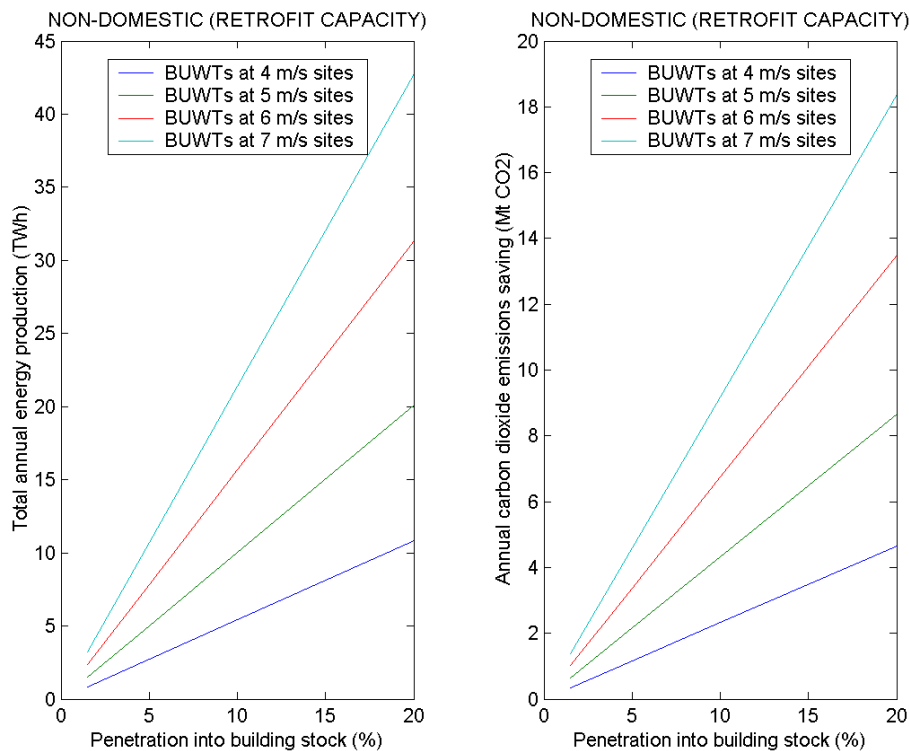

Figure 4-4 : Annual carbon dioxide emissions reduction capacity from non-domestic buildings (note: building stock based on England and Wales only) for varying penetration of BUWT devices under different wind regimes

4.3.2 Potential CO₂ Emissions Saving from new-build of BUWTs

Higher penetration rates could be achieved in new-build, where turbines are designed into the building structure from the start. However, certainly for larger installations, a better assessment of wind resource might then be likely and installations limited to the most productive sites.

The Feasibility of Building Mounted/Integrated Wind Turbines (BUWTs)

NEW BUILD	No. of buildings per year (x10 ⁶)	Power of turbine (kW)	Assumed penetration (%)	Total installed capacity (MW) per year
Domestic (all types) p.a.	0.146	2	5	15
High rise flats ⁹⁴	0.001	20	5	1
Commercial ⁹⁵	0.010	100	5	50
TOTAL	0.157		5	66

Table 4-5: Assumed distribution of BUWT turbine capacity and penetration level in the non-domestic buildings (retrofit) sector

Table 4-5 shows the new-build rate in the domestic buildings sector, together with estimates for the number of medium rise flats and commercial buildings. Somewhat higher BUWT capacities have been assumed compared to the retrofit cases, although the overall capacity per installation remains low compared with modern wind farms. Again, considerably higher capacities for individual installations could be contemplated. In particular, the integration of BUWTs into housing developments, schools, hospitals, and high rise buildings could be considered.

Assuming overall penetrations in the range 1% to 20%, Figure 4-5 shows the potential annual energy production and carbon dioxide emissions savings.

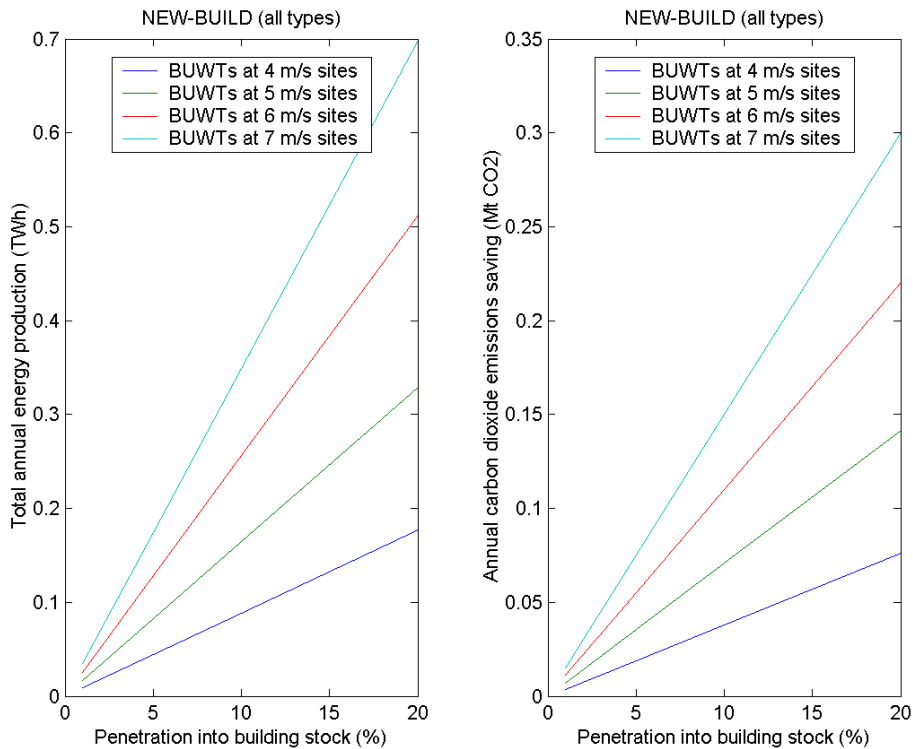

Figure 4-5 : Annual carbon dioxide emissions reduction capacity from new-build (domestic and non-domestic) for varying penetration of BUWT devices under different wind regimes

⁹⁴ National statistics suggest that around 34,000 flats are built each year; for convenience it is assumed that these represent some 1,000 medium rise blocks.

⁹⁵ No data was located on the national build rate of commercial buildings; this was therefore estimated on a pro rata basis from the new build rate of domestic buildings compared with the overall stock.

This analysis omits the possibility of significantly larger systems installed as “architectural statements”, since these are difficult to predict and are likely to be comparatively few (at least in the first instance).

4.3.3 Net Potential CO₂ Emissions Saving from a BUWTs Programme

The overall net potential energy production and hence carbon dioxide emissions savings from BUWTs therefore depend on manufacture and installation rates (retrofit and new build) and the distribution of installations relative to the available wind resource.

The baseline net 1% target for retrofitting BUWTs in the domestic sector represents manufacture and installation of (small capacity: 1 kW or less) turbines on 1% of domestic buildings, i.e. around 250,000 separate units. The 1.5% baseline target for non-domestic buildings represents around 25,000 installations of 20-100 kW units. Finally, the new-build penetration of 5% represents around 7,500 installations per year (7,000 domestic plus 500 non-domestic).

Assuming an initial domestic retrofit market of 1250 installations in 2005 and a market growth rate of 30%, the baseline target penetration for domestic properties of 250,000 installations could be reached by 2020, as shown in Figure 4-6. Figure 4-6 also shows the difference in energy capture and carbon dioxide emissions savings assuming that the installations are concentrated in 4 m/s or 5 m/s wind speed areas. By 2020, these installations could be achieving an annual energy production in the range 1.7-5.0 TWh⁹⁶, depending on local wind speeds, which translates into annual carbon dioxide savings in the range 0.75-2.2 Mt CO₂⁹⁷. In this case, the cumulative carbon dioxide emissions savings to 2020 would be in the range 4.5-13 Mt CO₂.

It is clear from Figure 4-6 that while the bulk of installations are in the domestic sector, the bulk of capacity and energy production is in the non-domestic sector. This outcome is in part due to the relative sizes of devices assumed to be suitable in these two possible markets and so should be treated with some caution. It also seems that even with quite modest penetrations in the retrofit market, this area could be more important than new build.

If a much higher penetration (10%) is assumed in the domestic retrofit market (which could be equivalent to a higher rated capacity per installation, as well as simply more installations), while keeping the non-domestic market and new-build sector at the same levels, then a more even distribution of energy production and modal carbon dioxide savings is achieved (see Figure 4-7). In this case, the energy production at 5 m/s sites would be around 5.5 TWh, compared with 3.2 TWh in the lower penetration case, and the annual carbon dioxide savings could reach 2.3 Mt CO₂ by 2020, compared with 1.4 Mt CO₂ in the lower penetration case. Now, the cumulative carbon dioxide emissions savings to 2020 could be as much as 12 Mt CO₂, compared with 8.1 Mt CO₂ in the lower penetration case.

⁹⁶ 1.7 TWh per year if all installations have annual mean wind speed of 4 m/s; 3.2 TWh per year if all installations have annual mean wind speed of 5 m/s; 5.0 TWh per year if all installations have annual mean wind speed of 6 m/s.

⁹⁷ 0.75 Mt CO₂ per year if all installations have annual mean wind speed of 4 m/s; 1.4 Mt CO₂ per year if all installations have annual mean wind speed of 5 m/s; 2.2 Mt CO₂ per year if all installations have annual mean wind speed of 6 m/s.

The Feasibility of Building Mounted/Integrated Wind Turbines (BUWTs)

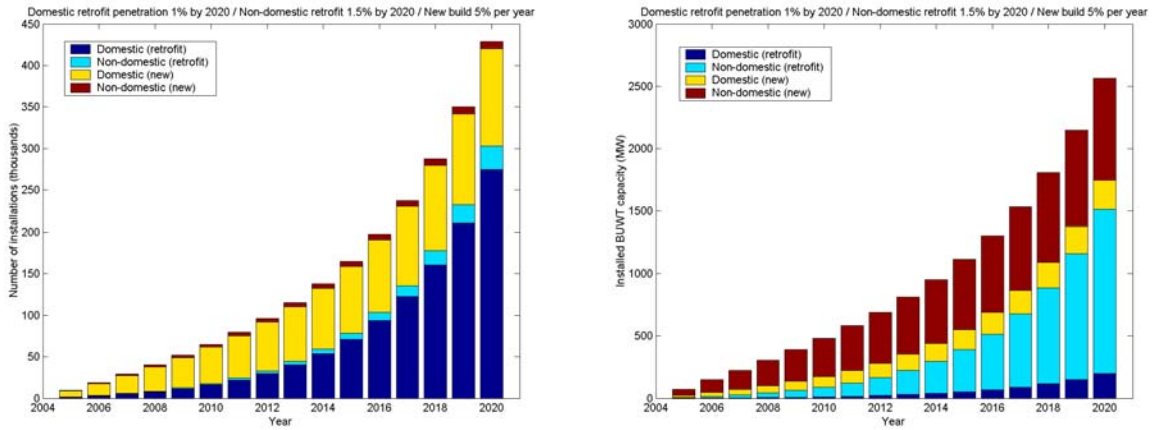

(i) Total number of installations and cumulative capacity

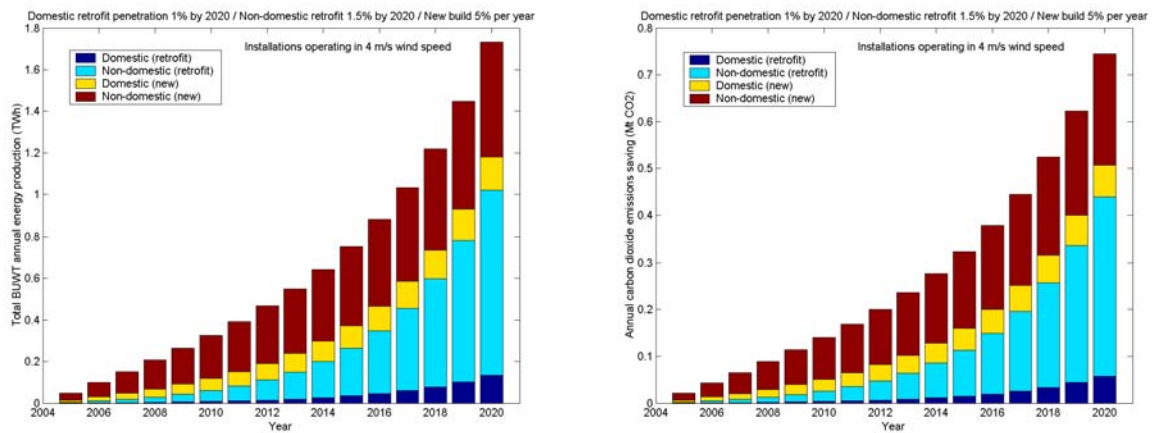

(ii) Energy production and carbon dioxide emissions savings at 4 m/s wind speed sites

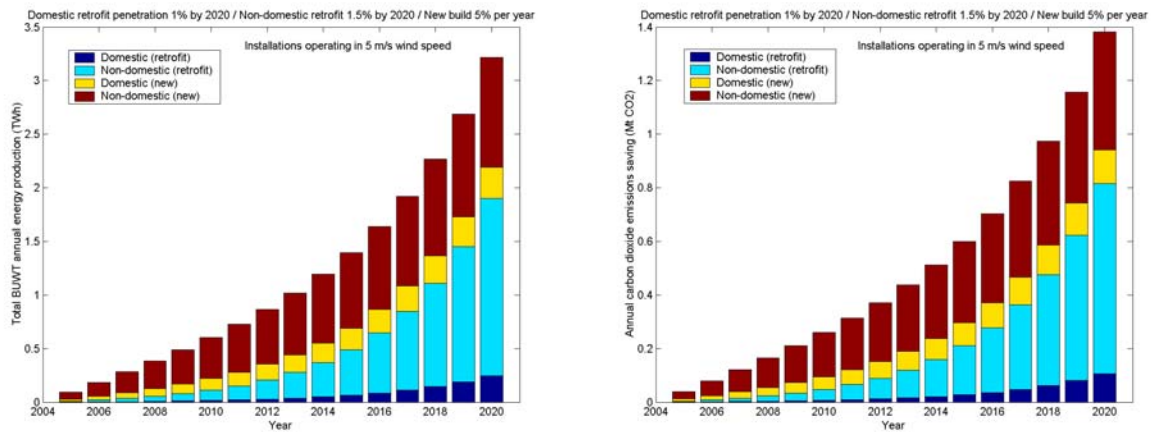

(iii) Energy production and carbon dioxide emissions savings at 5 m/s sites

Figure 4-6 : Potential carbon dioxide emissions savings from BUWTs at penetration levels of 1% in domestic retrofit, 1.5% in non-domestic building retrofit, and 5% in all new buildings

The Feasibility of Building Mounted/Integrated Wind Turbines (BUWTs)

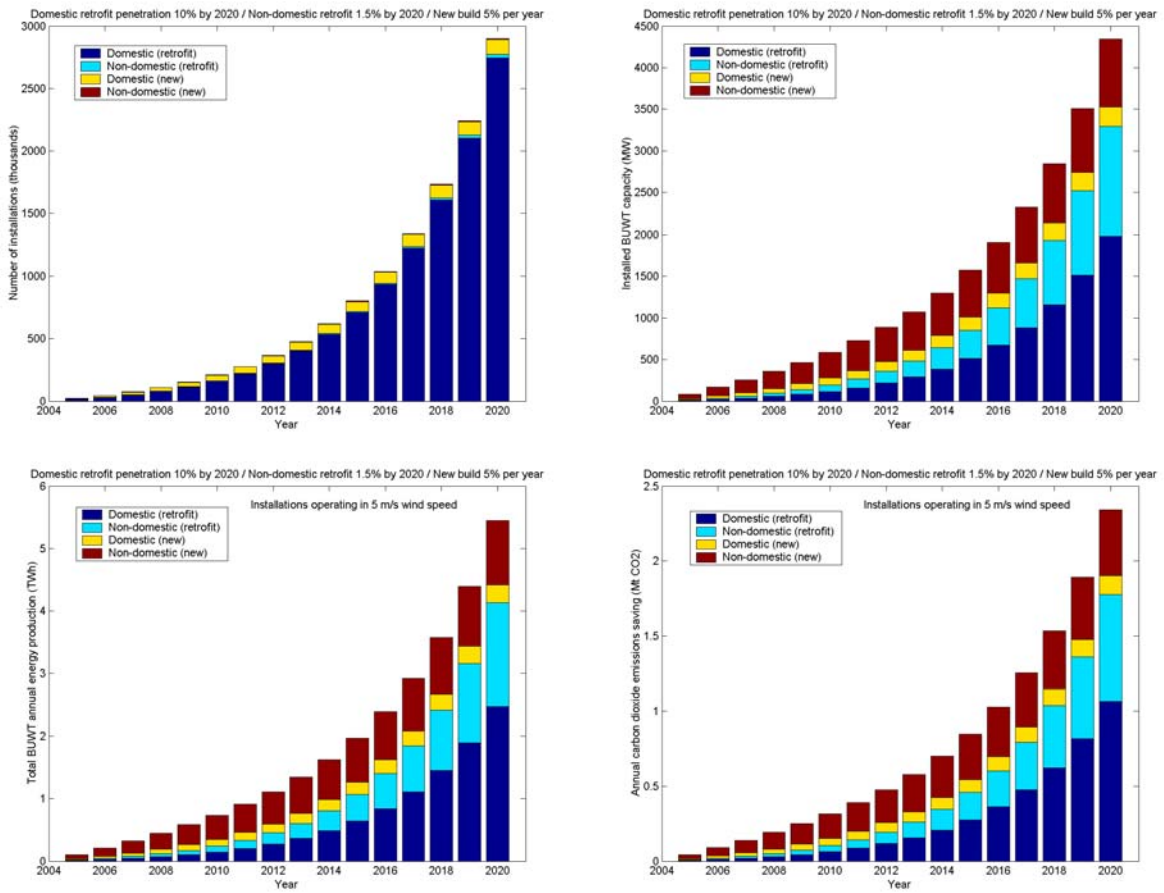

Figure 4-7 : Potential carbon dioxide emissions savings from BUWTs installed in sites with 5 m/s wind regime and penetration levels of 10% in domestic retrofit, 1.5% in non-domestic building retrofit, and 5% in all new buildings

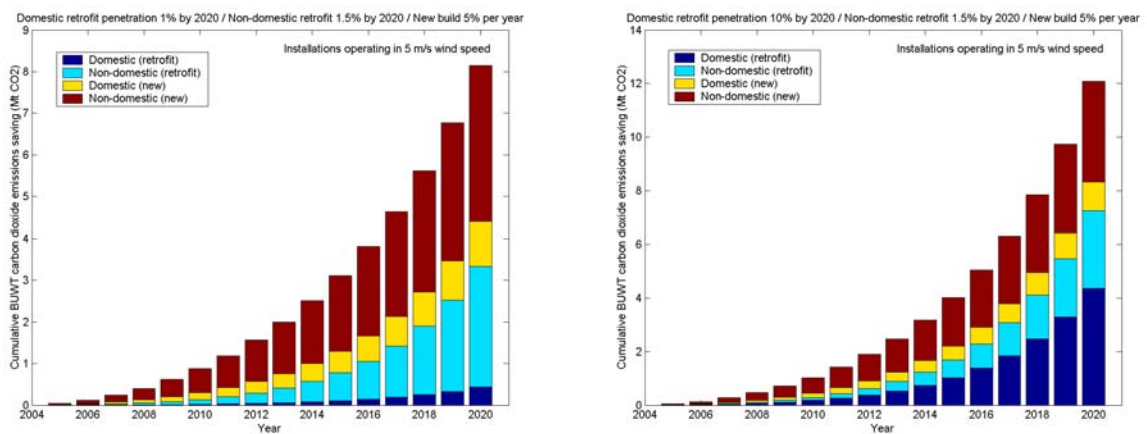

Figure 4-8 : Cumulative potential carbon dioxide emissions savings from BUWTs installed in sites with 5 m/s wind regime and penetration levels of 1% (left) or 10% (right) in domestic retrofit, 1.5% in non-domestic building retrofit, and 5% in all new buildings

4.4 Conclusions

The potential energy production and consequent carbon dioxide emissions reductions that can be expected from Building-Mounted/Integrated Wind Turbines (BUWTs) is dependent on the distribution of suitable building structures with respect to wind regime, the possible enhancement of energy capture due to optimal siting of the installation on the building, and the uptake of devices within the building stock.

It is clear that while BUWTs are, perhaps, most easily adopted in new build configurations (an estimated 66 MW per annum capacity at 5% penetration level), the technology could have a substantially bigger impact from retro-fitting to existing buildings, particularly in the non-domestic sector.

The majority of buildings can be found in inland urban or semi-urban environments where wind speeds are comparatively low (in a UK context). However, significant enhancement of energy capture appears possible by utilising speed-up effects around and over buildings in the optimal siting of turbines.

BUWTs appear to have the capacity to permit buildings a high degree of energy (particularly electricity) autonomy or even to become net electricity exporters. As such they would be able to offset possible liabilities under the Climate Change Levy or future carbon-trading schemes. They might also help to offset future rises in building energy demand due to either battery charging or hydrogen electrolysis for transport use.

It has been estimated that for a BUWT-retrofit penetration of around 1% of domestic properties (and 1.5% non-domestic and 5% penetration in new build properties in both sectors) the annual energy production could be in the range 1.7-5.0 TWh (dependent on the distribution of installations with respect to optimal wind speed) with annual carbon dioxide savings in the range 0.75-2.2 Mt CO₂. The cumulative carbon dioxide emissions savings to 2020 would then be in the range 4.5-13 Mt CO₂.

Since small increases in wind speed have such a large premium in terms of power, the effectiveness of BUWTs can be greatly enhanced by encouraging installations in areas with higher than average wind speed, or by seeking to augment the prevailing local wind speed in some way (by use of ducting, devices such as Altechnica's *Aeolian Planar Concentrators*TM, or simply optimal siting of the turbine in relation to the roof or other concentrating structure), or a combination of the two.

5. Producing a Research and Development Pathway to Demonstration

5.1 Introduction

Previous sections of this report contain a broad assessment of the Building Mounted/Integrated Wind Turbines (BUWTs) field and identify various R&D recommendations. Some of these recommendations were refined by the partners to give the list of specific technical hurdles facing BUWT developers ranked in section 3.

This section further refines these research topics and technical hurdles to give the final set of R&D priorities presented in section 5.2 below. These fall broadly into three categories: resource, structural implications, and design optimisation. An additional pair of R&D priorities on assessing the building resource and its characteristics (see section 5.2.4) arose from the Task 4 activity on assessing the economics and carbon dioxide emissions saving potential of BUWTs.

Finally, a major theme emerging from the list of R&D priorities is the need for improved characterisation and assessment of BUWT devices and the optimisation of their operation for the full range of building types found in the UK. This is discussed in section 5.3 and a possible way forward is suggested.

5.2 R&D priorities for introducing wind turbines into the built environment

The successful deployment of wind turbines into the built environment requires improved understanding in three main areas:

- (i) assessment of the wind regime in urban areas and around isolated buildings,
- (ii) the structural and noise implications of mounting wind turbines on or within a building structure,
- (iii) optimisation of wind turbine design for building applications (including the incorporation of flow enhancement devices).

Finally, a better understanding of the above would enable a more accurate resource assessment to be carried out and hence an improved estimate of the potential carbon dioxide emissions savings.

5.2.1 Assessment of wind regime in urban areas and around isolated buildings

Wind turbine installations in the urban environment will usually be sufficiently small that a thorough resource assessment, such as is normal practice for a commercial wind farm, is not economically feasible. The typical householder or business will need to be able to assess the likely energy payback for a specific device in a specific location and will therefore need to take account of:

- (i) the general wind speed deficit and increased turbulence level caused by the increased surface roughness effect of buildings (typically of order 50x the surface roughness of open fields depending on building density and topology),
- (ii) the trade-off between shadowing and potential speed-up effect within neighbourhoods (e.g. urban canyons) and their effect on the generation and persistence of turbulence,

- (iii) influence of the specific building designs (e.g. aerodynamic contouring of building, speed-up effects over roofs and enhancement devices, etc.) on local wind flow, including turbulence (reduction and magnification) and the occurrence of veering or swirling winds,
- (iv) use of ducting or similar types of flow enhancement technique.

There appear to be deficits in knowledge in all of these areas. All of them will need to be assessed considering the annual wind rose (i.e. not just for the prevailing wind direction). The objective must be to develop some “rule of thumb” guidelines or agreed modelling tools for assessment of annual energy production from a given location.

R&D Priority 1.1: Carry out resource assessments for wind energy potential in a range of different urban environments (e.g. major city centre, high density terraced housing or city blocks, suburban semi-detached and detached housing neighbourhoods, shopping centre, etc.).

Note that work carried out historically on wind flows around buildings has traditionally been targeted at mitigating effects, rather than taking advantage of velocity increases and evaluating energy potential. BUWT devices need to be optimally located in order to achieve the maximum energy capture (a small enhancement of wind speed, or, conversely, shadowing from a chimney stack could potentially make a large difference to the annual energy output). Since there are now several devices being marketed in the UK aimed at mounting on roof-tops or gable-ends, characterising the flow over flat and pitched roofs would be a good place to start. Computational fluid dynamics (CFD) calculations suggest that significant flow enhancement can be obtained due to speed-up effects over pitched roofs (and even more if combined with ducted designs – see section 5.2.3 below). Note, however, that the point of maximum velocity increase (and hence maximum energy capture) is substantially above the ridge-line, which may make the device subject to planning permission in the UK. These CFD calculations have typically been carried out for normal flows and need to be extended to include different flow directions and roof pitches and forms. Ideally these should be validated using *in situ* measurements, which should also assess turbulence levels. In particular, the influence of the wind turbine itself should be included, which could best be assessed using a dedicated test facility.

R&D Priority 1.2: Develop an improved understanding of local air flows around buildings through a combination of computational fluid dynamics modelling and *in situ* measurements.

R&D Priority 1.3: Consider developing a dedicated test facility to evaluate the effect of the wind turbine itself on flow over (or around) the building and to evaluate (and possibly certify) different devices.

A formal international test standard for evaluating the power performance of small wind turbines has never been properly established (largely due to the difficulty of accommodating the diversity of electrical load – often stand-alone battery-charging – conditions). It is suggested that for the purpose of BUWT assessment an appropriate mains electricity interface should be used to give an equivalent, common load condition for comparing devices.

5.2.2 Structural/noise implications of mounting wind turbines on/within a building

The estimate of potential energy resource and hence carbon dioxide savings made in Report 4 of this series was hampered by the lack of adequate data on the geographical distribution of buildings with specific construction (wall and roof) types and topology relative to high and low wind speed areas and lack of measured noise and vibration data from wind turbines mounted on the various characteristic building types. The critical issue is to establish the maximum rated capacity of wind turbine that can be attached to a given type of wall (e.g. masonry, concrete, steel, or timber frame) chimney, or roof structure (e.g. e.g. lattice truss, beam, portal frame, vault, or flat roof with a variety of materials such as slate or timber decking) such that there will be no discomfort from noise or vibration within the dwelling and no significant structural degradation during the lifetime of the wind turbine.

R&D Priority 2.1: Assess the possible combinations of building mounted turbine attachment methods and wall/roof types to determine installation guidelines on appropriate load-bearing capacities.

Assuming better characterisation of the wind regime (particularly turbulence) which the wind turbine will see – as recommended in section 5.2.1 above – the small wind turbine safety guidelines⁹⁸ and installers' guide should be reassessed in the light of likely higher turbulence and wind shear effects. The implications of high turbulence levels (and hence higher loads) must be fully understood for any design. The influence of design modifications (e.g. ducting and aerodynamic mechanisms) in reducing turbulence should be quantified.

R&D Priority 2.2: Re-assess small wind turbine safety standards to ensure that full range of likely turbulence and wind shear conditions are adequately covered.

Noise generation is one of the most significant issues for the successful deployment of BUWTs. Limited noise and vibration studies for one micro-scale BUWT technology have indicated relatively low noise ratings conducive to urban location. However, noise ratings should be made across the range of feasible technologies, taking account of turbine type, size and mounting configuration. The scale of emission variations may potentially limit the feasible types of environment and dwelling for which certain categories/scales of BUWT may be implemented. At present, the low number of operational installations restricts the volume of available noise data. Acquisition of this data will be necessary to aid in the identification of appropriate BUWT technologies that are optimally suited to the various ranges of ambient noise environments, wind characteristics, and building types (particularly important in retro-fit installations).

In particular, the relationship between background noise levels and wind speed in urban and semi-urban environments should be reviewed. A common method of assessing large scale wind farm proposals relies on setting environmental noise limits relative to the prevailing background level. In rural environments, background noise levels typically exhibit significant increases as a result of wind disturbance of vegetation, providing valuable masking noise that effectively reduces the prominence of wind turbines at higher wind speeds where noise emission levels are greatest. In urban and semi-urban environments, the reduced level of vegetation may limit the scale of this masking benefit, placing a premium on quieter turbines.

The noise generation from BUWT technologies should be measured and categorised according to whether they can be readily adopted within the context of existing planning and noise regulatory instruments for various environmental location (urban, semi-urban, rural) categories. If

⁹⁸ IEC 61400-2, *Wind turbine generator systems - part 2: Small wind turbine safety*, ed. 1, 1996-04

significant numbers of devices are excluded, it may be appropriate to fund R&D work to identify technical modifications that appropriately mitigate noise and/or vibration emissions or to consider possible amendments to existing policy guidelines to accommodate BUWT installations, consistent with government sustainability and amenity drivers. It will be important to note that more stringent noise criteria may apply in residential areas during night-time.

R&D Priority 2.3: Carry out a comprehensive review of background noise levels in urban environments and the potential additional contribution of various BUWT technologies

5.2.3 Optimisation of wind turbine design for building applications

Wind energy R&D effort in the last twenty years has tended to concentrate on large machine development for wind farm applications. Small wind turbines have largely been considered for stand-alone battery-charging operation. There is clearly scope for optimisation of small wind turbine design (e.g. blade design, electrical connection, operation in yawed flow, etc), especially in the possible new “ducted” configuration and considering mains grid application.

Optimisation of wind energy devices designed to operate effectively in disturbed or enhanced flow fields is required. The performance of horizontal axis and vertical axis wind turbines operating in axial flow, cross-flow, and mixed flow modes should be compared. Novel blade and rotor designs should be considered to take advantage of the particular flow conditions.

R&D Priority 3.1: Development work to optimise small wind turbine design for operation in the built environment.

Considerable commercial development will be required in order to optimise the configuration of inverters and inverter controllers for small, grid-connected wind turbines so as to maximise the energy production.

There are likely to be potential benefits in optimising generators and in improved matching of generators for BUWTs, similarly for inverters and inverter controllers.

Simplification of the grid connection of wind turbines is an important factor in taking full advantage of this new renewable energy resource of wind energy in the built environment.

Inverter and grid connection developments for PV should be reviewed and their appropriateness for adoption into BUWT designs assessed. The safety implications and licensing of direct “plug-in” connection (as in the Windsave system) of a wind turbine into a building's electricity circuit should be assessed.

R&D Priority 3.2: Optimise inverters, inverter controllers, and generators for small, grid-connected renewable energy applications.

Safety must be the major consideration in the design of BUWT systems. Since, turbines will operate by definition in populated areas, it is important that no parts fall to the ground. Suitable containment methods should be considered which could contain a failed rotor without significantly impairing aerodynamic performance or increasing weight.

Failsafe design methods may be employed if appropriate for minimising risks of failed rotors. For example, consideration might be given to low mass rotor designs to reduce force of impacts or to light-weight membrane blade surfaces which fail by the tearing of the membrane/fabric rather than fracture of heavier components.

R&D Priority 3.3: Develop suitable containment and/or failsafe methods for failed rotors.

5.2.4 Improved assessments of energy resource, cost, and potential CO₂ emissions savings

The development of a Geographical Information System (GIS) incorporating data on local topography, building topology, morphology, orientation, height, wall construction, and roof-type (and which could then be used to match these to the well known wind atlas) would greatly improve the confidence in estimating the potential BUWT energy resource (as well as improving the confidence in estimating the building integrated solar energy resource). In particular, knowledge about the distribution of high-rise buildings or those which project above the surrounding neighbourhood is essential in identifying the best sites for deployment, since these will most likely experience the highest wind speeds.

R&D Priority 4.1: Develop a UK-wide Geographical Information System (GIS) incorporating data on local topography, building topology, morphology, orientation, height, wall construction, and roof-type

This study had insufficient resource to properly assess the potential for BUWT deployment in high-rise buildings and other large structures.

There is a need to identify the location, style, form, orientation and type of high rise buildings in each town in the UK and establish those which are due to undergo refurbishment and where new-build opportunities might arise. A representative subset of high rise buildings should be assessed for their suitability to incorporate BUWTs (combined with energy audits and energy improvement measures).

The main topologies and morphologies of high rise buildings should be identified, alongside the structural forms, cladding and scope for inclusion of BUWTs in renovation and re-cladding programmes. Consideration should be given to the wall and roof-mounting of conventional designs and also the scope for including aerodynamic wind enhancement devices such as Altechnica's patented concepts.

R&D Priority 4.2: Assess the potential BUWT resource in high-rise buildings.

Capital cost will always be the top non-technical issue. Decisions on how best to achieve building carbon performance – the new regulatory standard – will be based on cost benefit analysis. There are many energy efficiency measures that can achieve substantial cuts in emissions and which are already cost effective. BUWTs will therefore be measured against these. In order to get the best return, the BUWTs must displace as much grid supply as possible and therefore will be selected to meet the base load requirements of the building. This approach is no different to that adopted with other energy efficiency /low carbon strategies such as CHP. In order to maximise “base load” provision, storage may be added; exporting power to the grid gives very little return and would probably not be worth pursuing without additional incentives.

The situation is further complicated by the fact that in the commercial world the building user is rarely the occupier. The guaranteed building load available is therefore confined to the landlord actors. It is of course possible that a tenant may wish to install a turbine, but then with a 5 or 10 year lease the economic argument is even more challenging. Further work is required to identify the appropriate economic size of BUWTs within the built environment. Such an understanding

may enable focussing of marketing effort towards particular developments. There are further issues of insurance, as discussed in section 1.9.4.

It is important to realise that unless the economics can be balanced then BUWT technology will ultimately prove unsustainable, as the solar industries are perhaps now beginning to find with the ending of the 40%-60% grants.

R&D Priority 4.3: Assess non-technical barriers to BUWTs, including capital cost, insurance issues, and end-user finance and social issues

5.3 A pathway to BUWT demonstration

5.3.1 Evaluating the potential of BUWTs

Improved energy potential and carbon dioxide reduction estimates beyond those presented in report 4 of this series could be developed initially by better understanding of the resource (see section 5.2.1) through a combination of wind tunnel measurements, computational fluid dynamics calculations, and *in situ* wind speed and turbulence measurements.

This improved estimate of wind resource potential would need to be backed up by the development of a more thorough database of the building stock than currently exists.

5.3.2 Optimising BUWT devices

One of the major difficulties in assessing the appropriateness of BUWT devices is the diversity of machine designs and installation configurations which are currently under consideration. There is a need for a consistent approach to characterisation and a unified approach to certain generic problems. It is suggested that a dedicated BUWT test facility would represent a major advance in addressing these issues.

A dedicated BUWT testing facility would be able to:

- (i) assess different mounting configurations for BUWT devices,
- (ii) compare the power performance of different BUWT devices (for example, it is suggested that small vertical axis and horizontal axis cross-flow turbines are better able to accommodate turbulence than horizontal axis axial-flow designs; certain mixed-flow – combined cross- and axial-flow – designs may even be able to better utilise the flow conditions around buildings than cross-flow or axial-flow designs),
- (iii) compare the performance of wind turbines optimised for use as BUWTs and turbines optimised for operation in the kind of enhanced flow fields experienced in wind concentrators or augmentation fields,
- (iv) assess velocity increase effect over different roof pitches and profiles taking into account eaves, ridge and edge details (and validate computational fluid dynamics calculations of maximum location) especially including the effect of the wind turbine (and its concentrator, if appropriate),
- (v) measure and compare noise and vibration characteristics of different combinations of turbine, mount, and roof/wall construction type and hence contribute to the development of effective isolation mounting systems, m
- (vi) evaluate building-augmented wind turbine concepts (e.g. Altechnica's *Aeolian Planar Concentrator*TM),

- (vii) support the development of appropriate standards for BUWT design, installation, operation, and power performance estimation.

5.4 Conclusions

The energy generation potential and technical feasibility of siting wind turbines in the built environment have been assessed. The study includes various configurations of Building Mounted/Integrated Wind Turbines (BUWTs), considered to be largely but not necessarily exclusively in urban areas: from turbines situated next to buildings, through turbines mounted on buildings, to turbines fully integrated into the building fabric.

It is concluded that wind energy could make a significant contribution to energy requirements in the built environment and that a more detailed evaluation of the resource is justified. In particular, through a combination of new-build with specifically designed wind energy devices and retrofitting of (preferably certified) turbines on existing buildings, it is estimated that the aggregated annual energy production by 2020 from wind turbines in the built environment could be in the range 1.7-5.0 TWh (dependent on the distribution of installations with respect to optimal wind speed)⁹⁹ resulting in annual carbon dioxide savings in the range 0.75-2.2 Mt CO₂. These figures represent between 1.5%-4.5% of the UK domestic sector electricity demand in 2000.

This remains an underdeveloped area of technology with potential for the UK to establish considerable, world-leading technical expertise, building on existing strengths in the small wind turbine market and offering good job creation opportunities.

The successful development of Building Mounted/Integrated Wind Turbines would be assisted by further R&D in four broad areas: assessment of wind regime in urban areas, assessment of the structural implications of BUWTs, optimisation of wind turbine design for BUWT installations, and addressing various non-technical barriers. In addition, the establishment of a national test centre would facilitate the adoption and application of consistent standards for power performance measurement, noise and vibration assessment, and location/mounting and safety. The specific recommendations in each of these areas are as follows:

1. Assessment of the wind regime in urban areas and around isolated buildings

R&D Priority 1.1: Carry out resource assessments for wind energy potential in a range of different urban environments (e.g. major city centre, high density terraced housing and city blocks, suburban semi-detached and detached housing neighbourhoods, shopping centre, etc.).

R&D Priority 1.2: Develop an improved understanding of local air flows around and over buildings through a combination of computational fluid dynamics modelling and in situ measurements.

R&D Priority 1.3: Consider developing a dedicated test facility to evaluate the effect of the wind turbine itself on flow over (or around) the building and to evaluate (and possibly certify) different devices.

2. Assessment of the structural and noise implications of mounting wind turbines on or within a building structure

⁹⁹ The estimated annual energy production of 1.7-5.0 TWh assumes a BUWT-retrofit penetration of around 1% of domestic properties (1.5% in non-domestic) and 5% penetration in all new-build properties

R&D Priority 2.1: Assess the possible combinations of building mounted turbine attachment methods and wall/roof types to determine installation guidelines on appropriate load-bearing capacities.

R&D Priority 2.2: Re-assess small wind turbine safety standards to ensure that full range of likely turbulence and wind shear conditions are adequately covered.

R&D Priority 2.3: Carry out a comprehensive review of background noise levels in urban environments and the potential additional contribution of various BUWT technologies.

3. Optimisation of wind turbine design for building applications

R&D Priority 3.1: Development work to optimise small wind turbine design for operation in the built environment. Particular attention should be paid to device optimisation for operation in enhanced (ducted) flow, cross flow, and high turbulence conditions. Novel blade designs and comparison of vertical and horizontal axis turbines should be considered.

R&D Priority 3.2: Optimise inverters, inverter controllers, and generators for small, grid-connected renewable energy applications.

R&D Priority 3.3: Develop suitable containment or failsafe methods for failed rotors.

4. Addressing non-technical barriers to BUWT installations

The final set of R&D recommendations refers to non-technical barriers. Firstly and most importantly, the construction type and distribution of the UK building stock is insufficiently documented to allow a more rigorous assessment of potential. Additional studies are recommended to improve the data on building statistics, in particular with respect to high rise buildings which sample the maximum urban wind potential. These studies should also consider capital cost, financial mechanisms, and the social position (e.g. whether owner-occupier or landlord-lessee) of the end-user market.

R&D Priority 4.1: Develop a UK-wide Geographical Information System (GIS) incorporating data on local topography, building topology, morphology, orientation, height, wall construction, and roof-type (clearly the development of such a database would have additional benefits outside this particular field, including, in particular, solar energy potential for buildings).

R&D Priority 4.2: Assess the potential BUWT resource in high-rise buildings and other large structures.

R&D Priority 4.3: Assess non-technical barriers to BUWTs, including capital cost, insurance issues, and end-user finance and social issues.

5. Establishment of national test centre for BUWT technologies

The successful demonstration of BUWT technology and the solving of certain generic questions such as mounting configuration, noise and vibration transmission, optimal location, power performance assessment, and the development of standards could be suitably met by establishing a dedicated BUWT testing facility.

Appendix 1: Detailed chart of turbine characteristics

(Note: Whilst every effort has been made to ensure that all the information in these tables is correct, CCLRC and the rest of the BUWT project team do not accept any liability arising from errors and omissions)

As the chart contains much information it is printed over nine successive pages: Pages 1-3 describe whether the turbine has been installed as a BUWT and if, so how and where; pages 4-6 describe how/if the turbine has been tested and certified, and pages 7-9 give specific technical information and a www page link. The order of the turbines within the chart remains the same in each section : thus information about the Proven WT2500 which is listed on page 1 also appears on pages 4 and 7.

From	Company	Model(s)	Building Mounted?	Tested as a prototype ?	Tested as a building mounted commercial machine ?	Number installed on or near buildings	Type	Near Building?	Building Mounted?	Numerically Modelled ?	Tested in wind tunnel ?
BUWTs of UK origin Building Mounted											
UK	Proven	WT2500	Y	Y	Y	50+	HAWT downwind	Y	Y	Y	N
UK	Proven	WT600	Y	Y	Y	10+	HAWT downwind	Y	Y	Y	N
UK	Renewable Devices	Swift	Y	Y	March/April 2004	1	HAWT		Y	Y	
UK	Windsave Ltd.	Windsave 'Plug-and-Save'	Y	Y	Y	various	HAWT	Y	Y	Y	Y
UK	Wind Dam	The Wind Dam is a whole market concept backed by research on both market and technology	Y	Y	Y	1	VAWT- caged, augmented	Y	Y	N	Y
UK	Marlec	Rutland Wind Charger	Y	Y	N	1	HAWT	N	Y		
UK	Proven	WT6000	Y	Y	N	20+	HAWT downwind	Y	Y	Y	N
UK	Proven	WT15000	Y	Y	N	4	HAWT downwind	Y	Y	Y	N
UK	Strathclyde University	Ducted Wind Turbine	Y	Y	N	0	Ducted HAWT		Y		Y
UK	FreeGEN Research Ltd	CATT	Y	Soon	N	0	Ducted HAWT with 2nd rotor	Y	Y	N	N
UK	XCO2 conisbee Ltd	Quiet rEvolution ®	Y	Not Yet (coming soon)	Not Yet (coming soon)	None (Yet)	Elegant 3 Blade Helical VAWT	Y	Y	Y	Y
UK	BDSP, Imperial College, (CCLRC)	WEB Concentrator	Y	N	N	0	HAWT (or VAWT) in Building Concentrator		Y	Y	Y
UK	Robertson and Leaman Ltd.	Roof turbine	Y	N	N	0	Ducted Vertical axis HAWT internal to roof	N	Y	N	N
UK	Altechnica	Patented Aeolian Roof	Y		0	0	Inverted 'wing'/fairing above apex of a low rise roof		Y	Y	Y
UK	Altechnica	Patented Aeolian Tower/Corner	Y		0	0	Wing'/fairing aligned with corner of tall building.		Y		
UK	Altechnica	Patented Aeolian Canopy	Y		0	0	Wing'/fairing aligned with apex of canopy roof		Y		
UK	Altechnica	Patented Aeolian Bi-plane/Tri-plane Linked Buildings	Y		0	0	Bi-plane, Triplane or multi-plane concentrators linked between two or more buildings or adjacent structures.		Y		
UK	Altechnica	Patented Aeolian 'Winged' Buildings	Y		0	0	Bi-plane or Tri-plane concentrators projecting out from building facades or roofs. Fixed or yawable.		Y		
UK	Altechnica	Patented Aeolian U-Top Buildings	Y		0	0	Bi-plane (or Tri-plane) concentrators projecting out from the top of tall buildings roofs. Fixed or yawable.		Y		
UK	Altechnica	Patented Aeolian Fish-tail Tower	Y		0	0	Yawable Bi-plane (or Tri-plane) concentrator enclosing tall building or structure.		Y		
UK	Altechnica	Patented Aeolian Bip-plane/Triplane Concentrator	Y		0	0	Free standing or building mounted yawable Bi-plane/Tri-plane concentrator (vertical or horizontal 'wings' enclosing tall building or structure.	Y	Y		
UK	Altechnica	V2-Turbine	Y		0	0	V2-Turbine next generation V-Type Vertical Axis Wind Turbine. With a very short support structure making it suitable for mounting on buildings.	Y	Y	Y	Y (earlier generation models were tested - but not latest generation version)

From	Company	Model(s)	Building Mounted?	Tested as a prototype ?	Tested as a building mounted commercial machine ?	Number installed on or near buildings	Type	Near Building?	Building Mounted?	Numerically Modelled ?	Tested in wind tunnel ?
UK	Altechnica	Patented Sycamore Rotor Wind Turbine	Y	0	0	0	Single bladed teetered vertical axis wind turbine derived from V-VAWT. With a very short support structure making it suitable for mounting on buildings. Teetering rotor results in much reduced wind induced bending moments on support structure.	Y	Y	Y	Y
UK	Intec		Y	N	N	0	Ducted Cross Flow		Y		Y
Building Mounted potential											
UK	Iskra wind turbines	AT5-1	Not specifically	Y	N	None	5 kW HAWT with 5 m rotor diameter, permanent magnet generator and passive pitch over-speed protection	Not specifically	Not specifically	N	N
UK	Zia Solar	Crescent		NK		0NK	Caged VAWT				NK
Near Building WT											
UK	Gazelle Wind Turbines Ltd	Gazelle	N	Y	? 5 running but None on buildings	2 near buildings (1 @ 15m away, 1 @ 35m away)	HAWT downwind	Y	N	N	
BUWTS of other origin Building Mounted											
NL	Fortis	Espada	Y	Y	Y	?	HAWT	Y	Y	N	N
NL	Fortis	Passaat	Y	Y	Y	>20	HAWT	Y	Y	N	N
NL	Fortis	Montana	Y	Y	Y	10 to 20	HAWT	Y	Y	N	N
Prescott Valley, Arizona, USA	Aeromag Corporation	Lakota 1Kw	Y	Y	Y	200 to 300	HAWT	Y	Y	Y	Airfoils
USA. Branches to follow in the U K and in Ireland.	Wind Electric Incorporated.	Ducted Fan Wind Turbine (DFWT)	Y	Y	Y	About 10 test, trial, installations were done around different prototypes of the DFWT.	Aerodynamically configurable DFWT. Complementary lift, diffusion augmentation system, self steering.	Y	Y	Y	Y

From	Company	Model(s)	Building Mounted?	Tested as a prototype ?	Tested as a building mounted commercial machine ?	Number installed on or near buildings	Type	Near Building?	Building Mounted?	Numerically Modelled ?	Tested in wind tunnel ?
Germany/ USA	WindKraft inc	WINDKRAFT 1.5	Y	Y	Y - On a building as a residential and as a commercial machine!	5 Units	Horizontal - WT featuring a joined wing helix/sinusoid plan form utilizing a high speed wing design with automated computer controlled motorized yaw control for direction and speed control.	Y	Y	N	Y
NL	Turby b.v.	Turby	Y	Y	Not yet, starting in March 2004	From march 2004 onwards 24 units	Slanted bladed VAWT 1,99 m dia x 2,65 m height (overall height 3 m)	N	Y	Y	Y
NL	WindWall B.V.	WindWall 1,2 m dia by 9 m long	Y	Y	N	2	cross flow		Y	N	Y (Univ. of Twente)
NL	WindWall B.V.	WW2000	Y	N	N	0	2,0 m dia 15 to 30 m long		Y		
NL	WindWall B.V.	WW4000	Y	N	N		0 4 m dia 25 to 40 m long		Y		
Finland	Shield Innovations	Aiolos	Y	Y	Will happen in 2004	FEW	Aiolos-Savonius VAWT	Y	Y	Y	Y
Finland	Shield Innovations	Aiolos					Aiolos-Darrieus VAWT				
NL	Ecofys	Neoga	Y	N	N	None	Darrieus VAWT	Y	Y	Y	N
NL	Ecofys	Hera	Y	N	N	None	Ducted Darrieus VAWT	N	Y	N	N
Canada	Sambrabec	Sambrabec Turbine	Y	Y	N	65	Turbine concept (like hydraulic) no blade or propeller	Y	Y	N	Y
USA	ENECO Texas LLC	WARP™ (Wind Amplified Rotor Platform)	Y	Y	N	None	World-wide patented stacked array of multi-use toroidal wind amplifier modules incorporating small diameter HAWTs or other turbine options) mounted thereon - see: www.warp-eneco.com	Y	Y	Y	Y
Italy	Ropatec	WRE.030	Can be done	Y	N	0	VAWT	Y	Can be done	N	N
Italy	Ropatec	WRE.060	Can be done	Y	Y	1	VAWT	Y	Can be done	N	N
Italy	Ropatec	WRE.007	Can be done	Y	N	0	VAWT	N	Can be done	N	N
USA	Wyndpower						Caged VAWT 5.5' diameter and 5.5' tall and weighs just 180 pounds.				
Japan	Panasonic	Wind power (Small power system)									
NL	Prowin	Provane 5							Y		
USA	Southwest Windpower	Whisper and AIR ranges					HAWT		Y		
Canada	Dermond	DWT					Darrieus VAWT				
Finland	Shield	Jaspira					Savonius VAWT				
Finland	Windside	WS-Turbine range					Savonius VAWT				
Iceland	Vindorka						HAWT				
USA	Aeritecture						VAWT?				
USA	EcoQuest	WindTree					Ducted HAWT				
France	Cita	CH CAP HORN 12/5.3, CH CAP HORN 10/POL					Ducted HAWT				
Czech	Enflo Systems						Ducted HAWT				
NZ/Mexico	Solwind	enflo 0060, enflo 0300, enflo 0700, enflo 2200					Darrieus H-VAWT, not BUWT				
Denmark	Calorius A/S	Calorius 37B					HAWT for water heating				
NL	Lagerwey						HAWT fitted to Expo 2000				

From	Company	Model(s)	Tested as open air research machine ?	Tested as a prototype ?	Tested as a building mounted commercial machine ?	certified to	Number installed on or near buildings	Total number forecast to be installed by end of 2004	Notes
BUWTs of UK origin Building Mounted									
UK	Proven	WT2500	Y	Y	Y	Self Cert CE	50+	400+	
UK	Proven	WT600	Y	Y	Y	Self Cert CE	10+	80	
UK	Renewable Devices	Swift		Y	March/April 2004	BS EN 61400 certified + safety due diligence	1	50	
UK	Windsave Ltd.	Windsave 'Plug-and-Save'	Y	Y	Y	CE due 2-4 weeks	various	3-4,000 units	
UK	Wind Dam	The Wind Dam is a whole market concept backed by research on both market and technology	Y	Y	Y	N	1	At least three	Prototype on test in real conditions
UK	Marlec	Rutland Wind Charger		Y	N	CE Marked	1		1 prototype
UK	Proven	WT6000	Y	Y	N	Self Cert CE	20+	170	
UK	Proven	WT15000	Y	Y	N	Self Cert CE	4	30	
UK	Strathclyde University	Ducted Wind Turbine	Y	Y	N	n/a			several wind tunnel models; 2 free air research machines
UK	FreeGEN Research Ltd	CATT	Y	Soon	N	N	0	1	Multiple models
UK	XCO2 conisbee Ltd	Quiet rEvolution ®	Not Yet (coming soon)	Not Yet (coming soon)	Not Yet (coming soon)	N	None (Yet)	4	Half Scale Tunnel Model
UK	BDSP, Imperial College, (CCLRC)	WEB Concentrator	Y	N	N	N	0		1 Free Air Research Model
UK	Robertson and Leaman Ltd.	Roof turbine	N	N	N	UK Patent GB 2384528A Pending	0		0 Concept stage
UK	Altechnica	Patented Aeolian Roof							
UK	Altechnica	Patented Aeolian Tower/Corner							
UK	Altechnica	Patented Aeolian Canopy							
UK	Altechnica	Patented Aeolian Bi-plane/Tri-plane Linked Buildings							
UK	Altechnica	Patented Aeolian 'Winged' Buildings							
UK	Altechnica	Patented Aeolian U-Top Buildings							
UK	Altechnica	Patented Aeolian Fish-tail Tower							
UK	Altechnica	Patented Aeolian Bip-plane/Triplane Concentrator							
UK	Altechnica	V2-Turbine	Y (earlier generation models were tested - but not latest generation version)						2 x wind tunnel model of earlier generation, but not latest generation V-2 Turbine.

From	Company	Model(s)	Tested as open air research machine ?	Tested as a prototype ?	Tested as a building mounted commercial machine ?	certified to	Number installed on or near buildings	Total number forecast to be installed by end of 2004	Notes
UK	Altechnica	Patented Sycamore Rotor Wind Turbine							1 x wind tunnel model.
UK	Intec		N	N	N		0		1 Wind Tunnel Research Model
Building Mounted potential									
UK	Iskra wind turbines	AT5-1	N	Y	N	CE	None	We aim to have installed 22 machines by end of 2004; I don't know if any of these will be on or near buildings	Prototype on farm in Derbyshire
UK	Zia Solar	Crescent	NK	NK			NK		
Near Building WT									
UK	Gazelle Wind Turbines Ltd	Gazelle		Y	? 5 running but None on buildings	Self CE Marked, built to conform with IEC 61400 Turbine Class III. Not Certified by GL or similar	2 near buildings (1 @ 15m away, 1 @ 35m away)	3 near buildings	
BUWTS of other origin Building Mounted									
NL	Fortis	Espada	N	Y	Y	None	?	?	?
NL	Fortis	Passaat	N	Y	Y		>20		
NL	Fortis	Montana	N	Y	Y		10 to 20		
Prescott Valley, Arizona, USA	Aeromag Corporation	Lakota 1Kw	Y	Y	Y	N	200 to 300	700	
USA. Branches to follow in the U K and in Ireland.	Wind Electric Incorporated.	Ducted Fan Wind Turbine (DFWT)	Y	Y	Y	The DFWT has never been submitted for certification to European or UK	About 10 test, trial, installations were done around different prototypes of the DFWT.	A dozen or so DFWT units should have installation by the end of 2004.	(The original work was done by American Power & Light, Inc, incorporated in October, 1982.)

From	Company	Model(s)	Tested as open air research machine ?	Tested as a prototype ?	Tested as a building mounted commercial machine ?	certified to	Number installed on or near buildings	Total number forecast to be installed by end of 2004	Notes
Germany/ USA	WindKraft inc	WINDKRAFT 1.5	N	Y	Y - On a building as a residential and as a commercial machine!	No certification to date!	5 Units	None	N/A
NL	Turby b.v.	Turby		Y	Not yet, starting in March 2004	CE marking pending; EN 16400 not applicable for VAWT	From march 2004 onwards 24 units	> 100 expected	
NL	WindWall B.V.	WindWall 1,2 m dia by 9 m long	N	Y	N	N	2	approx. 3	
NL	WindWall B.V.	WW2000					0	approx. 5	
NL	WindWall B.V.	WW4000							
Finland	Shield Innovations	Aiolos	Y	Y	Will happen in 2004	N	FEW	300	
Finland	Shield Innovations	Aiolos							
NL	Ecofys	Neoga	N	N	N	None	None	-3	no tests
NL	Ecofys	Hera	N	N	N	None	None	None	no tests
Canada	Sambrabec	Sambrabec Turbine	Y	Y	N	N		65??	
USA	ENECO Texas LLC	WARP™ (Wind Amplified Rotor Platform)	Y	Y	N	Not yet	None	None	1 Wind Tunnel Model and 1 single module prototype
Italy	Ropatec	WRE.030	N	Y	N	CE			We are working on it
Italy	Ropatec	WRE.060	N	Y	Y	CE		1	We are working on it
Italy	Ropatec	WRE.007	Y	Y	N	CE			We are working on it.
USA	Wyndpower								100
Japan	Panasonic	Wind power (Small power system)							
NL	Prowin	Provane 5			Y				
USA	Southwest Windpower	Whisper and AIR ranges							
Canada	Dermond	DWT			Y				
Finland	Shield	Jaspira							
Finland	Windside	WS-Turbine range							
Iceland	Vindorka								
USA	Aeritecture								
USA	EcoQuest	WindTree							
France	Cita	CH CAP HORN 12/5.3, CH CAP HORN 10/POL							
Czech	Enflo Systems								
NZ/Mexico	Solwind	enflo 0060, enflo 0300, enflo 0700, enflo 2200							
Denmark	Calorius A/S	Calorius 37B							Calorius is approved by the Risø Research Centre
NL	Lagerwey								

From	Company	Model(s)	Power rating away from building (W)	Power rating on/near building (W)	mounted your model/device/concept on buildings with permission	mounted your model/device/concept on buildings	Installed	Web page
BUWTS of UK origin Building Mounted								
UK	Proven	WT2500	2.5 kW @ 14 m/s	2.5 kW @ 14 m/s	Y		World	www.provenenergy.com
UK	Proven	WT600	600 W @ 12 m/s	600 W @ 12 m/s	Y	Y	World	www.provenenergy.com
UK	Renewable Devices	Swift	1.0 kW	1.5 kW	N	N	Midlothian Scotland	www.renewabledevices.co.uk
UK	Windsave Ltd.	Windsave 'Plug-and-Save'	~ 500	~500	N	N	-	www.windsave.com
UK	Wind Dam	The Wind Dam is a whole market concept backed by research on both market and technology	Not yet rated	Not yet rated	N	N	Prototype in Cornwall	N/A
UK	Marlec	Rutland Wind Charger	250/340W @ 10m/s	Not Known	N	N		www.marlec.co.uk
UK	Proven	WT6000	6 kW @ 12 m/s	6 kW @ 12 m/s			World	www.provenenergy.com
UK	Proven	WT15000	15 kW @ 11 m/s	Example 35 kW @ 15 m/s			Italy/Scotland	www.provenenergy.com
UK	Strathclyde University	Ducted Wind Turbine	n/a	90	N	N	University	www.esru.strath.ac.uk/EandE/Web_sites/01-02/RE_info/Urban%20wind.htm
UK	FreeGEN Research Ltd	CATT	5 - 20 kW	5 - 20 kW	N	N		N/A
UK	XCO2 conisbee Ltd	Quiet rEvolution ®	1kW-30kW	1kW-30kW	N	N	N/A	www.xco2.com
UK	BDSP, Imperial College, (CCLRC)	WEB Concentrator	~100 kW	~250 kW	N	N		www.bdsp.com/web ; www.eru.rl.ac.uk/web.htm
UK	Robertson and Leaman Ltd.	Roof turbine	5000	Unknown (5000 +)	N	N	N/A	N/A
UK	Altechnica	Patented Aeolian Roof	variable	variable				N/A
UK	Altechnica	Patented Aeolian Tower/Corner	variable	variable				N/A
UK	Altechnica	Patented Aeolian Canopy	variable	variable				N/A
UK	Altechnica	Patented Aeolian Bi-plane/Tri-plane Linked Buildings	variable	variable				N/A
UK	Altechnica	Patented Aeolian 'Winged' Buildings	variable	variable				N/A
UK	Altechnica	Patented Aeolian U-Top Buildings	variable	variable				N/A
UK	Altechnica	Patented Aeolian Fish-tail Tower	variable	variable				N/A
UK	Altechnica	Patented Aeolian Bip-plane/Triplane Concentrator	variable	variable				N/A
UK	Altechnica	V2-Turbine	variable	variable				N/A

From	Company	Model(s)	Power rating away from building (W)	Power rating on/near building (W)	mounted your model/device/concept on buildings with permission	mounted your model/device/concept on buildings	Installed	Web page
UK	Altechnica	Patented Sycamore Rotor Wind Turbine	variable	variable				N/A
UK	Intec							N/A
Building Mounted potential								
UK	Iskra wind turbines	AT5-1	5.3 kWe at 12 m/s	5.3 kWe at 12 m/s	N	N		www.iskrawind.com
UK	Zia Solar	Crescent						www.rainbowtradingpost.co.uk/crescent_gen.html
Near Building WT								
UK	Gazelle Wind Turbines Ltd	Gazelle	20 kW		N	N		www.northenergy.co.uk
BUWTS of other origin Building Mounted								
NL	Fortis	Espada	600	400	?	Y	EU+asia	www.fortiswindenergy.com
NL	Fortis	Passaat	1250	800	Y	Y	EU+asia	www.fortiswindenergy.com
NL	Fortis	Montana	4000	2000	Y	Y	EU+asia	www.fortiswindenergy.com
Prescott Valley, Arizona, USA	Aeromag Corporation	Lakota 1Kw	1kW at 25 mph	900 watts at 27mph	Y	Y	To many to list	www.aeromag.com truenorthpower.com
USA. Branches to follow in the U K and in Ireland.	Wind Electric Incorporated.	Ducted Fan Wind Turbine (DFWT)	The Three Meter fan version of the DFWT: 1.5 KW at 15 MPH. 12 KW at 30 MPH provided the generator/alternator is up to it. The DFWT can run and perform at essentially any wind speed, even above 100 MPH.	Building power ratings depend upon the extent to which the building turbulence can be in taken by the DFWT: the extent to which the building can be utilized as a concentrating collector. This field remains largely unexplored in turbine research.	Y	N		www.mxq.com

From	Company	Model(s)	Power rating away from building (W)	Power rating on/near building (W)	mounted your model/device/concept on buildings with permission	mounted your model/device/concept on buildings	Installed	Web page
Germany/ USA	WindKraft inc	WINDKRAFT 1.5	Estimated 1.5 kW @ 16m/s	Estimated 1.5 kW @ 16m/s	Y	Not known	Germany, France and Spain	www.windkraftusa.com
NL	Turby b.v.	Turby	2.5 kW at 12 m/s	same	N	N	not applicable	www.turby.nl
NL	WindWall B.V.	WindWall 1,2 m dia by 9 m long	approx. 200 W/m2 at 10 m/s	approx. 200 W/m2 at 10 m/s	N	N		www.windwall.nl
NL	WindWall B.V.	WW2000			N	N		www.windwall.nl
NL	WindWall B.V.	WW4000	24 to 36 kW		N	N		www.windwall.nl
Finland	Shield Innovations	Aiolos	800	800	N	N		www.shield.fi/
Finland	Shield Innovations	Aiolos	Aiolos active optimizing	Aiolos active optimizing				
NL	Ecofys	Neoga	see xls file	not specified	N	N	not applicable	www.urbanturbines.com
NL	Ecofys	Hera	not specified	not specified	N	N	not applicable	www.urbanturbines.com
Canada	Sambrabec	Sambrabec Turbine	2,5kW, 5kW, 10kW, 20kW	NEAR = all models	N	N	Quebec (Canada), Brazil, North Africa	http://pages.infinit.net/sambrab/presentation_cat_ang.htm
USA	ENECO Texas LLC	WARPTM (Wind Amplified Rotor Platform)	May be any rating from kW to deca-MW	May be rated from kW to MW level	Y - recently conceptually.	N	N/A	www.warp-eneco.com
Italy	Ropatec	WRE.030	Nominal output at 14m/s	It depends on the site	Not yet	N	Switzerland	www.ropatec.com
Italy	Ropatec	WRE.060	Nominal output at 14m/s	same				
Italy	Ropatec	WRE.007	Nominal output at 14m/s	same				
USA	Wyndpower							www.wyndpower.com
Japan	Panasonic	Wind power (Small power system)	300W, 500W, 1000W					www.panasonic.co.jp/mesc/products/en/index.html
NL	Prowin	Provane 5						www.prowin.nl
USA	Southwest Windpower	Whisper and AIR ranges	400 W to 3 kW					www.windenergy.com
Canada	Dermond	DWT	100 kW to +MW					www.mckenziebay.com
Finland	Shield	Jaspira						www.shield.fi/turbine.html
Finland	Windside	WS-Turbine range						www.windside.com
Iceland	Vindorka							www.vindorka.is
USA	Aeritecture							www.aeritecture.com
USA	EcoQuest	WindTree						www.ecoquestintl.com/eqwindtreepg.htm
France	Cita	CH CAP HORN 12/5.3, CH CAP HORN 10/POL	12 kW					www.cita-wind.com
Czech	Enflo Systems		0,5, 6, 50, 500 kW					www.enflo-systems.com
NZ/Mexico	Solwind	enflo 0060, enflo 0300, enflo 0700, enflo 2200						www.solwind.co.nz/vertical.htm
Denmark	Calorius A/S	Calorius 37B	5 kW					www.calorius.dk/Index_EN.asp
NL	Lagerwey		2.5 kW					Company has been taken over No contact could be made with the new owner

Appendix 2: Relative importance assigned to the 25 hurdles

Each partner was asked to distribute 1000 points between the 25 hurdles according to the importance that should be attached to each one. (N.B. Hoare Lea figures have been weighted to allow for the fact that they marked only areas concerned with acoustics and vibrations.) The highest single grade awarded was 300 (to “Need for augmentation” by Altechnica). All the following graphs are therefore plotted with 300 as the scale maximum for ease of comparison.

Wind regime in the built environment:

- Implications of high turbulence levels
- Implications of veering or swirling winds

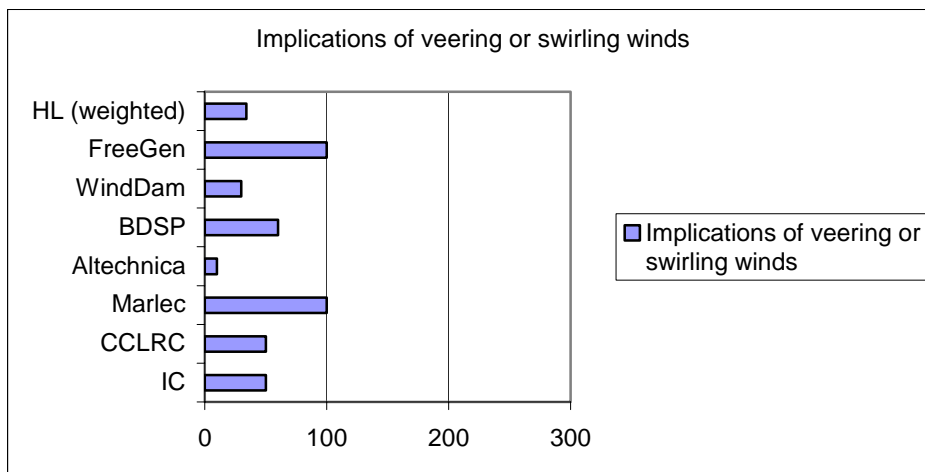
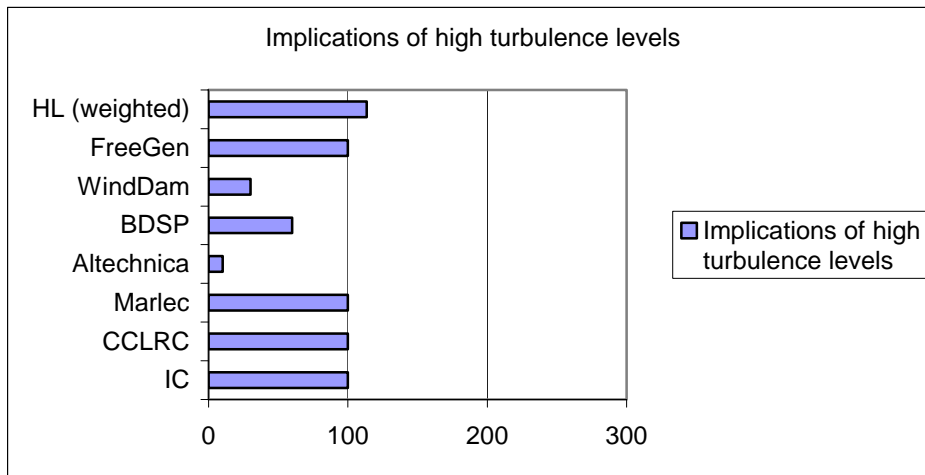

Noise and vibration issues:

- Noise Reduction - Broad band
- Noise Reduction - Low Frequency
- Low Frequency airborne vibration
- Structurally transmitted vibration
- Minimisation of vibration
- Determining prevailing ambient noise levels

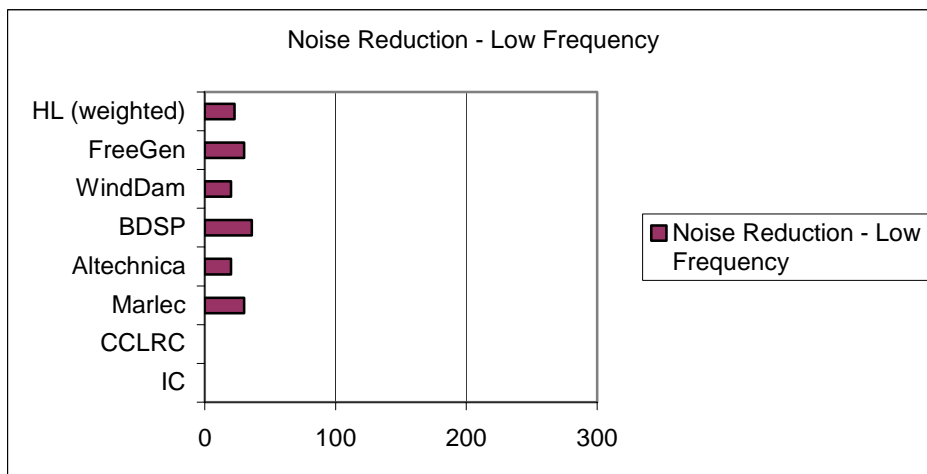
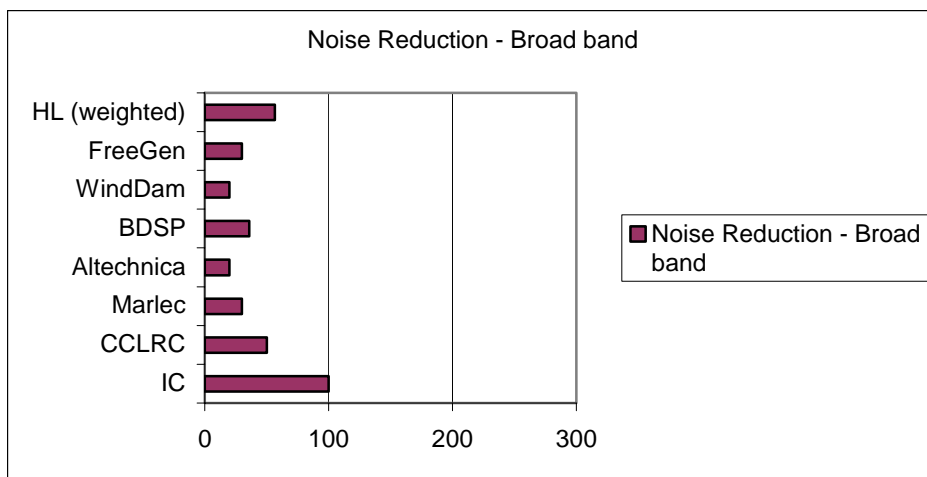

The Feasibility of Building Mounted/Integrated Wind Turbines (BUWTs)

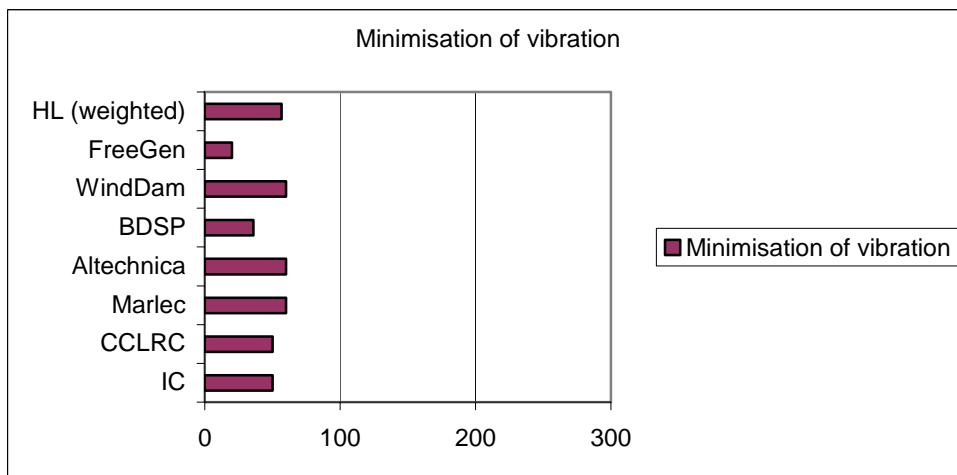
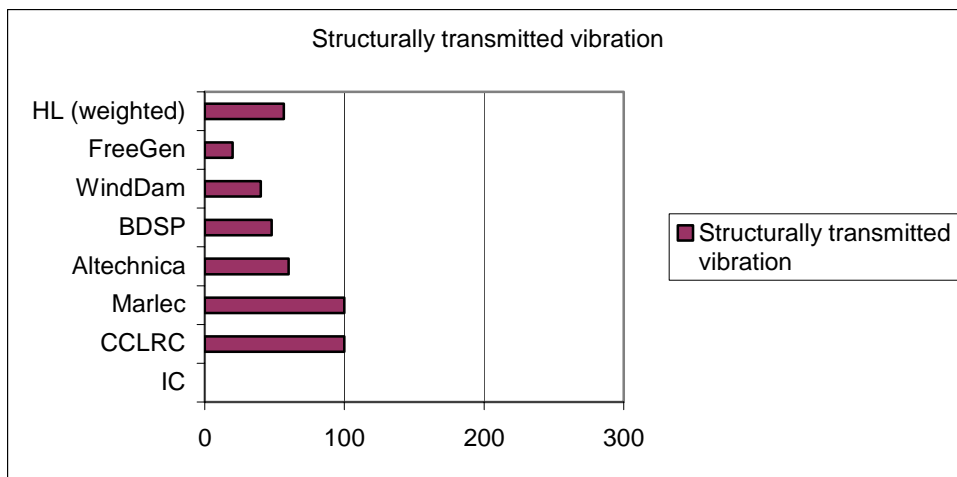
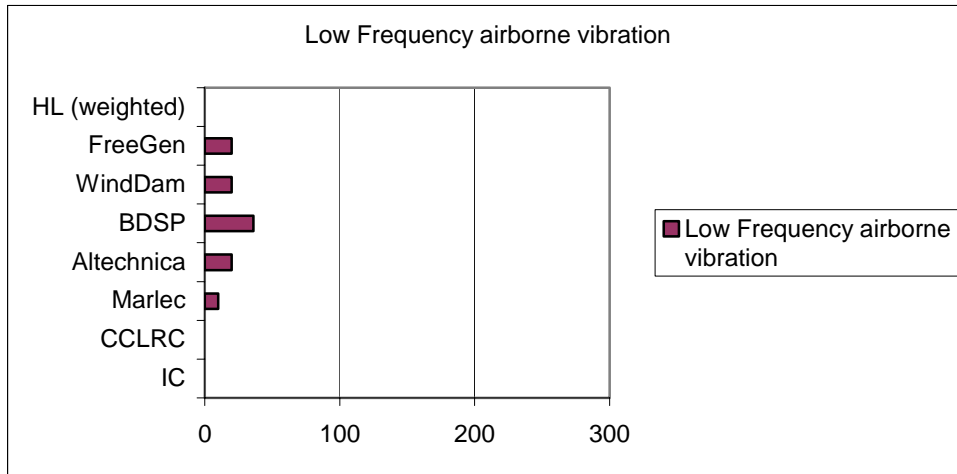

The Feasibility of Building Mounted/Integrated Wind Turbines (BUWTs)

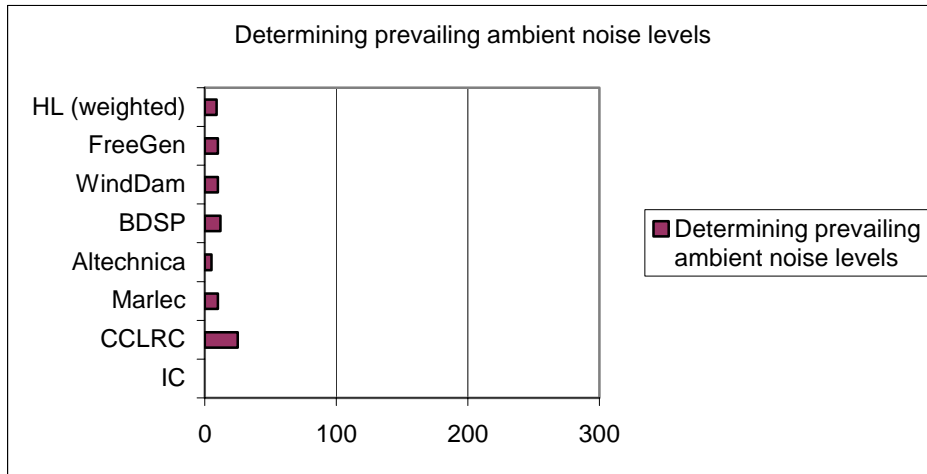

Building mounted/integrated wind turbine (BUWT) design:

- Ducting -need for, design of
- Blade design & construction
- Need for omni-directionality
- Need for augmentation
- Reduced performance
- Elimination of pitch alteration mechanism
- Safety containment of failed rotor

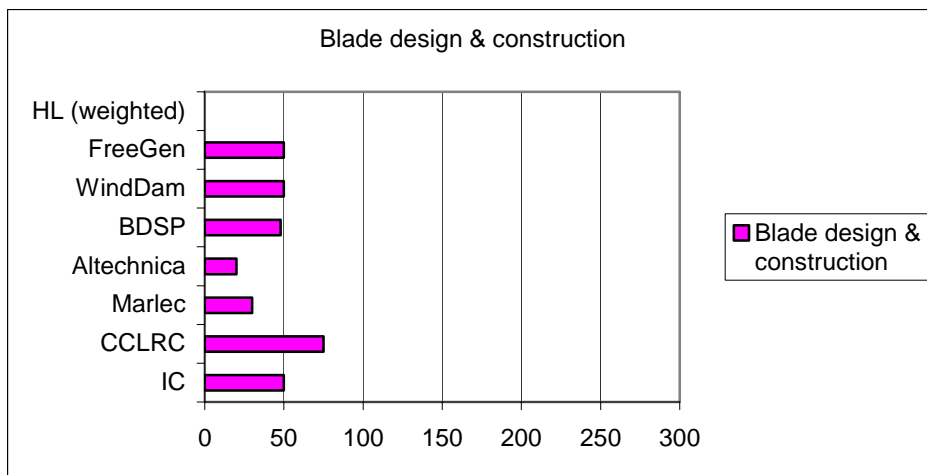
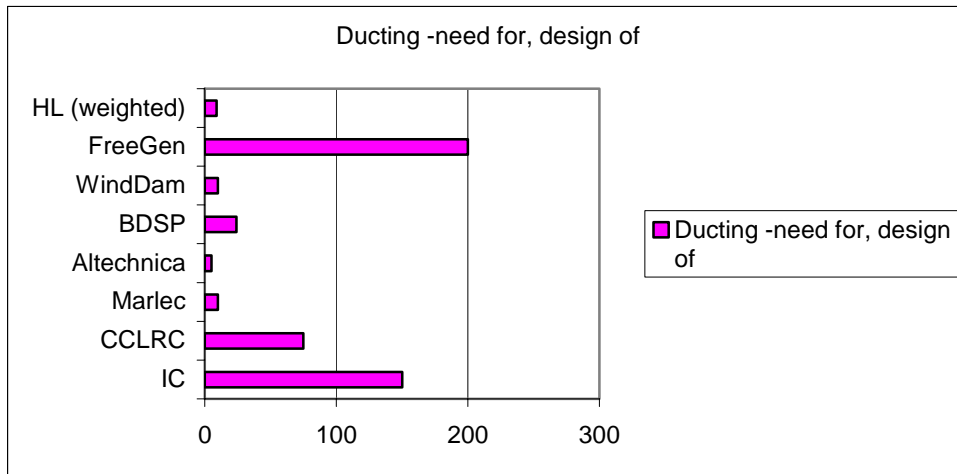

The Feasibility of Building Mounted/Integrated Wind Turbines (BUWTs)

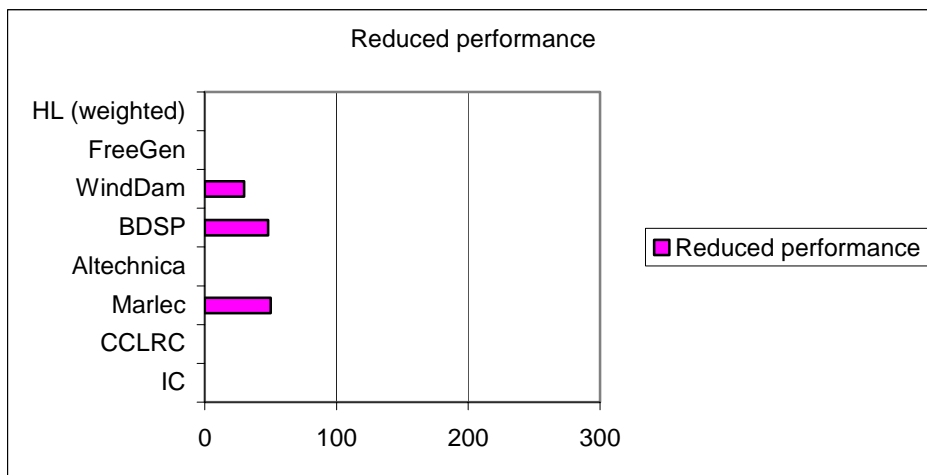
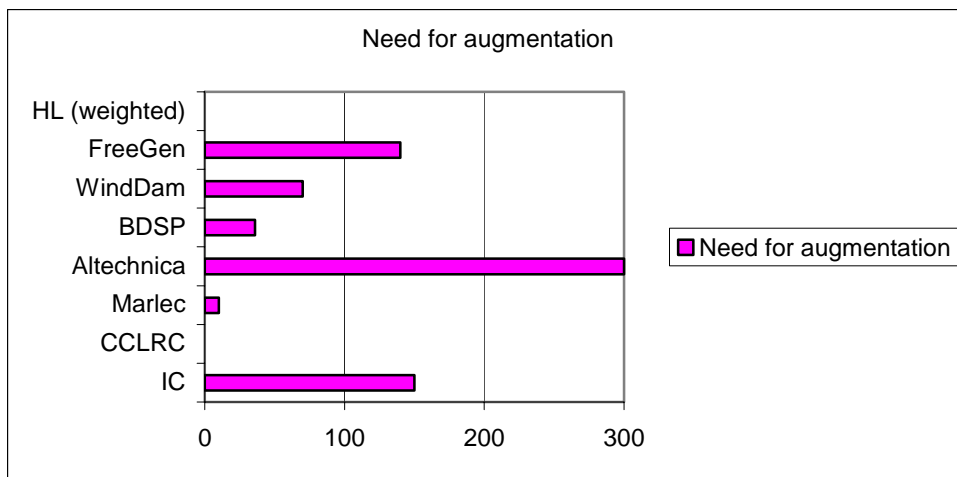
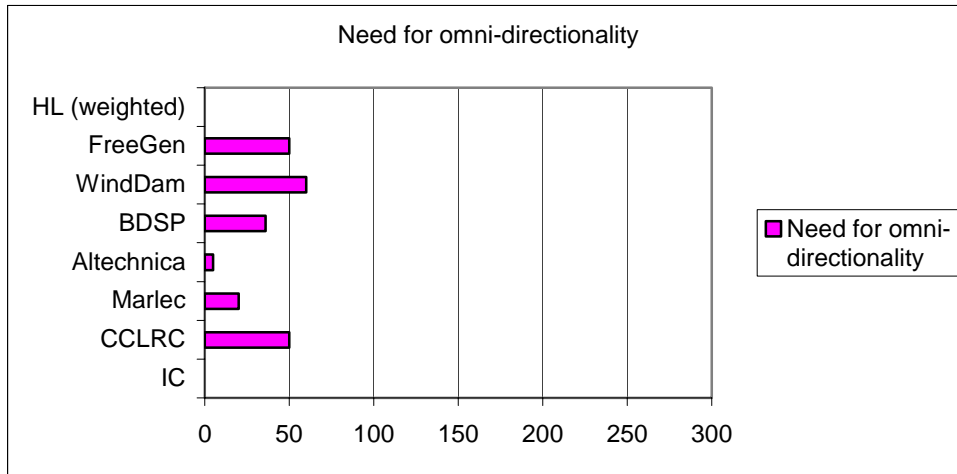

The Feasibility of Building Mounted/Integrated Wind Turbines (BUWTs)

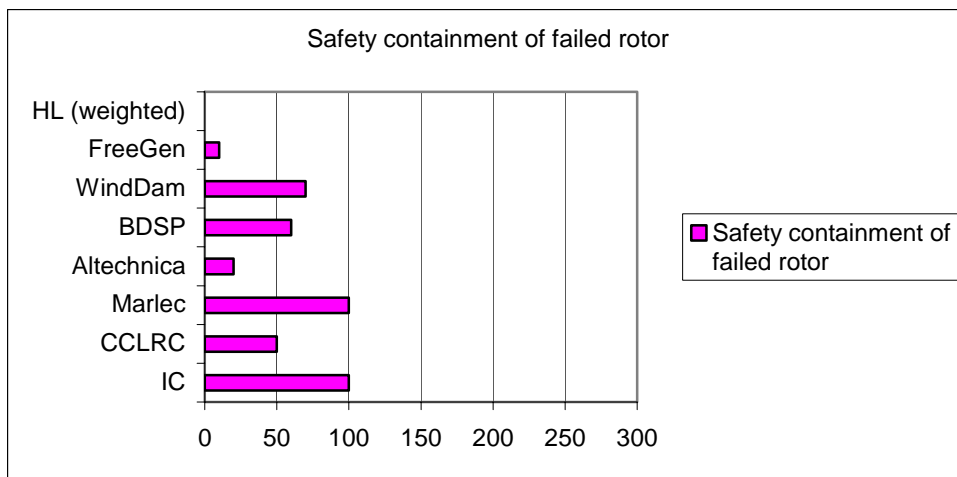
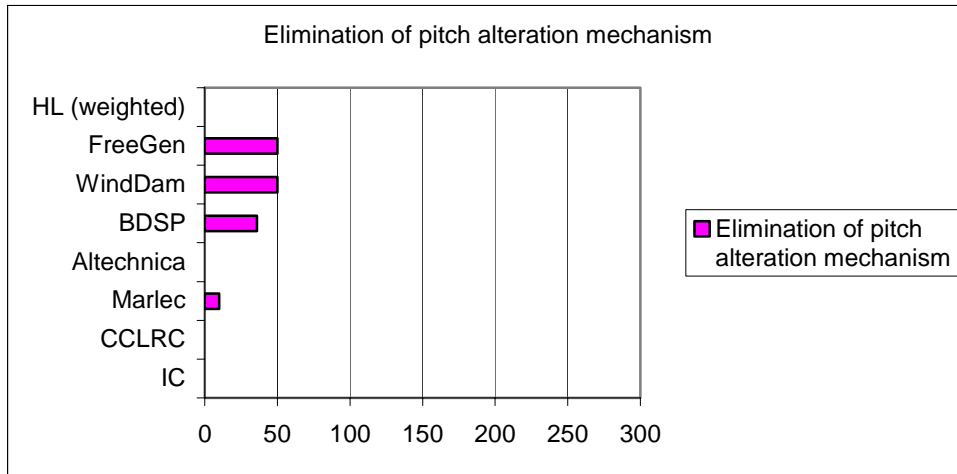

Installation issues:

- Location of BUWT on a building
- Mounting arrangements
- Electronics for automatic synchronisation to 13A
- Impact on design of new buildings

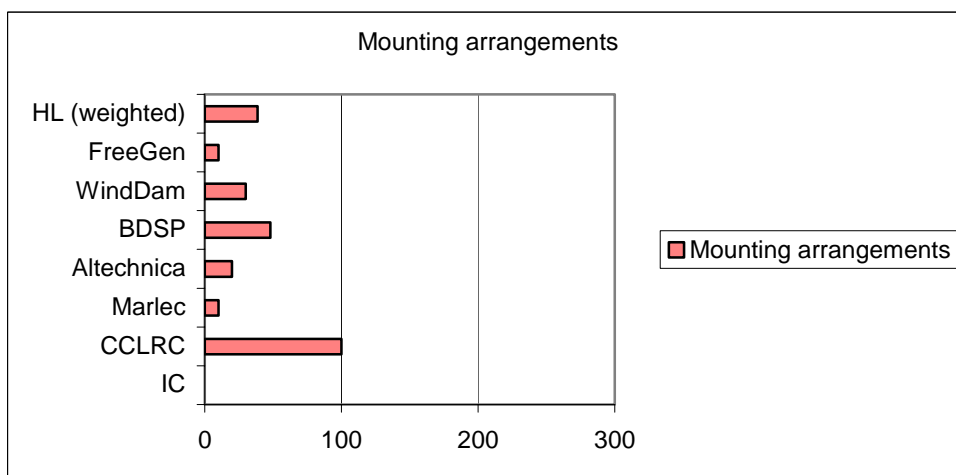

The Feasibility of Building Mounted/Integrated Wind Turbines (BUWTs)

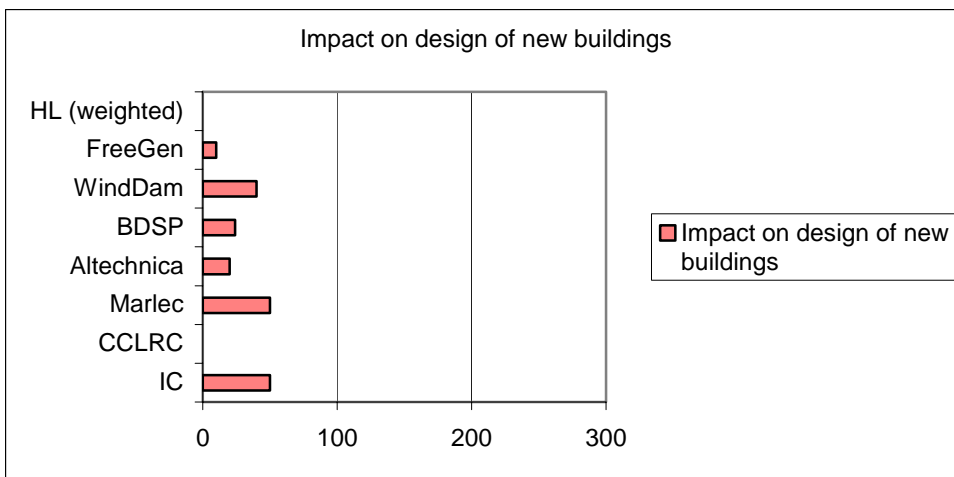
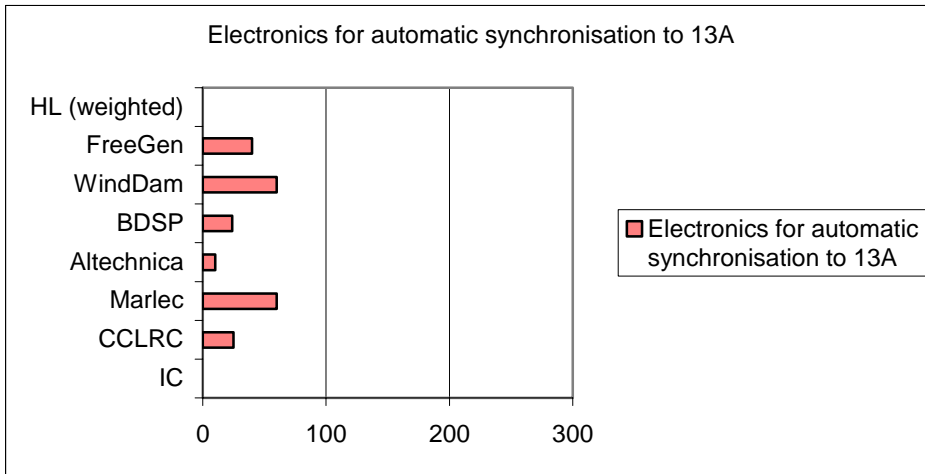

Overall systems, operation, and maintenance:

- Reducing capital costs
- Bat & bird strike
- Blown debris
- Maintenance considerations
- Reliability considerations
- Ease of access

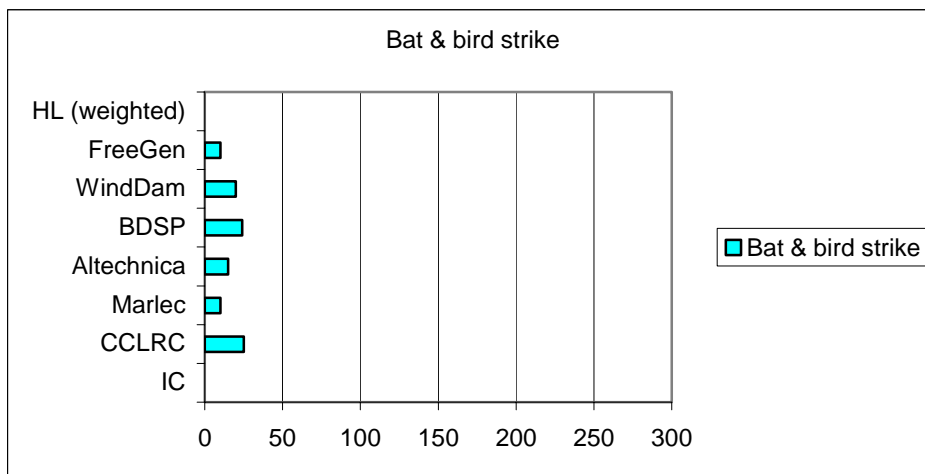
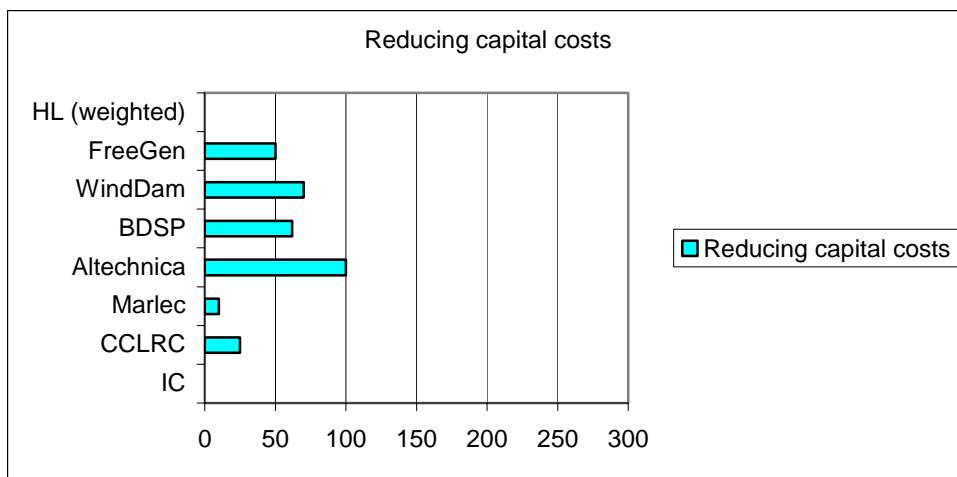

The Feasibility of Building Mounted/Integrated Wind Turbines (BUWTs)

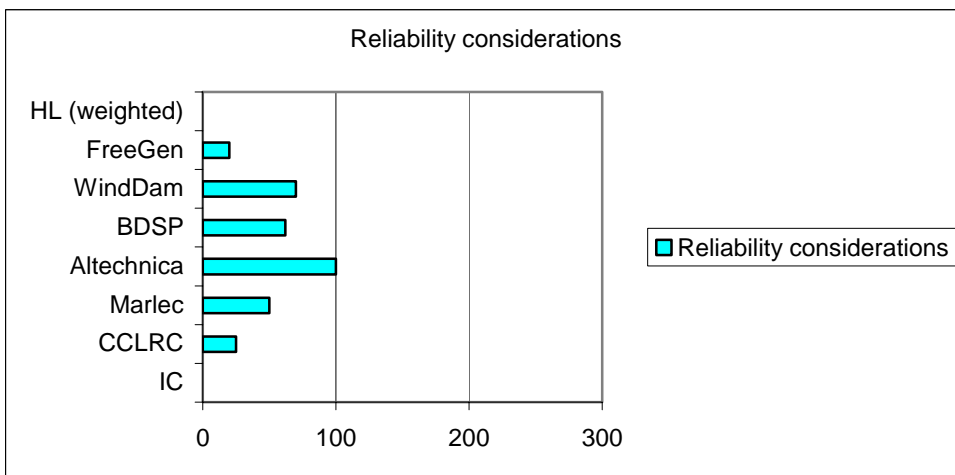
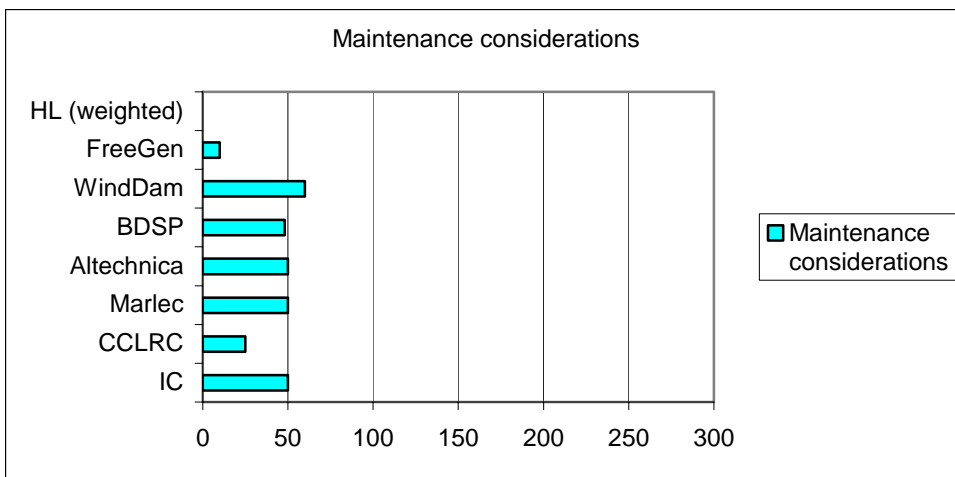
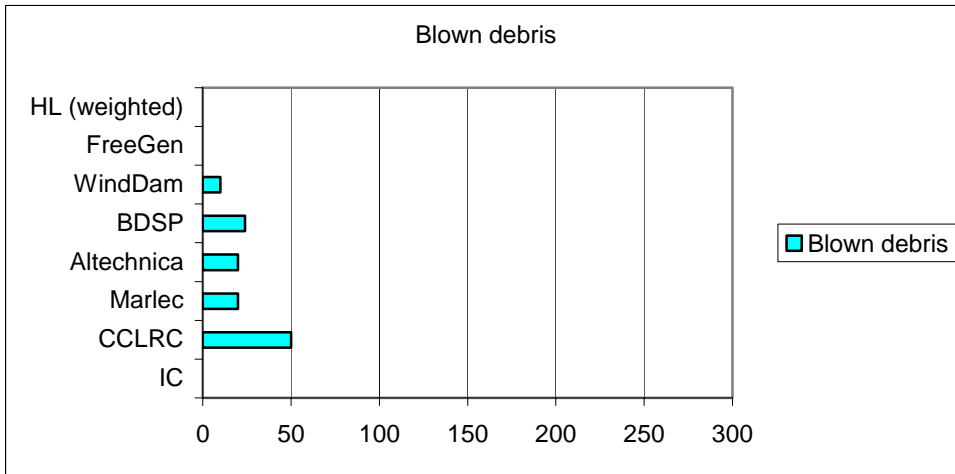

The Feasibility of Building Mounted/Integrated Wind Turbines (BUWTs)

