

Understanding Architecture Through Drawing

Second Edition

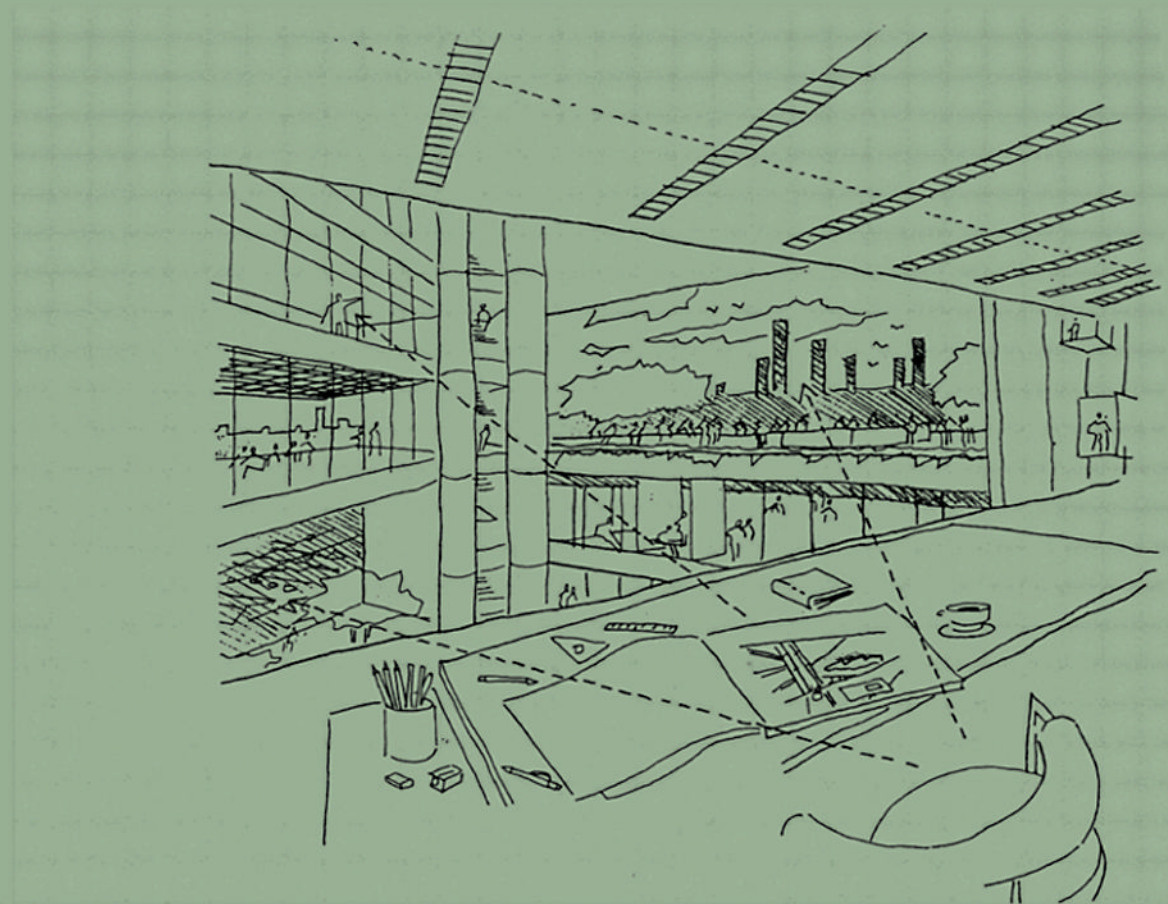

Brian Edwards

Understanding Architecture Through Drawing

Second Edition

This new edition is fully revised and updated and includes new chapters on sustainability, history and archaeology, designing through drawing and drawing in architectural practice. The book introduces design and graphic techniques aimed to help designers increase their understanding of buildings and places through drawing. For many, the camera has replaced the sketchbook, but here the author argues that freehand drawing as a means of analysing and understanding buildings develops visual sensitivity and awareness of design.

By combining design theory with practical lessons in drawing, *Understanding Architecture Through Drawing* encourages the use of the sketchbook as a creative and critical tool. The book is highly illustrated and is an essential manual on freehand drawing techniques for students of architecture, landscape architecture, town and country planning and urban design.

Brian Edwards is an architect, town planner, writer, teacher and artist. He has taught in various schools and has been Professor of Architecture at Huddersfield and Heriot Watt universities and the Edinburgh School of Art. He has written over 16 books, seven of which published by Spon Press/Taylor & Francis.

First published 2008 by Taylor & Francis
2 Park Square, Milton Park, Abingdon, Oxon, OX14 4RN

Simultaneously published in the USA and Canada by
Taylor & Francis
270 Madison Avenue, New York, NY10016

*Taylor & Francis is an imprint of the Taylor & Francis Group,
an informa business*

This edition published in the Taylor & Francis e-Library, 2008.

“ To purchase your own copy of this or any of Taylor & Francis or Routledge’ s
collection of thousands of eBooks please go to www.eBookstore.tandf.co.uk”

First edition © 1994 Brian Edwards

This second edition © 2008 Brian Edwards

Designed by Gavin Ambrose

Printed and bound in Great Britain by The Cromwell Press,
Trowbridge, Wiltshire

All rights reserved. No part of this book may be reprinted
or reproduced or utilised in any form or by any electronic,
mechanical, or other means, now known or hereafter
invented, including photocopying and recording, or in any
information storage or retrieval system, without permission
in writing from the publishers.

British Library Cataloguing in Publication Data

A catalogue record for this book is available from the
British Library

Library of Congress Cataloging- in-Publication Data

A catalog record for this book has been requested

ISBN 0-203-88243-1 Master e-book ISBN

ISBN10 0-415-44413-6 (hbk)

ISBN 10 0-415-44414-4 (pbk)

ISBN13 978-0-415-44413-2 (hbk)

ISBN13 978-0-415-44414-9 (pbk)

Understanding Architecture Through Drawing

Second Edition

Brian Edwards
Edinburgh School of Art



Taylor & Francis
Taylor & Francis Group

Contents

Acknowledgements	v	<i>Chapter 7</i> The importance of practice	60	<i>Chapter 19</i> History and archaeology	160
Introduction	vi	<i>Chapter 8</i> From sketch to plan making and documentary investigation	64	<i>Chapter 20</i> Interiors	170
<i>Chapter 1</i> The benefits of drawing	1	<i>Chapter 9</i> Sequential sketches	72	<i>Chapter 21</i> Using drawing to analyse an urban area	178
Part One <i>Guiding Principles</i>		<i>Chapter 10</i> Drawing and photography (with Susan Fahy)	80	<i>Case study 1</i> The Merchant City, Glasgow	178
<i>Chapter 2</i> Why draw?	16	Part Three <i>Case Studies in Drawing</i>		<i>Case study 2</i> The Bastide towns, France	187
<i>Chapter 3</i> Choosing the subject	30	<i>Chapter 11</i> Towns, townscapes and squares	90	<i>Case study 3</i> Japanese urbanism	192
Part Two <i>Techniques</i>		<i>Chapter 12</i> Streets, lanes and footpaths	100	Part Four <i>The Way Forward</i>	
<i>Chapter 4</i> Perspective	38	<i>Chapter 13</i> Landmarks, skyline and city image	108	<i>Chapter 22</i> Exploration through the sketchbook – some suitable subjects	198
<i>Chapter 5</i> Line and shade	46	<i>Chapter 14</i> Gateways, entrances and doorways	114	<i>Chapter 23</i> From sketch to design	214
<i>Chapter 6</i> Composition	50	<i>Chapter 15</i> The façades of buildings	122	<i>Chapter 24</i> Designing through drawing	226
		<i>Chapter 16</i> Machinery, function and modernism	132	<i>Chapter 25</i> Drawing in architectural practice	238
		<i>Chapter 17</i> Landscape	142	Bibliography	260
		<i>Chapter 18</i> Sustainability	152	Index	262

Acknowledgements

The author wishes first to thank those bodies that awarded research grants to undertake the work outlined in this book, namely the Arts and Humanities Research Council and Edinburgh College of Art. In addition, the book has drawn upon material from the Sir Basil Spence Research Project funded by the Heritage Lottery Fund. Various chapters use material abridged from the author's article 'The use of drawing in architectural design: some recent experiences from UK practice' published in *Architecture Research Quarterly (ARQ)* in 2005.

The author is also indebted to a number of architects and designers who have provided time for interviews and given consent for the use of drawings in the book. These include Lord Foster of Riverside, Sir Terry Farrell, Sir Nicholas Grimshaw, Edward Cullinan, Bob Allies, Will Alsop, Richard Murphy, Allan Murray, Gordon Murray and Malcolm Fraser. In addition, the following architects have kindly provided drawings to augment those of the author, namely Santiago Calatrava, David Prichard, Francis Tibbalds, Derek Fraser, Richard Reid and Arup Associates. The author is particularly indebted to Nick Hirst for allowing drawings prepared as a result of his Philip Webb Travelling Scholarship to be used in the publication.

The author also wishes to thank the RIBA Library, RCAHMS and the Hunterian Museum for making

available images of sketchbook practice from earlier periods.

Finally, the author wishes to thank the many students of architecture from Edinburgh, Glasgow and Huddersfield who kept him company with their sketchbooks on study visits to places far and wide over a twenty-five year period.

Unless stated otherwise all subsequent drawings are by the author.

Introduction

The aim of this book is to explore how freehand drawing can increase the level of understanding of the complexities of modern architecture. In particular it seeks to provide the means whereby there can be a marriage of art and architecture by establishing shared values and understandings. The sketchbook is a useful tool to help counter the dominance of science in architectural education, or at least to ensure that technology is employed with judgement and aesthetic discrimination. The aim is to encourage the creation of a more humane environment by developing visual and artistic sensibilities through the practice of drawing.

A number of themes are presented, each as a case study of issues facing students or practising architects. Since the first edition of this book was published in 1994, fresh concerns have emerged and these form the basis of much of the new material presented in this edition. There is also greater discussion of the role of sketching vis-à-vis other design development tools such as model-making, computer-aided design (CAD) and photography. As a result there are a number of more theoretical chapters than in the first edition, as well as interviews with a number of the UK's leading architects such as Lord Foster, Sir Nicholas Grimshaw, Will Alsop and Edward Cullinan.

The central aim of the book is to encourage the use of the sketchbook as a vehicle for learning about architecture. There is currently a revival of interest in the pedagogic role of drawing, particularly its place in the generation of architectural forms. This book looks forward to design practice by examining past examples using freehand drawing as the main analytical tool. The book is arranged thematically into four parts: the first part presents guiding principles, the second introduces the student to the main graphic tools and drawing techniques used by the architect; the third part explains how common design issues can be better understood through drawing with a number of case studies of sketching practice; the final part focuses upon examples from contemporary architectural practice with the emphasis upon current trends in drawing technique.

A characteristic of the book is the division of study material into themes. The aim of sketching is not to undertake drawings of subjects that randomly catch the eye but to explore architecture in a more systematic fashion. The comparative analysis of material through sketching entails a more rigorous questioning than is possible by many other means. Once sketched, the subject under investigation can be explored further –

perhaps by resort to archival sources or textbooks on construction. Thematic exploration through drawing aids learning about the built environment – it helps you to see, to think and to design.

The book presents a general overview of drawing practice in the twenty-first century and the principles that underpin it. The benefits of designing through drawing are discussed, particularly the way sketching allows options to be explored conceptually and in detail – this interaction across the scales is an important characteristic of drawing. Inevitably in the digital age, there is a great deal of interplay between freehand drawing and CAD, especially at the genesis of a project. Different architects use drawing in different ways but for many, if not most, architects freehand drawing is the first tool or medium used in designing a building.

The professional bodies which underpin standards in architectural education in the UK, namely the Architects Registration Board (ARB) and the Royal Institute of British Architects (RIBA), recognise the importance of the facility to draw to that of becoming an architect. Under the criteria for the prescription of architectural courses the term ‘communication’ is employed. It is used in the context of evolving and representing architectural design proposals, and embraces freehand drawing as well as CAD. Sketching remains an important aspect of being an architect, even in an age where information technology (IT) has to an increasing degree displaced traditional notions of architectural representation. Sketching remains important to designing and, equally, to understanding the physical, environmental and cultural context for architectural practice today.

In presenting new material in this edition, the author hopes to encourage greater use of the sketchbook and freehand drawing within architecture and design schools. The potential of investigating, learning and practising design through drawing is considerable. However, it is

easy for students to overlook drawing when other more fashionable or accessible tools, such as CAD and photographic digitisation, are presented during the courses of study at undergraduate level. As this book argues, the power of drawing to get beneath the surface encourages those who use the sketchbook to confront the deeper forces at work in shaping contemporary architecture. Architects were once noted for their ability to visualise through drawing and this set them apart from engineers or technicians. In writing this book the author seeks to revive the tradition of drawing – not as mere draughtsmanship or documentation, but as a powerful tool in generating the built forms of the twenty-first century.

THERE IS NO
'LANGHAM
PLACE' - NASH
HAD A GARDEN
HERE -
COMPARE
THE
AGRESSION
OF THIS
CORNER
WITH
THE
'INVITATION'
OF
ALL SOULS!



NOTE HOW THE LEVEL
CHANGE LIFTS YOU
ABOVE THE TRAFFIC
'VISUALLY BUT ALSO
SMALLS - A BETTER
PROSPECT THAN
PAVEMENT LEVEL.

NF

NOTE HOW THE
PERISTYLE IS
INVITING - A PUBLIC
SPACE - A SYMPHETIC
GESTURE - PEOPLE SIT
ON THE STEPS EVEN
IN THE COLDEST
WEATHER!

Chapter 1

The benefits of drawing

The act of drawing is an important starting point for the intellectual process we call 'design'. To be able to draw a chair or a building is a prerequisite for anyone wishing to design such things. Drawing has two functions for the designer – it allows him or her to record and to analyse existing examples, and the sketch provides the medium with which to test the appearance of some imagined object.

Before the advent of photography most architects kept a sketchbook in which they recorded the details of buildings, which they could refer to when designing. The fruits of the Grand Tour or more local wanderings consisted of drawn material supported, perhaps, by written information or surveyed dimensions.

The sketchbook provided a form of research and a library of plans and details to crib at a later stage. Because the architect is not necessarily aiming only at documentary representation, the sketches were often searching and analytical. Many of the drawings prepared found their way into later designs. The English architect C.R. Cockerell used pocket-sized sketchbooks and filled them with drawings not only of sites in Italy and Greece, but also of cities in Britain. His sketchbooks, which survive at the Royal Institute of British Architects (RIBA), show that a direct link existed between Cockerell's field

studies and his commissions as an architect. Later architects such as Alvar Aalto, Le Corbusier and Louis Kahn employed the sketchbook in a similar fashion, though to different ends. Lord Foster (opposite) continues with this tradition.

Drawings have been used by architects in many different ways. Ranging between the opposite poles of the freehand drawing as a record and as a design tool exist many different applications for the designer. Some architects use the sketch as the main means of communicating a design idea to clients. Such sketches relay the thinking behind a proposal as well as suggesting a tangible form. Other architects use the sketch to analyse townscape and to indicate how their design will fit into the street. Others use the sketch as a method of studying building typology, using the analysis as a way of placing their design into known precedents. However the sketch is employed, the main point is to use the freehand drawing as a design tool, as a method of giving form and expression to one's thoughts. One may finish the design process with a formal perspective, but that end product should not be where sketching begins. Design analysis through the freehand drawing should be at the start of the creative process, not at the end, and preferably before the design commission arrives in the first place. The

1.1

This sketch (dated 1862) by Richard Norman Shaw of Bidborough in Kent shows his interest in vernacular buildings. It is no surprise to find Shaw designing new buildings in similar spirit at the time. (RIBA Drawings Collection)

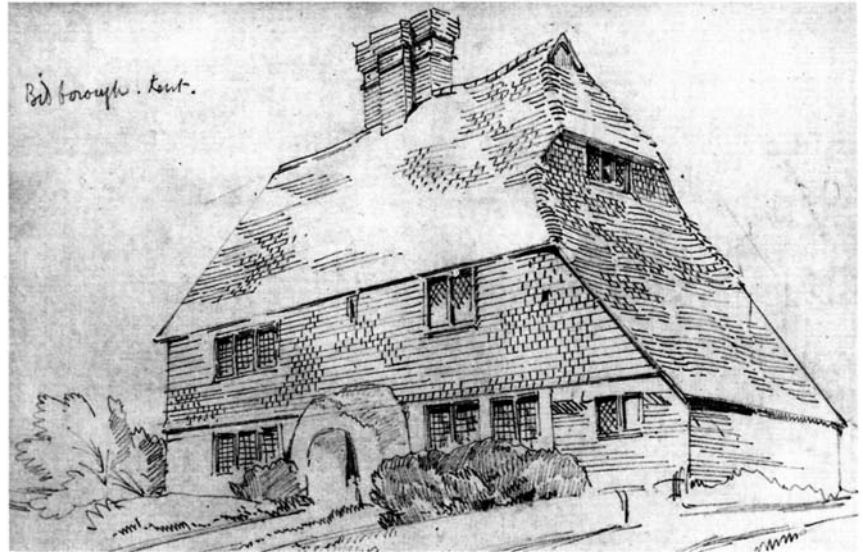

1.2

This drawing of a new circular tenement built in Glasgow in 1990 highlights the pattern of windows and shows how the stairways have been used to articulate the design. The sketch seeks to explain the basic geometry of the circular tenement. By eliminating all detail the proportions have become clearer, and what is not evident in the sketch has been highlighted in the notes.

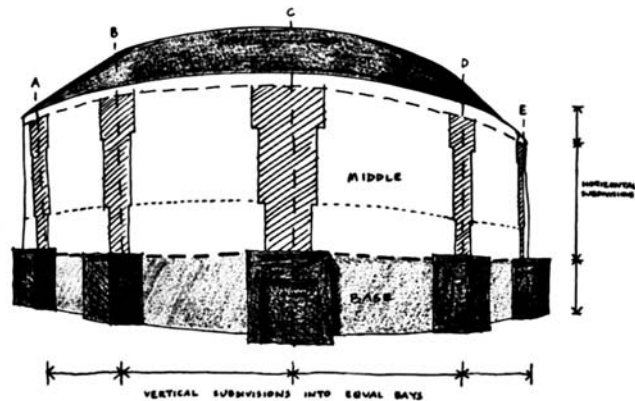

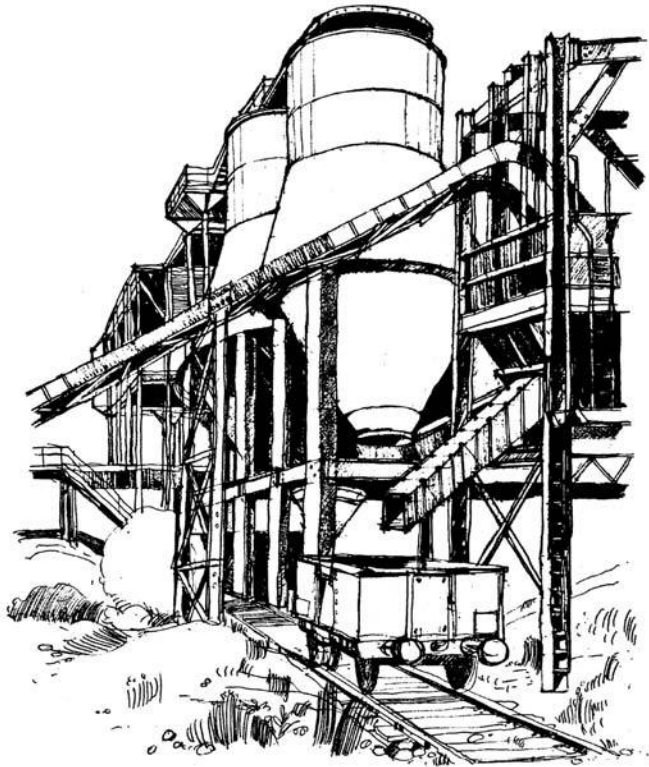

1.3

The sculptural massing is evident in this disused colliery at Chislet in Kent.

sketchbook is a personal library; it needs to be built up so that it can become a basis for later, undreamt of, designs.

Many architects' drawings leave out a great deal of detail. Whether a sketch is of a design proposal or an existing reality, the element of removal or abstraction is one of the characteristics of such drawings. It is better to capture the essence rather than seek an exhaustive realism. Designers need to know what to leave suggested rather than explicitly recorded. The principles and truth that such drawings seek to communicate can be hidden by too much detail or graphic bombardment. A good drawing is one that leaves room for imaginative interpretation. These principles apply equally to a page in the sketchbook or a drawing prepared to highlight a design proposal.

Sketching and freehand drawing have for too long been seen as the point of entry into painting, as against the essential starting point for design. Art colleges have, of course, always maintained a sketchbook tradition among artists and designers alike, but in sixth-form colleges, and even schools of architecture, the sketchbook has been usurped by the computer simulation or verbal description.

What this book seeks to revive is the sketch and analytical drawing as means of understanding form and construction. Only through the study of existing examples – not laboriously drawn but critically examined – can we cultivate a nation of people sensitive to design and its application to our everyday environment. This willingness to learn from past examples should apply across the

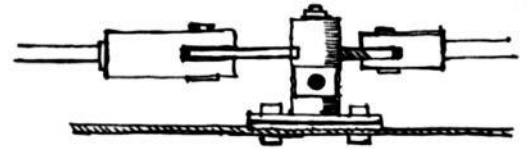
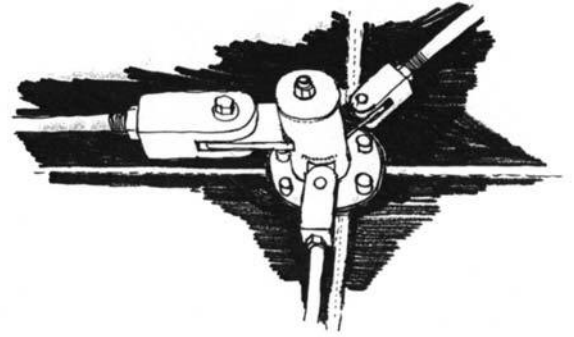
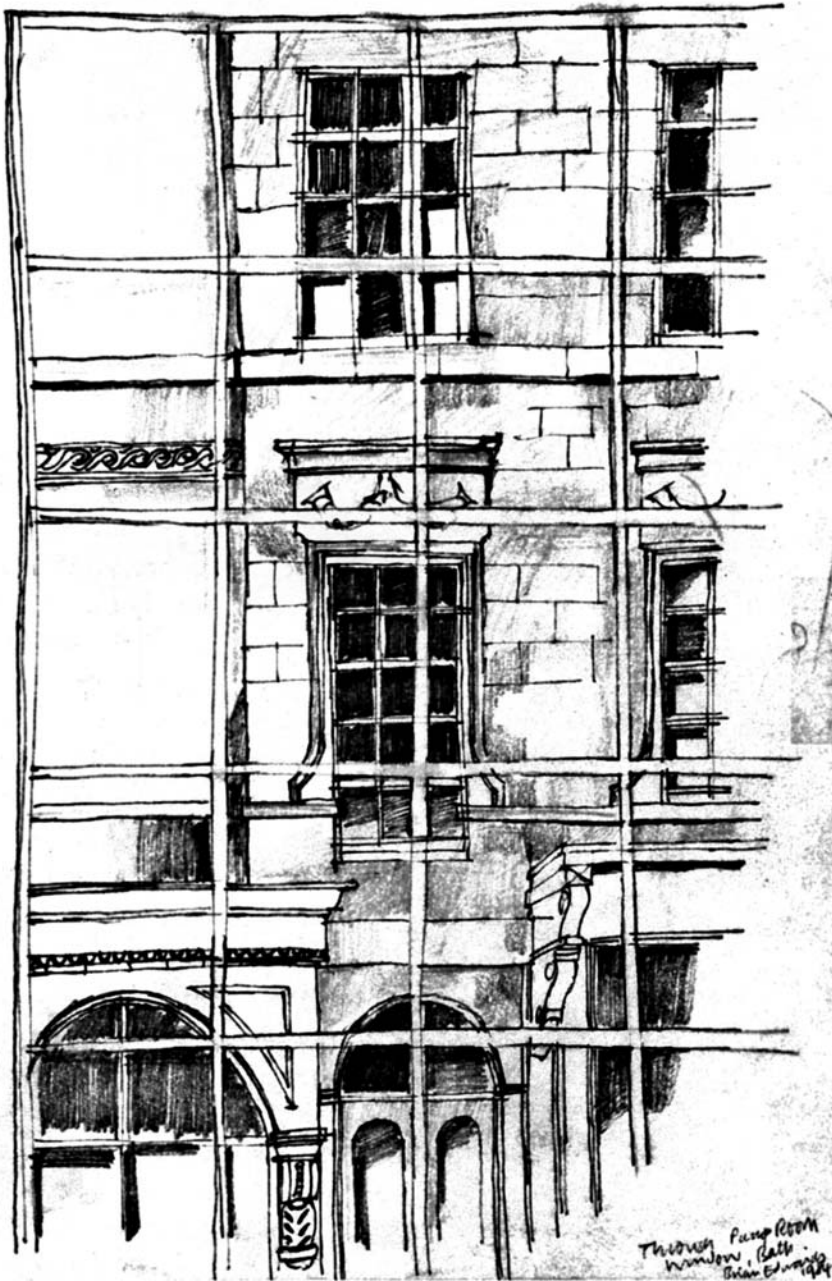

1.4 (above)

Glazing details are not always as expressive as here at the Financial Times printing works (designed by Nicholas Grimshaw and Partners) in East London. Notice how the sketch is supplemented by a freehand section.

1.5 (left)

The windows of the Pump Room in Bath make an attractive pattern from both the inside and outside. As with much Georgian architecture, elements such as shop fronts and sash windows are framed with margins and mouldings.

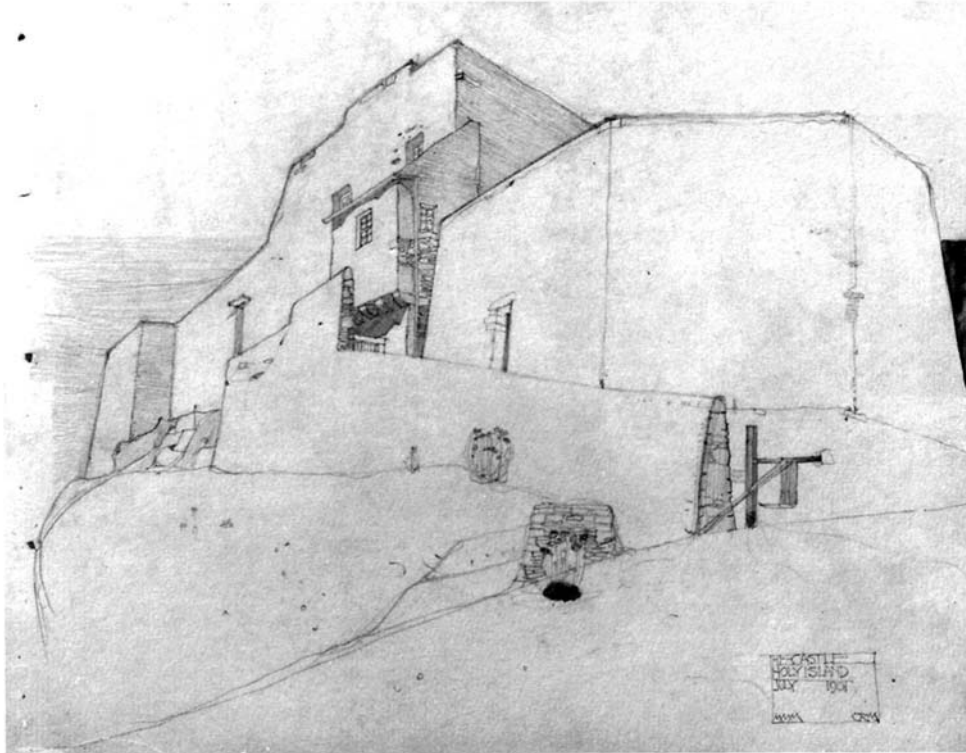

1.6

Charles Rennie Mackintosh possessed a unique vision which embraced not only his freehand drawings and watercolours, but also his designs as an architect. This sketch (dated 1901) by him of the castle at Holy Island in Northumberland is similar in spirit to his more adventurous designs, especially in the three-dimensional treatment of gables. (Glasgow University: Mackintosh Collection)

board, from an appreciation of townscapes to the design of children's furniture.

Questions of scale are hardly relevant – we live in a designed environment, whether we as consumers are aware of it or not. Every lamp standard and traffic sign has been 'designed', the layout of motorway junctions has been shaped by an engineer with an eye to beauty as well as safety. On a smaller scale, our cutlery and crockery are designed, as are the disposable wrappings at the fast-food restaurant.

The sketchbook allows us to be aware of this reality as long as students are encouraged to explore through drawing. The welcome changes to the national curriculum to enhance the status of design and craft teaching, and the broadening of appeal of courses in architecture,

landscape design and town planning, have created an unprecedented interest in the environment and design. To turn this interest into a better-designed world requires the development of graphic and visual skills.

In a sense we are all designers, even if we do not make our living through the medium of design. As designers we modify our immediate environment through changing the decor of our houses, or designing our own clothes, to choosing consumer objects on the basis of how they look as well as how they work. We are sold products and services partly by design – you have only to watch television advertising to realise that our aesthetic sensibilities are being appealed to even when the product being promoted is as unglamorous as double glazing.

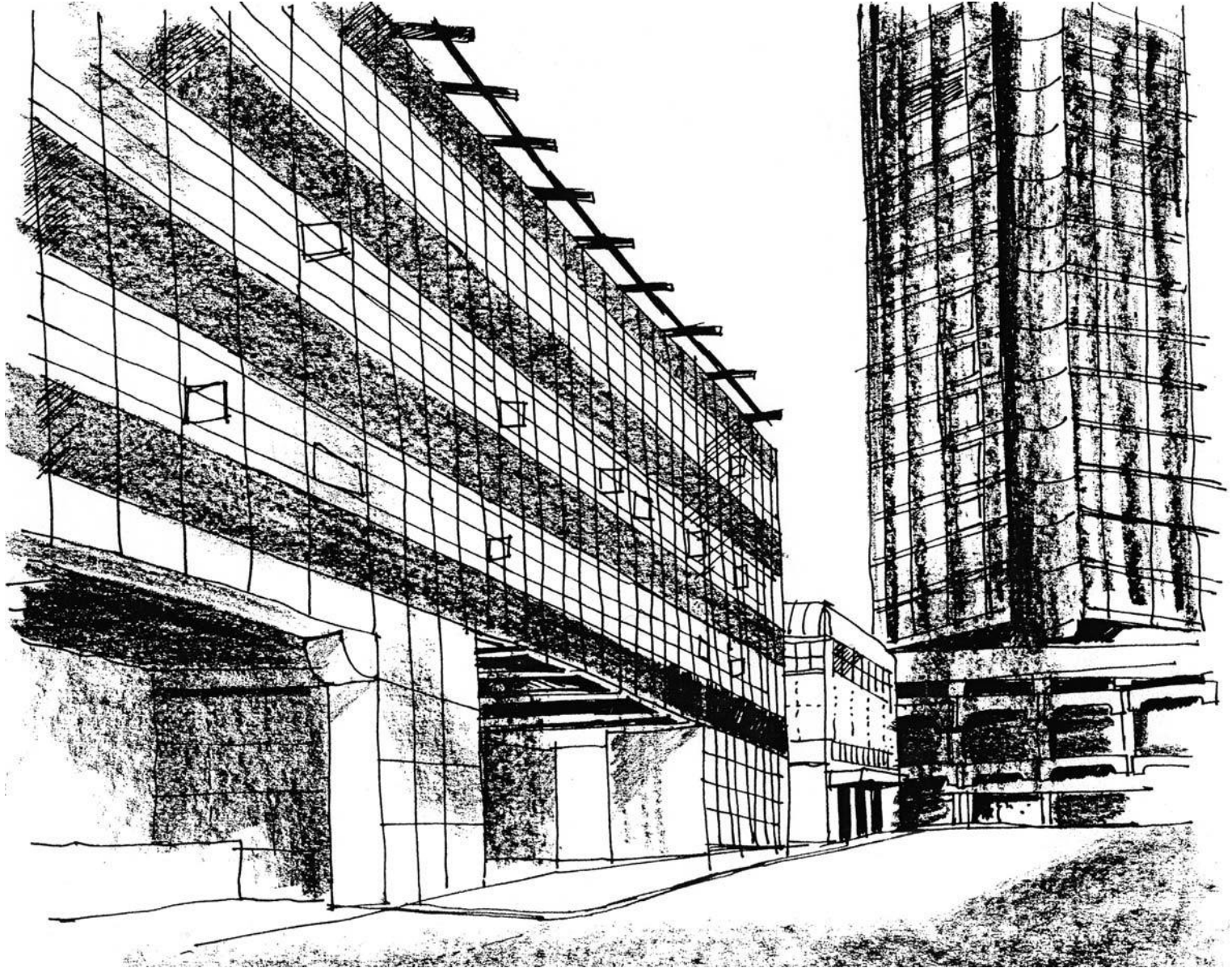

1.7 (opposite)

The Daily Express Building, Glasgow, built in 1936, expresses the material sleekness of International Modernism.

1.8 (right)

This sketch by the architect Richard Reid sets his design proposals for Gravesend in Kent into the streetscape. This type of exploratory sketch is part of the process most architects employ to test the appearance of their ideas.

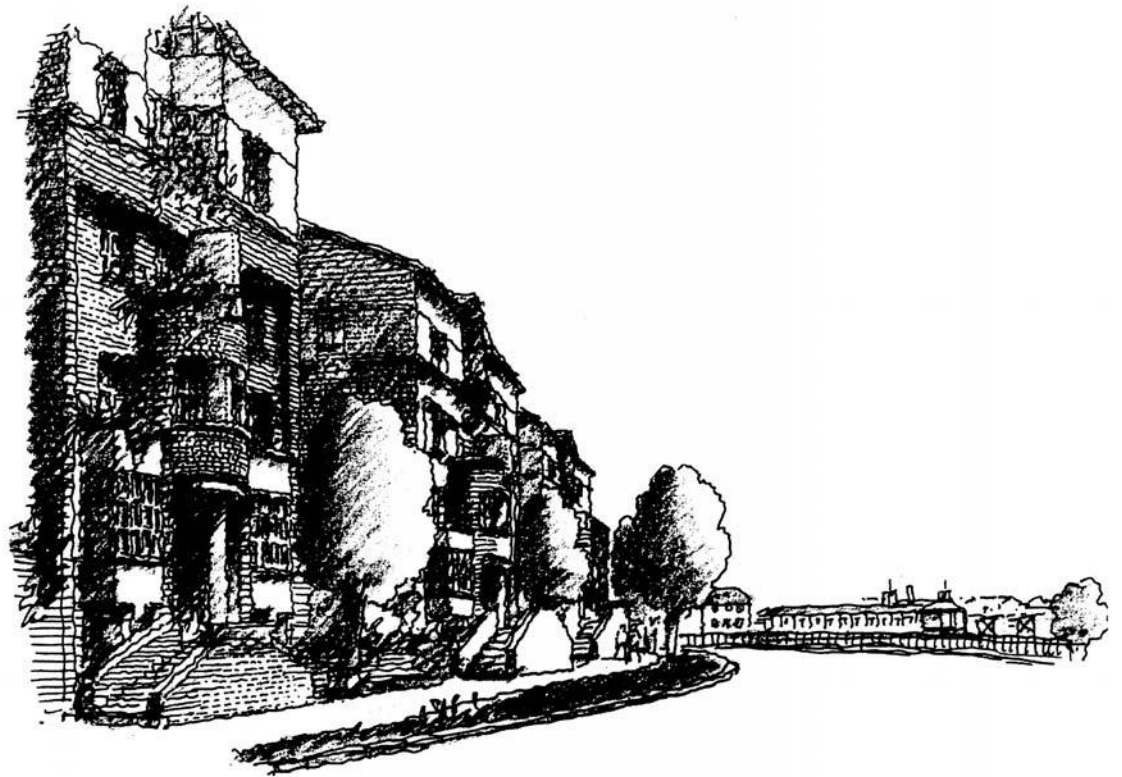

Prince Charles has awakened the national consciousness over questions of urban quality and architectural design. He uses the sketchbook as a means of describing and understanding the places he likes. The sketch is employed as a learning tool rather than as mere description.

The untrained eye can learn a great deal through drawing. It teaches an important visual discipline – an awareness of shape, line and perspective. The sketch also engenders respect for the environment and the designed objects within it. To have sat for an hour and drawn an old panelled door is to create a respect for the object that may discourage the tendency to daub it with graffiti, or to relegate it to firewood. Such doors could be recycled if their qualities or beauty were respected, and

1.9

At the level of house design, sketches by the architect Sir Basil Spence explore options for the general arrangement of the plan. Spence relates the plan to how the house will look from afar. The design is for Gribloch near Glasgow, built in 1938. (NMRS: Spence Collection)

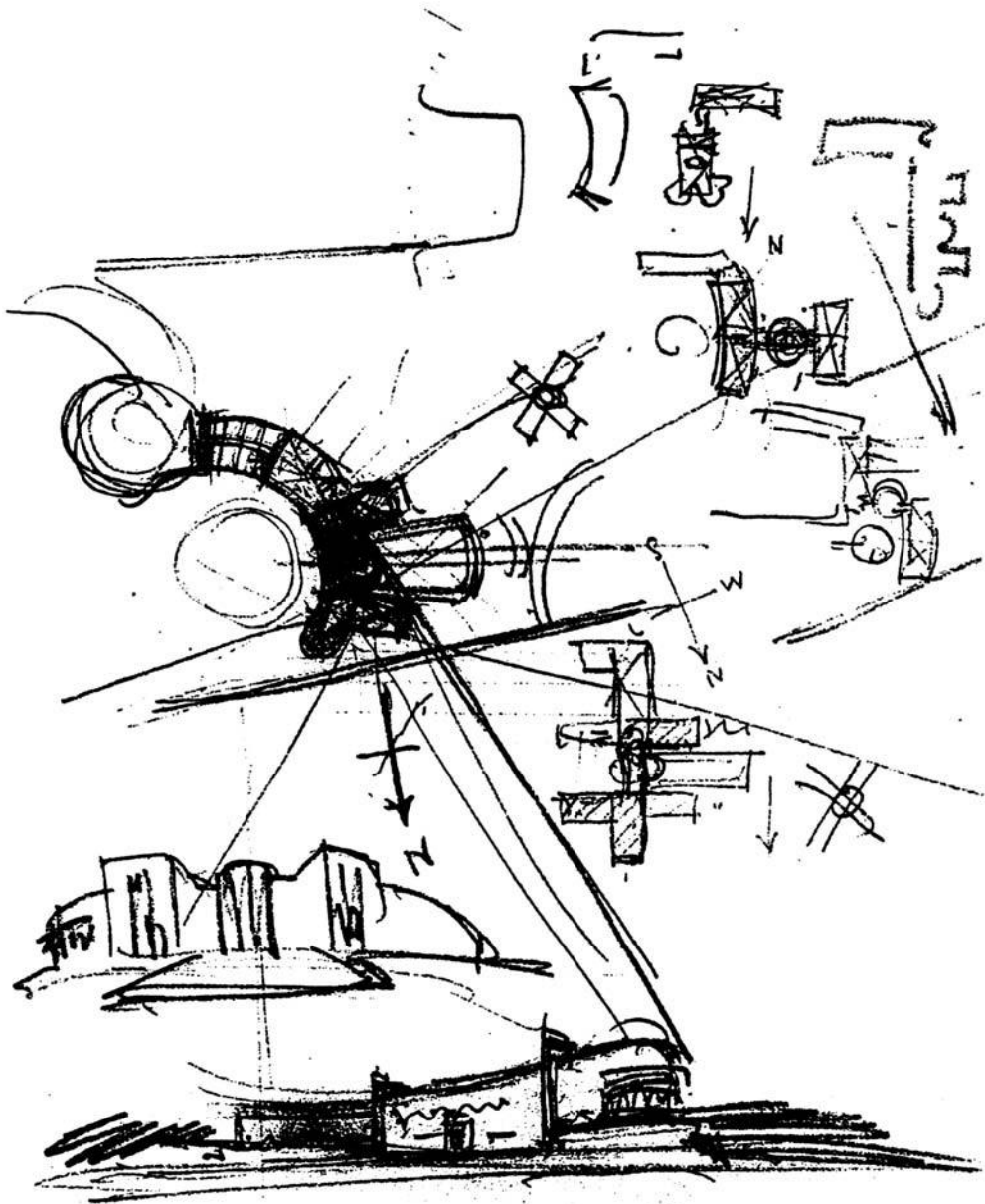

the sketch rather than the instantly obtained photograph is the means to this awareness.

It is said that in our modern world we now produce more photographs than bricks. For the first time in history the visual image has become more prevalent than the means of making houses. The lesson concerns the importance of design and appearance in contemporary society. But photographs are not always the most appropriate medium for expressing this visual concern. There are times, and subjects, which lend themselves to graphic analysis, rather than pictorial description. This book has the aim of reviving the sketchbook tradition, in order to create a visually literate society. The objective of education is to achieve not just literacy and numeracy, but graphic, visual and spatial skills. Our success as an industrial society requires this; and so do we, whether as designers or as individuals.

If this book encourages people – professional designers or otherwise – to explore the environment round about them with sketchbook and pencil (as against camera) in hand, then a useful beginning would have been made. There are always subjects to learn from, whether we choose to live in city, suburb or countryside. This book takes themes based upon everyday experience, and seeks to draw design lessons from them. Once we have learnt the language of drawing and graphic analysis, we are then in a position to engage in the complex business of design. For the first time in history design involves us all and has permeated through to every aspect of our lives. If we ignore the language of design, we will be as disadvantaged as those who finish school without the basic skills of literacy and numeracy. No single book can teach us how to learn through drawing, but it can point us in the right direction and open our eyes to the benefit of good design.

TYPES OF DRAWING

To the architect and urban designer there are three main types of freehand drawing. The first is the elaborate perspective drawing used to communicate design ideas to clients or planning authorities. Increasingly this type of drawing is produced by computer. The second type concerns the production of sketch perspectives and views used to communicate design ideas to specialists such as engineers, and sometimes to help clarify points for the designer's own benefit. This type of drawing can be split into:

- the investigation of an early design;
- exploring methods of construction;
- testing the visual effect of details;
- setting the design in its physical context.

The third type of freehand drawing concerns the exploration of the existing world, its buildings, details and landscapes. The use of drawing in this regard does not just provide a repertoire of forms and designs to use in developing new structures, but helps cultivate a sensitivity towards the existing context in which architects, planners and landscape architects are increasingly required to work.

Of these three broad categories of drawing, this book focuses upon the latter. With a growing awareness of the cultural and aesthetic values of cities, and with the European Community requiring ever-higher standards of urban design, those in the environmental professions face new challenges.

The general public, too, are better informed and through local amenity societies and bodies like the National Trust make their views known on an unprecedented scale. The widening of education to embrace design and technology (under the national curriculum reforms of 1990) promises to focus yet more

attention upon design in public fields such as architecture. Hence the world of the professions has been opened to challenge by an informed public, with design no longer the monopoly of people with letters after their names.

Before the modern design professions were established, students and practitioners employed the sketchbook as a matter of course. They were not topographical artists but people in search of creative material. The Arts and Crafts architect George Devey studied under John Sell Cotman in Norwich in the 1830s, thereby absorbing not just Cotman's approach to freehand drawing, but a whole collection of details of windmills, barns, country houses, castles and cottages which later proved invaluable to Devey the architect. Similarly, Richard Norman Shaw, Ernest George, John Keppie and, later, Edwin Lutyens continued to use the sketchbook to record the towns and buildings not just of Britain, but of Europe and the Middle East. One can trace the origins of the architectural sketchbook back to the Renaissance, but its blossoming as a creative force in its own right owes much to the nineteenth century.

The sketchbook is a personal record – a dialogue between artist and subject. The nature of the dialogue determines the quality or use of the finished drawing. By engaging in the subject, the artist, architect or student develops a sensitivity and understanding difficult to obtain by other means. The blind copying of subject is not necessarily useful – a critical stance is required. One may never use the sketch produced of the town or landscape – at least not directly – but, like reading a good book, the insights gained may prove invaluable later on.

The designer needs to be accomplished in the three main areas of drawing mentioned earlier. To be able to render a convincing perspective is an essential skill; to explore the detailing of an unbuilt structure through sketches avoids pitfalls in the final design; and to use freehand drawing to learn from past examples helps the

architect or urban designer to give better shape to townscapes of the future. The environmental awareness that is a feature of our post-industrial society has encouraged a return to questions of firmness, commodity and delight. These are the qualities the Arts and Crafts architects sought to discover through their sketchbook investigations. This book seeks to pick up the threads of a drawing tradition, and to use them to teach us lessons about the contemporary city, its buildings and landscapes.

DRAWING TODAY

Drawing is a technique that allows the visual world to be understood. It is a convention, based upon a degree of abstraction and analysis, which focuses the mind upon aesthetic values. Whereas numbers are useful to economists, words to politicians and poets, lines are what artists and designers employ. Visual literacy is developed through the medium of drawing.

A distinction needs to be made between drawing as a tool for designers and drawing as a technique employed by artists. Although both artists and designers use drawing to help develop ideas, they do so in quite different ways. Artists are concerned with mark making, rather than descriptive drawing, and such marks are usually the genesis of later inspirational work. Their drawings are invariably abstract and experimental even when based upon observation. Even when fine art conventions are followed, the drawings made by artists tend to be fairly free form, employing mixed media and integrated with other visual material such as photography or collage. Fine art drawings, as against the drawings designers make, are likely to employ scraffitto (texture), impasto (surface), and shade (light and dark to give the effect of modelling). Designer drawings, on the other hand, employ a more mechanistic response based upon disciplined observation of what is before the observer. This is not to suggest that architects' drawings are

1.10

This design sketch by Lord Foster of the Maison Carrée in Nîmes shows drawing being used to explore the relationship between new and existing buildings in a historic context. (Lord Foster of Riverside)

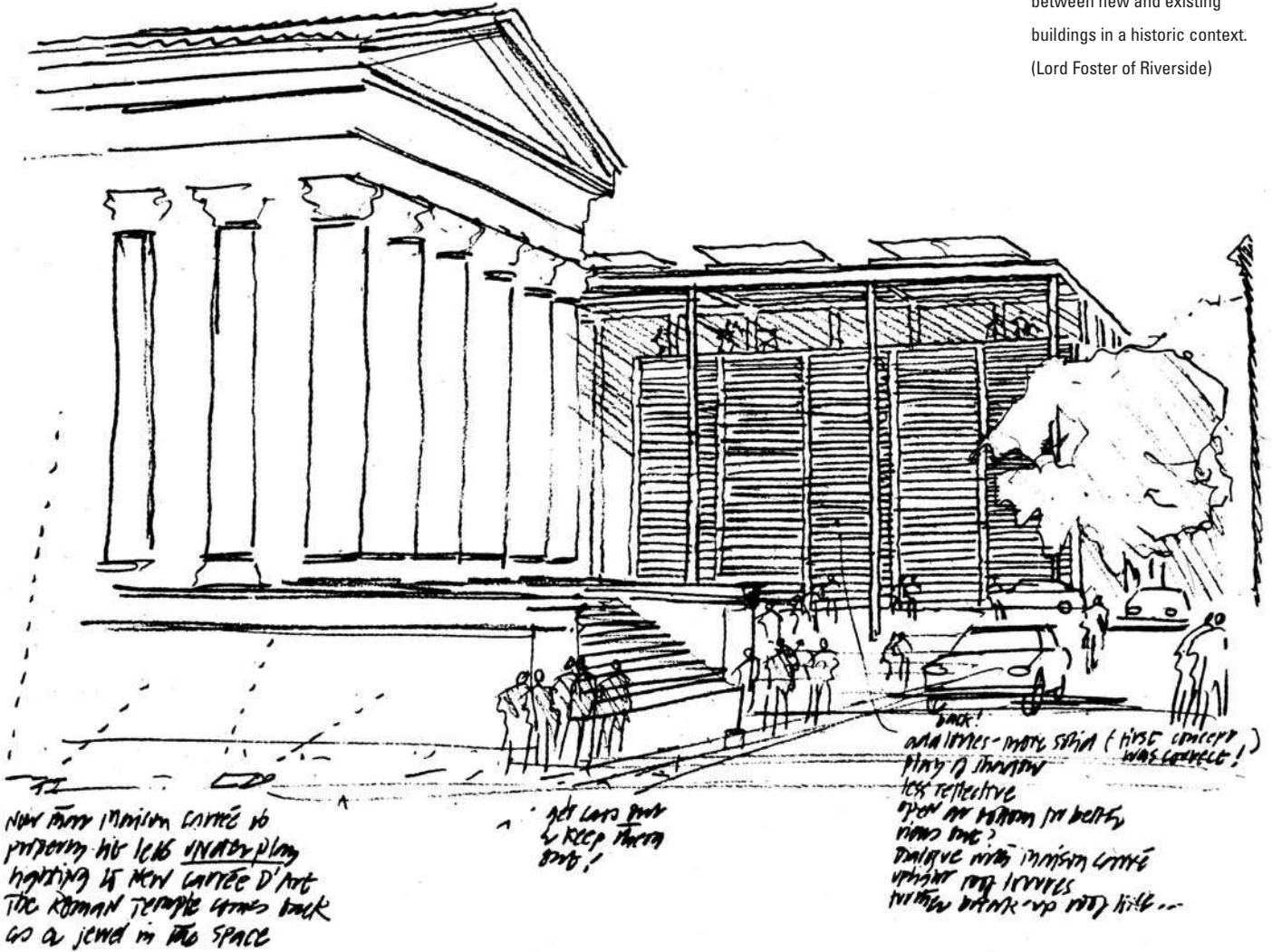

without abstraction or inspiration (although it is often sadly the case), rather it serves to remind society that designers solve both visual and functional problems through the medium of drawing. Their drawings contain the genes that allow future objects to be designed, made or built. In this sense the freehand drawings of architects and designers are not only anchored in the context of the present but contain the fertile possibility of the future.

To help architects understand form certain conventions have been developed. These include orthographic projection and perspective drawing, both of which have had their potential greatly amplified by computer-aided design (CAD) graphics. The combination of two- and three-dimensional drawing techniques means that a typical architect or product designer employs a mixture of plan, section, elevation, axonometric and perspective drawings to communicate their intentions. Increasingly these are all packaged into a CAD programme using AutoCAD, ArchiCAD or similar graphics software. What this book is mainly concerned with, however, is the stage before formal drawing begins – those preliminary sketches often made in the field or studio that help to develop visual awareness. These early sketches, placed for convenience in a sketchbook, allow precedent to be understood, methods of construction to be analysed, relationships in space or time to be assessed, and much more. For the designer the sketch is less an experimental beginning based upon abstract concepts (although this may be the case in the work of Zaha Hadid and Frank Gehry), and more the critical examination of a building, place, landscape or programme.

The architect generally builds his or her designs upon precedent. Even the best architects learn from the example of other architects' buildings, and often from their own. Many cultivate an awareness not just of contemporary precedent but historic examples too. Certain architects also seek to understand and exploit

types of precedent drawn from outside the world of the built environment. For example, Norman Foster admits to being influenced by the design of airport hangars and the aircraft themselves, whilst Santiago Calatrava is inspired by structures and designs found in nature, especially the shape and construction of bones. In both examples, sketches are used to learn about physical, material and visual properties – ideas that then migrate into their architecture.

Design is ultimately about solving problems. The future exists as an imaginative idea within the mind of the architect. Translating this concept into a building requires drawings. The problems to be solved are functional, technological, environmental and social. How sketches and more formal drawings are employed by architects varies but generally speaking sketching occurs at the beginning of the process, with two-dimensional drawings (such as plans) being utilised more towards the end. The first sketch made is instrumental and tells us a great deal about how a designer thinks. If the early design sketch takes the form of a section, the final building will be quite different had it been a plan. Likewise, had the first sketch been of a historic building of similar type, or of the structure of the landscape, or of some abstract but related concept, the final design again would have proceeded in a quite different fashion. For example, the architect Will Alsop often begins his design process with a painting that embodies some of the abstract ideas that more formal drawing may eliminate. His paintings are colourful, joyful and rich in design potential. Another architect, Edward Cullinan, carefully draws the visual relationship between his site and the wider city or landscape. In the process he discovers new ways of solving the design problem – ways that subtly stitch the new building into the wider scene. With Cullinan, as with Foster, the focus and tension in these early sketches informs the whole design process.

The type of drawing employed reflects well the intellectual inquiries undertaken by the architect. The plan is often the primary generator but sometimes the section or orthogonal projection takes priority. Sketches are explorations of spatial or formal possibilities. However, ideas are not only worked out in drawings, models and increasingly paintings are also employed, especially by those architects who are under the influence of art practices. More adventurous architects, from Rem Koolhaas to Zaha Hadid, use diagonal rather than orthogonal projection, creating dynamics in section as well as plan. When the lines are then stretched and twisted, the resulting buildings have a richness that the obsessive use of the right angle tends to deny.

Architects uniquely have invested in them the shaping of the future of cities. They shape this visually, functionally and socially (the latter in collaboration with town planners). Architects are essentially artists working at the scale of the city and with the material of building. Like other artists, they engage in shape, colour, light and space – manipulating all four to solve technical and aesthetic problems. Although architectural design is anchored by function to the reality of everyday life, architects are responsible for the evolution of buildings as cultural icons. They shape cities by looking simultaneously at precedent (with the sketchbook) and forwards to some unknown future (with CAD). As such, the freehand drawing is not part of a dead tradition but of a lively and inventive future. In this sense also the sketch is not made redundant by CAD but complements it. The two together provide architects with powerful tools to design the future. However, to ignore the act of drawing and to over-rely upon mechanical aids is to undermine any shared values between artists and architects.

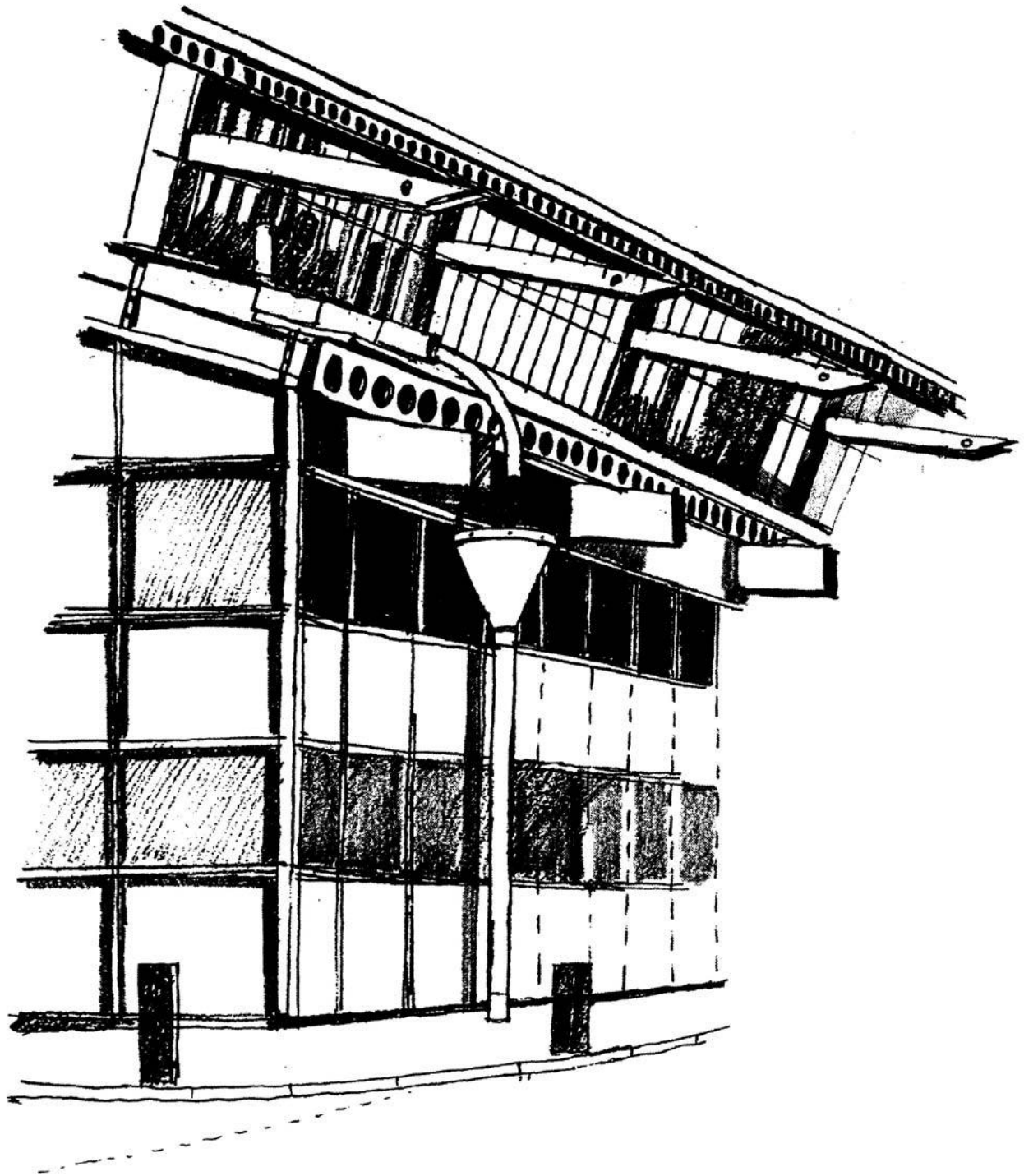

Part One

Guiding Principles

Chapter 2

Why draw?

There is an undisguised air of evangelism running through this book, for it seeks to encourage students of architecture, craft and design to forsake their cameras and learn the art of freehand sketching. Drawing is not only more enjoyable and far more educational, but the end product is more likely to remain a cherished object than would an anonymous slide or photographic print. Drawing an object, building or townscape forces you to engage more directly in the subject than as a mere photographer; the search to record shape, proportion, detail and colour requires greater effort and more skilled observation than that needed to press the shutter of a camera. The discriminatory eye encouraged through sketching has value to the potential designer and tourist alike for it engages the observer in an important dialogue with his or her subject.

Until fairly recently the sketchbook was the accepted accompaniment of all students of architecture or landscape, and of many interested tourists. In many ways Prince Charles maintains this honourable tradition. Before photography became more affordable and part of our visual culture, the sketch remained the means to record and analyse an interesting town, building or piece of furniture. You have only to look at the sketchbooks of famous architects – from Robert Adam to Charles Rennie

Mackintosh – to see how valued was the freehand sketch. Its use was often beyond that of mere record or pretty picture: invariably the sketch was the means of noting down a particular detail or type of composition that could be used when the right design commission came along. For instance, Adam's sketches of the fortifications of the Dalmation coast were transformed in less than a decade into the eighteenth-century Scottish castles occupying a more northern coastline.

Many students of architecture and design today spend a great deal of time making photographs rather than sketches. They could, of course, buy postcards or tourist guides, which often contain better and more accurate pictures at only a fraction of the cost, thereby concentrating their efforts instead on the harder but more valuable process of drawing. What the sketchbook provides is a means of delving deeper into the subject than merely recording it, in order to begin to understand why and how the scene was shaped. The main barrier to using the sketchbook in this way appears to be the lack of basic graphic skills, together with the hectic pace of modern life. As with all endeavours of value, you have to practise a great deal to cultivate the craft of freehand drawing, in order to fulfil the potential offered by the sketchbook.

The drawing skills are outlined in this book under simple headings such as shade, line weight, composition and rules of perspective. As with learning to play a musical instrument, you have to spend time practising and training eye-to-hand coordination. The rules of drawing are, like the rules of grammar or numeracy, based upon a language we all share and understand. By combining elements of the 'craft of drawing' with 'graphic rules', you will quickly develop a technique suitable to your particular needs – whether as a student of architecture, design or landscape, or simply as an inquisitive tourist on holiday abroad.

The process of sketching is not presented in these pages as an end in itself, but as a means of raising the student's awareness of design by cultivating careful, well-directed skills of observation. The sketch is both a record and a statement of visual inquiry. The act of drawing from life, be it of a town or a building, is to engage the artist in the subject in a unique and rewarding fashion. If the sketch is undertaken in the spirit of formal investigation then the results can be considerable in terms of the development of personal design skills. The linear progression from sketchbook analysis to design proposal is one that many architects have experienced. The

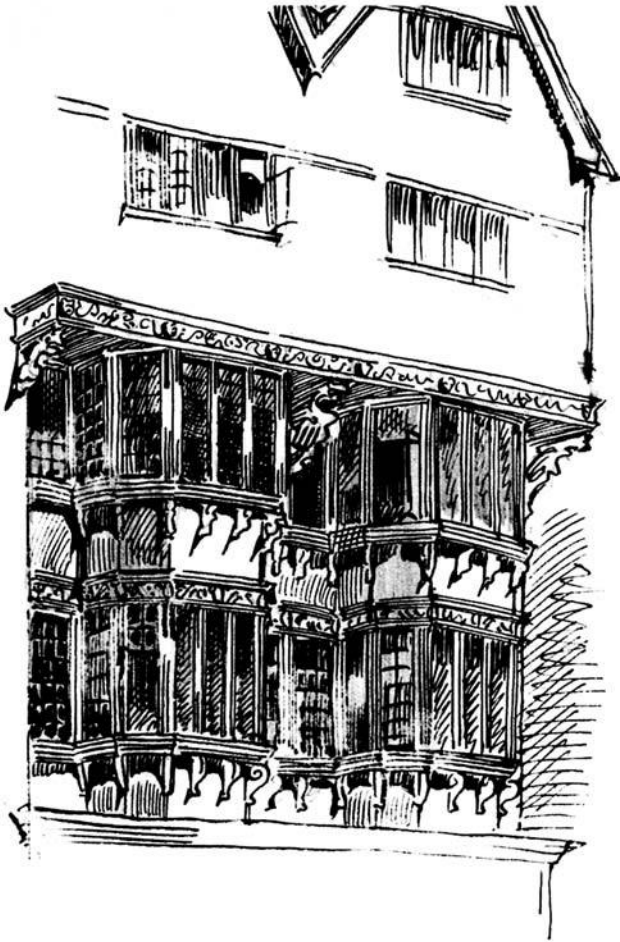

2.1

This elegant sketch (of 1880) by William Lethaby of the High Street, Exeter, displays a concern for construction and structural expression. (RIBA Drawings Collection)

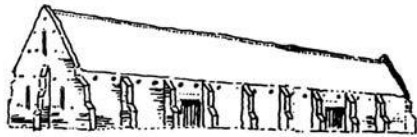

Wells Barn, Upper Weyford,
Oxfordshire c. 1400



Small granary
c. 1400 at Titchington
Wiltshire

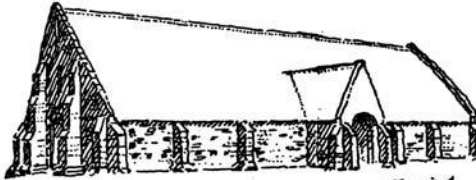

Great Cornwell Barn, Oxfordshire
mid 15th c. - one of finest surviving
medieval barns in England.



Interior of
Great Barn

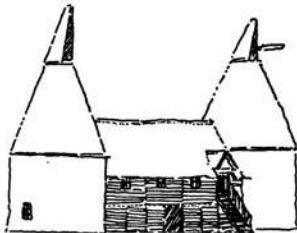

Oak houses, farm near
Edinburgh, Kent. - esp
central structure is late looking area.



Early 16th c barn
Gange Farm, Basing, Hampshire



2.2

Richard Reid's analytical drawings of farm buildings led, at least indirectly, to the design of his visitor centre at Chartwell for the National Trust.

2.3

The exploration of modern architecture can be as rewarding as that of historic buildings. This swimming pool in Sheringham, Norfolk, by architects Alsop and Lyall, makes expressive use of exposed beams, guttering and angled glazing. Shadows on the sketch help bring out the structural arrangements.

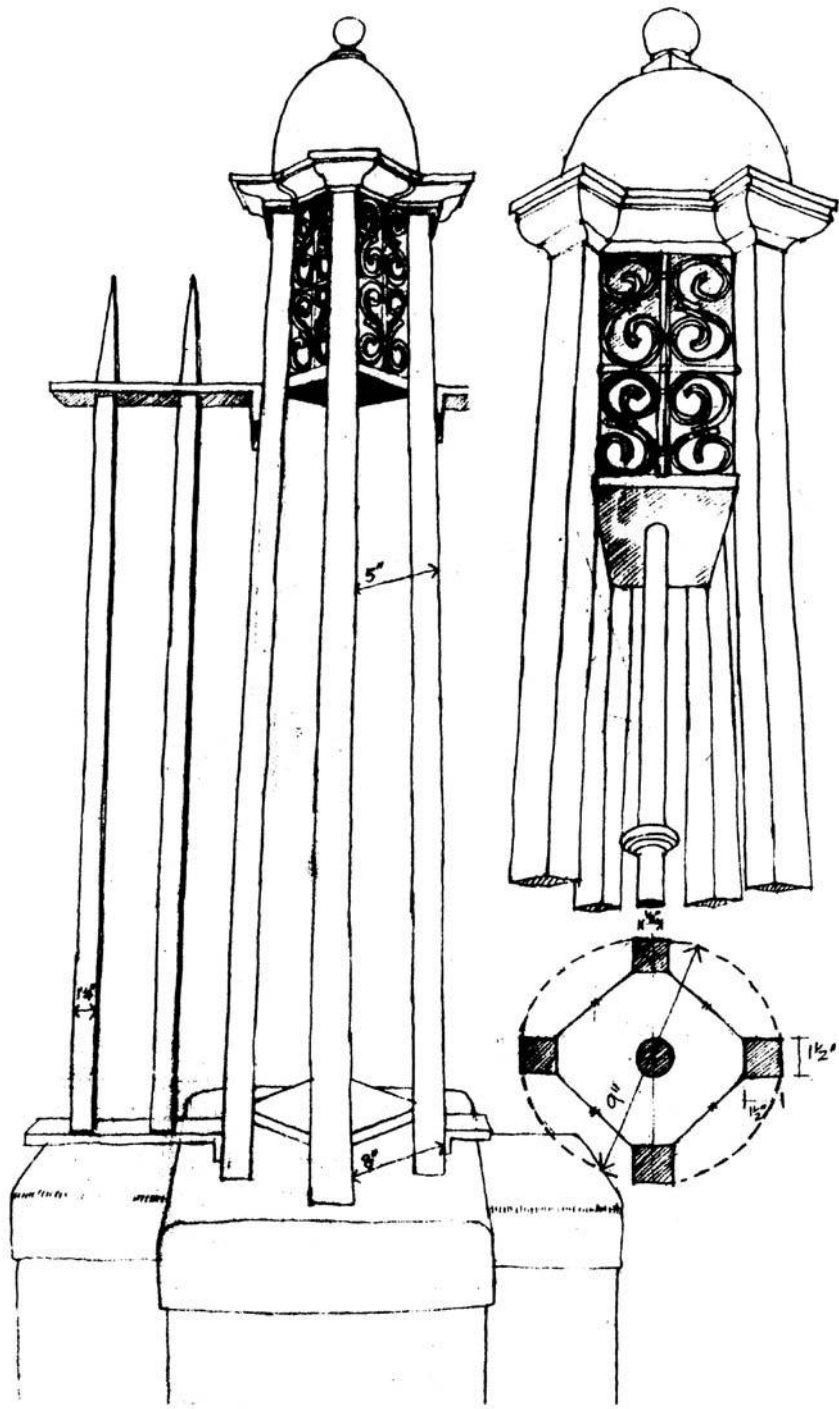

2.4

Decorative railings can be taxing to draw but the effort is worth while if it leads to the preservation of attractive features. This sketch was prepared as a measured survey prior to re-erection at the Royal Victoria Hospital, Newcastle upon Tyne.

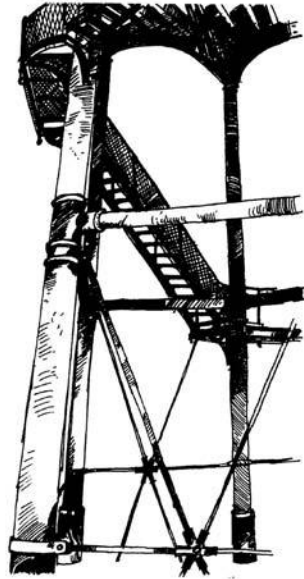
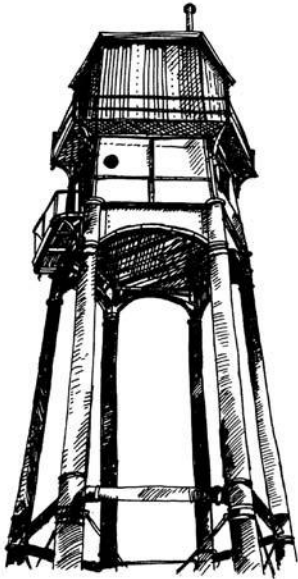

2.5 (far left)

The 19th-century lighthouse at Dovercourt in Essex has an undisguised steel frame and expressive bracing. The subject lends itself to pen and ink drawing with shading used to enhance the spacing of the columns and beams.

2.6 (left)

At a more detailed level the steelwork of the lighthouse at Dovercourt continues to give expression to how the structure is supported and braced against the coastal winds.

detailed study of a subject through the freehand drawing leads naturally to creative design by opening up different possibilities. Analysing existing buildings through the pages of the sketchbook provides a useful springboard for progressing into design. The precedents explored are of value in themselves, but, more importantly, the formal, spatial and decorative language employed in examples that have been sketched may prove applicable to the design of new buildings.

To take advantage of the progression from freehand drawing to creative design, the artist must approach the subject in a considered fashion. The outline is important and so are the proportions, and often a relationship exists between the building in plan and how it works in section and elevation. As we tend to draw the outsides of buildings, the potential designer should not focus upon the façades at the expense of the often critical relationship between elevation and plan. These 'invisible' relationships may be the most instructive when drawing certain buildings, and provide a source of ideas for the designer.

A good sketch is not necessarily a faithful likeness; it may in a pedagogic sense be better to analyse and decipher the subject. Sketches that consist of probings around specific themes may prove particularly useful to designers since they provide fruitful avenues for further exploration. Charles Rennie Mackintosh was a particular master of this type of sketch, and drawings from his Italian Tour of 1891 demonstrate a concern for form and decoration that are obvious precursors of his later designs. In his sketchbook drawings Mackintosh explores the volumetric nature of Italian churches, the simple, almost abstract forms of farmhouses, and the black and white decoration of Romanesque chapels. These images, and the facility Mackintosh developed for representing them, find expression, either directly or indirectly, in his later designs for schools and houses. Similar sketchbook studies of Celtic art and architecture, and of wild flowers sketched whilst living in Suffolk, proved a parallel path into creative design for Mackintosh.



2.7

This sketch made at a street café in Andraix in Majorca is drawn in pencil on smooth cartridge paper. The shading is intended to reflect the patina of ageing on old rendered façades.

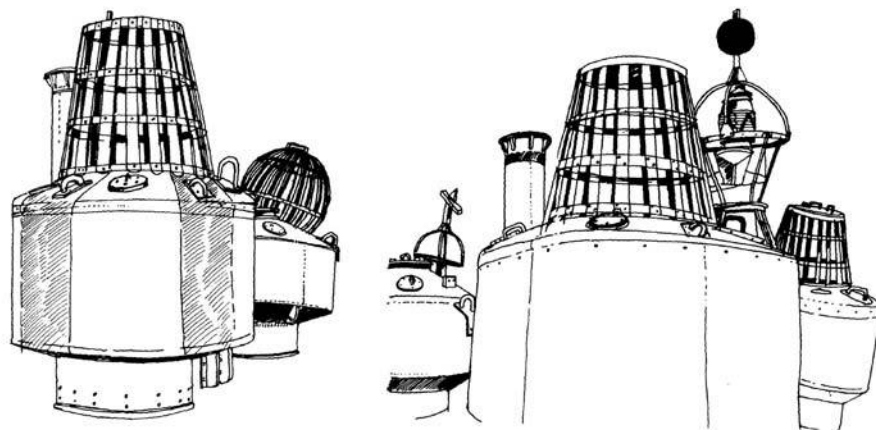

2.8 a and b

Drawn with a black felt pen, these buoys in Harwich harbour make an attractive assembly of strange shapes. Shadow has been employed to highlight the patterns and to distinguish between the buoyancy chambers and the protective grilles around the warning lights.

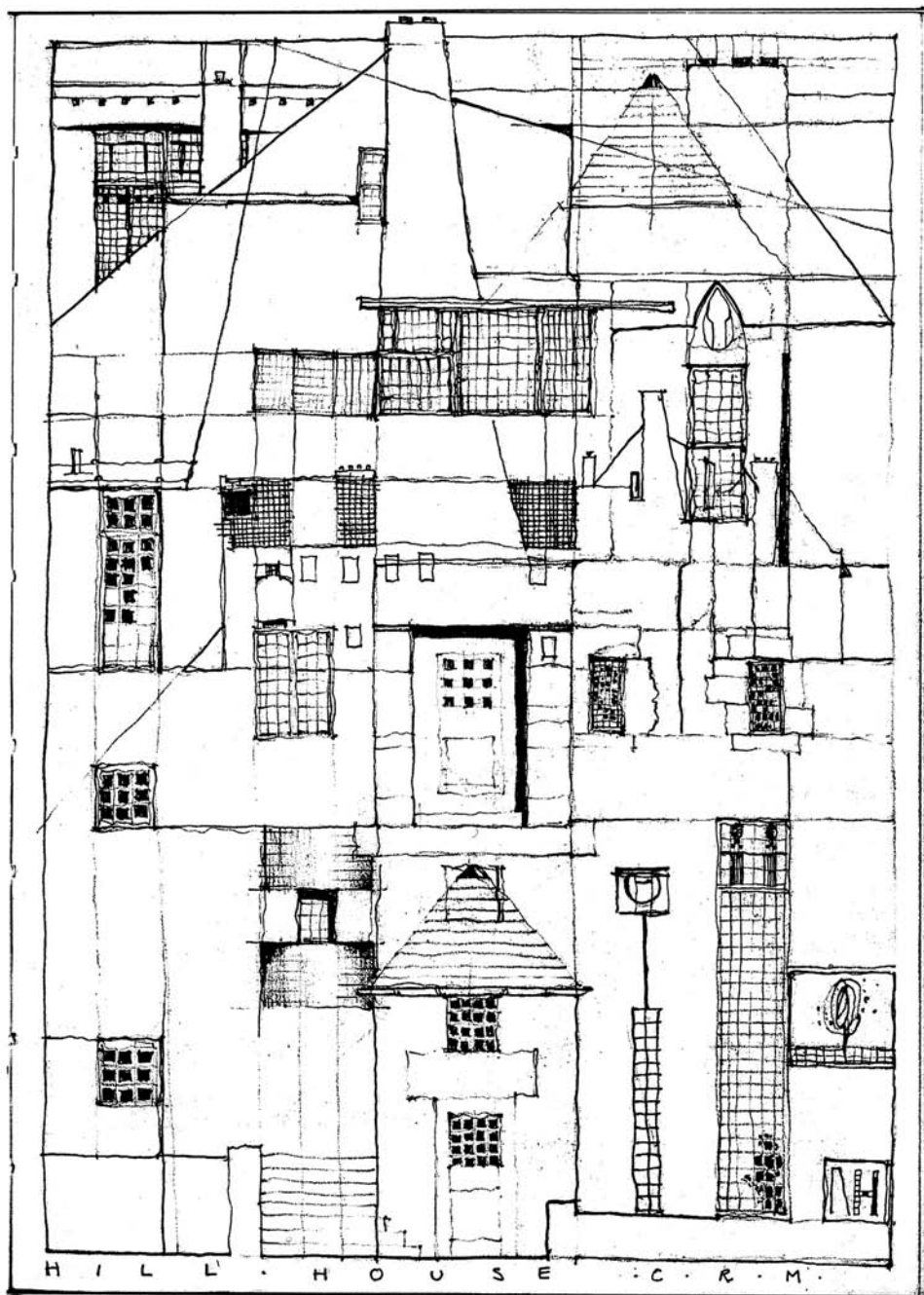

2.9 (left)

This study of Hill House, Helensburgh, by the architect Nick Hirst captures the essence of the building as a collage of elevations and details. The analysis implicit in the drawing is difficult to capture via photography or photoshop. (Nick Hirst)

2.10 a, b and c (opposite)

This sequence of sketches of New York in 1962 by Sir Terry Farrell uses black felt line with power and authority. The style of drawing suits well the subject matter and hints at the architect's subsequent design approach. (Sir Terry Farrell)

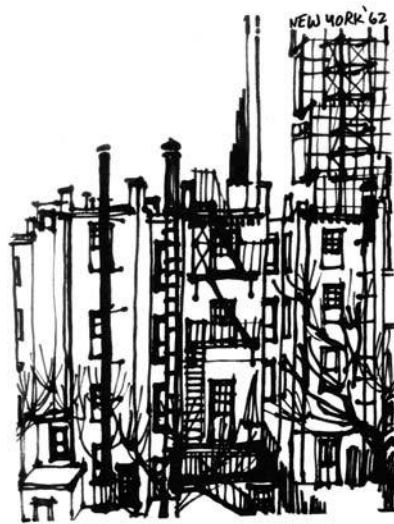

The architect Richard Reid uses the sketchbook in a similar fashion today. His studies of oasthouses in Kent were the inspiration for his design for a National Trust visitor centre at Chartwell. The freehand drawings provided a source of references that Reid selectively exploited for his new design. The skill Reid demonstrates in his sketching has enriched his experience as a designer. The same is true of Zaha Hadid whose three decades of sketchbooks sit by her desk and provide much of the DNA of her architecture (*Zaha Hadid 2006 p28*).

There is a further advantage for the designer in developing sketchbook skills. The graphic facility cultivated in freehand drawing aids the representation of design proposals. The means of recording an existing subject are much the same as those employed in depicting an unbuilt vision of the future. The graphic language is the same whether the building exists in reality or simply in one's imagination: the use of line and shadow, of weighted and feint lines, of exaggerated silhouette, and so on, are employed with equal meaning.

The skills needed for drawing, once learnt, are far speedier and more responsive than those required for model-making or computer graphics. Drawing also conveys a sense of spirit, of creative passion, which other forms of representation often lack.

Just as the sketchbook can be used to dissect graphically an existing building, the technique of unravelling and abstracting different architectural features can be employed in the reverse – to represent the different elements of a design proposal. The explanation of form, structure and decoration can help in the development of design especially where complex matters of building services and space management are involved. A line of continuity therefore links the analysis of existing buildings to the development of new ones, with a similar range of drawing techniques being employed. This is one of the lessons that may be learnt by studying the drawings of architects of the calibre of Mackintosh.

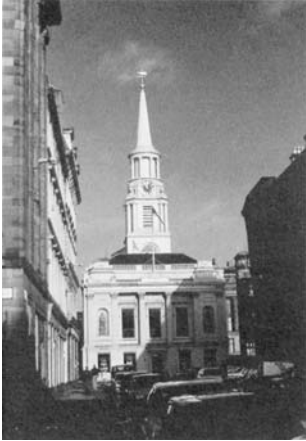

2.11 a, b, c and d

This sequence of four comparisons of sketches and photographs of central Glasgow shows the benefits of freehand drawing. In each case unnecessary information has been edited out in order to focus upon the architectural qualities. Whilst the photographs include all the detail, the sketches interpret their subject and highlight specific topics relevant to the designer.

MATERIALS

The artist of today has never been so fortunate with regard to drawing equipment. Modern waterproof felt-tip pens, clutch pencils and a wide range of drawing papers mean that every situation, type of subject and sketching style is catered for. The decision nowadays tends to be what to leave behind, since the range of materials is so wide and their reliability so good.

When choosing sketchbook paper, you should have already decided upon your sketching medium. Generally speaking, smooth cartridge sketchbooks (of the Daler type) are best for line work in pen; coarser paper for line work in pencil; and strong watercolour paper for paints or colour markers. Ideally, of course, you will have prepared for working in different materials and have corresponding sketchbooks to suit.

I prefer to use modern felt-tip pens (such as a waterproof Pilot or Staedtler) with smooth, fairly thin paper (such as a Daler 3404 sketchbook). Drawing pens with Indian ink tend to clog up or flow too slowly for my style of drawing. Alternatively, you can use a steel-nibbed pen (such as a post office nib) which is simply pushed into a pen holder and dipped as required into a pot of ink. The great advantage of old-fashioned steel nibs is that the thickness of line varies with the pressure exerted, so that sketches have a lot more character and points of emphasis. The architect and town planner Raymond Unwin used various thicknesses of line from a single nib to good effect in his sketches. The disadvantage of the open steel nibs is the length of time it takes for the ink to dry and their tendency to cast ink blots in all directions. However, with patience, good sunlight and a box of tissues, the problems can be overcome, and should you make an ink blot, this can either be worked into the drawing, or left to dry and scraped away with a sharp blade and ink rubber.

I try to encourage my students not to become weighed down with too many drawing materials – it is best to travel light and learn to improvise. It is no good for the artist to become like a photographer impeded by an assortment of lenses and light meters. All you really need is an A4 or A5 sketchbook, one or two pens or pencils and a good rubber.

The size of sketchbook depends upon the type of drawing you intend to do, and the medium you are working with. Large-format sketchbooks (A3–A2 in size) suit pastel drawing or watercolours rather than line drawing. As a rule, the finer the line, the smaller the sketchbook required. If you wish to mix line with paint then the effect is rather more of a painting than of a drawing, and consequently a large format is generally preferred.

I tend not to use sketching stools these days, partly because pavements are so busy, and partly because stools are rather cumbersome. You can, however, buy sketching stools with pockets for carrying pens, etc., and with a large flap for holding an A4 sketchbook, but I still prefer to find a café to sit outside. Often the places you wish to draw are the very spots where people want to sit and enjoy the view, and hence seats will have been provided by a friendly town council. In old towns there are generally lots of steps and walls to sit on, and inside cathedrals you will find comfortable pews or quiet cloisters with stone benches in which to enjoy a couple of hours of sketching. The one advantage of the sketching stool, however, is that you can choose the exact viewpoint for the drawing, and this can be important for certain subjects.

If you are drawing in pencil make sure you have a range of pencils of varying softness (6B–B), a soft rubber, fixative and a sharpener. Some people prefer clutch pencils, but many others prefer the weight and feel of the traditional pencil for field work. Pencil is a good starting

point for people learning to draw since corrections are easily made and the graphite or lead pencil has a 'graininess' suitable for many building subjects. Pencil also lends itself to depicting shade, light and shadow and this may be important in canyon-like street scenes. Pencil drawings have one other advantage: they can be photocopied to highlight or darken the tentative lines of a timid artist. Indeed, modern photocopiers can be a useful adjunct: not only can they encourage confidence in beginners, but in addition, several copies of a drawing may be taken (if, for instance, the sketch is the beginning for further analysis or the starting point for other artistic endeavours), while the original drawing is preserved.

Armed with a soft rubber, drawing with graphite pencil is the best way to start freehand sketching, being flexible, responsive and easily altered. Whether your sketches are spontaneous and primitive, or intricate and spatially accurate compositions reflecting a trained eye, pencil will probably serve your needs well. It should be remembered, however, that graphite pencils quickly smudge, especially if you are using a coarse drawing paper. It is imperative, therefore, that you spray lightly and frequently with fixative. Having mastered the technique of pencil drawing, the artist can then graduate to sketching in charcoal or pen and ink, or using colour washes.

Watercolour washes can be used to support pen or pencil drawings in order to give the appearance of three-dimensional form. Many people like to use grey wash along with line work to produce rather classical sketches of the type favoured in the eighteenth century. You can mix your own grey wash, or do as I prefer and make a grey by blending cobalt blue with sepia. The resulting wash is less 'dead' than a grey watercolour straight from the tube since hints of blue and brown appear as the wash dries. Sometimes a pre-mixed wash can be employed, especially if the sketch has to be produced in a

hurry, but often the wash varies in density, to the detriment of the finished drawing. Watercolour can, of course, be employed to produce illustration in its own right. For watercolour sketches use a box of twelve colours that come with a mixing box (Windsor and Newton, for instance) and two or three sable brushes. Try to use largish brushes to avoid the sketches becoming overworked, and if you like you can take a crayon or candle to experiment with wax relief to produce the sort of lively architectural sketches made famous by John Piper. For mood and character, dark-toned watercolour sketches can hardly be bettered, but you will find paint a difficult medium for analytical drawing.

Coloured felt-tip pens can be difficult to master since their hues are often rather strong and do not mix well together. But some subjects lend themselves to these pens (especially modern architectural subjects and industrial or automobile design). By mixing the bright, almost luminous quality of felt-tip pens with more neutral paints or pencil lines, the sketch can assume a sparkle or resonance appropriate to certain subjects. Felt-tip pens and magic markers are difficult to control but they have a place in both the modern design studio and amongst the sketching tools of an adventurous street artist.

Although I was taught never to use a ruler when sketching, I do not now subscribe to this view. So many of our landscapes and buildings are rectilinear in nature that the use of a ruler to help establish the basic outline and structure can no longer be considered a lazy shortcut. The straight-edge is, however, no substitute for the trained eye. If the sketch is as much learning process as end product, the ruler may help the latter but does not assist the former. Hence use the straight-edge if you will, but do not expect to learn much from the assistance it gives.

LOOKING AND SEEING THROUGH DRAWING: MODERN SKETCHBOOK PRACTICE

The practice of looking is as important as the practice of designing. The sketchbook allows the looking to become more critical – the image produced by drawing heightens awareness of the subject and offers a greater range of potential to the designer. Freehand sketching is a way of recording subjects in a more rigorous way than simply photographing them, thereby helping to cultivate visual memory and critical judgement. Looking is a precondition to exploring subjects beneath the surface, and this is further developed by sketching. Hence, there is a linear progression between looking, sketching, drawing and designing. A distinction is made here between sketching in the field, drawing in the studio, and rationalising one's thoughts through design.

In architecture and design schools drawing studies form the core of the curriculum. However, drawing tuition is expensive and demanding of studio space with the result that much of the teaching of drawing is concentrated in the early (often foundation) years. As a result many students fail to carry on exploring through freehand drawing, preferring to use CAD or technical drawing in their senior college years. The need to equip students with the tools necessary for industry and professional design practice adds to the pressure to abandon freehand drawing. Computer-assisted drawing does not necessarily undermine the craft of traditional drawing as long as creativity and presentation skills have previously been learnt by more orthodox methods.

Sketchbooks are seen by many students as a form of visual diary. They tend to resemble notebooks with their collections of images rather more than traditional hand-drawn sketchbooks. Modern sketchbook drawings are both the construction of images and the recording of objects. Construction suggests a deeper level of inquiry

than mere record-making. Modern sketchbooks tend, therefore, to contain four main types of visual material – the sketch as record, the sketch as re-construction, sketches augmented by photographs or digital images, and finally, abstract or analytical drawings. The combination of drawing types makes the sketchbook an important pedagogic tool, whilst also enhancing the level of critical viewing. In this sense there is a direct relationship between the sketch and looking, and by extension with the development of visual and design skills.

The trend in art, design and architectural education is to 'integrate' drawing with projects. Stand-alone drawing classes tend not to occur beyond the foundation years. The main difficulty with the concept of integration is how to develop drawing skills in parallel with project ones. The task of design tends to become dominant over that of drawing and increasingly, to fill the gap, students and design professionals rely upon computer-based drawing packages (Schenk 1998). This further distances the student from learning through drawing or matching the complexity of design projects with equally complex modes of traditional drawing techniques. Also, since drawing is the means whereby there can be a marriage of art and architecture, to neglect freehand sketching is to undermine the alliance of art, sculpture and architecture upon which the twenty-first century seems increasingly reliant.

DRAWING AS COMMUNICATION

Drawings are a designer's way of writing: they are a means both of communication and of problem solving. For many architects there is not a clear distinction between drawings, words and symbols (Lawson 1980 p173). All contribute towards the evolution of a design whether in plan, section or elevation. The shapes on

2.12

Sketch for unrealised Samsung
Headquarters Building in
London by Sir Terry Farrell.
Notice the similarity in the use
of line and shade to Figure 2.10.
(Sir Terry Farrell)

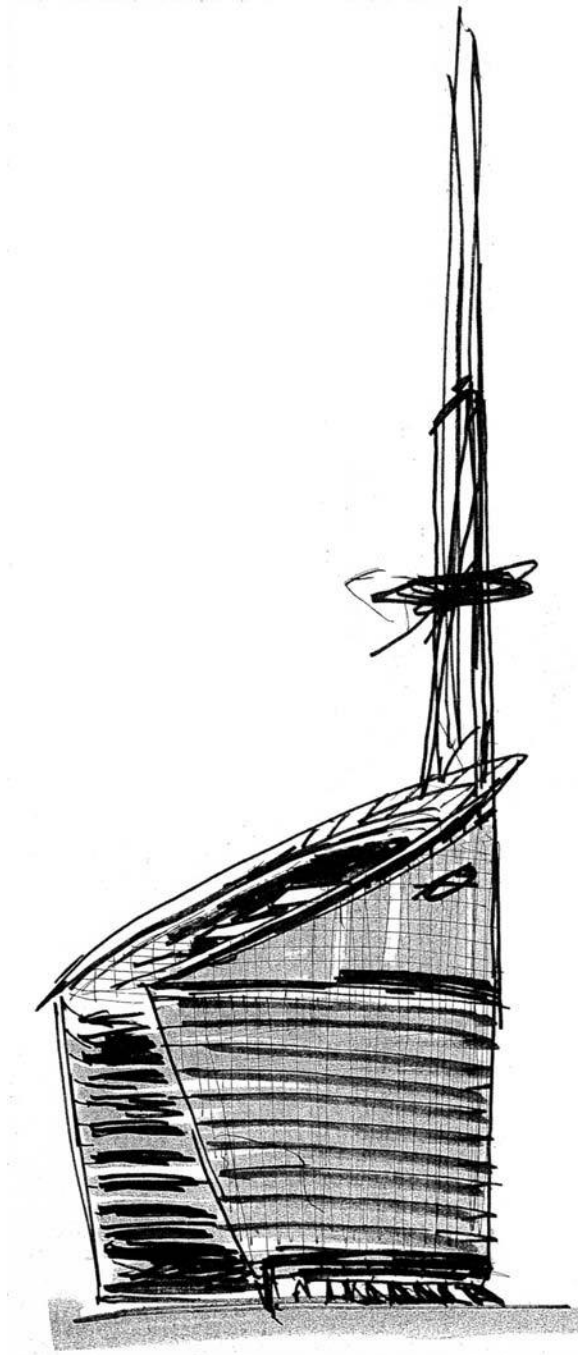

paper, often developed in parallel with model-making, are the beginnings of a story of design development. Drawing is essentially a form of language and, like all languages, there are recognised codes and conventions. It has been suggested that architectural drawing evolved for description rather than as a guide to new construction (Rattenbury 2002 pxxii). In this sense, the primary role of drawing was to record or analyse an existing building as opposed to anticipating the form of a new one. The drawing was a record of culture: human activity was recorded through drawing not, in the earliest examples at least, projected by them. Drawing, like language, was an account of things seen, not a blueprint or instruction to others.

One can, however, take the parallels between drawing and language too far: drawing does not offer the complexity of a spoken language but what it lacks in complexity it makes up for in power and communication. Drawing, like the language of words and mathematics, seeks to give meaning and order to very complicated worlds. It is a tool that is both representational and, looking forward, allows for the 'meaningful ordering of things in the environment' (Lawson 1980 pp173–4). Since drawing is a type of language, it is used in different ways by different architects. Some employ drawing as an analytical tool, others as a form of intuition. Inspirational drawing, which may be just a few lines and referential marks, varies from the type of drawing Frank Gehry makes to those of Norman Foster. Foster's design drawings quickly bring order, particularly spatial and constructional order, to the early chaos of a typical brief. Gehry's drawings, on the other hand, display a search for meaningful randomness, translating the functional demands of a design brief into a graphic form of non-linear logic. Both types of design drawing have their own logical processes and inner fluency, yet they instil architectural order in different ways. Hence, the resulting

buildings that start from these sketches end up looking quite different even if they share similarities in function. One has only to compare Gehry's Guggenheim Museum in Bilbao with Foster's museum in Nimes to see how powerful is the vehicle of drawing.

Freehand drawings tell us a great deal about the way individual architects think. They tell us, too, that architects think quite differently from engineers and artists. Their sketches lack the engineers' striving for mathematical exactitude or the artists' freedom from graphic convention. It is often said that you can measure whether an architect thinks like an architect from his or her drawings and this is one reason why sketches are often preferred at crits or job interviews to CAD images. The sketch contains the message that an architect is a designer and not just a draughtsman or technician.

The drawing is also the means by which the architect visualises, tests and orders imagined relationships (Lambert 1998 pp8–9). The drawing is a construct that starts in the mind of the architect and becomes manifest on paper, where it can be shared with others and further developed. To become a building there is the participation with two other key figures – the builder and client. As such, the drawing presents the artistic and intellectual ideals behind the design to those whose tasks are necessarily rather more mundane. However, as Forty notes, the drawing was the prime means by which the genius of the architect was set apart from the building trades (Forty 2004 p30). Sketching and visualising through drawing is what defines an architect and, arguably, should be the first skill to be developed in schools of architecture.

Chapter 3

Choosing the subject

It is no good dashing off a sketch on your first visit to a new city or to an interesting building. Such hurried sketches are generally poorly composed or suffer from having the light in the wrong direction. It is worth taking your time and planning the drawing carefully. The chief points to consider are:

- what drawing materials are best for the sketch in question;
- from where you should draw;
- what time of day is best for the sketch, bearing in mind the angle of light, especially sunlight;
- what position is best to bring out the character of the subject and produce an attractive composition.

Taking the first point about materials, you will probably find that certain subjects suit a particular sketching medium. For example, a highly decorative subject such as the west front of a cathedral would suit a line drawing in pen and ink, perhaps with depth being created by a sepia or grey wash to indicate shadows. The interior of the cathedral, on the other hand, may suit a charcoal drawing since the darkness and solidity of the columns, vaulting and arches could be brought out in thick, grainy lines and smudged tones. An Italian hill town may be best rendered

in watercolour as this may suit the delineation of the pink, brown and orange walls and roofs. A classical terrace by John Nash may look its best in pencil with a soft wash of cream added. A modern 'high tech' building such as the Lloyds Insurance offices in London or the Pompidou Centre in Paris could be tackled in pen and wash with brightly coloured felt-tip pens being used to pick out the externally placed lifts and services. Whatever materials are employed, the artist should try to establish a relationship between the qualities of the subject and the drawing medium.

Deciding where you should sit to draw on location raises both aesthetic and practical issues. You will often find that your subject is near the town centre and hence very busy, or so frequented by tourists that you can hardly obtain an unobstructed view. Hence you will need to plan your sketch to fit in with siesta times (if in Europe), or to take place in the early morning or late evening if in the city centre. Sometimes you can find a quiet corner even in the busiest town, but often it will be dirty or the odours will not be conducive to good sketching. If you have a sketching stool then your options may be greatly increased, but try to avoid positions where crowds of curious children can peer over your shoulder (and maybe steal your spare pencils!). If you have to find public seats,

low walls or steps to sit on, then planning in advance is doubly necessary. You might well find that the best angles for drawing are also those preferred by tourists, and sometimes the best sketching position places you in the shade or in a draughty corner. Drawing a Mediterranean town in the warm sunshine of a June afternoon is a rare pleasure, and with good planning you may be able to find a street café where for the price of a cup of coffee you will have an uninterrupted hour for drawing.

You are likely to produce a better sketch if you are warm and have a little privacy. Besides crowds, try to avoid sitting in areas full of traffic fumes since this is not

only unhealthy, but the dust and dirt will mark your paper and discolour your washes. Traffic is usually unavoidable, but if you study which way the breeze is blowing you may be able to find an area less troubled by fumes even in congested cities like Rome or Athens. Often it is only a case of deciding which side of a square or street to sit in order to avoid the traffic fumes and enjoy the sunshine on you and on the subject.

The angle of light, and particularly of sunlight, can make the difference between a good and a bad sketch, and hence affect your ability to learn from the process of drawing. You will generally need the sunshine to be on

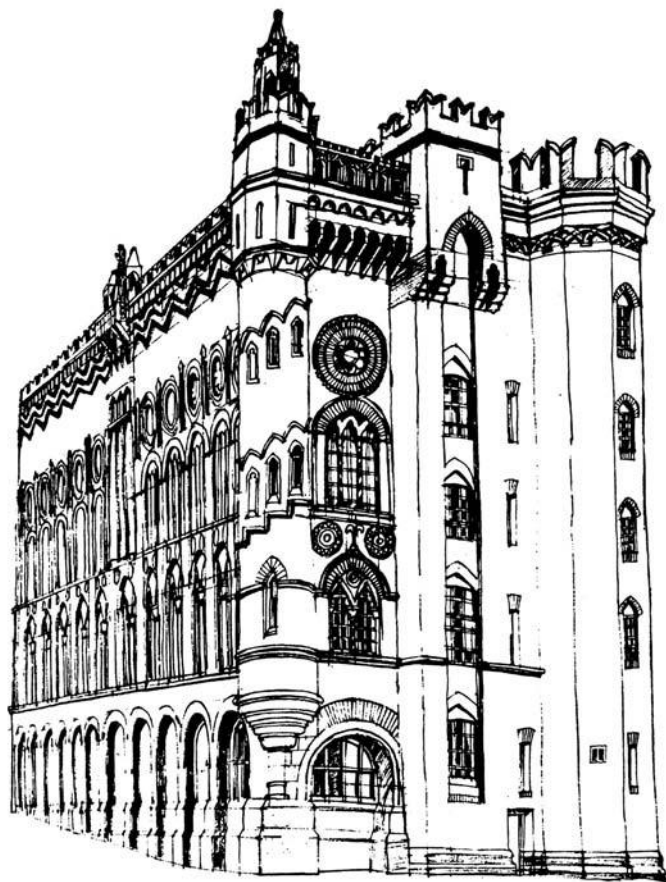

3.1

A drawing of this complexity can only be undertaken with the façades bathed in sunlight. The level of detail and degree of patterning requires bright, preferably diagonal, light to pick out the extraordinary detail. Known as Templeton's Factory and situated in Glasgow's east end, this handsome Victorian building looks across an extensive park.

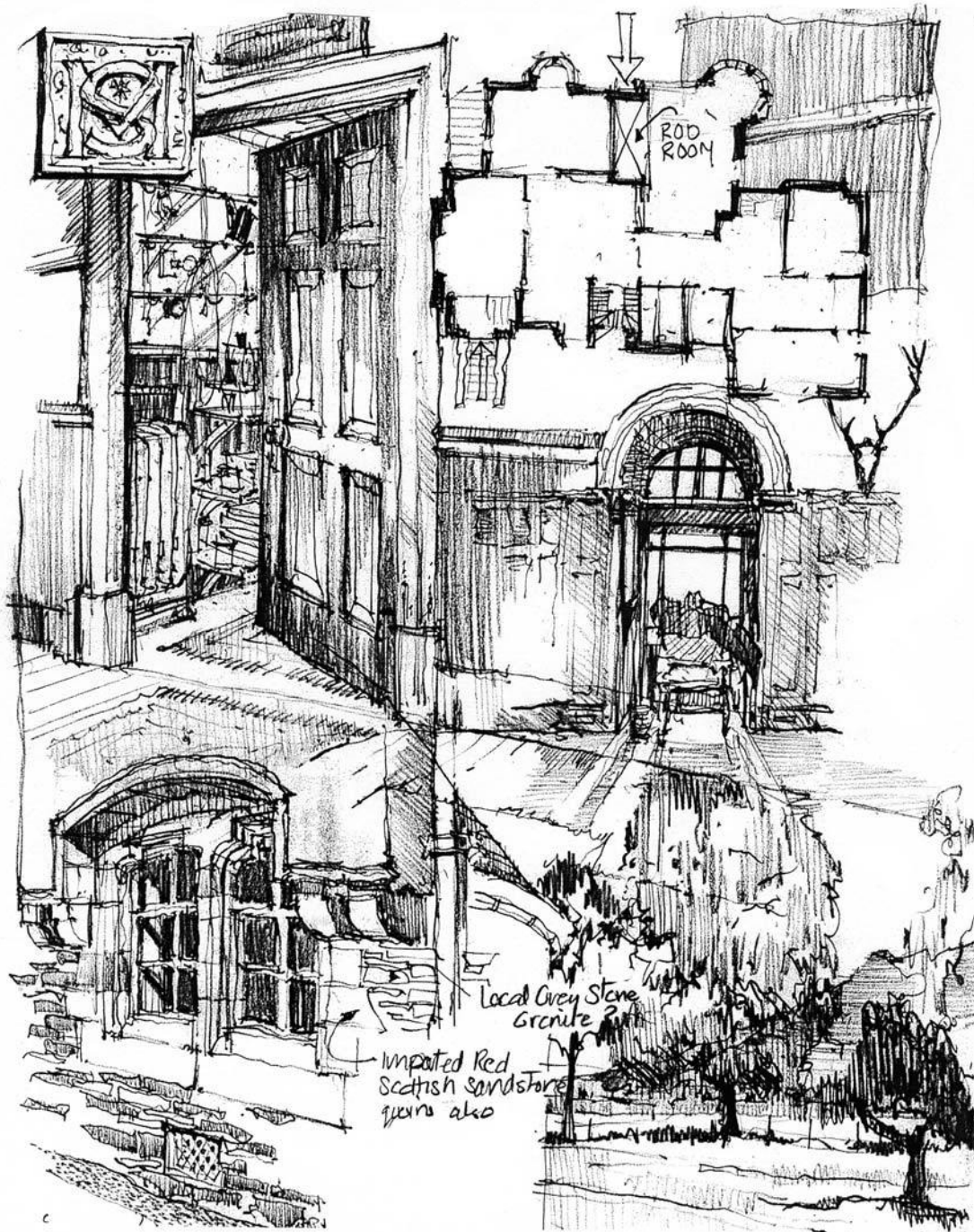

3.2 (left)

Kinlochmoidart House, designed in 1884 by William Leiper and drawn here in 1999 by Nick Hirst as part of his Philip Webb Travelling Scholarship. The drawing is a collection of sketches and plans aimed at documentary analysis. Leiper also designed the building in Figure 3.1. (Nick Hirst)

3.3 (above right)

The complicated façade of the Pompidou Centre in Paris is set against a dark sky to draw attention to the building's expressive silhouette. The exposed ducting and pipework make an attractive substitute for columns and walls.

3.4 (far right)

Street scenes like this are best attempted when the traffic has died down. This 19th-century 'flat iron' building in Vancouver shares a busy road junction with lamp-posts, telegraph wires and the occasional delivery bicycle.

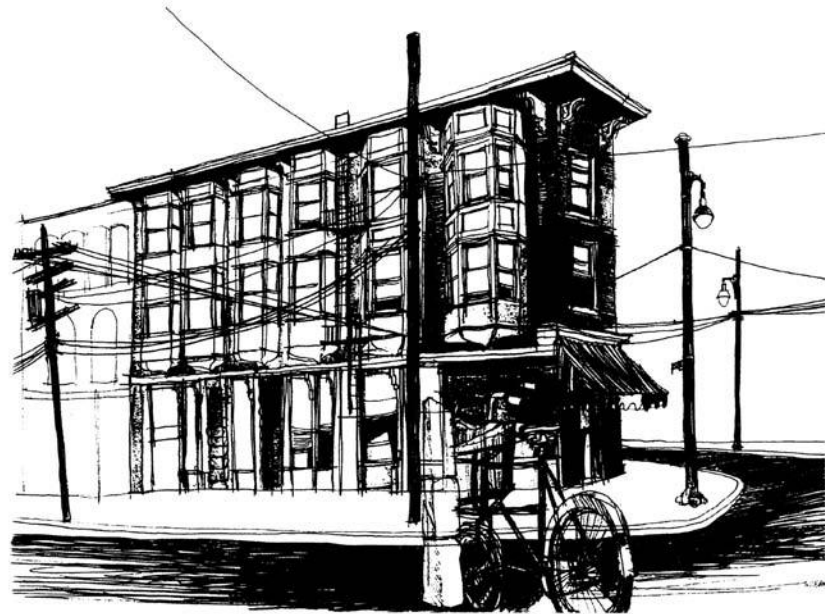
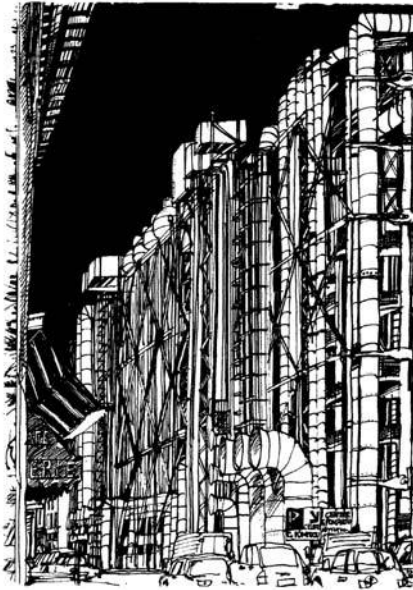

your subject and preferably at an angle rather than straight on. This brings out any sculptural modelling or surface relief, allowing the artist to understand the nuances of the building or the intentions of its designer. Certainly it is useful to highlight or exaggerate effects of light, especially in older buildings where time has worn away the sharpness of the detail. Try to avoid having the source of light behind the subject, unless you are deliberately attempting to draw its silhouette. Cathedrals lend themselves to dramatic silhouette and it is quite permissible to exaggerate the effects of light on the city skyline. The Manhattan skyline or a castle such as that at Edinburgh, perched on a dramatic hilltop, lend themselves to silhouette drawing, but the sketch may benefit from having detail shown at ground level drawn as open line rather than dark, craggy shapes. Such drawings can tell us about the role of the 'monuments' in the city and their prominent position in the skyline. The role of lesser buildings and foreground detail is merely supportive – a point not always recognised by modern architects or town planners.

Sunlight also casts shadows, which can provide tonal relief to a line drawing. A collection of lines can appear rather abstract, while shadow or shading gives the drawing a feeling of solidity and three-dimensional form. Shadows can also give an indication of buildings behind or to one side of the artist, but not in his or her field of view. It is worth bearing this in mind if you are drawing in the street or in a square. Shadows give an indication, too, of deep, canyon-like streets as against open suburban roads. Sketching should aim to capture the character of places, and the play of sunlight with its consequent casting of shadows is part of the visual repertoire to be exploited.

The depth of shadow is important. Northern subjects illuminated with soft light suit the faintest of shadows, but a southern Baroque church or Moorish temple is best rendered in deep shadow. It has been suggested that the extent of modelling of a building's façade directly reflects the anticipated level of sunlight, a south- or west-facing frontage being designed with plenty of deep relief whilst a north-facing façade has a more subdued quality. These

subtleties are often only made manifest to the observer through the act of drawing.

One of the professional tricks of the contemporary architect is to draw a bland office façade with plenty of deep shadows, thereby suggesting a building of greater visual richness than the one to be finally built. In this way the designer may 'persuade' a planning committee or amenity society to accept the proposals. The normal method of showing shadows is to assume a sun at 45° over your left shoulder – hence the window sills and eaves can then be picked out with a dark-blue or even black shadow. Designers have long realised that they can enhance the appearance of their proposals by using shadows based upon an abstract and decidedly flexible view of reality. In many ways the artist drawing a street scene or building can adopt this device and in the process make a dull northern scene look quite lively. Even if the sun is not shining, the assumption is that it can enhance a subject and make its visual qualities more accessible to you as artist, and to those who look at your sketch.

Choosing the position to draw from is also largely an aesthetic matter. The relationship between the parts of a sketch is important and you should seek to achieve a measure of harmony or balance in the drawing. The elements to consider are those features in shadow and those picked out by the sun, those that can be rendered in line as against tone, and the parts in elevation as against perspective. All these factors dictate where you choose to sit, what time of day you select to draw, and what materials you employ.

Taking time to consider these elements saves you from frustrations later when the drawing does not work out in spite of all your efforts. The sketch is really a piece of design, and hence a great deal of thought and planning is required. It is unusual to find that you can race into a drawing and be pleased with the results, or feel you have learnt from the experience.

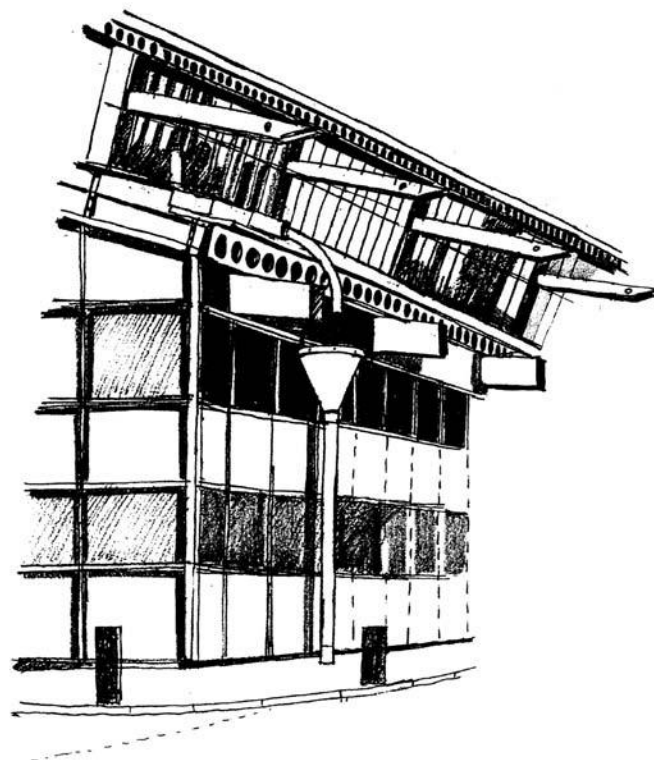

3.5

This drawing of the swimming pool by Alsop and Lyatt in Sheringham, Norfolk, was drawn from inside a car in order to provide shelter and privacy, and the best angle for the sketch.

Sketching should be both enjoyable and educational; and both may be helped by a little contemplative peace. As such you are likely to be happier in a quiet leafy courtyard than a busy high street, and in the side chapel of a cathedral as against the nave.

Search out quiet corners and try to have a wall behind you if strangers looking over your shoulder make you feel uneasy. One other tip about selecting your spot for sketching: choose somewhere that feels safe (street crime is unfortunately on the increase in most European cities) and keep an eye on your wallet or handbag.

3.6 (below)

Façade study of National Museum of Western Art, Tokyo, designed in 1958 by Le Corbusier.

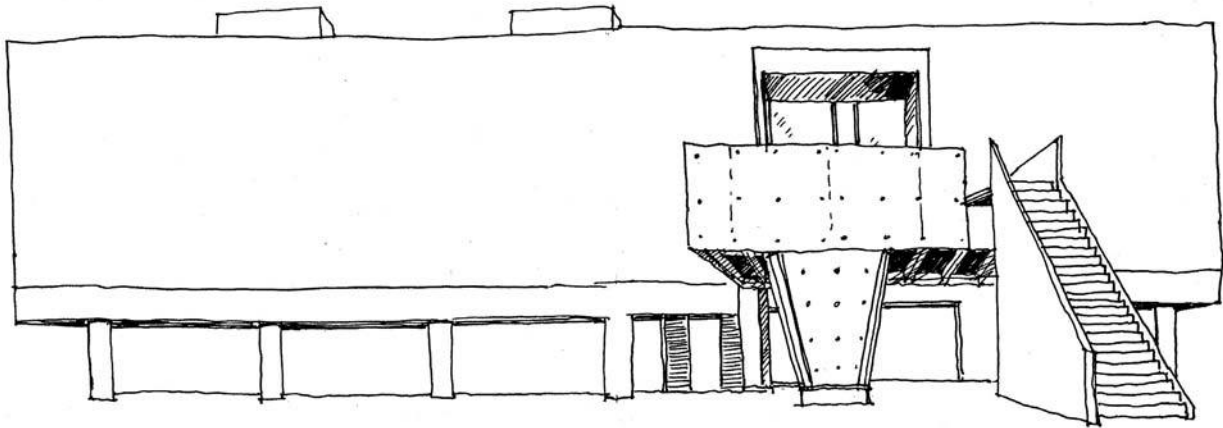

3.7 (bottom)

Façade study of Metropolitan Festival Hall, Tokyo, designed in 1960 by Kenzo Tange. Both Figures 3.6 and 3.7 sought to compare the compositional principles of modernism by two leading exponents.

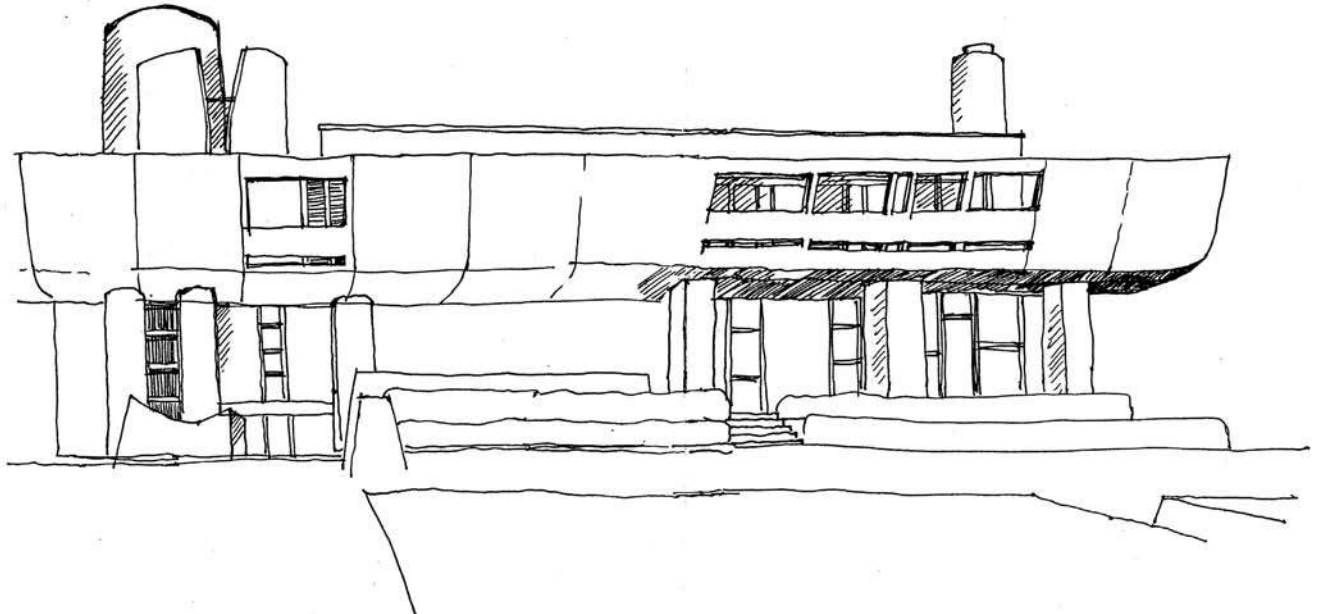

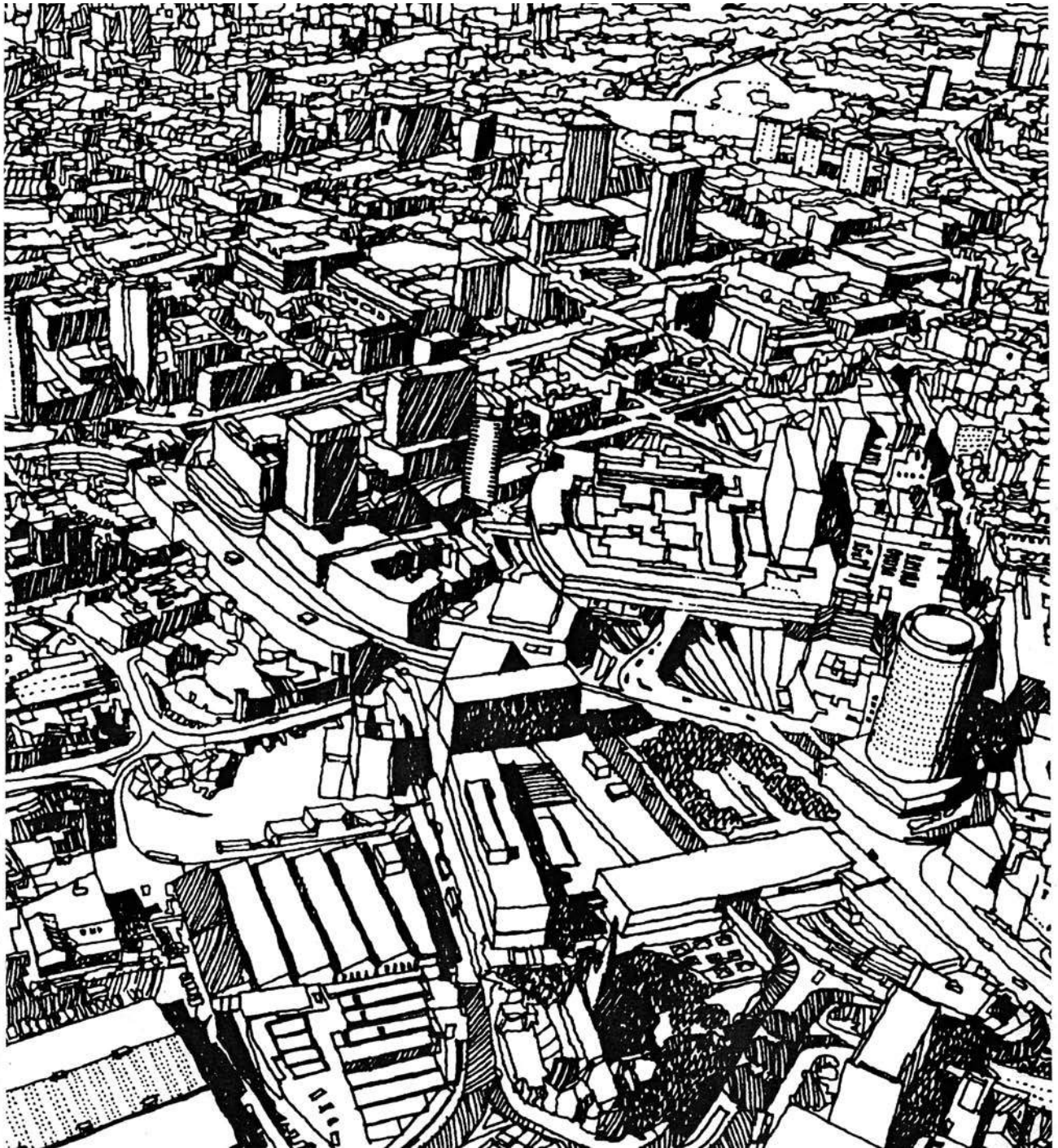

Part Two

Techniques

Chapter 4

Perspective

An understanding of perspective is essential in order to gain a full appreciation of the aesthetic quality of towns, and is necessary in order to be able to draw them well. Many cities, especially those based upon classical principles of town planning, exploit perspective in their arrangement of streets and squares, and if you do not understand the principles of perspective you can hardly be expected to draw them adequately. Likewise, many building interiors are so arranged that a grasp of perspective is essential not only if you are going to attempt to sketch them, but in order to understand their spatial qualities.

Designers are able to visualise the volumetric arrangement of their buildings simply by conceiving them in terms of true perspective. Sir Christopher Wren was one of the first architects to admit that an understanding of perspective was vital for the design of a building. Perspective allows the architect or designer to anticipate the relationship of the parts of the design without making a model or drawing a line. As we see towns in terms of the routes and streets we take, and buildings in terms of room and corridors, a grasp of linear perspective is a fundamental starting point for spatial comprehension.

The discovery of true perspective was one of the high points of Renaissance art. A handful of artists working in

Florence in the fifteenth century stumbled upon the rules of perspective, and quickly exploited it in their paintings. Soon afterwards it was adopted by architects, who arranged their buildings and squares with mathematical precision. The resulting environment seems almost to have the expression of perspective as the central point of the design. Proportional harmony and repeating bay sizes lent themselves to presentation through perspective either in the form of paintings or architectural sketches. Later, in the Baroque period, town planning exploited perspective by creating long vistas of streets or tree-lined avenues ending almost at infinity or terminating with a public building. Without the discovery of geometrically correct perspective, grand designs such as Versailles or the Nash terraces in London would have been unthinkable.

To draw such towns one must understand perspective, but sketching in the street does not require the production of drawing-board perspectives based upon rotating picture planes and mathematical precision. In fact, these elaborate perspective drawings can become so complicated that they discourage you from drawing on location at all. It is a case of the science of perspective becoming an obstacle to learning the simple principles of perspective.

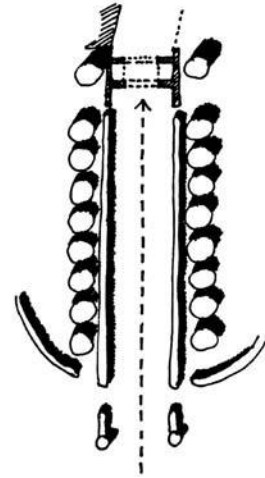
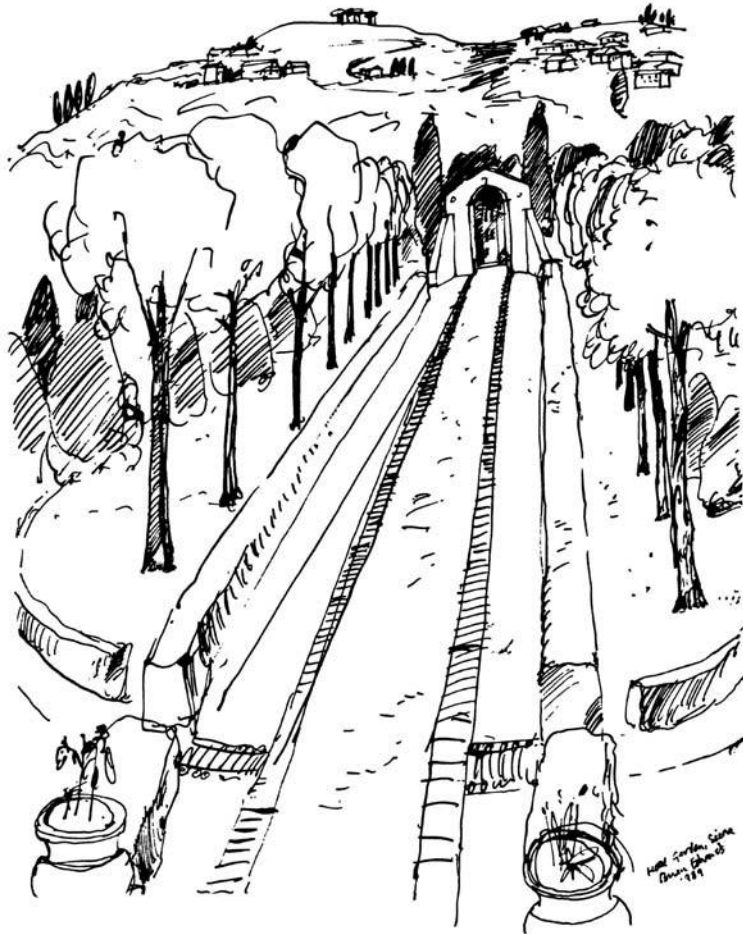

4.1

The axis of this garden in Siena exploits single-point perspective. The garden walk is terminated at one end by a gateway and at the other by a formal flowerbed.

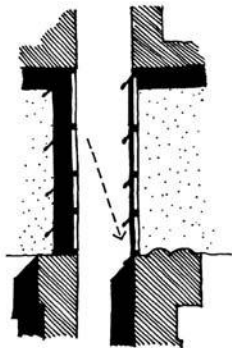

4.2

An understanding of perspective allows complex subjects such as this double bow-fronted Georgian house in Ayr to be drawn with confidence. Notice how windows in the distance are rendered as mere vertical lines, and the use of hatching focuses the eye on the critical parts of the design.



4.3

These three reconstructed timber houses at the Black Creek pioneer village in Ontario show how perspective enhances the spatial pattern. Notice how unnecessary detail has been left out to allow the observer to focus upon the buildings.

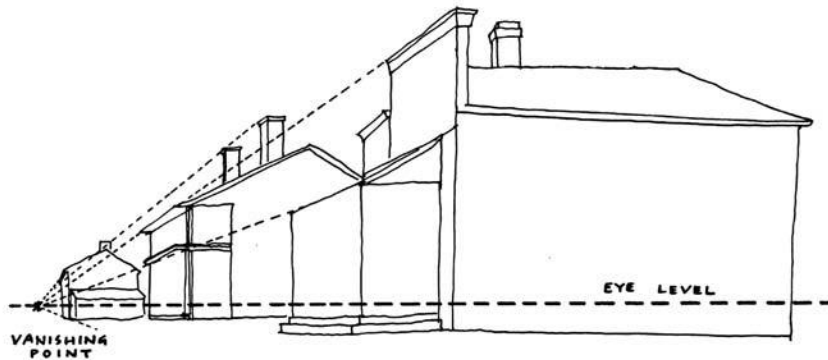

4.4

This diagram shows how Figure 4.3 is composed in terms of eye level and vanishing point.

Indeed, for most subjects it is only necessary to understand the basic rules of perspective – that parallel lines focus upon vanishing points, which are spaced along your eye level. This simple principle applies irrespective of the angles of the object (in plan) or changes in the level of the ground. Of course, if there are slopes or ramps to draw, these are not level and hence have their own vanishing point above or below those for horizontal lines, depending upon whether the slope or ramp is angled up or down.

Single-point perspective is the easiest to employ in the field and the most useful for townscape and landscape drawing. It focuses attention upon the space rather than the object, and for this reason is a great aid when drawing squares, streets and interiors. The buildings or walls at

right angles to the observer are simply elevations drawn without angle to left or right. Single-point perspective suits the sketching of towns laid out on axial planning principles, or interiors with parallel corridors and plenty of right-angled spaces. Hence it is very useful for drawing classical compositions, whether in terms of buildings or whole towns. Since the streets are normally straight and often have terminating features at the vanishing point, perspective allows the artist to quickly construct the parameters of the drawing.

Two-point perspective tends to concentrate the eye upon objects rather than on the space between them. Both vanishing points must be on the eye level and are usually so widely spaced that they are off the sheet they are drawn on. There are no parallel horizontal lines with



4.5

The widely set vanishing points of this sketch of Charles Rennie Mackintosh's Hill House near Glasgow allow the rambling composition to be included on a single sheet.

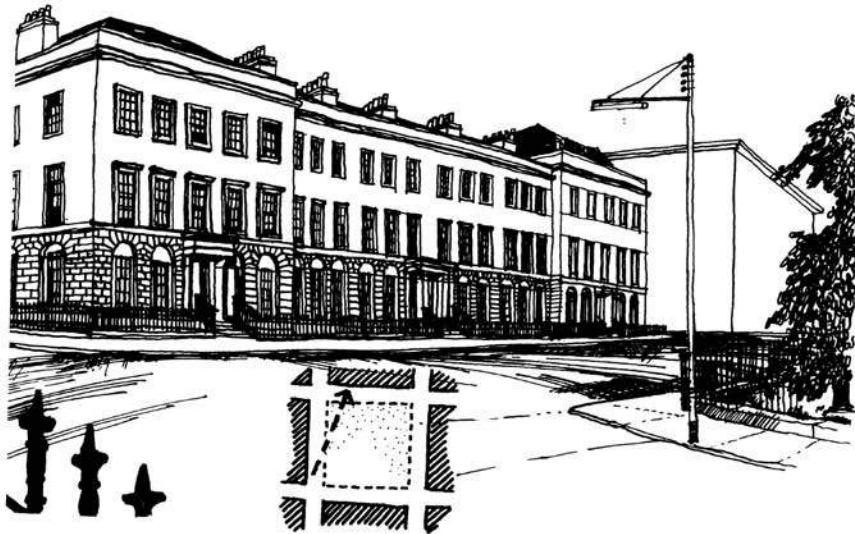

4.6

Two-point perspective focuses attention upon objects in space rather than on the space around buildings. Here in Blythswood Square in central Glasgow the composition retains its original arrangement.

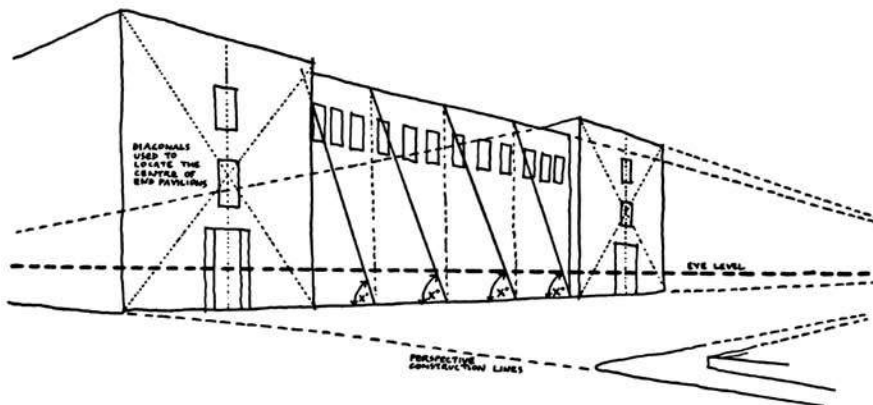

4.7

The use of diagonals and repeating bays allows the complex façade of Blythswood Square to be set down fairly accurately. The left- and right-hand vanishing points are off the page. Notice how the angle X° remains the same for the house's subdivisions.

two-point perspective (unlike single-point) and hence the artist has to concentrate a little harder on the drawing. A drawing with a landscape layout (i.e. horizontal) normally lends itself to two-point perspective, and a portrait layout (i.e. vertical) to single-point.

With complex towns or groups of buildings, several vanishing points have to be constructed, at least in one's mind's eye, because the differently angled buildings will all require their own vanishing point. Since constructing the vanishing points is time consuming, it is better to visualise where they are and check the angles in the field by using your pen or pencil as a guide. By holding the pen

at the angle of the wall or roof and bringing it down to the paper via an arc rotated about your elbow, you should be able to check the logic of lines in perspective against how they appear in reality.

Although perspective deals primarily in angled lines, it is useful to remember that the weight of line, darkness of shadow and strength of colour also convey the appearance of distance. As a rule, objects in the foreground should have the thickest lines, the darkest shadow and the brightest colour, while those in the distance should have the reverse – that is, faint lines, soft shadows and subdued colour. Attention to such detail not



4.8

The sense of perspective in this sketch has been enhanced by exaggerating the texture of the foreground steps. The telegraph lines also help with handling the sense of distance and change of direction at the top of the steps. The drawing is of Andraix in Majorca.

4.9

These high office blocks in Chicago exploit perspective in a vertical rather than horizontal direction.

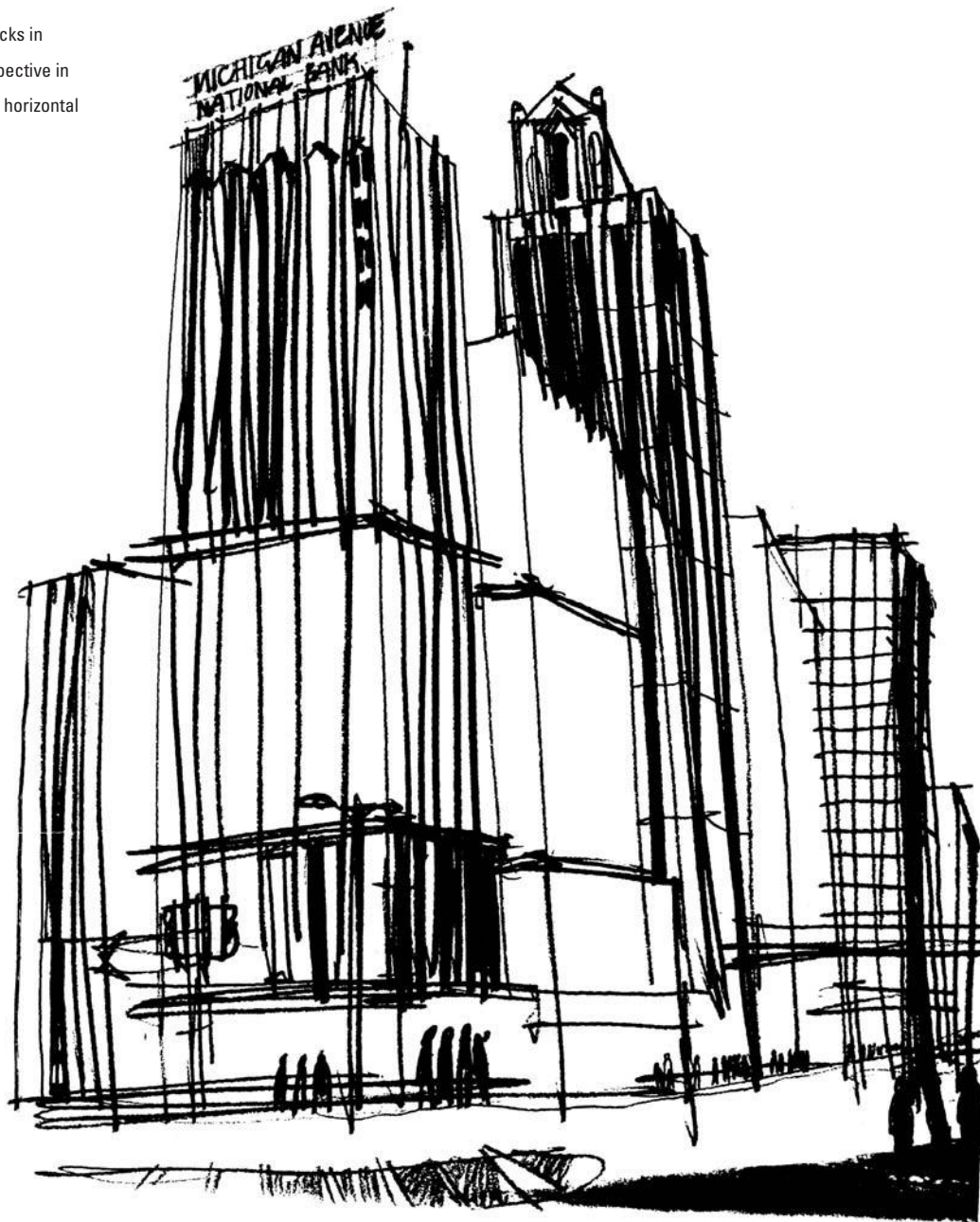



4.10

A grasp of perspective is necessary to achieve drawings of this difficulty. Notice how shade provides an essential three-dimensionality. The subject is central Birmingham as drawn by Francis Tibbalds. (Francis Tibbalds)

only gives the townscape sketch a certain subtlety, but helps reinforce the sense of perspective established by the angled lines.

There are some further useful tips to add to the lessons of perspective drawing. One concerns windows: those disappearing some distance down the street need not be drawn as compressed rectangles; a simple vertical line will suffice. Likewise, if the detail of, say, paving is shown in the foreground, it is quite unnecessary to attempt to show it in the background, and a mere hint will be enough in the middle ground.

If you are going to depart from full scientific perspective drawing with its complicated rotating picture planes (not only cumbersome to put into practice, but unrealistic in the field), then you will have to use your eye

to fix the depth of elements within the picture. The well-trained eye will in time prove as reliable as is necessary but you can assist it by using a pencil to establish the angle or proportion of height to width (in perspective). By holding the pencil and using the thumb as a sliding measure you should achieve accuracy to within 10 per cent, which is good enough for location sketching. However, once you have established the bay width or the depth of the building and are happy with it visually (your measurements should always be checked against how it looks), then you will discover that the angle of the diagonal will remain constant. This will allow you to tackle complex subjects such as street arcades or the column spacings in the aisle of a church.

Diagonals can also be used to establish the centre of a wall or building in perspective. By striking both diagonals lightly in pencil (or just fixing them in one's mind), the centre is quickly obtained and hence other information such as the spacing of windows or location of a door can be added, knowing that the basic layout is correct.

The choice of eye level is important in perspective drawing. If you are interested, say, in the skyline of a tall building, then it pays to take as low an eye level as possible and render the silhouette of the top dark against a light sky. This is how the perspective artists of the 1930s presented their brash new skyscraper designs. Alternatively, if you wish to look 'into' the subject, try to use a high eye level so that you can delve down into the streets and spaces and show how they relate to each other from this angle. When portraying a very tall building or lofty interior from a viewpoint where you are gazing upwards, remember that there is a vertical vanishing point pulling the lines together high over your head. Such a drawing is really in single-point perspective, with you turned through 90°.

An understanding of perspective is a great aid to those intent upon drawing architecture and towns. However, try not to allow the rules to dictate your every move, for spontaneity and flair can be driven away by too slavishly following the academic conventions of perspective. Some recent graphic artists such as Paul Hogarth have deliberately broken such rules in order to arrest the eye and encourage it to dwell upon the subject longer. They have developed a system of superimposing objects in space, which accords, to some extent, with Oriental concepts of perspective. However, be aware that if you break the rules of perspective a naivety creeps in that may undermine the overall appearance of the finished sketch, no matter how finely the details are rendered.

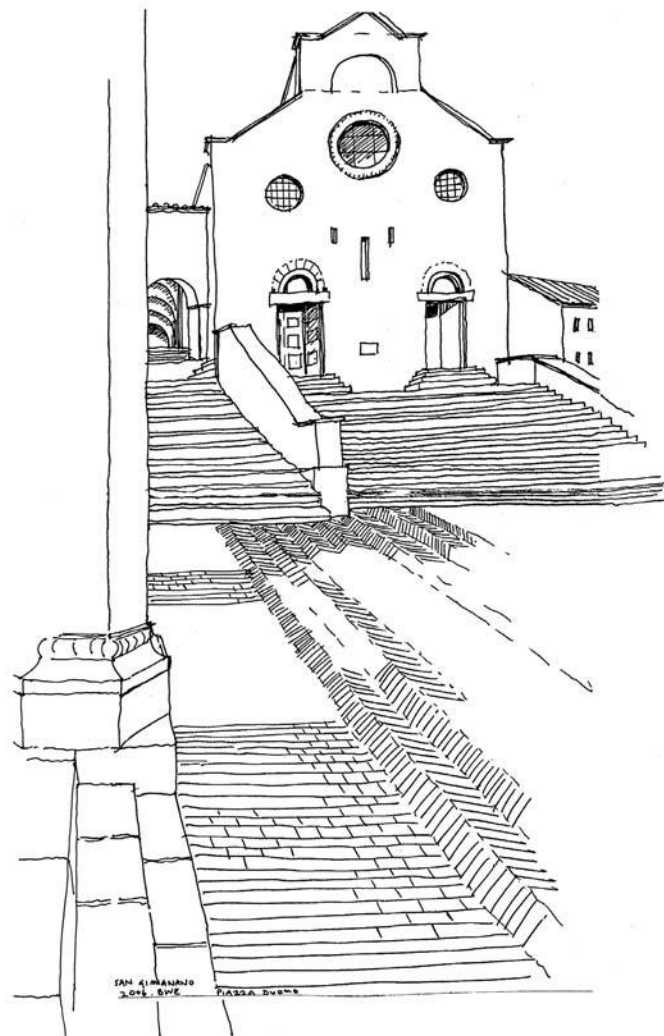

4.11

This drawing of the Piazza Duomo in San Gimignano shows the attention to detail common to Renaissance Italy.

Chapter 5

Line and shade

Sketching the outline of objects can lead to rather featureless and abstract drawing. Although one may recognise the shape of a house, its value to us as an object is determined by issues of form, texture and arrangement. These qualities are best represented not by line alone, but through line and shade.

Shade gives a sense of three-dimensional reality to two-dimensional shapes. The convention is simple: select a direction for a source of light (often imagined) and shade the sides of the object pointing away from the light source, drawing the shadow cast on to the ground and other surfaces. Your simple outline will then become alive with form, structure and surface richness. The more the building or object is modelled in plan or section, the greater will be the complexity of shade and shadows.

This convention becomes a reality when you draw on sunny days (mornings or afternoons are the best times to take advantage of angled light), but you can invent a source of strong light if it is not present. Ideally choose sunlight coming over your shoulder (preferably your left one) at an angle of 45°. This will make the dullest power station or comprehensive school suddenly dance off the page.



5.1

A simple line drawing is a good starting point for architectural exploration. Here a sketch plan is used to supplement the drawn view of Aylsham Church in Norfolk.

5.2 a, b, c and d

These four sketches of a Victorian terrace of seaside flats in Dovercourt, Essex, show how a line drawing (a) can be enhanced by stippled shading (b), hatched shading (c), and dark pencil tone shading (d). In each case the formal composition is enhanced by shading.



(a)



(b)



(c)



(d)



5.3

This pen drawing of the pioneer village of New Lanark, Scotland, uses shade to express the pedimented gable and to focus the eye upon the cupola.



5.4

Shade, shadow and perspective have been used to exploit the dramatic composition of this church square in Gaeta in Italy. Notice how the columns impose an enormous scale on the space, and how cafés enliven the perimeter of the town square.



5.5

Simple pencil shading brings alive the three-dimensional qualities of the urban spaces in central Prague (near the top of Wenceslas Square in this instance). Here a distinction is made graphically between object buildings and the background architecture of the city.

Many eighteenth- or nineteenth-century buildings employ cornices, string courses and window margins in order to create panels of walls and frames to highlight key architectural elements. The presence of these features can be emphasised in the sketch by exaggerating the play of light and shade on the façade. Similarly, modern buildings with their exposed structure and service runs also benefit from the use of this graphic technique. When drawing urban space or landscape design, shade and shadows create a necessary sense of substance to things such as dwarf walls, hedges, trees and sculpture.

By placing elements in front of each other, shadows can be cast from one object on to another. The layering of objects in the picture not only enlivens the composition, but adds spatial complexity to the subject. Elements

placed in front of a building such as lamp-posts, telephone boxes or trees give a sense of depth to the sketch and allow shadows to pass along the horizontal surfaces and up the vertical ones. By such means the distances in plan between object and observer can be expressed and exploited graphically.

The function of shadows is, therefore, to make you aware of the depth within the view: they give flat two-dimensional subjects a semblance of reality. The rendition of shadows follows similar conventions to those of perspective. As a rule, darker shade and stronger shadows should be in the foreground of the sketch, becoming progressively lighter as they move into the distance. This has the effect of reinforcing the illusion of perspective.

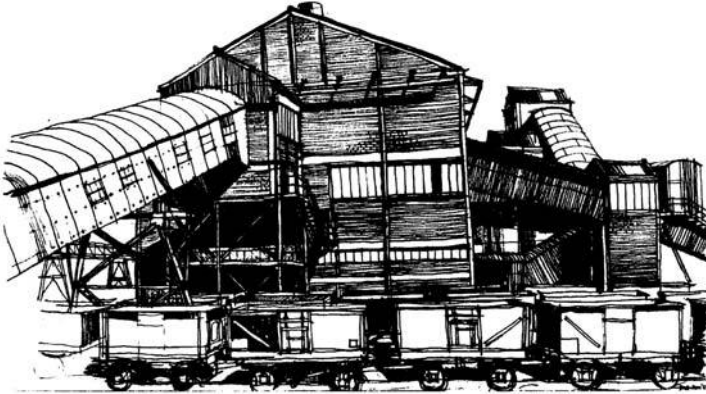

5.6

The use of shade and shadow enhances the sculptural qualities of this coal mine at the Snowdown Colliery in Kent.

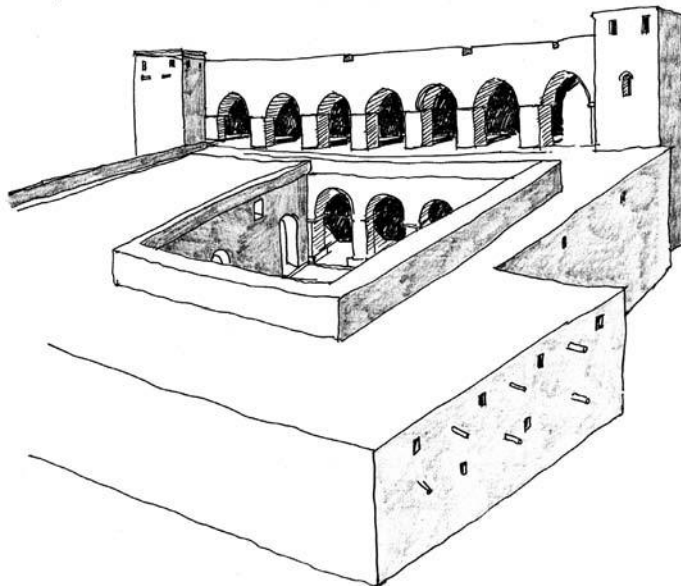

5.8 (left)

Shadow and shade are used here to highlight the sculptural quality of this large courtyard house in Baghdad, Iraq.

5.7 (above)

Line and shade are used to distinguish between dressed stone, rough stone, render and slate of the Royal Mil in Edinburgh.

Chapter 6

Composition

6.1 (opposite)

This street scene in London benefits from details such as market stalls and a stripey canopy. This fine drawing (dated 1992) by Francis Tibbalds has layers of interest which help inform the subject. (Francis Tibbalds)

An appreciation of composition is particularly important when drawing buildings and cities. The abstract nature of architecture means that sketches have to be well composed, otherwise the finished drawing may lack appeal, or fail to communicate the qualities that attracted you to the subject in the first place.

Generally speaking, the subject of the drawing should occupy the middle third of the sheet, not centrally placed, but perhaps positioned on the basis of the golden section. The proportional harmony of the golden section can enhance the drawing and give the subject a feeling of repose on the sheet. The subject can, of course, be in the foreground, middle ground or distance. It often helps, however, if the main object of the sketch is in the middle ground with foreground detail such as paving and background silhouette used to establish layers in the drawing.

Since buildings are made of materials of known size (bricks, blocks of stone, curtain walling, etc.), the opportunity often exists to exploit the rhythmic patterns they create. By considering the position of elements in the drawing it is often possible to create interesting arrangements that take advantage of the relative scale of the different building materials. Moreover, as we are all familiar with the dimensions of a standard brick, the use

of patterns of brick courses quickly establishes a sense of scale within the sketch.

Often it is possible to fill an area of the drawing with brickwork or tiling, and this can provide a texture to set against more detailed line work of, say, a Georgian window or doorcase. The juxtaposition of line, shadow and texture can make an attractive drawing, and it is worth taking time before starting the sketch to find a good combination of these elements. A little licence may also be permitted in rearranging the parts or extending (or exaggerating) the area of brickwork in order to produce a more satisfactory final drawing. Remember that good composition may also have been the architect's or town planner's objective, and that your sketch is simply bringing out elements of the town scene that already exist, though perhaps looking slightly different in reality.

A good sketch should have layers of information and meaning. By setting elements into the foreground, especially those that give local character, you can convey the atmosphere of a street or urban area. Such details as post boxes, seats or advertising signs can be placed in the foreground, and this not only improves the composition of the sketch but can also give it extra complexity and richness. Remember, too, that knowing what to leave out is also important. Unlike the literal documentation of the





6.2

This sketch of a street in Florence focuses upon the walling elements and surface textures. The use of shade and shadow helps enhance the appearance of three dimensions, thereby better expressing the main architectural components. Unnecessary detail has been left out.

photographer, a drawing permits the artist to exercise a discerning eye, adding or subtracting detail to the benefit of the sketch.

Building designers play with various ingredients to produce a satisfactory piece of architecture. They have proportion, colour, outline, texture, harmony, shadow and framing at their disposal. Likewise, artists should seek out these qualities within the object or subject they are tackling, and exploit them in the drawing. After all, there is no better way of getting to know a subject than drawing it, and no better way of remembering what it is really like beneath the surface appearance.

Some modern buildings are highly abstract in appearance and often rather minimal in detail. These buildings derive from the legacy of the International Style,

which began in the 1920s and put machine production and functional logic before craftsmanship or individual human needs. Such buildings require a different approach to being rendered through architectural drawing than do more traditional townscapes. Here you will find a ruler useful and perhaps a circle template, and the use of dark shade and dramatic highlighting may also be helpful. Similarly, small areas of bright colour may enliven the drawing, and give a dull building a focus of interest. Whatever drawing technique is employed, it is important to think hard about composition before starting to draw, and to try to enter into the spirit of the period of the subject before putting pencil to paper. An abstract modernist building may well suit a cool, almost cerebral, style of drawing. On the other hand, a Brutalist building of



6.3

By placing the 'subject' of the sketch (which here depicts the Merchant City, Glasgow) near the top of the drawing, the spaces which form the context and public realm are also described.



6.4

This drawing of the semicircular portico to Bramante's S. Maria della Pace in Rome leaves much detail out in order to express the framing of the doorway and the clash between curved and straight lines.



6.5

The cliff-like structure of the ferry Norland is broken up by the angled lines of mooring ropes and access gangway. Placing the bollard in the foreground adds to the layers of interest, which reinforce the nautical theme of the sketch.

the 1960s, with a rough-textured concrete façade (as on the South Bank in London), would lend itself to a charcoal or a pencil drawing using a 6B to bring out the graininess of the surface. Architecture of whatever period has always attracted the artist, and modern buildings are no exception.

It is useful to try to relate the compositional arrangement of the sketch to the theme of the subject. Should you be drawing a city church faced by a square, then both church and square should feature in the sketch since both are probably there in support of each other. In Europe most cathedrals and many town churches are fronted at their west end by a square, and it would be foolish to draw the church without at least hinting at the presence of the square. Consequently, your composition should

provide space for both, perhaps with church and square linked by single-point perspective. As the square will probably be paved over and perhaps edged with clipped hedges or statues, the artist has elements around which to build up an attractive and well-constructed picture.

The relative positioning of the different elements, the weight of line and tonal value of each, are all important considerations and should be planned in advance of starting to draw. There is nothing worse than spending a great deal of time carefully drawing an ornate Baroque church to find that you have not captured the spirit of the place through not considering the composition of the picture with due care. Remember that a degree of abstraction or restraint is important – you cannot draw



6.6

The Beacon Hill area of Boston, Massachusetts, contains fine 19th-century houses and squares. Here railings and a fire hydrant add foreground interest and give the sketch a complexity which a study of building façades alone would lack.

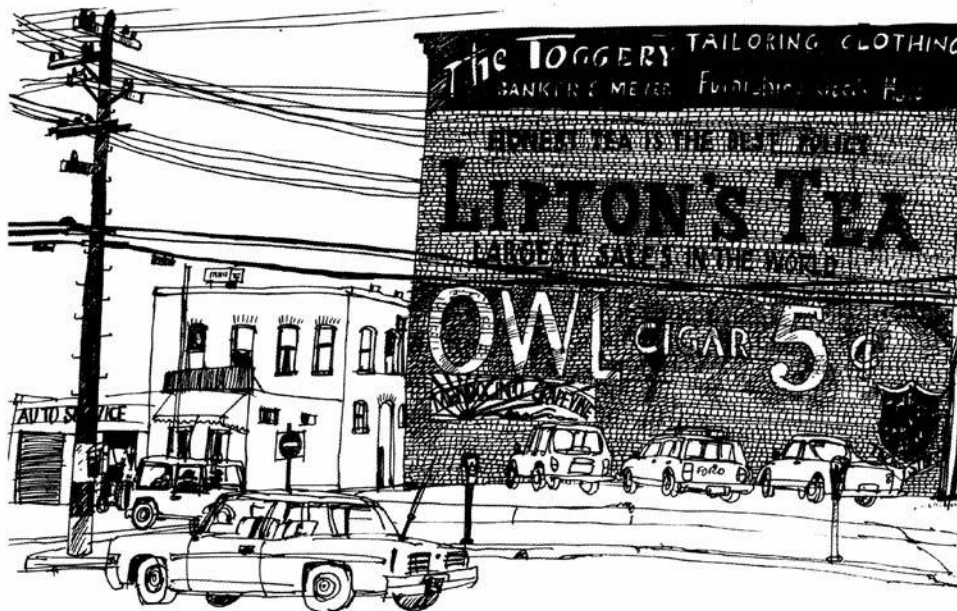

6.7

This sketch of an advertising gable in Ukiah, California, uses the telegraph pole wires and parked cars to add further layers of meaning or character. The nature of American urban design was the starting point for this descriptive drawing.

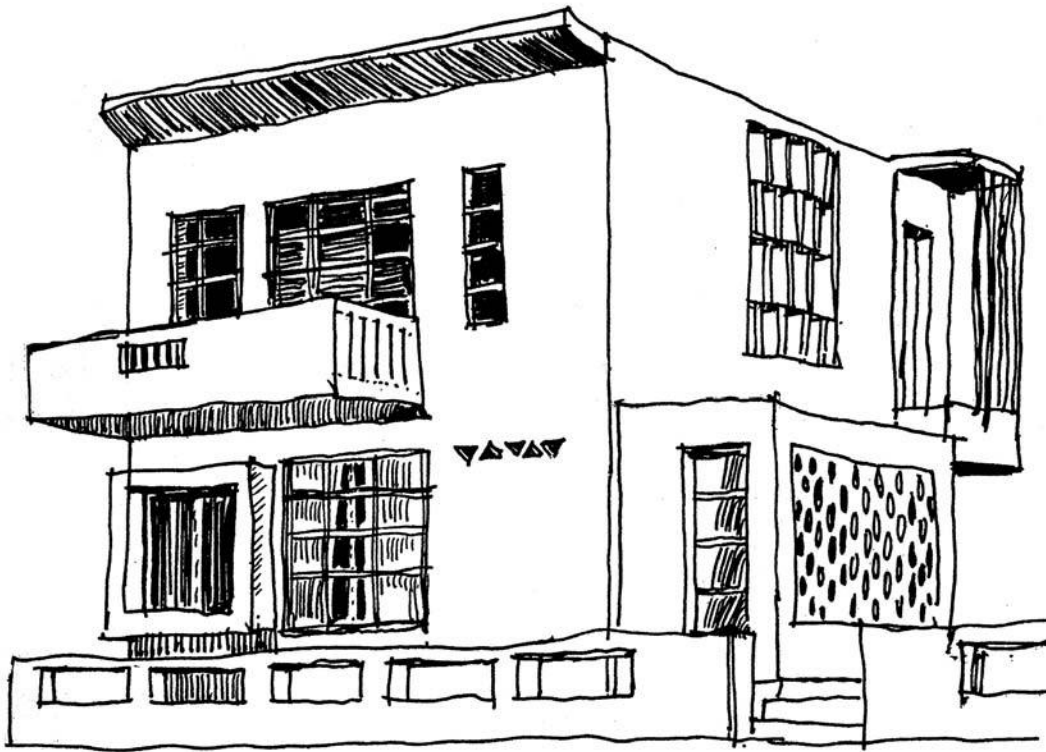

6.8

Modernist buildings often express their design ambition with great vigour.

everything, and to select the focus of attention at the outset is vital. This should prevent you from over-working the subject and ending up producing what amounts to a second-rate photograph.

Since the most prominent features of a building are those that form a frame (doors, windows, trusses, gateways), you should incorporate these into your picture. As we move through a building, we have an impression of prospects opening out of bigger rooms viewed through narrow spaces. The transition between rooms is often marked by a doorway that is deliberately framed. Since we experience architecture by passing through these framing elements, they are very much part of the scene and therefore cannot be ignored. Indeed, successful sketches frequently tantalise the observer with a glimpse

of a distant, and sometimes mysterious, world through such 'frames' – the view through the solid gateway of a medieval town being a good example.

As with all great buildings or fine cities and landscapes, there needs to be an element of complexity and richness in the freehand drawing. Such complexity can be set against the plainness of unadorned surfaces to heighten the drama of the sketch. Alternatively, any repeated surface decoration can establish a rhythm or beat as in music. Searching out such compositions can result in well-informed drawing that not only sustains our attention but also teaches us something about the nature of the place.

As mentioned already, the positioning on the page of the main subject of the sketch is important. A sketch can

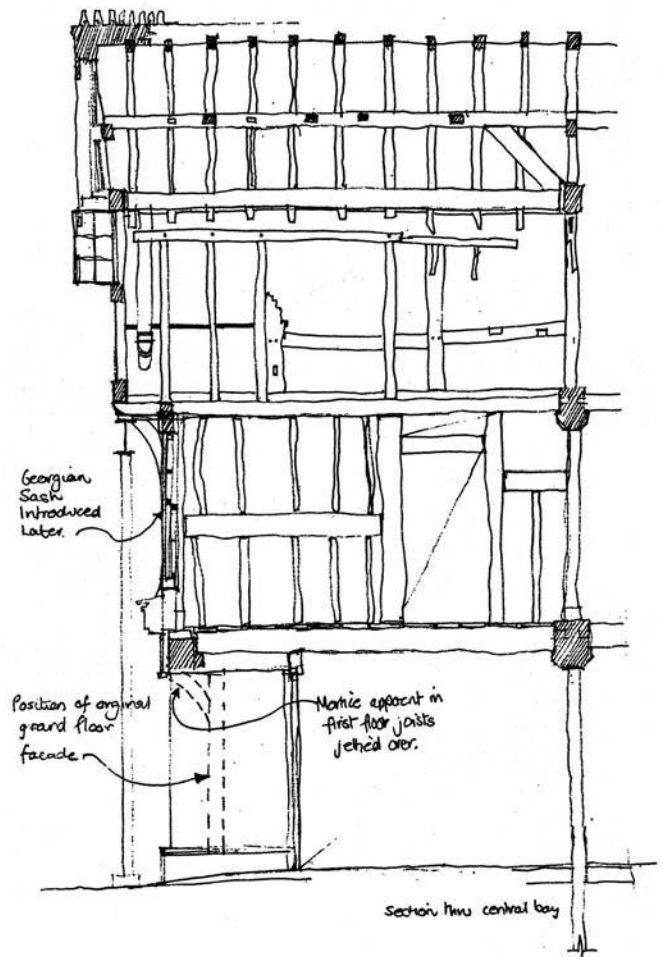
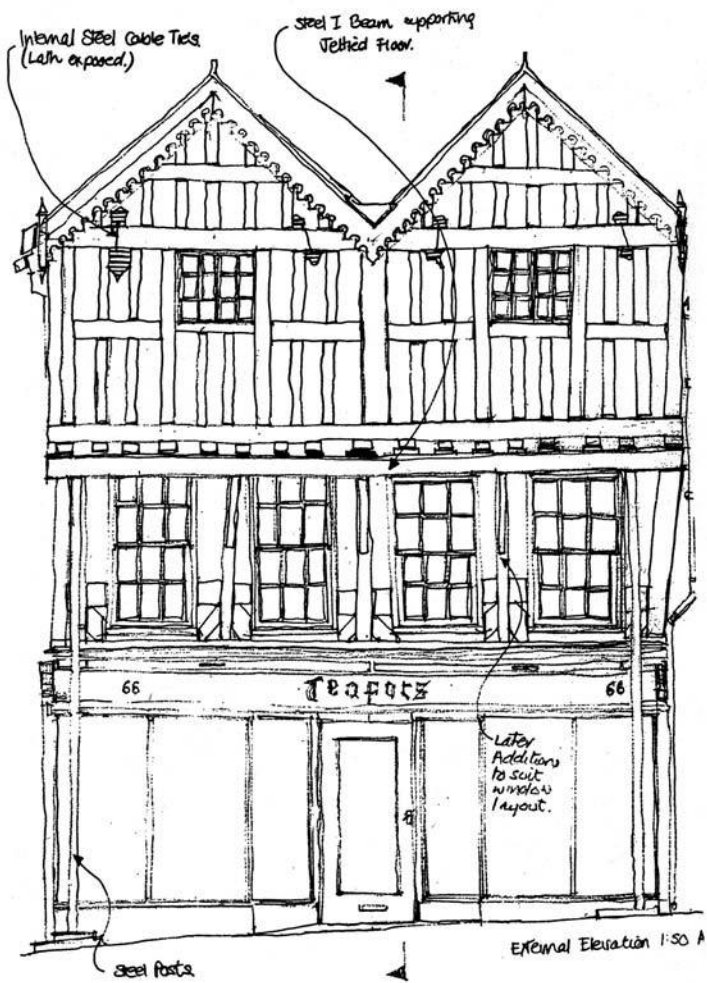

6.9 a and b

These studies of a medieval townhouse in Gloucester by Nick Hirst are finely composed on the page. Notice how the section to the right provides a perfect balance to the façade study on the left. (Nick Hirst)

be either landscape (horizontal) or portrait (vertical) in layout, depending upon whether a panorama or, for instance, a street scene is preferred. Panoramas of cities can be dull affairs – just a collection of roofs and towers – though vertical elements such as columnar cypress trees, factory chimneys or masts can be used to offset the stretching horizontality of the subject. Likewise, street scenes may require some horizontality or shallow-angled lines to counter the tendency towards the vertical. In both cases you should search out shapes and lines to balance the dominant ‘direction’ of subject or layout.

To return to the subject of the town church; if you wish to draw the square in any detail then it is necessary to place the church towards the top of the sheet. This will allow you to pull the lines of the square and its paving towards you, thereby giving the impression that you are looking both ‘into’ the space and ‘at’ the church. This type of drawing establishes a dialogue between object and space, and allows you to consider how the square is used and decorated.

Often a good sketch consists of leaving large areas of the sheet relatively unrendered. A mere hint of lines is usually sufficient and the openness of approach on one part of the page can enhance the level of detail elsewhere. A common mistake is to draw to the same level of intensity right across the sheet, thereby removing the opportunity for tensional conflicts. Since traditional architecture plays on such tensions (for example, the contrast between a decorated entrance doorway and a plain area of wall) and modern architecture often ignores them, a perceptive drawing should seek to exploit these differences.

Try, if you can, to compose your drawing around powerful lines of force within the sketch. These may be the vertical ribs of an office block, the diagonal grid of a steel-framed bridge, or the flowing lines of forestry planting. The structure of a drawing should consist of

these dominating linear forces being mediated by secondary lines or areas of shadow. If possible, seek a balance between the primary and secondary elements, or at least soften the harsh linearity of most architectural subjects by drawing in surface pattern or texture.

The inclusion of such elements as people, cars or vegetation helps to counteract the rectangular or linear forms of buildings. The degree to which these secondary elements soften the sharp outlines of architecture depends upon the subject and the effect sought. You may wish to add complexity and contradiction to the subject, or simply accept the realities of a highly engineered environment.

The play between horizontal and vertical lines, and between hard and soft elements, can be developed into triangular groupings on the sheet. By having three points of interest the picture is more easily composed. Instead of, say, the unresolved dominance of the towering lines of a skyscraper, the drawing will have a repose, which may suit certain subjects. Triangular framing does require rather more than a simple sketch; the artist is now moving towards a more detailed drawing, perhaps as a prelude to easel painting.

As so much urban drawing deals with the façades of buildings, the artist should try to add interest to the drawing by giving the observer a sense of looking both into the spaces of the city and at its buildings. The effect can be achieved by pulling the lines of a street or square towards the observer, thereby creating space that is ‘entered into’. The tension that results from the city as ‘elevation’ and the street as ‘stage’ can lead to a sketch rich in ideas about the nature of urban design.

6.10

Landscape often provides a better opportunity to compose a drawing than townscape. The patterns in this Tuscan landscape are all man-made and could be turned to architectural effect.

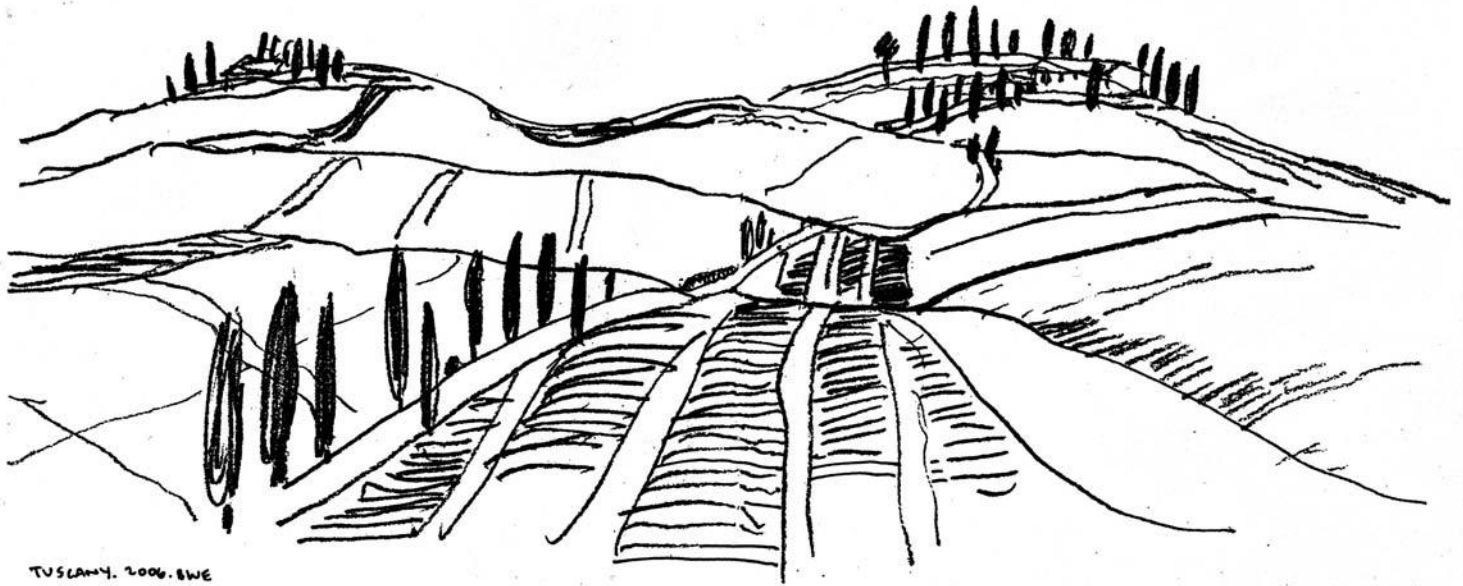

Chapter 7

The importance of practice

The co-ordination of hand and eye is a necessary starting point for freehand drawing. It is only through frequent practice and by following sound principles that the facility to draw without hesitation or uncertainty can be attained. The fluid, confident lines of an accomplished draughtsman are achieved as the result of much practice. This book does not pretend to teach drawing, only to encourage its use as part of the design process. Like the acquisition of all skills, training and self-discipline are as important as the possession of natural talent.

Practice does not require that you spend your time entirely on location drawing. The home and the design studio or workshop provide ample opportunity to develop eye-to-hand co-ordination or to test the rules of perspective drawing. By looking at the outline of the subject and infilling part or all of the detail – whether it be a drawing of a chair or cup and saucer – you will quickly develop the basic skills necessary for sketching in the street. The importance of spontaneous, relaxed drawing cannot be overemphasised. While you might be concentrating on organising the angled lines of a scene into a sound perspective framework, the fact that you are sketching at all is of the greatest importance. Unlike the first notes on a piano or trumpet, the artist's scribbles are largely a private affair and should not disturb the

household. It is remarkable how quickly most people graduate from producing primitive, inhibited sketches to lifelike representations.

It is important that you approach drawing from both ends – from the personal, idiosyncratic angle, and from the point of view of academic skill. The latter concerns questions of perspective, composition, shade and shadow. By developing both a personal style and a good grasp of basic principles, it should be possible to produce drawings that are lively and informative. Architectural sketching benefits from both a strong individual approach to the subject and the necessary graphic techniques to relay the private vision satisfactorily.

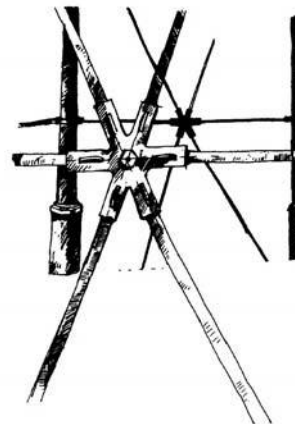

7.1

Small subjects can be a useful starting point in learning to explore through freehand drawing. Here a fragment of structure from the lighthouse at Dovercourt forms the basis of the sketch.

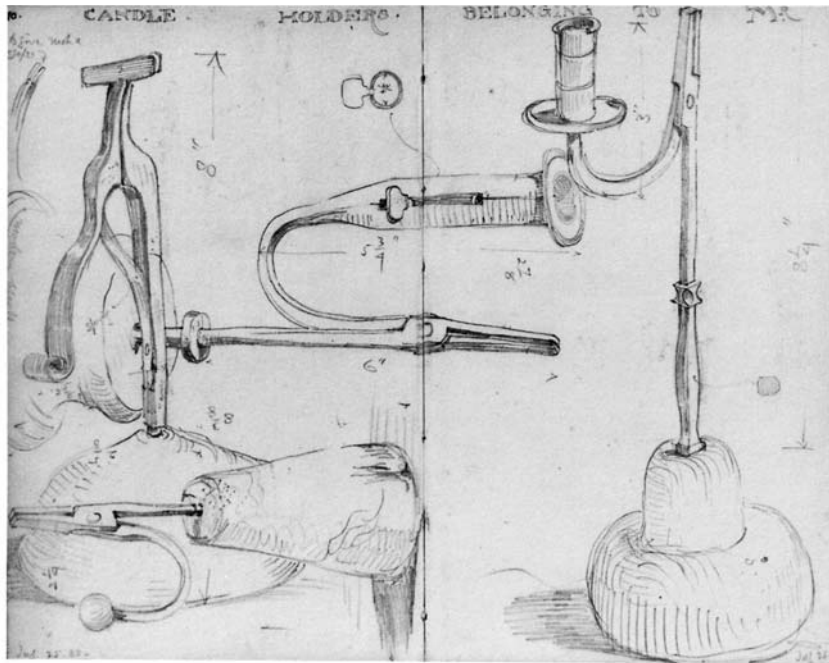

7.2

Edward May's sketch of candleholders is the type of subject which lends itself to a practice exercise. May's facility for drawing was, no doubt, acquired as the result of many such sketches.

(RIBA Drawings Collection)

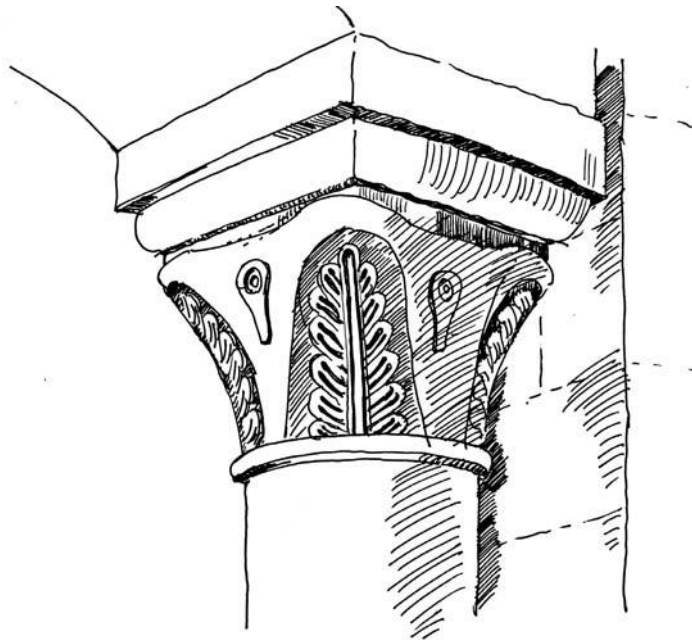

7.3

Sketch by the author of a column capital at Dumma Goulia in Homs, Syria. The decoration is based upon the palm leaf.

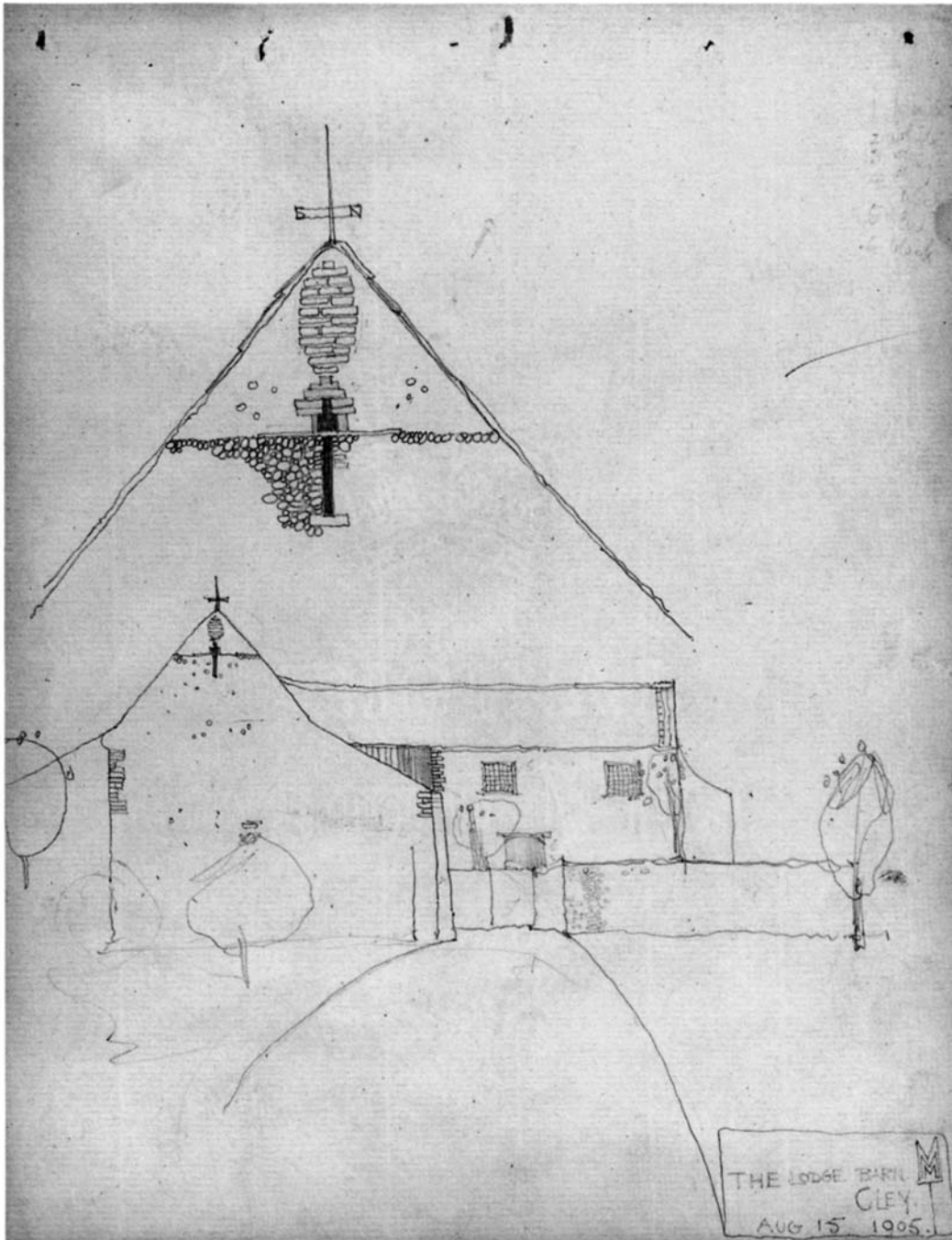

7.4

This sketch (dated 1905) by Mackintosh of a hall at Cley in Norfolk edits out features in an attempt to interpret rather than merely describe the scene. The artist's facility is achieved as the result of practice and a critical approach. (Glasgow University: Mackintosh Collection)

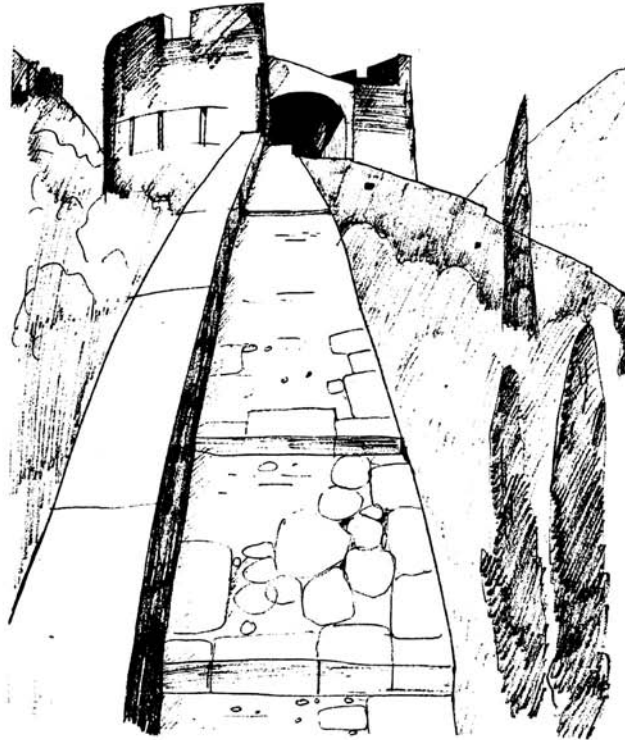

7.5

A degree of abstraction helps when rendering difficult subjects, as in this sketch made near Dubrovnik.

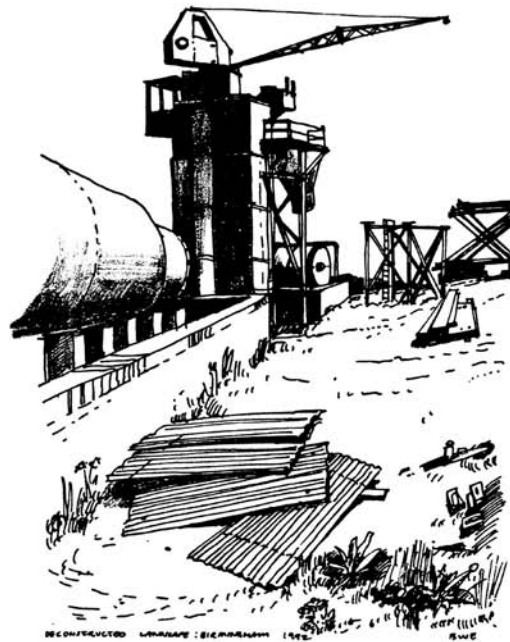

7.6

Derelict industrial areas (in this case on the edge of Birmingham) provide much material upon which to practise different drawing techniques.

Chapter 8

From sketch to plan making and documentary investigation

Sketching may on occasion be supplemented by drawing quick plans or sections. The sketch is a useful and enjoyable tool, but there are occasions when more analytical drawings are required. Although a sketch can indicate the position of a doorway relative to the rest of the façade, it cannot show the importance of the door with regard to the plan of the building. Here you will have to resort to preparing drawings of a more technical nature.

As with sketching, there are a few useful tips to bear in mind. If you are going to measure the subject, get someone else to hold the end of the tape measure, and preferably a third person to read out the dimensions. Your task will then be that of drawing and recording the measurements. Any plan prepared in this way should have the sketch plan, section or elevation drawn at the same time as the measurements are taken, and ideally at the same scale.

Height often poses a problem, but you can triangulate the subject or alternatively use a staircase (if you have access to the interior) to take a vertical measure. Sometimes you can count the number of brick courses, assuming they are laid at four courses per foot. If these fail, then it is possible to take an informed guess on the basis of 9 feet (2.7m) per storey for an ordinary house

(allowing for the type of construction) and 15 feet (4.4m) for a grander building.

The sketch plan does not have to be dimensionally accurate to contain useful information. The fact that the building is square in plan, or that a city street is the same width as the height of houses enclosing it, is more important than mere dimensions. You may be able to pace out the dimensions of the building, on the assumption that your step is about 3 feet (0.9m), or determine the height of doors by your reach.

Approximate plans are used to supplement the sketched information and to help bring some aspect of the design into clearer focus. After all, you are sketching to learn about the built environment, and learning does require a disciplined approach. With townscape sketches, a quickly drawn plan of the figure-ground (the relationship between the solids of buildings and the voids of streets and spaces) helps explain the geometry or pattern evident in your view. It may also encourage you to draw from another point in the street, thereby helping you to reach a real understanding of the often complex spatial interactions in an urban scene.

Assuming you have prepared a sketch and supplemented this with a plan or section, then you may decide to take your investigation further.

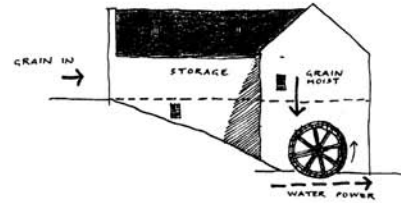
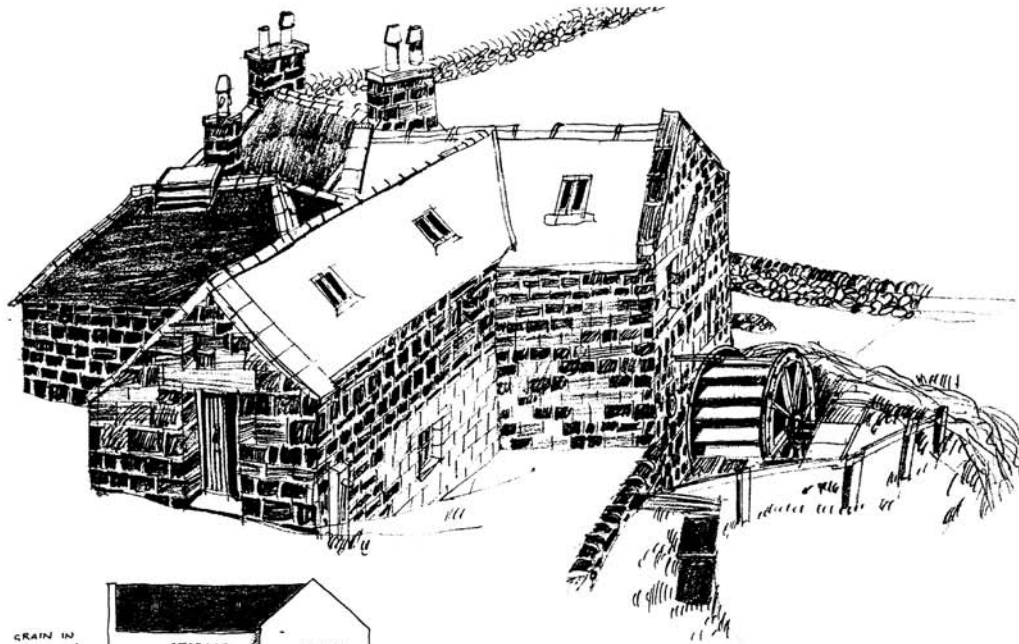

8.1

Flockerton Mill, Douglas, in Scotland, is typical of early industrial architecture. The sketch shows the general arrangement but other drawings, such as the section, are required to explain how the various buildings work.

8.2

The sketch of the Royal Crescent in Bath is supplemented by a plan drawn at the time from memory. The exploration of the geometry of the volumes at an urban level was the reason for the drawing.

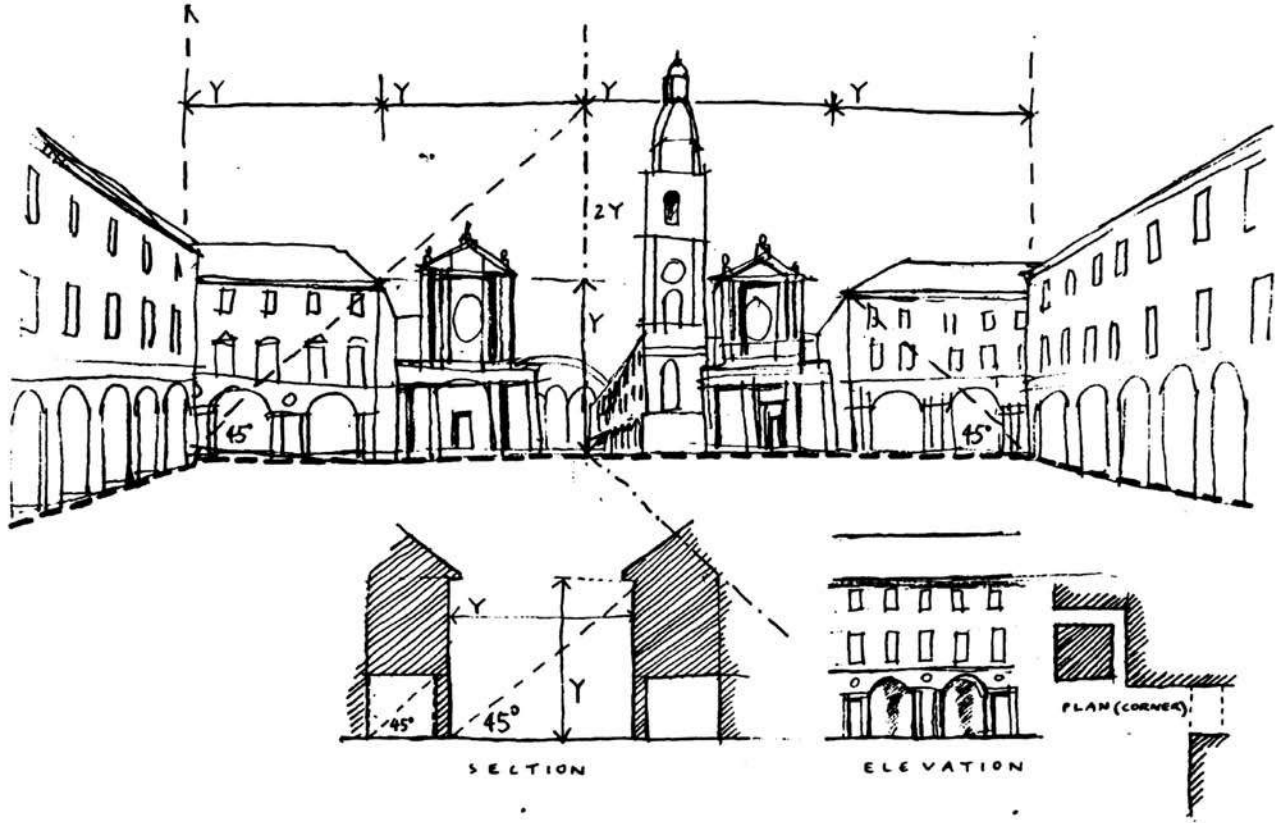

8.3

This sketch, based upon field notes and town plans, shows the proportional system employed at the Baroque Piazza San Carlo in Turin. Plan, section and elevation have all been employed to highlight the relationship between the detail and the whole.

8.4

Figure-ground drawings

prepared from a good map can show the relationship between the solids (buildings) and voids (spaces) of the city. Here an area of London Docklands is shown with the lack of connections between old and new communities manifested through the drawing technique.



8.5

This plan sketch by Sir Nicholas Grimshaw for the Berlin Stock Exchange seeks to show how the rhythms of construction and the urban context are reconciled. Notice how the rotunda forms a public space at the entrance.

(Sir Nicholas Grimshaw)

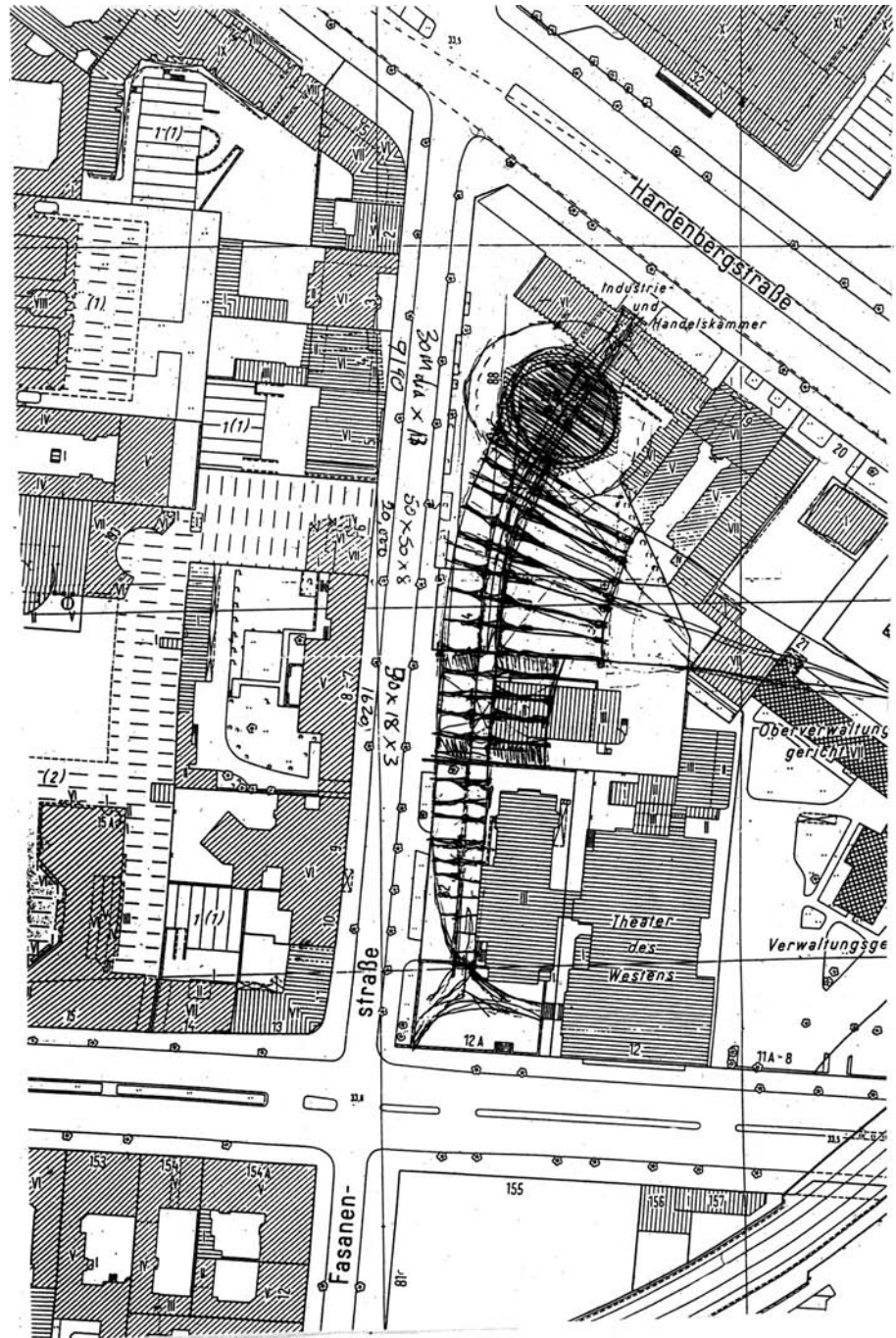

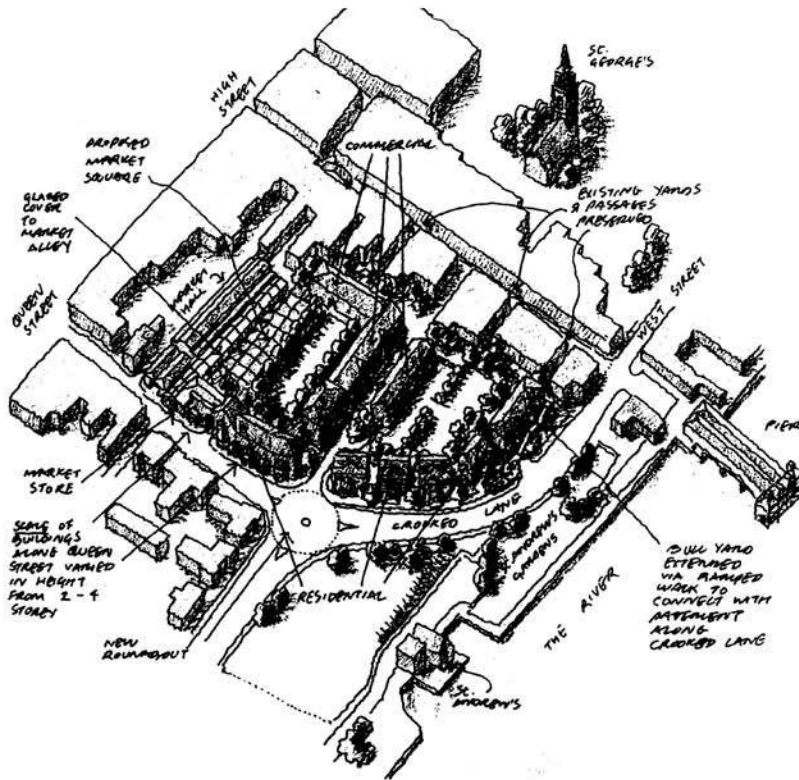
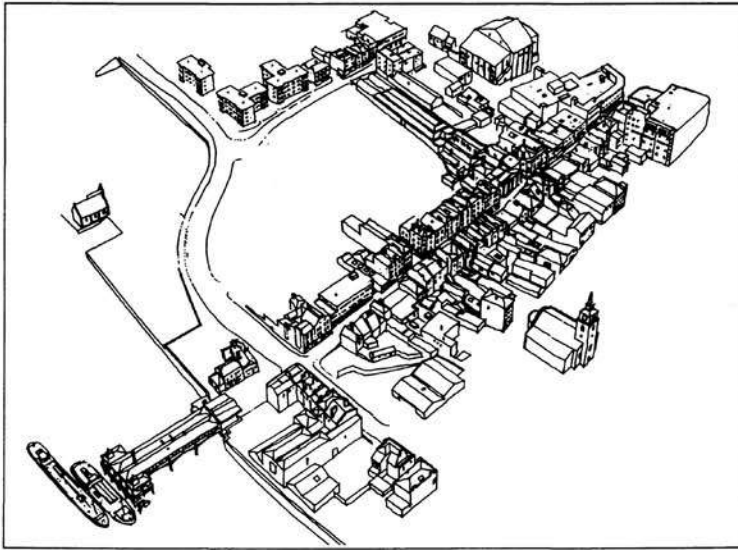

8.6 a, b and c

These studies of Gravesend in Kent by Richard Reid move from sketchbook drawings to more analytical explorations and broad design proposals.

Local libraries will probably contain documentary records about the date of the subject, or other information that can enhance your understanding of the area you have studied through the sketch. Inquiry through graphic analysis is a useful means of cultivating an appreciation of an area or subject, particularly if it then leads to a search through archival records or historic plans. This may not suit everybody's needs, but for a school or college project the bringing together of graphic and written sources is a useful educational tool.

Just as in your freehand drawing, the weight of line must be used to help explain aspects of the plan. The sketch plans are meant to communicate and thus should abide by accepted norms of technical drawing. Hence the most important information (such as the position of the walls of a house) should be rendered in the thickest lines and deepest tones. If the garden fence and structural walls have the same weight of line, then their relative importance is obscured. Likewise, the presence of mouldings on the front façade may be important to understanding the proportional rules that the original architect employed (as with a Georgian house), and this fact can be drawn to the attention of the viewer by your selection of an appropriate weight of line. The presence or absence of lines and their relative weight are as important as the presence or absence of words in a report.

Your sketches and plans are really records of facts or your interpretation of them – they are not mere speculations or whimsical invention. If you wish to move into design changes, then your inventions should be clearly indicated. The progression from sketch as record, plan as description, and design drawing as proposed change is an accepted method of proceeding. But it is important that should you mix all three together on a single sheet, then this fact should be communicated to those who look at the drawing. Similarly, records of fact

and matters of interpretation should be clearly marked as such and not combined in the same graphic language.

The intention is to supplement the sketch with other relevant information. Your need for additional material will in all probability stem from a practical consideration such as curiosity about how the building is constructed, how the landscape is formed, or the design put together. Hence, the initial sketch – itself probably the result of a need to admire or record – leads to further inquiry that takes you from the sketchbook to the notepad and perhaps to the local archive office, planning department or library. Seen in this way, the sketch is part of the process of understanding, not an end in itself

Through the sketchbook we may learn to appreciate objects and places for what they are, and as designers intervene in a more informed and sensitive fashion. Because the sketchbook requires our concentrated involvement and can lead outwards into the further investigations mentioned above, it is a great deal more useful than the camera. The camera can only record – it cannot edit, select or interpret. A trained photographer may use the camera creatively, but its educational benefits are limited. By encouraging us to become more visually literate through the countless photographs produced each year, the camera can have the adverse effect of focusing our attention upon the superficialities of subject and form, rather than upon their underlying structure and meaning.

8.7

The investigation of urban landmarks in Manchester forms a starting point for Sir Terry Farrell's Green Building (see Chapter 18).
(Sir Terry Farrell)

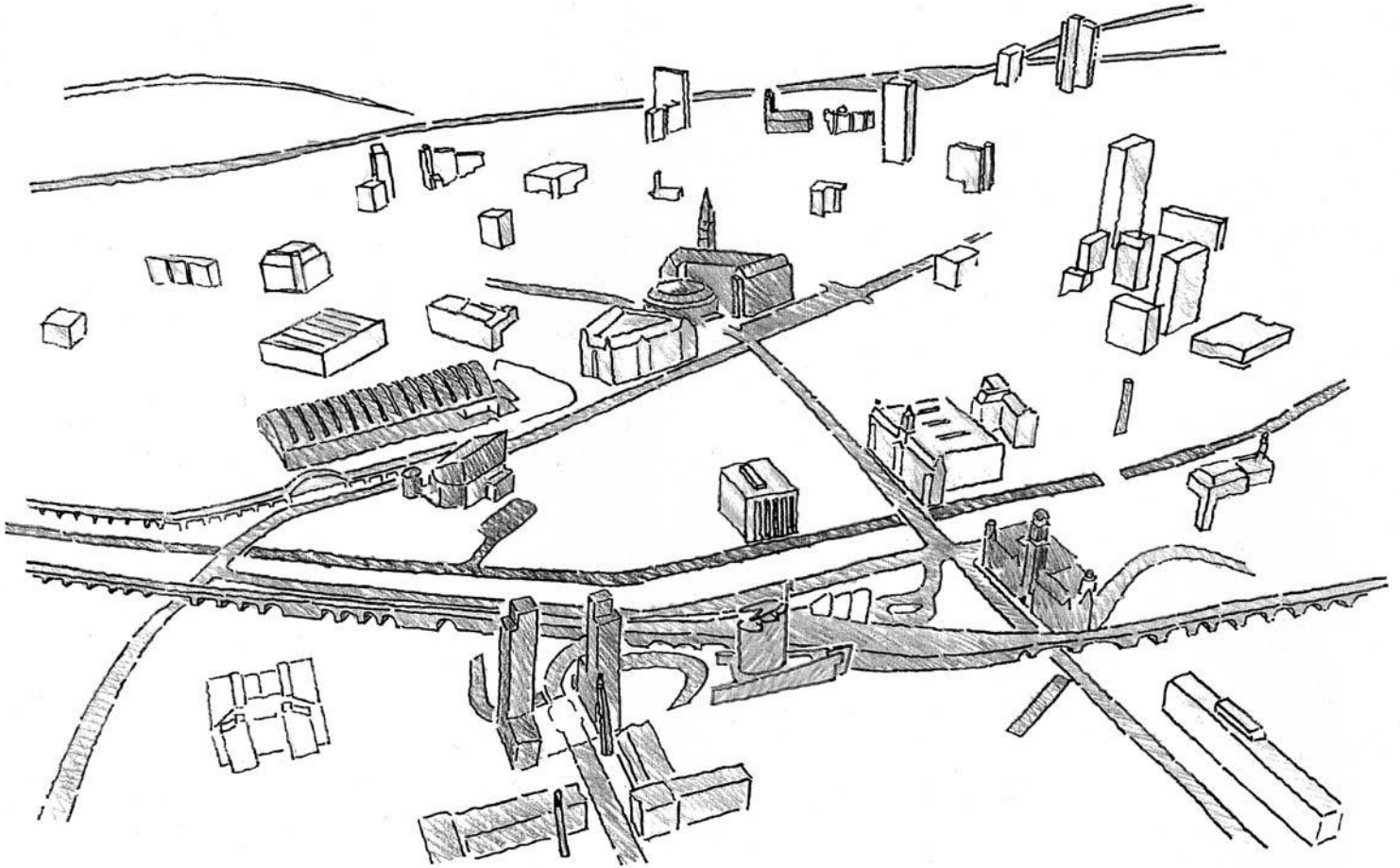

Chapter 9

Sequential sketches

Sketching is about exploration, about learning to see places and architecture through the graphic experience. As such, the architectural illustrator is concerned with interpretation rather than mere description, and that interpretation must contain elements of critical judgement. A common mistake is to draw too literally and to seek representation from one viewpoint alone.

To reach a real understanding of 'place', you need to walk through it, thereby experiencing the changing geometries of the urban scene. Sketching can be a useful aid to urban analysis as long as the viewpoints are chosen with some thought. The most rewarding urban spaces often revolve around a public monument where a mixture of squares, streets and lanes provide a range of spatial patterns. As you move through the different volumes, you become aware of large and small spaces, enclosed and partially enclosed ones, connected and unconnected ones. The beauty of many towns, particularly historic ones, lies in this variety and in the unexpected delights that unfold.

You can attempt to record such experiences through a single sketch, but usually a collection of sketches is more informative. The mystery of old towns, which derives in no small part from the irregular street layout, and the marvellous contrast between large public buildings and

small domestic ones, can be captured in a well-planned sequence of analytical sketches. The complexity of such places and the subtle interplay between the parts means that three or four sketches are required to capture the essence of the place and its changing geometries. Such sequential sketches (or 'serial vision', as Gordon Cullen put it) should be based upon well-selected viewpoints. For the drawing of a historic town with a major public monument as focus you should sketch:

- the approach from afar, or at least just outside the immediate sphere of influence of the monument;
- a view glimpsed of the monument above roof tops or along streets (the monument should not yet be fully in view);
- a view showing much or all of the monument within its setting;
- a close-up view of the monument, with steps, railings and human activity round about.

Whatever sequence you follow (and many different vistas are normally available), it is important to keep the feeling of mystery and suspense alive. Therefore the story should unfold like a good play, with each drawing an act that develops a particular theme. It often helps if the views



9.1

This sequence of four views along a route in Siena seeks to explore the landmarking of a street by major and minor architectural 'events'.





9.2 a, b, c and d

These four drawings take the theme of exploring bridge crossings over the canals of Venice. Each sketch relates the bridges to the adjoining palace façades.



selected are of, or appear alongside, 'hinge' buildings that act as key 'events' in the unfolding of the urban experience. Gateways provide an obvious example, but often steps or a café are equally useful to aid the observer. Few major towns are without such a sequence of spaces and key buildings, and to search them out through the sketchbook is a valuable and enjoyable experience. Sadly many modern places are without these qualities and the designer's challenge today is how to introduce greater spatial variety into an otherwise dull network of streets.

If you are seeking to analyse urban space through such means, you may find sketch plans useful. They can help relate your sketches to key factors in the structure of the town, and explain dynamic or spatial relationships that were only hinted at in the street view.

By using sequential sketches to analyse urban scenes, you will quickly become aware of the complex geometries present. Slight deviations in routes or changes in level can in reality be quite marked, though they seem hardly discernable in plan or section. Likewise, abrupt changes of direction can break the line of continuity that is so important in the enjoyment of place. Contrast can be employed deliberately and should be reserved for siting significant public buildings such as the sudden termination of a vista by a town hall or the set-back on a street to reveal a church. Often, however, the use of contrast is abused by private buildings such as a supermarket or an office block seeking to draw attention to itself.

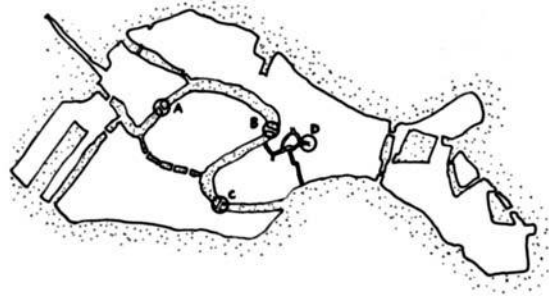



9.3 a, b, c and d

This sequence of sketches presents the village of Easdale in Scotland. The views selected describe critical point – from the sea edge to inner spaces. The emphasis is upon entry, harbour-side, procession and termination – all studied against a Highland backcloth.

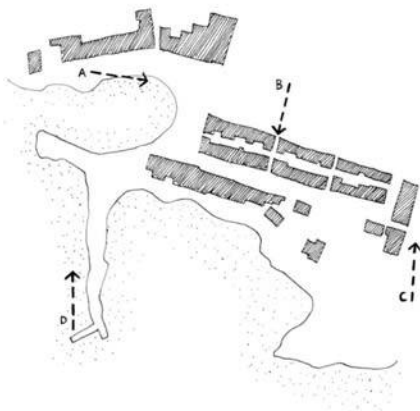

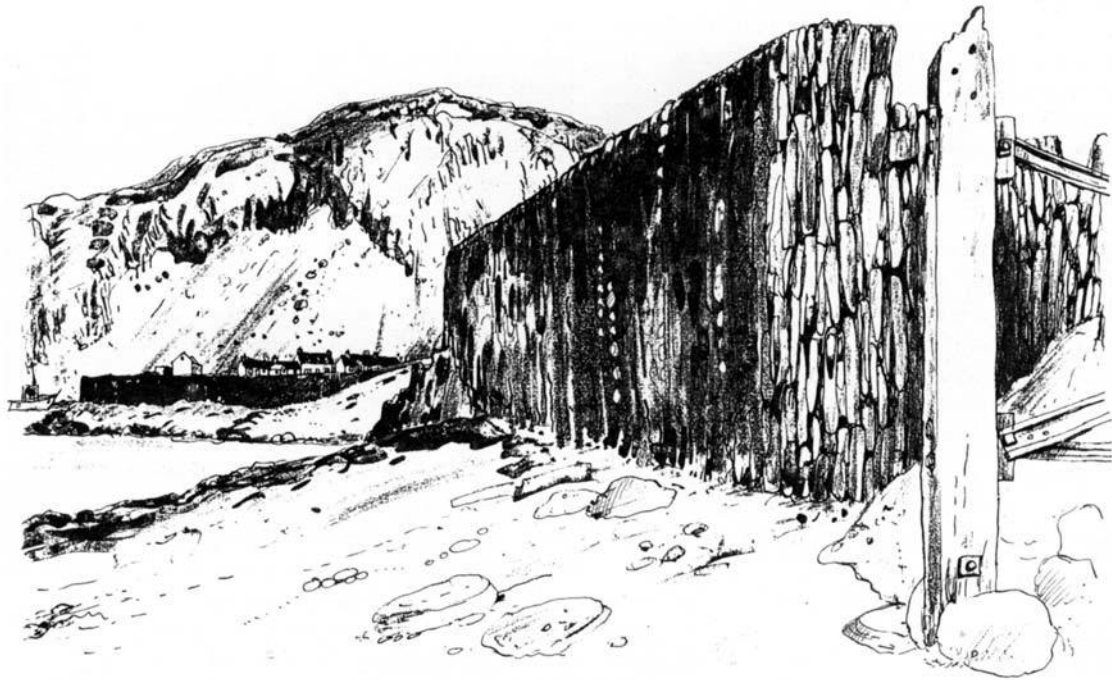
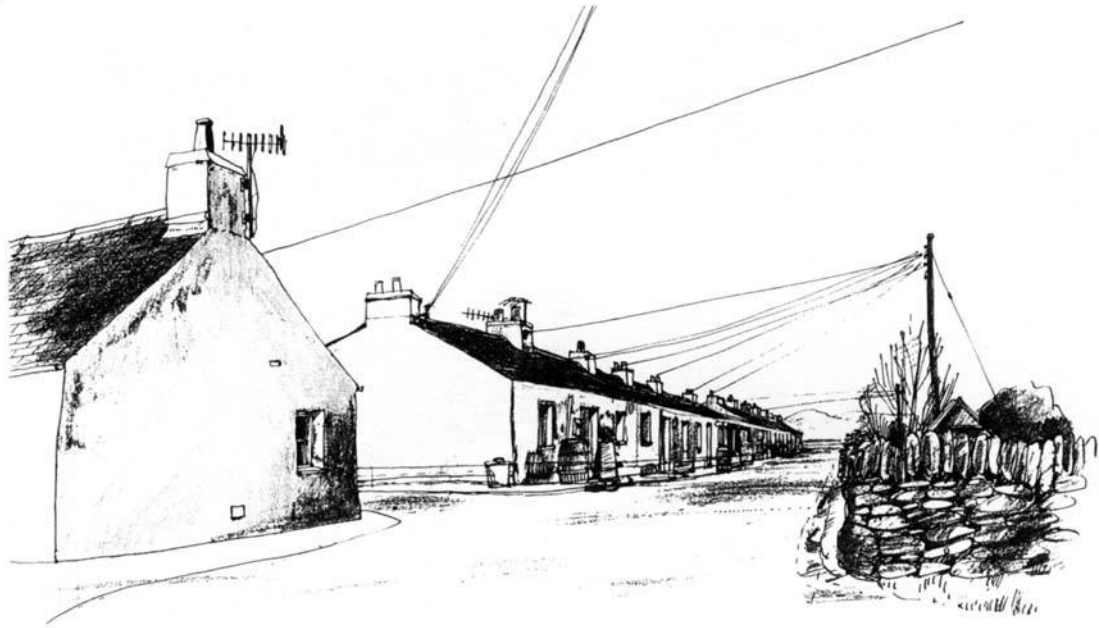

9.4

This sequence of sketches of the Guggenheim Museum in Bilbao designed by Frank Gehry explores the relationship between art, space and architecture.

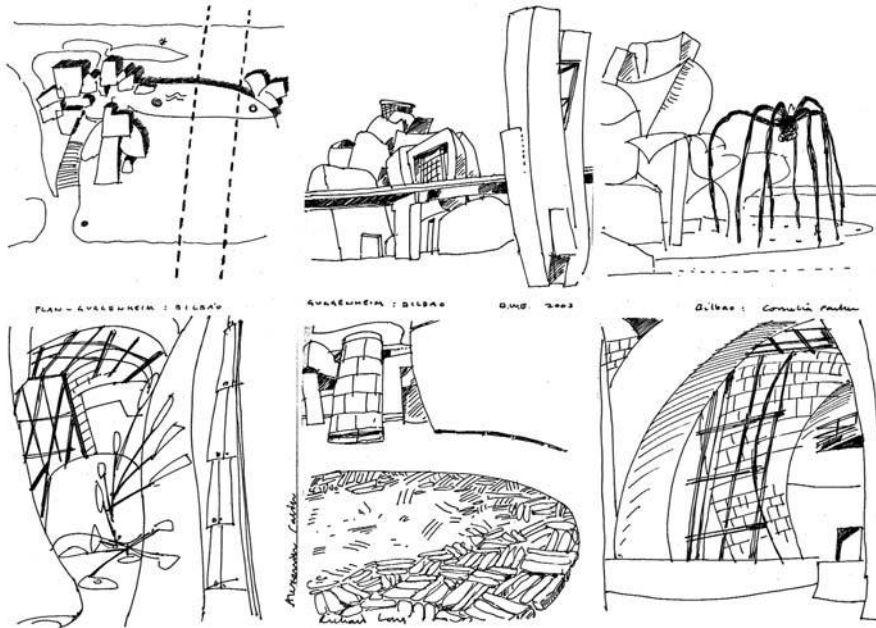

You can, of course, record contrast through a discerning sketch. If your sketches are concerned with contrast and discontinuity, then do not hesitate to underline the point with a well-selected viewpoint. For example, if you find that the scale of the town changes at a particular point, then this is where to draw. By placing the large and small buildings side by side their full impact may be felt, and if the change of scale occurs at a change of direction (which is often the case), then the sketch has additional value. Sequential sketches should therefore seek out differences and contrasts in order to enliven the drawings and increase your own awareness of design issues.

Sequential sketches can also be employed to explore the line of continuity referred to above and found in many urban situations. Such lines often unite a row of warehouses facing a harbourside or the frontage of buildings along a high street. It is often important to maintain such continuity (for reasons of civic design) in order to provide a firm edge to the urban scene. A straight

line tends to be visually less satisfactory than one that curves slightly or absorbs some irregularity with ease. A sketch of such a line, whether straight or curving, can be quite delightful and informative, especially if it is part of a sequence of related views that deal also with questions of punctuation – in other words, how the line is stopped and defined along its route.

It is important for the observer to 'read' the line and its punctuation, otherwise the point of the sketch may be lost. Therefore try to highlight the elements that make up the line of continuity, and draw attention to the elements that define points along its length. You are trying to make 'informed' sketches – sketches that tell you about the nature of urban design – so a measure of selectivity and focus in your drawing is important.

If the line of continuity links together the façades of a group of buildings facing a river, then use a particular tone or wash to unite them in your sketch. Add contrast or complexity by drawing attention to certain ingredients within the view, such as decorated doorways, special

shopfronts or town churches. Your sequence of sketches should explore progress along the line, noting where and how it is broken, deflected or punctuated.

Mention has already been made of the geometry of urban spaces. Most places of interest contain a mixture of cubes, rectangles and spheres. Such complex geometries are the essence of attractive townscape. These spaces and their interrelationships can only be discovered by walking about the town and recording one's impressions in the sketchbook. The volumetric geometry often extends to the interiors of buildings where a circular space inside, say, a church is complemented by a rectangle of urban space outside. In his design for the

Sheldonian Theatre in Oxford, Sir Christopher Wren played upon such interrelationships, as did the designers of many Baroque churches in Rome, and more recently Frank Gehry at the Guggenheim Museum in Bilbao.

You can train your eye to recognise and appreciate this architectural interplay, and through the sketchbook record and analyse your experiences. Of course, if you are an architect, town planner or developer, you may be in a position to bring this sensibility to bear upon current civic design. Europe once had a splendid tradition of related interior and exterior spaces, but the car and the dominance of street traffic have together eroded our perception of this rich urban heritage.

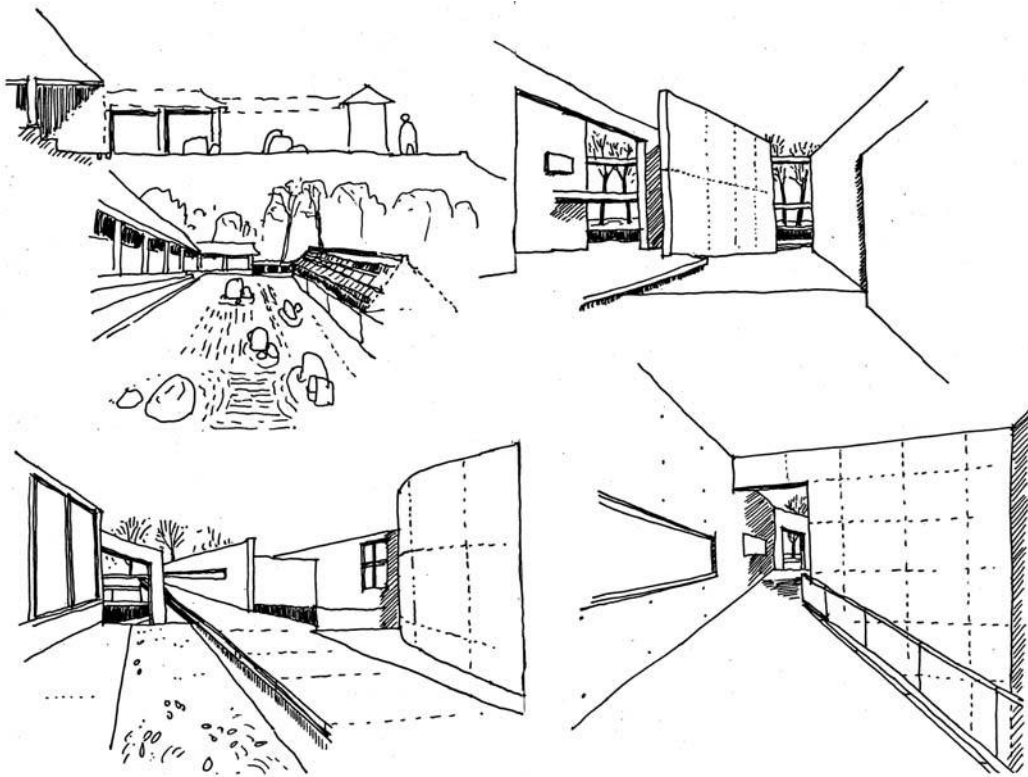

9.5

This sequence of sketches from Kyoto begins with the Zen garden at the Ryoanji Temple and ends with the Open Air Art Museum designed by Tadao Ando. The route traces a journey through gravel gardens, standing stones, minimalist planes of concrete and art installations.

Chapter 10

Drawing and photography

with Susan Fahy

To freehand drawing, photography is a double-edged sword. The lens can make an exact copy of a building façade or city scene, allowing the designer to save time on the arduous task of rendering. Once a design has begun to take shape, photography can also allow the imagined object to be further explored with the help of digitisation. Hence, photography adds a useful dimension to the trilogy of freehand sketching, model-making and CAD simulation.

Photography is, however, an ambivalent tool because its ability to make quick accurate images can engender a certain lack of critical engagement by the student or practitioner. The photographic image is so superficially compelling that the deeper inquiries that accompany freehand drawing are discouraged. In fact, the better the photograph the less likely it is that other modes of visual media will be employed. The lens produces a mind set of replication and exactitude that can thwart visual discrimination unless the student seeks to combine photography with other tools of design analysis. If the camera is employed simply for recording it has many advantages as long as freehand drawing is used to scratch beneath the surface. By combining the use of photography and drawing, the architect can record all the details and at the same time explore the fundamentals of

rhythm, structure, proportion, skyline and texture. It is the latter that are needed as a stimulus to design intervention in the city or landscape.

It is clear that the photograph can anticipate the freehand drawing or, conversely, it can follow the sketch by recording and digitising the drawn image. Either way, there is a dynamic relationship between what is drawn, what is photographed, and the evolving design intervention. The latter can be developed using other tools such as the sketch design model and CAD. As such, the photographic image can play an important role in the testing and resolution of architectural design problems, particularly when there is a physical context to take into account. Here one can use collage or cut and paste to combine design options with the photographic realities of the site.

Photography has insinuated itself into nearly all aspects of visual culture and this has inevitably impacted upon architecture. In architecture, photographs can also be used in a variety of ways both documentary and creative. Used with a critical eye, the photographic image can be employed, for instance, to study an existing building in order to understand design qualities such as the use of light, structural arrangements or the colour or texture of materials. Light in particular is well explored via

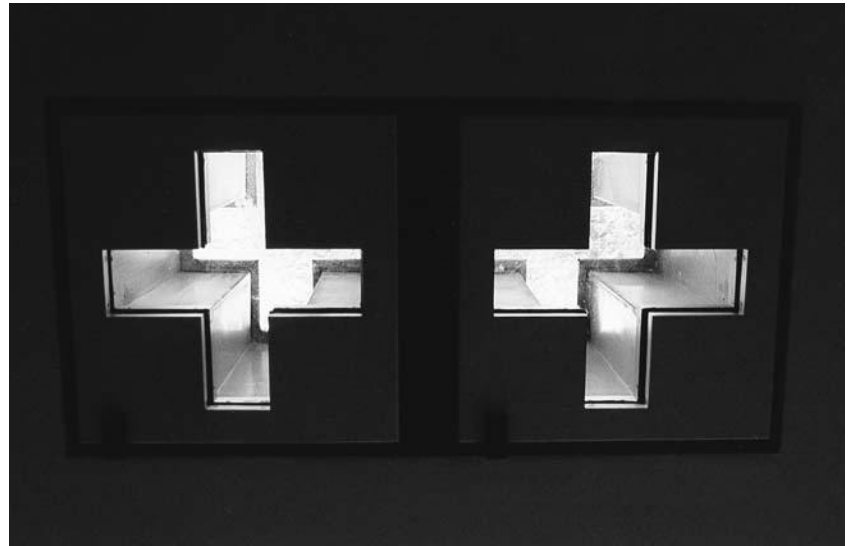

10.1a and b

These photographs by Susan Fahy of the Jewish Memorial Museum in Berlin capture the atmospheric effects of light and space sought by its architect Daniel Libeskind. (Susan Fahy)

the camera lens, particularly the atmospheric effects of natural light found in much contemporary architecture. How light changes the quality of rugged modern materials such as concrete or cast glass, and how this alters the perception of interior space, are subjects that photographic images can reveal more readily than line in the sketchbook. Similarly the analysis of light and shade, particularly the patterns of shadows, lends itself to lens-based investigation. However, when the camera is used in this fashion it is often advantageous to supplement the photographic images with sketched notes – the two mediums being used in a complementary way, taking advantage of the graphic properties of each. Buildings such as the Jewish Memorial Museum in Berlin by Daniel Libeskind lend themselves to combining lens and

traditional drawing techniques.

Used with discrimination, photography can encourage the type of critical observation required of designers. The lens, whether in the eye or the camera, is the tool that communicates the properties of the visual world. The lens is both the medium of visual communication and the instrument that models light and form. In this regard how the lens is employed influences how the designer thinks. The raw material of sight is communication – what the lens and sketchbook help to develop is visual judgement, which in turn is the source of a personal style of drawing and architectural form making. As such the photographic lens can help reveal truths in architecture, particularly in areas like the modelling of light, which can then be employed in design.

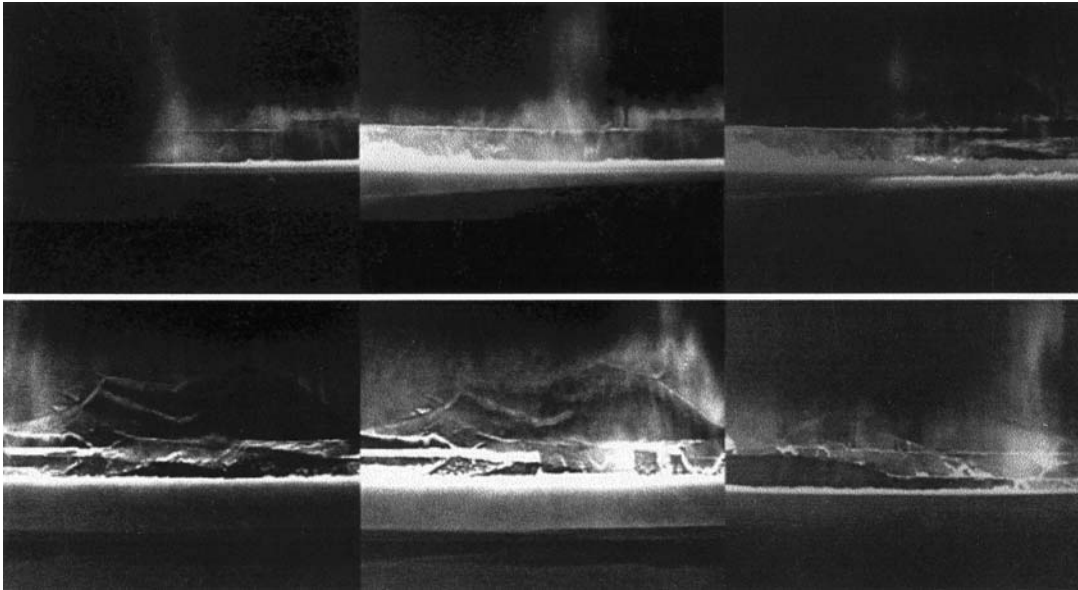

10.2a and b (left)

These studies of patterns of magnetized iron dust by James Bingham from his 'Dead Reckoning' series can readily be turned into formal compositions applicable to building design. The sequence of images captures the fluidity and movement in modern architecture (James Bingham)

10.3a and b (opposite)

Comparison between documentary photography (a) and documentary drawing (b) using grain silos in Montreal as an example. (Susan Fahy and Brian Edwards)

Photography is also a useful tool in undertaking documentation of architecture, perhaps in the context of comparative analysis of typology variations. The ability of the photograph to record from a consistent perspective removes some of the subjective qualities of drawing. Such documentation can help inform a designer whose subsequent drawings are influenced by what is revealed through the lens. For instance, if an architect was commissioned to design a radio mast (as Lord Foster was in Barcelona in 1996) the documentation of existing masts could provide a useful archive of photographic images that sketching can compare, analyse and take forward as ideas for new design solutions. So there are benefits in combining the lens and sketchbook, just as there are later in the design process in synthesising ideas developed through drawing, model-making and CAD.

A great deal of interest was shown in the 'city' by photographers of the modern movement. The aim was to document the rich, diverse and often horrific imagery of the twentieth century urban scene. The exploration of the 'city' by photographers influenced architects of the period such as Le Corbusier, whose visionary plans for Paris and Algiers sought to embrace the whole urban world in one clean sweep of reform. The squalor and chaos recorded by the photo-journalists of the period became an inspiration for large-scale reconstruction. Having recorded the city, architects felt motivated to use fresh approaches to urban design to create a new, ordered utopia. Le Corbusier's urban remodelling and, to a lesser degree, that of Walter Gropius were a response to the horrors that the documentary photographers had revealed. The stretched image of the wide-angled photographic

portraits of European urbanism encouraged architects to think on a grand and ultimately damaging scale. What photographic artists revealed through their work became an inspiration to a generation of modernist architects.

Creating a record of the site for later investigation is common practice, whether by sketchbook or camera. The idea of photo-documentation led to the practice of repetition and the exploration of various architectural typologies. As early as 1947 Lázló Moholy Nagy was presenting exhibitions of photographs based on industrial and architectural sequences that exposed the language of abstraction related to the built environment. Replication and prefabrication, which featured largely in architectural practice in the 1950s and 1960s, owed something to these photographic sequences. The lens had frozen a

moment in time, allowing serial fragmentation of movement and subtle changes in cities to be expressed with inherent design potential. As artists moved increasingly from the body to the urban scene for inspiration they exposed the limitations of the thinking methods used by architects. In time the fractals and abstractions of the photo-documentary artists, coupled with ideas from land-art and map-making, led to the opening up of fresh design possibilities. With new forms of digitised representation (including video) the limitations of the straight line and right angle were exposed. Just as the discovery of perspective had liberated architecture in the late fifteenth century, so too documentary photography and video opened up new lines of design potential late in the twentieth century.

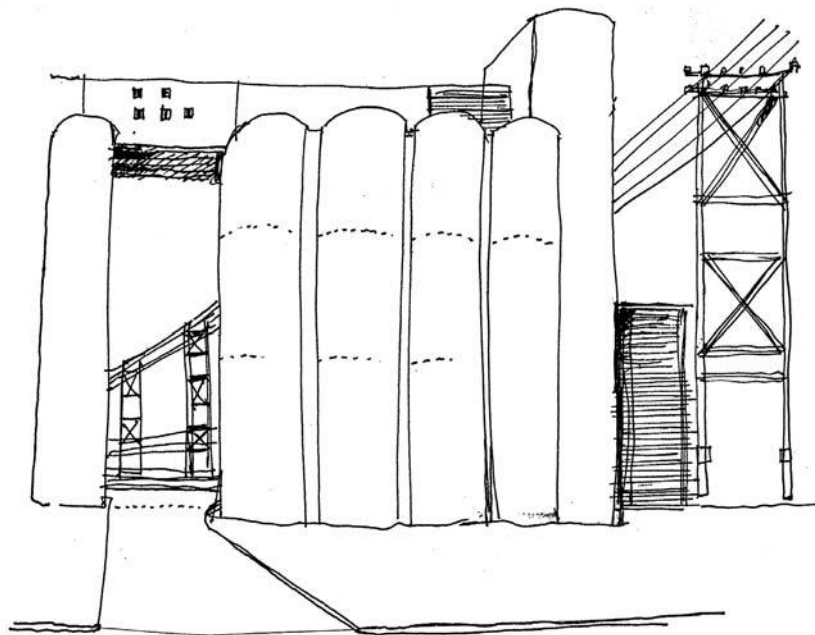



10.4a and b

This photograph by Susan Fahy of the British Embassy in Rome designed in 1968 by Sir Basil Spence is set alongside the sketch made by Spence. Both the drawing and the photograph explore the different effects of light and shade. (Susan Fahy and Sir Basil Spence)

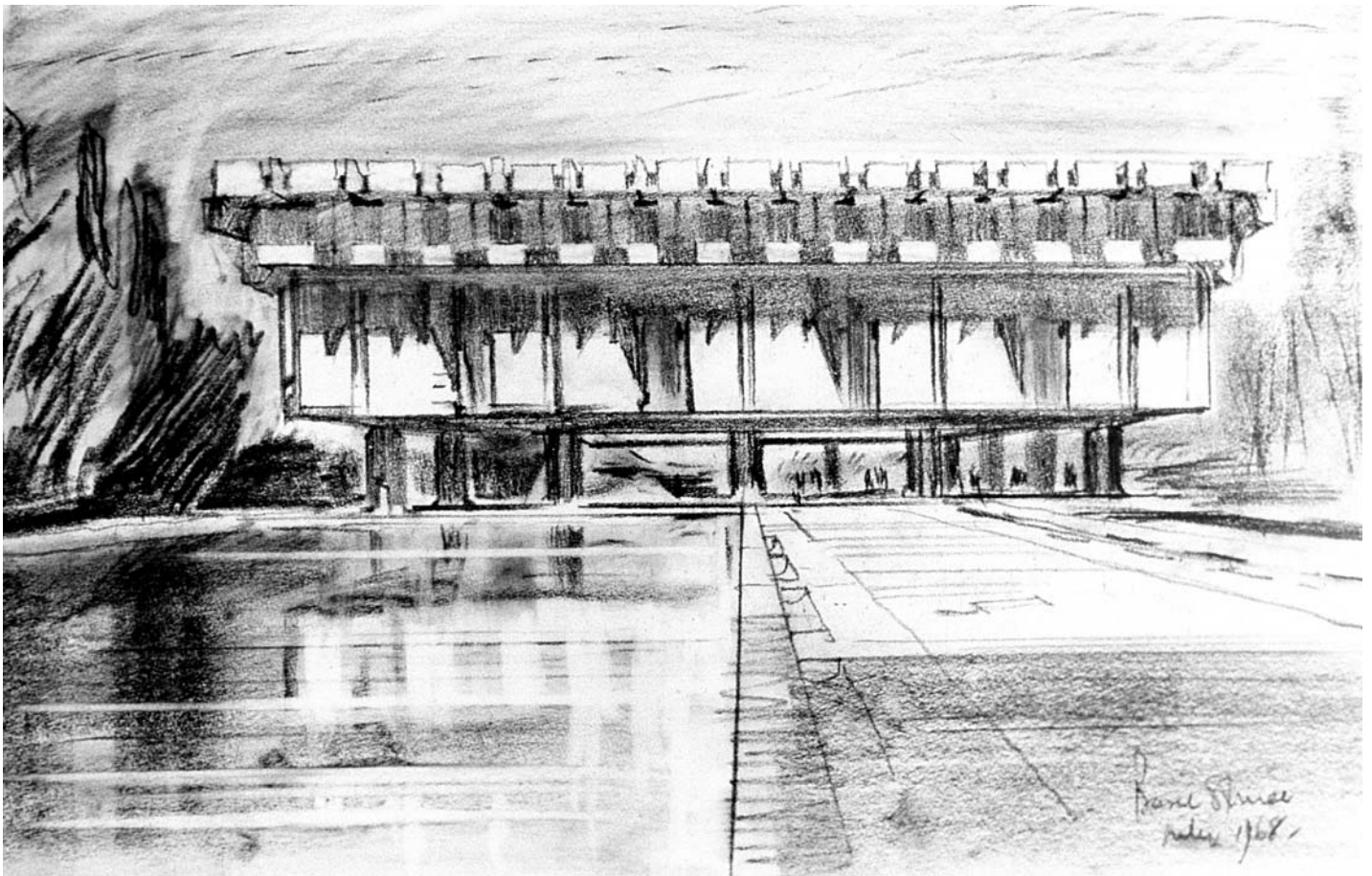

10.5

This photograph of Blakeney Point in Norfolk has been modified to test the design of a visitor centre (left) for the National Trust. The use of white correction fluid contrasts well with black pen in this speculative design proposal.



The photograph of a building, like the formal perspective drawing, suffers, however, from one perennial weakness: it so alters the representation of the object that the image takes over from the intellectual content of the architecture. However, new modes of lens-based representation when mixed with CAD allow evolving design ideas to be explored in fresh ways using photographs as the starting context. For example, ideas can be developed away from the studio using laptops, which allows design possibilities to be shared with others in an interactive fashion whilst retaining the original photographs as reference. In this world of photo-manipulation, the student and practitioner should, however, remember that it is the design that matters, not the images of it, which can be manipulated with ever

greater finesse. Although the photography/CAD interface can amplify the architectural imagination, the process of design remains a difficult probing activity.

In architecture, the photograph, like the perspective drawing, can be responsible for a great deal of false imagery, which leads to poor design. The problem with modern photography is the ease with which the image can be modified and glamorised, moving architecture into the realm of fashion on the one hand, or fine art on the other. One has only to look at architecture journals and certain book publishers to see the consequences of the surface image superseding the plan and section as the basis for architectural thought.

The lens has impacted on the main arena of architectural discourse in an ambiguous fashion and in the

process it has altered modern sketchbook practice. Photography has its uses but only if the architect exercises critical judgement in its employment relative to freehand drawing. The camera lens is no substitute for the eye and the critical exchanges that occur in designing between the eye, hand and paper. The freehand drawing needs to remain at the centre of creative practice, with the camera operating at an important but essentially secondary level.

A potential weakness of the photographic image is the neglect of line. In architecture, the line is a powerful force of demarcation and the representation of architectural order. The line is the basis for judgement and intellectual discourse. No such comparable discipline exists in photography until the designer imposes linear patterns onto the image. However, the photograph is a useful tool for exploring atmospheric effects in architecture, such as the impact of light on an interior or the texture of surfaces. This more spiritual dimension to design lends itself to lens-based analysis, either as static or moving images. Bringing together the architectural diagram expressed in plan or section with the atmospheric qualities of photography offers the potential to explore design in fresh ways. The photograph provides a subjective depth to the objectivity of the plan, allowing design ideas to be tested beyond their intellectual properties. In this way the combination of various thicknesses of line used to reflect the hierarchies of space or structure when combined with photomontage reveals the greater whole of the embryonic design. But a word of warning – since architecture is a discipline where spatial ideas rather than images are the basis for plan generation, the use of photography must take a secondary role to that of freehand drawing. If it does not then new designs are merely cloned versions of old ones.

With an intervention in an existing building the picture is somewhat different. Photography allows a subject to

be examined in all its detail. The images produced form the basis for the kind of examination denied of sketching (unless one is highly accomplished and willing to spend many hours in painstaking drawing). Using computer digitisation such as photogrammetry and software programmes like Photoshop, the images produced via the lens can be enlarged, collaged and altered in a variety of ways. As a result, photography can reveal what is easily overlooked by the casual eye.

When presenting to a client or studio instructor, a photographic presentation can evoke the spirit of a design and cite appropriate precedent. Used in conjunction with a sketch design drawn in plan and section, the supplementary photographs can help complete the picture of what the resulting building may look like. In this way freehand drawing, mechanical rendering and photography, when combined into a single presentation, may provide a useful character sketch of a design project during its evolution. Where existing buildings are employed in this type of storyboard presentation it is important to name the building being referred to and to cite the architect. Students who fail to do this may be accused of plagiarism, since visual references are as important as literary ones.

The type of hybrid drawing where freehand sketches, key words, formal technical renderings, CAD and photography are combined is an increasingly common sight in the design studio. It is the basis for most student 'crits' in UK schools of architecture. The hybridisation of rendering styles reflects the growing complexity of architectural practice and the relative decline of the plan as the major generator of built form. The latter mirrors the rise of postmodernism, with its emphasis upon the section and external image. It also mirrors the democratisation of architecture and the expanding role of amenity groups and external stakeholders in design. For these people new forms of representation are needed

and this has encouraged the rise in the architectural photograph. Often the architectural photograph is, in fact, a set of multiple images, collage or photomontage. When combined with drawing and perhaps physical models these achieve an experience of architectural possibilities that any single medium fails to deliver.

The hybrid drawing is also commonly used in the adaptation of existing buildings. Photography can save a great deal of time in rendering existing structures and in making records of changes during the course of construction. The 'before' and 'after' images need to be factually accurate, and hence the lens is preferred to the sketchbook, particularly for conservation projects. But often too many details are recorded on the photograph for the architect's purpose and hence there is a tendency to trace over the image in order to focus on important points. Where existing buildings are extended, the combination of drawn and photographic material can narrate a project, drawing attention to the changes by the different representation media employed. There commonly emerges therefore a dynamic relationship between drawn and photographic material, especially where small-scale interventions are involved. At its simplest level this could consist of a photograph over which is drawn a representation of some future change – perhaps a new building or a design for re-paving a city square.

Since photographs record everything (in sometimes excessive detail), many contemporary photographers choose to abstract their images in an attempt to turn photography into art. This does not concern us here but since the photographic image provides a record of reality, it has encouraged architectural drawing to go beyond recording the existing world. Modern drawing practice is concerned with searching for the truths beneath the surface. In design terms, the drawing is an intellectual statement of spatial intent expressed through weight of

line, colour, texture, etc. The mental map or diagram of a project is often the first drawing produced once the brief has been established, and forms a kind of genetic code for subsequent design development. Drawings that are too literal may thwart subsequent design possibilities although they may be examples of fine draughtsmanship. It is better to use the diagram with photographic references at this stage.

Looking back over the past 100 years, it is evident that the use of freehand drawing has changed under the impact of photography. Drawing, like painting, has become more concerned with abstraction on the one hand, and capturing the spirit of a subject on the other. In turn the line (once the dominant element of architectural thought) has become augmented by mark making and a galaxy of CAD-based graphic effects, as well as the ideas stemming from photographic artists. Freehand drawing has begun to take on the mathematical and intellectual qualities of mechanical drawing in the hands of some architects. With others, the graphic practices of artists have been turned towards the subject of architecture with surprisingly rich results. The symbiotic relationship between a mechanical architecture and machine-like drawing evident in the work of Mies van der Rohe finds its updated version in the graphic language of architects such as Zaha Hadid. In the latter case the photorealism of some of the drawn architectural projects is witness to the power of photography to alter our understanding of architecture.



SHENTUKU TOKYO SKYLINE OVER YOYOGI PARK

Part Three

Case Studies in Drawing

Chapter 11

Towns, townscapes and squares

An appreciation of landscape – the aesthetic quality of the countryside – has been part of our culture for at least two hundred years, but its urban equivalent – townscape – is a relative newcomer. The urban theorist and graphic delineator of towns Gordon Cullen drew our attention to ‘townscape’ in a series of articles in the *Architectural Review* about thirty years ago. His subsequent book, *The Concise Townscape*, remains a valuable introduction to the subject. What Cullen and others have sought to show is that towns have aesthetic qualities just as rich as the countryside, and that the recording and preserving the poetry of the urban scene is as important as protecting the beauties of the landscape.

What, then, makes up the beauty of towns, both ancient and modern? Different theories prevail, especially between urban theorists of a European as against American bent. On the whole, we are dealing with the following key qualities, each worthy of exploration through the sketchbook:

- squares, enclosed places and centres of activity;
- routes through the town such as streets, alleyways, lanes and footpaths;
- landmarks of varying types such as church spires, high office buildings and transmitter masts.

These important elements of urban character are supported by a secondary layer of features that provide rhythm, patterning and changes of scale or punctuation. Hence we may find that a pattern running through the glazing of an office building is echoed in the paving of a square at its base: façade and space are thus united by a commonality of line.

The sketchbook is a useful tool for understanding towns and cultivating an awareness of the complex visual language of the city. Unlike the countryside, many cities, especially big modern ones, are very complicated; their spatial structure may be disjointed and the skyline a battleground for different styles. In spite of this, the freehand sketch is a useful starting point for analysis. As when drawing a landscape, one has to be selective, and it is best to avoid a too literal representation of the urban scene. A good townscape drawing focuses upon relationships and highlights the crucial elements such as the street line, silhouette and entry point.

Whether one is drawing countryside or a town, establishing the structure of the view is of great importance. The relationship of hedges and trees to a field in the landscape sketch is analogous to that of buildings and towers to a street in the townscape drawing. To focus upon the windows and doors of the



11.1 (far left)

The relationship between public building, public square and gathering space is the basis of this drawing of Rome in Italy.



11.2 (left)

The deliberate landmarking of the street junction is a common feature of 19th-century urban design. Here in a tenement neighbourhood of Glasgow the architect for the church placed a Gothic spire as near to the pavement edge as he could. The coherence of the scene is the result of four-storey height limits placed on the builders of the tenements by the Victorian city council.

buildings is akin to a precise rendition of the leaves and branches of a hedge – such detail may not be necessary to your analysis.

Rather than seek to sketch the full complexity of a town, it is best to concentrate on the key elements listed earlier. In this way the artist or student will better understand the main factors that shape our perception of cities, and, as an urban designer, will be better informed as to how and when to change their form or structure. Let us begin by looking at the first of the key elements: squares, enclosed spaces and centres of activity.

Cities do not contain an even distribution of social or commercial activity. Most towns have squares where people meet, civic functions are held and where railway and bus stations often make their presence felt. As focal

points, 'squares' come in many forms and sizes; some are regular, others charmingly irregular and uneven. As our perception of cities is shaped by our memory of squares (such as Trafalgar Square in London, Times Square in New York or George Square in Glasgow), they perform a vital function in making one place feel different from another.

Squares are essentially enclosed spaces, though they can be partly open at the edges and partly filled by buildings. The degree of enclosure is important, however, for a real civic focus requires a space that is 'contained' by the surrounding buildings. Containment places a responsibility on the enclosing structures to be of sufficient size to prevent the space spilling out. If the square is very large then the surrounding buildings need



11.3

The relationship between densely packed private houses, the castle and topography is the subject of this study of an Italian hill town. Here 'townscape' is analogous to 'landscape'.

to be fairly high, and any breaks in the continuity of the façades filled, unless the breaks lead to further events of interest such as a secondary square or a public building set back from the main square.

It is important when drawing squares and courtyards to allow some of the character of the place to invade the sketch. For example, if it is a residential square then to incorporate such details as washing lines or children playing would not only enliven the sketch, but inform its content as well. Alternatively, if the subject is a public square then elements of a civic nature such as statues or trees planted in formal lines should be included. You may wish to add people since this gives life to the square, but be careful to draw people appropriate to the location and select such details as local costume to bring a touch of *genius loci*.

Whatever type of square or courtyard you decide to draw, ensure that the sketch has a focus. Drawings of squares tend to be sketches of spaces (not objects) and hence can have a vacuous quality. The reality may be that the square itself lacks a focal point, but often you can overcome the problem by drawing a length of building façade to provide a point of interest around which to compose the sketch of the square. The building façade will probably be the principal frontage facing the square – perhaps a town church, market building or railway station. A great deal of effort will have to be devoted to sketching this properly as it is likely to be the major event within the space.

Once the focal point has been fixed, the rest of the sketch should fall into place with railings, fountains, statues, steps and walls providing useful articulation of

11.4

The Placa Reial in Barcelona is an even-shaped square surrounded by buildings of consistent style and filled with splendid palm trees. Openings into the square at regular intervals allow it to connect with the older pattern of streets outside. By selecting certain elements, this elaborate civic space becomes manageable to draw.

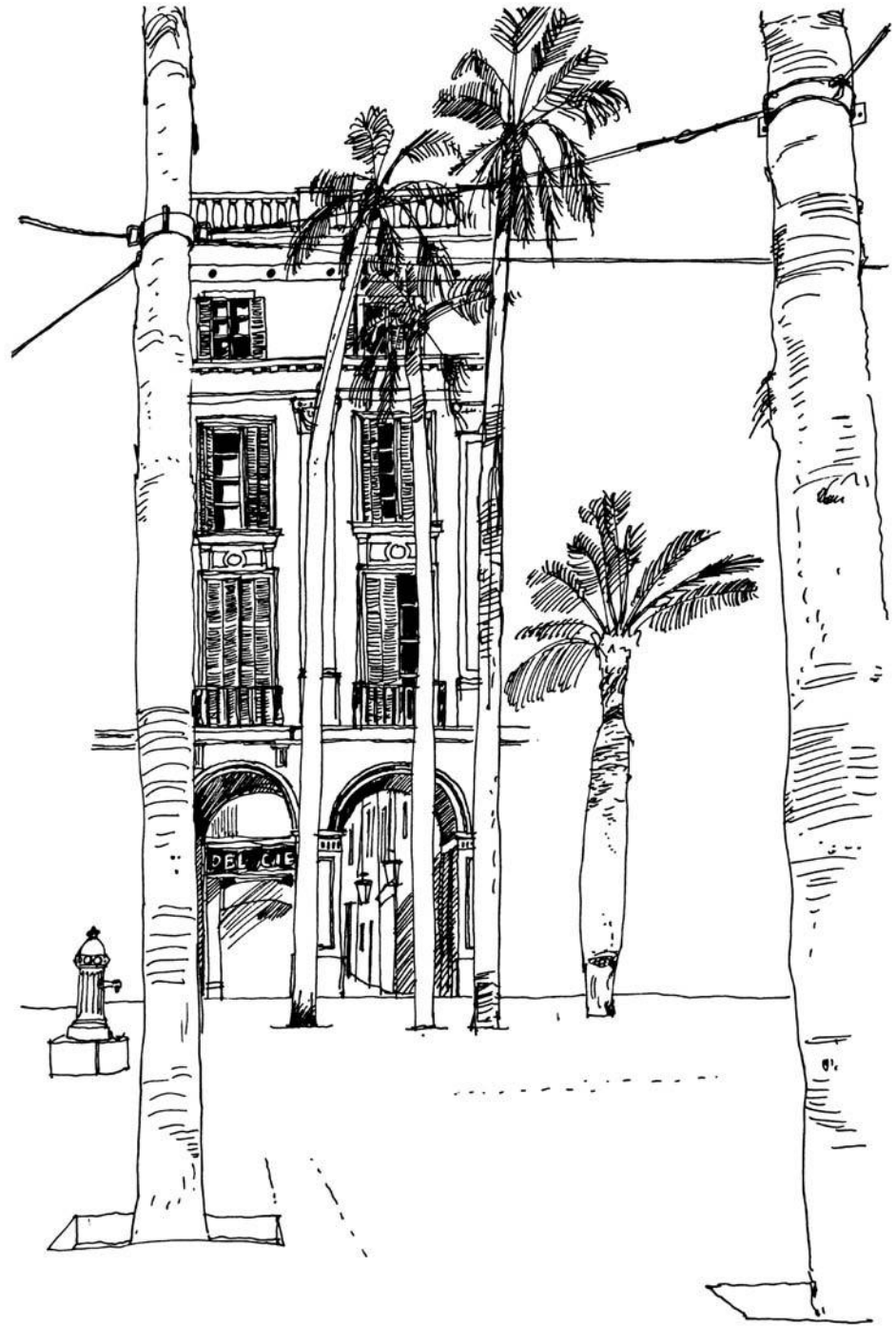



11.5
Shops and pubs are traditionally grouped around market squares, as in this sketch of North Walsham in Norfolk.

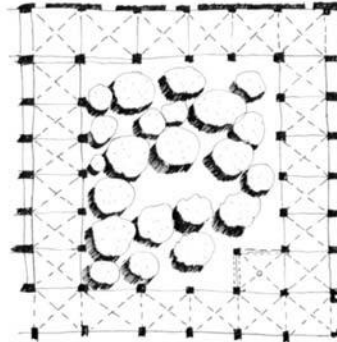

11.6
Cloisters are often peaceful and well-shaded places to draw. Here in Barcelona Cathedral the central space is filled with luxurious planting overlooked by grotesque gargoyles.

11.7

This sketch shows the main elements that make traditional city form. Notice how the different typologies provide different levels of townscape enclosure and scale.

(Derek Fraser)

URBAN DESIGN - BUILDING TYPOLOGY

POINT

HOUSE/VILLA

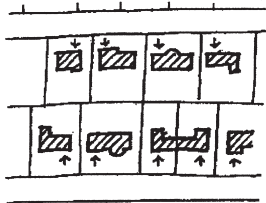

SINGLE FAMILY HOUSES
SEMI-DETACHED HOUSES
1, 2, OR 3, STOREY

URBAN VILLA

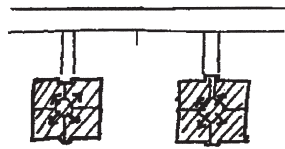

APARTMENTS
DUPLEX
4 - 6 STOREY

TOWER

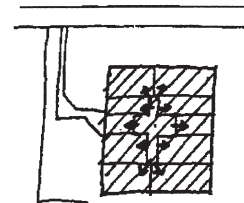

HIGH-RISE
APARTMENT BLOCK
MULTI-STOREY

LINE

TERRACE

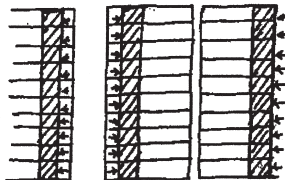

PARTY WALL HOUSES
2 - 4 STOREY
Front to Front & Back to Back

ROW

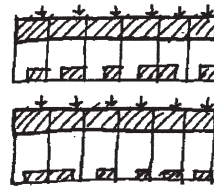

PARTY WALL HOUSES
2 - 4 STOREY
Front to Back

SLAB

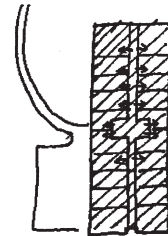

APARTMENT BLOCK
MULTI-STOREY

ENCLOSURE

COURTYARD HOUSES

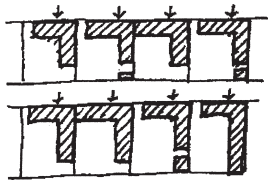

SINGLE FAMILY HOUSES
LINKED
1 STOREY

PERIMETER COURT

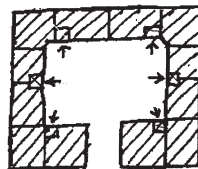

TERACED HOUSES/
APARTMENTS
4 - 6 STOREY

PERIMETER BLOCK

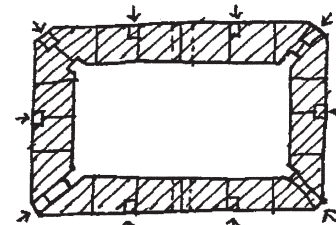

APARTMENTS
4 - 8 STOREY

DF

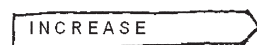

S

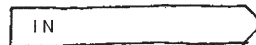

M



L

XL

11.8

This sketch plan by Robert Camlin shows the application of different patterns of urbanism for a project in Dublin. Here existing buildings and landscape are stitched into a masterplan for university expansion. (Camlin Lonsdale)

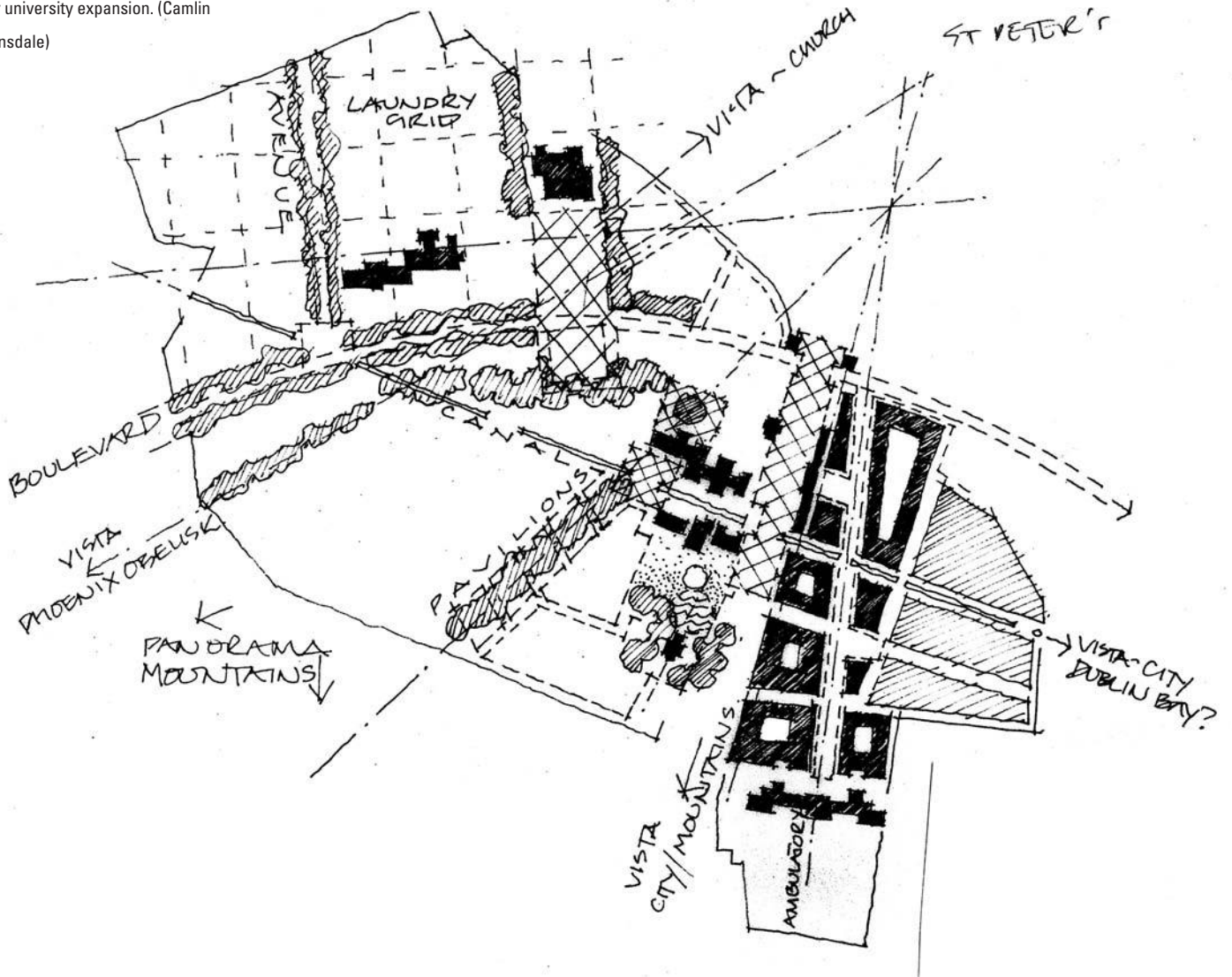



11.9 (left)

The courtyard formed at the rear of ancient tenements in the Old Town of Edinburgh offers a quiet space to experiment with sketching.

11.10 (below left)

The fountain at this monastery in Dubrovnik provides the path with a sense of focus and deflects movement to either side.

11.11 (below right)

Deep shadows are used to help explain the structure of this small square in Florence.

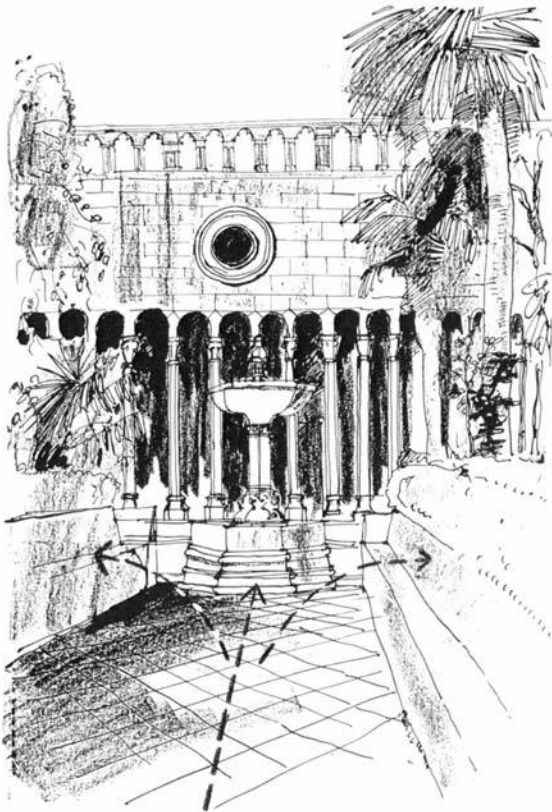

the space. Often squares have more interesting paving details than do the surrounding roads, and these should be included in the sketch. Such details bring the foreground towards the viewer, and help establish the shape and configuration of the square. Equally, squares are frequently planted with interesting trees and shrubs whose foliage can provide much fascinating detail to set against the hard-edged buildings. Your sketch should demonstrate how good urban design consists of considering the buildings, spaces and landscape of the city as one, rather than as separate entities.

Squares that are distorted or uneven in shape can be more taxing to draw than regular ones. Remember that although the walls are not parallel, they have vanishing points along the same eye level. You may find, however, that one side of the square is strictly geometric in layout and often has buildings of fine proportion. You should exploit the differences in your sketch – contrasting the regular with the unplanned, thereby capturing the charm of the place.

Squares come in all sizes, from small domestic courtyards to broad civic spaces. The latter are the hardest to draw since they contain much complex detail and are often so wide that the sketches become panoramas. Beginners should start with small spaces and only attempt scenes such as London's Parliament Square after much practice.

If you do attempt a big public square then a grasp of perspective is essential. However, scientific perspective may not provide all the answers in terms of composition or for capturing the action within the square. Here you may choose to adopt a more personal system of representing space, not unlike the Oriental system of perspective, which sets images (represented with no regard for geometric accuracy) layered in front of each other so that they become larger the nearer they are to the observer. With large squares, no matter which

technique of perspective is employed, it is often instructive to try to enter into the space through the medium of drawing. If the artist chooses a position, not so much on the edge of the square looking in, but within the square and surrounded by its action, then something of the character will come through. Photomontage can also be employed to represent the background architecture, thereby allowing you to focus upon the activity in the square.

The most interesting urban spaces are those surrounded by buildings such as shops, cafés or bars. If the activities of these places are encouraged to spill out on to the square, so much the better. In addition, the square will frequently be edged by an arcade containing shops and restaurants. Hence it is surrounded by buildings that respond in form to the activities that it encloses, providing a richness of visual and social detail at the perimeter of the space. It is unfortunate that these traditional qualities have been eroded by the ubiquitous presence of the car, which in many European cities has usurped the city dweller from many areas.

Squares with much activity around the edge often have a focus of attention in the centre. Fountains, seats, an area for gossip under a few trees form the centre of many European civic spaces. In Britain it is more common to find a group of large plane trees growing within a railed-off enclosure. The relationship between the geometry of the space, its activities and planting are excellent subjects for a sketchbook analysis. Often there is room within the square for the internal activities of the enclosing buildings to spread well into the space. If a railway or underground station is located on the edge of the square then its influence will be felt more directly than in the case of a café. Now there will be bustle and bursts of movement – at rush hours and when trains arrive. A similar situation can occur if a theatre faces a square; the times of the performance will be reflected in an increase of activity.

One lesson to be drawn from this exploration is the need to allow perimeter functions to influence the design and layout of the square. A circulating system of roads prevents the peripheral traffic from spreading into the centre, leaving the space free for, and enriched by, social interaction. Those who design public buildings and railway stations have a responsibility to provide related urban space for this essential human need. It is a daunting task to try to draw a busy square, but to demonstrate the relationship between physical form and civilised values through the carefully drawn sketch is useful, even if the drawing itself is a failure artistically.

Since squares are generally enclosed on all sides, the artist should employ shade and shadow to create the impression of spatial containment. You can use your imagination when portraying the direction of light in order to express the quality of the square in the most favourable way. A deep shadow to left or right allows figures, statues or trees to be set against it, thereby standing out and creating a real feeling of occupying the space. Shading should not generally be drawn upon the focal building – the intention is to direct the eye towards it by masking out surrounding buildings. The focal building (say, a theatre or church) can have broken shadow or shade beneath lintels and cornices, but the principal structure in the square is best bathed in sunshine (even if this is not present in reality) and framed by other buildings and trees in shadow.

Sometimes a mixture of wash or Conté crayon and fine line are the best materials to delineate such spaces. The wash or crayon depicts the shadows, while the line work can be employed for portraying decorative or principal elements. With complex urban spaces it pays to simplify the subject as far as possible, and to build up the sketch gradually, aiming to stop before the subject becomes overworked.

As squares are one of the chief attractions of towns, it is worth spending more time in them than elsewhere. The culture of cities often resides in the squares – a culture not just of architecture but of people and public functions. Lesser squares and domestic spaces are also valuable and provide important social centres for smaller districts. These secondary spaces may be a useful starting point for those intent upon understanding urban design, as drawing skills can be learnt in them unimpeded by the bustle or embarrassment that can arise in more central locations. For the lessons provided by urban spaces – those of entry, containment and perimeter activity – are to be gained equally well in small squares as in large ones.

These lesser squares show that a hierarchy of urban spaces exists in most towns. The civic square is a truly public space, while domestic squares set back from the street edge are more intimate in character, though often different again from semi-private squares landlocked within the middle of a city block. Hence the different types of enclosed urban spaces have distinctive qualities that relate to their levels of privacy and need for security. A design sketch should communicate some of these differences in character, as in the proposal for a new university campus in Dublin by Metropolitan Workshop Architects.

Chapter 12

Streets, lanes and footpaths

Our movement through towns is normally along streets and roads, and hence our perception of the quality of place is shaped by what we see from them. Anybody intent upon exploring cities through the freehand sketch should, therefore, concentrate upon the routes people normally take. These vary from grand streets to alleyways and pedestrian footpaths, and each has its distinctive character. The different types of city route can be categorised as follows:

- street: a relatively formal route lined by continuous frontages of buildings;
- boulevard: a grander version of the street, often containing trees planted in parallel rows, and sometimes with a central reservation;
- road: an informal car-dominated route generally of a suburban nature;
- lane: an access route often serving the rear of properties and frequently running parallel to a street;
- alleyway: a narrow route, often a service corridor originally constructed for the movement of carts;
- footpath: a pedestrian-scale route between buildings, often an ancient right of way and known by a variety of local names such as a 'loke' in Norfolk or 'pend' in Edinburgh.



12.1

This formal street in Glasgow enclosed by late-nineteenth-century tenements has a regimented character that extends through architecture, urban layout and planting design.

The mixture of different types of route within a town, and the way they connect up with each other and to the public squares, expresses the very essence of urban character. Not only is the spatial experience of using them enhanced by their variety and complexity (explore, for example, the Rows in Brighton), but you will often find that key routes have landmarks such as important buildings. These points of punctuation help city dwellers to find their way around and to relate one set of routes to another.

Landmarks along routes come in many forms, from a distinctive 'event' such as a decorated pub jutting into the space, to an oriel window overlooking a change of direction, or a lofty church spire. One can search out these 'highlighting' features and describe them through the sketchbook. Many major routes through a town are deliberately punctuated by a well-placed statue or public building, but the lesser routes are often accidentally landmarked. Hence a hierarchy of landmarks may exist, each tailored to the scale of the route and its civic status.

If you are intent upon sketching a route, it is important to allow the drawing to focus upon or acknowledge a point of punctuation. Although the sketch may be concerned with the nature of a street or road, the fact that it has a landmark along it that provides local interest should not be overlooked. With long routes the points of punctuation allow us not only to measure how far we have travelled, but to experience the process of movement. On an urban motorway tall or distinctive structures may provide distance markers, and the same is true on a pedestrian-scale alleyway.

Our route along a street can be intentionally punctuated by such features as a clock mounted on a bracket above our heads, or by a colonnaded entrance jutting into the pavement. Such manipulation of our perception by well-placed markers was normally reserved for public architecture, but today it is common to find



12.2

Access lanes (as here in Siena) are often tortuous routes that have grown up from ancient cart tracks. In this sketch the buildings overshadow the lane, which provides no space for gatherings of any description.

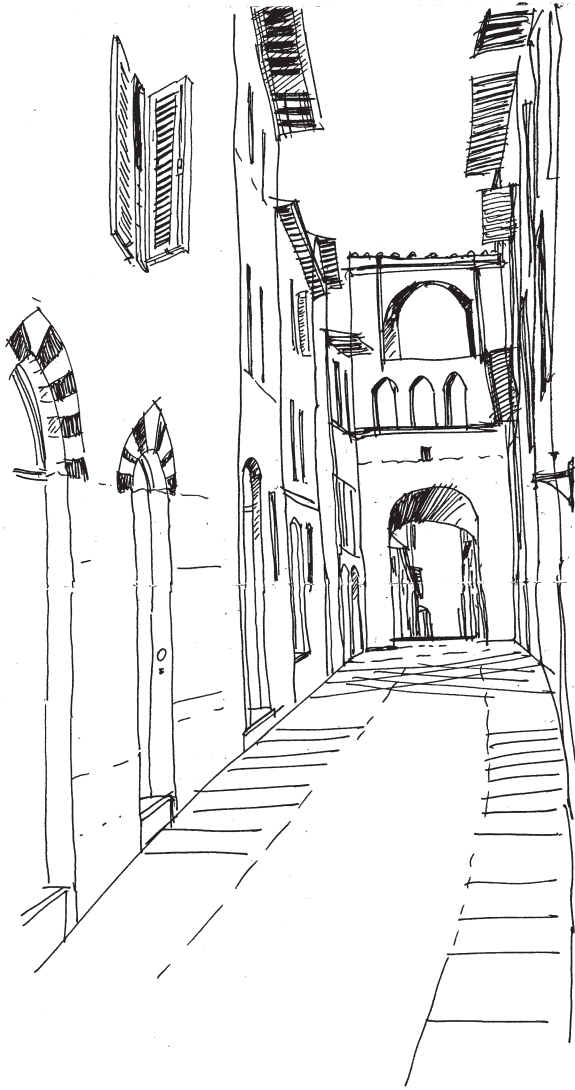

12.3

This sketch of San Gimignano in Tuscany shows the importance of enclosure in city making.



12.4

The bracket-mounted clock at the Guildhall in Guildford provides an obvious point of punctuation along the main street. Notice also how the cupola is pushed to the edge of the roof to provide another landmark.



12.5 (far left)

This attractive scene in Sperlonga in Italy shows how changes of level can be handled along a pedestrian route. Clues to where the pathway leads are marked by archways with doorways providing a secondary focus.

12.6 (left)

The archway above this street in Siena signifies where a territorial edge occurs and the steps further on are designed as private, not public, space.

illuminated advertisements or supermarket frontages exploiting these qualities.

Whether your sketch seeks to analyse a traditional route and its landmarks or a modern one, the same rules apply. Select a good vantage point, compose the drawing in your mind before you begin, ensure the perspective is correctly handled, and make sure the marker on the route is prominently displayed.

Routes are not only deliberately landmarked, but undergo pleasant changes of direction or level. Frequently a curve in a street is the place to find a distinctive house or shopfront, and at changes of level there may be an old pub or group of ancient trees. Where steps occur they can enliven the scene, especially if there are decorative handrails or lamps to light the way. Search out these

incidental events, for they are part of the character of towns and are frequently being swept away or standardised by insensitive municipal authorities.

Towns with spatial richness consist of a mixture of the different sorts of streets listed earlier. Generally it is only the bigger cities and those with distinct historical layers, such as Edinburgh, York or Chester, that offer the full repertoire of types of routes situated close together. Other countries are more fortunate – around the Mediterranean it is commonplace to find in quite small places a network of fascinating streets and lanes leading to and from a town square. Here the spatial tensions experienced by the pedestrian are enhanced not only by many changes of level, but also by abrupt alterations of scale as, for instance, a grand central square suddenly

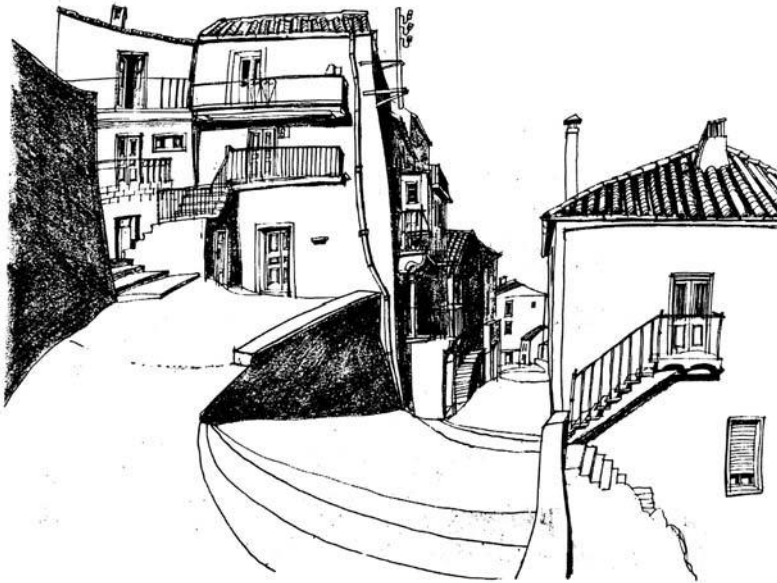

12.7

The network of lanes, steps and footpaths in this stretch of an Italian hill town provide the basic urban structure around which more recent houses are grouped. Walls are an important element where abrupt changes of level occur.

opens into view. Added to this, the remnants of fortifications (as in Dubrovnik) provide a perimeter route around the town as well as attractive terminations to many of the alleyways.

Grand cities such as Paris, Washington or Turin contain wide tree-lined boulevards that are rather like linear squares. Here many different types of activity can be accommodated within the broad space of the street – pavement cafés, room for parking, tram routes, through-traffic, central promenades and shaded areas for gossip. Largely the result of nineteenth-century highway engineering, the boulevard sought to bring beauty and ventilation to the heart of congested cities. Today they are worthy subjects for sketching as long as they are treated fairly broadly (attempts to include too much of their detail would defeat the average artist).

For routes to uphold their civic responsibilities they should be legible places: streets need to be landmarked along their route and perhaps terminated at their ends. Yet the enjoyment of towns depends upon a balance

between legibility and mystery. The narrow spaces of lanes and alleyways provide mystery and spatial complexity to set against the right angles and open spaces of the major streets and squares. How the parts are put together is largely the result of history – towns normally represent their economic or cultural origins in the present layout of their streets. For the artist, a good street map, a willingness to explore on foot, and the use of the sketchbook as a tool for urban investigation are all equally important. Urban design is best taught in the field, by employing the freehand drawing to record and analyse. Our towns are a shared responsibility – their well-being is momentarily in our hands when we draw and plan them. The much-overlooked visual language of cities resides not only in what we can see and experience from the routes we take, but in how we elect to represent it and thereby protect it.



12.8

Handsome streets like this one in Pimlico, London, are often spoiled by parked cars. Streets and squares cease to be attractive or legible when filled with vehicles.

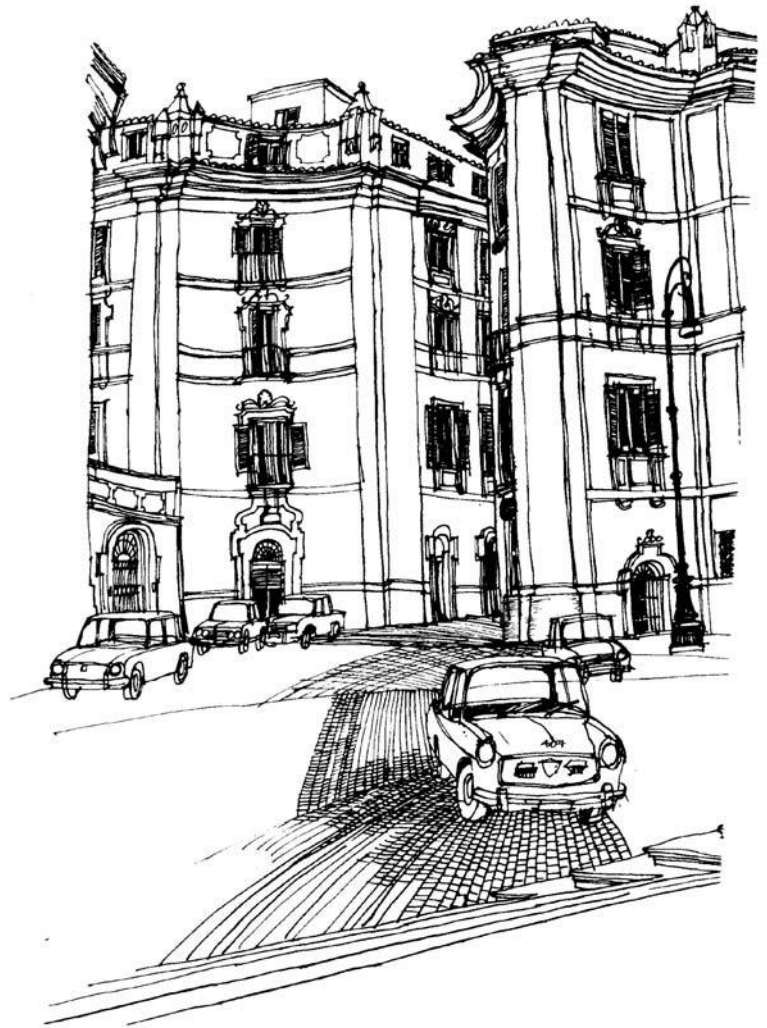

12.9

The relationship between streets and squares is often important. This composition of Baroque buildings in Rome contains narrow streets that open dramatically into a well-lit square.



12.10

The curve of the main street in Holt, Norfolk, heightens the drama of entry to the town centre. The Georgian house to the right provides a welcome 'book-end' to the older houses and landmarks the end of the formal street.

12.11

The market square in Holt, Norfolk, has been partly invaded by subsequent building. The effect is to create an attractive sequence of spaces around the various buildings.



12.12

This drawing of a mountain village in Oman shows how permeable historic towns are compared to their modern equivalents. The routes also provide the main means by which we experience places.



MOUNTAIN VILLAGE - OMAN -
BRIAN EDWARDS

Chapter 13

Landmarks, skyline and city image

Tall buildings, church spires and vertical features such as chimneys or pylons provide reference points to aid our navigation through towns. They are normally external landmarks in that we do not usually enter into them. In the city tall buildings rise above a basecourse of lower structures that comprise the everyday buildings – houses, warehouses, offices, and so on. For the landmarks to be read clearly they need to have background contrast so that they stand out from their neighbours. This means that landmarks are best set in an envelope of free space, and have a distinctive profile. Many towers in historic cities are so treated, especially the spires of churches or domes of town halls. The modern city poses a difficulty since the tall buildings are normally office blocks and they can look much like each other. So in many contemporary cities such as London or Birmingham one cannot navigate by the tall structures. Instead, one must search out the lower but more profiled and distinctive towers of earlier times to aid one's navigation.

Generally speaking, the basecourse of lower buildings is about four to six storeys high, and structures that rise significantly above this become 'landmarks'. Tall buildings can be 'dominant' structures – that is, they assert themselves through bulk – or 'prominent' structures that establish their presence through a distinctive profile or

use of colour. Many modern office or residential blocks are 'dumb boxes' in visual terms since they fail to communicate a civic presence. A new generation of tall buildings that recognise their urban responsibilities is currently appearing on our city skylines (for instance, the SwissRe Building in central London or Canary Wharf in London Docklands). These structures are more profiled than their predecessors, especially at their tops.

If the success of a landmark depends upon its distinctiveness or uniqueness from its neighbours, then the designer can either manipulate the shape of the whole tower or (and this is cheaper) simply profile the top. Either way, uniqueness can be achieved and the skyline of the city enhanced. As we tend to view landmarks from within the city, the lower buildings obscure the bulk of the tower, thereby focusing our attention upon its top. Hence it may be legitimate only to shape the cap of the tower. Yet it should be also borne in mind that from outside the city the whole landmark is visible, so that concentrating on the profile of the whole tower, and not just the top, becomes important (Manhattan viewed from across the water is a good example).

As landmarks compete for attention, there is some argument for treating skyscrapers as an ensemble. Skyline competition can enliven the urban scene, but it

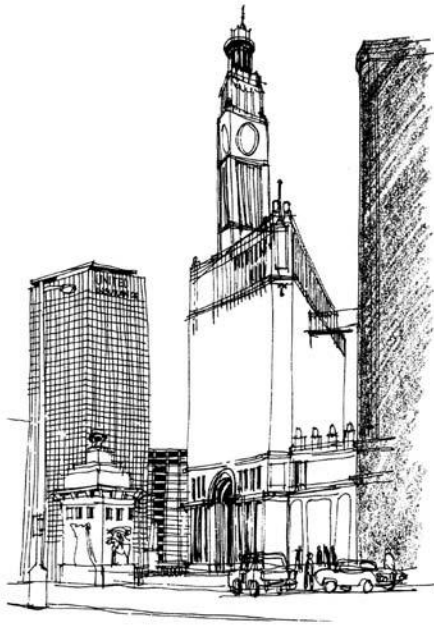

13.1 (far left)

This street in Chicago is landmarked by towers of different generations (1930s and 1960s). The street becomes a showcase of architecture through the ages, each building vying for attention. With broad streets the skyline is particularly important.



13.2 (left)

This early 20th-century office tower in Vancouver rises above a basecourse of more ordinary buildings. The curved roof provides a distinctive profile to the block.

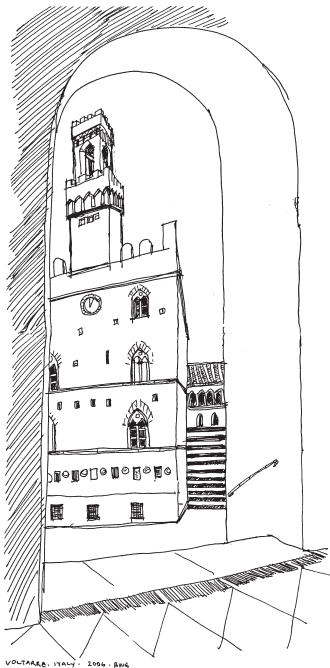

VOLTERRA, ITALY - 1964 - B&G

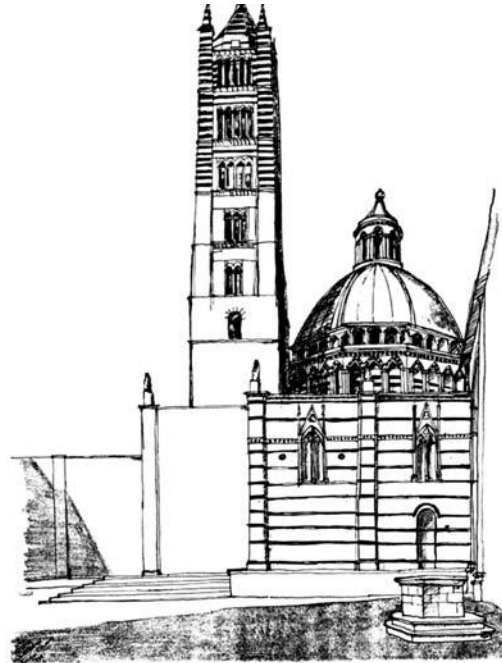

13.3 (far left)

This tower in Volterra, Italy, benefits from the framing provided by an adjacent building.

13.4 (left)

At Siena Cathedral two forms of landmark have been employed – the tower and the dome. Each is set sufficiently apart to avoid competition. Here the tower acts as a useful marker to the square, alongside the cathedral.

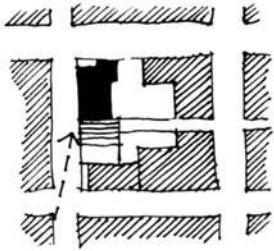

13.5

Old and new landmarks are here (in central Glasgow) set rather more in competition than cooperation with each other. Although a space has been formed to allow Alexander Thomson's church tower to rise unobscured, it remains bullied by the new neighbour.

13.6

The Seine in Paris is edged by handsome cliffs of apartment blocks and offices. The occasional church or university tower provide a useful point of reference to tourists and residents alike. Notice how the river has become a corridor for public display.



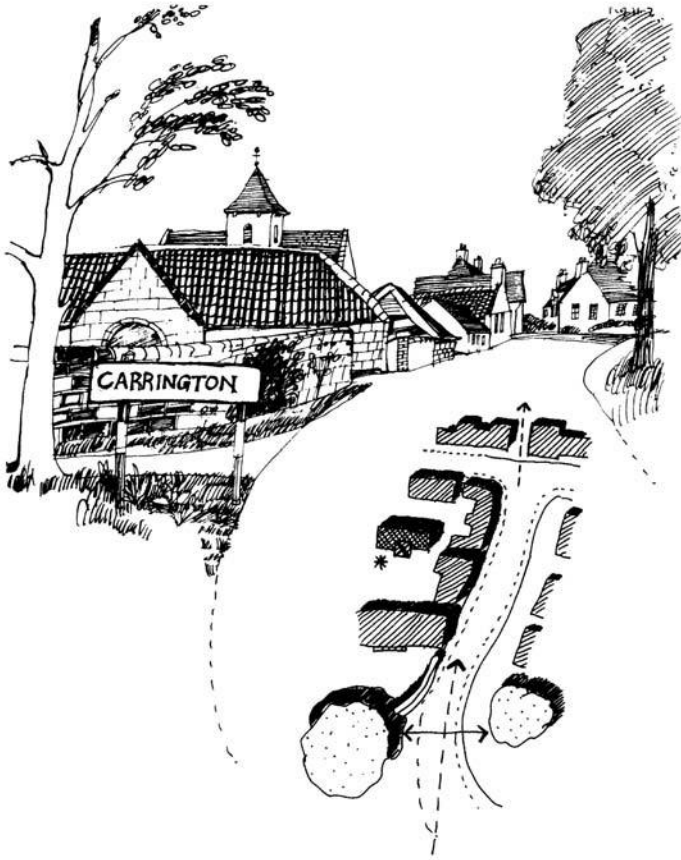

13.7

Our appreciation of towns is usually derived from the public streets. Here in Carrington, Midlothian, the barn on the left deflects our view into the main street with the trees framing the entrance. The church tower acts as a useful landmark.

can also be beneficial to treat towers as a collection of related but different parts. When Sir Christopher Wren designed his 50 or so London churches after the Great Fire of 1666, he saw them as complementary elements both between themselves and with regard to the dominating presence of the dome of St Paul's. Each tower or spire was different, but taken together they had a certain unity.

The relationship between old and new city landmarks is a valuable subject for the sketchbook. It is best to draw the landmarks from within the street scene, showing their relationship to the urban context. Hence the sketch will probably contain streets as well as the tall buildings. By setting the landmarks into context, their importance as an aid to navigation becomes clearer. A sketch exploring the impact of one landmark upon another may dwell upon the need for singularity of form or the formal relationship of one skyscraper to another.

By understanding the relationship of different parts of the townscape – squares, streets, landmarks, etc. – one can begin to appreciate the interconnected nature of urban design. Many modern cities are hard to find our way around because the routes are not landmarked, or because the tall buildings all look the same. Pedestrians experience abrupt changes of direction and level without

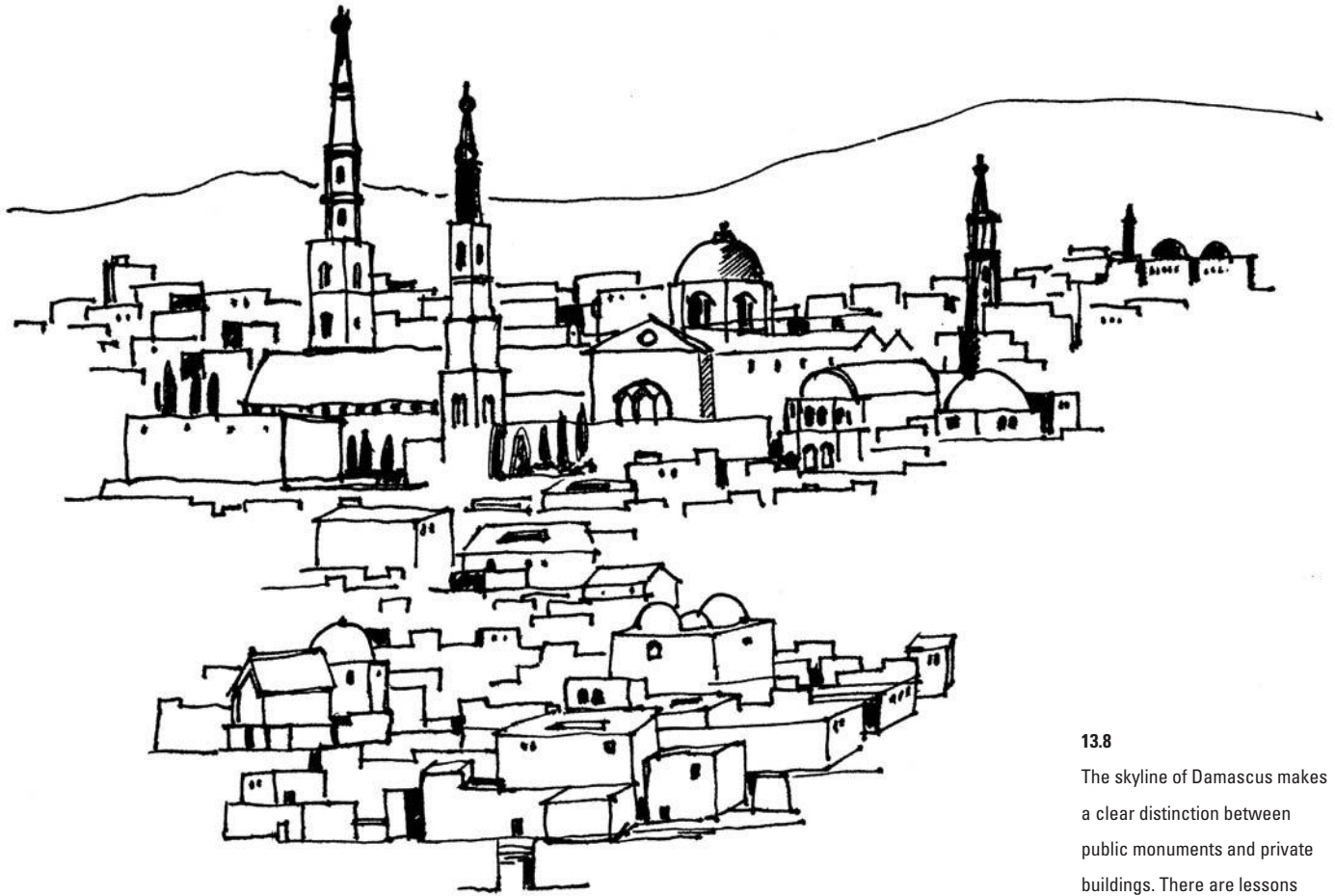

OLD DAMASCUS
BRIAN EDWARDS
2 0 0 2

13.8

The skyline of Damascus makes a clear distinction between public monuments and private buildings. There are lessons here for other historic cities such as Rome and Edinburgh.

13.9

The church spire not only landmarks the Bastide town of Eymet, but provides a local reference point from the market square. The offset side street is terminated by the church.

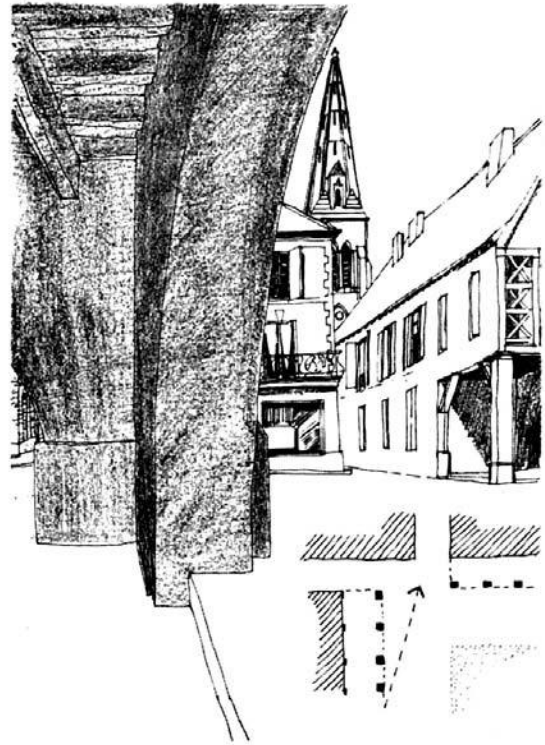

any visual clues to guide them. Even motorists find themselves bewildered by a series of urban roads that sweep between near-identical buildings and across roundabouts, each detailed in the same fashion as the one before. Tall buildings help us find our way around as long as each stands out from its neighbours. This is another reason why we should be cultivating architectural distinctiveness, not conformity, in tall buildings, and placing these 'unique' buildings at key points in the city.

As in much townscape analysis, the sketchbook is the best vehicle for cultivating an appreciation of the issues outlined above. The sketch does not have to be too literal, but it should seek to understand the language of the city. As towns are very complicated subjects to draw, one must be selective and edit out the unnecessary detail. If a

drawing focuses upon skyline, then other elements in the view can be played down. And if a skyline feature is treated as an icon of the city (for example, Big Ben in London or the Eiffel Tower in Paris), then celebrate its presence with a bold rendition of it. There is a hierarchy in the skyline of most cities: representing the contrast between a central dominant structure and the supporting towers nearby can produce a sketch that is not only instructive but dramatic.

Chapter 14

Gateways, entrances and doorways

The sense of arrival at places is important, and in recognition of this many cities and the buildings within them have elaborate gateways or doorways. Entry points are usually celebrated in this way except in the most utilitarian structures. At the other end of the scale, entry may consist only of a roundabout on a ring road or a collection of petrol stations marking an approach into a modern town. Historic towns, on the other hand, are normally well defined in terms of entry points, often because of the need for fortification in the past.

Entry points given celebration through architectural display are a common feature of urban design in Europe and beyond. The grand gateways of Paris, Rome or Kyoto serve to define arrival at the city centre or the entry point into a special neighbourhood. Gateways into the city, into districts of the city and then into public buildings establish a legible hierarchy. In similar fashion entrance doorways into private houses often lead to lesser doorways within the interior. A sense of hierarchy between outside and hallway, then between hallway and living rooms, and living rooms and kitchens is part of the everyday language of domestic design. The same should apply to the city.

Modern gateways are rare, though the need for crime prevention through territorial definition and surveillance of entrances has led to their revival of late. Such gateways

into private housing estates or industrial parks serve both functional and decorative needs. They define entrances into distinctive domains in much the same way that gateways in historic towns give expression to the privacy or security needs of different groups or classes of people.

Gateways and doorways are rewarding subjects to draw. As they define routes into and out of places, they provide a visual tension, which derives from a well-engineered constriction at a certain point. Often a narrowing of the route is supplemented by a change of direction or level. The materials of the road surface might also change at critical points, and there may be windows or arrow slots overlooking the space. Such gateways do not only occur at the edges of towns but at the entrance to distinctive neighbourhoods within them. In Oxford, for instance, the gateways to many of the colleges are so treated, as are the palace grounds in princely cities such as St Petersburg or Prague. A modern trend is to define neighbourhoods of the city by such means, for example the Chinese gateway in London's Soho. Here the urban designer has the challenge of selecting an appropriate entrance, and giving it definition through symbolic structures at the edge (as in Piazza Del Popolo in Rome) or in the centre of the space (as in the former Euston Arch in London).

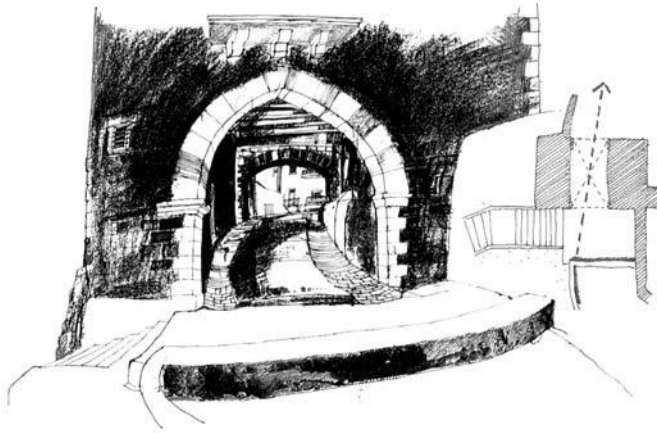

14.1

The gateway into the old town of San Felice Circeo, Italy, is marked by an abrupt change of direction. Once a fortified entrance, the gateway has only symbolic value today.

14.2

This residential courtyard alongside a busy road in Holt, Norfolk, is marked by a pair of gatepiers and screen wall. The area is clearly identified as private territory, not public.

Most gateways derive their justification from questions of security, but they also perform a useful function in terms of legibility. Big cities are perceived as collections of villages or neighbourhoods. Each should have its own community focus, public buildings and entrances. The edge of the 'village' is often defined by a major road or railway line with entrances marked by significant buildings. Often, as in the approaches into Hampstead Garden Suburb, London, the entrance buildings look like gateways and suggest an element of celebration. Hence to draw them is not only enjoyable but instructive of the nature of cities.

The modern movement in architecture and town planning played down the question of entrances. The wish to depict an air of democracy and freedom led to openness, not enclosure, in urban design. As a consequence, the twentieth-century city became windswept in appearance, with spaces between buildings lacking territorial definition and used mainly for low-grade activities such as car parking. The re-creation of boundary, edge and gateway is one of the challenges faced by current urban designers. Modern cities are undergoing a crisis of legibility that the introduction of gateways, using perhaps the roundabouts on the inner ring roads as a starting point, would help to solve.



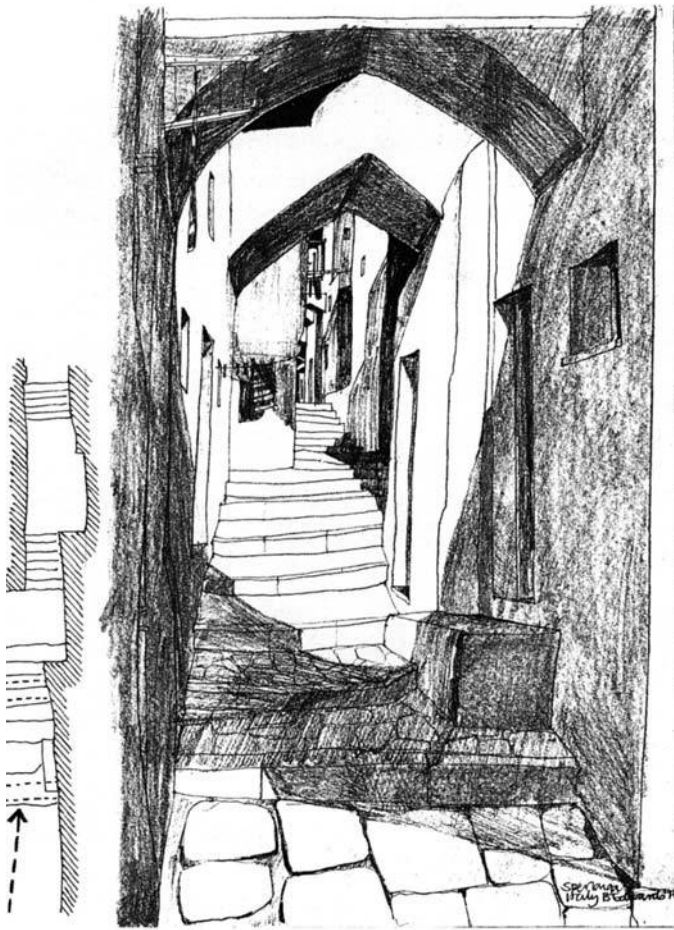

14.3

This passageway through Sperlonga in Italy is divided into zones of territory by the presence of big overhead arches. The route becomes progressively private as one ascends.

The perception and definition of 'place', from the regional scale to the domestic, is of crucial importance to design. A regional identity bred of cultural, geographic and social factors will lead to a Europe of variety and pluralism, as against monotony and standardisation. In this, gateways and boundaries are important. Between England and Scotland on the M74 there is no customs point, but a stone wall and piers on either side of the motorway proclaim the entrance to Scotland. This gateway is purely symbolic – it makes manifest a desire for national identity. One could argue that Dover is a gateway to Britain, with the white cliffs performing a similar iconographic function as the walls and piers across the motorway north of Carlisle. Seen in this way, Dover is an entry point establishing the first taste of Englishness for many people. The town is, therefore, setting standards of culture and design for the whole country and should be designed as an entrance way rather than simply as a seaside town.

Many engineering structures serve secondary functions as gateways into cities. The Humber Bridge is a gateway into Hull, as is Robert Adam's Pulteney Bridge into the centre of Bath. Gateways, therefore, come in many forms and not all are conventionally designed as entrance porticoes. Bridge engineers increasingly see their structures as entrance points and design them in a fashion that celebrates arrival.

A gateway is best regarded as a deliberate break within a city wall or the careful marking of a boundary of territory. It is important to draw both the boundary and the break, for each is supporting the same purpose. Sometimes the boundary is clear, as with medieval fortifications, but often the territorial edge is not so well defined, and you may have to use your imagination to see the architecture as gateway markers. For instance, an urban fringe may be marked by a line of bungalows and the point of entry by a pair of car showrooms facing each

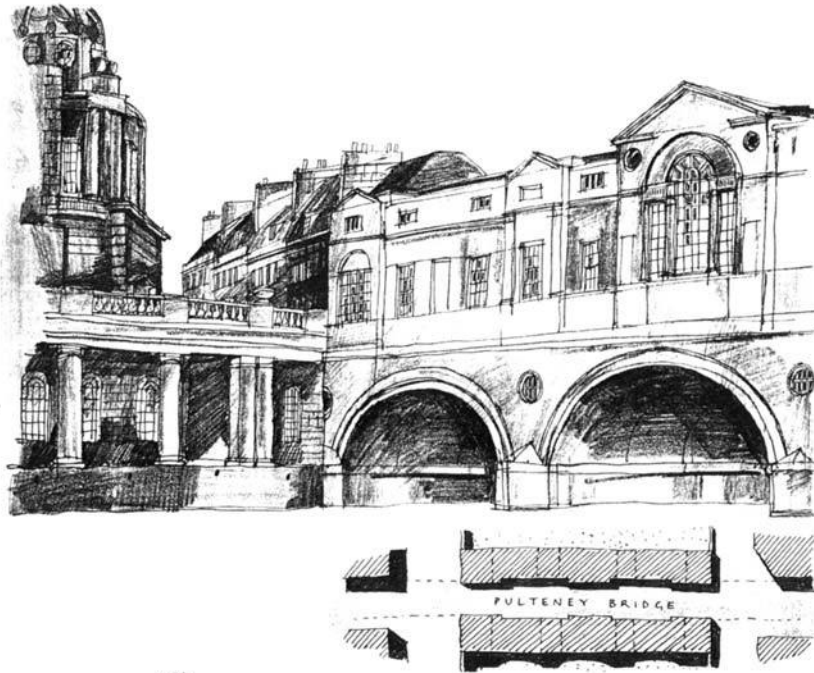

14.4

Robert Adam's Pulteney Bridge provides an elegant river crossing and a gateway into the centre of Bath. Here the bridge is lined with shops which look outwards over the river.

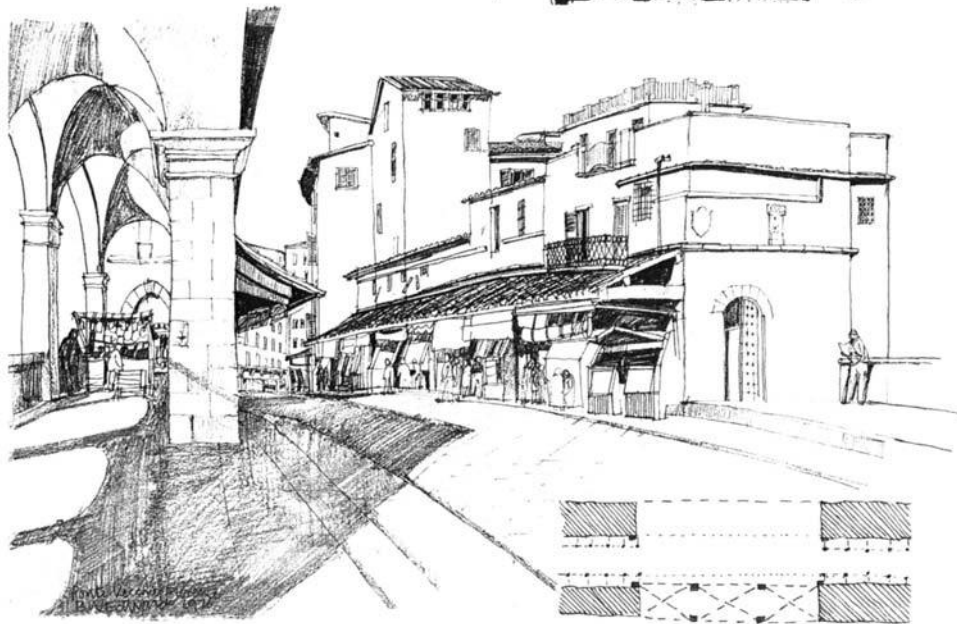

14.5

The Ponte Vecchio in Florence also acts as a gateway into the city and a shopping street. Space is provided for stall holders beneath the arches of this handsome structure.

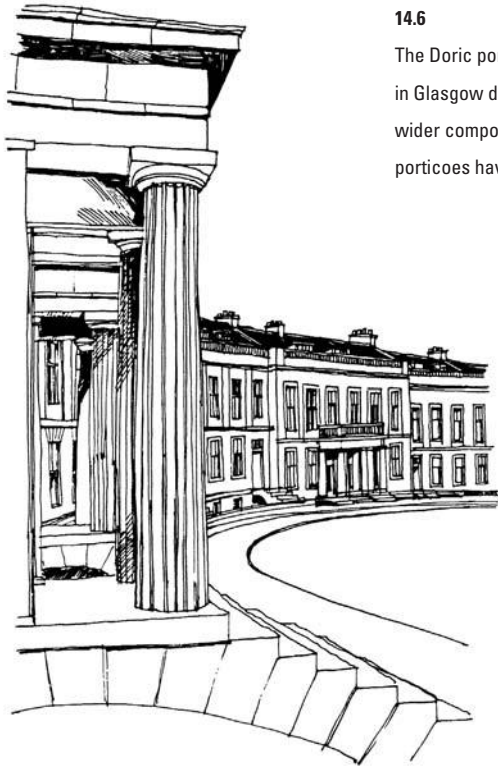

14.6

The Doric porticoes to this imposing crescent of houses in Glasgow define entrances and provide a rhythm to the wider composition. By linking together entrances the porticoes have a scale in keeping with the crescent.

14.7 a and b

Gatepiers are often part of the decorative tradition of older areas. These splendid gatepiers from a middle-class suburb in Glasgow both define the edge of private territory and enrich the public realm.

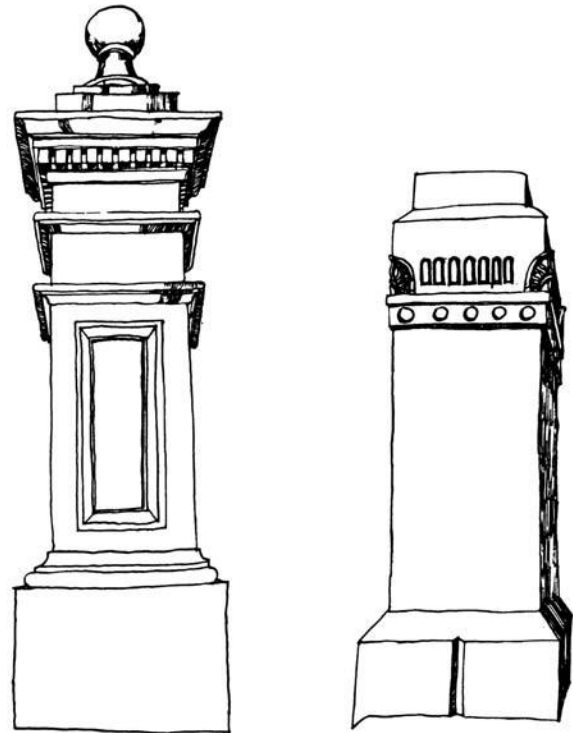

other across a main road.

Within the town, entry points exist though they may not be immediately apparent. A roundabout or exit ramp from a motorway may serve as an entrance gateway with, perhaps, a tall building marking its presence. Again, the artist must employ some insight and imagination to see these as modern gateways. Having sketched such a scene, it is easier to imagine a cluster of buildings making an urban gateway – you can move from description of the present situation to proposing some future change.

Lesser gateways in a town are quite common. Many modern shopping centres employ expressive portals in order to announce the position of entrances to malls or car parks. The language of entrance and advertising is often skilfully exploited in such areas. In historic towns

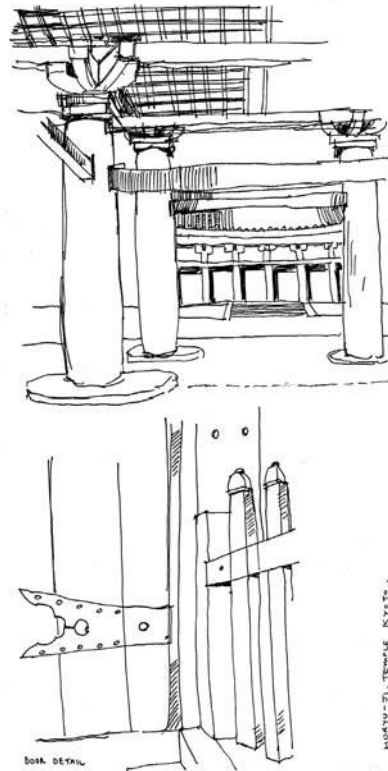
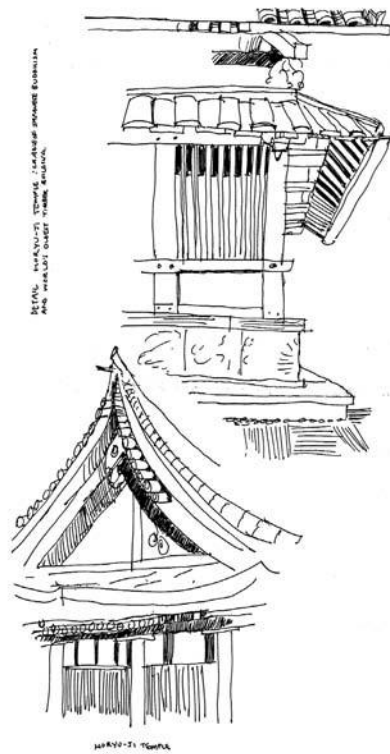

14.8

These studies of doorways and gables at Horyu-Ji Temple, Kyoto, show the benefit of articulating construction for aesthetic effect. The building is reputed to be the oldest timber structure in the world.

the gateways into cathedral closes or market squares are sometimes given civic expression, and deserve sketchbook analysis. In much the same fashion large buildings have imposing entrances that tell you immediately where the main doors are located. Town halls, Victorian railway stations and court houses all employ a simple language of entrance definition usually incorporating columns and pediments. By way of contrast, modern buildings (especially those of the 1960s and 1970s) often fail to mark their entrance, so that, for example, to find the doors to the Sainsbury Centre at the University of East Anglia is an unwelcome trial.

Expressed entrances frequently open on to interesting interior hallways, which lead the visitor to secondary

doorways and corridors. The progression through from street, to entrance, to interior is periodically marked by elaborate doorways. The sketchbook study could focus upon the processional route and its punctuation, or upon the details of the portals or doorways. If the latter path is followed, the door furniture and aspects of craftsmanship could be highlighted.

Doors and doorcases are difficult subjects to draw. It is worth spending time on them as they often represent a greater amount of architectural investment than much of the remainder of the building. Georgian doorways are particularly complex subjects, but at least ensure, when you are sketching them, that the proportions are correct, for this is what probably most concerned the original

designer. In your drawing you can simplify the decorative carvings or simply record one section of detail, but the proportions of width to height of the door and of any panels should be depicted as accurately as possible.

Many doorways or portals contain the coats of arms or inscriptions of their benefactors. The presence of such embellishment simply highlights the symbolic importance of doorways or gateways. Much recent design has sought to resurrect the language of the doorway and to revive its spiritual importance. In terms of building design, much has been achieved in the past ten years, but in the context of the town or countryside as a whole, the idea of gateways has not received as much attention.

If the culture of Europe resides in her distinctive cities as against countries, then doorways, gateways and entrances are very much part of local and regional character. In Barcelona, for instance, the approach to the design of entrances is quite different to that employed in Glasgow – the Catalan tradition is far removed from the Celtic one. To maintain these differences, not just between cities but within them, the freehand sketch is a vital means of recording, understanding and cultivating a climate for preserving local idiosyncrasies.

A good exercise is to search out entrances at the various scales – urban, district, neighbourhood, building, interior, etc. Each can be recorded and related to the other in the form of a network or in terms of spatial hierarchy. By relating the scale of the doorway to its sphere of perceptual influence, one can begin to understand the language of cities and where the visual clues become disjointed. Cities encompass patterns of behaviour and networks of design, with doorways providing the links between one system and another. Hence, of all the architectural elements, few have more symbolic value than the doorway or portal.

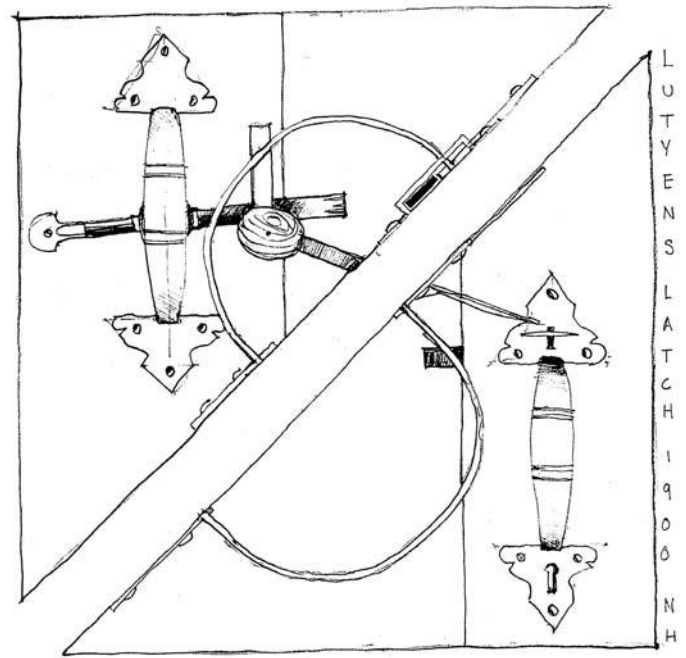

14.9

Detail of a door latch at Goddard's, designed by Edwin Lutyens. Such handles are often the first point of contact with buildings and deserve particular attention. (Nick Hirst)

14.10

Study of entrance sequence
at Goddards as analysed by
Nick Hirst. (Nick Hirst)

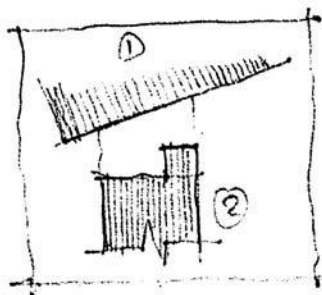
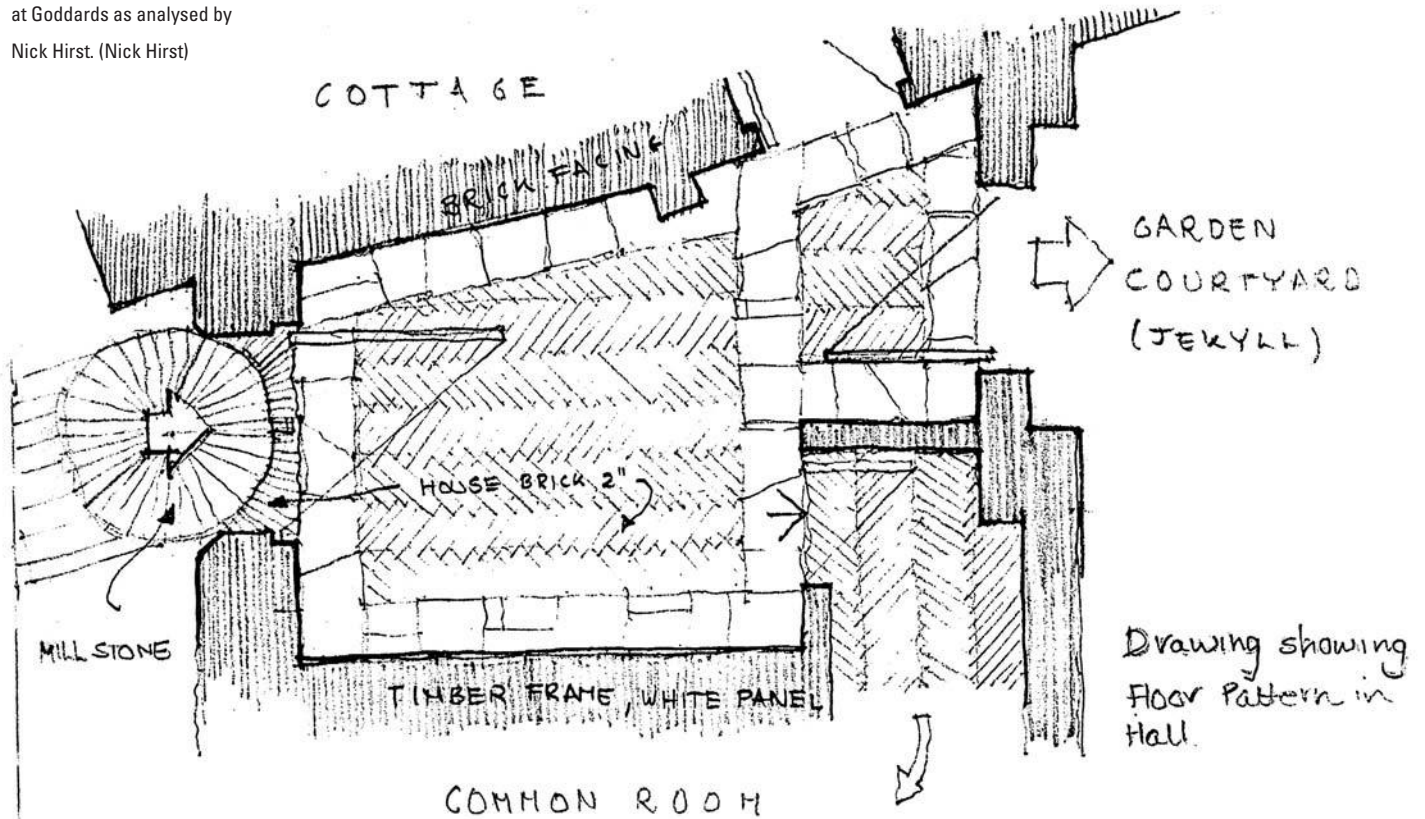

HALL SPACE FORMED BY INTERSECTION OF THE TWO BUILDINGS

- ① THE BRICK COTTAGE (PRIMARY)
 - ② THE INFILL COMMON ROOM, (SECONDARY)
- ... CREATING THE HALL (TERTIARY ORDER.)

Chapter 15

The façades of buildings

Like an honest face, the elevations of a building should tell you something about what function it serves, how it is built and when it was constructed. In addition, the degree of embellishment or grandeur probably provides clues to the civic importance of the building. By drawing the façade of a building, you will gain insights into the intentions of the architect and his or her aspirations as an urban designer. Additionally, you will probably understand better the role of the building within the social or economic structure of the area, the reason for employing a distinctive style or pattern of architecture, or the justification for adopting a particular mode of technology.

Your freehand sketch is, therefore, both graphic description and historical analysis. Generally speaking, historic buildings are more complex structures than modern ones, partly as a result of layers of change that have left their mark on the elevations, but mainly because they do not subscribe to the simplified abstraction of contemporary buildings. In the past the role of a building may have been to decorate a street, terminate a vista or provide a supporting role to a public monument. Today buildings are more likely to express their structural prowess, or their use of a sophisticated cladding system. Whichever expression is sought by the modern architect, it is unlikely to relate directly to wider civic ambitions.



15.1

This Edwardian office building in central Glasgow tells you that the public functions are to be found on the ground floor with the entrance well marked. Above is found repetitive office space.

Drawing the architectural façade may highlight some aspect of current or historical theory of design, or the sketch may simply tell you about the social pattern of living at a particular place or time. The main point is to get beyond the surface of the drawing into an analysis of social and technological factors or of design theory. Whether you choose to sketch a city or country building, a private house or public monument, a modern structure or ancient one, the same general rules should apply. By drawing the façade of a building, you are focusing your attention upon the principal area for expression exploited by architect and engineer alike. The method of expression may be obvious – perhaps by the use of exposed columns – or more subtly – perhaps by the skilful adoption of proportional harmonies. Remember that, though the designer of a building may seek to link the exterior expression to the interior pattern of spaces and functions, he or she is mainly concerned with how the building looks from the outside. The yardstick by which to judge architectural quality is primarily that of the elevations.

CLUES TO INTERNAL FUNCTION

Many buildings employ a visual code based upon making manifest the function of the building through elevational expression. The clues are both direct and indirect. With old industrial buildings, and some modern ones, cranes, lifting hoists and large door openings announce the presence of a warehouse. The office block may betray its function through the use of repeating grids of windows, strip lighting visible through large sheets of glass, and the lack of curtains or blinds. Likewise a modern block of flats will perhaps have expressed balconies, which provide 'gardens in the air', different window sizes and security systems around the main entrance. Designers wishing to exploit the functional clues may link the balconies into bands 20 or so storeys high, or raise the block of flats on



15.2

The designer of this small cinema in Ukiah, California, gives expression to the tower and canopy in a fashion typical of the 1930s. The tower acts as a hinge around which the rest of the design pivots. The bottle-cap shape of the top of the tower alludes perhaps to the café found inside.

stilts to provide space at the ground level for common facilities such as laundries or shops. In the case of office blocks, the architect may allow the entrance to project forwards with a canopy for signage, or change the grid of windows where conference facilities or staff refreshment areas are located. In this way there are clues to both the function of the building and to that of its various parts.

Many people interpret these visual codes when deciding what the functions are within a particular building. We are all familiar with the traditional use of columns to mark an entrance to a public building, the use of a rotunda to denote a space of importance inside or an atrium marking a gathering space within the building. This simple language of expression can be found in provincial court houses as well as in many modern office buildings in business parks. On a more mundane level, a single-storey structure with high-level bands of windows denotes accommodation for utility companies or perhaps public toilets. These buildings do not necessarily require signs: their appearance tells most people what goes on inside.

A recent trend in architecture has been to enliven the façades of dull buildings such as offices by exaggerating on the outside the differences in internal function. Many



15.3

Hill House by Mackintosh does not have a principal front. The design grows naturally from the plan with living rooms, master bedroom and staircase clearly expressed on the outside.

modern office blocks contain atria both to help with the control of the internal environment and to provide space for informal staff meetings. By bringing the atrium to the outside, the elevations offer a play of solid against void. In addition, as the atrium often contains an abundance of trees and shrubs, it can appear as if an area of garden had been trapped inside the building 'envelope'. Assuming clear glass has been employed, the outside observer can see into the office building, so that not only the elevations are enlivened, but internal activities are also relayed to the street outside. Moreover, if the building entrance leads through the atrium, a lightweight canopy may project forward, thereby enriching further the building's façade. By such means, dull architectural subjects can be made interesting, and monotonous façades more lively.

The more that internal functions are allowed to express themselves externally, the richer become the elevations. The classical language of entrance portico, colonnade, rotunda and dome gave expression not just to different structural members or constructional systems,

but also to the internal activities or functions of a particular building. The façade of a classical or neo-classical building is not a flat plane, but instead a series of layers of connected structural or decorative parts. Added to this, the interest in pure geometry of the neoclassicists led to an architecture consisting of cubes, circles, semicircles and triangles. Hence an abstract language of shapes forming the structure of a building was counter-balanced by surface decoration, which often denoted the functions housed. A typical building of the period was broken down into parts, with each serving a different function and given a separate form of expression. In addition, the public was in many cases allowed to penetrate part of the edge of the building before reaching the main entrance. A transition space for meeting friends or colleagues was therefore provided, often within the thickness of the wall or within the depth of a projecting porch or recessed entrance. Elevational richness thus derived from a consideration of how people behaved when moving from the outside to the inside of a building.

15.4 (right)

The façade of this Renaissance church in Gaeta, Italy, creates a grand impression to a city square. The architect has concentrated on the front rather than on the whole building.



15.5 (far right)

The Barcelona Pavilion by Mies van der Rohe seeks to occupy the space around its edge by wings of structure and overhanging roofs. The building, pool and paving area are united by a consistency of approach.

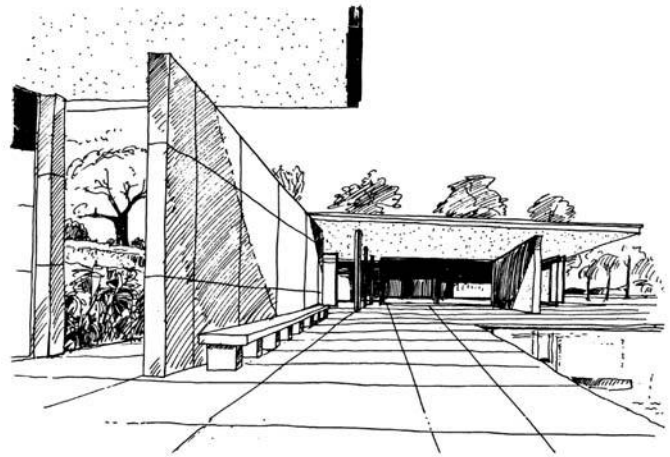

The cinema is one of the more interesting building types of the twentieth century. It gives expression to its function as a building for public gatherings – it makes its presence felt by a dramatic tower or exterior sign, the roof of the auditorium rises above the surrounding rooftops and the entrance, foyer and bars are often separately expressed. As buildings, cinemas are easily recognised and rarely confused with their sister building – the theatre. Since cinemas require few windows, designers have traditionally concentrated instead on the manipulation of mass and surface decoration. Brickwork is often arranged in panels, allowing a tension to be created between the juxtaposition of horizontal and vertical lines. Entrances are light and airy and contrast pleasantly with the solid auditoria. In sketching such buildings the artist should dwell upon these points in order to learn about the design of cinemas through the process of drawing.

CLUES TO STRUCTURAL SYSTEMS

It is a modernist maxim that buildings should give expression to their means of construction. A search for authenticity in architecture marks much of the twentieth century. The trouble is that to express nothing but the structure or construction of a building can lead to rather dull architecture. Freehand drawing is, however, a handy means of understanding structural arrangements. Victorian architects such as Richard Norman Shaw used the sketch to record the skills of medieval carpenters or the methods employed in framing church roofs. Today you can use the freehand drawing to analyse the steelwork of modern structures such as Lord Foster's tree-like roof trusses at Stansted Airport, or the concrete framing of a modern grain silo.

Many modern architects are more at home giving expression to the structure, construction and servicing of a building than to function. This is partly because the use of a building changes fairly quickly over time and hence to make functional expression the main aim of the design

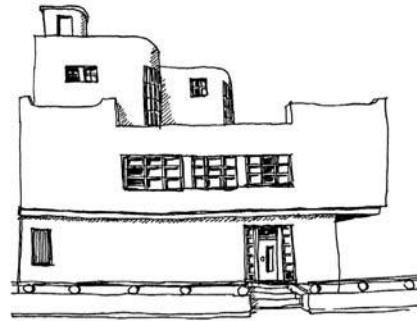

15.6a, b, c, and d

These studies of the façades of 1930s buildings on Faro Island in southern Portugal show the influence of international modernism on seaside architecture.

can make a nonsense of a building in the longer term. But the main reason is that modern technology has made twentieth-century buildings more exciting structurally than in any other way. Hence designers such as Renzo Piano, Sir Nicholas Grimshaw and Sir Michael Hopkins concentrate on structural and material daring in preference to proportional harmony or the expression of a building's programme. It is often a case of constructional invention being linked to new ways of servicing buildings, with the result that our current 'green' awareness finds expression in buildings with solar panels, stepped sections and ventilating chimneys.

There are three broad ways of constructing a building: by frame, by load-bearing wall, and by self-supporting panel. Framed structures probably pre-date the others

simply because of the wide availability of building timber in the ancient forests of the temperate world. Load-bearing brickwork was introduced into Britain by the Romans and began to become commonplace as timber became scarce in the late Middle Ages. Large panel construction is chiefly a twentieth-century invention and has the benefit that it can be prefabricated and speedily erected. As the panels are load bearing, the walls provide both enclosure and structure within the same unit and this leads to obvious economies, though often at the cost of aesthetics.

This simple classification of constructional systems can be enlarged to include suspended structures where the tensile rather than compressive strength of materials is exploited. A mixture of structural systems is frequently

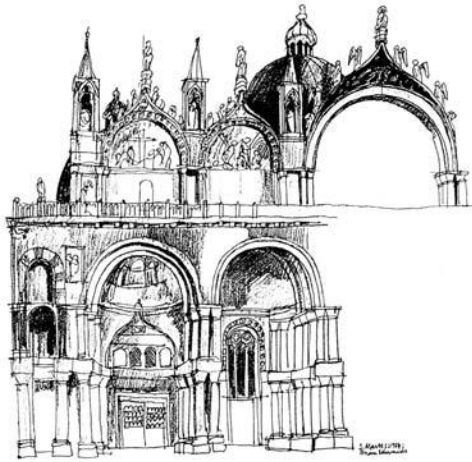

15.7 (left)

In this drawing of a section of the west façade of St Mark's in Venice, the structural logic of arches and columns is not obscured by lavish decoration. Embellishment here consists of reinforcing the logic of the structure by sculpture and friezes.

15.8 (below left)

The varied activities in this harbourside development in Gaeta, Italy, are expressed in extensions to the main building and in the form of cheerful signs.

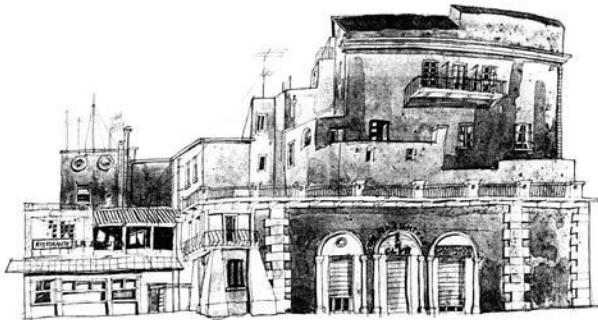

15.9 (below)

The brute force of shuttered concrete is well expressed in these buildings on London's South Bank. The style known as Brutalism sought to exaggerate the scale of construction and the visual possibilities of concrete left in its natural state.

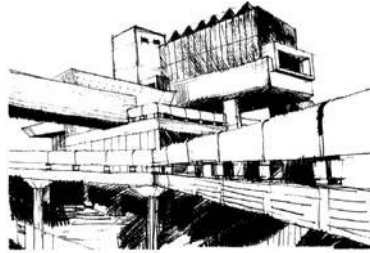

represented on the same elevation of a building, thereby adding to the complexity of the façade. For example, the Mound Stand by Hopkins at the Lord's Cricket Ground uses load-bearing brickwork and stretched lightweight fabric canopies to good effect.

The degree to which the structural system employed is made visible determines the appearance of the building. A concrete-framed office can have its basic structure disguised by a glass cladding system that gives no expression at all to the framing members. Alternatively, the structure can be expressed, giving an otherwise bland façade a sense of interest or organisation in visual terms. A well-expressed series of columns and beams can absorb the visual chaos of the modern apartment block, as exemplified by some of the poorer

areas of downtown Hong Kong. Your sketch can draw attention to the frame by highlighting its presence through shadows, or play it down in order to express some other aspect of the building. Frequently the use of an exposed frame gives expression to both the structural and functional logic of a building. Sir Giles Gilbert Scott's London power stations make manifest both the method of construction and the internal arrangements of complex, yet publicly visible, buildings. Although your sketch may focus upon the main structures alone, it is hard to overlook the architectural drama given by Scott to the generators or chimneys.

Load-bearing walls can be treated so that every brick, or block of masonry, is expressed, or designed so that the wall reads as a single panel of construction. From afar,

large areas of brickwork can appear to be seamless wall planes rather than composed of individual units, but different colours of brick are often employed to create patterns on a larger scale. Where bricks are mixed with stone, the relative scale of the parts of the wall can establish lines of tension, which eighteenth-century designers used to define edges and create visual frames. In many cases you will find that the whole façade of a brick building is trimmed in stone in order to create a 'picture frame' around the house.

The wall and its framing members are essential to the rhythm of a façade. Frequently the structural members become the main means of decorating a building. The classical orders established rules whereby embellishment subscribed to a predetermined plan. Often the orders obscured rather than expressed the structural logic of a building – and it was partly an escape from the limitations of the classical decorative language that justified the flight into the Gothic Revival and thence, a century later, into modern architecture.

It is rewarding to compare an architect-designed building of the eighteenth century to that erected by an engineer or surveyor. The design of a country house or town hall of the time would no doubt be correct from an academic point of view, but one would be hard pressed to identify clearly what method of construction had been employed. By way of contrast, an area of dockland would contain wharfs and warehouses of honest construction and simple, unadorned lines. The hand of the engineer would be evident in the use of robust arches, plain areas of undecorated brickwork and functionally expressed beams or roof trusses. In both cases the façade makes visible the values that led to the erection of the building – values that the act of drawing should reveal.

Whether you are drawing for pleasure or discovery, the architectural sketch is best rendered in good light – preferably sunlight. The texture of the various building

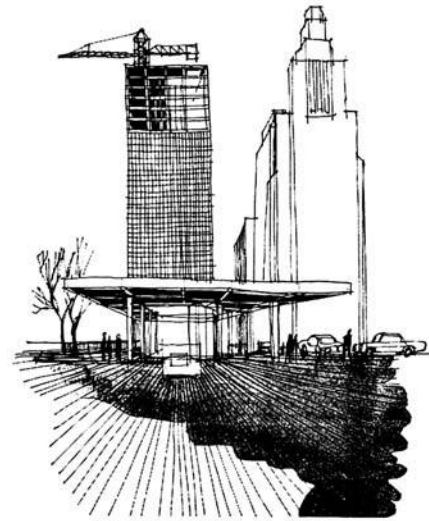

materials, the play of structure against background walling, the depth of windows and façade projections are better observed in strong light, and best depicted with the aid of shadows.

As in plan drawing, shadows or shading can enhance the three-dimensional qualities and bring alive qualities of the façade, which have become obscured by generations of soot deposits or by your own overfamiliarity with such buildings. The architectural sketch is a means of cultivating a personal sensitivity to buildings and to their construction. Whether your subject is a vernacular house, a modern factory or historic church, the sketch should make visible to you some of the key qualities of the architectural design.

CLUESTO PROPORTIONAL SYSTEMS

If you see the elevations of a building in more geometric terms, it may become evident that the design is based upon a proportional system of one kind or another. Many buildings of classical inspiration employ proportional harmonies based upon squares, circles and the golden section. Beauty was seen to lie in the adoption of shapes

15.10 (opposite)

These buildings in Chicago exploit not just the technical possibilities of steel construction, but the aesthetic ones as well. The contrast between the stoneclad skyscraper and the one finished in glass is immediately evident. Open public spaces like this demand a matching architecture of scale and interest.

15.11 a and b (below)

These drawings of Georgian terraces in Glasgow show how proportional systems can create elevation with repose and dignity.



and outlines that related well to each other and contained in themselves a harmonic repose. Hence the front of a house may be a double square on its side, with windows also in the proportion of a double square placed vertically. Sometimes an elevation may consist of a circle within a square or the placing and size of windows may be dictated by the diagonal lines of the golden section.

In modern buildings the repeating pattern of lines within curtain walling may also subscribe to similar rules of proportion. At South Quay Plaza on the Isle of Dogs in London Docklands, an office development by Seifert Architects mixes double squares, squares and diamonds to good effect. Here the buildings can be viewed across the river Thames, allowing the calculated use of harmonic subdivisions to have maximum impact on the observer.

Often architects draw attention to the key lines that they want you to read in order to understand the proportional system they are using. String courses may be employed or the building may be set upon a solid base (*piano nobile*). Frequently corner definition is employed, thereby creating a rectangular frame across the façade. By changing the colour, texture or nature of the constructional material, the designer is able to express the critical lines or planes of the proportional system.

The problem that architects often face is how to subdivide a large elevation into smaller parts that fix the position of windows, doors, columns, etc. in a logical fashion. A proportional system should embrace both large and small parts, and should also allow the observer to 'read' where the important elements or functions are located. Many modern buildings are so abstract in design that the same pattern is wrapped around all sides of a building irrespective of functional hierarchy. On the other hand, a study of older buildings, even functional ones like warehouses, can reveal the use of proportional systems worked out to a surprising level of detail, if you make the effort to uncover them.

SOURCES OF DECORATION

A modern abstract façade can add up to dull architecture. Similarly a severe historical building whose beauty derives almost totally from proportional systems tends not to attract our attention for very long. Just as a townscape made up almost entirely of modern office blocks can be a visually depressing experience, so too a district of buildings constructed according to strict classical principles can be quite lifeless. The Victorian writer on art John Ruskin was particularly critical of Queen Street in the heart of Georgian Edinburgh for this very reason when he visited the city in 1853.

It is a responsibility of buildings that they enrich the public domain. Frequently the sources of richness derive from the simple expression of how people wish to live. For example, an apartment block will probably contain balconies where families can sit in the sun, dry their clothes or grow their plants. These activities not only enrich the façade, but provide justification for the presence of certain architectural details: the balcony may be edged by a balustrade or a colourful awning may protect the area from the midday sun. Similarly French windows can add an extra dimension to a room by opening up a view on to the street, but because such large openings require closing at night for acoustic and visual reasons, there may be window shutters as well as doors and probably a lace curtain. All three features become part of the architecture of the façade – and worthy subjects for drawing.

Entrance doors are often similarly treated, and where there is a slight change of level, plants around the steps add to the diversity of the scene. As doorways need to be lit, there are often interesting light fittings projecting from the wall face and complementing the other special qualities of the entrance.

Each element of the building can be so treated. The celebration of function in this everyday fashion is part of

our architectural tradition. The more the façade gives expression to the activities of the building, the richer the architecture. Earlier we saw how the form of the building can be manipulated to allow people to 'read' the activities it contains, but here the detailed expression of function is the source of our interest.

Shops are a good example of how local colour can be provided at the base of buildings. Not only will the form of the building change to accommodate a different function, but there will be shop signs, goods on display and pavement activity to add diversity to the immediate environment. Where shops, banks and restaurants occur, there will probably be competition for space and attention, and here the architecture will probably respond. This visual richness bred of competition is a healthy aspect of the building façades of most high streets.

Decorative ironwork, applied columns, pilasters and banners are other ingredients of elevational embellishment. Often the orthodox will be distorted in order to attract attention: exaggerated columns may mark a shop or supermarket front, or ironwork may be twisted into the curving forms of Art Nouveau.

By focusing upon the decorative elements of the building façade, the student or artist will be able to relate embellishment to function. Pure decoration in architecture can become a sham unless it is justified by use or legibility. Although decoration is eminently drawable, the real benefit lies in relating the four main strands together – of linking structure, function, proportion and decoration into a united whole. Buildings are complex entities, and though a specific style or artistic movement may focus upon a particular aspect of their construction, most façades reflect a compromise between conflicting priorities. The freehand drawing can help break down the façade into its component parts, and in the process provide insights into the nature of architectural design.

15.12

South Quay Plaza on the Isle of Dogs seeks to apply proportional systems to give expression to modern office block.

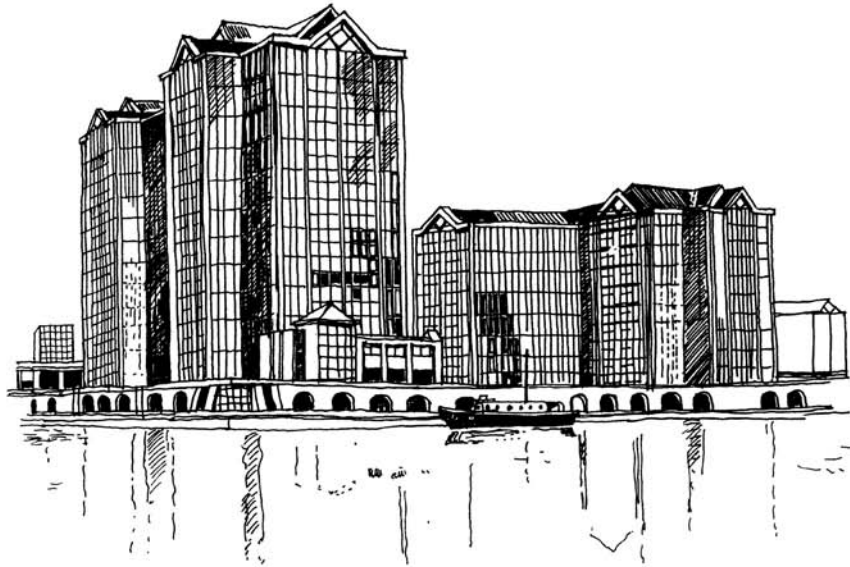

15.13

Buildings at angled corners are often given special treatment. Here at the Russell Institute in Paisley the façade rhythms reach a climax in a dramatic entrance tower topped by an Art Deco angel. Such buildings should be sought out and cherished. Note the classical subdivision overlaid by modernist principles.

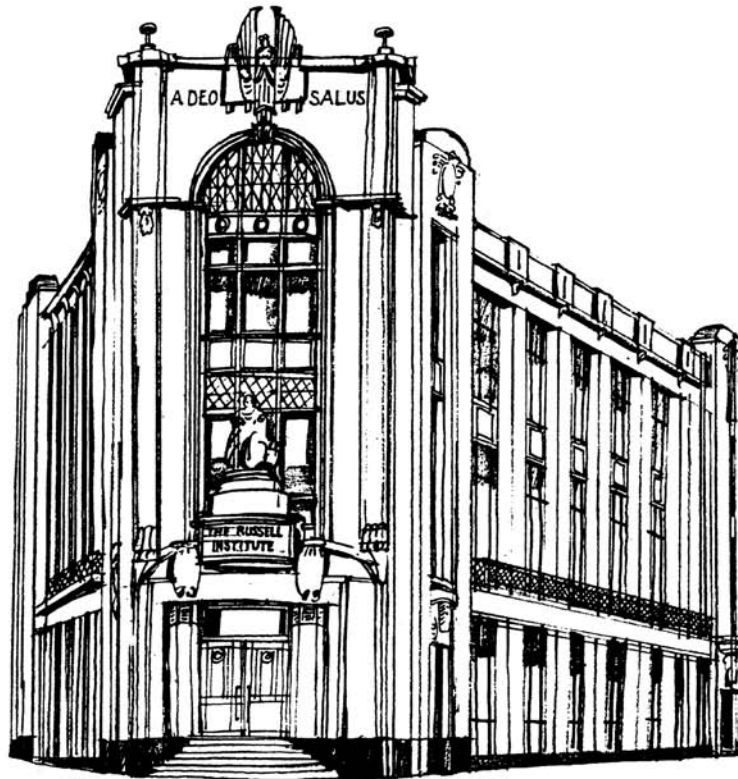

Chapter 16

Machinery, function and modernism

The functional character of trains, machinery and ships makes a pleasant contrast to the historicism or concern for applied style in buildings, especially very recent ones. Machinery makes no concession to surface aesthetics, and derives its visual qualities instead from meeting strict utilitarian criteria: rivets are left exposed and moving parts are placed on the outside for ease of access and servicing. The result of this unassuming functionalism is often to produce objects of rare beauty or structures of haunting presence. To draw them is to understand their essence as working objects and to appreciate their form. When placed against everyday buildings and landscapes, the industrial object has both an immediacy and charm that can be attractive to draw.

Sketching machinery is not easy, yet the functionalism of the subject often gives the picture great power. The 'functional aesthetic' is normally expressed at both a detailed level (in the bolts, welds and pressed metal panels) and in the general massing or arrangement of the subject. You have only to look at such essentials as the steps up to the cabs of diesel engines or the door handles of tractors to realise that a rugged utilitarianism reigns. If beauty is to be found in the machine-made detail, the same is true of these objects as seen in their entirety. Their silhouettes are often evocative, and the exposed

frames of such structures as pit heads and gantry cranes make them striking features in any landscape.

Industrial landscapes are often linear affairs. The parallel lines of railway tracks or dock basins allow the artist to exploit the directness of single-point perspective. The balance between horizontal and vertical lines is also important. Since trees are often lacking from such places or appear only as a self-seeded scrub, the lines of the industrial features are not generally softened by landscape. Hence the artist can approach the subject using 6B pencils and plenty of dark wash or crayon. The spirit of such places lends them to bold representation.

It is often a good idea to exploit silhouette, especially in structures that are quite high. Industrial buildings and working machinery are not normally painted – their colour derives from oily splashes, rusting steelwork and the hues of manufacture. In a landscape of flour mills and cement works much will look frosted by the white dust, and mining areas will be darkened by the colour of coal and iron ore. Such places tend to be dark and rather dramatic, with 'spillage' providing a counterbalance to sculptural shape. The best industrial scenes are almost sublime (to paraphrase the eighteenth-century Romantic Edmund Burke) in their honest juxtaposition of structure, dilapidation and enormous scale.

16.1

The construction of fishing boats, crab and lobster pots share a common interest in functional and practical design.

This sketch is from a beach scene on the Orkney Islands.

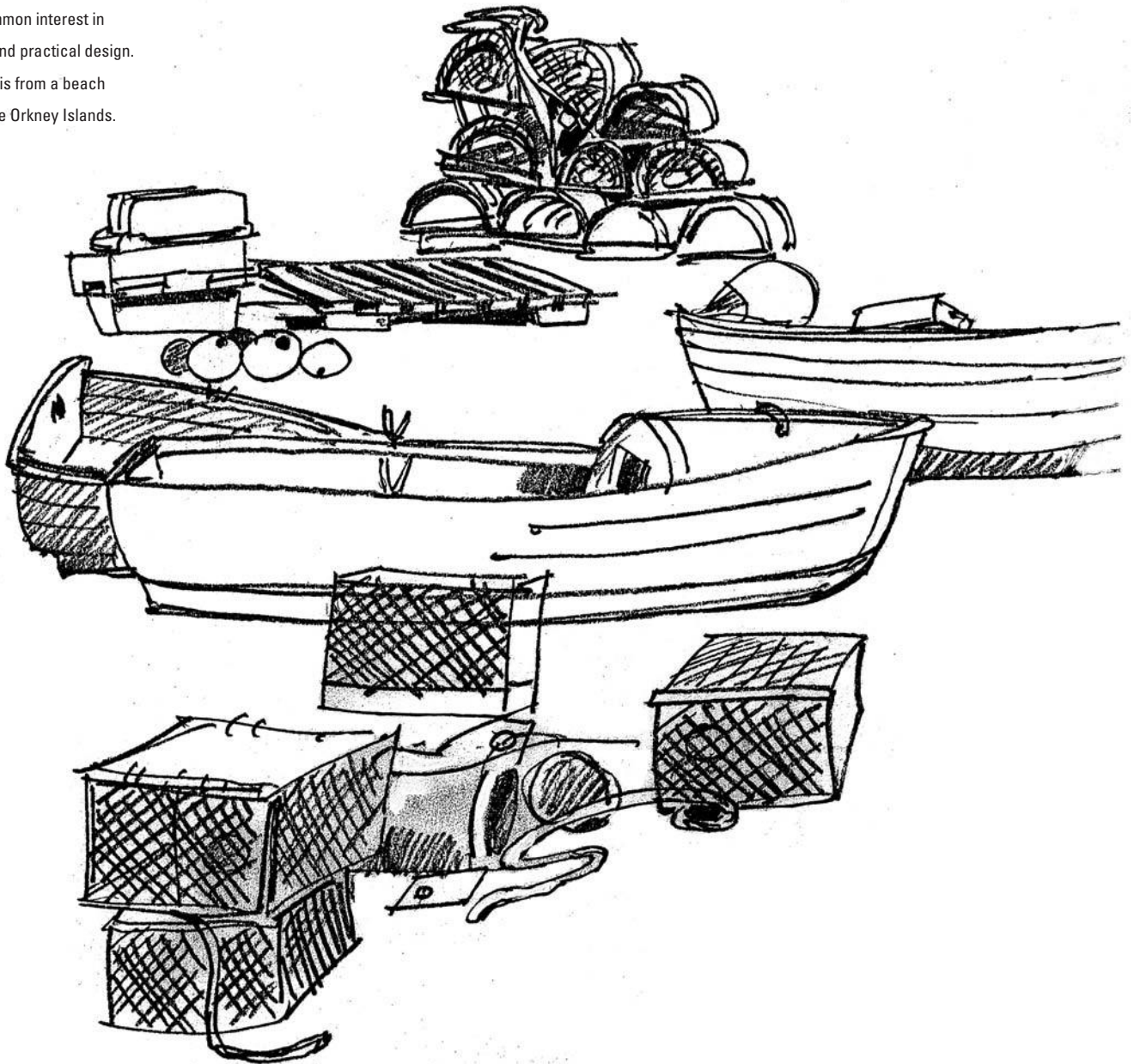

Graphics frequently play an important role within the functional landscape. The numbering of railway wagons and the alphabetic coding of buildings adds a further component to the air of rationalism. The graphic style is necessarily practical – a form of squared-off lettering tends to be used, often in conjunction with exaggerated scale. The scene (and hence the analytical sketch) can take on the qualities of a Russian Constructivist painting as a result of the almost abstract superimposition of graphics, structures and architecture.

As the lettering does not normally have to appeal to city sensibilities, it is often crudely painted or at least has a visually carefree style typical of industrial landscapes. In modern factory areas, the graphics are often part of corporate identity (as with British Steel) and have a corresponding lifelessness, but in older industrial areas the style of lettering can be rather idiosyncratic and hence more rewarding for the artist.

The sketches that result from a close scrutiny of industrial areas can have artistic value, as well as helping to teach us lessons about design. If buildings are designed purely out of practical consideration, with no special regard for appearance, then the resulting structures have a form quite different from buildings designed on aesthetic grounds. Only the 'high tech' modernists such as Lord Rogers and Lord Foster produce contemporary architecture that has qualities which derive from the spirit of our industrial tradition. These architects place the building services on the outside and leave cranes on the roof to suggest a flexible and utilitarian approach to design. Their use of sheet metal and an exposed, often exaggerated structure has obvious parallels with buildings associated with the manufacturing process. The Lloyds Building in London is a tour de force of such an approach to design, though to this author it is as unhappy in the City of London as a factory would be. But to understand some of the more assertive aspects of

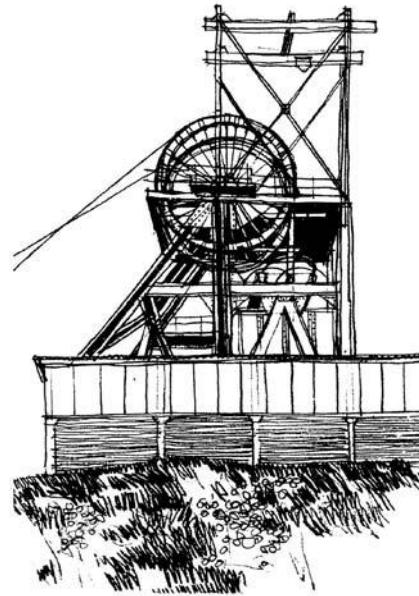

contemporary architecture, a few days spent sketching decaying pit heads at local coal mines or dilapidated warehouses at the dockside should prove invaluable.

The current fashion for a kind of fragmented modernism (known as Deconstructivism) has part of its origins in the architecture of industrial areas. The peeling away of façade to expose the structure, the distortions of scale and angle, and the expression of physical change or structural impermanence are qualities frequently encountered in factory areas or mechanical plant. When decay has set in, these monuments to functionalism can be romantic in the extreme, but they can also teach us much about the role of frame, panel, fixing and assembly. In analysing such subjects through the sketchbook, we can gain an invaluable insight into the construction of industrial architecture and machinery.

Nature, when it encroaches, has an interesting relationship with the industrial landscape. Trees are rarely planted as decorative elements – they simply seed themselves in odd corners or high up on the outsides of

16.2 (opposite)

Coal mines (here at Chislet Colliery in Kent) can be a collection of bold abstract shapes grouped into sculptural assemblies in open landscapes. They too offer lessons in architectural composition and construction.

16.3 (right)

This mechanical grab displays the muscular qualities of much industrial design.

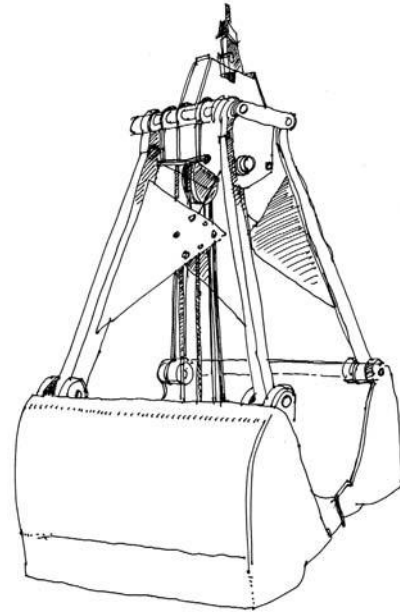

buildings. Wild flowers and creepers are also quick to colonise waste areas and these can provide an attractive foil to the straight lines of factory buildings. Try not to ignore the presence of nature – the odd weed or sprouting willow can add a welcome air of tranquility or contradiction to the sketch. Nature is also good at giving a sense of scale to the drawing. A typical industrial scene has an inhuman scale and though this is one of the charms of the subject, a few weeds (and even the occasional factory worker) will immediately establish the size of what has been drawn. The contrast in scale and texture between the built and natural elements makes not only attractive sketches, but is instructive of the connected role of townscape and landscape within our cities.

While buildings and cities are densely inhabited, many industrial scenes appear unpopulated. Instead fork-lift trucks, lorries and railway wagons tend to occupy the spaces between buildings. Since they are important elements in most of our functional landscapes, their

presence cannot be ignored. In many cases the style of the structures is reflected in the design or detail of the means of transport. Hence in dockland areas the wharves and cranes have features in common with the ships, and in factories the conveyor belts share a visual language with aspects of the buildings.

Sketching the structure of the industrial landscape has arguably more lessons to teach the designer of buildings or objects than more conventional architectural subjects. The lessons are best learnt through the sketchbook, but in addition the drawings themselves can be of great power and interest.

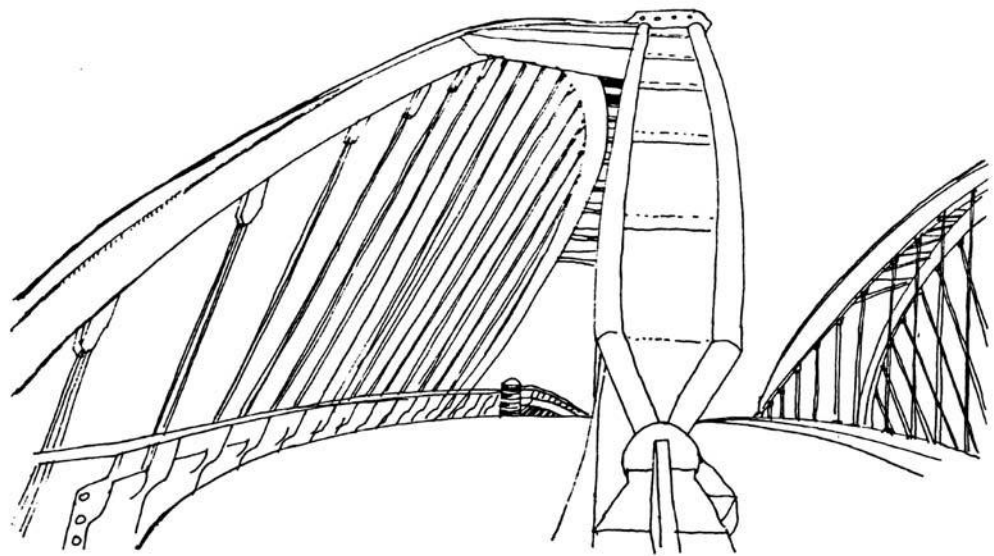
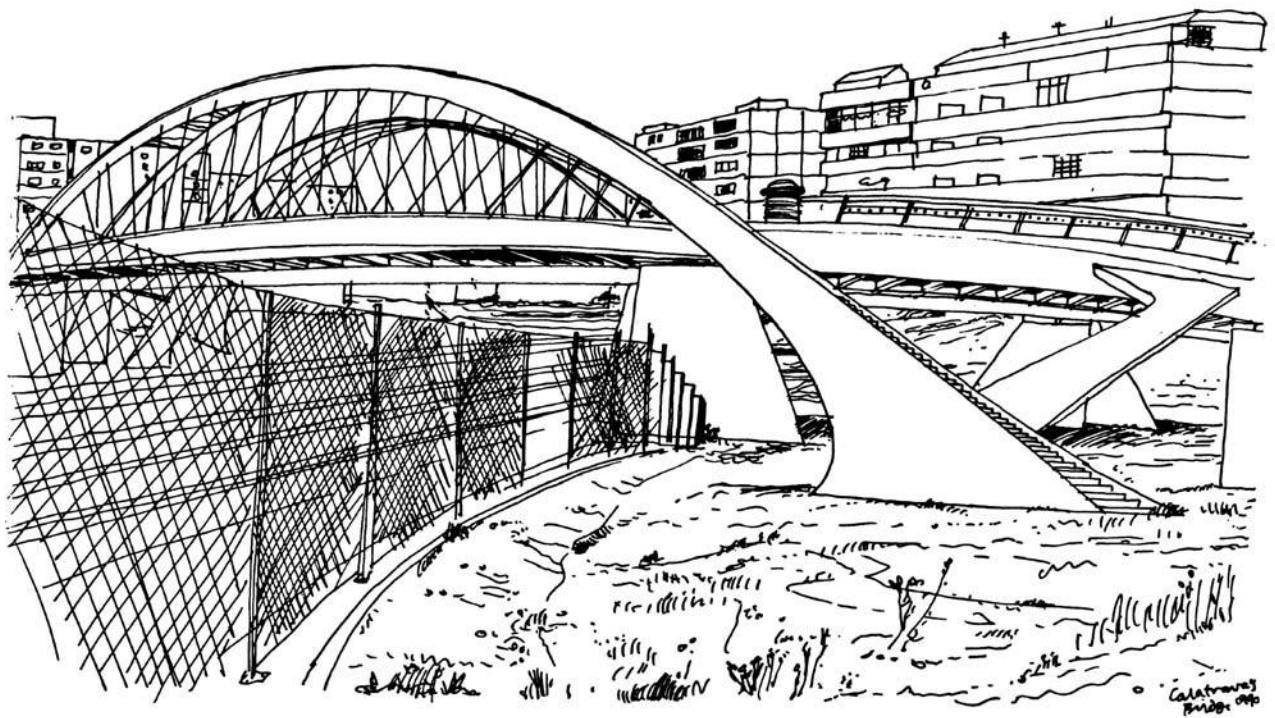

16.4 a, b, c and d

These sketches of Santiago Calatrava's bridge at Bach de Roda in Barcelona seek to capture this engineer's extraordinary grasp of geometry and form. Such structures can uplift the spirit in inner-city areas.

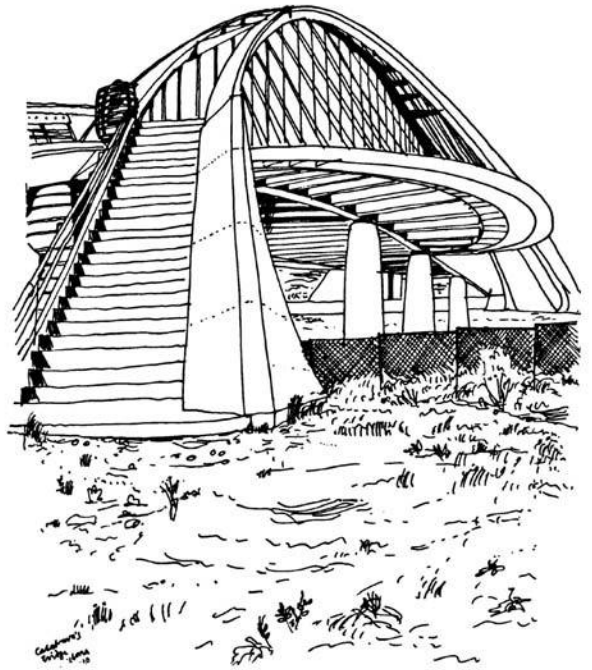
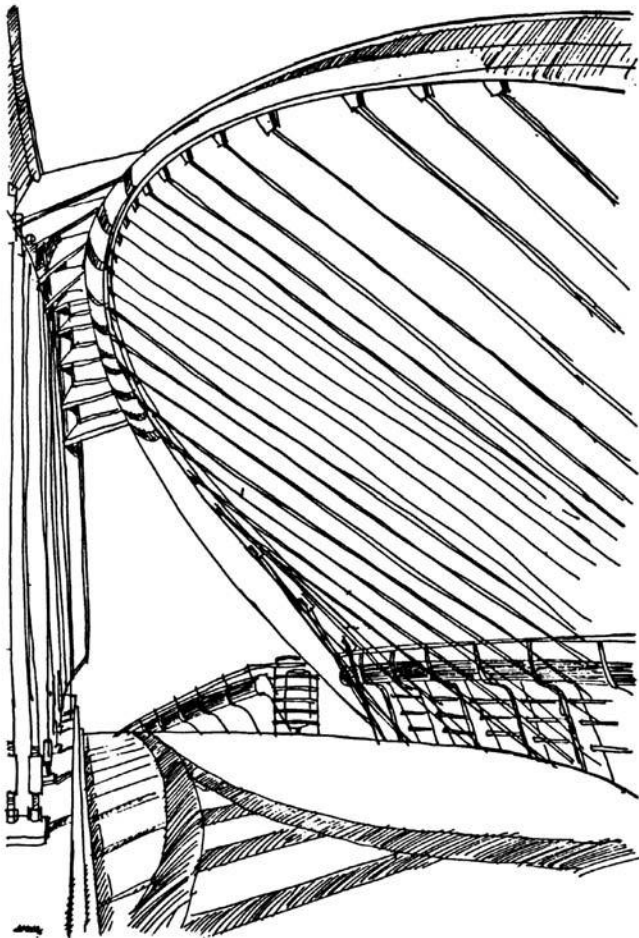

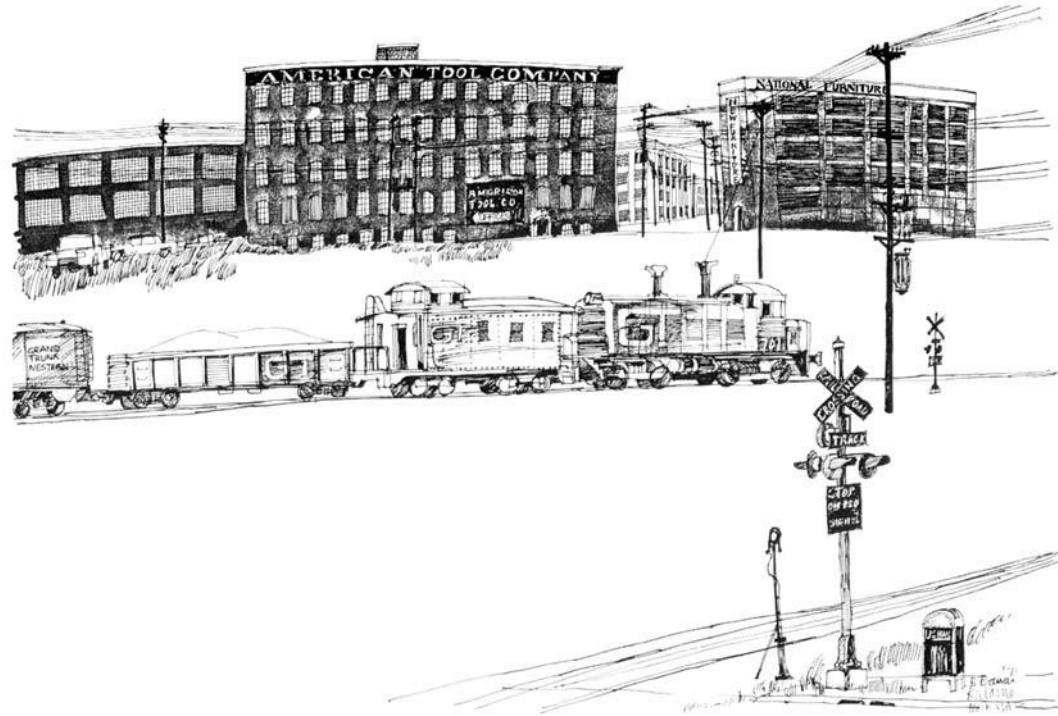

16.5

The character of the industrial landscape extends not just through buildings but the spaces between them. Here at Kalamazoo in Michigan, railway tracks, traffic signs, trains and telegraph poles establish an appropriate foreground to the factories

16.6

This Russian built bulldozer contains details and forms that could be translated into an architectural context.

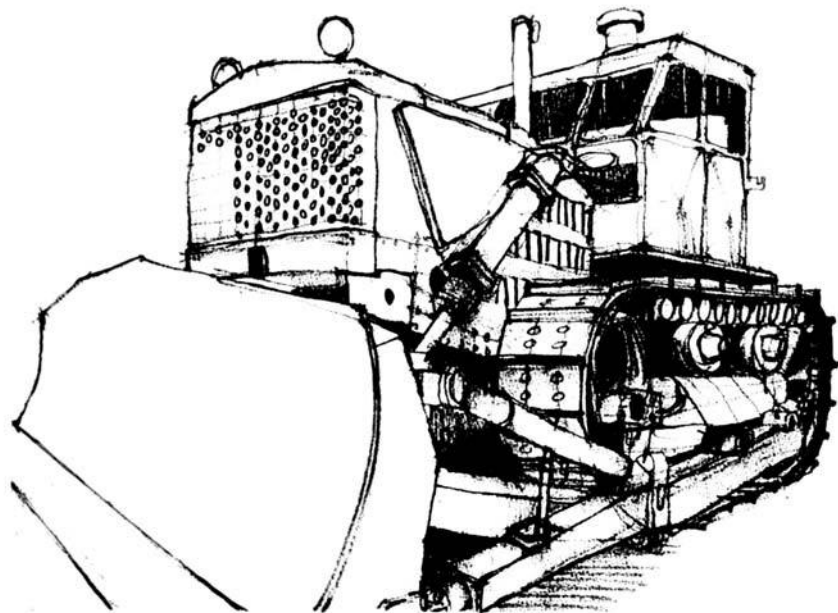

MODERNISM

With its geometric discipline and avoidance of superfluous decoration, the modern movement in architecture makes a good subject for investigation through drawing. The key principles of modernism, namely functionalism and honest construction, provide good material for the sketchbook. Space, structure, physical form and climatic response were driven by the principles of modernism from the 1930s to the end of the century. Although today there are new and perhaps more exciting ideas shaping contemporary design practice, buildings from a few decades earlier provide valuable insights into the spirit of the modern age.

Since light was a revolutionary force in much twentieth-century design, drawings that express the effects of light on space can be particularly useful. Sunlight and the corresponding patterns of shadows help bring modernist design approaches into focus. Space is less easy to draw but the use of shadow and shade along with strong black lines can provide a tangible element of the atmosphere sought by architects from Le Corbusier to Louis Khan. The use and delineation of line tells us a great deal about how an architect thinks. If one compares the thin but authoritative line of Mies van der Rohe with the chunkier and soft-edged line of Frank Lloyd Wright it prepares us for the difference in the resulting approaches to modernism. Our own drawings can use line in a way which respects these different qualities.

Line by itself can rarely express the emotional and shocking aspects of much modern architecture. The shock of the new often requires the employment of a wider range of graphic tools from colour to strong textures and dark, almost black shadows. Since the engineering precision and linearity of many twentieth-century structures mattered greatly, the use of straight edges can help in understanding and representing the

buildings of the age. Hence, the type and thickness of line is an important consideration in sketching buildings of the period. Also since line was the primary tool employed to represent edges, planes and the grids of construction, the abstraction of lines by twentieth century architects gives their buildings an intellectual quality.

Much modern architecture was sculptural, if not brutal, in character. The drawings made today should seek to capture the atmosphere of neighbourhoods created on the premise that 'form follows function'. This may require a more lively form of sketching than formerly employed, perhaps extending into collage and multiple image making. Whatever tools are used, the distinctiveness of the age should be expressed in the drawings made.

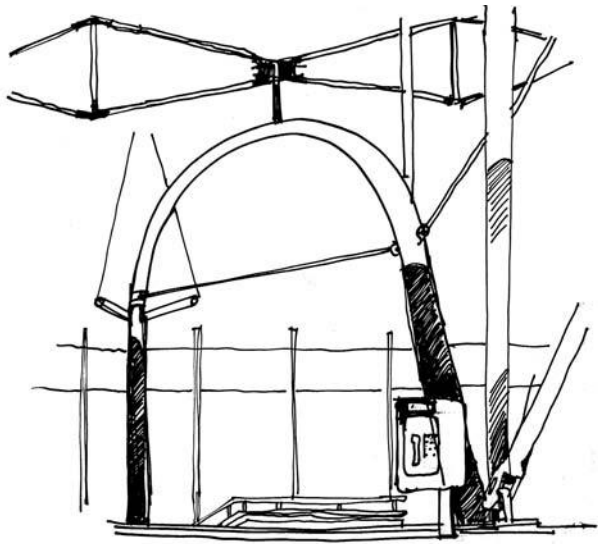

16.7a and b

These sketches of Lille Eurostar Station and Kansai Airport explore tectonic construction. The designs go beyond the honest expression of structure in order to create poetic spaces.

16.8a, b and c (right)

These sketches of modernist buildings from the 1930s in Antalya, Turkey, show the structural possibilities of new technical solutions such as portal frames and reinforced concrete.

Eurostar Station

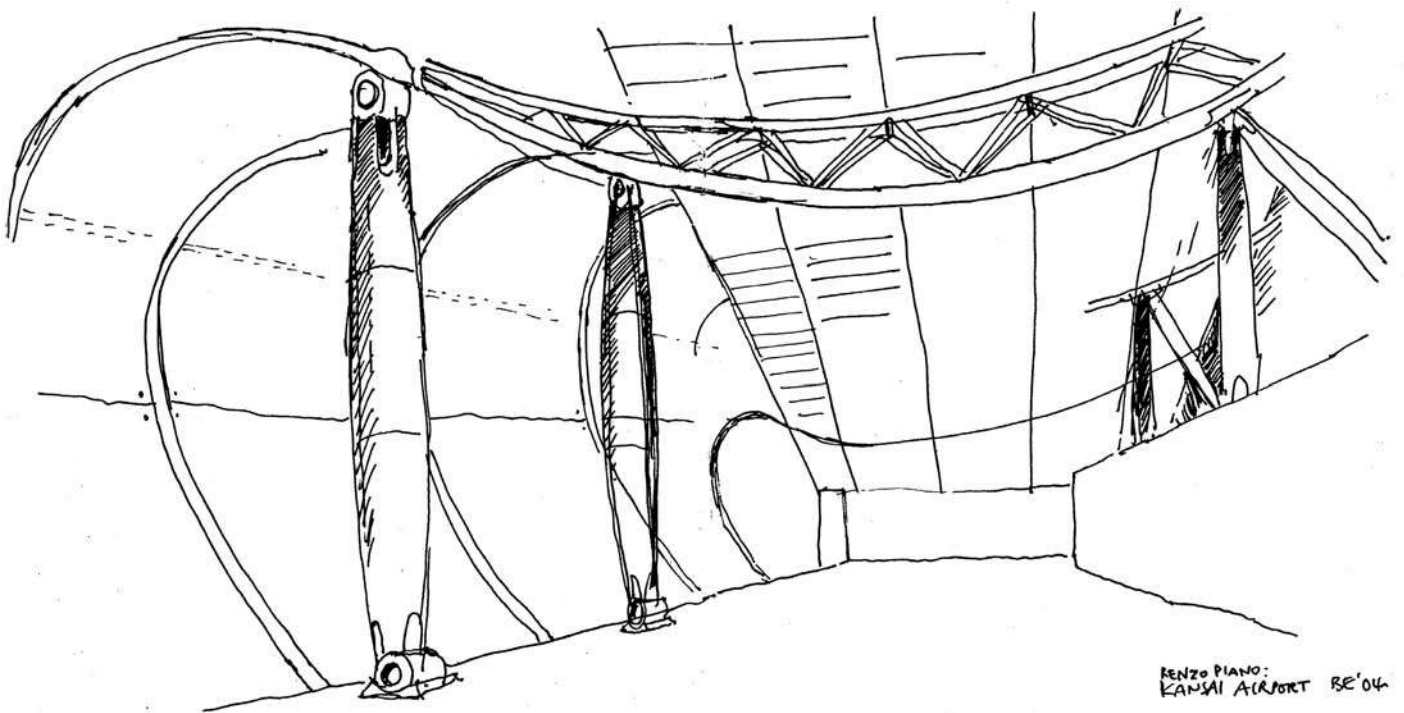

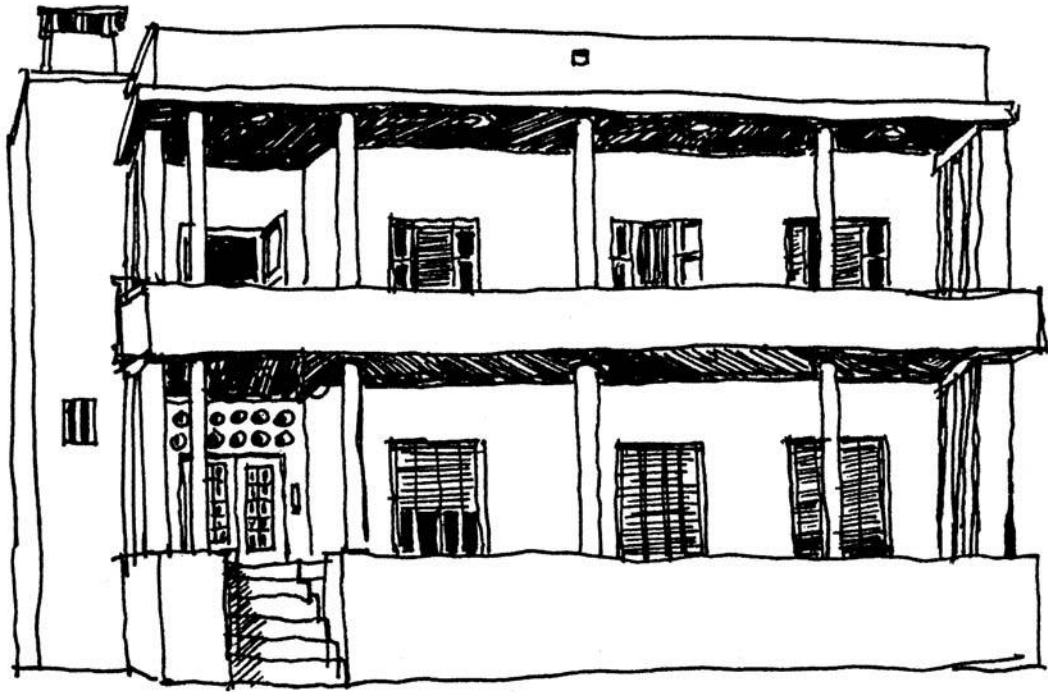
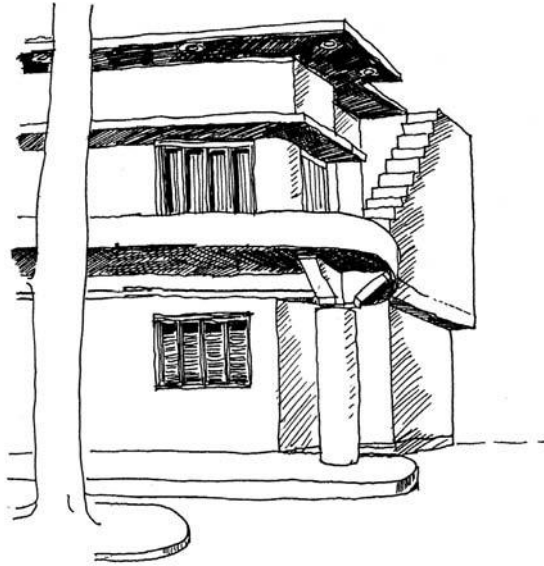

Chapter 17

Landscape

The landscape of cities and the countryside around them can be divided roughly into the following categories:

- tree-planted squares and parks;
- waste land occupied by vegetation;
- trees used for visual screening, such as around industrial estates;
- farmland and parkland in the countryside;
- private gardens and courtyards.

These various landscape types can each be sketched and their aesthetic qualities explored. Before doing so, however, it is important to understand the structure of landscape and how best to represent its basic ingredients – hills, fields, boundaries, hedges, paving, etc.

Landscape drawing is a well-developed art, and sufficient guidance in its principles is given elsewhere to make duplication here unnecessary. As a rule, the artist should concentrate upon the structure and form of landscape, leaving matters of detail to a secondary

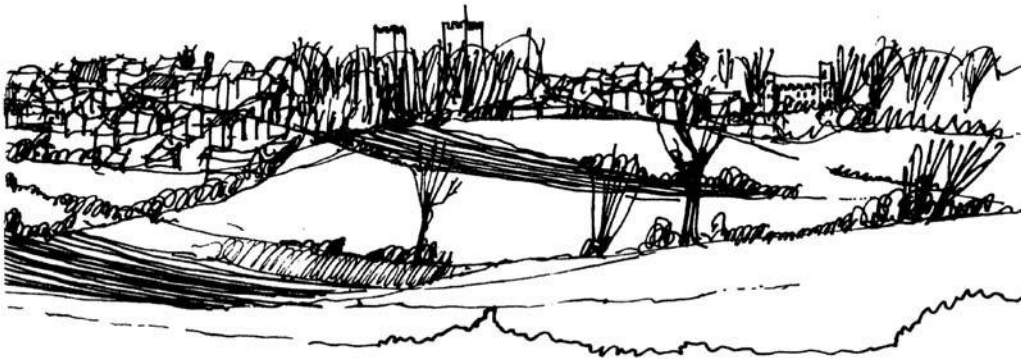

17.1

Landscape provides the setting for most towns. The open fields of Norfolk and remnants of old hedgerows enhance the scene of the market town of Reepham. The church towers built on high ground make distant landmarks and provide the focus for the drawing.

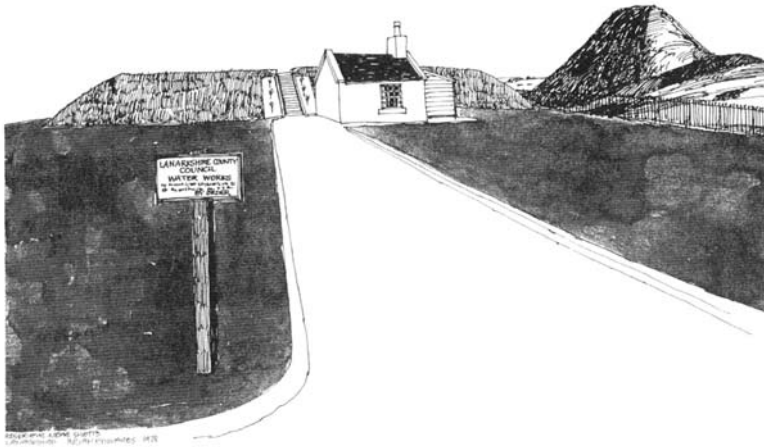

17.2

Perspective plays a large part in landscape drawing. This view of a water works outside Glasgow exploits the strange geometries of such places.

sketch. The character of towns requires an appreciation of landscape, but vegetation is rarely a dominant element in the scene. Normally the structure of land form, the pattern of landscape and the geometry of planting are the essential ingredients. As landscape and architecture are closely interwoven within towns and the city edge, the principles already mentioned for drawing the urban elements can be applied to the natural ones.

Hence, seek out patterns and structures within the landscape as you would with buildings, and represent them broadly. See the trees and hedges as enclosing 'rooms', as brick walls are in the urban scene. Tall trees, especially if columnar in shape, can be depicted as landmarks rising above the background townscape. In Continental cities the spires of churches are often set in competition with the cypresses planted in the nearby graveyards. Similarly, the parallel lines of trees planted along a city street can have a formality nearly as great as that of the enclosing buildings. The perceptive eye of the artist should pick out these qualities of form and geometry, and represent them clearly in the sketch.

The modern landscape often contains straight lines and bold arrangements. The urban fringe is frequently filled with large-scale engineering structures that contrast with the old cottages and farmsteads of former times.

Modern bypasses, electricity pylons and reservoir dams often stand right at the edge of the city. The difference in scale and the strict geometry of the new structures are worthy of a carefully drawn sketch. The new landscapes of the twentieth century are crowded into the green belts around most cities. Their modernist lines, smooth surfaces and strictly controlled vegetation contrast pleasantly with the landscapes of earlier generations.

The modern landscapes of reservoirs, airfields and science parks can all be explored, understood and enjoyed through freehand sketching. The scale and speed of modern life is well captured in the new landscapes of the urban edge. As in much townscape drawing, an understanding of perspective is important, especially as many characteristic landscapes of the twentieth century are made up of parallel lines. Straight field edges, railway and electricity lines, the geometric pattern of modern forestry, all require a good grasp of perspective if they are to be accurately represented.

These parallel landscapes often overlap older field boundaries or the ancient alignment of a country lane. Hence the modern elements can be drawn alongside an earlier order, making not only an interesting drawing, but also highlighting the historical processes that shape our landscape. The patterns of different geometries, of old

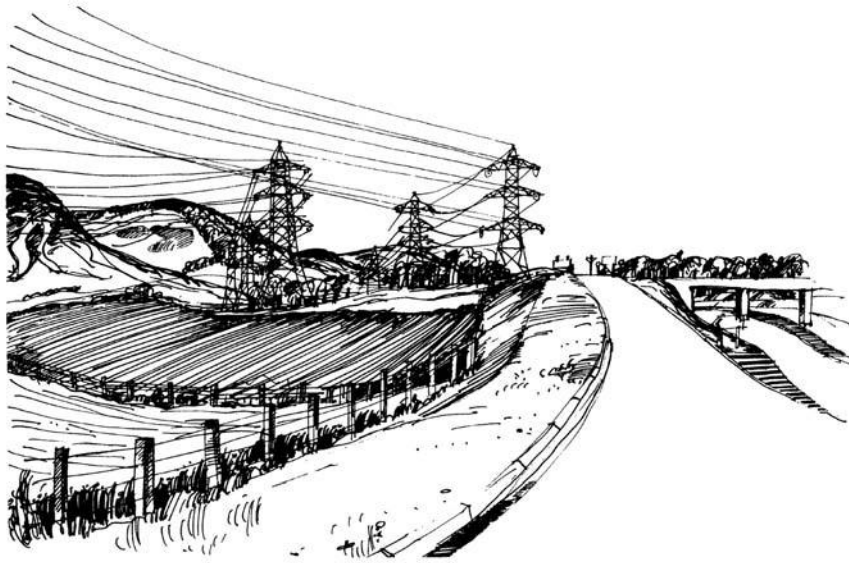

17.3

Landscape and engineering are the two main elements of modern road design. Here at the Edinburgh city bypass electricity pylons form a barrier between the road and Pentland Hills and reinforce the geometries of the road system.



17.4

The bold patterns of the ploughed fields in upland landscapes can make for interesting drawings. The flowing lines of hills, fields and shelter belts stand in contrast to the more man-made landscapes of the urban fringe (see Figure 17.1).

17.5a and b

These simple drawings, made from a train window, of a forest and fields in Ontario, Canada, with melting snow benefit from a large measure of subtraction. The patterns have design potential.

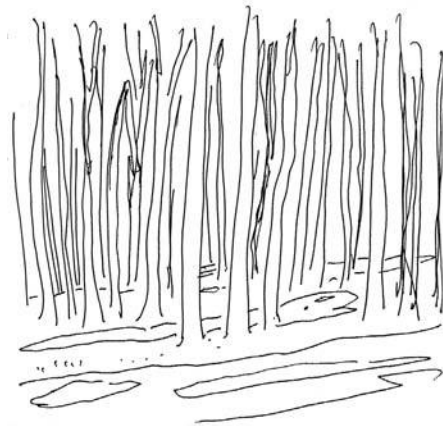



17.6 (above)

In suburban areas landscape design and architectural design are often well balanced. Different shapes and colours of trees complement the diverse patterns of building in this drive in Glasgow.

17.7 (right)

The proximity of the date palm to this merchant's house in Palma, Majorca, creates a tension between building and landscape design. The terrace provides an opportunity to enjoy the shade of the tree and gives privacy to the main apartments on the first floor.



17.8

The density of planting along this road in Glasgow results in the landscape elements dominating the urban ones. The different textures of the trees and plants have been deliberately exploited partly to aid identifying the species involved.



and new textures, frequently extend through both urban and rural areas. Compared to the countryside well away from towns, the landscapes at the urban edge are complex subjects, being neither truly rural nor truly urban. They are the servicing areas for the city, and therefore contain sewage farms, railway yards, industrial parks and motorway corridors interspersed with remnants of the older farmed landscape. The somewhat artificial boundary between town and country is represented in the untidy and often vandalised countryside immediately around cities. Using the sketchbook in these areas can result in interesting compositions. The challenging material of the urban countryside is also helpful in teaching landscape design and in cultivating an appreciation of issues facing modern geographers and town planners.

The modern industrial landscape at the urban edge frequently contains relics of the Industrial Revolution. In former mining areas heaps of coal spoil, like mini mountains, can often be found alongside the dilapidated remains of pit winding gear. These relics have a poetic quality, especially if softened by invading vegetation. Disused canals and railway lines have a similar quality and in time, perhaps, the elements of the twentieth-century landscape (pylons, motorways) will also be transformed into romantic ruins.

The pre-industrial landscape made up primarily of agricultural countryside and compact settlements has given way to dispersed towns and disrupted countryside. As a consequence, the town now extends into the countryside, leaving pockets of fields and orchards marooned in the city. Hence fragments of the countryside can often be found in towns, and transplants of the city in the countryside (frequently in the form of new towns or business parks). The old rigid distinction between town and countryside has been broken, creating much material for exploration through the sketchbook.



17.9

These palm trees in a courtyard in Palma, Majorca, provide a feeling of tranquillity. The wide, spreading leaves of the palms offset the hard lines of the arcade and stairs behind.

Green belts seek to hold on to the romantic notion of the countryside surviving as a discrete entity alongside towns. They are usually well-defined areas consisting of country parks, old planted estates and modern recreational facilities. They provide good material and a tranquil setting for those wishing to learn through freehand drawing.

Landscape sketches are more successful if there is a focus to the drawing. This can either be a farm or house set within its rural context, or, more challengingly, a large engineering structure such as a radio mast or motorway bridge. By mixing the natural and the artificial, the sketch will develop a complexity and meaning otherwise lacking if it depicts the countryside alone.

Trees can be drawn individually or as blocks. The structure of an individual tree (whether circular, columnar, pyramidal) is worth noting, but as a group the trees will form a screen like a planted wall. In urban situations trees may be planted in formal rows or grouped geometrically in a square. The challenge then is to capture their

17.10

Upland landscapes (as here in this view of the Pentland Hills near Edinburgh) are usually seen from the road. Signs, poles and fences form the poorly designed foreground for many such views.

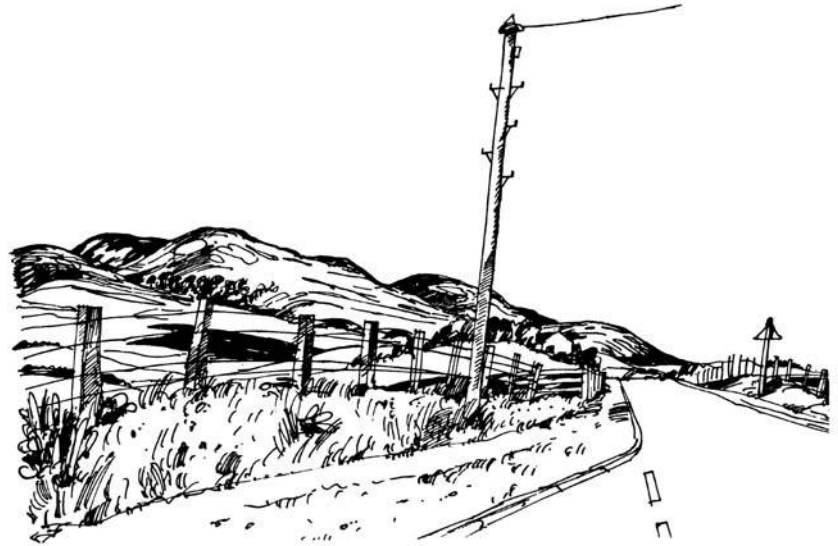

17.11

The cypress tree in this suburban street in Barcelona provides a landmark almost as important in civic terms as Antonio Gaudi's apartment block behind. The relationship between trees, walls, cars and buildings establishes a balance that is typical of Mediterranean towns.

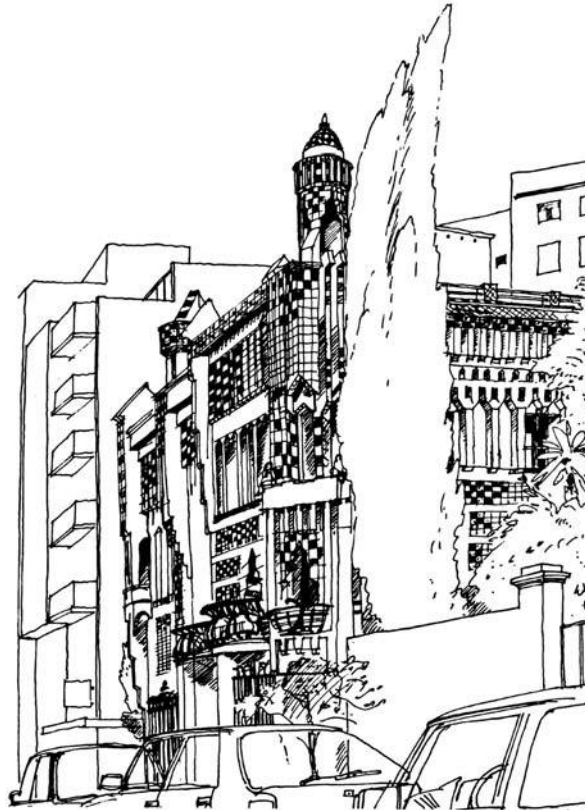



17.12

The Place Dauphine in Paris provides a perfect balance between urban and landscape design. The trees have a significant impact and provide welcome shade and tranquility within the congested city.

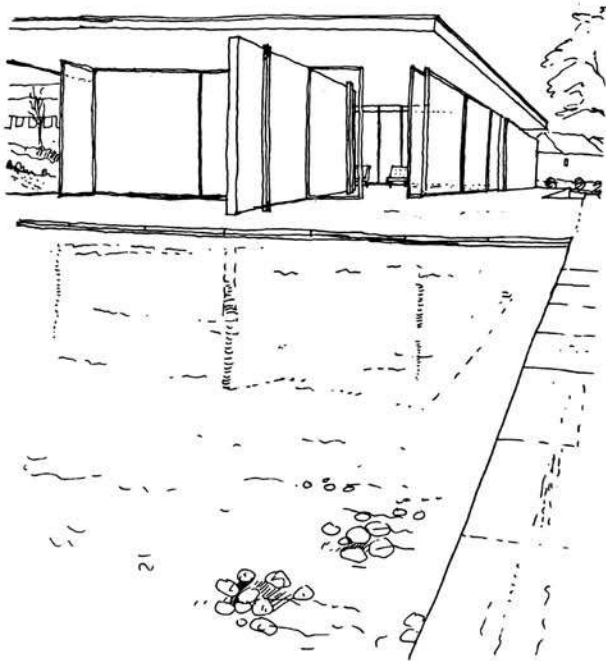

17.13

The Barcelona Pavilion, built in 1929 by Mies van der Rohe, makes little distinction between building design and landscape design. Here paving and pool are merely an extension of walls and roof.

formality and to use the planted elements to complement the built ones. Often trees are employed along with shrubs and ground-cover planting. These three layers of landscape are usually designed to act together, especially in city parks. The shape of leaf, colour and texture of foliage contribute much towards the visual effect, and can be highlighted in a sketch. In more urban situations trees are mixed with paving, and here the contrast between the gnarled trunks of ancient trees and the smoother surfaces of brick or stone is deliberately exploited. Whether as an amateur artist or as a professional designer, it is worth searching out such details and learning to use them.

UNDERSTANDING ANDY GOLDSWORTHY THROUGH DRAWING

A number of artists work in the media of landscape, such as Andy Goldsworthy whose installations at the Yorkshire Sculpture Park are explored here. Landscapes are primarily man-made and hence lend themselves to analysis through drawing, particularly when artists and sculptors intervene in interesting ways. Goldsworthy's art engages directly with nature, producing work in the countryside that draws upon ecological understandings, local materials and cultural references. Using dry stone walls, ambiguous holes, woven branches, twigs and leaves, Goldsworthy produces sculpture of great beauty whilst also engaging the viewer in questions of sustainability.

Sketching the landforms and installations created by Goldsworthy helps bring the structural properties of his work into greater focus. There is considerable understanding of engineering and craft in his work, especially that placed directly in the landscape rather than in a gallery context. With Goldsworthy, the structural solutions employed borrow directly from constructions found in nature, such as the weaving of birds' nests or the suspension of spiders' webs. However, in the exploitation of familiar natural phenomena, Goldsworthy adds local

cultural and craft references, which anchor his work into specific locations. In bringing together nature, craft and indigenous materials, Goldsworthy is making a statement about the particular as against the universal – an arena in which architects are also much engaged.

Recording Goldsworthy's often ephemeral work via the sketchbook is a departure from the usual documentation via the camera lens. As mentioned before, the process of sketching forces the student to explore beneath the surface whilst also providing the opportunity to modify the drawing in order to enhance the learning experience. This is particularly pertinent in an analysis of Goldsworthy's land art, where the surface structures reflect deeper intellectual investigations by the artist. Bringing these into focus by drawing helps the student to understand his art at two main levels. First, there are the practical areas such as the materials, crafts and structural techniques used to realise what are often large constructions built to withstand the harsh realities of the outdoor world. Second, there are the artistic aspirations, values and working principles followed by the artist. Through sketching, Goldsworthy's use of geometry and space becomes clearer, especially the play of circle and square, and straight and serpentine line, which recur in his art at different scales.

All of Goldsworthy's work can be explored via the sketchbook. However, his large site-specific sculptures, which address themes of nature and time, holes and layering, cracking and stability, lend themselves to analysis through drawing better than his smaller gallery works. The conceptual journeys undertaken by artists working in the medium of landscape art from Goldsworthy to Richard Long and Ian Hamilton Finlay are often concerned with time, space and construction – the very issues faced by architects. Drawing encourages these parallels to be explored, perhaps in the process enriching future architectural practice.

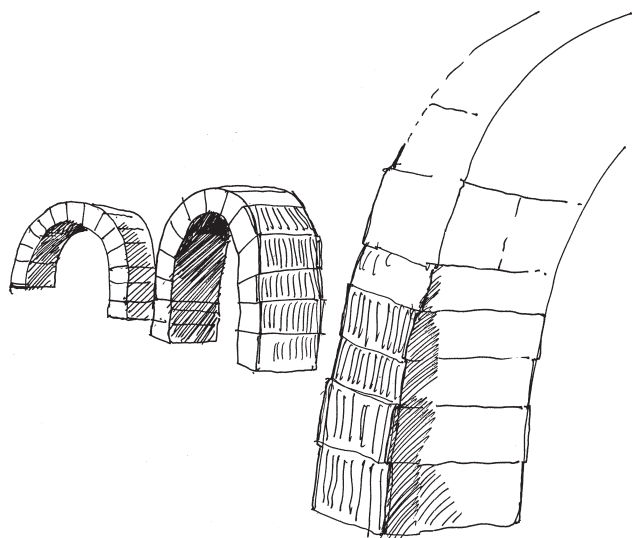

17.14

Andy Goldsworthy constructs installations that bridge art, landscape and architecture. This example is known as 'Striding Arches'.

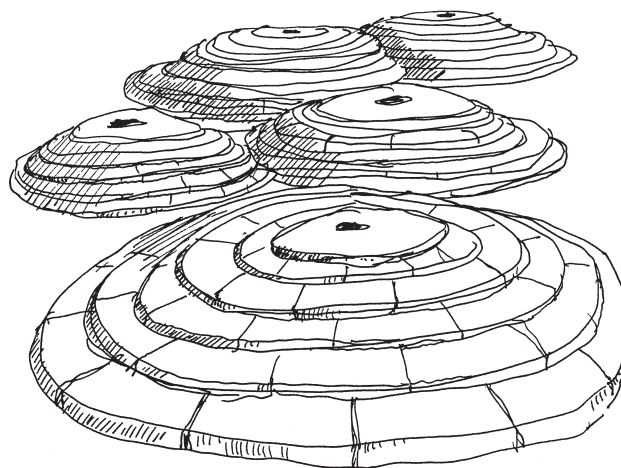

17.15

Stone Room at the Yorkshire Sculpture Park is a construction by Goldsworthy of sandstone domes with ambiguous holes.

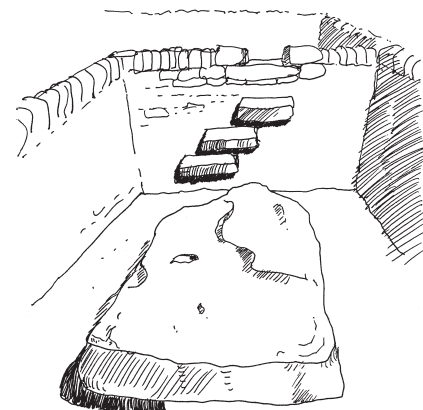
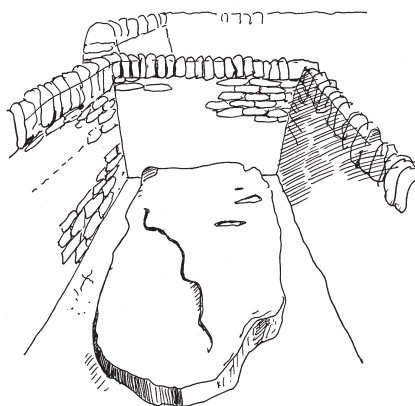
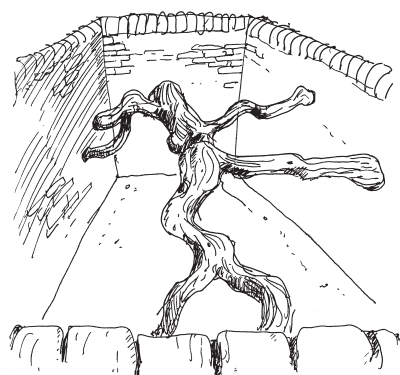

17.16a, b and c

The use of landforms and structures based upon farming practice is a feature of Goldsworthy's work. Here in these installations the artist alludes to the enclosure of nature as a metaphor for wider ecological concerns.

Chapter 18

Sustainability

The concept of sustainable development, and associated practices such as sustainable construction, lend themselves to investigation via the sketchbook. It is possible to use freehand drawing to explore aspects of modern green design, be it the use of solar energy, wind power or natural ventilation. Conversely, most of the buildings constructed before the Industrial Revolution utilised local renewable energy sources, building materials were from the immediate locality, transport and farming practices relied on human and horse power, and cities were located where natural resources demanded. There was little or no importation of energy, food, water or materials, and since there was scarcity all round, there was a great deal of re-use and recycling. In this there are lessons for the future, which can be recorded and understood through freehand drawing. So sketching can help reveal best green practice, whether old buildings or more recent examples are employed.

The resources available also shaped the technologies and design practices employed. Here again the sketchbook can be used to study the crafts as well as the buildings and cities produced. In this there is no difference in principle between practice in the eighteenth century and that in the twenty-first. In both cases, science and technology seek to achieve the maximum benefit

from the minimum of resource consumption, using design to mediate between resources and uses. Hence, as in all sustainable practice, design and technology are intimately related. The function of drawing is to record this relationship so that lessons can be learned that may have relevance for future design practice.

Sustainable development, defined as development which meets the needs of the present without compromising the ability of future generations to meet their own needs, is essentially concerned with development, i.e. what architects do. Sustainable development is about cities and large-scale decisions that act upon global players, such as politicians. The architect is involved in this, but more commonly at the level of sustainable design and sustainable construction. Hence the subject of sustainability is best explored through freehand drawing at all three levels – urban, building and construction.

There are different green practices in different regions of the world as a result of variations in climate or cultural practices. The sketchbook can be used to explore these differences and in the process gain some insight into the subject of sustainable development. Since there are marked inequalities in the global distribution of resources, from water to agricultural land and energy supplies, the subject has considerable educational benefit if sketching



18.1

Drawing of the south-facing façade at BedZED, a low-energy housing project designed by Bill Dunster in south London.

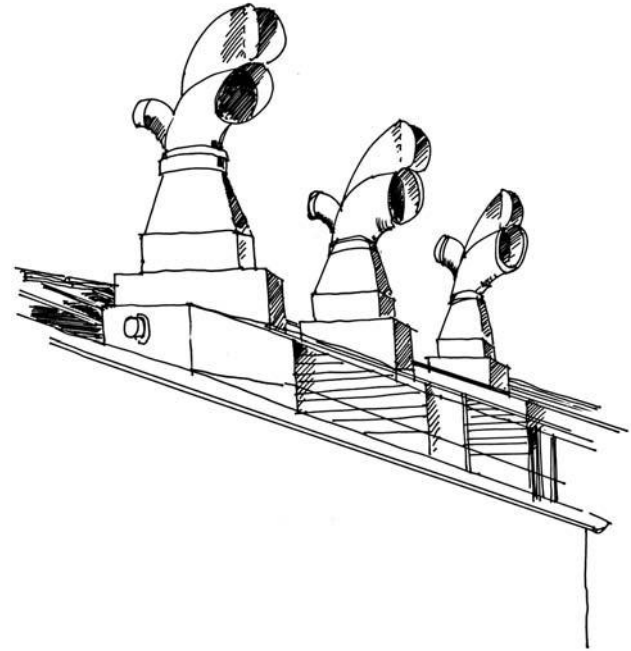

18.2

Sketch of ventilating cowls at BedZED. They rotate to take advantage of wind to cool the houses and workshops beneath.

is employed as the media of investigation rather than words. Drawings allow the experience of green design to be analysed from various perspectives – plan, section, sketch views, details, etc. When key words are added, the drawings display deeper understanding thereby allowing the subject to be shared with others and assessed if they are done as part of college work. Such sketches should retain an analytical quality if the principles are to be understood, although they can be more descriptive if the aim is to relay the character and experience of green design.

Sustainable architecture comes in various guises, from modern solar-designed houses to traditional wind towers or courtyard forms. In terms of solar energy, there is the problem of keeping buildings cool (a growing problem

with global warming) as well as exploiting the sun for heat gain. Hence practice varies in different regions of the world and at different times of the year. For example, in many twentieth-century modern movement houses the architect balanced the need for high levels of daylight with solar protection in the summer, whilst also affording access to the health-giving qualities of sunshine in winter. Many buildings (both houses and schools) constructed around the mid century provide an interesting case study of how architectural design responded to climate and health in a sustainable way.

There is a clear link between cultural practices in architecture and sustainability. Much vernacular architecture carries in its construction and craft practices a solid knowledge of low energy design, recycling, the

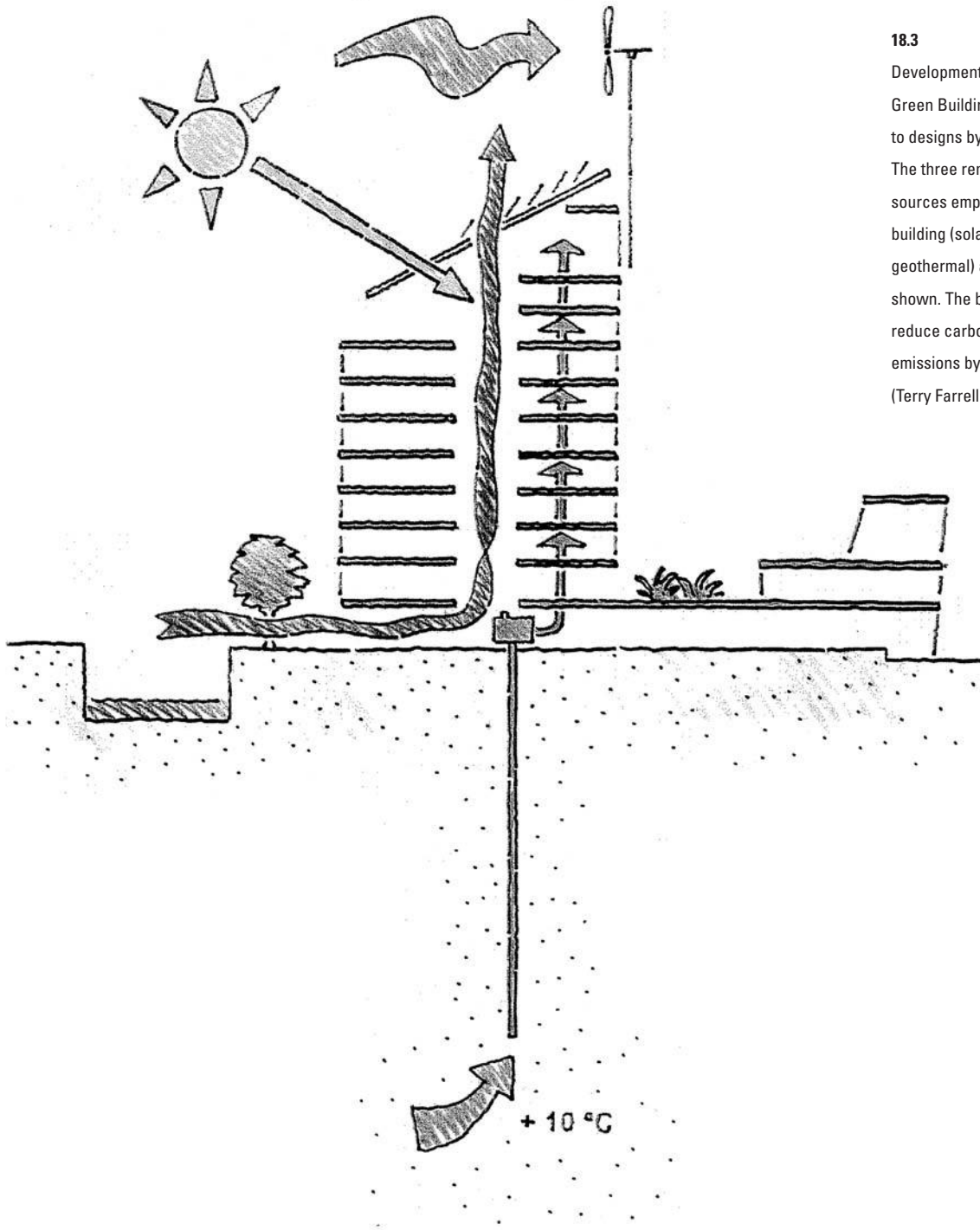

18.3
Development sketch of the Green Building in Manchester to designs by Sir Terry Farrell. The three renewable energy sources employed in the building (solar, wind and geothermal) are clearly shown. The building claims to reduce carbon dioxide emissions by 75 per cent. (Terry Farrell and Partners)

18.4

Sketch by Sir Nicholas Grimshaw explaining the energy strategy at the British Pavilion at the Seville Expo. (Sir Nicholas Grimshaw)

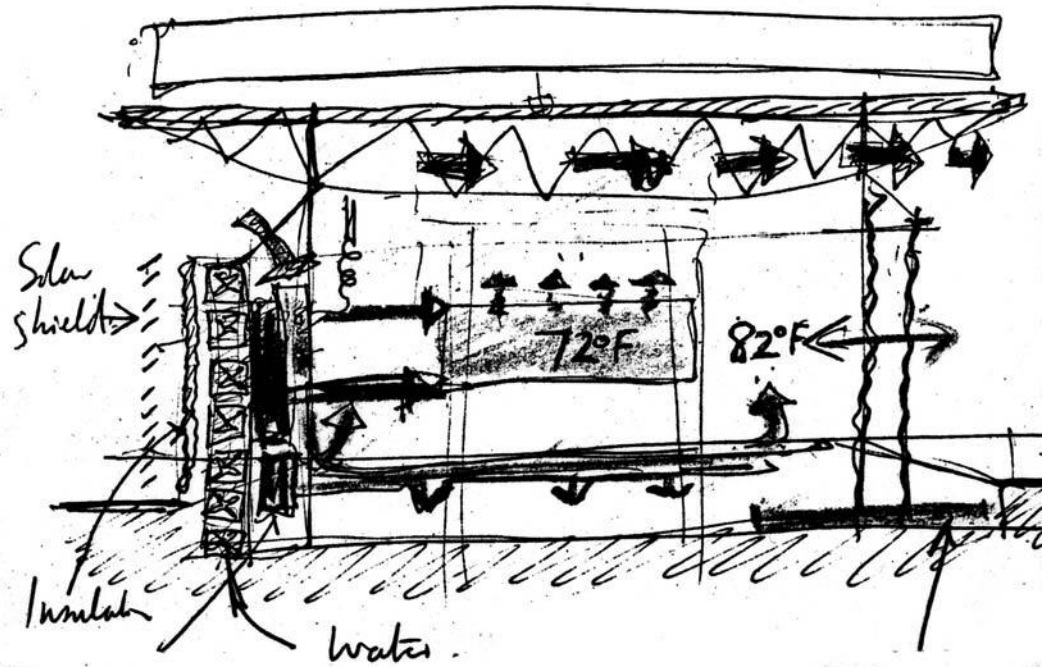
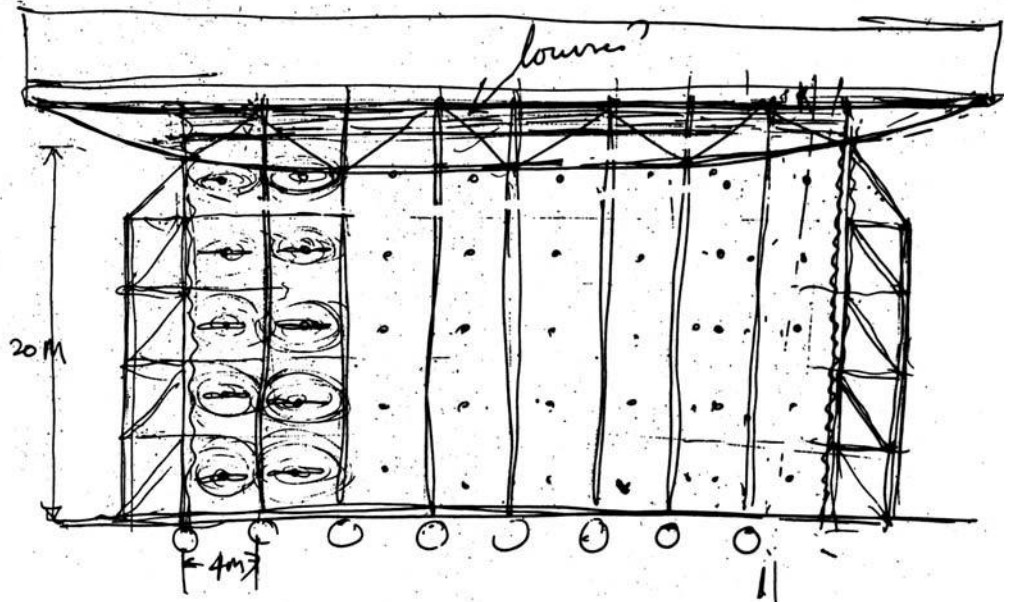

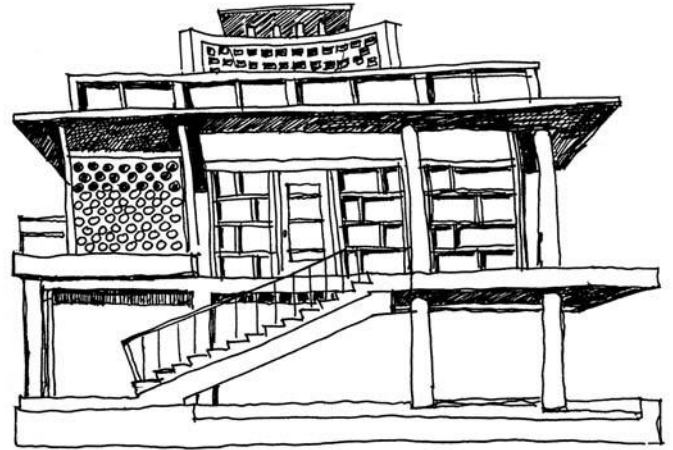
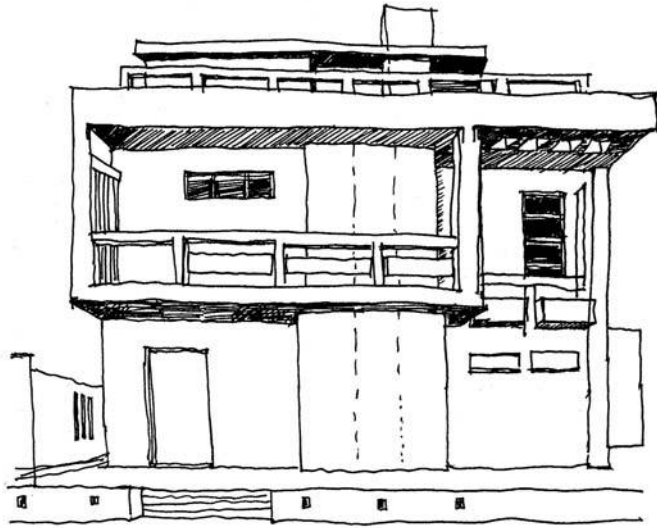

use of thermal mass for heating and cooling, rainwater collection, sustainable drainage systems and integration between human and animal shelter to provide greater levels of comfort. There was a respect for nature and the landscape that provided the resources upon which the building or village drew. Modern practice has often broken the continuity of these traditions with serious social, cultural and environmental consequences. By using the sketchbook to learn from the past, students and architects may be better prepared for a future with fewer global resources upon which to draw. In regions like Africa and the Middle East, where much future development attention is likely to be focused, there are well-established vernacular practices that are unique to their localities and climate. Recording and understanding these provides the opportunity to update them for the demands of the twenty-first century. Rather than take Western industrial traditions into these areas, it may be more valid to transport ideas from the less developed world into the resource-hungry cities of Europe and the USA.

It is tempting to use the camera to undertake the type

of recording and analyse described here. However, as chapter 10 argues, photography has limitations in reaching a deep understanding of design or construction practices. The camera records the surfaces, not the structural or spatial arrangements, nor the thickness of materials or air flows. The drawing is better equipped to undertake this type of investigation, although sketches and photographs can be combined to fully narrate an example of green practice. The benefits of drawing to learning are obvious: there are judgements and interpretations that need to be made (unlike in photography), and in the quality of the graphic investigation there is a basis to assess the level of intellectual inquiry. Sketches also provide a vehicle for taking learning from an existing building and applying the principles to the design of a new one. Hence in learning about sustainable design from existing structures, whether vernacular or more recent examples, the sketches are the bridge into the imagination.

As mentioned earlier, the subject can be examined at three levels – urban, building and construction. All are

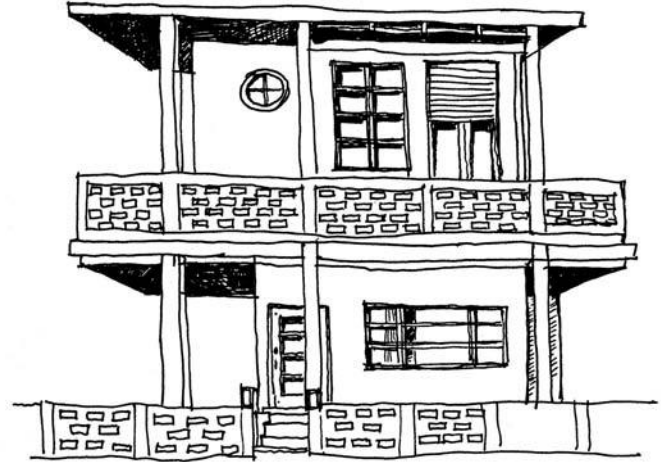
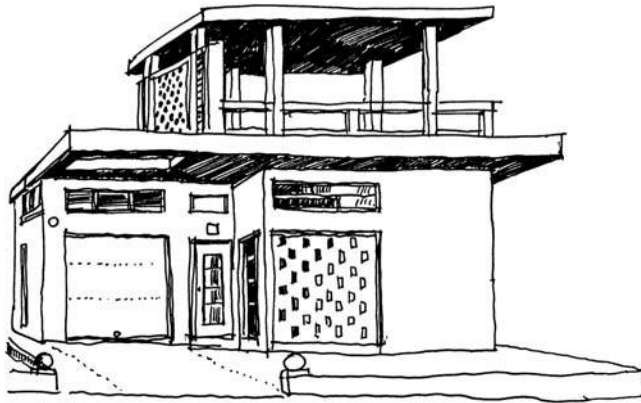

relevant to the architecture student. Three examples are given here from the author's sketchbook. The first concerns the relationship between transport systems and urban design using Tokyo as an example, based upon a study visit with Edinburgh students in 2005. The metro system in Tokyo has shaped the profile of the city above ground. Where stations are located there is a greater intensity of buildings of various kinds from offices to hotels and apartment blocks. As a result the city achieves the kind of mixed use, pedestrian friendly compaction advocated by architects such as Lord Rogers. This type of intensity of commercial and cultural life leads to other changes to the city fabric. Parks become enclosed and cherished for the tranquillity they provide, railway stations become interchanges connecting different transport modes together, and streets become places mainly for people rather than cars. Using the sketchbook, the world below and above ground can be superimposed, the mixture of land-uses analysed and street life described – leading to a better understanding of sustainable practice in Japanese cities.

18.5 a, b, c and d

These sketches show various methods of dealing with environmental control using architectural means rather than air-conditioning. The fins, louvers, balconies and overhangs protect the buildings from the midday sun whilst also encouraging cross-ventilation. These houses are in southern Portugal and date from 1930–60.

18.6

Sketch showing the relationship between development above and below ground in Tokyo. Public transport is an essential element of sustainable development.

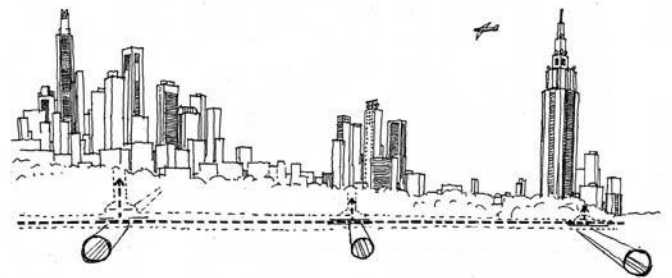

Another example, this time at the level of building design, is that of courtyard houses in Syria and other parts of the Middle East. Again the studies are based upon student field trips to the region. The form of the traditional courtyard house was a direct response to climatic conditions, although over time it assumed a cultural and social significance. The dimensions of the courtyard, thickness of walls, presence or absence of ventilating chimneys, the size and position of windows and much else was a direct response to solar design. These characteristics lend themselves to sketchbook analysis and, if time permits, to more thorough investigation of temperatures at different times of the day and over the year. By combining visual analysis with building physics, the student can learn a great deal about sustainability in the field.

The final example at the level of construction concerns the use of ventilating cowls in contemporary building design in the UK. The sketches concern buildings of different types (library) and different architects (Rab Bennetts and Bill Dunster). The aim behind the drawings was to investigate the workings of natural wind-assisted ventilation, the impact upon the interior spaces and the external aesthetic consequences. By combining different types of drawing (mainly sketches and cross-sections) it was possible to understand more fully this phenomenon of current green design practice.

The exercises described here were of academic as well as personal interest. The sketchbook provided the means to more fully understand the subject of sustainable development than had photography alone been employed. Different types of drawings were needed to interpret the complexities of sustainability, and frequently words and arrows were added to the sketches to elaborate in some detail. As with understanding architecture generally, the use of sketching gets beneath the surface of subjects, allowing the principles to be better understood.

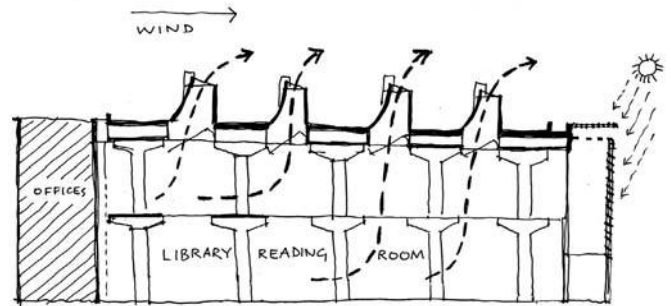
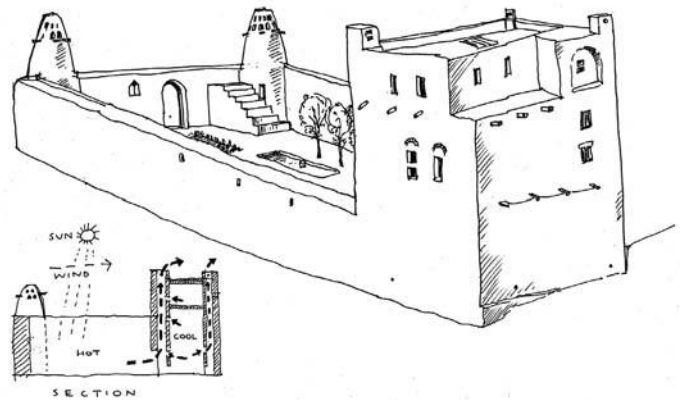

18.7 (top)

Typical courtyard house in the Middle East. The drawing explains the traditional methods employed for cooling using wind towers.

18.8 (above)

Study of ventilating cowls at Brighton Public Library designed by Bennetts Associates. The building was short-listed for the Stirling Prize in 2005.

18.9 (right)

The Loch Lomond Visitor Centre designed by Bennetts Associates uses local oak in its construction and rhythms drawn from the adjacent woodland. The building seeks to reduce its environmental and visual impact whilst still being modernist in spirit.

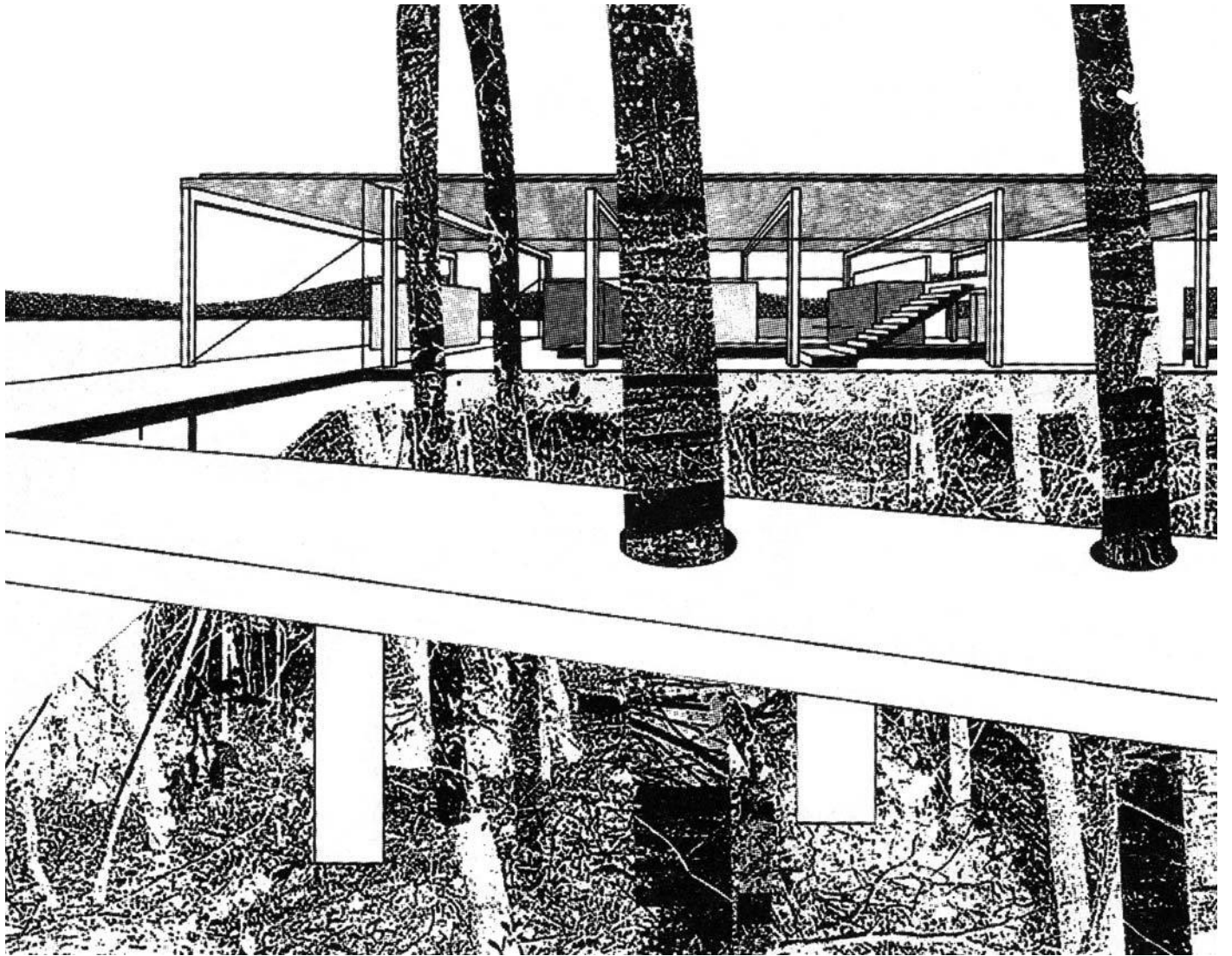

Chapter 19

History and archaeology

Drawing is a particularly useful tool to employ in the study of the history of architecture and in related fields of archaeology. The site sketch supplemented by measurements on the ground brings the organisation, structure and construction of historical and archaeological subjects into a graphic form that can be readily understood. Historical sites come in many forms – some are predominantly below ground, others are fragments of structure above, others are relatively complete assemblies covering quite large areas, others still are

large settlements or areas of cities. Invariably, the man-made structures and surrounding landscape have a special and often planned relationship although it may not be evident to the casual observer. The role of the sketch is to bring these relationships into focus, thereby beginning to understand the design content of the building or site in question.

Unlike drawing modern buildings, a typical archaeological site usually sits independently of the urban context. Although the subjects under exploration may be

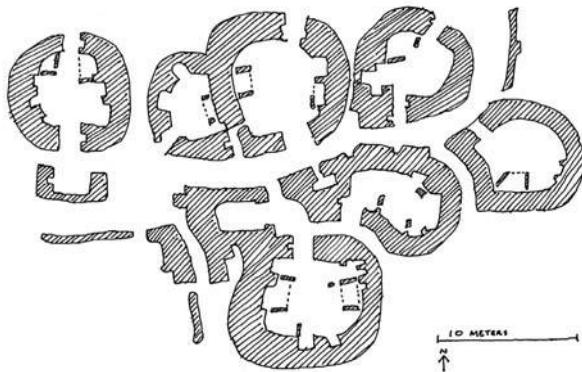

ADAPTED HISTORIC SCOTLAND

SKARA BRAE PLAN

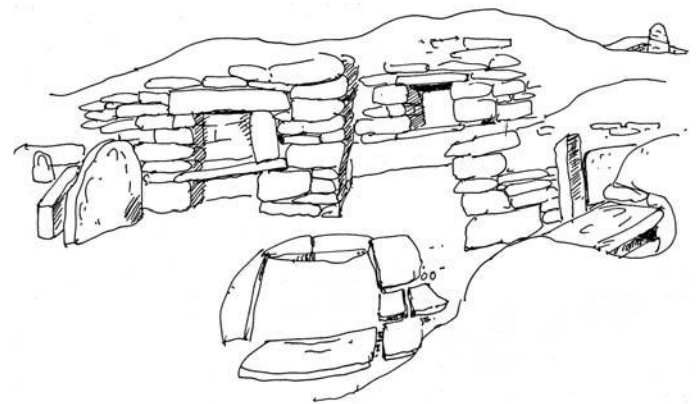



19.1

Skara Brae in Orkney, northern Scotland, is an ancient settlement of stone houses by the sea. It is one of the oldest Iron Age villages in the world and being constructed of stone has survived remarkably well. The sketches and accompanying plan explore the relationship between enclosure, climate and landscape.

large and well-preserved (such as Egyptian pyramids, Greek temples, Roman townships and Crusader castles), they normally exist in relative isolation. This allows the subject to be drawn from various angles, in different lights and at progressively greater scale of detail. Hence, the student may begin with sketches that explore how the subject relates to the wider landscape, then progress to how it is organised in plan or section, and finally make detailed drawings of construction and decoration.

In the north of Europe many historical and archaeological sites exist as dramatic constructions of rock and lintel, creating sculptural compositions in open landscapes. Here the stone circles, burial cairns, fragments of castles or early settlements often display a planned rather than casual relationship with the adjoining

countryside. The sites were often chosen for their symbolic or defensive role, with earth mounding, ditches and vistas being important elements of the total composition. In southern Europe and the Middle East, the same symbiotic relationship between historic site and adjoining landscape exists but here moor and open grassland are replaced by low scrub and desert. In all cases, however, the importance of orientation should be noted on the drawing, recording, for example, the angle of the sun, the axis of due north and any ancient routes into the site. As many early sites have ritual significance it is likely that buildings, field enclosures, lines of valleys and the positions of hills or mountains are in some kind of meaningful relationship. Again, the sketchbook can be used to note these factors, helping to develop an

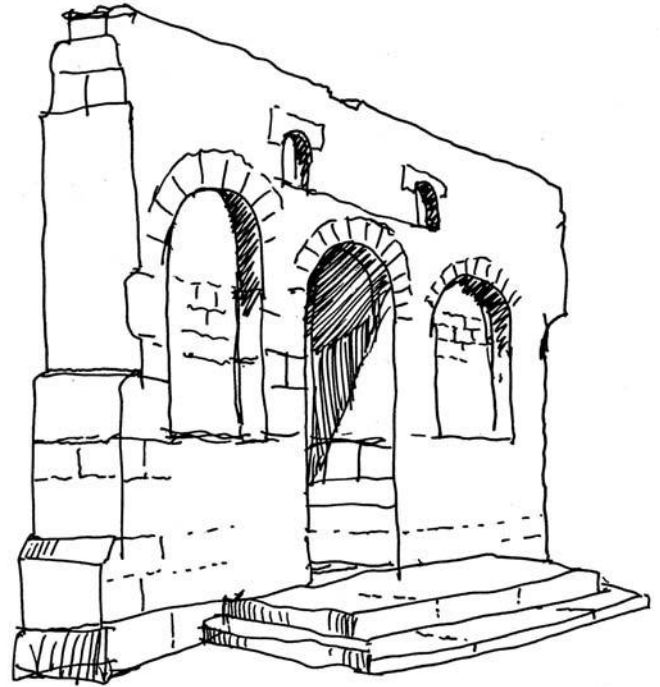
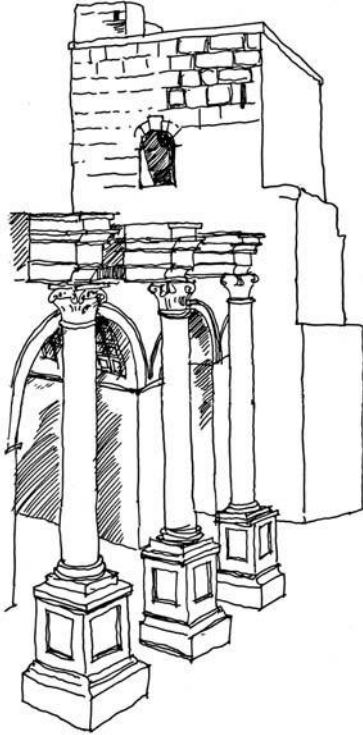

understanding of how early man fashioned the environment. There may be lessons here not just in construction and site planning but in sustainability, particularly the use of water and renewable energy.

How our ancestors designed their world has relevance today. Many ancient sites were successfully occupied for hundreds of years and have lessons to teach us today as the modern world strives to achieve more sustainable patterns of development. Examples like Skara Brae in Orkney, thought to be one of the best preserved Neolithic sites in Europe, show how early man used primitive forms of engineering to modify the environment. Here the residents of this small community of twenty or so stone built, mainly subterranean dwellings (perhaps housing seventy to eighty people) harvested food from the nearby

sea and used peat for heating. Living on fish, mammals (such as seals and whales), oats and turnips they eked out a life in dwellings made of huge slabs of thin stone cut from the immediate vicinity. The limited timber available as driftwood from Scandinavia was used for roofing rather than furniture, which was constructed also of sandstone cut into shape using primitive iron and granite tools. How the village was planned, how it was designed and constructed, and how the lives of people were conducted in these simple, Spartan stone dwellings are subjects that can be more effectively explored through the freehand drawing than the lens of a camera. The analytical drawing, supplemented by observational drawing, gets the student beneath the surface of the subject, bringing into consciousness lessons about construction and sustainability.

19.2a, b, c, d and e

These sketches of Roman buildings on the Aegean in southern Turkey seek to investigate construction as well as more formal aspects of classical architecture.

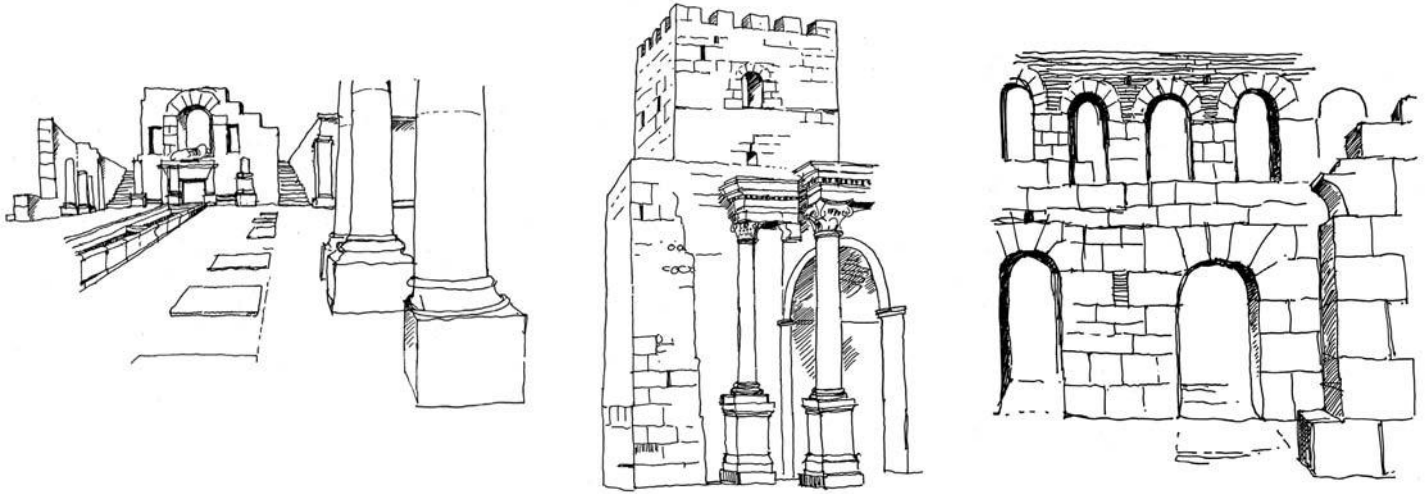

Little evidence exists of the lives of our ancestors four to five thousand years ago, except that left behind in the form of structures and artefacts. The burial cairns of the Neolithic and Bronze Ages offer tantalising glimpses into a world of ritual significance. Here the dead were buried in large community vaults, often as family groups and frequently with a clear pecking order of importance. People were buried with tools, clothes and cherished artefacts, making funerary monuments of particular anthropological importance. Such cairns or pyramid tombs were often sited where they had commanding views over a moorland landscape, a river valley, or along a coastline. Studying these sites, as well as the jewellery and tools discovered within them, provides insights into a world without written records. For many historical or

archaeological sites it is the use of technology, design and construction that holds the key to understanding the lives of people who lived long ago.

The path of the sun, and to a lesser extent the moon, is the key to deciphering the spatial layout of many early sites. In the north the sun was associated with harvests (and hence survival) and appears to have had greater impact upon the design of ancient sites (such as Stonehenge) than places of similar date further south. The motion of the sun (and moon for those who endured the long, dark winters in places like Iceland and Orkney) had an influence upon the geometry of buildings and other structures. Layout on the ground often reflected cosmic or astronomical relationships. Through the field sketch and simple site measurement it may be possible to

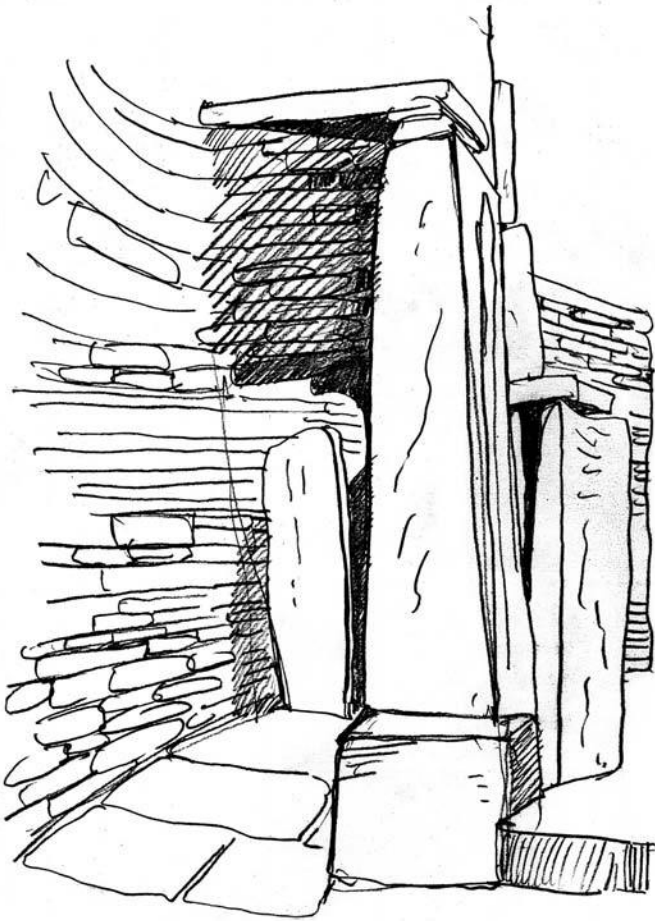

19.3a and b

Built at much the same time as the classical buildings of the Aegean (Figure 19.2) these sketches of burial cairns and Bronze Age monuments on the island of Rousay in Orkney, Scotland, display a similar tabular stone architecture. Once roofed, these enclosures now stand open to the elements.

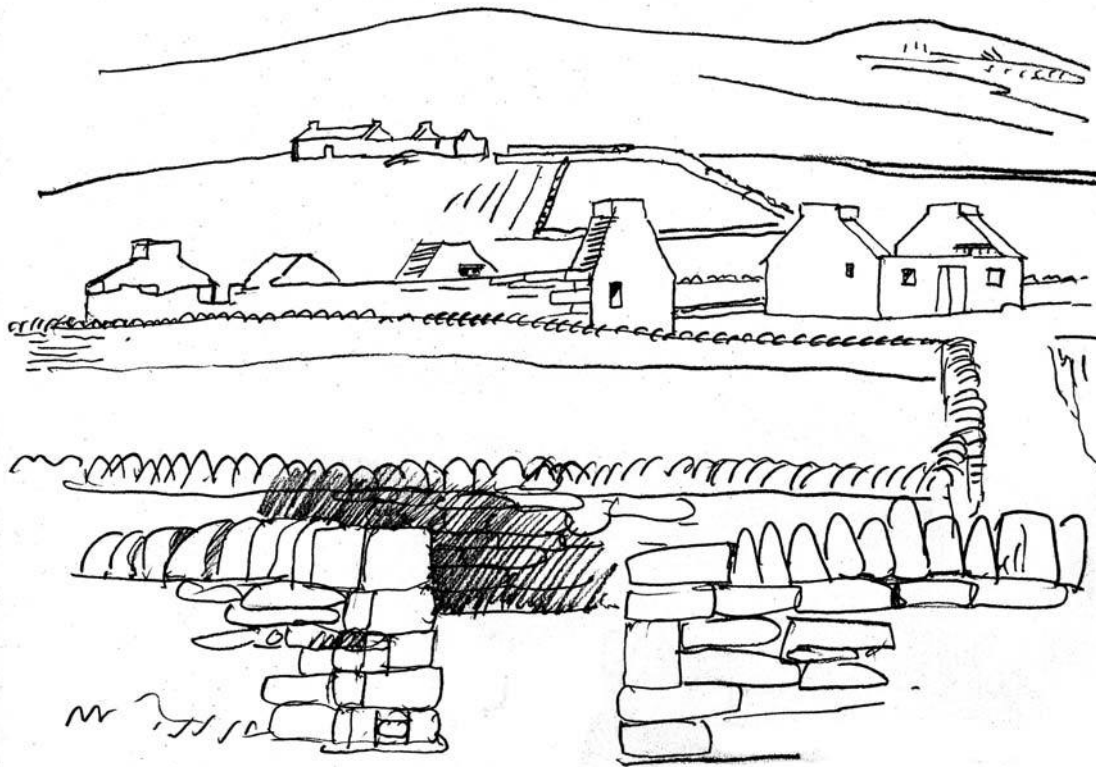

19.4

A deserted highland village in Scotland showing the close relationship between buildings and the enclosure of landscape with stone walls. The drawing edits out much unnecessary material to focus on the melancholic scene.

understand relationships partly lost on the surface. Even if all the evidence is not available, analysis through the sketchbook may allow new theories to be postulated or old ones tested.

Many historic and ancient sites faced problems that modern city planners and architects also frequently address. How were the resources needed for survival to be gathered, where were they stored, and how was waste to be disposed of without jeopardising the health of the community? Where was water to be found and how could energy from the sun and wind be exploited for heating or cooling? How could the settlement be sheltered from winds or protected from attack, and what was the best relationship between field, forest, farm and hamlet? These are all questions that can be addressed in

the context of archaeological sites and for which the sketchbook could be used to draw lessons.

More recent histories, such as Roman settlements, can be explored in similar ways. With its strong sense of geometry and monumental construction, Roman architecture lends itself to investigation through freehand drawing. The clean lines of the Roman builders, their compact town planning and well-articulated public monuments provide good material for those intent upon sketching the remains rather than recording them through photography. Line and shade are the best techniques to employ – the first to understand the orthogonal discipline of Roman structures, the second to express the visual weight of its construction. Roman city planning was based upon grid layouts intersected with cross-axes and



Sigirya.

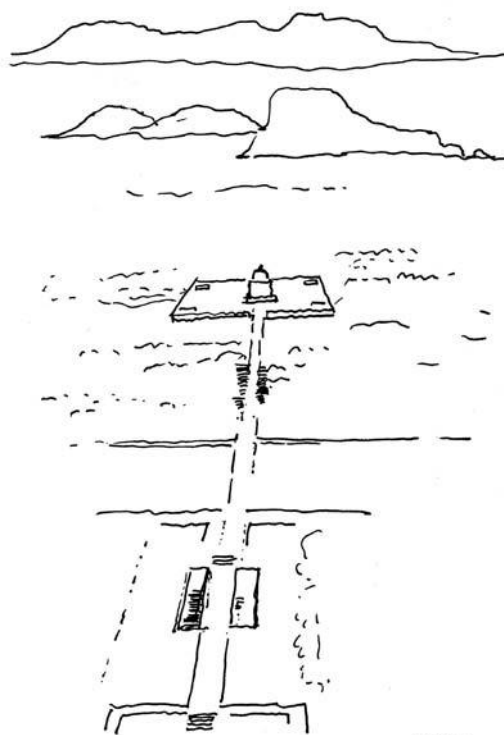

Sigirya

public open spaces that contained market halls, shopping streets, stadia and theatres. The point and counterpoint of a typical Roman settlement are a pleasure to contemplate and draw, especially in the tranquil decay of many classical sites in the Mediterranean or Aegean regions.

A grasp of perspective helps in fashioning the sketches on the page. Few Roman sites are without a grand vista, monumental gateway or viaduct striding across the countryside. Single point perspective allows the heroic ambition of the Roman architect to be analysed in the context of the wider landscape. However, parallel geometries and right-angled crossings are only part of the typical scene; there are also usually fragments of sculpture, friezes and intricately carved capitals. These provide an attractive richness of detail to the orthogonal

discipline of Roman town planning whilst also alluding to the cultural significance of art in classical times. Sketching on site demands the kind of attention to large gestures and small details that is the essence of classical architecture.

Where a large amount of sculpture and carved detail has failed to survive (it is often to be found in nearby museums rather than in situ, as at Palmyra in Syria and Perge in Turkey), there is still much to investigate via the sketchbook. One can learn about Roman construction techniques, not just the use of arch and lintel but the way stone blocks were cemented together and mixed with brick in areas away from public gaze. The sketchbook can be used to explore the ingenuity of Roman engineering as well as architecture, not just in the walls but beneath the

19.5a, b and c

This sequence of drawings of the Buddhist temple site of Sigiriya in Sri Lanka explores the relationship between religious structures and the wider landscape.

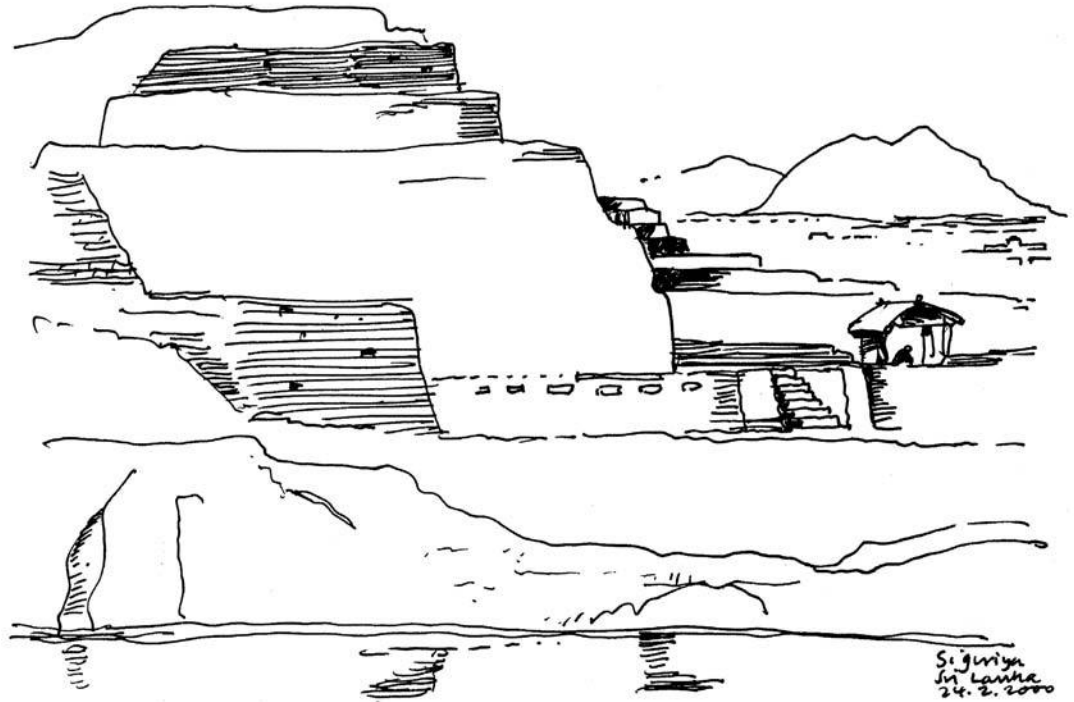

ground in the water channels, hot springs and sewage systems of many towns. At many sites these are open to scholars and tourists to view, though they rarely receive much attention in spite of their significance today.

Roman architecture and town planning displays considerable intellectual thought. The Hellenistic synthesis of art and science is best displayed in the public monuments of the period. Analysis through freehand drawing can reveal patterns and richness that escape casual viewing. Sketching can also bring alive fragments of existing structures by completing buildings either in the imagination or on paper. Since drawing is a fluid tool, the things beneath the surface can be revealed through line, texture or shade. When key words are added, such as the identification or naming of parts, these sketches become

alive with real understanding. Hence, the hidden story of architecture, which is usually described in words, is revealed through the alternative medium of drawing.

Architecture is shaped by lines, not words. They are the basis for much architectural draughtsmanship, either to aid the builder in the task of construction, or as described here in the analysis of existing buildings. Lines serve a useful purpose and obey certain conventions that are shared across the construction professions. The same is true of sketching, where weight of line, effects of shade and technical rendering such as perspective are understood by all architects. Hence, to discover the principles, values and techniques employed in Roman architecture through the medium of sketching requires the student to adhere to standard conventions of drawing

19.6

A sketch by Basil Spence made in 1962 showing how the proportions for his design for the British Embassy in Rome were influenced by the adjacent Porta Pia designed over 400 years earlier by Michelangelo. Drawings rather than words are the best means of exploring such ideas. (RCAHMS)

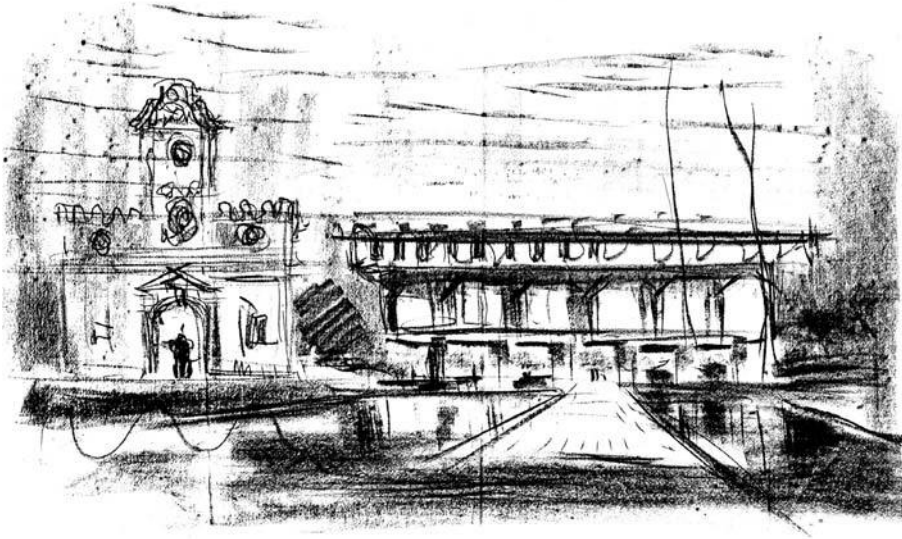

wherever possible. Roman buildings display an unswerving adoption of certain universal principles of design – in this sense the architecture of the period was not unlike modernism in the twentieth century in its stylistic consistency from Scotland to Asia Minor. To draw such buildings reveals more than architectural truths – the sketches tell us something about the Roman world view.

Ancient sites are often busy places in which to draw. It may be best to plan a sketching visit to coincide with when tourists are less in evidence – as in the early morning – or to find a quiet corner away from the crowds. Often Roman or Greek sites are quite extensive and there are usually stone slabs on which to sit. Since sunlight was used to articulate many classical buildings, it is advisable to plan a visit to get the most out of the effects of light and shadow. A diagonal sun (rather than one directly overhead) is preferable and, since conditions are not always ideal, the student is advised to apply effects to the sketch that bring the monumental qualities out.

Buildings and towns display the social structures of

their age. Attention to the plan is important if the social hierarchies present are to be understood. Hence, sketches can have a combination of view, plan and perhaps also section and elevation. This combination can help in unravelling complex relationships on the ground, particularly when the archaeological evidence is incomplete. Architecture is a social art where the plan provides the clue to power and order in society.

As with many subjects discussed elsewhere in this book, freehand drawing is not just an observational tool but one that allows questions to be posed and answered. The modification of the landscape by early man was an exercise in design as much as it was the result of developments in agriculture or social organisation. By design one means a wide definition of human intervention involving the construction of field walls or defensive enclosures, of dwellings, the evolution of primitive technologies, the making of furniture or domestic implements, the design of fighting tools and ceremonial or ritual jewellery. In fact, the root of modern design

disciplines from textile design to architecture, product design to landscape planning, are to be found in the historical and archaeological sites of our ancestors. The freehand sketch and field measurement can release the secrets of the past.

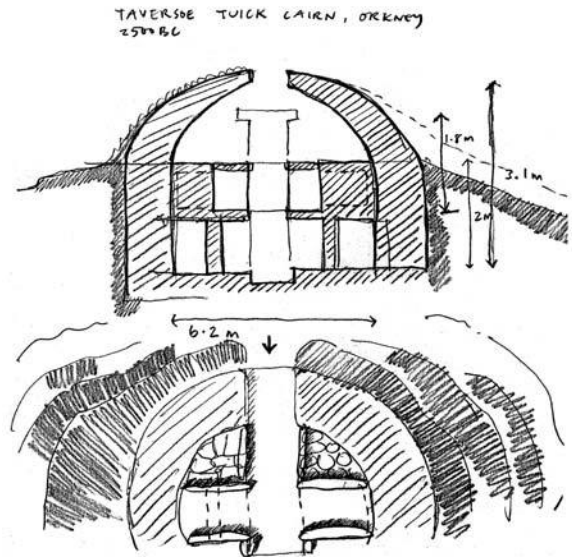

19.7 (right)

Sketch plan and section of Bronze Age tomb on Orkney.

19.8 (below)

Sketch of pyramids at Giza with diagrammatic plan.

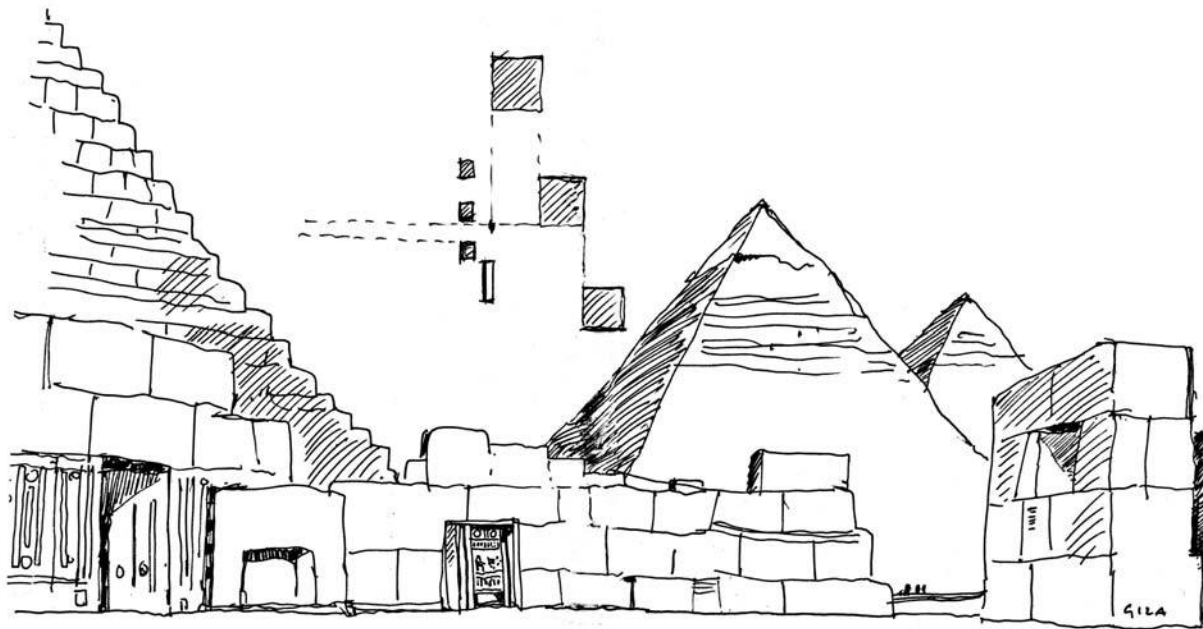

Chapter 20

Interiors

Many of the rules that apply to the drawing of exterior space are equally applicable to interior volumes; in both cases one is depicting the play of solid against void, of line against plane, and light against shade. To sit and draw a room is rather like drawing a courtyard and the same general principles apply. After all, a room is little more than a square with a roof, and a corridor a scaled-down street.

First, select a good place from which to view the room – a position that shows its design attributes to best advantage. Choose a location that does justice to the subject, whether it be the interior of a Baroque church or of a modest café. Look at the play of light upon the surfaces, how the space is used, and how the function of the room determines its general organisation and level of detail. Activity, though difficult to draw, defines the function, and hence character, of the room. Some interiors are frequently empty, devoid of human bustle, whereas others are always alive with human activity. A typical pub or railway station cannot adequately be drawn or understood as a space without the rich layers of human life found there, while the composition of the inside of a church or of a power station may benefit from their emptiness.

In sketching a scene you are seeking to understand space – the objective is to look, draw and learn. The picture is important, but the heightened awareness obtained through sketching is perhaps more rewarding and ultimately more useful to the potential designer. Select your subject with care, therefore, and be critical in the approach to drawing it. If the subject is complicated, then either focus upon a detail that is typical of the whole, or abstract the view in order to pare the subject down to essentials. Never attempt too much; you will quickly tire and lose any pleasure from drawing, and the learning process will also suffer. If a complicated interior has to be recorded, then use a camera – the sketchbook is for analysis, understanding and, one hopes, pleasure.

The sketch of the Europa Bar in Prague shows an Art Nouveau interior typical of those to be found in many European cities, from Glasgow to Moscow. The design of the space is perceived as an ellipse within a rectangle, with a pair of columns defining the cross-axis. In this sketch much of the detail is left out – the key elements are highlighted and Art Nouveau decoration is added to enrich the overall geometry. As the room was nearly empty at the time of the sketch, the seating level is merely hinted at, and this allows the eye to focus upon the splendid gallery and ceiling.

The Europa Bar employs a device common to turn-of-the-century interiors – it is constructed as a circle within a square, treated rather like a clearing in a forest with the dome of space representing the pulling back of the trees to reveal the sky. In such an interior the columns could be likened to the trunks of trees and the exposed beams to branches. Many famous interiors employ a biological metaphor, especially those in the Art Nouveau style whose forms echo those in nature. At the Glasgow School of Art the renowned library by Charles Rennie Mackintosh has also been likened to a woodland clearing, the verticality of the columns suggesting some northern pine forest.

By way of contrast, a sketch of the interior of a medieval cathedral should evoke its imposing ambience and Gothic detail. Here the architecture is not one of line and rectilinear decoration, but of light, shade, space and carved decoration. Accordingly, the artist should adapt his or her style to suit the interior and choose materials that are appropriate for depicting the subject in question. The resulting sketch may well tell us more about Gothic architecture than could be communicated by laboriously measured drawings of walls, windows and columns, and certainly more than could a photograph.

In terms of design, interior spaces are treated in a way that is so similar to certain exterior ones that it is hardly worth analysing them as a separate entity. The rules of articulation, of the manipulation of scale and of the exploitation of axial arrangements are equally relevant to the design of the interior of buildings as their exteriors. What is different is the fact that interiors are designed to be entered: these are spaces that can be inhabited and modified, rather than simply gazed upon. As such, the positioning of the artist is vital; drawings are static records yet the viewpoint should seek to show the interpenetration of space, and how light is used to

20.1

The use of timber shutters to reduce glare in North African houses creates attractive patterns on floors.

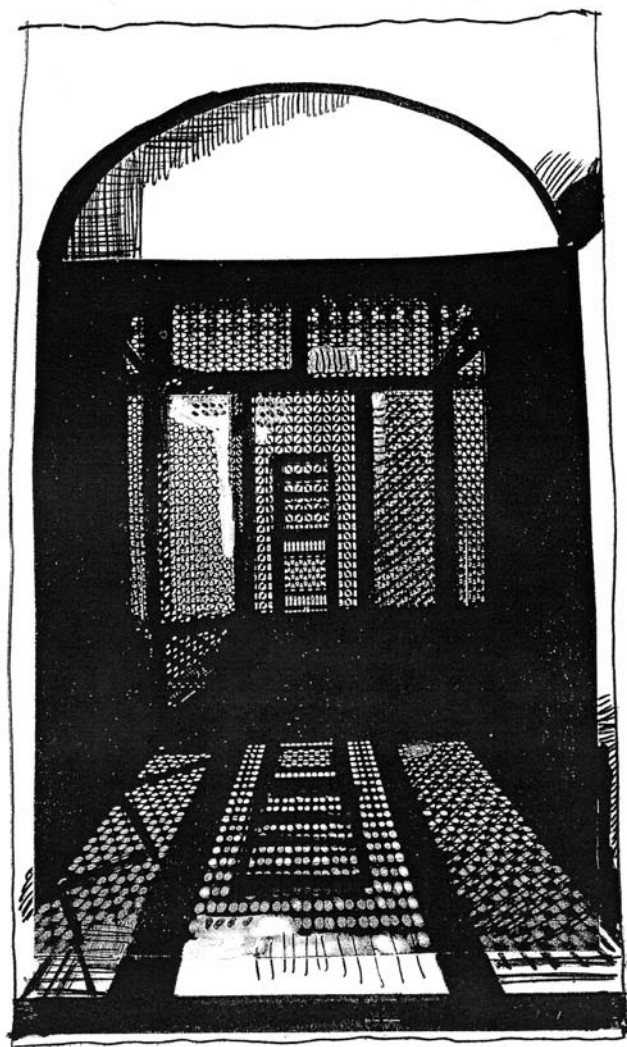

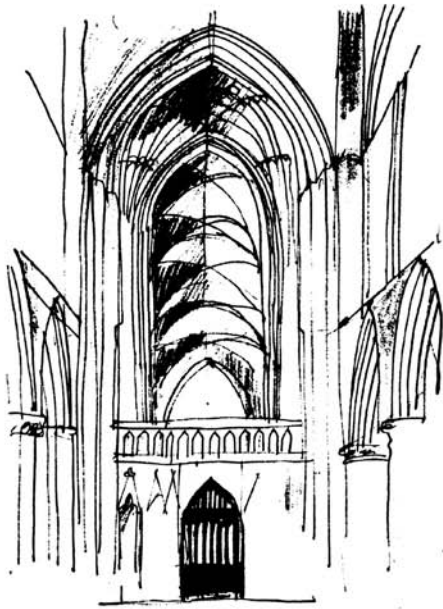
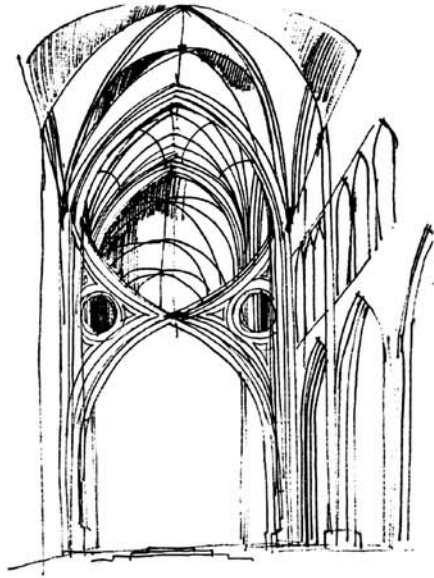

illuminate a decorative panel, or to channel the visitor through rooms and corridors. Interiors, like exteriors, are experienced as linear and progressive volumes – the interplay of rooms, doorways and connecting corridors have their parallels in squares, gateways and streets. Through sketching, one may come to understand the complexity of interior design, and the essential relationships between the observer and the spaces he or she occupies.

For beginners seeking to learn how to draw and understand form, the interior as a subject offers many advantages. Sketching inside does, of course, provide shelter from the elements and generally there are fewer people peering over your shoulder than in busy city streets. In addition, interiors are normally regular spaces and hence they abide by the rules of perspective with greater clarity than do the complex angles of busy streets. Moreover, interiors are well articulated in the sense that doorways are framed by mouldings (known as architraves), walls join ceilings with a cornice, and most rooms have a focus of attention in the form of a fireplace or handsome piece of furniture. You can also move around interiors so that the sketch can become an accumulation of views or the superimposition of points of interest. Such collaging of material can make the interior sketch interesting in itself, and instructive as a piece of drawing. Hence interiors are a useful starting point for learning not only how to draw, but also how to understand the rules of architectural design.

The way space is depicted tells us a great deal about how that space is used. In Le Corbusier's sketches of the apartment-block interior at Unité, for instance, all is open, with the rooms mere zones of interconnected territory. The dividing walls barely exist, and where they do they are stripped of decoration. As a consequence, the space has little of the sense of meaning that results from applied decoration; instead, the quality of the apartment is

20.2 a and b (opposite)

Church interiors are usually well-articulated spaces. Columns, arches and windows define the interior volumes and provide space for different liturgical activities. These sketches are of Wells Cathedral and deliberately focus upon the building structure.

20.3 (right)

The handling of light and shade helps express the structural complexity of this fine space inside St Mark's Cathedral in Venice. The weightiness of the columns and piers means that surface decoration is barely needed.

20.4 (below)

Michelangelo's staircase to the San Lorenzo Library in Florence is a study in spatial complexity.

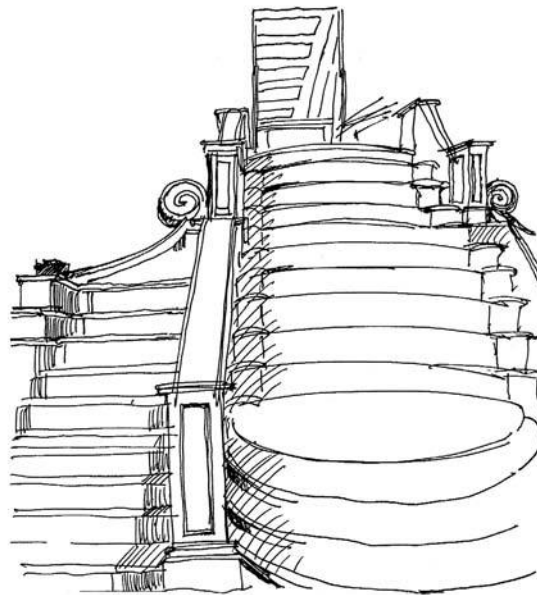
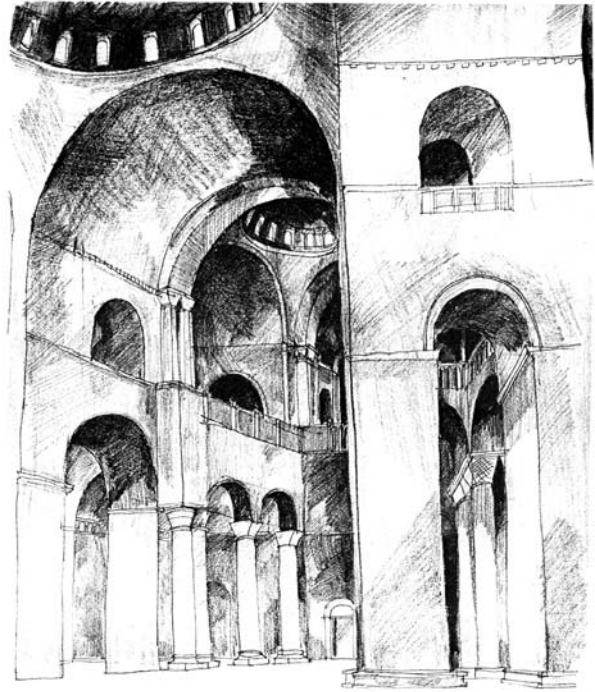

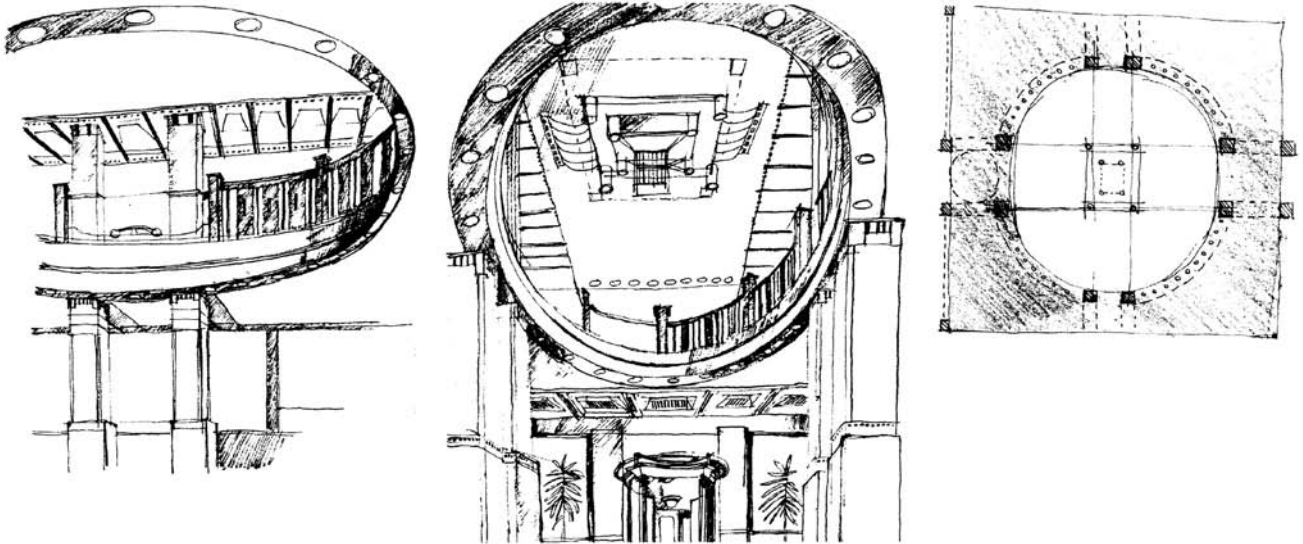

20.5

The bar of the Europa Hotel in Prague exploits a circular gallery in the centre of the room supported by Art Nouveau columns. The interior is a little, like a forest clearing with light flooding down from above.

determined by its proportions, the sense of openness, and the pictures, furniture and rugs. By way of contrast, the sketch of the 1930s ranch house in Kalamazoo, Michigan, derives its character from the decorative elements – be they columns supporting a beam or the patterned wallpaper. From such drawings we can learn that how one perceives an interior is not just to do with the relationship of shape and volume, but with the meaning given to the spaces by the applied elements of moulding, pattern and texture. Plan and section are not always adequate to explain the differences, whereas the sketch can capture the essential qualities and communicate the designer's intention, or at least the artist's interpretation of this. It is also a useful method for testing alternative ideas for improving an existing interior

or for creating new designs.

The links between the inside and outside of a building are as important as those between the building and the city to which it belongs. In a building the connection between interior enclosed space and exterior open space is the doorway. This is an important perceptual element and often has symbolic value. Hence sketches of interior space are often drawn looking through a doorway, and likewise drawings of the façades of buildings frequently contain glimpses through doors or windows into the interior. The combination of these elements gives the drawings extra complexity and richness, and no little mystery.

To understand architecture is to appreciate these qualities, and the sketch is a good way to cultivate such

20.6 (right)

The grotto-like quality of Parc Guell (Barcelona) by Gaudi is expressed here in a carefree drawing style. The roughly hewn stone columns and bizarre vaulting makes the space immediately memorable. Notice how the columns articulate the curved passageway.

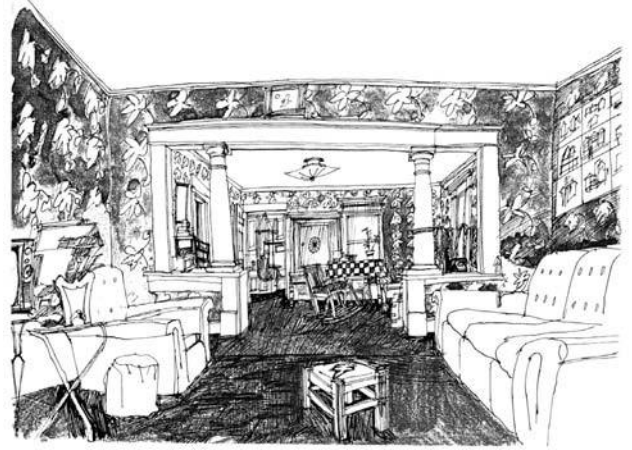

20.7 (far right)

This domestic scene in Kalamazoo, Michigan, is typical of suburban life. The columns and screen wall divide the dining room from the living room without introducing unnecessary enclosure.

20.8 (below left)

The interior of this hotel room in Barcelona opens on to the view of the street. Window shutters and the balcony provide a transition space between the interior and exterior worlds.



20.9 (below)

The linking of rooms is a common feature of interior design. In this apartment in Grenoble the dining room and salon are joined by double doors. The perimeter windows and the interior doors are almost on the same axis.

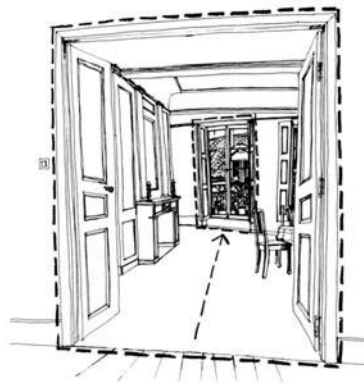

awareness. Thus the artist should not begin a sketch in too precipitate a fashion, but only after much careful contemplation of the subject. The interior of a building reveals a more personal world, by contrast to the public image of its exterior. Portraying the human dimension is often critical when evoking the quality of the interior – be it in the choice of furnishings, furniture or colour scheme. For instance, a room full of plants has quite a different character to one filled with paintings, or one left unembellished. Modernist interiors are often difficult to draw, but they can have a poignancy that would be lost in rooms where every surface is

trimmed with mouldings and divided into panels.

The artist's choice of drawing materials and the selection of shading or colour should suit the mood or complexity of the subject. For example, unadorned modernist interiors are best rendered in washes, using pencil or magic markers to provide highlighting. Classical rooms suit pen and ink with pale blue and pink washes. By contrast, the interiors of churches require deep tones and dark shadows to emphasise their weighty structure; yet the details need to be picked out, too, perhaps in pen or sharp pencil.



20.10 (far left)

The lesson to be drawn from this interior is the play of horizontal and vertical lines. The gallery and columns divide the space into units once used by the Glasgow tobacco merchants.

20.11 (left)

The harmonious proportions of this mosque in Mostav, Serbia, are expressed by the use of dark shading. By selecting a position on the centre line of the space, the drawing conveys something of the spiritual qualities of the interior.

On a practical level, because the artist is unimpeded by the weather when sketching an interior, whether of a house or of a ship, train or aeroplane, he or she is free to examine it in closer detail. Hence, one's critical judgements are often sharper with regard to interiors than with any other architectural subjects. Added to this, the artist can sketch while enjoying a cup of coffee, for instance, or listening to music, and the leisurely pace engendered by mixing activities means the act of drawing becomes more enjoyable.

Since we spend most of our time in interiors we are often more aware of their shape and mood than that of

city streets. Thus our drawings of interiors should be accurate with regard to both proportion and perspective. However, precisely because we are so used to occupying such spaces means that we have a tendency to sketch them in an instinctive fashion, without proper regard to the rules of perspective. If a room is regular in plan, the lines of the walls must be running to a single vanishing point even if it does not feel as though that is the case. By first establishing the eye level and vanishing points, the subject will not only be easier and more rewarding to draw, but the sketch will ultimately be more valuable as a means of understanding interior space.



20.12a and b

This comparison of two cloisters at San Lorenzo, Florence (left) and Pienza (right) shows the importance of articulating interior spaces.

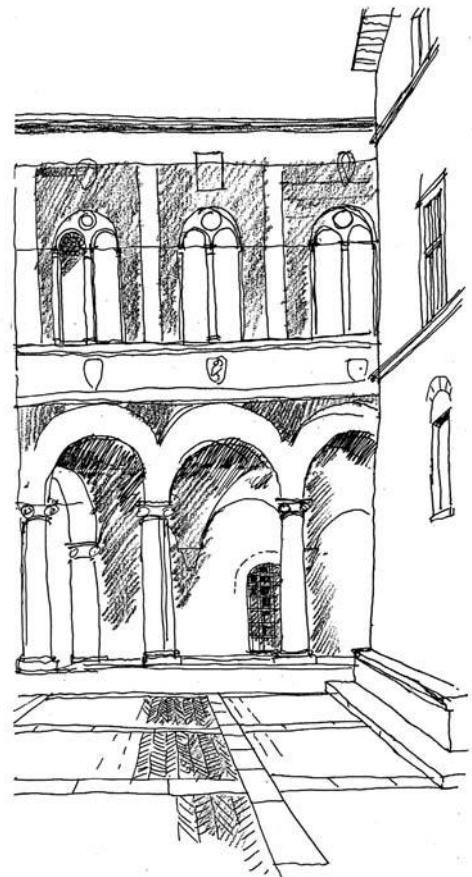

Chapter 21

Using drawing to analyse an urban area

CASE STUDY 1

THE MERCHANT CITY, GLASGOW

The Merchant City area of Glasgow is typical of the kind of inner city neighbourhood that can be analysed through drawing. By using a combination of freehand sketching and mechanical drawing it is possible to describe the main ingredients of urban form and the key role played by particular features of architecture or townscape.

Depending upon the nature of the area, the analysis could deal with the following points:

- the urban structure of the area;
- the role played by public buildings;
- the nature and characteristics of the background architecture;
- key decorative elements such as windows or doors;
- entrances and gateways;
- squares, streets, urban spaces and landscape design;
- proportional systems.

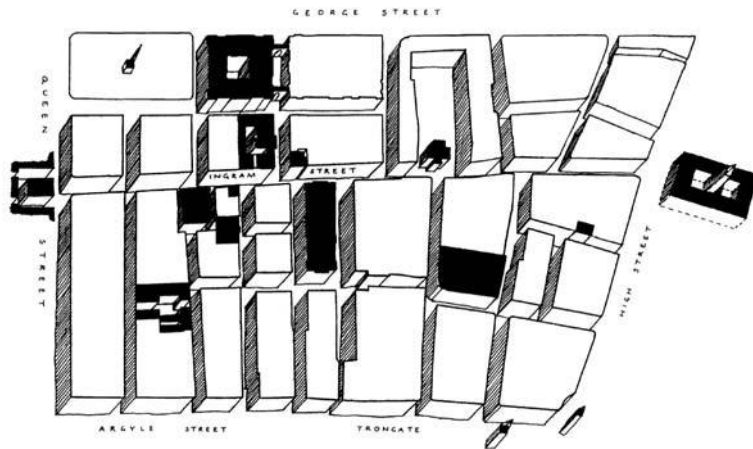

21.1

This axonometric drawing of the Merchant City area of Glasgow shows the public buildings in black and the rest in white. Simple shade has been employed to show the approximate height of buildings relative to the width of streets. The importance of Ingram Street is highlighted by the public monuments at either end (only one survives).

This list is not exhaustive; you should seek to embrace the particular qualities that the district in question offers. As the Merchant City was a planned expansion of Glasgow in the eighteenth century, the layout is fairly regular and this makes the analysis a little easier than had the area grown organically. However, subsequent changes to the urban pattern and to the neighbourhood's architecture have added complexity and spatial richness, and it is largely these qualities that the freehand drawing seeks to describe and understand.

THE URBAN STRUCTURE OF THE AREA

By using a good town map, preferably an Ordnance Survey sheet, it is possible to see at a glance the basic geometry of the area. The layout of streets, the pattern of squares, the placing of public buildings are all well described on plans and can be highlighted through figure-ground analysis. Moving from the two-dimensional plan to the three-dimensional image is where drawing comes in. By employing axonometric or isometric projection, or by using bird's-eye perspective (i.e. singlepoint, high-level) it is possible to represent the underlying structure of the area. Such a drawing requires a degree of simplification or abstraction, otherwise the irregularities of building height or façade line would defeat all but the most gifted artists.

Drawings of urban structure do not need to show detail – their function is to represent the spatial geometry in a simple, easy-to-grasp, three-dimensional fashion. By drawing cubes of building mass that show height in proportion to width, and that relate the various urban blocks to each other, the layout of an area will become clearer than had plans alone been employed.

The method is simple: with axonometric drawing, simply rotate the plan through 45° and project the lines upwards using the same scale for building heights as the one in which the plan is drawn. With isometric drawing you will need to employ a 60°/30° setsquare and, again,

do not allow for perspective in height or depth of field. Alternatively, you can employ perspective drawing, taking a high eye-level and vanishing point placed near to the centre of the sheet. Whichever method is employed (and remember axonometric drawing is the easier to make), it helps if the sides of the blocks are shaded to highlight the three-dimensional effect.

Other key information, such as the location of public buildings, parks and important squares, can be added relatively easily to the basic three-dimensional drawing. The advantage of this approach to drawing is that the relationship between the urban parts becomes self-evident. For example, the importance of a public monument to a street, or the role of a park in defining the edge of an area, becomes a little more obvious. Had your analysis relied upon plans alone, such relationships may not have become so apparent.

THE ROLE PLAYED BY PUBLIC BUILDINGS

The three-dimensional drawing described above is also important in helping to establish the scale of influence of a public building or civic monument. A public building can have its position in the townscape eroded by unsuitable neighbours. How far the setting of a building extends can be plotted on such drawings. Often the major buildings in an area have a relationship to each other, perhaps as skyline features or as markers along a particular street. Freehand drawing can be employed to study these aspects of the townscape, particularly if such sketches are related to the drawing of the whole area. Similarly, if a design is proposed for a building, it can be tested against existing neighbours so that the potential benefits or injuries to skyline or space patterns can be analysed.

In the Merchant City public buildings are generally located so that they terminate street vistas. This classical device is common to planned towns of the eighteenth century. In Glasgow it means that you can find your way

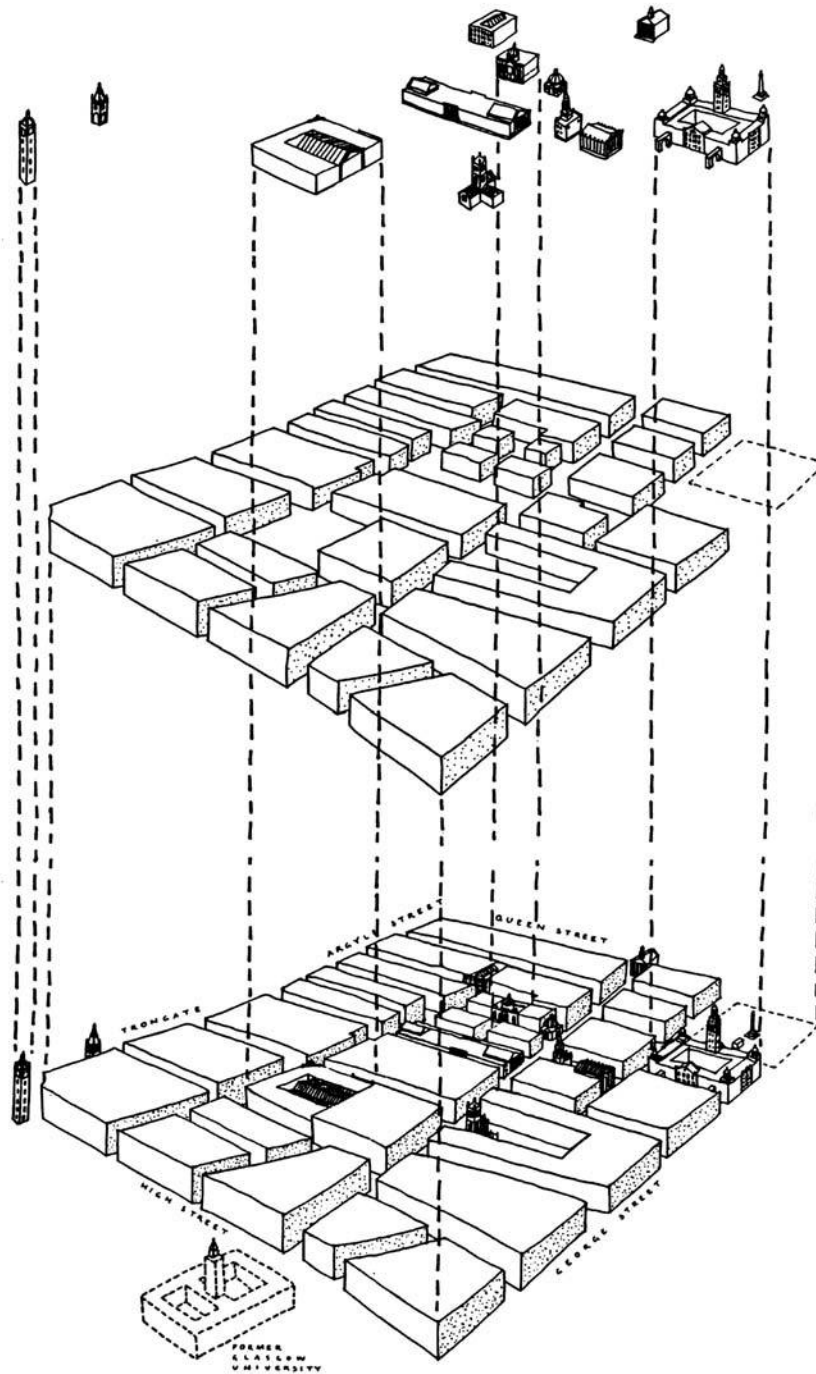

21.2 (left)

This isometric view shows buildings in less abstract terms than in Figure 21.1. Now the public monuments are given architectural form. George Square is at the far right. The drawing distinguishes between monuments and background buildings in order to show the relationship between the two.

21.3 (opposite)

The termination of Ingram Street by the Stirling Library (formerly the Royal Exchange) makes a dramatic sketch. The drawing is rendered with sunlight on the main façade and shadows expressing the depth of the colonnade. Notice how the eye is taken into the adjoining spaces by the arcade to the right.



with ease around gridded street layouts because the ends of certain streets are differently terminated. Although the public buildings were constructed over a relatively short period, their styles vary from classical to Gothic, and from simple shapes to elaborate structures adorned with towers and domes. The freehand sketch allows the varying ambitions of the different architects to be recorded and analysed. You will find that certain roads, such as Ingram Street, are terminated at one end – in this case by the former Royal Exchange (now the Stirling Library), which has a handsome portico projecting into the street space. The other end of this straight street opens on to the derelict east end of Glasgow. Thus a sketch of the street could not only highlight its distinctive qualities, but could form the basis for speculative proposals for terminating the open end.

Public buildings have a scale and presence greater than that of the background architecture. Although in the Merchant City they are not necessarily taller than their neighbours (except the City Chambers), they employ

columns, pediments and domes to establish their position in the architectural hierarchy. The use of decoration and visual codes can be the subject of a drawing, especially if it is related to the pedestrian's experience of the city.

In the Merchant City many public buildings have changed their function since they were built. Mention has been made of the former Royal Exchange now being used as a public library, but there are also churches that currently serve as night clubs, restaurants or theatres, and market buildings that are concert halls. The ability of monuments to adapt to new public uses is an argument of Aldo Rossi's in his *Architecture of the City*, and is well represented in Glasgow. The important point is to realise that the visual currency of places like the Merchant City depends upon the survival of the inherited public buildings.

THE NATURE AND CHARACTERISTICS OF THE BACKGROUND ARCHITECTURE

The background architecture of the Merchant City determines the physical context for the public buildings. Whether the everyday buildings are houses, offices or warehouses, they are the backcloth to urban life and contribute significantly to the character of this inner city area. The relationships between the function of an area, its buildings and how they are decorated are worthy subjects for sketchbook exploration.

The character of residential neighbourhoods in the Merchant City depends upon whether apartment blocks, tenements or converted warehouses are the main type of housing. Each has a different relationship to the street and a different form of exterior expression. Likewise, the degree to which housing is mixed with shops or work spaces determines not just the appearance but use of exterior space.

The industrial areas, too, have their own character. The presence of cranes, bollards, heavy doors and robust



21.4
This sketch of Hutcheson Street being terminated by Hutcheson's Hospital (Glasgow home of the National Trust for Scotland) exploits the verticality of the streets in the Merchant City. Although the original street pattern survives, this view shows how much the architecture has changed over the years. Note how the perpendicular lines of the buildings arrest the movement of the eye down the street.



21.5
As the termination of streets by public buildings is such a feature of the area, any graphic analysis should focus upon this theme. Here Robert Adam's Trades House (1794) acts as a focal point to Garth Street. It is framed by buildings whose height is the same as the width of the street.



21.6
Carved stone detailing such as this city coat of arms high on a church gable is typical of the older buildings.

materials give the workshop and industrial areas qualities that are immediately recognisable. Even the modern factory buildings such as the Glasgow Herald printing works incorporate similar industrial features.

The main business district is also distinctive; the perpendicular façades of modern office blocks and their sheer glass walls create unique townscapes. They are a challenge to the artist since decorative elements are normally in short supply; one has to rely upon plane, surface texture and parallel line. When an historic church or old house is marooned in such areas, a rendition of the relative scale and degree of decoration can lead to a telling drawing.

KEY DECORATIVE ELEMENTS SUCH AS WINDOWS OR DOORS

The design and detailing of windows and doors help establish the style of architecture. The use of decorative surrounds picked out in stone, brick or timber allow us to categorise buildings into particular styles, and often provide clues to their date of construction. Also the use of specific technologies in the design and fabrication of windows and doors tells us a great deal about the technology of the age that produced them. For example, the narrow width of Georgian windows and their subdivision into many small panes of glass provide insights into the structural limitations of the age and the specific problems experienced by the glaziers of eighteenth-century Glasgow in the production of glass. Similarly, the design and detailing of Georgian doorways give clues to the symbolic value of building entrances, and to the level of sophistication achieved by joiners at the time. Added to this, the proportional elegance of such doors suggest that even in provincial towns the language of the pattern book had been well assimilated.

Whole buildings are complex and frequently daunting subjects to draw, and you may instead prefer to



21.7

This view of George Square shows the dominating presence of the City Chambers (Town Hall), built in 1880. The vanishing point is along George Street on the left. Notice how statuary provides a focus to the square, which in this drawing excludes the trees and people.

concentrate your attention upon doors or windows. The architect often invests a great deal of time in the design of these elements, which makes them particularly worthy subjects for freehand sketches. As doors and windows are openings into a building, they are frequently framed in a distinctive fashion, and sometimes given symbolic value by the addition of figurative sculpture or lettering. Windows are normally dark openings crisscrossed by glazing bars in an attractive design. With the addition of blinds, curtains and shutters, the window provides a good subject for the artist, with its layers of different materials not normally depicted in architectural drawing. Although windows allow light into buildings, they also permit those on the inside to look out. Hence the world of the interior and exterior have their interface at the window, making windows

and doors a good subject for a sketch.

In the Merchant City, doors and windows come in many forms. In the warehouse areas many are plain and with repetitive forms, yet they establish interesting rhythms or patterns in the street scene. The subdivision of larger windows into smaller openings and the grouping together of these into tall bands give such areas their distinctive character. In some of the new apartment buildings circular windows have been used to express major street corners or to give verve to the design of rooftops.

When drawing windows and doors, it is often useful to exploit shadows. The set-back of windows within their frames allows a shadow line to be established that then becomes a major element in the composition of the sketch. The depth of shadow should reflect the distance

the window or door is set back within its frame, although when drawing this some licence is permitted. Each pane of glass or timber panel would also have a shadow, which provides a secondary layer of articulation. If the door or window is framed in columns with a pediment, these bigger architectural elements form a bold frame that imposes an order on the drawing – an order that makes visual reference, perhaps, to the larger structure of the building's façade. The various components of the subject will have their own scale, pattern and proportion – and it is these elements that should attract the architectural draughtsman's attention.

Modern doorways can be quite minimal in design, but the need for handles and hinges, and even security cameras, makes them interesting subjects. Like traditional doorways, the change of level at the threshold and the presence of signage and perhaps interior planting can provide material for a telling sketch.

To assess your local environment graphically, you should look at the details as well as the whole. The quality known as townscape is to be found in both the whole urban scene and in many of its smaller parts, such as windows and doors. Often the details are changed unsympathetically whereby the broader view, though structurally much the same, is gradually devalued.

ENTRANCES AND GATEWAYS

Every neighbourhood or district has its boundaries and hence entrance buildings. As we saw in Chapter 14, these may not be self-evident; sometimes you have to search them out, or to see such structures as hotels or pubs as gateway buildings. Just as every neighbourhood has its centre and a few special, often public, buildings, so too you will probably have a perception of the edges to the area and its entrances. In the Merchant City such entrance buildings may be recognised, for instance, in the cliffs of sandstone tenements and wide, straight

streets penetrating into the heart of the area and flanked by gateway shops (such as Marks & Spencer in Glassford Street).

The personal nature of a sketch will result in different people viewing the same place in different ways. Consequently, your perception of the entrances and gateways in an urban district – and this applies equally to the Merchant City – will differ from someone else's. But this is the strength of the sketch: unlike the camera, which can only record the same view no matter who pushes the shutter, a drawing is able to express different meanings and interpretations of a scene.

SQUARES, STREETS, URBAN SPACES AND LANDSCAPE

The gridiron layout of the Merchant City gives the streets a particular distinction. Planned in the eighteenth century, the area is not unlike parts of Chicago or New York – straight streets with right-angled junctions leading into leafy squares. Indeed, the streets are more important than many of the buildings, which merely provide the backcloth to urban life. The framing of the streets, their periodic punctuation by key buildings, and the fashion in which streets are linked to squares or churchyards make them a subject worthy of sketchbook analysis.

To obtain such drawings means, of course, that you have to work within the space of the street. The bustle, fumes and noise do not make for comfortable freehand drawing, and aids such as rulers are essential if speed is important. If you are concentrating upon street space then the activities of the street may be important. The relationship between the function of the buildings that line the street and how, as at the Italian Centre in John Street, the public space is modified by it may be central to the quality of place and therefore to its portrayal in your sketch.

21.8 a, b and c

New buildings bring with them modern details. These windows can be found in recent apartment blocks constructed in the area.

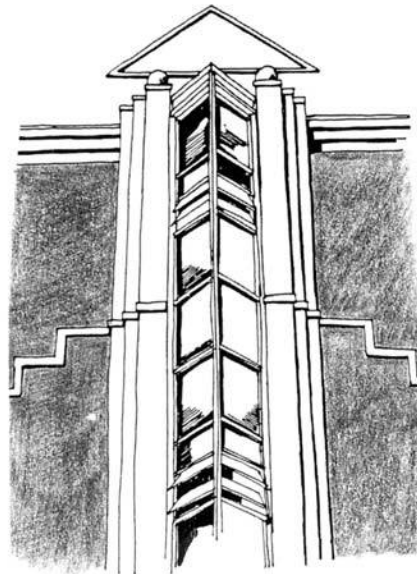
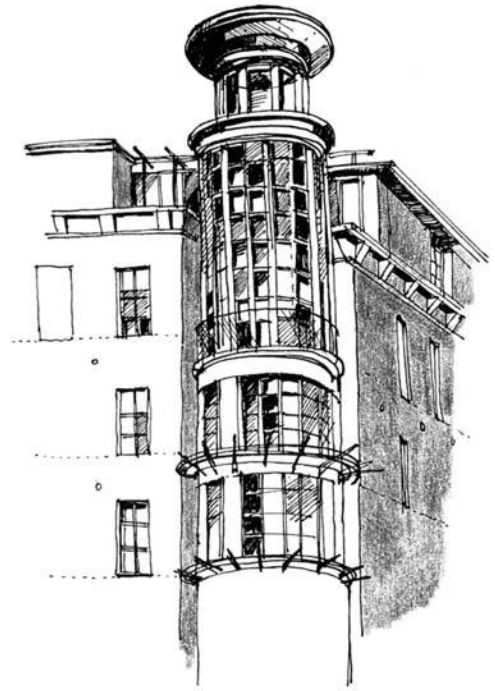
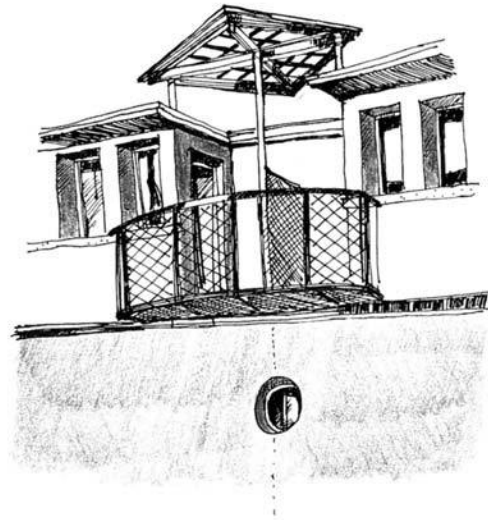



21.9

The silhouette of the Merchant City is as distinctive as its ground plan. Here the City Chambers and the tower of Hutcheson's Hospital are shown as viewed from an apartment in Ingram Square.

It is useful to get to know an area before starting to draw; note-taking can help to save frustration later on. What you will need to jot down are the best times to draw with regard to the angle of light and levels of activity, the position of terminating buildings (to provide visual stops to the gridiron layout) and places where greenery can soften the harsh lines of the drawing. If your sketch focuses exclusively upon the perpendicular lines of modern office buildings, then noting the best times for lighting effects could prove useful, as well as recording how such buildings relate to the street.

Tone, line and texture are useful techniques to exploit in such drawings. The rectilinear nature of modern streets and the canyon-like edges formed by modern buildings are best rendered in Conté, crayon, pen or soft pencil.

Where a particular building or tree stands in contrast to the remainder of the scene, it can be drawn in a different material, thereby adding complexity to the sketch.

PROPORTIONAL SYSTEMS

Many of our urban environments have evolved under the influence of building codes or planning regulations. Much of the New Town of Edinburgh grew up under a rule limiting buildings to three storeys, and the same was true of the Bloomsbury area of London. In many Victorian cities the buildings could not be higher than the width of the streets they faced because of the restrictions placed on them by the Municipal Building Acts. The effect was to lead to a certain monotony of layout, particularly in working-class districts, where 'mean houses faced mean streets'.

In spatial terms, however, the regulations often led to a rather classical sense of order. Where the buildings were high and the streets wide, a generous cube of space existed in the front of each building. The harmonious relationship between buildings and space engendered by such regulations was often reflected in the subdivision of the façades of buildings. In many nineteenth-century towns, and particularly in the Merchant City, a proportional system can be traced in both urban layout and building design.

Recent development in Glasgow has departed from the earlier pattern, and now modern buildings are higher relative to the street width than were their predecessors. The same is true of Edinburgh, London and even Boston, which grew up under similar influences.

Sketching proportional systems requires detailed analysis. You will need to look at the relationship of the various parts (buildings to streets, windows to walls, streets to squares) and record them through plan, section and elevation as well as the freehand sketch. An understanding of the inherited geometry of places is particularly useful if, as a student of architecture or a designer, you intend to make speculative proposals for the redevelopment of a site or, as a member of the public, you wish to object to the overdevelopment of a particular site.

A grasp of proportion is also important when drawing a complicated building so that its different sections are represented accurately. Buildings that are full of ornate detail or complex structural systems are not easy for the beginner to draw. By dividing the building into parts, each based upon an expressed structural system such as columns or a repeating pattern of windows or storey heights, a complex building can be reduced to its constituent parts. Once the basic subdivisions are in place and each has at least an approximation to reality, then the detail can be added later.

The advantage of breaking down a complex subject into simple subdivisions is to draw attention to the proportional systems behind the design. Often the proportions of a fine building are disguised by over-elaborate decoration or an array of recent signs. If as an artist you can see beyond the surface embellishment, you may uncover a proportional code that not only helps you draw the building, but also provides clues to design guides that could be adopted in the future, should you have ambitions towards being a planning officer, architect or developer.

CASE STUDY 2

THE BASTIDE TOWNS, FRANCE

The Bastide towns in the Dordogne region of France represent a unique collection of small country towns eminently suitable for a sketchbook study. Built as new, fortified settlements in the thirteenth century by different sovereigns, including the English King Edward I, each town contains a central market square surrounded by handsome arcades. A common range of elements is found in each of the dozen or so towns; besides an arcaded market square there is generally a timber-framed market hall, a centrally placed church used originally for defensive purposes, a town wall with gateways, and a gridded layout of streets. These elements make for a remarkable consistency in spite of the different origins of the towns. For whilst Edward I laid out Beaumont and Lalinde-Villeréal, Castillonnes and Eymet were new towns founded by the local monarch Alfonse de Poitiers.

The Bastide towns are grouped in a fertile region about 25 miles square, west and south of Bergerac in south-west France. Each occupies, or overlooks, a valley bottom since the agricultural development of the surrounding marshes was the principal starting point for the towns. As their economy grew, so too did their architecture. Houses, often restricted to three storeys high, blossomed

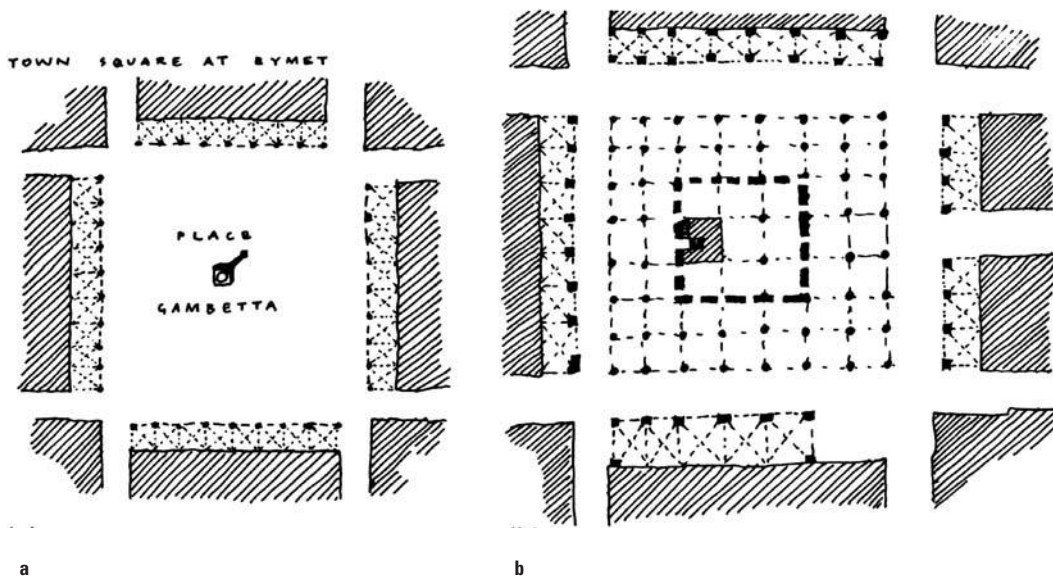

21.10 a and b

These town plans drawn from tourist maps help to explain the structure of the central squares of two of the Bastide towns of the Dordogne Eymet (a) and Villeréal (b).

with first Gothic, then Renaissance, decoration, reflecting the wealth of the merchants and farmers who flourished under aristocratic protection. Civic buildings quickly became more imposing, leaving a splendid heritage today. As the latter are grouped around or stand within the market square, their impact is both immediate and impressive.

Since the Bastide towns were developed according to a predetermined plan, they have a clarity that is unusual in medieval settlements. The square street blocks, central market place and clearly defined town edges (usually formed by a defensive wall or river) result in places that are well ordered and legible in architectural terms. In most cases the centre of the town is marked by a church or market hall, the main commercial activities are grouped

within the arcade around the central square, and the secondary streets support private houses and small shops. With gated entrances or approaches via medieval river bridges, the sequence from outside to inside is also well articulated.

The unusual qualities of urban design represented by the Bastide towns make them a fine subject for sketchbook exploration. As cafés and bars are grouped around the market square, drawings of the square and its contents can be prepared in some comfort from well-located positions. Several drawings are required to gain a full understanding of even fairly modest towns. In the case of the Bastide towns, a series of sketches can perhaps capture the sequence of views from the town edge to the centre, focusing upon key elements such as

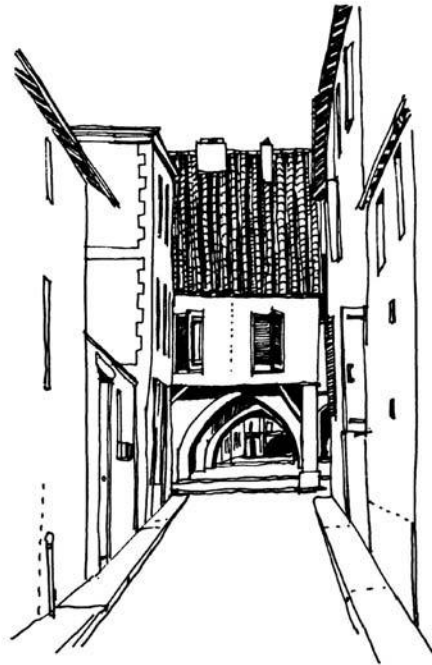
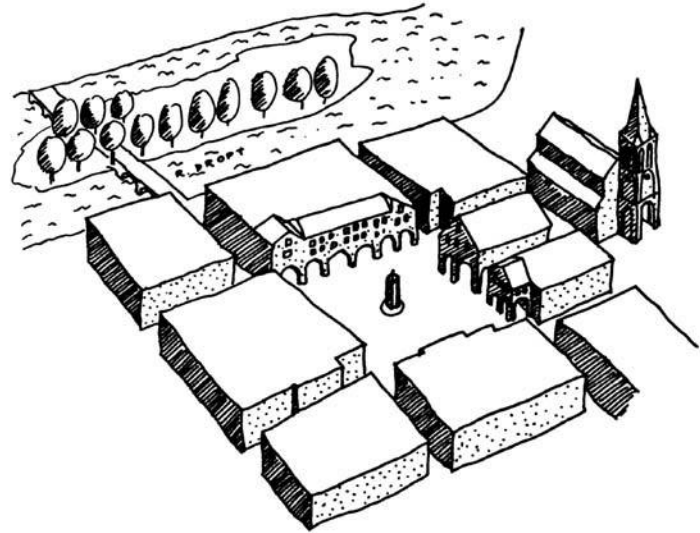
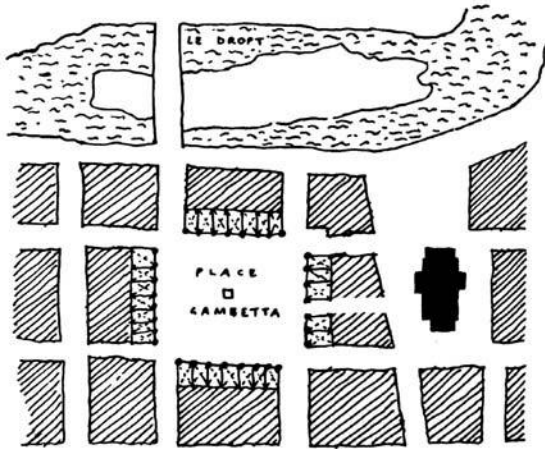

21.11 a and b (above)

This axonometric sketch of Eymet is drawn from a postcard. The relationship between square, river and church is more clearly shown on the sketch than in the plan.

21.12 (left)

This view into the arcade of the central square in Eymet is typical of the Bastide towns.



21.13 a, b and c

The market hall in Villeréal fills the central space. This sequence of sketches explores the progression from outside the square to the area beneath the timber floor of the market hall.

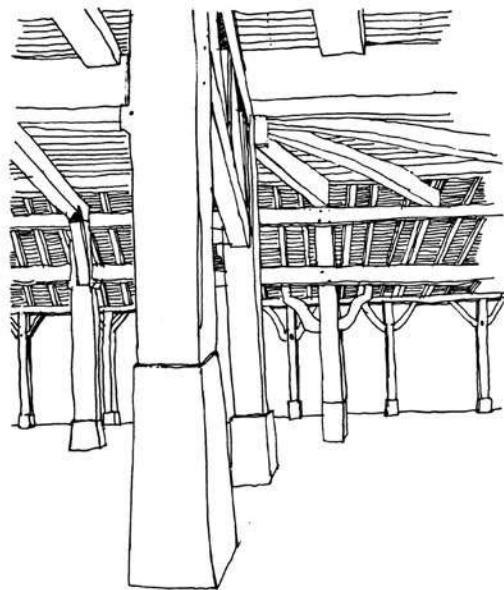

21.14 a, b, c and d

A similar exploration can be undertaken of the central market square at Castillonnes. Here the main square is left open, with public functions grouped beneath the irregular arches of the perimeter arcade.

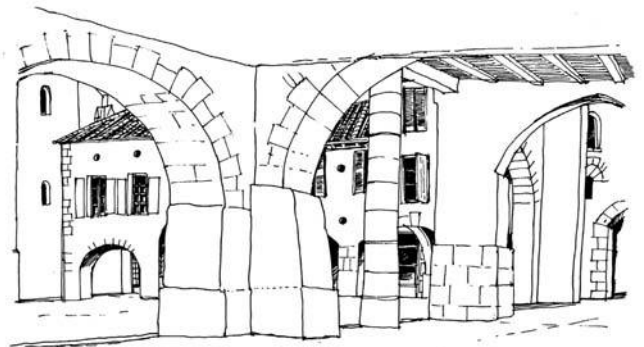
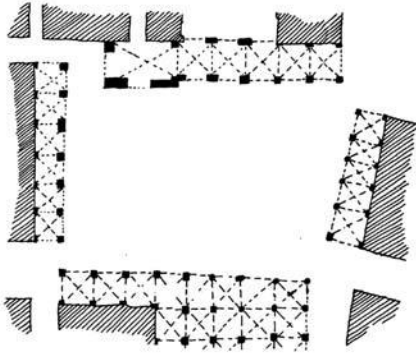

the gateways, arcades and public buildings.

Since the Bastide towns have characteristic layouts, picture postcards often show them from the air. These views can be adapted by the artist to show the structure of each particular town, thereby supplementing the street sketches with more analytical drawings. Detailed maps also show the town layout and these allow the geometry of street blocks, and the position of arcades and market halls, to be plotted. Combining sketches, axonometric views and figure-ground plans can result in an informed exploration of the subject.

Having studied the urban structure of the Bastide towns, the next step is to record the design of specific buildings. You might choose to focus on market halls, for example, where expressive carpentry could be the attraction; or upon private houses, which vary from modest structures to those with sculpted doorways, ornate window surrounds and splendid street-fronting courtyards. Hence in a few days the character of the Bastide towns can be studied and sketched, from the whole town to the details of individual buildings.

Rather than drawing subjects at random, the selection of particular themes gives a sense of purpose to the task of sketching that is both enjoyable and educational for the artist. In addition, the advantage of sketching small towns is their relative simplicity of design and lack of bustle. The modest Bastide towns demonstrate the advantages of a predetermined town plan which contains well-defined edges and has a clear civic focus in the centre. The layout of such towns offers lessons, perhaps, for our age with its ribbon development, poorly maintained central areas and lack of skyline definition. Like nearly all plantation towns, the new settlements of the Bastides brought with them a sense of geometric unity. It is this spatial and civic order that the sketchbook can record, and that is sadly lacking from the current proposals for urban villages.

CASE STUDY 3

JAPANESE URBANISM

Japanese cities are quite different in character and organisation to those in the West. The juxtaposition of urban elements, both commercial and industrial, and the presence of natural features leads to distinctive city forms. This is evident particularly in the skylines of the major cities, from Tokyo to Hiroshima. This case study uses freehand drawing to document the urban phenomena in order to better understand the forces at work.

There are perhaps four lessons to be gained from an analysis of the Japanese city. The first concerns the effects of deregulation, particularly of the impact of commercial pressures on the skyline of the major cities. High buildings are in a state of competition for the attention they can attract through architectural design. This is expressed particularly in the profiling of skyscrapers at their very top. Although high buildings are often distinguished by elaborate shaping from base to top, it is the upper storeys that are most celebrated. Here penthouse apartments for company executives, or conference suites, provide an excuse to depart from the standardised accommodation below. In the process there is competition for urban prominence that mirrors the commercial ethos present in many Japanese companies.

The second observation concerns the nature of the spaces between the skyscrapers. The urban landscape is squeezed by the architecture of the high-rise buildings with advertising signs, elaborate wire-scapes and glittering shop fronts providing the street experience at ground level. As a result, two conditions apply – that of the top of the skyscrapers and that of the bottom. At street level one is rarely aware of the rarefied world of the penthouses that exist sometimes forty storeys above. Since the buildings are so high and densely developed, only a limited amount of light reaches pavement level.

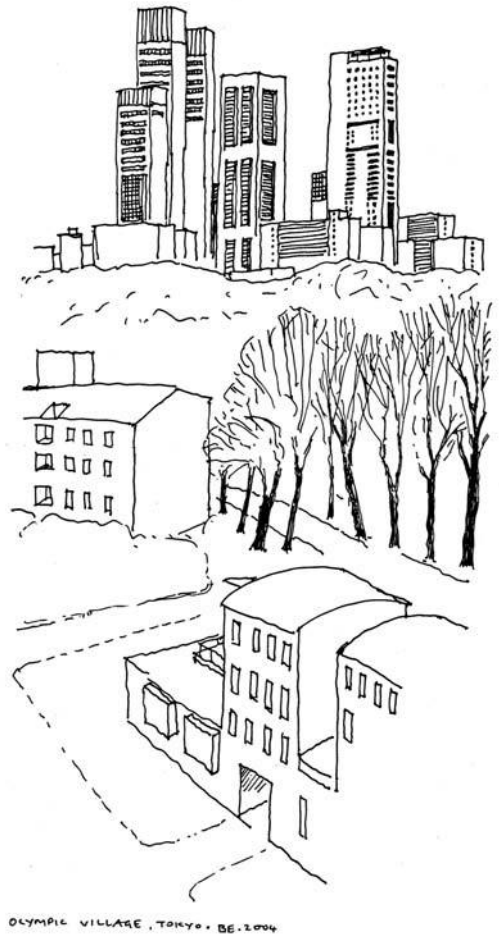

22.15 a, b, c and d

This study of the Shinjuku district of Tokyo highlights the benefits of clustering tall buildings together.

21.16 a, b and c

Skyline of Hiroshima from the 33rd floor of the Rihga hotel. The distant landscape is a welcome foil to the architecture of the city.

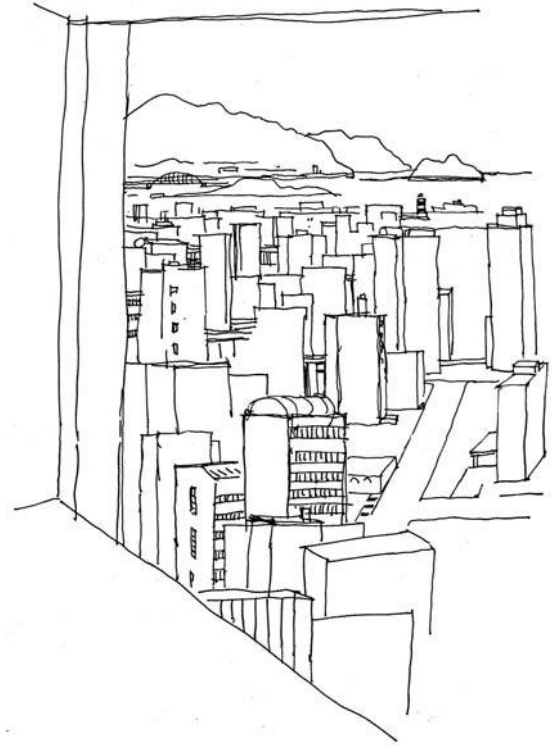
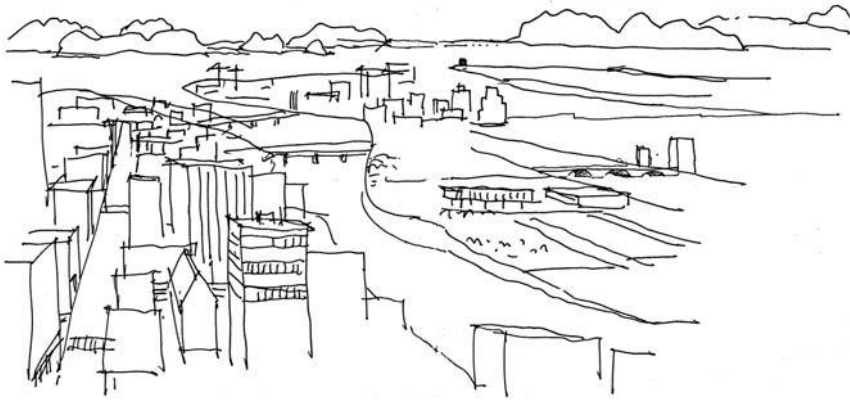
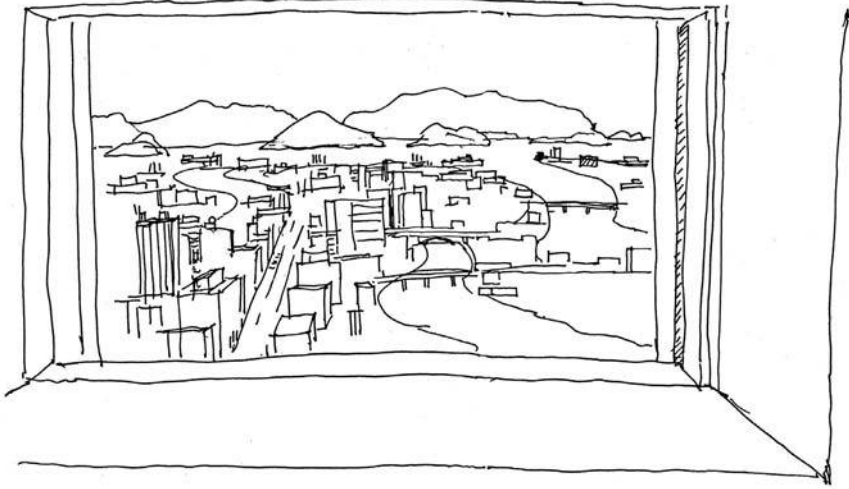

This adds to the drama of the spectacle and increases the impact of the advertising signs.

High buildings in Japan are normally clustered into tight groups around railway stations. A good example is Shinjuku in Tokyo where many of Japan's big companies have their headquarters. The competition for space and architectural impact is enormous, yet there are hints at the top of the towers of traditional Shinto or Buddhist temple imagery. This combination of high tech and tradition makes the silhouette of Japanese cities exceptional in their respect for cultural continuity.

The final observation that drawing such scenes reveals is the close proximity between architecture and landscape. Even in cities of several million people, parks close at hand and distant mountains set the architecture into a wider, more natural frame of reference. This is evident particularly in the studies of Hiroshima, where the sea and countless mountainous offshore islands soften the rectangular outlines of recent urban building. In a city that has suffered so much, nature provides an important source of reflection.

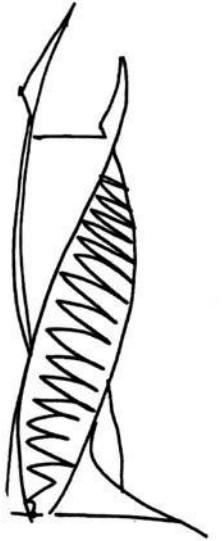

Part Four

The Way Forward

Chapter 22

Exploration through the sketchbook – some suitable subjects

Developing a personal appreciation of buildings and places through the sketchbook benefits from a structured approach. The pursuit of design experience via the freehand drawing requires an allocation of time and the selection of topics relevant to your urban enquiries. Rather than try to draw a whole town, it is often useful to focus upon part of a neighbourhood or a particular topic and explore it systematically. For example, you may decide to concentrate upon one street and show how its character changes from one end to another. Alternatively, you could focus your attention on a square or courtyard, recording how the buildings relate to the space, and how people interact with it.

As a student exercise it is often valuable to record and analyse through the sketchbook the key qualities of places, from their skyline to the spaces between buildings and the edges of districts. In fact a systematic exploration of topics along the following lines can heighten one's personal understanding of places.

KEY STREETS

Choose a street with which you are familiar and sketch interesting buildings or details, such as distinctive façades, signs or shopfronts, or spaces set back from the street. Once you have walked along the street a few

times, storing in your mind the key qualities and significant buildings, your next task is to record them through the freehand sketch and perhaps to locate them on a sketch plan of the street. Some points to note might be the positions and design of signs, changes in the angle of the street, and deliberate points of punctuation. If the street is a major one, you will probably find important shops or civic buildings located along it.

Once the exploration is complete and you have a collection of sketches and a plan, you can then begin to analyse the street by noting the critical factors in its design. Although valuable in itself and in your growing awareness of places, the exercise could lead to you suggesting changes in the design of the street to enhance its qualities. Sites for new buildings could be identified and sketch designs prepared, or suggestions could be made for tree planting or even traffic management.

Part of your exploration could involve the study of façades of buildings along the street. The patterns of windows, the rhythm created by the varying widths and heights of buildings and the different materials employed in their construction make good subjects for sketchbook analysis. Your drawings may consist of both a formal study of the street, in which detail is edited out, and a

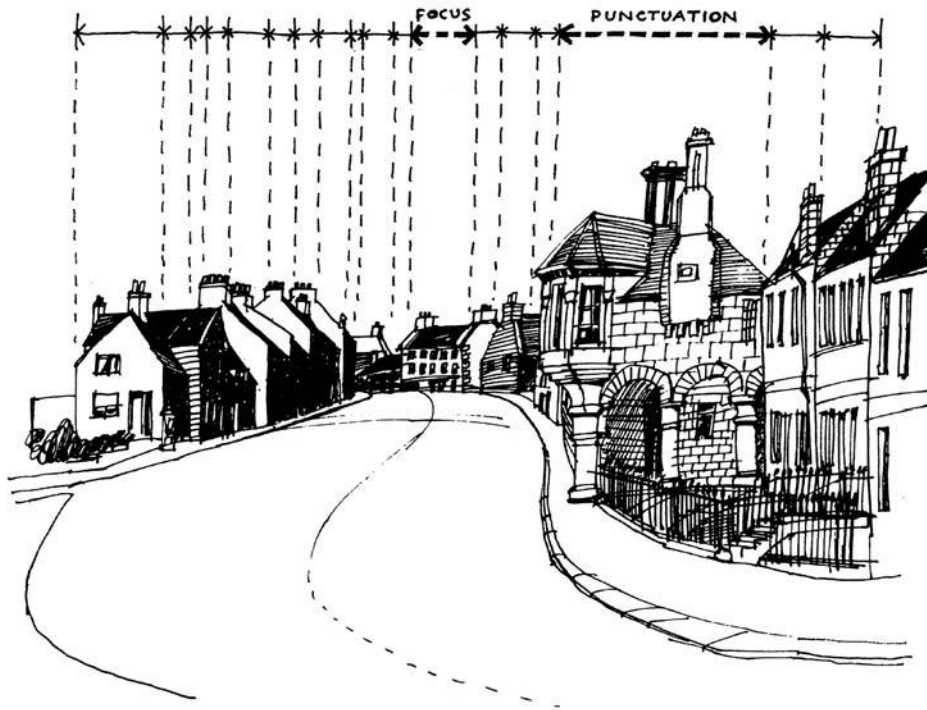

22.1

The sketch of Penicuik high street in Scotland shows the rhythm of house fronts. The sketch records the curve of the street and shows how the house in the distance becomes a focus and deflects the eye around the bend.

descriptive rendering that captures such features as texture and colour.

URBAN SPACES

Select a space in your town and record its key features using freehand drawing. These may include public buildings such as libraries or the town hall, or – if the space is a residential square – perhaps repeating house fronts. The degree to which the space is enclosed, the height of the surrounding buildings, and any features such as sculpture or trees in the centre of the square should all attract the artist's attention.

If the square is large and complex, you will probably have to focus your attention on a single aspect of it. If, say, you decide to explore how the library relates to the

square, then you could draw the façade of the library, its entrance, and the way the doors open out from the space. Many public buildings have a gathering space outside the entrance, perhaps sheltered beneath a columned portico. Often major squares are landmarked by a tower or spire and this, too, could form the subject of your personal exploration.

In smaller residential squares, the use of shared balconies, communal drying areas or playgrounds for children may be an important feature. Such courtyards are frequently jam-packed with cars or filled with dense greenery, and again this could provide a fruitful topic for sketching.

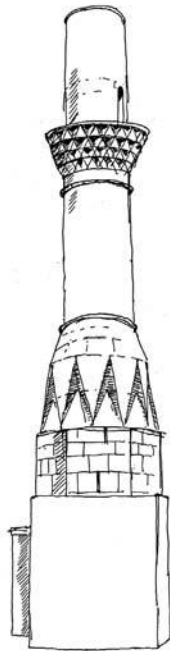
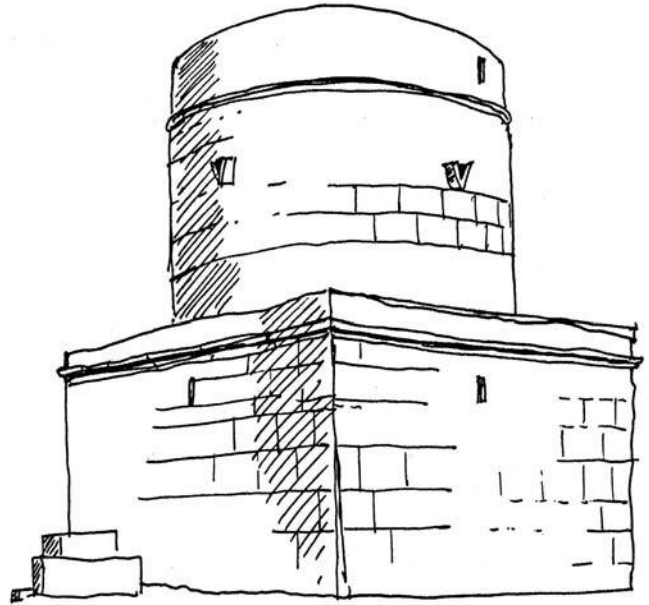

22.2a, b, and c

This sequence of sketches records monuments in the Turkish city of Antalya. Each tower has a square base which accommodate different shapes of the tower above.

SKYLINE

The study of skyline and silhouette shows how important tall buildings are to the character of different towns. Many cities are marked by distinctive skylines: London's Houses of Parliament (and particularly Big Ben), the Eiffel Tower in Paris, the Empire State Building in New York all give a unique stamp to the urban silhouette. Lesser towns have their own characteristic skylines, too, though on a smaller scale. Places like Guildford, with its twentieth-century cathedral, and Antalya in Turkey, with its collection of Roman monuments, have skylines that shape the perception people hold of the towns.

Drawing skylines requires a bold approach and much use of dark shading. The skyline should ideally be drawn from both inside and outside the town, and from different angles. You may well find that tall structures denote the town centre, acting as markers to the commercial core. It may be, however, that the tallest buildings are the least interesting. Many modern office and apartment blocks are dreary structures, while the lower church spires are more profiled and hence worthier of note.

When sketching the skyline, one is also free to use one's imagination to modify the silhouette of the town. By re-profiling tower blocks or by adding new structures to the roof, the shape of the building can be changed to the benefit of the city skyline. As most of the high buildings in Britain were built in the 1960s and 1970s when the aspirations of building design were not very high, the opportunity exists to use the sketches to speculate upon how such structures could be enriched to improve the skyline and hence legibility of our towns.

NEIGHBOURHOODS

Big towns are really a collection of villages of which each is a separate entity, a neighbourhood shaped by distinctive building types (terraced houses, semi-detached, tenements, flats) or different land uses (offices,

warehouses, educational areas). Land use is usually reflected in building type, reinforcing the sense that a big town is really a collection of different districts each with its own characteristic architecture.

Freehand drawing is a good tool to use in analysing neighbourhoods. First choose an area that is not too large or too complex to draw. Determine the boundaries of the area, its centre and key urban and architectural qualities. Study where the public spaces are and how they are designed. Look at how different districts are defined by major traffic routes or natural features such as hills or rivers.

Sketch the major building types in order to record and understand their form. Look at how buildings and spaces are arranged in plan form and perhaps in section. Draw characteristic details such as bay windows and entrance porches if you are dealing with a residential area, or glazing grids and office doorways if you are sketching a commercial neighbourhood.

The heightened awareness achieved by such an exploration allows students of architecture and design to intervene in a fashion that enhances, rather than destroys, the inherited patterns. The task of the urban designer should be to strengthen the character and culture of places and to add new richness. Places should be visually firm and well structured, with additions reinforcing the existing style of the neighbourhood.

BOUNDARIES AND BARRIERS

Towns, and even the countryside, consist of places with marked boundaries. These are often natural features such as rivers, but they can be railway lines, motorways and embankments. These barriers help divide the city and its surrounding countryside into parcels with clearly defined edges. Edges, corridors and boundaries are rewarding subjects to draw because of the way buildings interact with them. In London, for instance, the Thames forms a

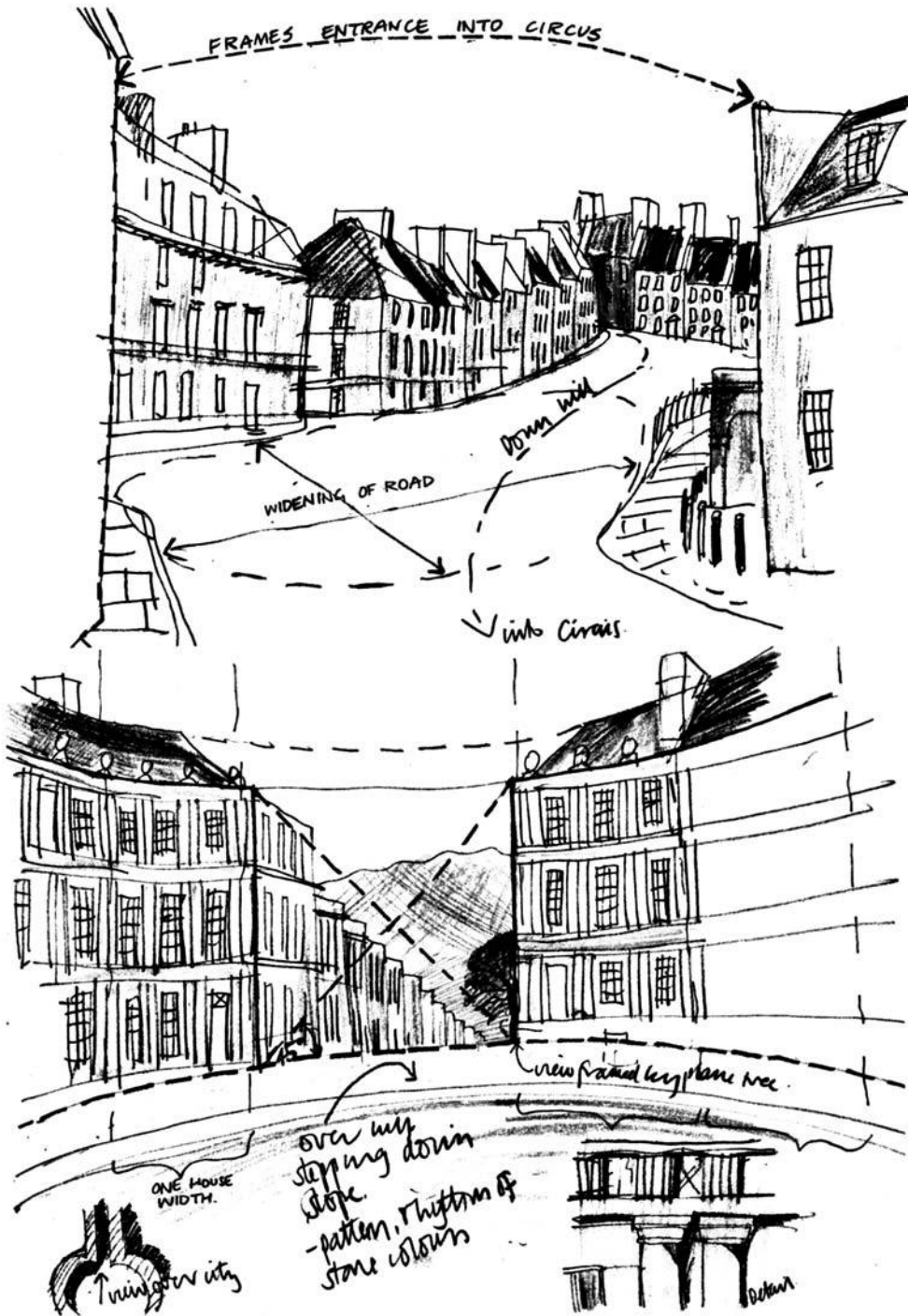

22.3 a, b and c

The streets of Bath provide an opportunity to study urban proportions. These quick sketches mix details with general views and employ simple graphics to augment freehand drawing.



22.4

This courtyard house in Syria expresses well the values of the society that it serves. The courtyard house is a relatively neglected domestic type.



major barrier between the two halves of the conurbation. The river itself is lined with warehouses, office and apartment blocks, and the occasional public building. The bridges create links between the two edges, giving them a particular significance. If you take a river bus in London or Paris, you quickly become aware of the qualities the river has as a corridor with firm urban edges.

Similarly, to drive along urban motorways is to be aware of the edges formed by these vast concrete structures that divide the city into huge parcels of land. A study of how buildings interact with these barriers is important to both the architect and town planner.

Roads often define the limits of our cities: a ring road, for instance, may constitute an urban boundary – built up on the city side and left green on the other. In sketching

boundaries the task of the artist is to search out examples of continuity and discontinuity. Edges are best when they are visually firm and well defined. One could perhaps explore a river or motorway, noting and sketching strong and weak points. Rivers often flow through fragmented areas, such as older docklands, passing through to well-regulated townscapes in the city centre. By selecting particular viewpoints you can explore these physical barriers, noting in the process areas where the edges should be better defined, or where the barrier may be bridged by some form of new structure.



22.5 (left)

Fragments of buildings can be rewarding, especially if as well articulated as this Glasgow apartment block.

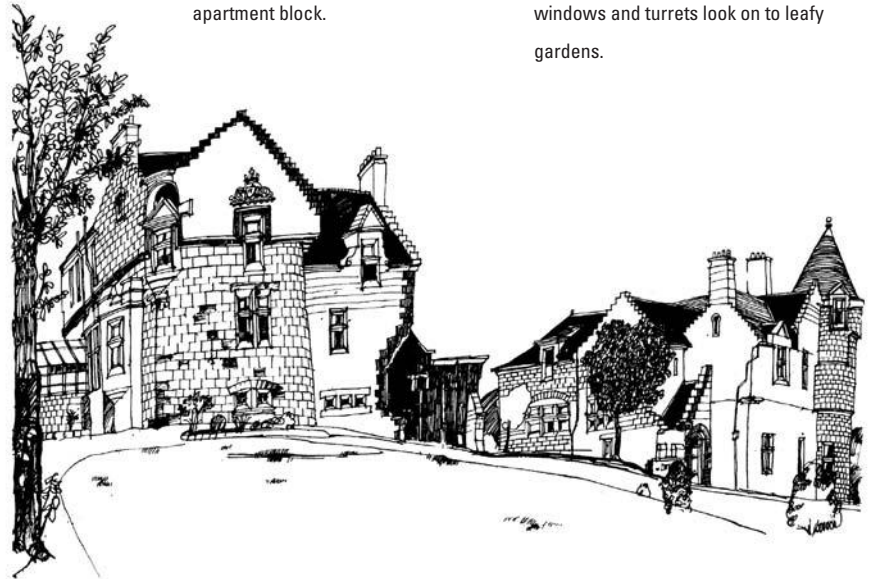

22.6 (below)

The imposing suburb of Pollokshields in Glasgow provides ample material for the sketchbook. Here houses with bay windows and turrets look on to leafy gardens.

BUILDING TYPES

Most towns consist of a collection of distinctive building types whose qualities and variety are representative of the area. The three-bedroomed semi-detached villa is typical of southern England, the terraced house of the Midlands, the tenement of Scotland and the courtyard house of the Middle East. By selecting a specific building type you can explore its various manifestations within a neighbourhood or geographical area, relating the elevation of different buildings to aspects of their plan. Such an exploration through the freehand sketch can highlight regional differences and teach you about the traditions of your area.

Your exploration could embrace factory buildings, offices, warehouses and churches as well as residential

buildings. By selecting a specific building type and studying the permutations of form and arrangement in a precise area, it is surprising how many examples can be discovered, and how varied their design is. In addition, focusing upon selected building types encourages you to become knowledgeable about the design of that particular category of buildings. In the past, schools of architecture required their students to keep a sketchbook of buildings, categorising arrangements of plan and elevation within specific building types. Besides cultivating an appreciation of the links between the design of the building plan and the treatment of the façade, the use of sketchbooks also encouraged the students to learn from past examples rather than seeking to design new building types from scratch.



22.7 (left)

This street of urban tenements in Glasgow exploits the compositional possibilities of bay windows. The terrace forms a crescent around a shallow planted square.



22.8 a and b (below)

Many inner city areas contain the houses of once prosperous merchants. These two villas are from a 19th-century district of Vancouver.



BUILDING DETAILS

If whole buildings or engineering structures are too complex for your needs or drawing skills, then select an aspect of their architecture or construction. You could concentrate on a relatively simple subject such as windows, chimneys or roofs, or alternatively you could attempt the more difficult topic of shopfronts, curtain walling or decorative paving. Whatever subject is selected, ensure you locate the example clearly and use a drawing style that allows one example to be compared with another. It is remarkable how much pleasure you will derive from building up a collection of examples drawn from your neighbourhood or on your travels. You will be surprised, too, at how freshly you view your local environment once you have taken the time to record and analyse it through the freehand sketch.

EXPLORING YOUR LOCAL HERITAGE

Sketching is an excellent way to study your local architectural or archaeological heritage. You do not have to be a great artist to benefit from the heightened awareness of the subject that drawing it gives. The exploration of one's locality through the freehand sketch can be supplemented by accurately measured surveys or searches through documentary sources. No matter where one lives, the local environment will provide much material for those intent upon exploring a town's heritage.

Whether you choose to study the conservation of town houses, rural farms or industrial monuments, drawing on location is an essential starting point. Such studies can deal with building types that may interest you – perhaps the arrangement of farm buildings outside your town – or with special parts of the town, such as conservation areas. If you are drawing primarily for pleasure, seek out attractive compositions and comfortable locations, but if your sketch is part of a

systematic analysis then you should adopt a more methodical approach.

For example, if you are studying farm buildings, start with a specific building type, such as threshing barns, or particular farm layouts, whether U-shaped or based around a courtyard. The important point is to build up a collection of sketched case studies that can be compared in both general form and detail. In no time you will be surprised at the similarities that exist between subjects and the subtle evolutions of form that emerge in response to changing farm practices or different climatic demands. By analysing a specific building type fairly closely, your knowledge of the local environment and its architectural heritage may well exceed the documentation available in local libraries. It may be possible to compare your field sketches and notes with historic maps of the area, allowing you to speculate upon the development of particular farm types in your neighbourhood. Such exercises have obvious value in environmental education and could be used to support the conservation of such buildings if they are threatened by planning applications.

If you are seeking to analyse historic buildings in your neighbourhood through the medium of freehand drawing, you may find it useful to add sketch plans or details of such things as windows or gate hinges to the space around the edges of your drawing. A single sheet can then provide a wide range of useful documentary material. This supplementary material may prove useful if you are seeking to date the building or identify the people who built it.

EXPLORING DESIGN: THE WORK OF FOUR GREAT ARCHITECTS

A great deal can be learnt from a careful study of buildings designed by famous architects. How they fashion a corner, model a façade, or organise the ground plan are

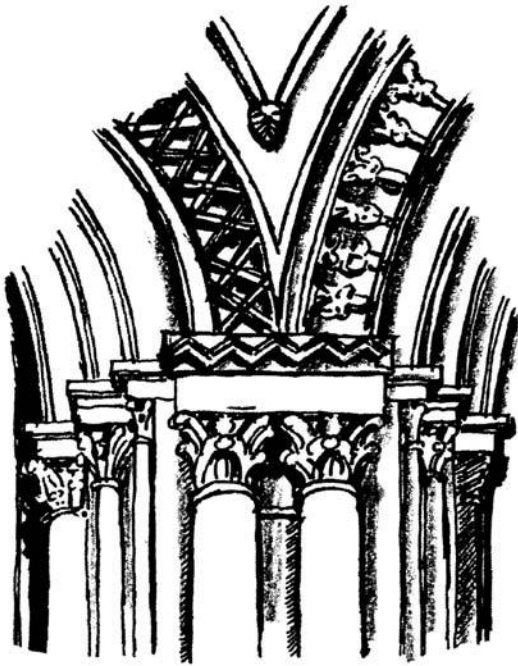

22.9 (far left)

The Norman carving on the capital of each of the nave columns at Bayeux Cathedral varies from one column to the next. This sketch is one of a series that chart the differences along the nave.

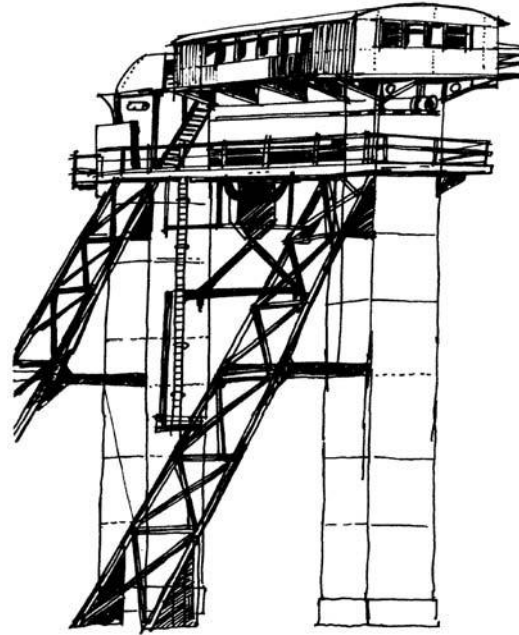

22.10 (left)

Industrial architecture provides some of the most sculptural subjects for those intent on learning about design. This crane is to be found at Harwich.

useful fields of inquiry. Armed with a sketchbook and plenty of time, the student should be able to visit a building and, through making descriptive or analytical drawings, come away with an enhanced appreciation of architectural design.

It is remarkable how many buildings by famous architects exist in most European cities. Wherever you live, it should be possible to analyse a building of real worth. As a resident of Glasgow I have the works of Charles Rennie Mackintosh and Alexander 'Greek' Thomson on my doorstep, and should I live in Edinburgh or London, I would have the buildings of Robert Adam or Richard Rogers to explore. The examples given here are from Glasgow's two great architects, together with sketchbook studies of Le Corbusier's Ronchamp Chapel

and various buildings by Antonio Gaudi. Sketches of works by the latter are the result of visits to France and Spain specifically to experience, record and explore the works of these two fine European architects.

It is important to seek out the works of major architects. Experiencing buildings and places first hand is infinitely more valuable than studying their designs by way of slides and construction drawings. The sketch heightens the act of experience, and forces the observer into a critical relationship with the subject. A systematic approach is desired, though many undertake the freehand drawing in a more spontaneous fashion.

Depending upon the building, the sketchbook analysis will probably move from the exploration of the whole to the detail, and from the edge to the interior. Such features

22.11 a, b, c, d and e

These drawings of buildings by Mackintosh seek to explore how he handles design. His bold massing and contrast between horizontal and vertical lines, and between solid and void, are the basis for these studies.

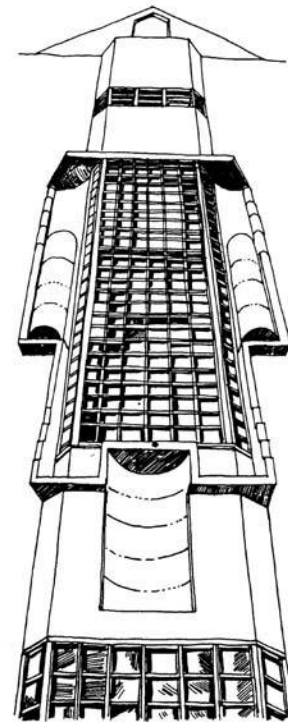
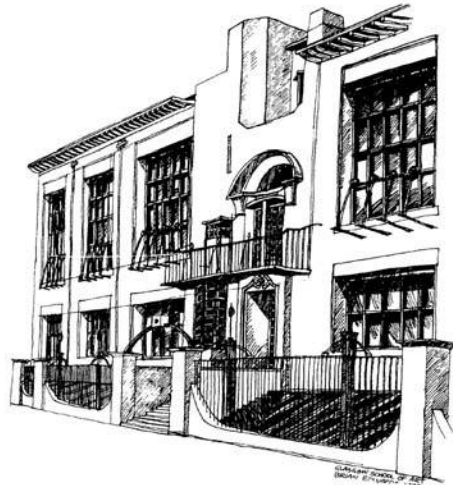
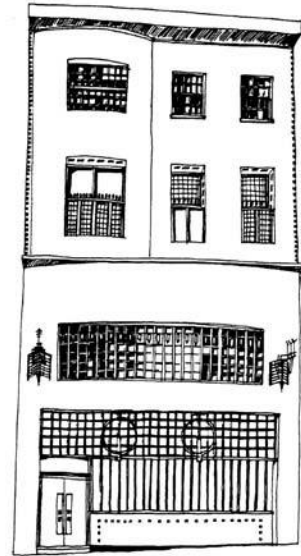
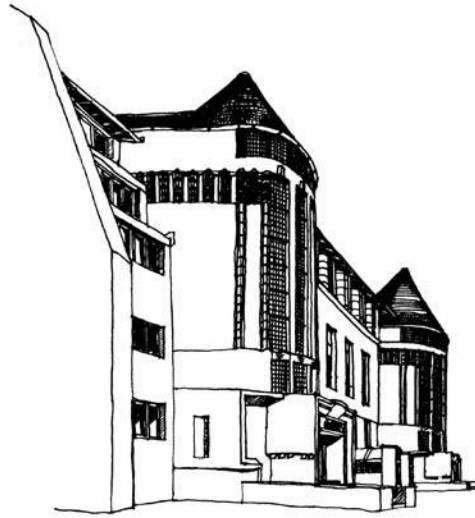

22.12 a, b, c and d

Alexander Thomson is recognized as a master of street architecture. This graphic study of his buildings in Glasgow focuses upon his handling of façades.

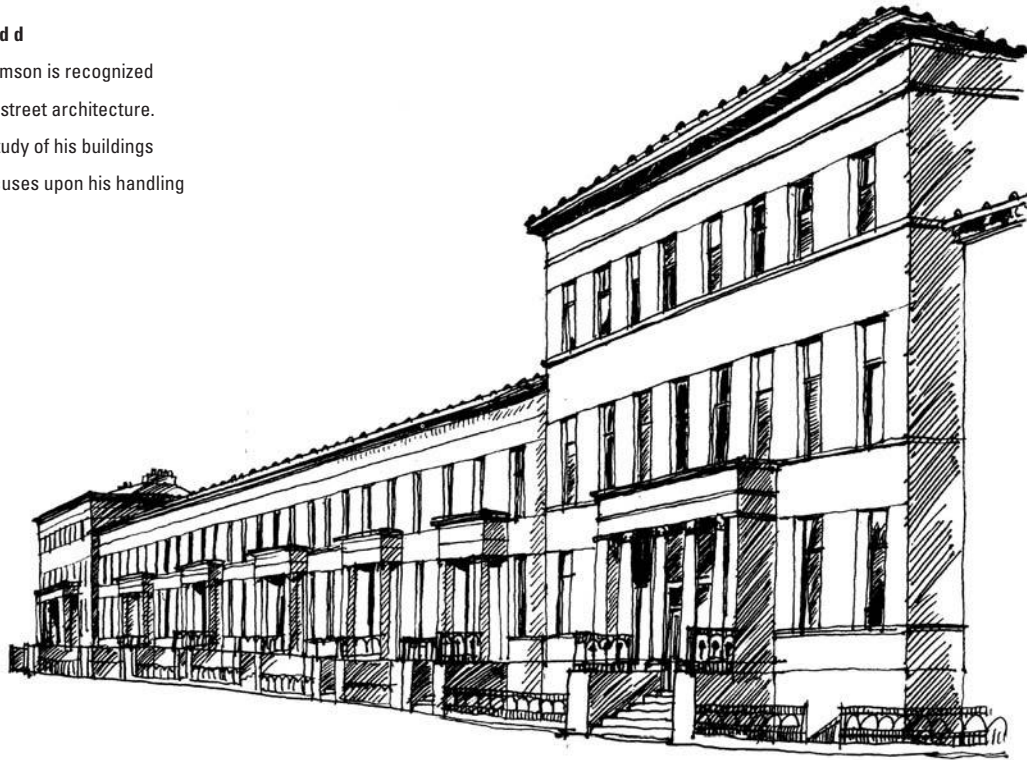



as entranceways and staircases might deserve a specific sketch, as would windows or railing details in the case of an architect such as Mackintosh. The general sketch may relate the structure to its context, showing perhaps how the building interacts with the pavement that edges it. The analysis may include a sketch plan or section to show how the external form relates to the plan of the building. Drawings help unravel the complex parameters under which designers operate, making clear their architectural intentions.

By examining the work of different architects, the student of design gains insights into the diverse philosophies in operation. It is evident in the illustrations included here that while Mackintosh is concerned with abstract forms and shapes, Thomson is stretching the classical language almost to breaking point. While Le Corbusier employs heavy concrete walls to create a monumental modernity, Gaudi breaks the surface into decorative flowing lines derivative of natural or organic shapes.

22.13

Antonio Gaudi built several notable apartment blocks in Barcelona at the turn of the century. How he composed the façade around flowing lines is of interest here.

By focusing upon a specific issue of design, the sketch should be selective in spirit. It is of little value to strive to record every detail whilst missing the fundamental truth. No matter where one lives, there are examples of good architecture available to help teach lessons in design. Our accumulated wisdom as designers resides in the buildings round about us. Both the successes and failures of design are to be found in most towns, even those lacking the works of well-known architects. Armed with an appetite for sketching, the student should gain useful insights into what has been built, thereby continuing a tradition. Of course, good design is not a case of blindly repeating the language of the inherited monuments, but of inventing new forms by changing the angle of refraction. The sketch teaches us how to look and learn from the past without inhibiting movement into the future.



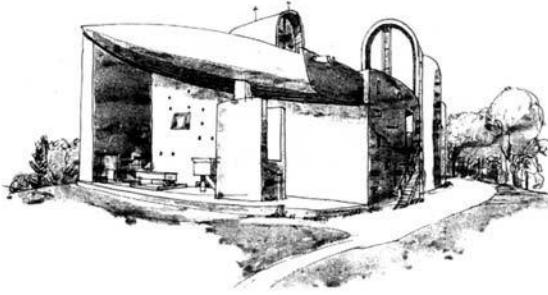

22.14 a, b and c

Le Corbusier's chapel at Ronchamp has lessons for those interested in church architecture. His handling of shape, light and space is the main interest of these sketches.

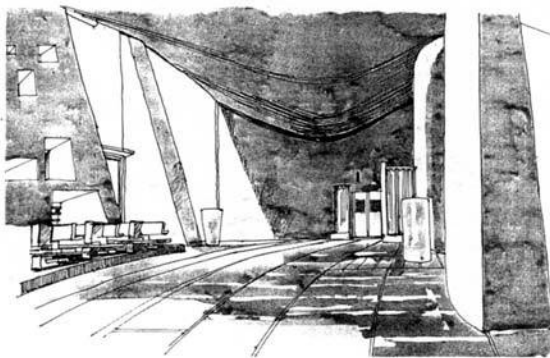
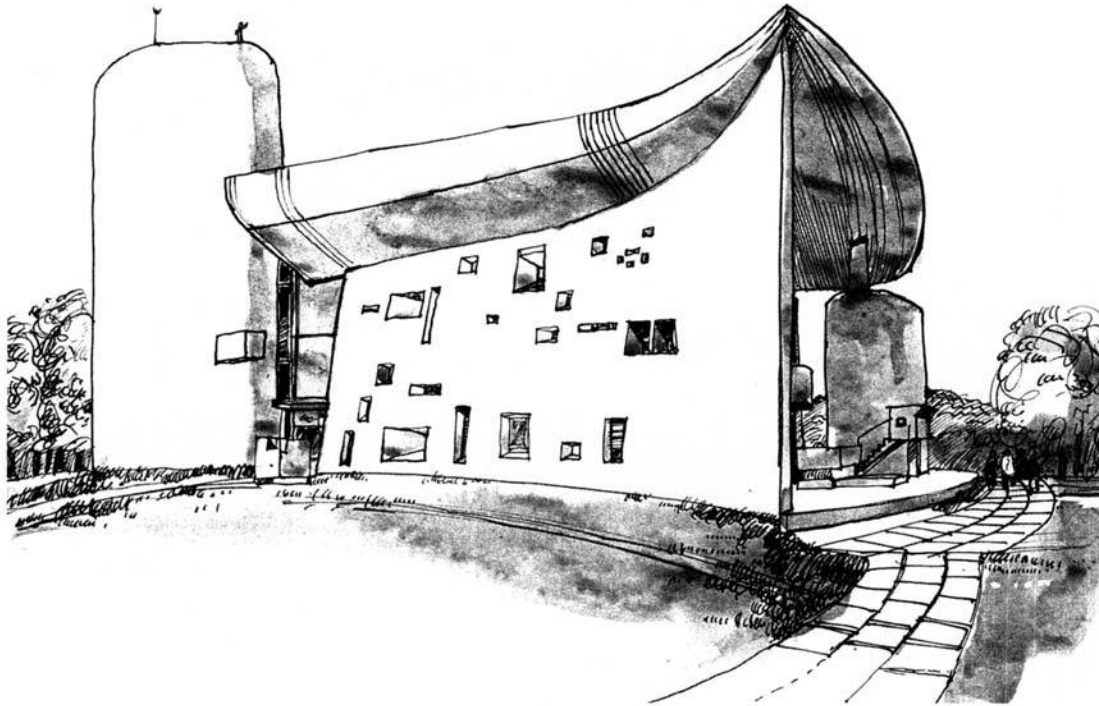

Chapter 23

From sketch to design

Having become accustomed to using the sketchbook as an aid to visual understanding, it is not too much of a leap to begin thinking in design terms. Your sketches will not only have sharpened your perceptual awareness, but more importantly opened your eyes to how a designer thinks. Basically an architect or urban designer has to evolve a form – hopefully an elegant one – to suit a particular function, and relate it to a context. Hence design is a two-way process – working from the functional programme outwards, and from the physical surroundings inwards. How well the balance is struck establishes the appropriateness and even beauty of the design.

Most books on design focus upon programme, process and function, leaving aside questions of suitability to townscape or landscape. By way of contrast, this book looks at the visual language of places in an attempt to address the balance. Drawing existing buildings, squares and streets not only provides a rich repertoire of details and forms from which to seek inspiration, but teaches something of the significance of particular places and their functions. To draw an area of eighteenth-century London, for instance, is to realise how important buildings and squares are to each other – to understand that a

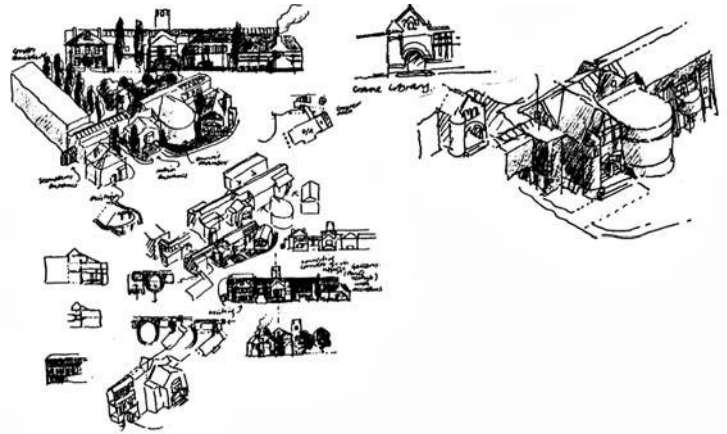

23.1 a, b and c

Richard Reid's drawings of Epping High Street provide the context for the design of his town hall. The dictates of function are moderated by a concern for the historic fabric of the town. These sketches show how place and programme are reconciled.

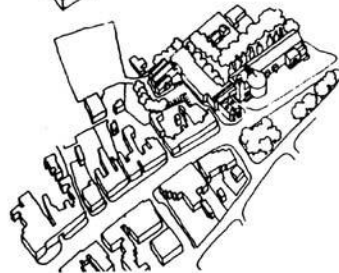
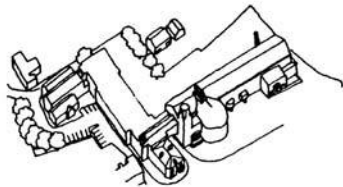
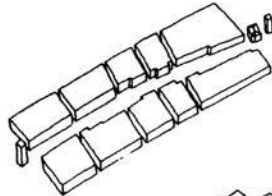
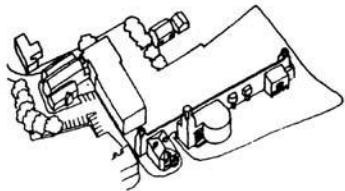
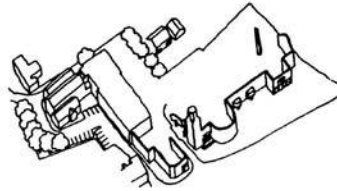
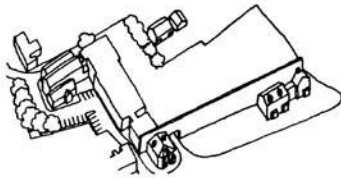
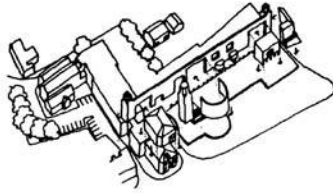
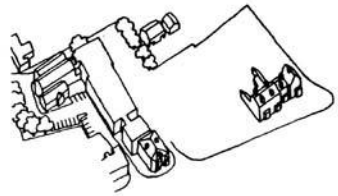
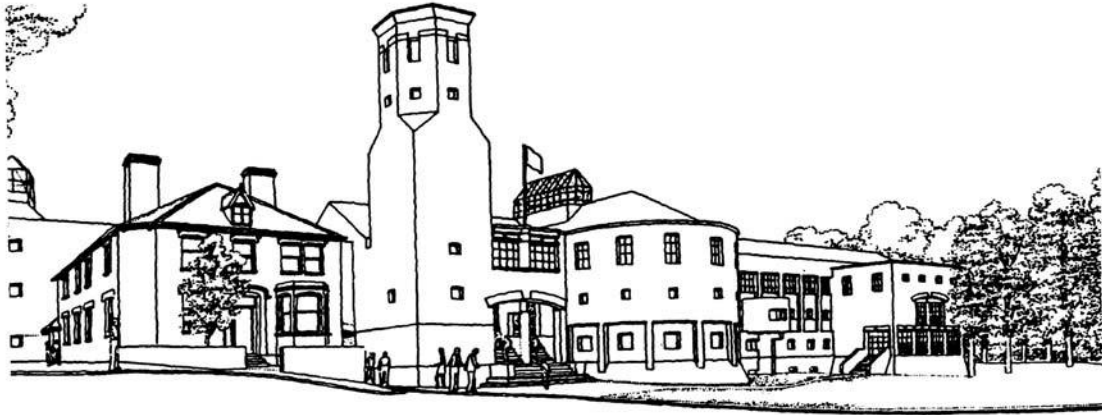

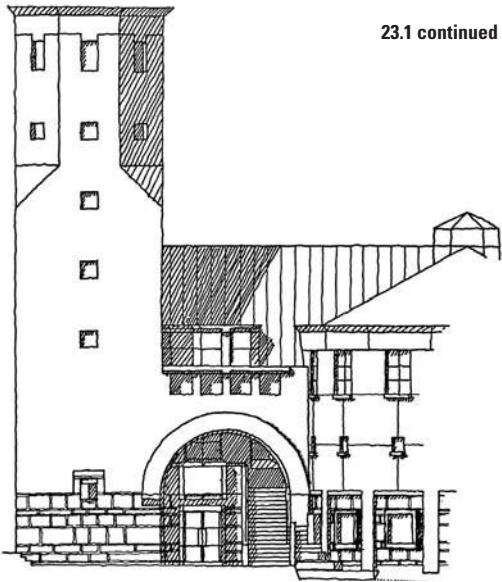

designer must consider both the buildings and the space they occupy. Similarly, sketches of Los Angeles show how central the road and parking lot are to modern civic design. If you were to sketch in parts of Paris or New York, you may also discover the urban significance of corner sites – not just as a place for architectural display, but as a location for prime real estate.

The process of drawing is, therefore, crucial to understanding the significance of architectural ‘events’ in the urban scene. Gateways may be special buildings but their real value to you as a designer is to help you establish the relative importance of such structures within the hierarchy of the city. Designers have responsibilities towards the town as well as their clients: addressing questions of legibility, order, hierarchy and continuity are part of the architect’s and urban designer’s wider duties.

By sketching you will begin to understand the visual structure of an area, and the various details that collectively make up cityscape or landscape. Places are assemblies of parts held together by an organising

principle. The latter may be simple, such as an urban grid of streets or a network of docks, or complex, such as an inner-city neighbourhood made up of fragmented parts. Landscapes, although superficially beautiful, are often composed of irregular or dislocated elements. It is analysis through the sketchbook, rather than through words, that can best unravel these complexities.

Designing from the basis of a sharpened visual perception is of obvious benefit to you, to your client and to the environment. If your task is relatively simple, such as designing a new house, then it is a straightforward undertaking to sketch the houses in the neighbourhood, recording their basic shapes and window, door, roof and wall details. The cataloguing of parts and general arrangements make a good starting point for the design of the new house. Your ambitions as a designer may go further than blindly repeating the pattern round about, but a clever architect will reinterpret the old forms, not invent completely new ones. Should you decide to place a glass box in a district of Arts and Crafts houses, then it is hardly surprising that the planning authority will take a dislike to your design.

The form and details of what you have drawn are important, but so is their significance. A particular assembly of glass and steel on an office block may prove useful in the design of objects unrelated to architecture, such as in furniture or product design. The way the juxtaposition of materials is handled can, therefore, have a universal application. Similarly, an aircraft wing may provide clues as to how a building could be put together – the moving parts giving hints, for instance, as to how flexible solar screening could operate. When drawing, one should be asking questions about the subject, discovering the essence rather than merely recording the surface forms. It is often the underlying principles, more than the details, that prove a source of inspiration in design.

It is obvious that the way we draw influences how we



23.2 a, b and c

This sequence of a photograph and sketches showing urban changes demonstrate how flexible the graphic medium is. In this case Hawksmoor's church at St Anne's Limehouse in London Docklands is opened to view by removing the clutter of recent buildings in Commercial Road.



think about places and buildings, and hence plays a significant part in how we might approach design. The use of perspective drawing, axonometric, figure-ground or shadow-enhanced image shapes our perception of the subject. The current fashionable interest in figure-ground representation has discouraged the deconstructed distortions of many designers. Five hundred years ago the discovery of geometric perspective led to a similar interest in spatial patterns, vistas and terminations.

If drawing sharpens our visual awareness, the method of representation directly influences how we view the world. To move from sketchbook exploration to design requires the intermediary of a drawing. Many graphic techniques are available, from simple plan, section and elevation to more elaborate methods of three-dimensional representation. Whichever method is chosen, it is important to follow the established rules, rather than make up new conventions as you go along. Like writing or mathematics, the rules are well understood and relatively inviolable. The grammar of drawing, its syntax and composition are important matters, whether you are a graphic illustrator or a designer.

The shift in emphasis from sketchbook studies to questions of design requires an appreciation of some simple theories of architecture. Like all patterns formed by the interrelationship of objects and space, the architecture of buildings and cities can be understood from various perspectives. One can view the subject in terms of space, surface, structure or decoration. Architecture as space has long captivated designers who have contrived to carve complex spatial effects out of the solid mass of buildings or even whole cities. Baroque churches and many modern office buildings enhanced with atria manipulate architectural space to dramatic effect. Even in relatively small rooms space can be moulded and modified to excite the senses.

Architecture as plane or surface is the converse of architecture as space, though obviously both cannot be considered in isolation. Here the interest is in design of the surfaces that define the spaces, both inside and out. As the surfaces are what we see, they have long fascinated the topographical artist, for it is they that provide clues to the function and significance of a building. Focusing on the surfaces allows the designer to exploit modelling, hierarchy of form, colour and texture in order to transmit to the observer the 'meaning' of a building.

Architecture as structure is another readily understood classification. It derives great legitimacy from modernist functional theory, which requires the honest expression of the means of supporting a building. To take an example from history, Gothic cathedrals were as concerned with structural expression as with the moulding of space. The visible display of a building's structure can greatly influence one's perception of both its interior and exterior.

Architecture as decoration concerns itself with applied embellishment. The task of the designer is to provide enough decoration to allow people to understand and enjoy the building. Decorative detail can relate the building to its surroundings or function by adopting a familiar code of expression, or allow advertising in some form or another. Decoration provides a cheap and ready means of instilling symbolism for commercial, civic or private reasons.

These four key interests should be integrated in a design. The integrity or appropriateness of a design – whether for a chair, building or city – should be generated by weighing the demands of functional arrangement against these principal means of expression. The designer has the task of striking the balance and relating it to other points mentioned earlier, such as the physical or historical context. Sometimes the clue to how the balance should be struck derives from precedent (churches are often



23.3 a, b and c

Another sequence of a photograph and sketches remodels Great Western Road in Glasgow by removing the traffic and planting trees. Notice how the first drawing begins to edit out the unnecessary information of the photograph.

concerned with space and symbolism, while office buildings focus upon structure and surface) or the dictates of context. Whether as a student of architecture, a professional involved in the construction industry, or as an interested lay person, a visual awareness sharpened by use of the sketchbook leads quite naturally to a sensitivity towards design.

Many designers employ the freehand drawing to help develop their ideas. A completed design proposal does not happen all at once; rather it grows from a series of early sketches and abstract probings. The sketch plan or section allows the architect to grasp the complexity of the subject and develop particular strands. The methods employed in reaching an understanding of an existing building or place are much the same as those used to develop a design proposal. Such drawings have the prime objective of explaining to the architect aspects of the design. A series of sketch drawings are normally prepared, each representing a layer of development or an aspect of the design. They can be used in three important ways:

- to relate new design proposals to the existing structure of site and buildings;
- to communicate the broad design strategy to others involved in the creative process;
- to analyse and explain aspects of the design to oneself.

Mention has already been made of how Charles Rennie Mackintosh and Richard Reid use the freehand drawing as part of the creative act. For many architects and engineers the sketch is an essential starting point for any design proposal. The investigation of options and the development of particular avenues of thought are best achieved through the medium of the freehand sketch.

23.4 a, b and c

A more ambitious change is described by way of sketches at the Gorbals in Glasgow. Here Alexander Thomson's church is freed of the visual competition of tower blocks and given a square at the front.

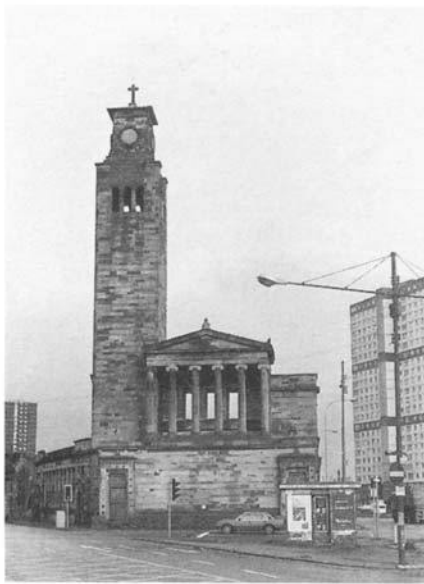

There comes a time when a more critical and analytical approach is needed, and here formal perspective drawings or computer simulation can be useful. But at the conceptual stage, when designs are still fluid and where a number of options need to be explored quickly, the sketch can be invaluable. At this point the designer will be relating the plan and form of the proposed building to such matters as function; considering how to link patterns of circulation to the section; and having initial thoughts

about structure and servicing. Depending upon the project in hand, the designer will probably be grappling with questions of site layout, landscaping and shelter. These and many other issues lend themselves to the freehand sketch, not as a means of recording a final decision, but as a method of weighing up options from the point of view of design and the organisation of form and space.

23.5

These analytical drawings show the development of a design idea by Arup Associates. The sketch becomes the vehicle for testing concepts and reconciling the interests of architecture, engineering and sustainability.

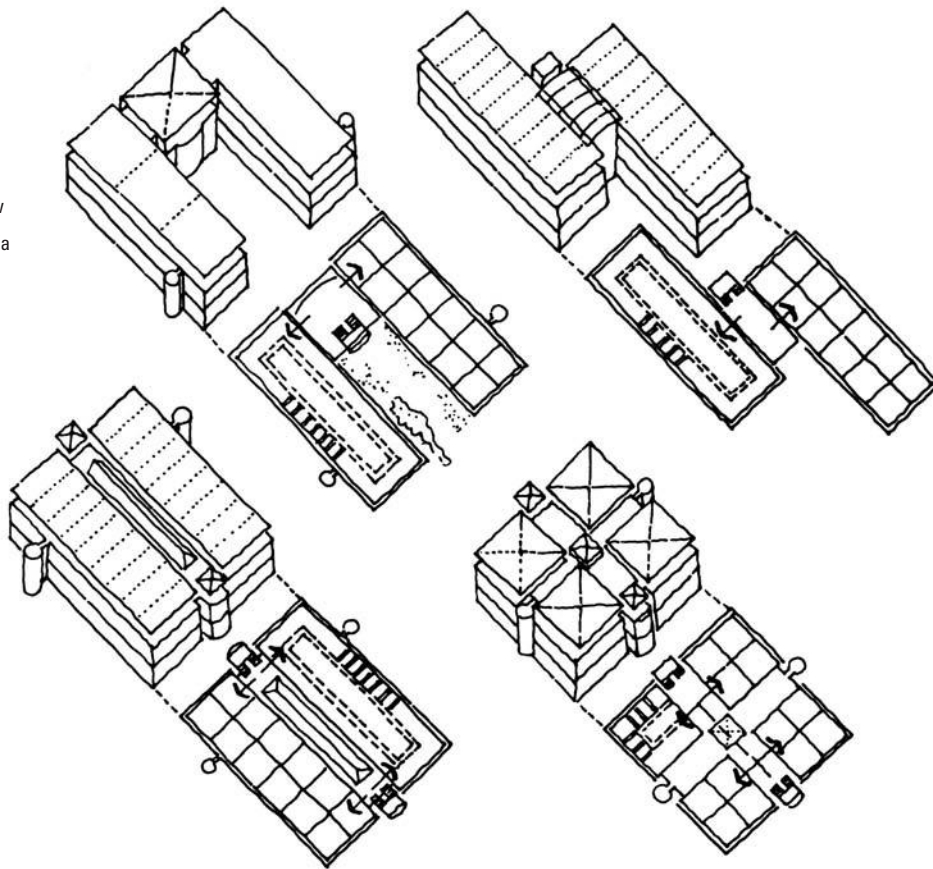

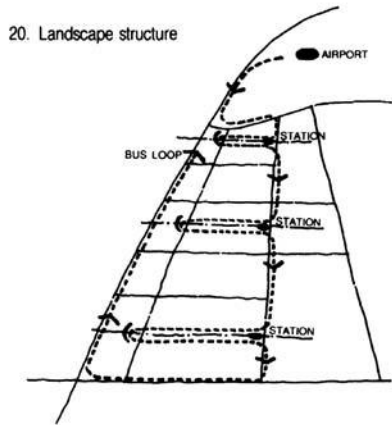
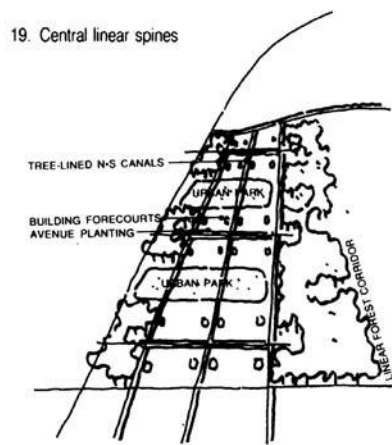
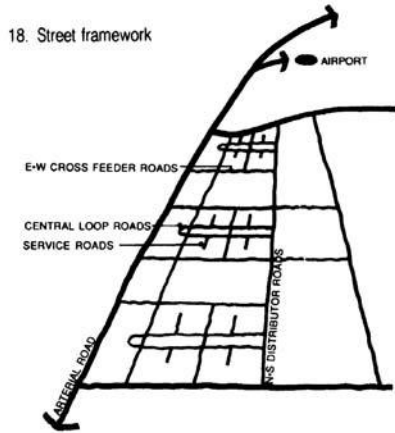

23.6 a, b and c
 In these sketches (of 1992) Arup Associates seek to establish the development framework for a business park. The sketches try to integrate the needs of urban, landscape and engineering design.

For the artist to become comfortable with using drawing as a creative tool, the sketchbook must be employed as a means of recording and analysing existing buildings. The sense of a 'sketchbook culture' needs to underpin the creative design process.

Arup Associates, whose designs have received many recent awards, operate in much this fashion. Here design proposals are explored around the central focus of the sketch. The concept for the whole building, and its various parts, is explained to mixed teams of architects and engineers using the sketch of a plan, section or

detail as the starting point for debate. The lack of distinction in Arup Associates office between architects and engineers has resulted in a climate where most designers, irrespective of their backgrounds, have become skilful communicators through the medium of the freehand sketch.

23.7

This sketch by Ted Cullinan is based upon a masterclass in urban design held in Glasgow in 1992. Cullinan's 'dot' drawing proposes a new gateway building near Cathedral Square.



23.8

The same masterclass (see Figure 23.7) led to the development of this proposal for decking over the M8 motorway near Glasgow's Mitchell Library. The drawing by architect Terry Pawson uses free graphics to capture the spirit rather than details of the proposal..

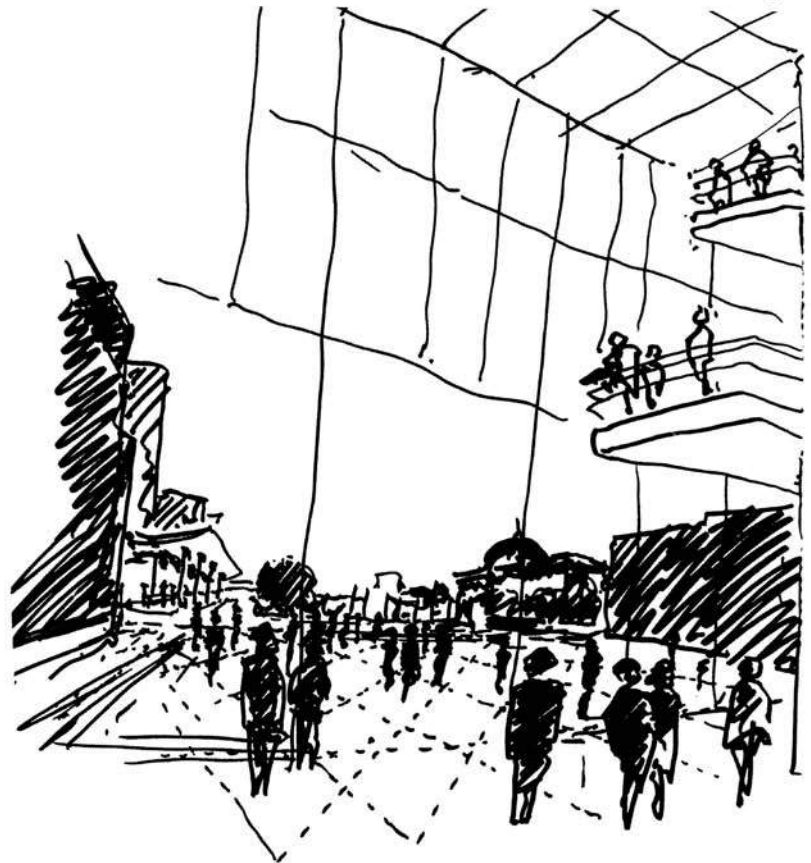

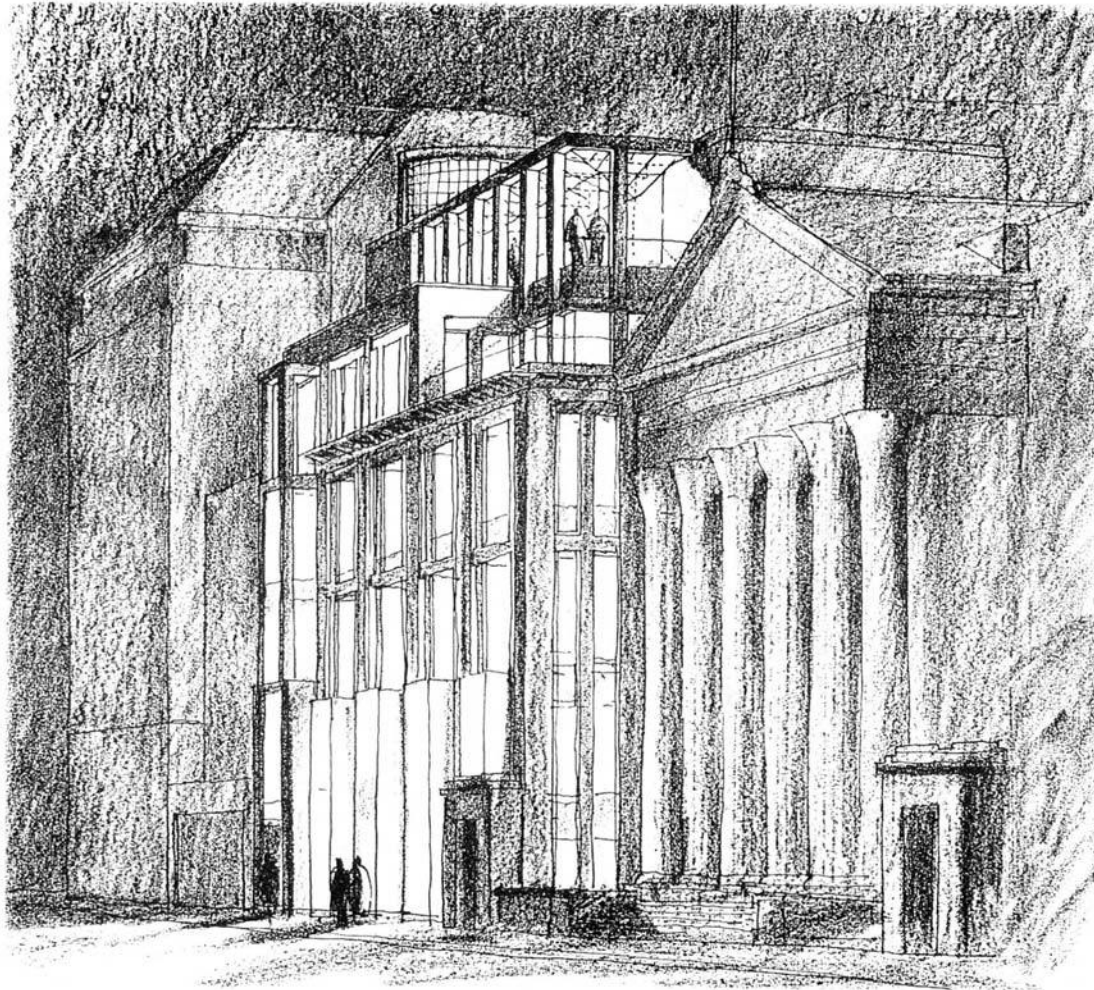

23.9 (opposite)

More matured proposals by architects Reiach and Hall are detailed in this drawing of 1992 in which the design for an office development accords well with the surrounding buildings in Edinburgh's George Street.

23.10 (right)

Richard Reid's sketch of his housing proposal for Finland Quay in London Docklands uses boats and people to give scale and interest to the public spaces.

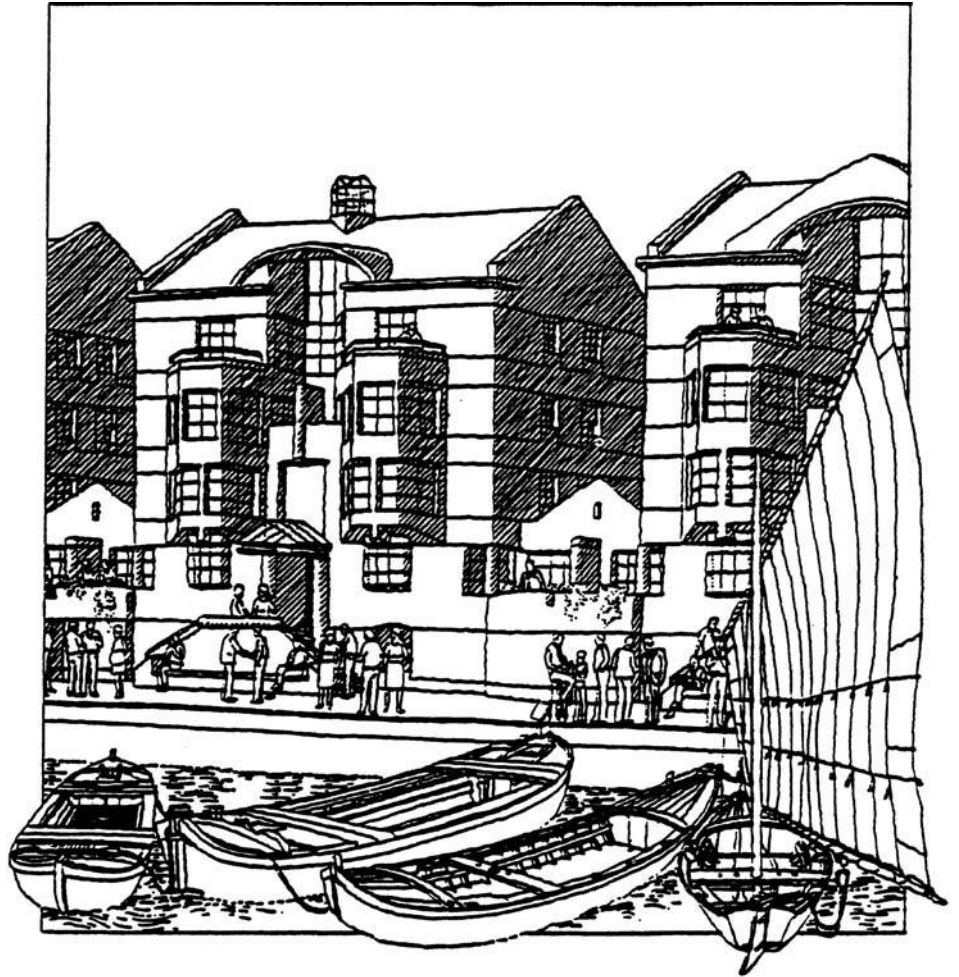

Chapter 24

Designing through drawing

The idea as formed in the mind was imperfect and could only be given its consequent form through examination, exercise of judgement, and modification of the idea through drawing.

Leon Battista Alberti (1452), Ten Books on Architecture

The traditional view is that the objective of design is the creation of form and the task of drawing is to give that form some shape or expression (Alexander 1964 p15). Hence, in modernist practice form is grounded in function and meaning – the argument being that the legitimacy of built form is based upon programmatic clarity (Alexander 1964 p15). As a consequence the designer must define the problem in order to determine its functional characteristics using the drawing process to test a variety of form responses. According to this mechanistic perspective the drawing helps achieve fitness between the brief, context and other technical and physical determinants. Being forward-looking ‘design’ is concerned primarily with the meaningful ordering of things in the environment using sketching, mechanical drawing, models and CAD to map the mental diagram into a physical reality (Lawson 1990 p173). The key question in this chapter concerns the role of freehand drawing and particularly how it interfaces with other media (model and

CAD) in the process of achieving excellence in architecture. Can the drawing perform the dual task of providing authority in a constructive as well as an artistic sense? Put another way, are freehand drawing and concept sketching the means to establish the marriage of art and technology necessary in the twenty-first century?

Since built form is the solution to the design problem brought about through the action of drawing, and given expression by the product of drawing, how drawing is used deserves close attention (Lawson 1994 pp141–2). The architectural diagram and sketch drawing mediates in the process of solving a design problem but it is not the only tool employed (Robbins 1997). Just as how the problem is defined influences the solution, so too the tools used to solve the design problem have bearing on how the problem is understood and ultimately solved. The graphic analysis and spatial diagrams that architects produce can be studied to see how the best fit solution is achieved. In this regard the drawing is both a record of the stage reached and, being a tool that is abstract and intellectual in nature, it also opens up the inner processes of design development to external examination. However, the assumption that there exists a structural correspondence between the pattern of a problem and the drawing of a physical form that solves that problem

raises two important concerns. First, can the three-dimensional nature of a building be adequately represented on a flat sheet of paper – can space be truly understood and designed by such means? If it cannot, what is the relationship at different points in the design process between the three tools commonly used for form analysis and development – namely, drawing, models and CAD – in representing an imagined reality? How is three-dimensional space to be designed, understood and communicated two-dimensionally, and since architectural space is not static but fluid, how is movement accommodated in the graphic analysis?

The second problem concerns the private nature of the design drawing. In a task that involves many, namely the design of a building, can drawings truly be a vehicle for shared problem solving and, more importantly, shared form evolution? The team drawing is relatively rare and not much of a feature of contemporary architectural practice, even in offices where multi-disciplinary skills exist. Advocates of CAD argue that the screen provides

for more effective design collaboration and contains in this the seeds of a more democratic process of architectural production.

In spite of these difficulties many architects acknowledge the primary importance of the act of drawing to solving design problems and in understanding design precedent (Lawson, 1994 p141). In fact, some architects claim that the actual holding of a pencil encourages creative thinking, the pencil or pen being the go-between that links the mind and hand. The drawing allows thoughts to flow and, when combined with words, creates a framework whereby design problems are turned into embryonic solutions. This is commonly called the 'Diagram' (*Architectural Review* 2006a p28). The mind, eye, hand, pencil and drawing exist as a seamless interface in the experience of accomplished architects; in fact, it has been argued that thinking through drawing is what distinguishes the architect from others in the building design process (Eastman 1970; Schon 1983; Curtis 1999). Architects draw in a way unique to their

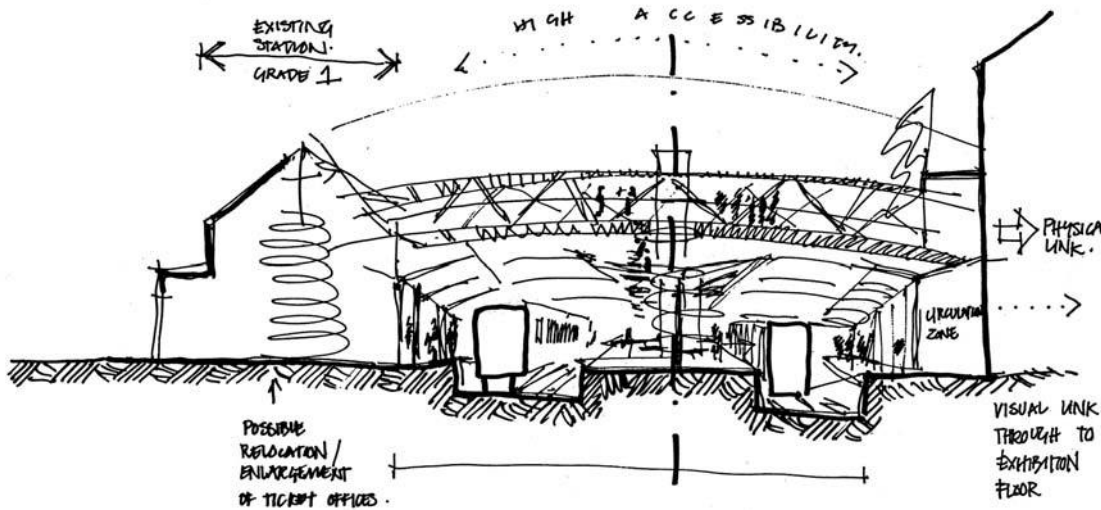

24.1

For the architect the freehand drawing mediates between the conflicting demands of brief, site and construction. Here words are used to augment the ideas expressed in line.

(Source unknown)

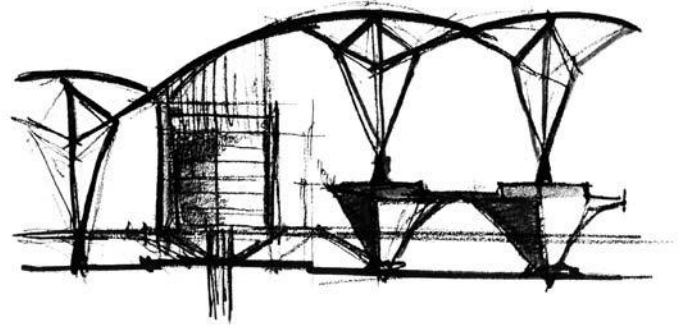
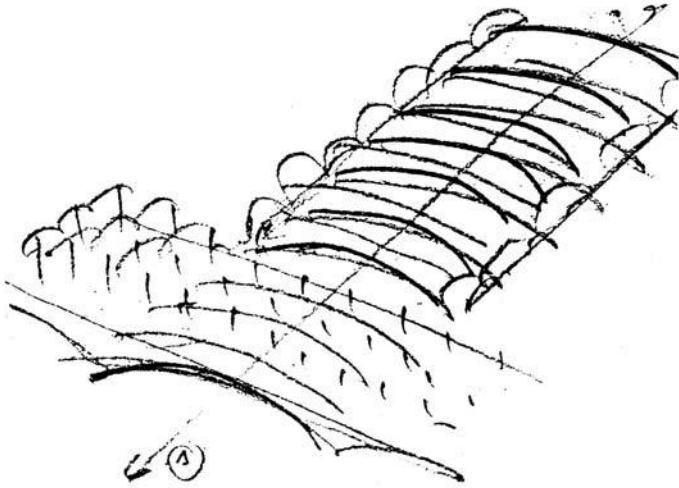

24.2 a, b and c

These drawings by Santiago Calatrava are little more than a structural diagram for the Lisbon Orient Station yet they are rich in architectural and spatial potential.

(Santiago Calatrava)

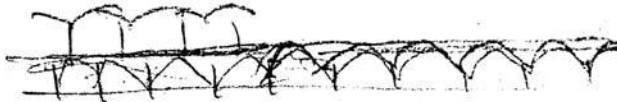

profession, and although engineers and industrial designers also draw to solve problems their graphic techniques are quite distinct.

The question addressed in these final chapters is whether drawing still retains this central position in the face of considerable development of other investigative design tools such as CAD. Specifically, how do ideas, drawings, models and CAD interact at the early stages of design evolution, and, more fundamentally, can the architect design without the aid of freehand drawing? All designers, and here architects are no exception, interpret and solve problems by graphic mediation. One can design without drawing but, as the research described here relates, it is difficult for architects to communicate an imagined design without the use of drawing. Equally, it is

difficult to undertake the development of a design idea, particularly at its early stages, without recourse to freehand drawing (Lawson 1994 p142; Bowers 1999 p13). Although the CAD-based design drawing has an increasing role in the genesis of an architectural concept, traditional drawing is still required to resolve problems as they arrive. Hence, this chapter argues that there is a dynamic relationship between sketching and other investigative modes such as models and CAD right through the design process. In the hands of more adventurous architects the line in plan becomes the line in section, and this in turn becomes the line that is traced through the model. However, as the design idea matures beyond the diagram and early concept sketches, there is an increasing reliance upon CAD and more formal model-

24.3

This sketch by the engineer Ove Arup of the structural arrangement at the nave of Coventry Cathedral designed by Basil Spence displays the difference in how engineers and architects draw. (Ove Arup/ Bruce Yoell)

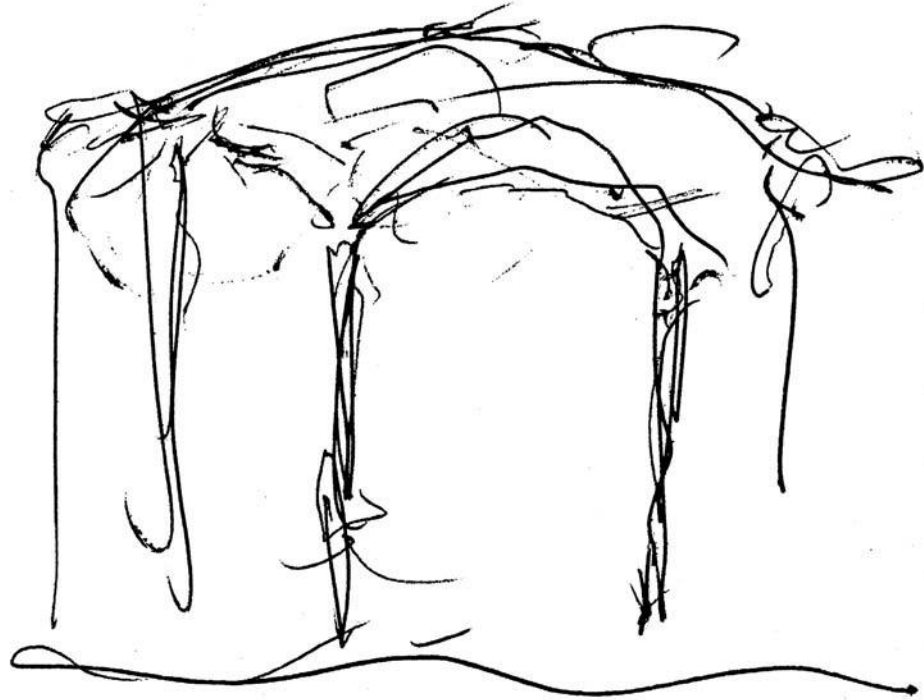

making. But when later changes are required, the freehand sketch retains its prime position as the first tool employed in testing options.

The argument outlined in this chapter is in contrast to the more theoretical perspectives on the nature of the architectural drawing that have been the primary concern of scholars over the past decade. The drawing has tended to become an object of interest in its own right rather than a vehicle to develop ideas and engage in design dialogue. Few have sought to investigate the changing role of drawing as a design tool under the impact of ever more sophisticated computer-aided design software and modern methods of model-making such as CAD/CAM. What these final two chapters seek is an understanding of how an architectural idea is born, and how it is

represented, tested and articulated through drawing, either manually or digitally generated.

PERSPECTIVES ON ARCHITECTURAL DRAWING

The literature on drawing highlights a number of important characteristics of the architectural drawing. Whereas Paul Klee describes drawing as 'taking a line for a walk', the architectural drawing has an important role to play in the conceptualising process we call design (Stern 1977 p382). In architecture, the line is taken for a walk with purpose – i.e. design. The renewal of interest today in drawing is part of a more general discourse surrounding visual culture embracing themes such as 'ways of seeing' and 'ways of imagining' (Bowers 1999 pp13–15). Although it is recognised that there is a link between

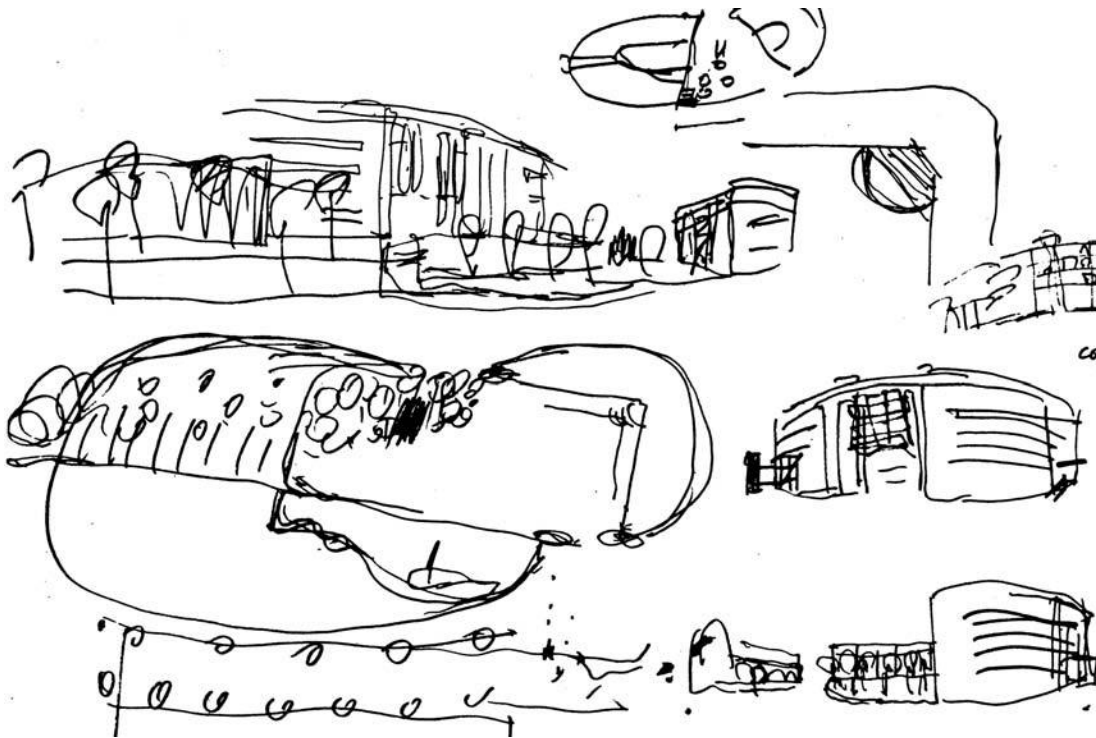

24.4

Sir Terry Farrell's sketch design for an Arts Centre in Newcastle combines different drawing types on one sheet. (Sir Terry Farrell)

techniques of drawing and the perceptual experience of space, the tools employed by architects to represent reality (drawings, models, CAD) have not received the attention they deserve in shaping some imagined future. Architects are generally innocent actors in these wider debates yet, as the Critical Architecture conference at University College London in 2004 noted, 'the drawing of lines and the drawing forth of ideas' is what designers do as matter of course even if the deeper significance is rarely addressed (Critical Architecture 2004). Not only do architects draw forth creative ideas habitually, they use drawing to gain a better understanding of the context to the problem in hand, whether this be the physical sight or precedent studies.

Although there is a large body of understanding surrounding the interface between the initial functional diagram, drawing, briefs and site characteristics (Lawson 1990 and 1994; Dunster 2006), the more critical role of drawing in evolving new technological solutions or fresh constructs of space is less understood. Admittedly there is an increasing interest in the use of drawing to represent different philosophical approaches to design, though until recently these have rarely developed into buildings of a concrete nature. However, Zaha Hadid, Frank Gehry and Will Alsop have begun to open up a debate between the mode of drawing and its design consequences. Rather than separate the media of painting, drawing, models and CAD onto different drawings, these architects have

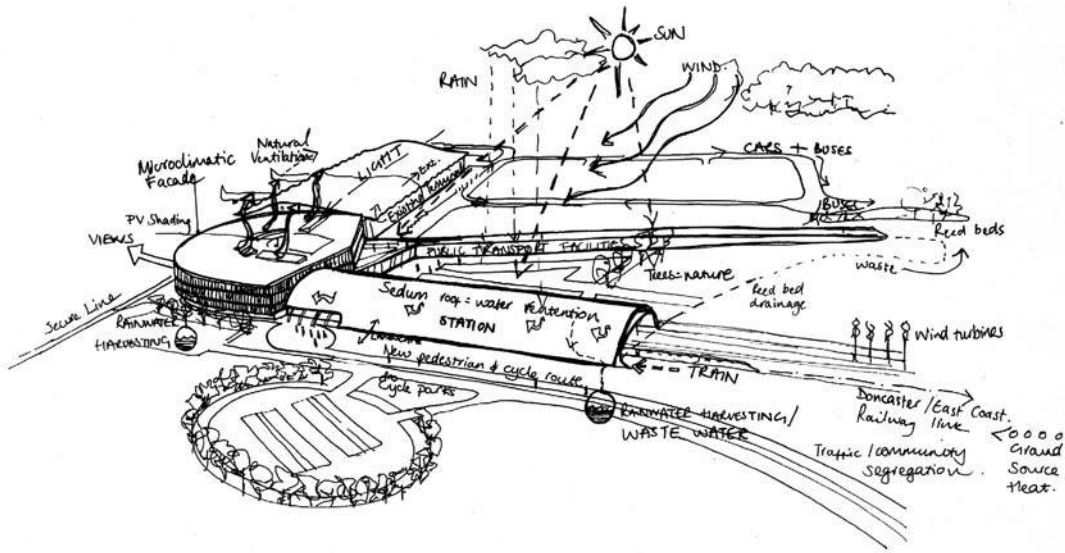

24.5 (left)

This sketch by Gemma Hickling, a final year student at Sheffield Hallam University, shows how a single drawing can effectively explain complex environmental aspects of a design project. (Gemma Hickling)

24.6 (below)

This sketch of Alexandria Public Library in Egypt, designed by Snohetta, helped the author understand the logic of the roof construction. The process of drawing provided the means to better appreciate the ideas behind the design.

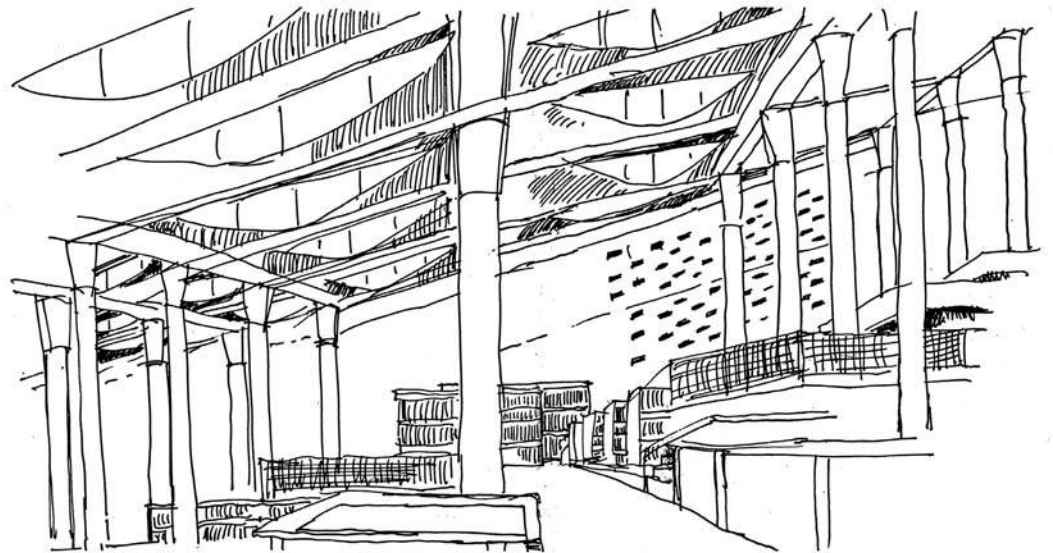

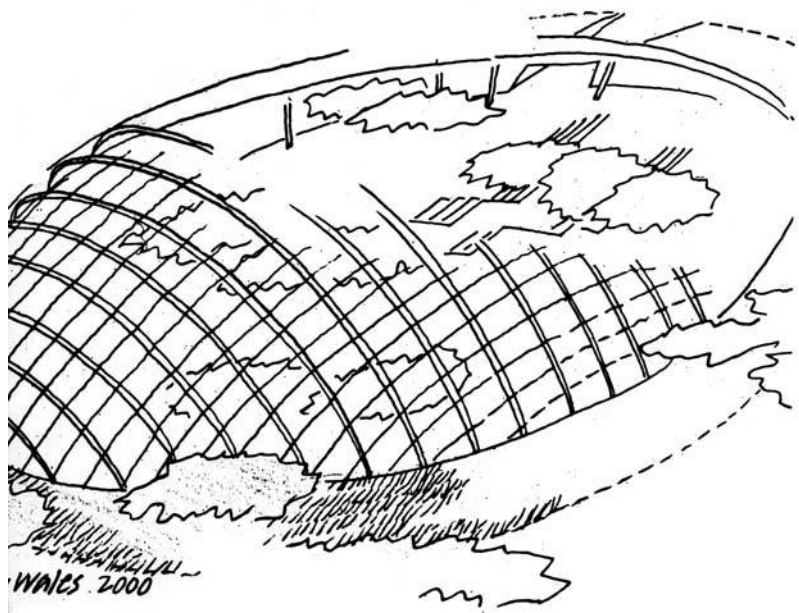
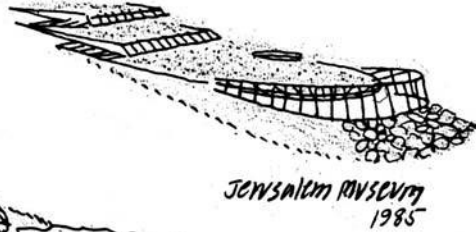

24.7

This sheet of sketches by Lord Foster of Riverside displays an almost Darwinian interest in the evolution of design ideas. The ordering of types into chronological sequences shows how freehand drawing can be employed in an intellectual fashion. (Lord Foster of Riverside)

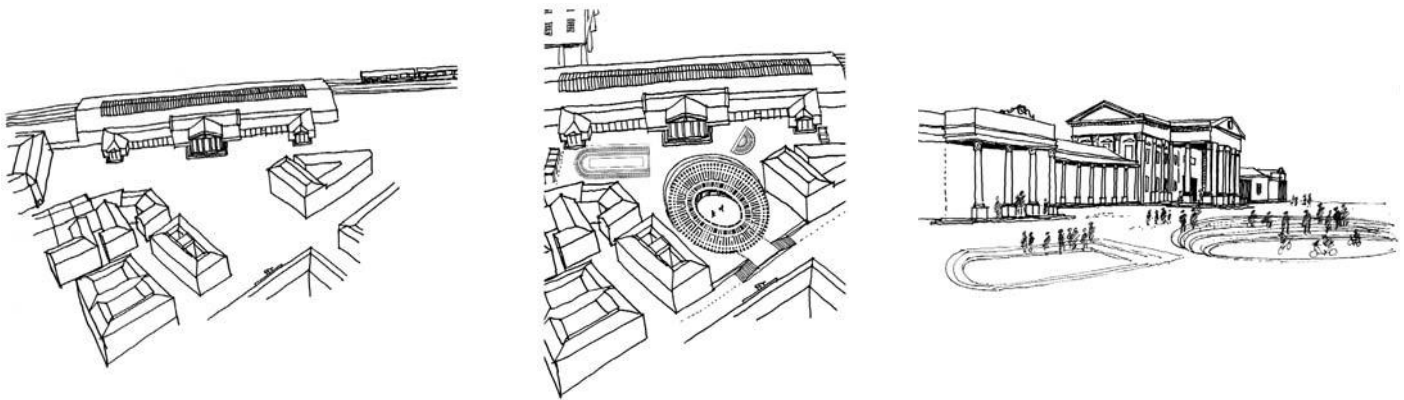

24.8a, b and c

These sketches of the square in front of Huddersfield Station test an idea for remodelling the space.

begun to combine them onto a single sheet, producing drawings almost without precedent. As a result, architecture has been liberated from the straightjacket of orthogonal thought process of plan, section and elevation.

Part of the problem has been the relegation of drawing under the influence of post modernism to that of 'rendering' and under modernism to the 'diagram'. These renderings were views of designed buildings in their still-unrealised but complete state (the perspectives of Leon Krier or Aldo Rossi are good examples). On the other hand, at the Bauhaus students were not encouraged to explore through drawing but rather to use paintings and cardboard models to investigate the properties of form and colour (Periton 1996 pp189–205). Writing in 1943 Kenneth Clark observed the decline of architectural

drawing, which he attributed to the influence of modernism with its concerns for abstraction and the functional diagram (Architectural Review 1943 p148). A similar point has been made by Curtis in the context of Le Corbusier (Curtis 1999) and Arnell and Bickford with regard to Gehry (Arnell and Bickford 1985). Gehry has a particular interest here because of his acknowledged debt to Mondrian and the way his particular art-design graphic processes are translated into digital media in order to positively influence any subsequent architectural drawings.

The recent rebirth of interest in drawing is largely a manifestation of the engagement by academics in emerging cultural and social theories of design. Here the author is not concerned with new modes of architectural

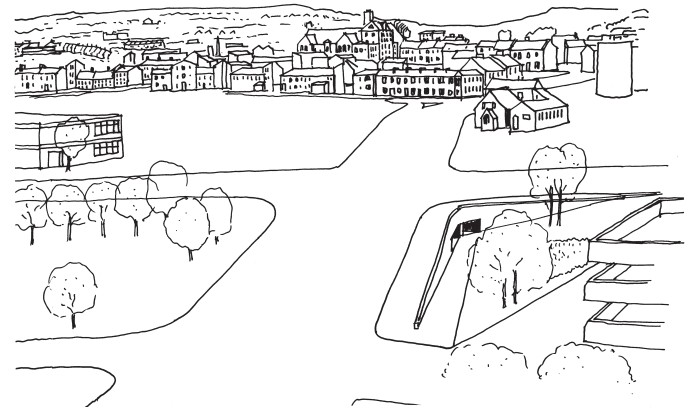
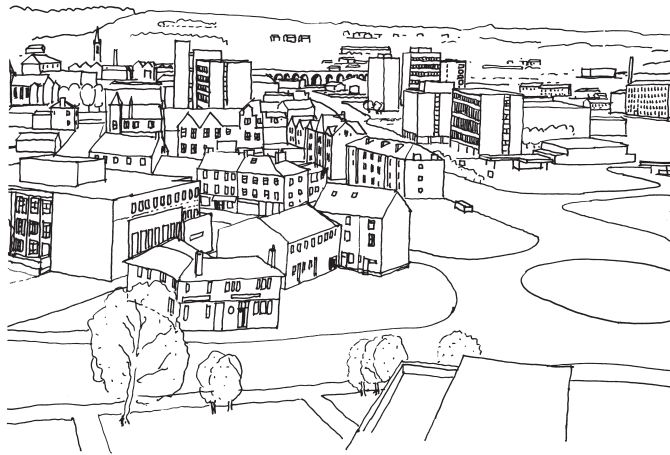

representation or with the beautiful drawing whose roots extend back to the Ecole des Beaux Arts and the Royal Academy but with the use of drawing as a creative design tool. After all, most architectural schools in the UK still retain a curriculum based, at least in the early years, around the discipline of drawing. In fact, skill in drawing is a key element of the RIBA validation process and is strongly linked in terms of ARB prescription to that of competency in design. The key word used is that of 'communication' – the ability to represent ideas graphically to oneself and others. All the architects interviewed in the next chapter afforded supremacy to the drawing as the main design generator and as a skill they expect in young graduates.

Five types of architectural drawing can be identified – the initial diagram, the sketch design, technical and preparatory details, site and other context studies, and the definitive drawing. The first consists of mere lines and fragmentary sketches often more akin to a notebook, the second is concerned with the initial physical form often with variations explored, the third is analytical and technical, the fourth consists of records and analysis of the site or questions posed by the brief, the fifth is a representation of the architectural concept itself using conventions such as plans, sections and perspective views. The latter allows the question posed by the brief to be tested against visual and practical criteria. These tools allowed Michael Graves to posit the view that 'without

24.9a, b and c

Drawing allows the urban scene to be documented in a way that allows design interventions to be tested. These sketches are deliberately skeletal to help identify development sites for student projects.

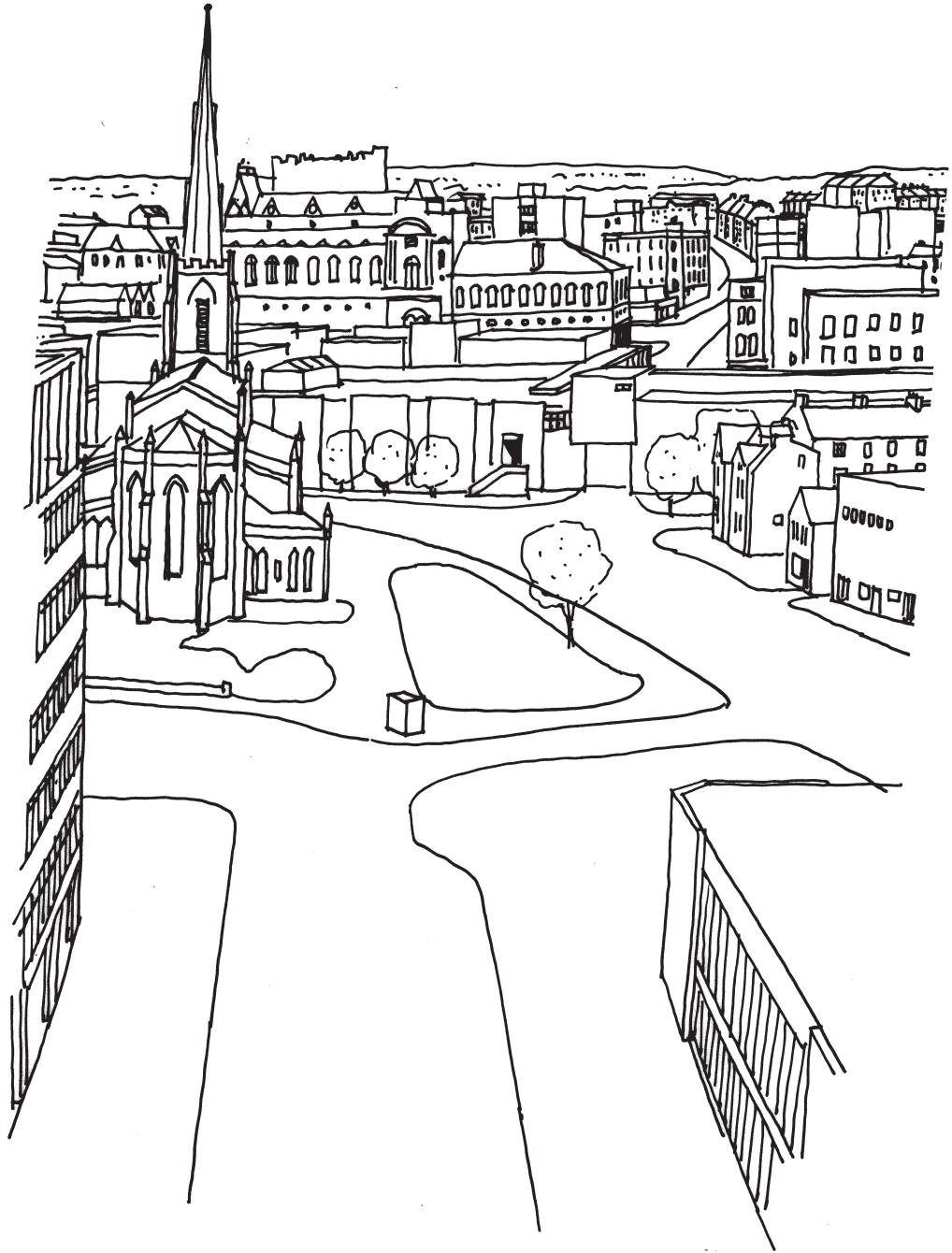

the discipline of drawing it would be difficult to employ in the architecture the imagined life implicit in the brief'. This is an argument also explored by Robin Evans, who posits the opinion that the key power of drawing in architecture is to act as a bridge between the imagined and real worlds (Evans 1997 pp153–94). Similarly, according to the architect Richard MacCormac, different frames of mind require different instruments for producing and representing what you are doing as a designer (Lawson 1994 p142). What this suggests is not only that different types of drawing allow design problems to be solved from different perspectives, but more importantly, the choice of drawing type (or painting in Gehry, Hadid and Alsop's case) help mediate across the various cognitive phases of design production. Put simply, the 'drawing is the frame of mind'.

The limitations of drawing have, however, been highlighted, amongst others by Henri Lefebvre who claims that drawing restricts architectural speculation (Hill 2003 p173). Lefebvre is particularly critical of plans and elevations which in their geometric bias objectify drawings to the point where communication is lost with users and often other designers (Lefebvre 1991 p361). Hill further argues that conventional architectural drawing limits rather than expands design speculation through its mechanistic origins. A slightly different criticism of architectural drawing is made by Bob Sheils, who claims that since the drawing has to visualise both the real and virtual worlds at the same time, it is not capable of testing the information without translation into physical form (Sheils 2003 p204). The answer, he suggests, is to rely more upon CAD/CAM as a means of operating in multiple modes at the design stage rather than rely upon the architectural sketch.

Four main criticisms of drawing are often cited: first, that the mechanistic tendencies in traditional architectural drawing limit creativity; second, that greater attention

should be paid to the modernist 'diagram' rather than the traditional sketch design; third, that to be most useful drawings need to interact with other modes of spatial exploration; fourth, that different frames of mind require different types of drawing at different points in the creative process, and this has the tendency to exclude non-designers in the process of architectural generation. These criticisms and speculations beg the question whether the type of drawing influences the content of architecture. Or put another way, in order to develop a new architecture we need to evolve, as Gehry and others suggest, a new language of drawing. At a more practical level most architects adjust the choice of drawing types in order to mediate across the various cognitive phases of design production.

Two opposing positions have been outlined so far. First, the more theoretical view that drawing is part of a wider discourse grounded in art practice and how architects use drawing should be seen in cultural rather than purely technical terms. Second, since drawing is the main begetter of built form, its central role should be as the practical generator of architectural form free of philosophical dogma. However, since architects employ drawing in a fashion distinct to their discipline (there are few parallels with engineering drawing) one should not perhaps expect non-architects to fully appreciate the significance in generative terms of the architectural drawing, especially the freehand sketch and associated design diagram.

Until recently, it was assumed that the processes of drawing inspired by contemporary art practice had limited relevance to the architectural profession. However, one can see in the drawings and paintings of Frank Gehry, Zaha Hadid and Will Alsop the emergence of a wider engagement with abstract spatial concerns that challenge the more functionalist view of drawing. Gehry's approach to drawing, for example the linear adaptations of the

Matisse collages that inspired the Bilbao Guggenheim, mirrors that of the sculptor Richard Serra who describes drawing as a 'verb' with the emphasis on process rather than product. Gehry's design drawings approach that 'perpetual state of becoming' identified by Laura Hopton (Hopton 2002 p11) and explored in the 'Drawing Now' exhibition at MoMA, New York in 2002. These emerging currents are beginning to influence mainstream architectural practice in the UK, judging by the designers' inner thoughts voiced in the interviews conducted (see next chapter) and the sketches produced. But if traditional

freehand drawing remains paramount at the start of projects, CAD offers the chance to realise forms that could previously only be imagined. In the digital age CAD appears to bridge the worlds, if not of theory and practice, at least of art and architecture.

24.10

This masterplan sketch by Malcolm Fraser shows the benefits of mixing line and text. (Malcolm Fraser)

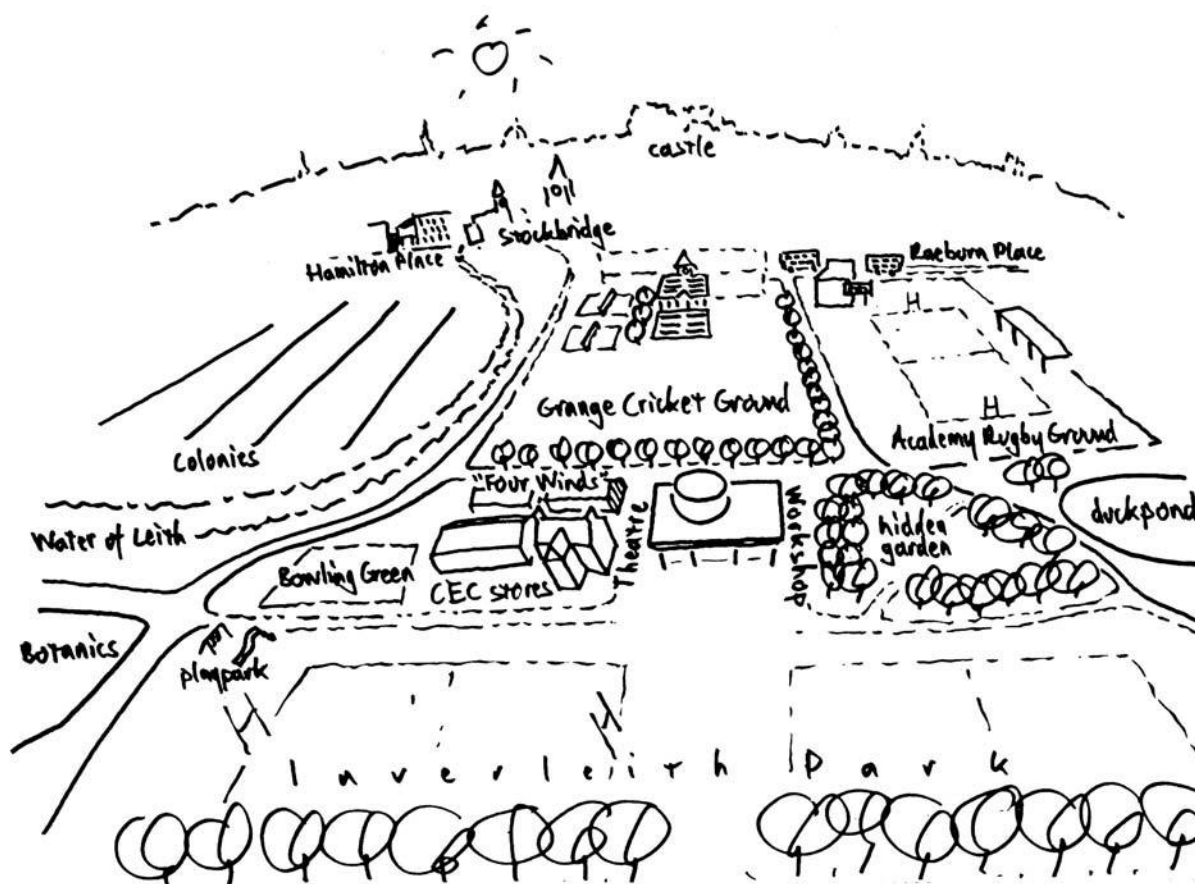

Chapter 25

Drawing in architectural practice

It is now necessary to explore how freehand drawing is employed today in design generation by a selection of leading architects in the UK. The emphasis is not upon drawings as end products but on the role of drawing in the process of designing buildings. The investigation is into the drawings that architects produce – their type at different points in the evolution of a design idea, the paper and graphic techniques employed, the interrelationships with thought processes and other tools such as models and CAD. The focus is upon the role of drawing in the context of the architects' office rather than in the rarefied arena of the public exhibition or gallery.

In this concluding chapter ten architects were selected for interview, six with London practices, three based in Edinburgh and one in Glasgow. Each architect interviewed was the principal of a large or medium sized practice and hence the person most likely to be the originator of the design concept as well as the person most likely to intervene at later stages. The architects chosen also represented a wide range of design approach, from those whose concerns were mainly in urbanism to architects whose work is seen as high tech, rationalist, art or socially motivated. In each case study, the architects were selected because of their reputation as 'designers', as evidenced by the architectural awards won. Each architect was of a

generation trained in the tradition of the freehand drawing but practising in an age where digital representation was the norm. The resulting tension between the screen and the sketchbook interested the author. The nine questions put to the architects can be divided into three types – those dealing with the relationship between drawing and thought processes, those dealing with drawing and problem solving, and those dealing with drawing techniques and communication.

The key drawing questions addressed

Drawing and abstract thought processes

- Can you think without drawing?
- Can you draw without designing?
- Can you design without drawing?

Drawing and practical problem solving

- What type of drawing do you begin with?
- How do drawing, model-making and CAD interrelate?
- How does sketching inform designing?

Drawing tools and techniques

- What do you draw with?
- What do you draw on?
- How does the drawing become shared?

The first set of questions tried to tease out the cerebral role of drawing not just in terms of organising and solving abstract problems but also in relaying something of the thought processes of the designer. In this there was an attempt to discover the architects' inner thoughts and how they interfaced with traditional and electronic graphic tools. The second group of questions aimed to discover the specific nature of drawing in the more practical arenas posed by design problems, the type of drawings used at different points in the design process (using the RIBA Plan of Work as a guide), and the interrelationship between drawing, CAD and model-making. The third group sought to investigate the tools and techniques employed, particularly how and when the drawing becomes a shared design tool. The questions posed dealt only with the early stages of a design project: the research had no interest in the perspective drawing prepared to simulate a final design nor with drawing as part of the 'information package' aimed at the construction process. As such the investigation examined drawing in the context of visual thinking and sought in particular to discover whether drawing remains a critical part of the architect's armoury of spatial and technical problem solving techniques.

THE FINDINGS: DRAWING AND ABSTRACT THOUGHT PROCESSES

Without exception all of the architects questioned acknowledge the symbiotic relationship between thinking, drawing and designing. However, not all thought that drawing was a prerequisite for design: many architects, including Cullinan, Grimshaw, Alsop and Foster, often arrived at an initial design idea in their head before they committed a line to paper. These early design ideas were generated spontaneously, perhaps whilst jogging in Foster's case, cutting logs in Cullinan's or painting in Alsop's. The subsequent drawings prepared,

often the merest diagram or sketch, gave physical form to cognitive processes already undertaken. As Cullinan puts it, 'drawing allows me to express what is already in my mind's eye'. Likewise, Grimshaw admits that he not only generally draws an idea already partially formed in his head but he uses drawings to clarify spatial structures lodged in the imagination. Similarly Alsop states that 'drawing tests an idea which is already in my head', but to make sure he is thinking conceptually (rather than just problem solving) he prefers not to draw too soon. This view is shared by Farrell, who states that design is a mental process that remains more fluid in your head, and although line is fluid it is not as fluid as the first design idea.

Many architects reported that at the conceptual stage drawings per se can be limiting and they prefer to represent their thoughts with diagrams. A useful distinction exists here between the sketch and the diagram: the latter is the germ of an idea drawn with the minimum of lines but containing the potential genetic code of a project. All ten architects interviewed are admittedly experienced designers but they share the facility to construct images in their mind, which they then commit to paper in sketch form. One could go further and suggest that they deliberately avoid drawing too soon in an attempt to keep the creative options open. In this they are like composers who hum out a tune before they commit notes to paper.

If a design idea pre-exists its representation in drawn form, all of the architects acknowledge the power of sketching to test and develop the initial design concept. Murphy thinks it 'absurd to think you can design without drawing' and Foster states that 'design is about ordering and this is expressed and explored through drawing'. To Foster a distinction can be made between thinking and designing, and although he engages in both as an architect, 'drawing is essential to the latter but not the

Responses to the research questions by architects interviewed

Architect	Does design exist in head before the first drawing?	Type of first drawings made	Drawing tool used	Paper used
Bob Allies	Yes	Site plan and building diagram combined	Two sizes of black felt-tip pen	Sketch pad and tracing roll
Will Alsop	Yes	Abstract drawing or painting followed by plan	Painting followed by soft pencil or charcoal	Large cartridge sheet
Ted Cullinan	Yes	Section, overhead axonometric	Black and coloured felt-tip pen	Tracing paper
Sir Terry Farrell	Yes	Section, plan view	Black felt-tip pen	Layout paper
Lord Foster	Yes	Urban plan, section	Pencil and black felt-tip pen	Cartridge pad
Malcolm Fraser	Yes	Plan and section diagram	Black felt-tip pen	Narrow white tracing roll
Sir Nicholas Grimshaw	Yes	Masterplan and detail	Blue broad gauge fountain pen	Sketch book
Richard Murphy	No	Plan and section	Black felt-tip pen	A3 tracing pad
Allan Murray	No	Site analysis and plan	Pencil	Narrow detail paper roll
Gordon Murray	Yes	Site analysis and design diagram	Varies	Narrow yellow tracing roll

Is site sketching undertaken as design generator?	Main design development tool at stage 1 (RIBA Plan of Work C)	Main design development tool at Stage 2 (RIBA Plan of Work D)	Main design development tool at stage 3 (RIBA Plan of Work E)
Sometimes	Diagram/drawing	Drawing and model	Model and CAD
No	Drawing	Drawing and model	CAD
Yes	Drawing	Drawing	Drawing
No	Diagram/drawing	Model and CAD	CAD
Yes	Sketch/drawing	Drawing model and CAD	Drawing, model and CAD
Yes	Diagram/drawing	Drawing	Drawing, model and CAD
Yes	Sketch/drawing	Model	Drawing and model
No	Sketch/drawing	Drawing	CAD
Yes	Drawing	Drawing and model	Drawing and CAD
Yes	Diagram/drawing	Sketch/drawing model and CAD	CAD

former'. A similar view is expressed by Allies, who says he cannot design without drawing, since 'drawing is how I understand the problem'. A distinction, therefore, can be made between those architects who see design in conceptual terms where drawing may become an impediment to deeper cognitive processes, and those who see design as a synthesis of complex factors whose resolution is undertaken partly or wholly through manual drawing. Some architects admit, however, that in the initial design sketches lines and words are often combined in order for there to be synthesis of spatial, functional and contextual concerns (Allan Murray, Alsop, Farrell). All of the architects questioned believed you could think without drawing (although two admitted its usefulness here too), suggesting that to the architect drawing and designing are more closely related than thinking and drawing. However, after the initial stage of tentative form generation expressed usually as a plan or less frequently as a section diagram, all admitted the usefulness of freehand drawing in the development of design ideas 'right through the design and construction process' as Allies put it. The latter is a useful point, for whilst the design is developed and tested using CAD, when changes occur during the evolutionary process, these are invariable undertaken through freehand sketching.

Farrell relayed the process of designing the Visitor Centre in Newcastle. The first idea was a sketch from above, which represented the formal elements in relationship to the city. This volume was then divided into functional and hierarchical elements using diagrammatic axonometrics drawn in felt-tip pen from above. Various forms of testing, some involving a rough model, were undertaken before the first section was drawn, and this in turn led to the exploration of structural possibilities drawn by hand. When these were resolved, the plan was addressed both internally and in relationship to the city. Once a working solution had been arrived at, the sketches

25.1 (opposite)

This collage of architectural sketches and diagrams represents well the early design thoughts for a number of projects. (Architectural Review)

at 1.500 were then translated into digital format and tested further. The CAD explorations involved views from various points, the addition of colour and texture, and then structural delineation. These were printed and overdrawn and led to a fresh round of freehand sketching and then further refinement on the screen. In time these sketches were digitised and allowed to interact with the CAD images, which in turn became the medium for the detailed involvement of engineers. Farrell's role in all this was that of a conductor, leading the team with sketches, diagrammatic lines and the occasional word.

Although most of the architects interviewed could and often did draw without designing, the majority still kept either a sketchbook or notebook. The practice of drawing a repertoire of forms and precedents to employ in new designs, what the architect Thomas Jackson in 1873 called 'the making of careful drawings of existing buildings to inspire the designer later in life' (Royal Academy of Arts, 2003), is still employed. For example, Foster keeps a sketchbook 'whose images influence my

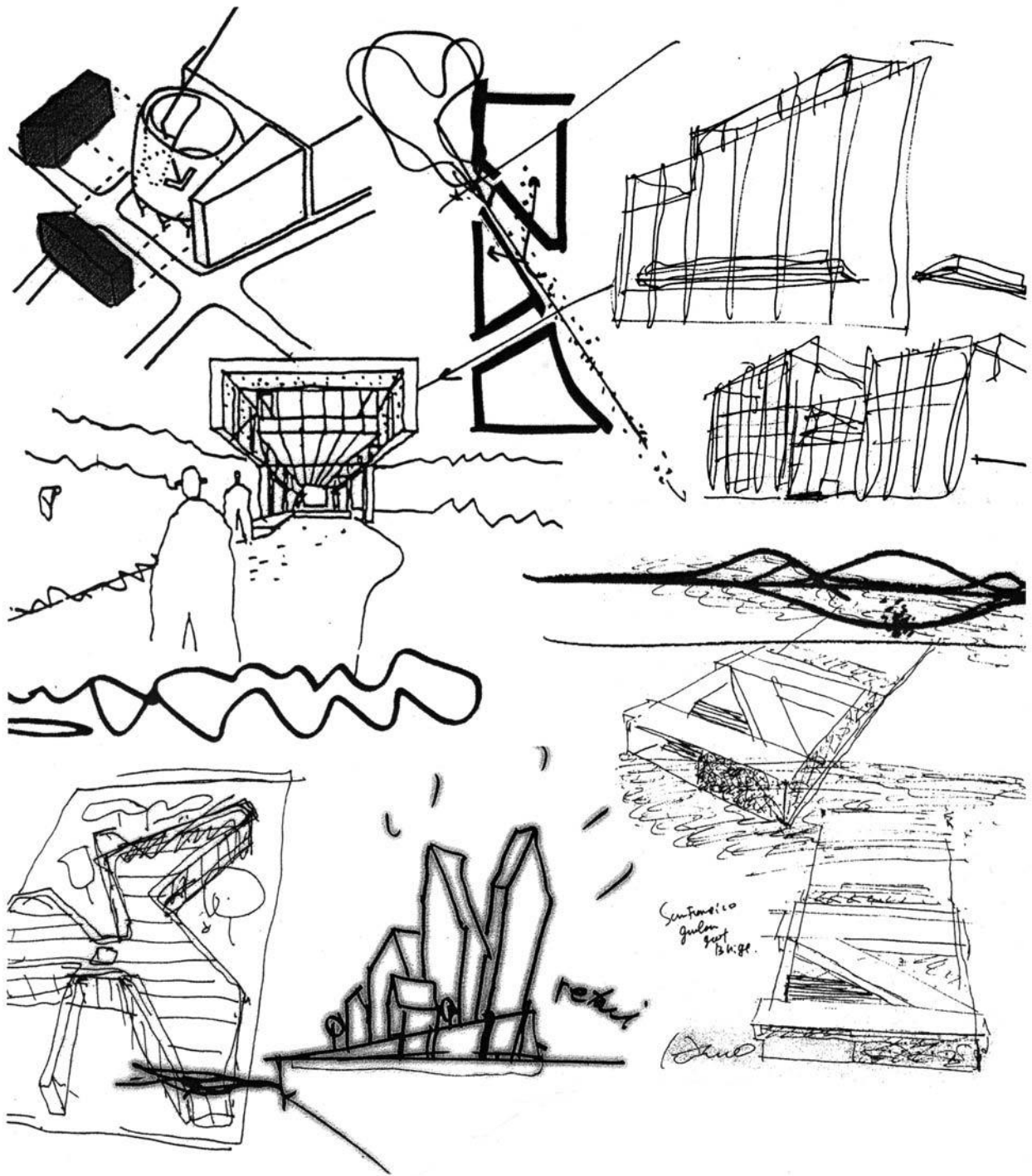

Relative importance of drawing, models and CAD at different stages of design evolution by architects interviewed

Architect	Design stage 1 (RIBA Plan of Work C)	Design stage 2 (RIBA Plan of Work D)	Design stage 3 (RIBA Plan of Work E)
Allies	Drawing 5 Model 3 CAD 1	Drawing 4 Model 4 CAD 1	Drawing 2 Model 4 CAD 4
Alsop	Drawing 5 Model 3 CAD 2	Drawing 4 Model 4 CAD 2	Drawing 3 Model 3 CAD 4
Cullinan	Drawing 5 Model 1 CAD 1	Drawing 5 Model 2 CAD 3	Drawing 5 Model 3 CAD 4
Farrell	Drawing 5 Model 3 CAD 1	Drawing 2 Model 4 CAD 4	Drawing 2 Model 3 CAD 5
Foster	Drawing 5 Model 3 CAD 3	Drawing 3 Model 3 CAD 3	Drawing 3 Model 3 CAD 3
Fraser	Drawing 5 Model 2 CAD 2	Drawing 4 Model 3 CAD 3	Drawing 3 Model 3 CAD 3
Grimshaw	Drawing 5 Model 4 CAD 1	Drawing 4 Model 5 CAD 1	Drawing 4 Model 4 CAD 3
Murphy	Drawing 5 Model 2 CAD 2	Drawing 5 Model 2 CAD 3	Drawing 3 Model 2 CAD 5
Murray, A.	Drawing 5 Model 3 CAD 1	Drawing 4 Model 4 CAD 2	Drawing 4 Model 2 CAD 4
Murray, G.	Drawing 5 Model 3 CAD 1	Drawing 4 Model 4 CAD 4	Drawing 3 Model 1 CAD 5

Scale 5: very important; 4: important; 3: less important; 2: occasionally used; 1: rarely used.

design work', arguing that sketching helps reinforce his visual memory, and Alsop does the same. Farrell thinks, too, that his earlier New York sketchbooks may have influenced his approach to design although today Farrell sees sketching as a 'way of seeing rather than a way of designing'. Six of the architects interviewed (Cullinan, Foster, Fraser, Grimshaw, Gordon Murray and Allan Murray) did, however, admit to using the sketchbook as a method of recording the site and analysing its visual characteristics – these early sketches then being used to test design proposals. The use of referential drawings where the design ideas interfaced with the site context proved useful to explaining design concepts to clients or community groups. Alsop took the opposite view, stating that he never draws the site, preferring to use digital cameras, which produce images that can be scanned and used to interact with emerging freehand designs. Farrell, too, prefers the camera to record the site, which he can then reproduce and draw over. In both cases (as explained in chapter 10, the photograph can be painted and sketched over, then scanned digitally, allowing the design to be tested against an accurate record of site characteristics.

THE FINDINGS: DRAWING AND SPATIAL INVESTIGATION

The type of freehand drawing first employed often depended upon the nature of the architectural problem posed. Seven of the architects talked about the primacy of the plan as the main generator of built form, often combining a sketch site plan with an embryonic diagram of building functions drawn to scale. Although the plan was the primary generator it was normally merely a diagram of circulation, functional disposition or urban relationship. However, the word 'diagram' should not belittle what is often a thinking drawing of importance to all later stages of design development. Order in plan and

its correspondence with site characteristics appears to be the main concern of most architects. However, in the case of Murphy and Fraser the first drawing was frequently a marriage of plan and section explored on a single sheet. For Cullinan, on the other hand, the first drawing was generally an overhead axonometric and for Farrell it was frequently a diagrammatic section. For Alsop the first drawing that followed the painting stage was often an abstract composition of lines and marks in soft pencil or charcoal that encouraged him 'to see something in interesting and unfamiliar ways'. Alsop also talks about 'mark making' rather than the use of conventional architectural drawing techniques but after this explorative stage the first drawing is a plan. Conversely, Grimshaw approaches the design problem from both ends (site plan and construction detail), allowing the marriage of technology and materials to influence his thinking right at the beginning of the design process.

All of the architects interviewed drew first and then somewhat later interacted with CAD and model-making. CAD remains, in spite of considerable software development, a mechanical drawing and testing tool rather than a design aid. Foster, like most architects, is interested at the start of a project in how things work rather than how they look and this he thinks is better explored through freehand drawing. Also since he spends some of his time re-shaping projects developed by others, the drawing allows for the ready identification of key design changes in a fashion which is interactive with members of the team. In Murphy's view the role of drawing is to 'test the mental diagram that solves the problem rather than represent the object'. Again the importance of the diagram is highlighted with the perception that CAD does not represent the thinking drawing well.

For all ten architects the traditional freehand drawing is the main development tool with models and then CAD

employed at later stages. Models, either plasticine or card, tend to be used to explain ideas to clients, and CAD becomes essential when engineers are involved. The sequence of diagram, then sketch design in plan and 3D, followed by more formal drawing and rough model, followed then by CAD is employed by seven out of the ten architects interviewed. The only significant variation concerns whether CAD emerges significantly in the second rather than third stage of design development. For Allies, CAD can deceive the designer and alter the quality of the built product. Alsop goes further, believing that CAD can 'produce a believable building too soon' and undermine creative exploration, which is the central responsibility of being an architect.

The increasing employment of complex forms in architecture means that CAD inevitably becomes a modelling tool in projects early on (Foster, Grimshaw). The respondents make a useful distinction between CAD as a design tool and CAD as a means of visualising complex ideas developed by other means. In Grimshaw's office, for example, rough models are made at an early stage (rather than use professional model-makers) because these can be integrated more readily with freehand drawing and through digital scanning with CAD. Grimshaw has reservations concerning the ability to develop sketch designs on the screen, believing that drawings and models used together are better ways of 'understanding the visual tensions and weight of architecture'. The point made by all ten architects is that CAD is used in their offices almost entirely as a drawing tool, and when it is used to develop spatial design ideas it tends to diminish the quality of the resulting architecture. A similar point was made over a decade ago (Lawson 1994 p14), suggesting that in spite of improvements in software technology mainstream architectural practice in the UK relies little upon CAD for initial design development. However, this is not to suggest that many

smaller and younger practices do not use CAD right at the inception of a design project or that CAD is not indispensable at later stages. In fact, much of the current renaissance in architecture is due to the amplifying potential of digital media at both a creative and technical level.

Many of the respondents made an interesting distinction between freehand drawing in design development and its parallel role in communication. Farrell talks about the drawing having three functions in architectural practice – problem solving, communication and persuasion. The problem solving role has already been discussed but because design by drawing is an iterative process, many people can become involved at different points in time using different levels of sketching skill. This helps the design idea (according to Allies, Alsop, Farrell and Grimshaw) to become owned by a wide range of stakeholders, including the client. Hence the process is one of a small initial doodle or diagram that grows to A4, then A3 and perhaps A1 format. In Alsop's case, where community involvement is encouraged it may entail large rolls of paper and coloured markers, perhaps augmented by video. Freehand drawing allows more authors to participate than had design development been undertaken solely on the screen.

Often early sketches prepared by senior partners are worked up by others at a later stage. What starts as a design diagram quickly becomes corporate and increasingly complex as more players become involved. In Grimshaw's office sketchbooks are provided to encourage visual thinking and Alsop provided staff with evening life classes. Foster believes the most effective drawings in terms of design generation are those often prepared spontaneously in the confines of a design team meeting. Here Foster alludes to the role of drawing in responding to the perspectives of others – their critical thinking acting as a catalyst for design insights. What

starts as a self-generated design idea quickly becomes shared as colleagues are drawn into the process. In this sense the freehand drawing aids the democratising of design. However, Cullinan notes that the lack of graphic skill by members of the team can be a serious impediment to the idea of an interactive drawing involving participation by non-professionals (e.g. users and clients). Murphy warns that the loss of ownership of a design drawing through its duplication via CAD can have an adverse impact upon subsequent architectural quality. A further point worth noting from the interviews is that the initial design drawing is nearly always individually

25.2

Will Alsop's painting was part of the process for the design of the Cardiff Bay Visitor Centre. (Will Alsop)

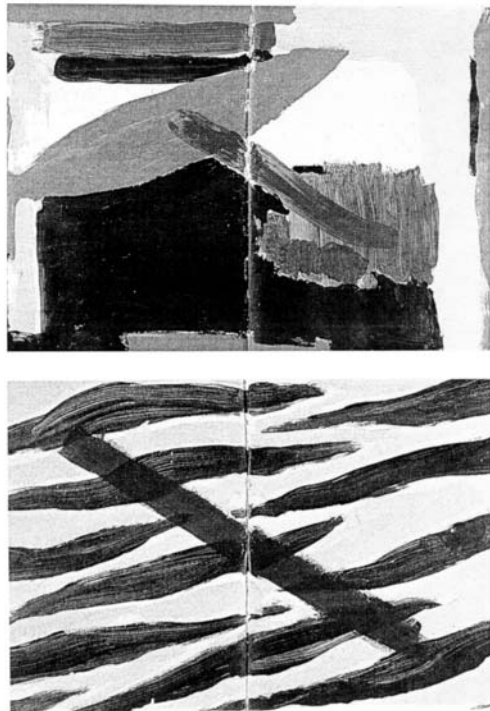

generated. Although many minds are drawn in later, at the very beginning projects were generated by a single mind often on a single sheet of paper. Here the sketch comes into its own as a begetter of future form rather than as a means of documenting what already exists.

THE FINDINGS: DRAWING TOOLS AND TECHNIQUES

The materials, tools and techniques of architectural drawing have not overly concerned academics. The questions addressed here seek to tease out the drawing tools employed in a practical sense for design exploration. The issue concerns the role of line, its weight and permanence, the type of paper and pen used, and the strategies for integrating sketching with other investigative tools.

Whilst all architects interviewed designed primarily by drawing, not all employed the pen. Foster, for instance, designs mainly in pencil (HB) because of its flexibility and textural potential. The dogmatic nature of black pen lines worries Foster and he feels they suggest a solution too soon. Allan Murray, who also designs in soft pencil (2B) on detail paper, enjoys the way pencil glides over paper giving the author the ability to alter the weight of line in a way that reflects the hierarchies implicit in architectural briefs. He also notes that pencil leads to drawings that, with their many revisions and erasings, provide a better narrative of the evolution of a design than the more bombastic pen drawing. To several of those interviewed line was the primary organisational device that allowed the problem to be defined and then solved. However, Alsop, who uses pencil (6–6B) and sometimes charcoal to describe lines that can then be filled in with colour (usually acrylic paint), refuses to solve the problem by line alone. He, like Gehry, does not see the drawing as 'finished product' but part of the process of creativity, which also includes CAD, models, painting and collaboration with fine artists and sculptors. On the other hand, felt-tip pen is

25.3

Lord Foster's sketch of the context for the new BBC headquarters in London. Notice the mixing of lines and words, and the skillful shade rendering. (Lord Foster of Riverside)

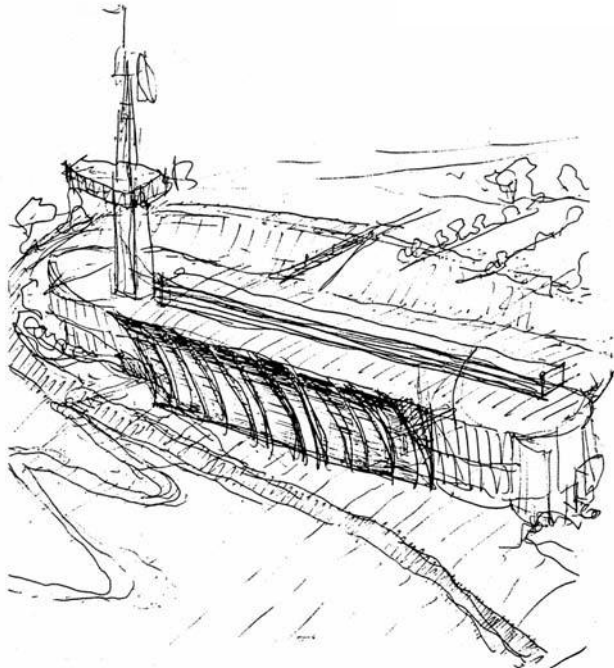
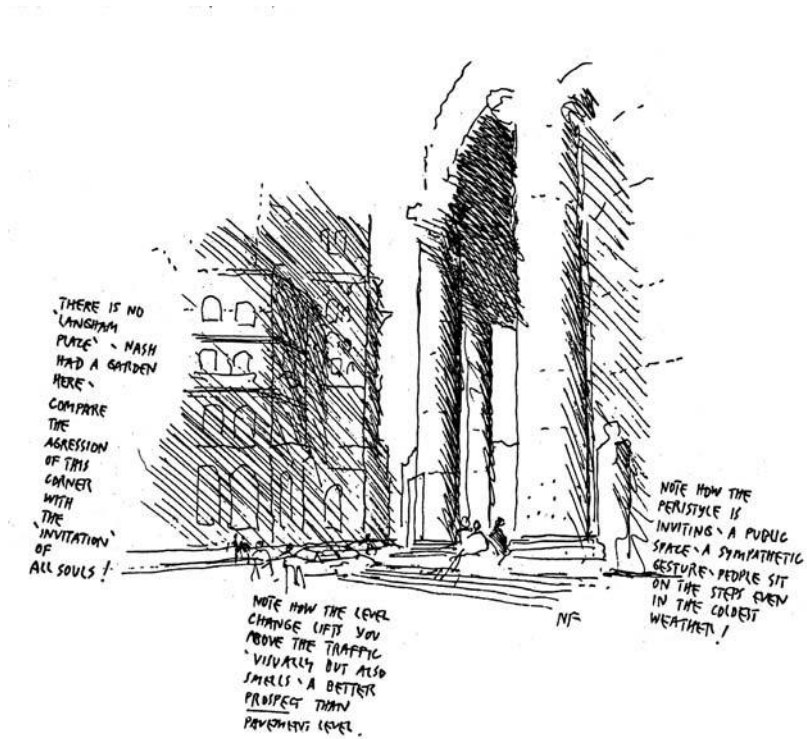

25.4

Sir Nicholas Grimshaw's overhead sketch of the proposed Western Daily News Building reveals a number of design interests with a refreshing freedom of line. (Sir Nicholas Grimshaw)

25.5

Lord Foster's sketch of the view from the Commerzbank in Frankfurt explains the design concept in a fashion that is readily understood by non-architects. (Lord Foster of Riverside)

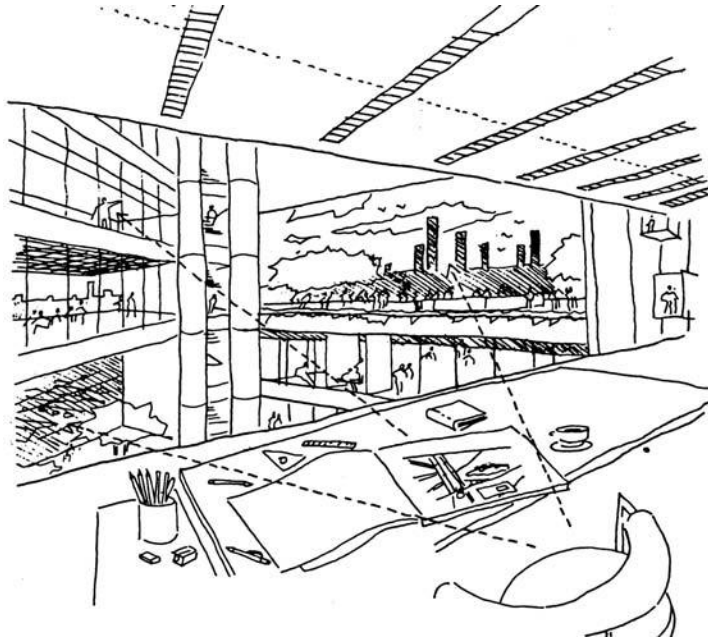

25.6

Sir Terry Farrell's sketch of the Sea Life Centre in Hull confirms Leon Alberti's proposition that beauty is found in the section of a building whilst the plan relays the order. (Sir Terry Farrell)

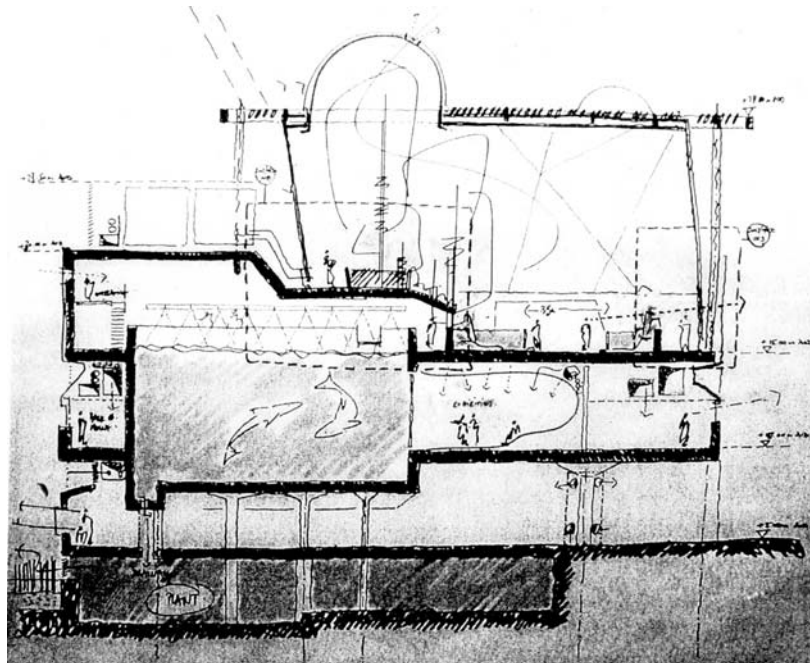

the preferred medium for the majority of remaining architects interviewed. For Farrell the black felt-tip pen has an authority and discipline that mirrors the rigour of design, whilst Cullinan talks of the way black pen is 'difficult to erase and makes you think well'. Grimshaw, on the other hand, often draws with a blue fountain pen, moving onto black drawing pen later when the initial ideas have firmed up.

Some of the architects questioned used black lines because they knew they reproduced well in professional journals. Others referred to the ease of scanning unambiguous black lines whilst several thought that clients were impressed by the implied confidence of the black pen line. Cullinan went further and said that he liked to draw in front of clients as he thought that had helped him win commissions. Fraser mentioned the benefit of photocopying and faxing black pen drawings to clients and consultants, inviting their contribution to drawings, which deliberately had an open framework. Farrell, too, used faxed sketches to communicate with team members often working overseas, preferring this form of communication to CAD. With the design of the Seoul Interchange in Korea, Farrell notes that the first sketch on a napkin was modelled in clay, then cut into sections that were scanned onto computer; these images were then printed and faxed to Korea, having been further drawn over by the architect. The interactive nature of traditional and digitised drawing methods allowed the project to develop without loss of the formal clarity of the initial 'paper napkin' conception.

The abstraction and discipline of pen drawing appears to be a useful means of clarifying design intentions to oneself and others – a point made by Allies who uses two weights of pen line (the thicker Pentel and thin Artline 200) to distinguish the design hierarchies and layers of meaning implicit in the work of Allies and Morrison. Weight of line and its architectural symbolism is noted too

by Farrell who (with Murphy and Gordon Murray) likens the blackness of felt-tip pen on white paper to the solid and void relationships in architectural composition. Only two of the architects interviewed (Alsop and Cullinan) used colour in their initial design drawings, whilst later in the design process Murphy used colour to explain drawings to clients. Fraser warned, however, that the use of colour can undermine the essential rigour of design drawing.

Irrespective of the medium of drawing, all ten architects admitted the importance of line. Designs grew by being shaped by lines in the first instance. These lines were edges and demarcations that ordered the abstractions of sites, urban footprints, the accommodation listed in briefs, structural rhythms and light. Lines in this sense were the delineation of space in both plan and section. Lines remain the fundamental ordering system of architectural exploration. Often, however, these early generative drawings were combined with words or photographs to evoke an essence rather than provide a mere description. In every case cited, lines occur before physical models or modelling on CAD. The lines produced were not usually neutral but were infused with meaning – artistic in the case of Alsop, evolutionary and democratic in the case of Allies, Murphy, Fraser, Allan Murray, Grimshaw and Foster, and authoritative and assured in the case of Cullinan, Farrell and Gordon Murray.

Related to the question of line is that of paper. Small cartridge sketchbooks are used for design development by Alsop and Foster, larger ones by Grimshaw and Allan Murray. Tracing paper in narrow rolls was preferred by Allies because its feeling of endlessness encouraged dialogue and a narrative record of thought processes. Others used layout and detail paper in A3 pads because of the ability to build up solutions in transparent layers. The see-through nature of tracing and layout paper had

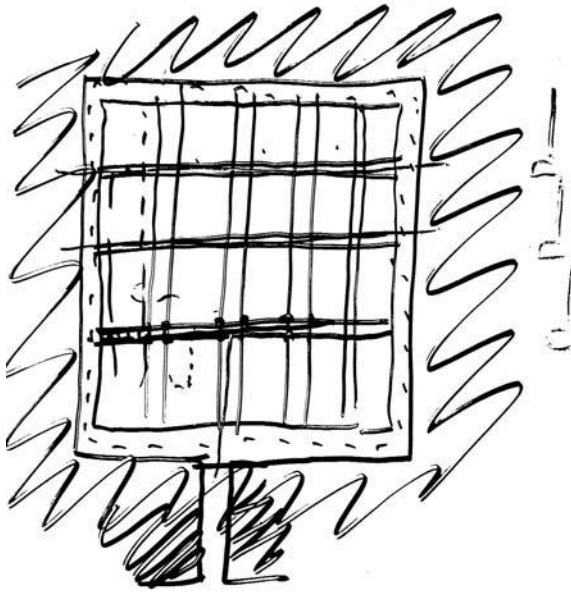

25.7

Composite drawing by Richard Murphy showing the plan and section of the Computer Centre at Napier University, Edinburgh. Although the economy of line means this sketch is little more than a diagram, it contains the kernel of a strong design idea. (Richard Murphy)

practical and aesthetic benefits (Murphy, Gordon Murray, Grimshaw), whilst the smooth quality of such paper in relationship with felt-tip pens or pencil appealed to others (Grimshaw, Allan Murray). Often there was graduation from small cartridge sketch pads to larger tracing sheets, with a corresponding change from early pencil sketches to felt-tip pen and marker, a point noted in particular by Foster and Alsop.

It appears that the evolution of design ideas is matched by a gradual expansion in the size and often sophistication of drawing tools or techniques involving both freehand and digital media. However, drawing boards were only noted in two of the offices visited and here their role was rather more social than practical. Allan Murray, for example, shares an A0 board with his partner, the two of them working from opposite sides of the same

board in order to encourage collaboration in design. The pattern found generally, however, is that of a progression from the initial design diagram, to small freehand design sketches to larger freehand drawings, rough card or plasticine models and then CAD visualisation, followed by CAD-generated contract drawings (for the contractor) and often a professionally made model (for the client).

In design investigation the model became an important supplementary tool for many of the architects questioned. Although drawings always pre-existed models, rough models of whole or parts of buildings were employed to explore spatial arrangements, or sometimes façades. For Allan Murray, the model was often made before sections were drawn, as he believes that in design development drawing has limitations after the initial stages. Gordon Murray also used the physical model extensively in testing design options for the SAS hotel in Glasgow, employing freehand drawing and CAD after this stage. Both Allan Murray and Fraser noted that exploration by model was less common than their experience of practice in the USA. Allies talks about two types of plan being drawn (abstract organisational diagram and site plan) which, when combined into the first tentative design, were then tested through the vehicle of a model. These rough models in card, plastic or wood (usually made by the office model-maker) became maquettes, which is akin to the process followed by sculptors. Allies sees such models as a more reliable tool to test the abstractions of the plan than CAD. Many of the architects reported that investigation by model sometimes took over as the main driver of architectural form at a stage midway between the initial sketch design drawing and CAD. Grimshaw likes to make his own models in card or balsa wood, using them to test elements of the building rather than the whole, the images then being scanned onto computer without intervening drawings.

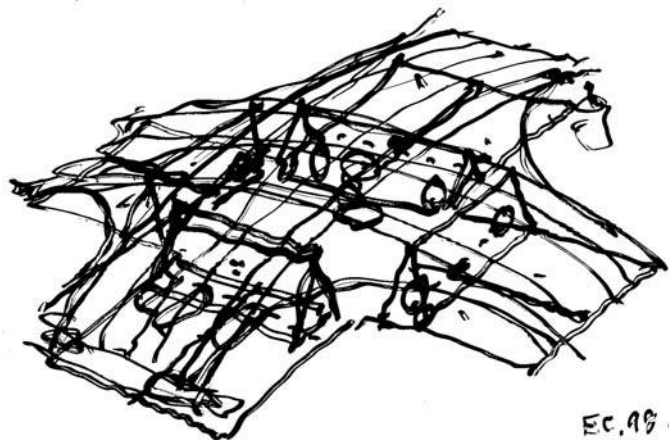
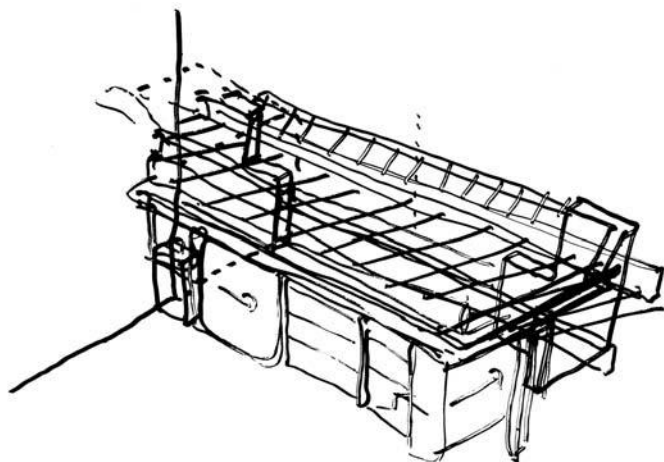
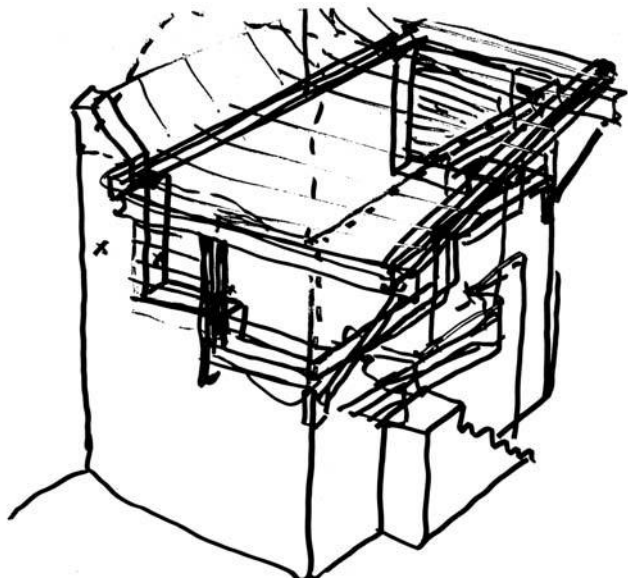

EC. 98.

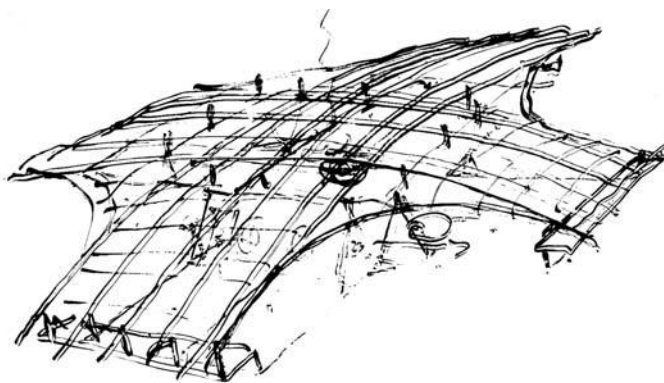

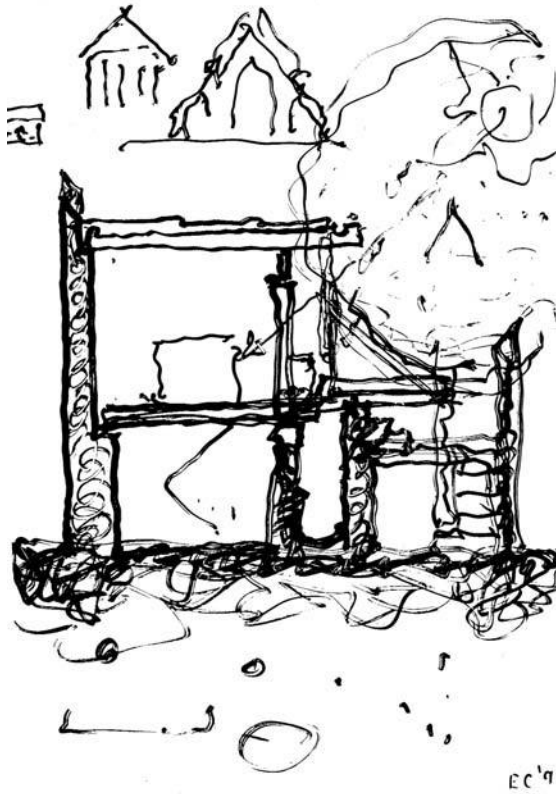

25.8a and b (above left)

These sketches by Richard Murphy show the layering of construction for two Edinburgh house extensions. (Richard Murphy)

25.9a and b (left)

Edward Cullinan's sketches showing the structural principles behind a green oak grid-shell roof. (Edward Cullinan)

25.10 (above)

Edward Cullinan's sketch section of his own house in London. (Edward Cullinan)

The sequence of design generation by the three main vehicles investigated (freehand drawing, model and CAD) varied between architects interviewed. What did emerge, however, was the primacy of freehand drawing in each case and the perceived limitation of CAD as anything but a graphic tool. In fact, where CAD was specifically employed for design evolution some of the architects expressed the view that design quality suffered unless there was parallel inquiry via freehand drawing or model-making. The poor opinion of CAD is surprising given the development in design software particularly aimed at building designers. Using the RIBA Plan of Work as a guide, all ten architects used freehand drawing as the primary or sole design tool at the first stage of design conceptualisation. Freehand drawing also remained an important tool at the second stage, but model-making then emerged as an important contributor to design evolution. Although two architects interviewed employed CAD significantly at the second stage (Gordon Murray and Farrell), its usefulness was mainly in the third stage of design development. However, even at the third stage, CAD was employed in equal measure with model-making in four cases and with model and freehand drawing in a further two. So in spite of popular perception, CAD is not universally used for design evolution by many of the country's leading architects – this role continues to be undertaken by freehand drawing on its own or drawing in association with model-making. More worrying perhaps is the perception that CAD glamorises the image and provides at best a superficial impression of design quality. There are lessons here for architectural education.

The research undertaken sought to explore the use of freehand drawing in design by undertaking structured interviews with ten leading architects in the UK. The architects questioned were all educated before the advent of CAD yet practise in an age of universal use of digital media in design. As such they are the last

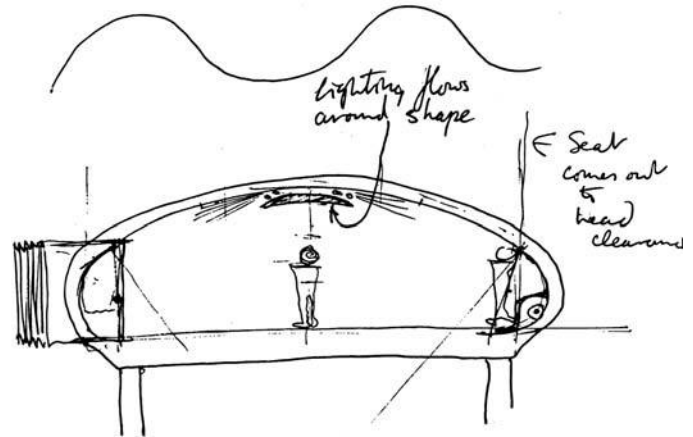
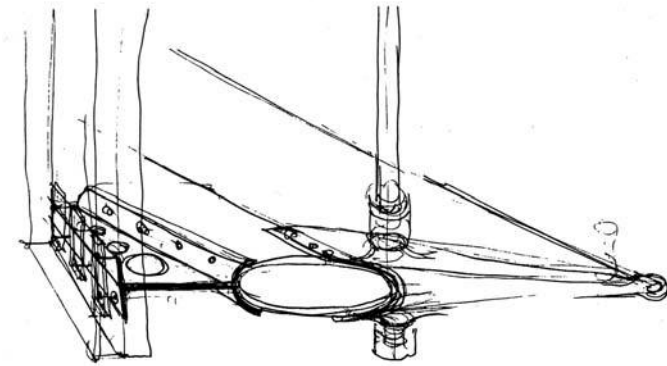

25.11a and b

These sketches by Sir Nicholas Grimshaw display an interest in the poetics of construction. They relay more intended character than a CAD drawing. (Sir Nicholas Grimshaw)

generation of architects whose education was based upon the modernist concept of the 'architectural diagram' and creativity developed through the medium of drawing, painting and abstract model-making. The focus of the investigation was upon how freehand drawing was employed at different stages in the design process and particularly how drawing interfaced with CAD and model-making. The intention was to move from documentary and explorative freehand drawing (the theme of this book) to examine sketching in the context of architectural practice in the twenty-first century. Inevitably, the interviews relayed both personal experience as well as wider perceptions of the role of freehand drawing in the offices concerned. Four main conclusions can be drawn.

First, in the process of solving design problems the

freehand drawing is the pre-eminent tool employed. The drawings produced are a kind of conversation acted out in line and often integrated with words, symbols and photographs to produce a kind of collage of design potential. Whilst architects tend to employ different explorative drawing techniques, they all rely upon the freehand drawing at the initial design stage and to a degree at subsequent stages. The first drawings are 'thinking' drawings or abstract diagrams, usually private rather than shared, often produced after much inner reflection, and generally in plan form. These initial drawings invariably record design thoughts rather than the thoughts following the design sketches. The diagram can be a mere dozen lines but it contains the kernel of a design idea and its very presence is one of the defining

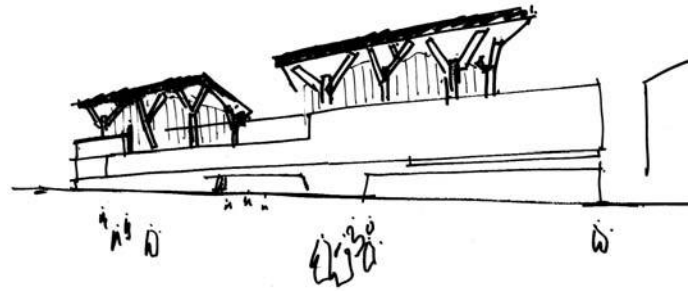
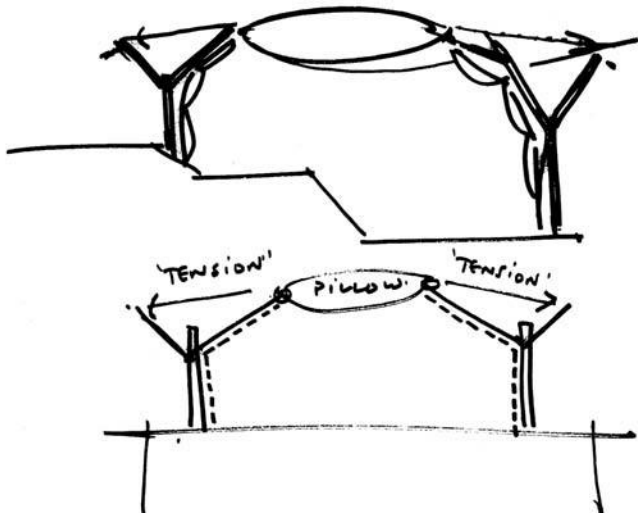

25.12a, b, c and d

This sequence by Sir Terry Farrell's office shows the evolution of a project via freehand drawing, model and CAD. (Farrell and Partners)

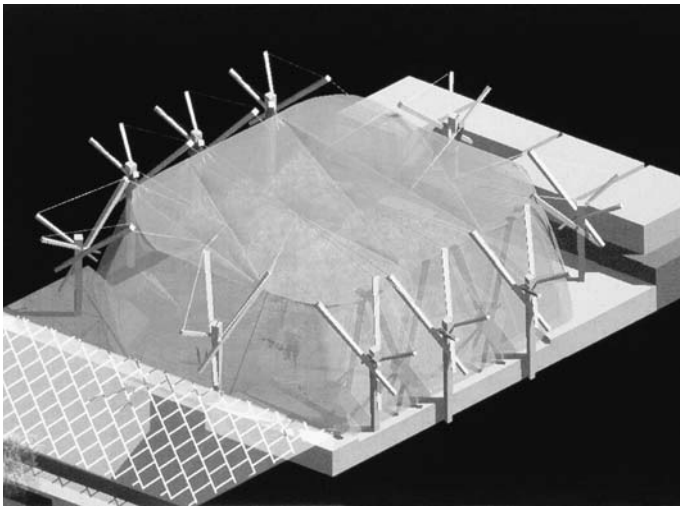

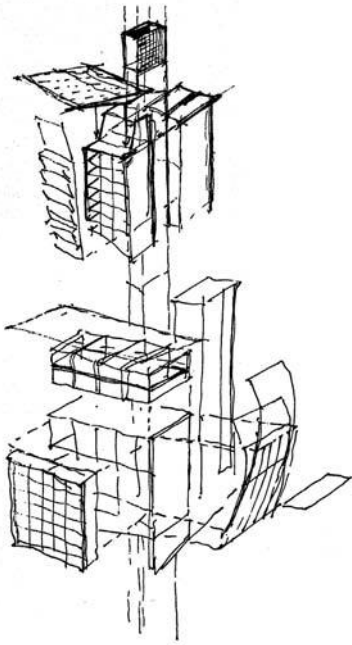

25.13 (left)

Gordon Murray's façade studies for the SAS hotel in Glasgow. (Gordon Murray)

25.14 (below)

Concept drawings for tower block in central Moscow based upon the intertwining of two figures. The design is by RMJM's Edinburgh and Moscow offices in collaboration with the artist Karen Forbes. (RMJM)

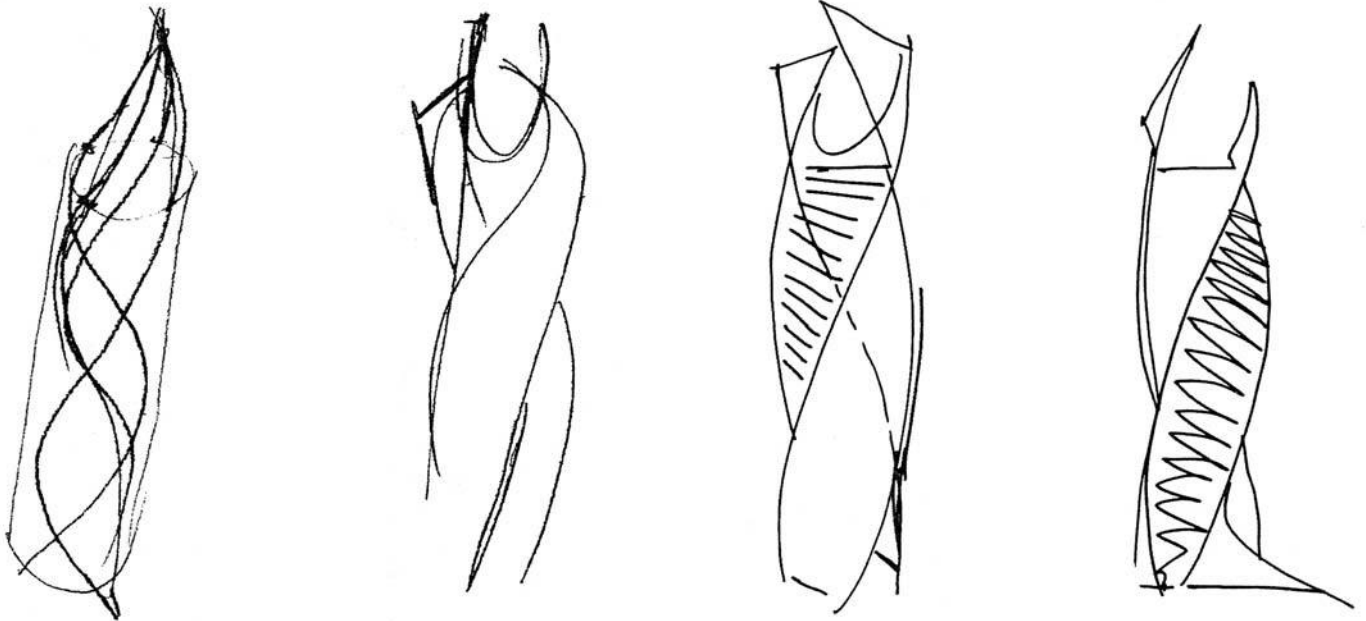

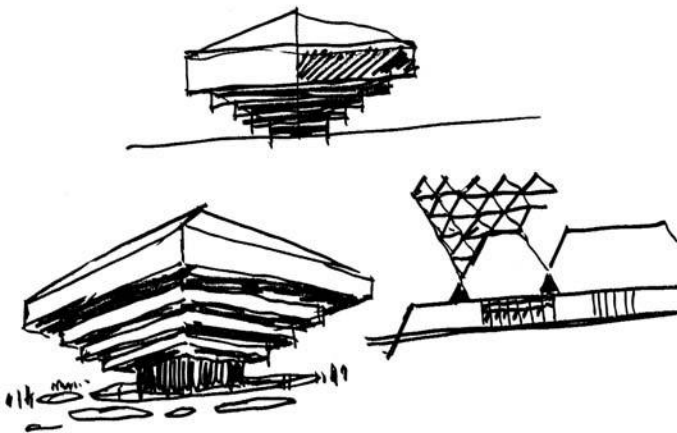
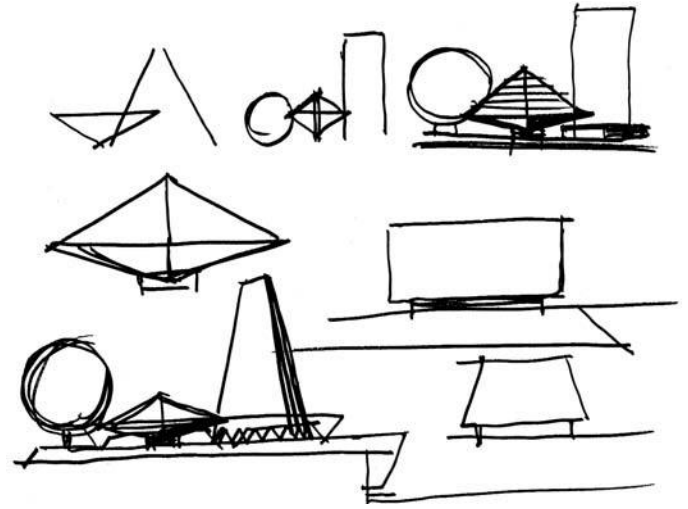
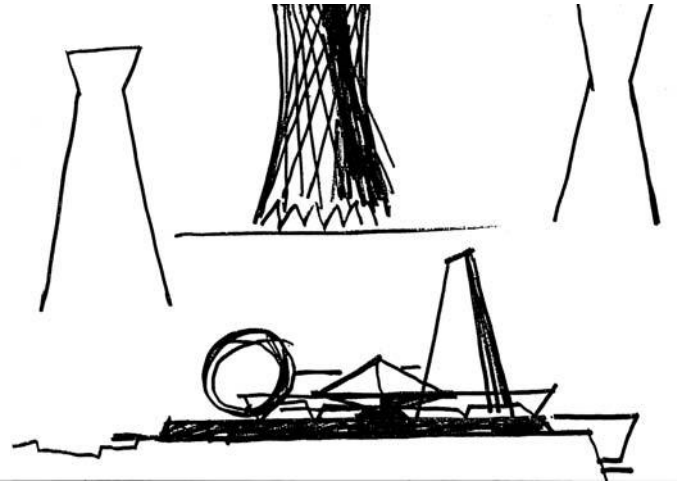

25.15 a , b and c

These sketches by Sir Basil Spence for the design of the British Pavilion at Expo67 show the architect exploring architectural options through freehand drawing. (Sir Basil Spence Archive)

features of being an architect.

Second, since many architects, especially the more experienced, design in their heads and often visualise the external form of a building in their imagination, the progression of design thought consists of setting down in drawing the first concepts and developing these via tools such as models and CAD. These early drawings are generally diagrammatic rather than real plans and contain the essence of architectural thinking. Generally the sketch plans diversify into sections, perspective sketches and studies of details, materials or light. Elevations tend to come late in the process. In some instances, the section diagram assumes authority over the plan especially when environmental considerations are paramount. Although less experienced architects rely more upon freehand drawing at the initial design stage, there is a consistent progression from the architectural diagram to plan drawing, then to other drawing types (section, axonometric), to investigation via models and finally CAD. Hence CAD remains essentially a drafting, documenting and presentation tool.

Third, CAD is not only rarely employed as a design tool at the early stages of concept gestation by the country's senior architects, it is felt by many interviewed to hinder initial design investigation. Several architects deliberately avoid its use until the building has been relatively resolved by other means. In fact, the view expressed by some was that the use of CAD too early undermined architectural exploration and had a detrimental effect on the quality of architectural thought. Furthermore, two of the architects interviewed thought that graduates today from UK schools of architecture were too dependent upon CAD. One large Edinburgh practice, for instance, preferred to recruit new staff from Europe because they were still trained to think through traditional drawing. Another regretted the loss of spatial inquiry through the interfacing of drawing and model-making, which he had found

prevalent in the USA. He found UK graduates too eager to move to CAD to explore questions of space, thereby neglecting the potential of freehand drawing.

Four, a surprising number of experienced and successful architects kept a personal sketchbook and others commonly used sketches of the site to influence their design thinking. Sketching was seen to be useful in terms of visual thinking, in undertaking spatial analysis and in carrying out site investigation. Such sketches were not just views but rough plans and analytical studies of existing buildings. The discipline of looking through drawing was as important as the role of sketching in mere recording of site features. Since four of the architects interviewed had won prizes as students for their drawings (Foster, Grimshaw, Farrell and Allies) this was hardly surprising but it remained significant that sketching was closely aligned with the creative side of design drawing.

In reaching these conclusions, the author admits several methodological limitations. First, the generational aspects of the inquiry make the results specific rather than universal. One suspects that younger architects and those educated outside the UK will give quite different responses to the questions posed. The tensions displayed between modes of exploration reflect in many ways the Britishness of architectural design with its emphasis in the post-war years upon programme, technology and urban redevelopment. Freehand drawing is both a tool and the product of an era faced by this generation of architects. Another limitation concerns the small sample and the prestige of those interviewed. However, the smallness of the sample is balanced by depth, both in terms of the questions posed and the time given to the interviewer (usually an hour). Those interviewed were also architects of whom a great deal has been said elsewhere, thereby allowing the answers given to be set against existing scholarship and a large body of published buildings.

Architects interviewed

Architects	Name of practice	Size of practice
Bob Allies	Allies and Morrison	74 architects
Will Alsop	Alsop Architects	40 architects
Ted Cullinan	Edward Cullinan and Partners	35 architects
Sir Terry Farrell	Farrell and Partners	45 architects
Lord Foster	Foster and Partners	174 architects
Malcolm Fraser	Malcolm Fraser Architects	17 architects
Sir Nicholas Grimshaw	Grimshaw	34 architects
Richard Murphy	Richard Murphy Architects	28 architects
Allan Murray	Allan Murray Architects	24 architects
Gordon Murray	Murray Dunlop Architects	21 architects

Bibliography

- Alexander, C. (1964 and 1977) *Notes on the Synthesis of Form*, Cambridge, MA: Harvard University Press.
- Architectural Review (The)* (1943) vol. 12, p148.
- Architectural Review (The)* (2006a) vol. 219.
- Arnell, Peter and Bickford, Ted (1985) *Frank Gehry: Buildings and Projects*, New York: Rizzoli, see in particular p.vix
- Bacon, E. (1967) *The Design of Cities*, London: Thames and Hudson.
- Bentley, I., Alcock, A., Murrain, P., McGlynn, S. and Smith, G. (1985) *Responsive Environments: A Manual for Designers*, London: Architectural Press.
- Bowers, J. (1999) *Introduction to Two-Dimensional Design*, London and New York: John Wiley and Sons.
- Broadbent, G. (1990) *Emerging Concepts in Urban Space Design*, London and New York: Van Nostrand Reinhold.
- Clark, Kenneth (1943) 'Ornament in Modern Architecture', *The Architectural Review*, vol. 94, pp147–50.
- Critical Architecture* Conference (2004) Online at www.criticalarchitecture.ucl.ac.uk
- Cullen, G. (1971) *The Concise Townscape*, London: Architectural Press.
- Curtis, William (with Thorne, Martha)(1999) *Pritzker Architecture Prize: The First 20 Years*, Chicago: Chicago Art Institute.
- Dunster, D. (2006) 'The diagram: design essence', *The Architectural Review*, vol. 229, pp28–30.
- Eastman, C.M. (1970) 'On the analysis of the intuitive design process', in G.T. Moore (ed.) *Emerging Methods in Environmental Design and Planning*, Cambridge, MA: MIT Press, pp42–59.
- Evans, R. (1997) *Translations from Drawings to Building and Other Essays*, London: Architectural Association, pp153–94.
- Giedion, S. (1941) *Space, Time and Architecture*, 1954 edn, Cambridge, MA: Harvard University Press.
- Graves, Michael (1977) 'Conversation through drawing', *Architectural Design*, vol. 6, no. 77, pp 394–6.
- Farrell, T. (1998) *Sketchbook*, London: Rightangle Publishing.
- Forty, A. (2004) *Words and Buildings: A Vocabulary of Modern Architecture*, London: Thames and Hudson.
- Gomez, P. (1997) *Architectural Representation and the Perspective Hinge*, Boston, MA: MIT Press.
- Hill, J. (2003) 'Hunting the shadow – immaterial architecture', *Journal of Architecture*, vol. 8, summer, pp165–79.

- Hogarth, P. (1973) *Drawing Architecture: A Creative Approach*, London: Pitman.
- Hopton, Laura (2002) *Drawing Now*, New York: Museum of Modern Art.
- Jenkins, D. (ed.) (2005) *Norman Foster Works 2*, Munich: Prestel.
- Lambert, P. (1998) *Architecture and its Image: Four Centuries of Architectural Representation*, Montreal: Canadian Centre for Architecture.
- Lawson, B.R. (1980) *How Designers Think*, Oxford: Architectural Press.
- Lawson, B.R. (1990) *How Designers Think* (second edition), Oxford: Butterworth Architecture.
- Lawson, B.R. (1994) *Design in Mind*, Oxford: Butterworth Architecture.
- Lefebvre, H. (1991) *The Production of Space* (trans. D. Nicholson-Smith), Oxford: Blackwell.
- Lynch, K. (1960) *The Image of the City*, Cambridge, MA and London: MIT Press.
- Matheou, D. (1995) 'In the news', *The Architects' Journal*, 17 August, pp18–19.
- 'Pendock Competition results' (1996), *The Architectural Review*, vol. 200, no. 1193, pp18–19.
- Periton, D. (1996) 'The Bauhaus of cultural paradigm', *Journal of Architecture*, vol.1, autumn, pp189–205.
- Powell, K. (2001) *Will Alsop Book 1*, London: Laurence King.
- Quantrill, M. (1999) *The Norman Foster Studio*, London: Spon Press.
- Rattenbury, K. (2002) *This is not Architecture: Media Constructions*, London: Routledge.
- Richard Murphy Architects: Ten Years in Practice* (2001), Edinburgh: Fruitmarket Gallery.
- Robbins, E. (1997) *Why Designers Draw*, Cambridge, MA and London: MIT Press.
- Rossi, A. (1982) *The Architecture of the City*, Cambridge, MA and London: MIT Press.
- Royal Academy of Arts (2003) *In Search of Architecture: The Watercolour Albums of Sir Thomas Graham Jackson*, exhibition catalogue, London: RA Publications.
- Saint, A. (1996) *Allies and Morrison*, Ann Arbor, MI: University of Michigan Press.
- Schenk, P. (1998) 'Drawing for design: the impact of computer-assisted design on the role of drawing for communication designers in commercial practice', *The Design Journal*, vol. 1, issue 3, pp45–50.
- Schon, D.A. (1983) *The Reflective Practitioner: How Professionals Think in Action*, London: Temple Smith.
- Sheils, B. (2003) 'Making paradigms', *Journal of Architecture*, vol. 8, summer, p205.
- Stern, Robert (1977) 'Drawing: towards a more modern architecture', *Architectural Design*, vol. 6, no. 77, pp382–90.
- Zaha Hadid (2006) Guggenheim Museum, New York.

Index

Page numbers in **bold**
refer to illustrations.

- Abstraction 50
Alexandria Public Library **231**
Allies, Bob 242-59
Alsop, Will 12, 230, 236, 239-59
Andraixt, Majorca **21, 42**
Antalya **141, 200**
Approximate plans 64
Aylsham, Norfolk
 church **46**
Ayr, Scotland **39**
ARB prescription 234
Archaeological sites 160-4
Architecture
 as decoration 218
 as structure 218
Arup Associates 218, **221, 222**
Authenticity, in design 125-6
Axonometric drawing 179, 245
Background architecture 181
Baghdad **49**
Barcelona
 Bach de Roda **136-7**
 Cathedral cloister **94**
 Placa Reial **93**
 Parc Guell **175**
 Pavilion **125, 149**
 street scene **148**
Bastide towns 187-192
Bath
 Pulteney Bridge **117**
 Pump Rooms **4**
 Royal Crescent **65**
 street studies **202-3**
Bayeux Cathedral **208**
Bedzed **153**
Bennetts, Rab 158, 159
Berlin
 Jewish Memorial Museum 81, **81**
 Stock Exchange **68**
Bidborough, Kent **2**
Bilbao Guggenheim Museum **78, 79**
Bingham, James 82
Birmingham, near **44, 63**
Black Creek Pioneer Village, Ontario **40**
Boston, Beacon Hill **55**
Boundaries 201-4
Bridges 116
Brighton Public Library **158**
British Pavilion, Seville Expo **155**
Building
 acts 185-7
 construction 135-8
 details 207
 types 205
CAD 80, 85, 86-7, 226-32, 236, 239-59
Candleholders **61**
Cardiff Bay Visitor Centre **247**
Carrington, Scotland **91**
Castollonnes, France **191**
Charles, Prince 5
Chartwell Visitor Centre **18**
Chicago **43, 109, 129**
Chislet Colliery, Kent **3, 134**
Cinemas 102
City, visual language of 90
Cley, Norfolk **62**
Cockerel, C.R. 1
Composition 50-8
Corbusier, le 212, 213, 233
 buildings **213**
Courtyard house
 Middle East **158**
 Syria **204**
Coventry Cathedral **229**
Cromer, Norfolk **68**
Cullen, Gordon 72, 90
Cullinan, Edward 223, 239-59
Damascus skyline **112**
Decoration 130
Design
 importance of 1-9
 Problems with 227-9
 process of 12-13, 16, 214-8, 226-232
 progression into 214-220, 226-259
Deserted village, Scotland **165**
Devey, George 10
Diagonals, use of 40-1
Diagram 227, 233

- Digitisation 86-7
- Documentary investigation 64-70
- Doorways 114, 116-120, 182-4
- Dordogne, France 188
- Dovercourt, Essex **20, 47**
- Drawing
 - freehand 226-45
 - function of 1-5, 227-32
 - language of 29, 226-7
 - materials 25-8, 247-9
 - perspectives on 229-38
 - problems with 226-9
 - research 238-59
 - today 10-3, 226-59
 - tools 247-51
 - types of 9, 234-8
- Dublin **96**
- Dubrovnik **63, 97**
- Easdale, Scotland **76-7**,
- Edinburgh
 - George Street **224**
 - House extensions **252**
 - Old Town **79**
 - Royal Mile **49**
- Entrances 114, 115, 182
- Epping High Street Studies **214, 215**
- Eymet, France **113, 118, 189**
- Exploration 199-213
- Expo67, British Pavilion **257**
- Façades
 - clues to internal function 123-5
 - clues to proportional systems 128-9
 - clues to structure 125-7
- rhythms 110
- sources of decoration 129-30
- Fahy, Susan 80, 81, 83, 84
- Faro Island houses **125**
- Farrell, Sir Terry 23, 28, 71, 154, 230, 242-59
- Figure ground **67**
- Financial Times* printing works, London **4**
- Flockerton Mill, Douglas, Scotland **65**
- Florence **46, 79, 87, 95**
- San Lorenzo Library **173, 175**
- Foster of Riverside, Lord 1, 29, 232, 239-59
- Framing elements 132-5
- Frankfurt Commerzbank **249**
- Frazer, Malcolm 237, 242-59
- Functional traditional 132-41
- Gaeta, Italy **48, 125**
- Gateways 114-20
- Gaudi, Antonio 208, 212
- Giza, Egypt **169**
- Glasgow
 - apartment block **205**
 - Blythswood Square **40**
 - Cathedral Square, proposals **223**
 - central **110, 122**
 - circular tenement **2**
 - crescent **118**
 - Daily Express Building **6**
 - Gorbals **220**
 - Great Western Road **175**
- Gribloch **8**
- Hill House **41, 124**
- Merchant City **53, 178-87, 178, 180, 181, 182, 183, 185, 186**
- motorways, proposals for decking **223**
- Pollokshields **91, 205**
- SAS Hotel 251, **256**
- suburban street **146**
- Templeton's Factory **31**
- tenement area **100, 206**
- terraces **129**
- Tobacco Exchange **176**
- Gloucester **57**
- Goddards **120, 121**
- Goldsworthy, Andy 150, **150**
- Gravesend, Kent **69**
- Green Building, Manchester **154**
- Grimshaw, Sir Nicholas 155, 239-59
- Guildford, Surrey **102**
- Hadid, Zaha 12-3, 23, 87, 230, 236
- Harwich, Essex **21, 208**
- Hiroshima 192, **194**
- Hirst, Nick 32, 57, 120, 121
- Holt, Norfolk **106, 115**
- Holy Island, Northumberland **5**
- Huddersfield Railway Station **233**
- Hull, Sea Life Centre **249**
- Industrial, influence on design 132
- Industrial landscapes 145-7
- Industrial subjects 132-5
- Interiors 170-5
- Interior design
 - framing elements 174-5
 - principles 171
 - rendering techniques 173
- Japanese urbanism 192-5
- Kalamazoo, Michigan **139, 175**
- Kansai Airport **140**
- Kinlochmoidart House **32**
- Koolhaas, Rem 13
- Kyoto, Horyu-Ji Temple **119**
- Ryoanji Temple **79**
- Landmarks
 - hierarchy of 108-13
 - navigation by 111-3
 - old and new 111
 - similarity of 108
- Landscape drawing 142-50
- Lille Eurostar Station **140**
- Lisbon Orient Station **228**
- Loch Lomond Visitor Centre **159**
- London
 - BBC Headquarters **248**
 - Cullinan house **253**
 - Docklands **67**
 - Finland Quay **225**
 - Isle of Dogs **131**
 - Limehouse **217**
 - Pimlico **105**
 - Samsung Building **28**
 - South Bank **127**
- Manchester **71**
- Machinery 133-9
- Mackintosh, Charles Rennie **5, 16, 20, 208-12**

Mackintosh buildings study **209**
 Modern landscapes 147
 Modern movement, in architecture 119
 Modernism 138
 Montreal grain silos **83**
 Murphy, Richard 242-59
 Murray, Allan 242-59
 Murray, Gordon 242-59
 Nagy, Lazio-Moholy 83
 Nature 142
 Neighbourhood 201
 New Lanark, Scotland **48**
 New York **23**
 Newcastle upon Tyne,
 Royal Victoria Hospital **19**
 Arts Centre **230**
 Nimes, Maison Carree **11**
 Norland, drawing of **48**
 North Walsham, Norfolk **94**
 Oman village **107**
 Ontario landscape **144**
 Orkney fishing boats **133**
 Paisley, Russell Institute **131**
 Palma, Majorca **145, 147**
 Paris
 Place Duphine **149**
 Pompidou Centre **33**
 view **110**
 Patterns, exploiting 50
 Penicuik **199**
 Pentland Hills, Scotland **144, 148**
 Perspective
 discovery of 38
 techniques 38, 40-5
 Photography and drawing 80-7
 Pienza, Italy **177**
 Planning codes 144-6
 Practice 60
 Prague
 Europa Bar 170-1, **174**
 general view **48**
 Proportion 128-9
 Public buildings, importance of 178-87
 Reepham, Norfolk **142**
 Reid, Richard 18, 22, 214, 221
 Robin Hood Interchange proposals **231**
 Roman settlements 165-8
 Rome
 Baroque square **105**
 British Embassy **84, 168**
 San Maria della Pace **53**
 Ronchamp, chapel **213**
 Routes
 changes of level 103
 exploitation of 101-4
 landmarking of 103
 punctuation of 101
 San Felice Circeo, Italy **115**
 San Gimignano, Italy **45, 102**
 Sequential drawing 9, 72-9, 188-9
 Sequential photography 83
 Shadows 46-8, 184
 Sheringham, Norfolk **18, 34**
 Siena **101, 103, 109**
 Sigiriya, Sri Lanka **166, 167**
 Skara Brae, Orkney **160, 161, 162-4**
 Sketchbook
 learning through 9, 16-9, 26-7, 154-69
 size of 25
 use of 1, 2, 9, 12, 113, 154-69, 242-50
 Sketches
 choosing subject 30-5
 selecting right time 72
 types of 9, 226-37
 Skyline 108-13, 201
 Snowdown Colliery, Kent **9**
 Spence, Sir Basil 8, 168, 229, 257
 Sperlonga, Italy **103, 116**
 Squares
 drawing 90-3, 98-9
 focal points 92
 hierarchy 99
 perimeter activity 98
 types of 90
 Streets
 character of 101-4
 key qualities 198
 types of 100-1
 Sustainability and drawing 152-8
 Taversoe Tuick Cairn, Orkney **169**
 Thomson, Alexander 208
 Thomson buildings study **210, 211**
 Tokyo, Shinjuku **193, 195**
 Subway system **157**
 Town planning 67-9
 Townscape 90-2
 Triangular framing 58
 Turin, Piazza San Carlo **66**
 Tuscan landscape **59**
 Ukiah, California **55, 123**
 Urban design
 key qualities 90-3, 111
 spaces 98, 199
 typologies **95**
 Vancouver, BC, Canada **23, 109, 206**
 Venice
 bridges **74, 75**
 St Marks **127, 173**
 Villeréal, France **188, 190**
 Visual
 Discipline 7
 perception 218
 structure 214-20
 Visualizing through drawing 29
 Wells Cathedral **172**
 Western Daily News Building **248**
 Windows **4, 184-5, 185**
 Yorkshire Sculpture Park **151**