

THE STONE

THE JOURNAL OF THE PHILOSOPHERS OF NATURE

© 2001, TRIAD PUBLISHING. ALL RIGHTS RESERVED.

VOLUME 2

1996 - 1997

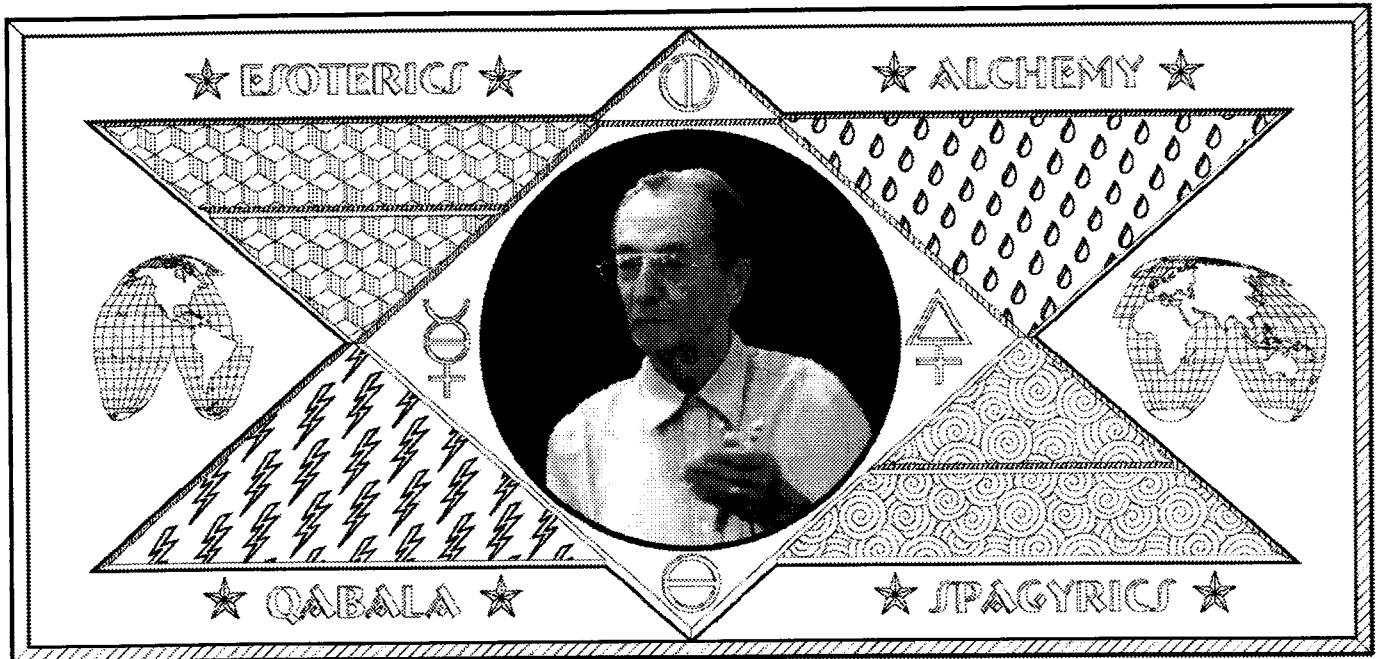

VOLUME 2 OF 3

- ♀ Issue 15, March 1996
- ♀ Issue 16, July 1996
- ♀ Issue 17, Nov./Dec. 1996
- ♀ Issue 18, Jan./Feb. 1997
- ♀ Issue 19, Mar./Apr. 1997
- ♀ Issue 20, May/June 1997
- ♀ Issue 21, July/Aug. 1997
- ♀ Issue 22, Sep./Oct. 1997
- ♀ Issue 23, Nov./Dec. 1997

♀ Cover Photograph: Jean Dubuis

THE STONE

The Philosophers of Nature was a research and educational association that existed in the United States from 1987 until 1999. The focus of the organization was on the Western esoteric practice, with a particular emphasis on practical work in Alchemy and Qabala. "The Stone" was the newsletters for members and associates of The Philosophers of Nature.

It is reprinted in 3 volumes by Triad Publishing.

TRIAD PUBLISHING

P.O. Box 116, Winfield, IL 60190 USA

Email: info@triad-publishing.com www.triad-publishing.com

THE STONE

THE JOURNAL OF THE PHILOSOPHERS OF NATURE

© 2001, TRIAD PUBLISHING. ALL RIGHTS RESERVED.

Dear Reader,

As a 'charter member' of The Philosophers of Nature (back when it was LPN-USA), I had the great privilege of waiting for the first 16 issues of these newsletters to come to my mailbox. They were great, right from the start, or at least I thought so. Never mind that desktop publishing was in its infancy, and that an affordable scanner was just a dream in 1990, this was a newsletter that did what it set out to do -- connect the few and far-between alchemists, qabalists, ceremonialists, astrologers and Hermeticists that were The Philosophers of Nature. Ken Miller was the editor for those 16 great issues; more than anyone, he gave The Stone a personality that the later caretakers would continue as well as we knew how.

Beginning with issue 17, I could no longer wait for The Stone to come to my mailbox, but was instead involved in the production of each issue, working with Editor-in-Chief Rick Grimes. We died a thousand deaths together dealing with the 2AM technical glitches that seemed to travel in herds at that time of day. Sometimes we were a little 'light' on material for an issue, a day or so before the deadline, so one of us would start writing an article. It was this sort of necessity that prompted me to write an article about a childhood hero, George Washington Carver.

As the organization grew, and the number of subscribers to the newsletter along with it, Vi and Norm Engel volunteered to take over the bi-monthly copying and mailing. Their doing so helped to keep The Stone and The Philosophers of Nature afloat for just a bit longer.

Today, the PON is no more. I hope that those of you, who read these issues of The Stone, will find something inspiring here, something that moves you into action. I think you will find that The Stone was the voice of some of the finest thinkers, innovators, and tinkerers of our times.

With best regards,



Russ House
Triad Publishing



IMPORTANT NOTE: Many of the businesses that advertised in these issues are closed. Do not send money to any of the companies listed in these back issues unless you have contacted them first. These issues are complete as originally published, except that we often removed the last few pages of issues in the 3rd volume as they were advertising for publications from the PON that we ran repeatedly.

TRIAD PUBLISHING

P.O. Box 116, Winfield, IL 60190 USA

Email: info@triad-publishing.com www.triad-publishing.com

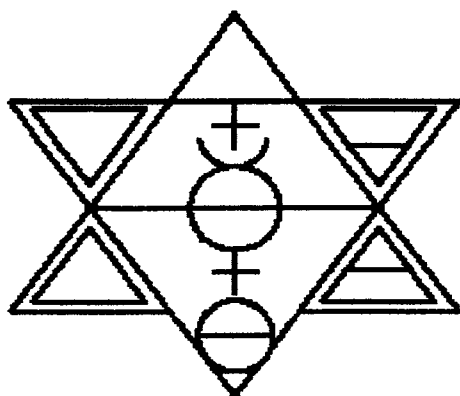

The Stone

& ORA ET LABORA

Journal of The Philosophers of Nature

Issue Number 15

March 1996

The Ides of Stones

For your reading pleasure: the March and 15th consecutive issue of The Stone. If this is your first, welcome! If you are a regular reader of The Stone... no your watch hasn't stopped. Nor is your calendar off a month; we actually managed to prepare and mail this issue so that it would arrive to you in March! Imagine, reading an issue of The Stone in the same month as the cover date; this may be something of a first for us. This is just one of the improvements in service you are bound to notice. The administrative headquarters has been working very hard to improve efficiency and it appears we are succeeding.

The big news is the Conference scheduled for May 27-31 this year (see page 15). A tentative schedule is available now and you can check it out at our web site (<http://www.mcs.net/~alchemy/>). Personally, I always find the content of these things secondary to the wonderful interpersonal exchanges that take place. Let's face it, this is the one place where you can say you are working on alchemy and not be asked "oh, you must be a Jungian," or "wow, how much lead have you changed to gold so far?" The friendships you form here will be deep and long lasting; and there is much to be learned from your peers on lab technique and other experiences. One of the goals of PON has always been to create an environment for the free exchange of information so that the whole may benefit.

Easy research

An upcoming ORA Project (see page 14) involves studying astrological influences on lab work. From the classics to modern day masters like Junius, the importance of astrological influences should not be underestimated, or so we are told. I know many alchemists that do not pay particular attention to these things. A questionnaire is being developed that will query people on the date, time, place, nature of the alchemical procedure's outcome. This is to start verifying/clarifying the astrological admonitions traditionally associated with various lab projects. If you have any ideas for the questionnaire please contact me. We hope to mail it out to members in the Spring sometime.

Enjoy the issue, as always I welcome your submissions and comments. Please try to send your articles on an IBM formatted diskette, I can import virtually any word processor format (except the Windows 95 editions; I have not made the jump just yet). The deadline for articles for issue #16 is June 20th, 1996.

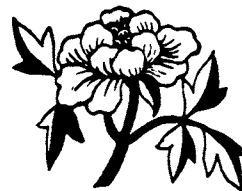

In This Issue...

The Ides of March	by Ken Miller	page 1
The Open Door of Alchemy	by John Eberly	page 2
Alchemy and the Tamil Siddhars	by Joseph Caezza	page 5
The Tarot: Structure and Use, Part Two	by Ned Darenuith	page 9
Pow-Wow, Psalms, and German Magical Folklore	by Mark Stavish, M.A.	page 11
Advertisements		pages 14-16
ORA ET LABORA		pages 17-21
About The Stone		page 22

The Stone, Issue Number 15, Mar. 1996. Published in March, July, & November by the Philosophers of Nature. Editor: Ken Miller. Subscription details on page XXII. © 1996 Philosophers of Nature.

The Open Door of Alchemy

by John Eberly, © 1996

*Go, seek out the
Friend, for God's sake:
the secrets of words will
never reveal Him*

-Nurbakhsh

Procuring the tincture from plants, animals and minerals is an alchemical spiritualization of basic matter. The philosophic sulphur, mercury, and salt of a given substance in whatever kingdom is first separated, and then recombined in such a way as to produce an exalted substance. This inspired work amounts to an accelerated process of Nature, in which the alchemist becomes the intermediary between earth and heaven.

This essential *becoming* of the alchemist has been cited as the goal of the Art, whether the source of the citation emphasizes a seemingly material process, or, on the other hand, a purely spiritual one, or both.

In perhaps the most famous of all legends surrounding the early twentieth-century adept known as Fulcanelli, the alchemist mysteriously appears to a young chemist named Jacques Bergier one afternoon in June 1937 and states:

I can tell you this much: you are aware that in the official science of today the role of the observer becomes more and more important. Relativity, the principal of indeterminacy, show the extent to which the observer today intervenes in all these phenomena. The secret of alchemy is this: there is a way of manipulating matter and energy so as to produce what modern scientists call a "field of force". This field acts on the observer and puts him in a privileged position *vis-a-vis* the Universe. From this position he has access to the realities which are ordinarily hidden from us by time and space, matter and energy. This is what we call "The Great Work". (1)

We must assume that the Art reveals externally through "experiment" what is simultaneously revealed internally to the artist, transforming both, and creating a situation in which the distinctions between internal and external are rendered meaningless.

Russ House, in a recent issue of "The Stone & Ora Et Labora-Journal of The Philosophers of Nature" (2) states:

In the fall of 1993, during a seminar at St. Charles, IL, a distillation of an amalgam was demonstrated out of doors, using an electrically heated distilling apparatus...At that time, I had an experience which was both physical and 'subtle' which convinced me that the distillation of amalgams can create a force field of significant proportions. Further, I was satisfied by certain facts of the experiment that there was no self-delusion nor expectation of an experience on my part, and that the force field induces chemical changes within the operator...A friend of mine has had similar experiences in work on the vegetable kingdom.

The present author can also attest to the statement above concerning work in the vegetable kingdom.

In a fundamental way, the alchemist must recognize that the prima materia he would transform in which the spiritual seed awaits revelation corresponds exactly with his own flesh and blood, soul, and spirit.

Theophrastus Bombastus von Hohenheim (1493-1541), is more popularly known as Paracelsus, the name conferred upon him by Trithemius, his master in alchemy and a Benedictine monk regarded as an adept of a high order. This master also counted the famed occultist Henry Cornelius Agrippa among his students. Trithemius dubbed his disciple "Paracelsus" to signify that he was greater than Celsus, the famous physician of antiquity. Paracelsus was able to articulate and revise the philosophy and practise of the healers and alchemists who preceded him and synthesize his own ideas into a thoroughly original approach. He taught that every created thing would reveal a hidden, exalted nature if approached and understood correctly. The teachings of Paracelsus would affect subsequent generations of alchemists, indeed, none who would approach any of the healing arts in general could ignore his unique contributions. Paracelsus, always critical of contemporary theology, medicine, and practically anything and everyone else, nevertheless wrote at least one treatise on what he described as the Blessed Blood of Rosy Color, in which he quotes Mercurius speaking of the mystery of blood to King Calid:

This mystery it is permitted only to the prophets of God to know. Hence it comes to

pass that this Stone is called animal, because in its blood a soul lies hid. It is likewise composed of body, spirit, and soul. For the same reason they called it their microcosm, because it has the likeness of all things in the world, and then they termed it animal, as Plato named the great world an animal. (3)

Many sacred traditions admit to the unrealized potential of the creation. Religion generally may be said to supply the means toward the transmutation of cosmic "imperfection" and particularly human nature.

In the Bible, the explanation of the "fall" of humankind is illustrated in the story of Adam and Eve. The animal-nature is revealed precisely at the point when the first man and woman suppose their "imperfection" (or unrealized potential) resulting in the idea of apparent separation from the divine-nature. This situation of course allegorically represents the sulphur, mercury and salt awaiting purification and recombination by the alchemist. The fruit of the tree which effects the separation may correspond to the *Circulata* of Paracelsus of the famous *Circulatum Minus* of Urbigerus. In the story of Adam and Eve, the serpent or dragon of deception convinces of a "false" or "forbidden" rational knowledge of mortality, when in reality the immortal union of God and humanity/nature becomes veiled yet remains everpresent. It is impossible to believe that a Creator-God would allow this chain of events to unfold without purpose. From an alchemical perspective at least, this "hidden" purpose is the revelation to humanity of the divine origin of creation and the means of return to Originality. The biblical stage has thus been set for the entrance of a messiah, the illuminated one endowed with the alchemical mission of healing the perceived division between Creator and creation.

In a discourse by St. Maximus the Confessor entitled "On The Lord's Prayer" we find,

Since we are in this present mortal life, give us this day our daily bread which Thou hast originally prepared for human nature so that it might become immortal (cf Gen 2:9) for in this way the food of the bread of life and knowledge will triumph over the death that comes through sin. The transgression of the divine commandment prevented the first man from partaking of this bread (cf Gen 3:19). Indeed, had he taken his fill of this divine food, he would not have been made subject to death through sin. (4)

Jesus the messiah physically and spiritually recombined the divine origin of humanity and abolished the idea of sin and the fall of creation. He overcame the animal-nature first, symbolically riding the ass that man had

become into Jerusalem. The Atonement of the entire creation by virtue of the Creator was later reached during the crucifixion. The transformation of the world began with death of Jesus the mortal and the resurrection of Jesus the immortal divine essence of humanity.

The veil of the sacred temple was torn, and for three hours darkness covered the earth. The earth quaked, and its rocks were broken apart. Graves were opened and saints of old walked through the holy city. (*Vista Interiora Terrae Rectificando Invenies Occultum Lapidem* - "visit the interior of the Earth, in rectifying you find the hidden Stone").

Many of those present understandably stood in awe of these events and at least one, the centurion, was transformed on the spot saying Truly this was the Son of God.

(He) bought you at the price of his precious blood when, in Adam, you were lost...says the anonymous author of the fourteenth century text, The Cloud of Unknowing. (5)

Nearly four centuries later, Karl von Eckartshausen, a still widely-read German author obviously influenced by Paracelsian-tinged Rosicrucian ideas states:

The tinctural force which flowed from His shed blood penetrated to the inmost parts of the earth...the divine force, driven to the earth's centre by the shedding of His blood, works and ferments perpetually, to press outward, and to fit and prepare all substances gradually for the great cataclysm which is destined for the world...

In the clear understanding of what consists this flesh and this blood of Jesus Christ lies the true and pure knowledge of the real generation of man.

The mystery of being united with Jesus Christ, not only spiritually *but also corporeally*, is the greatest aim of the Inner Church. (6)

The divine substance, the spiritual tincture in the blood Christ physically transmutes the prima materia of Nature, apparently unrealized by humankind since Adam. The light of Christ effects this change from the inside out, driven to the Earth's center, commonly referred to as the Descent Into Hades where He extends His life-giving hand to Adam and Eve, raising them up enlightened with immortal Reality.

He who believes in me will never die, says Jesus in the Gospel of John.

The sulphur (soul), mercury (spirit), and salt (body) say the alchemists, is first separated from its divine origin, then dies spiritually and physically, is purified and recombined into new life. The tincture of the blood of Christ potentiates the exaltation of the entire creation. By following the example of the crucifixion and resurrection, the alchemist accesses the divine substance concealed in Nature through the plant, animal, and mineral kingdoms. Paracelsus, knowledgeable of alchemy as an Art of greatest antiquity, still regards Jesus as the first alchemist when he says,

Seek, seek, says the first Spagyrist, and you shall find; knock, and it shall be opened unto you. (7)

In the Aphorisms of Urbigerus concerning the *Circulatum minus*, or The Philosophical Elixir of Vegetables, he states in Aphorism XVIII:

When your Salt is brought to its perfect Spiritualization, and real Union with its own volatile Spirit, then you will have in you power your Circulatum minus, or Vegetable Elixir, and Menstruum, with which you will be able to perform wonders in the Vegetable Kingdom, separating in a moment not only their Principles or Elements, but also at one and the same Operation the Pure from the Impure. (8)

Innumerable other similar declarations exist concerning the alchemistical transformation of matter in the animal and mineral kingdoms. A rapid separation and purification/recombination implies an equally immediate reunion.

Through the "first Spagyrist" all of creation is transformed allowing the Holy Spirit to enter when the material vehicle is simultaneously perfected. The wind carries it in its belly, say the alchemists. The earth, permeated with the spiritual tincture of the holy blood provides the matrix which brings the seed to fruition. Our daily bread becomes divine food as the wheat seed is pulverized and baked, just as the vine produces the grape that is transformed into the spirit of wine.

And as they were eating, Jesus took bread, and blessed it, and brake it, and gave it to the disciples, and said, Take, eat; this is my body. And he took the cup, and gave thanks, and gave it to them, saying, Drink ye all of it; For this is my blood of the new testament, which is shed for many for the remission sins.

-The Gospel of Matthew 26: 26-28

The mystery of the order of the Christian Mass represents the life of Christ, from incarnation to ascension.

It is not only a symbolic representation, but a living tradition in the strictest sense: it overcomes all conceptions of death with abundant new and everlasting Life.

The early Christians met to worship in private houses, gathered around a triclinium (a dining room with a three-part couch extending around three sides of a table, representing the Trinity, interpreted by Paracelsus and others as the philosophical sulphur, mercury, and salt) to share a simple communal meal of bread and wine. Through their belief in the healing, transforming nature of the substances simultaneously physically and spiritually entering their bodies, they entered into what Fulcanelli reportedly described above as,

...a "field of force". This field acts on the observer and puts him in a privileged position vis-a-vis the Universe. From this position he has access to the realities which are ordinarily hidden from us by time and space, matter and energy. This is what we call "The Great Work". (1)

The result of the Great Work is an exalted *metanoia*, the change of the heart's blood in which the participant/observer becomes One with the Creator as creation realizes its Christ-nature. Rise up like Lazarus and walk again in the garden of Eden, in eternity, with Adam and Eve resurrected, reinstated, and exalted. Hear the words of the first Spagyrist: Knock, and it shall be opened unto you.

NOTES

1. The Morning of the Magicians, p. 78.
2. Issue Number 12, March 1995, pp.X-XI
3. Hermetic and Alchemical Writings of Paracelsus the Great, Book 1, Chap. VIII, p. 55.
4. Philokalia, Vol. Two, p. 299.
5. The Cloud of Unknowing, Chap 1, p. 116.
6. The Cloud Upon the Sanctuary, Letter V, pp. 75-76.
7. Hermetic and Alchemical Writings of Paracelsus the Great, Book 1, Chap. V, p.28. The term "spagyria" apparently coined by Paracelsus, refers to alchemical methods that produce medicines, although generally it is applied to mean the whole of alchemy. The term itself, "spagyria" is derived from two Greek words, spao, to draw out, divide; and ageiro, to gather, to bind, to join. In all probability Paracelsus regards the passion of Jesus Christ as the model alchemical allegory but not the only one. In this same book, A.E. Waite states that "the supreme secret of alchemy" was imparted to Paracelsus by "a generous Arab", no doubt a Muslim. This is not to suggest that this Arab was not generous enough to include the Christ story in His understanding, but simply implies that Paracelsus regarded alchemical truth to be universal.

8. Circulatum minus Urbigeranum, London, 1690.



Alchemy and the Tamil Siddhars

By Joseph Caezza

In the hungered New Age frenzy where the practice and principles of Ayurveda, traditional Hindu medicine, have become so well known, the West still remains largely ignorant of the South Indian Tamil Siddhar tradition. It represents a wonderful parallel to that of the Rosicrucian Alchemists. Just as the Rosicrucians claim lineage to the high culture of Ancient Egypt, itself only an artifact of "Atlantis", so too do Tamil Siddhars trace their original heritage to an advanced civilization destroyed by a great flood about 10,000 years ago. The lost continent supporting this heritage purportedly stretched from Madagascar to Australia with Sri Lanka constituting its central surviving land mass.

Ancient Egyptian High Culture appears suddenly, even from the earliest times at a very advanced level. Examples of its elegance include high yield strains of grain, a precise calendrical system, refined medicine even featuring neurosurgery, but above all its complete system of hieroglyphic language which seems to serve a higher state of consciousness. These advances emerge suddenly from Neolithic chaos. So too, from earliest recorded history Tamil language appears as one of the most sophisticated literary systems on the face of this planet. This lack of developmental period suggests that both Tamil and Egyptian cultures were surviving artifacts, preserved by the greatest sages of highly advanced civilizations destroyed by geological cataclysm.

The contemporary scholar, Kamil Zvelebil, in THE SMILE OF MURUGAN, explains the necessity of understanding the siddhars, the primordial Tamil sages, before any deeper appreciation of South Indian civilization becomes possible. These spiritual giants composed the foundations of literary and scientific development. Yet because they wrote in obscure style so reminiscent of western alchemy and often ridiculed the orthodox caste system with its over-emphasis on ritual worship, the Siddhars have always moved on the outer perimeter of social acceptability. Their chief artifacts aside from a complete medical system include a vast body of esoteric literature as well as every popular rustic poems and bardic songs.

Zvelebil outlines the common features of siddhar poetry:

"a protest, sometimes expressed in very strong terms, against the formalities of life and religion; rough handling of priests and Brahmins in general; denial of the religious practices and beliefs of

Brahmanism, and not only that: an opposition against the generally accepted pan Indian social doctrine and religious practice; protest against the abuses of temple rule; emphasis on the purity of character; claims made by the authors of these poems that they have achieved certain psychokinetic powers and other capabilities which belong to the sphere of parapsychological phenomena; use of imaginative and ambiguous language, rather puzzling though strongly colloquial; no systemic doctrinal exposition. Finally, all these poems are ascribed to a body of sages known as the siddhars (1)."

Does this descriptions recall the mood of the Rosicrucian manifestoes and the Alchemical literature of 17th century Europe during the age of Reformation against the corruption in the Roman Catholic Church?

The Siddhars present themselves as the greatest masters of yoga, medicine and alchemy. Unlike their western counterparts who emphasized the transmutation of base metal into gold, the Tamil sages stressed the accomplishment of physical immortality or at least extended longevity as the ultimate token of self-realization. Parallels exist in the western concept of the "glorified body". Just as in the west, these sages left a vast number of inscrutable texts accessible only to initiates. Their Hermetic emphasis on knowing reality directly by reading "the signatures of Nature", developing contemplative "seeing" as Castanada uses the term or cultivating, "the intelligence of the heart", as described by Schwaller de Lubicz, goes far beyond conventional understandings of Eastern meditation techniques. Such vision in ancient times served as the basis of a sacred science with bountiful practical applications.

Patanjali, one of the greatest Tamil siddhars who accomplished himself at Rameswaram, explicated the essentials of mystic discipline, in his well known YOGA SUTRAS. Although postures, breath and contemplative techniques play a major role this tradition also includes the practical science of Nature; Cosmology, Astrology, Herbalism, Chemistry, Alchemy and Medicine. While Ayurvedic medicine concerns itself generally with herbs and organic treatments the siddhars add strong emphasis on use of inorganic salts, metals and mineral poisons.

Like the romantic notion of the Rosicrucians the siddhars are bound by an oath of secrecy. They wander anonymously practicing their yogic disciplines, doing service to their fellow men especially as dispensers of

potent medicines. In the west sages such as Roger Bacon, Albertus Magnus and Basil Valentine acquired legendary status as alchemists. So too a rich tradition venerates the exploits of these Tamil mystics. Eighteen of the siddhars are venerated above others for accomplishing themselves to the highest level of perfection. The historic locations in India where they performed their penance today comprise spiritually charged centers of pilgrimage.

The first and foremost of the siddhars, Agastyar, fits the image of his western counterpart, Toth-Hermes. Considered the founder of Tamil language and grammar, he presided over the first two sangams, ancient literary academies located on the now submerged continent south of Sri Lanka. He also appears as the primordial giver of arts and sciences. Innumerable classic works ascribe themselves to his authorship. Contemporary Tamil scholars assert that at least 26 classic authors wrote under this name. Who were they all aspiring to imitate? Folk tales abound in account of Agastyar's constant battles with local demons. He pops into the story line of classic epics, the Ramayana and Mahabharata, to bestow blessing and guidance. Tradition has it that Agastyar still lives in the Pothigai Hills, below the Western Ghats, occasionally appearing to the sincere aspirant (2).

Thirumoolar, another of the most renowned Tamil masters, accomplished his magnum opus of yogic reintegration at Chidambaram, the sacred spot where Shiva performs his cosmic dance. The chief contribution of Thirumoolar, the **THIRMANDIRAM**, an esoteric masterpiece of 3000 verses explains man's yogic path to immortal divinity, referring metaphorically to the philosopher's stone that transmutes base metal into gold. Here is the essential classic text of siddhar wisdom. Only in the recent past has this work been made available to the English reading public.

Karuvoorar, an architect as well as a yogin-chemist, played a major role in the design and construction of the Brihadeshwara Temple at Thanjavur. The feats involved in this task recall not only the emergence of the Gothic cathedrals which occurred at about the same time but also the construction of the pyramids. A popular tour guide describes this as one of India's greatest temples:

"This superb and fascinating monument is one of only a handful in India with World Heritage listing and is worth a couple visits. On top of the apex of the 63 meter high temple, a dome encloses an enormous Shiva Lingam. Constructed from a single piece of granite weighing an estimated 81 tons, the dome was hauled into place along a six-km earth work ramp in a manner similar to that used for the Egyptian Pyramids (3)."

From a western perspective Bogar might be the most intriguing of the siddhars. Born into a family of gold smiths in central South-India, Bogar received initiation from the illustrious Natha Yogi, Kalangi. Contemplative insight allegedly guided Bogar to construct a primitive form of aircraft that he used in a journey to China. He is also credited with inventing a sea-going craft using a stream engine, preparing an indestructible statue of the god, Muruga, using nine poisonous herbs and minerals and making a major contribution to the siddhar medicine system which boasts possession of fabulous remedies that heal presently incurable diseases and make possible an extreme longevity. Bogar achieved the ultimate state of perfection at the hill top shrine of Palani where the statue he fabricated is still in use. Elaborate temple murals here chronicle his wondrous exploits.

These claims seem somewhat reminiscent of the achievements of the contemporary western Hermetic master Schwaller de Lubicz, who in an attempt to free France from imported energy invented an engine fueled by vegetable oil. He designed following principles of number and harmonic proportion imbibed from contemplative vision a ship which possessed innovative properties of speed and balance in the roughest waters. He developed an airplane motor still used in France today. He also prepared Homeopathic medicines from plants and rediscovered the medieval alchemical procedure for producing the brilliant red and blue stained glass found in the windows of the Gothic Cathedrals. Evidence suggests that Schwaller was the original genius behind the Fulcanelli material, perhaps the most significant alchemical literature of the century.

A popular legend describes how Bogar made several missionary excursions into China. A master of astral projections and soul transmigration, Bogar entered the body of a recently deceased Chinese youth, revived it and grew to become the Chinese sage, Lao Tzu, author of the **TAO TE CHING** and founder of Taoism. Taoism has a rich alchemical faction devoted to physical longevity that lends credit to this bizarre tale. The **TAO TE CHING** embodies the same esoteric style that haunts the obscure language of the Tamil siddhars and echoes ideas from western alchemy. Any student of Taoist Yoga is shocked by the similarity of its techniques to those of the Tamil siddhars.

Initially I could not accept the possibility that Bogar was Lao Tzu. During an extensive pilgrimage to the shrines of the siddhars in 1989 I encountered well educated residents of Palani who took it for granted that Bogar was indeed Lao Tzu. Finally, I found a pilgrimage guide book written in English, a rare commodity indeed in this off-the-beaten-track location. It described Palani's Hill temple to Lord Muruga and contained a brief monograph on Bogar identifying him as the Chinese sage, Lao Tzu.

Bogar's monumental work of 7000 verses has

recently been edited in Tamil by one of the great living apostles of this tradition, Yogi S.A. Ramaiah of Madras. Since 1954, Yogi Ramaiah has traveled the world, giving lectures, initiating students and building temples. An American center at Yuma, Arizona features a temple containing eighteen granite images dedicated to the greatest siddhars. He does not offer the customary guru-disciple relationship but rather teaches postures, breathing and contemplative techniques geared to give access to what Anthony Rooley described so wonderfully in the third issue of ALEXANDRIA as "The Invisible College", a higher inspired state of mind where ancient knowledge is made present in the imaginal realm of "self examination". Jean Dubuis, the contemporary French alchemist describes a vaguely similar practice as "night school". These concepts might be related to the medieval notion of "the communion of saints" not as blind faith but as actual guiding contemplative experience. Perhaps Herman Hesse's STEPPENWOLF encountered the same experience as "*The Magic Theater*". Although mantras do play a role the actual advanced techniques taught by Yogi Ramaiah seem more in tune with the methods of western alchemy.

movement to Nina Hagen, the German Rock Singer. Babaji's picture even appears on the album jacket of the Beatles, SERGEANT PEPPERS LONELY HEARTS CLUB BAND. In the vast realm of human imagination, what myth could possibly be more attractive to the ego than that of physical immortality?

Yogi Ramaiah offers the world a unique biography of this immortal saint. Babaji was born in 203 A.D. near the sanctuary of Chidambaram. At an early age he was kidnapped, sold into slavery and then purchased by a wealthy man who freed him. Babaji was thus absolved from the responsibilities of caste and family. He soon fell in with a group of advanced wandering sages who trained him in contemplative methods of self-realization. In his wanderings Babaji studied with Bogar at Katirgama in Sri Lanka and at Courtrallam with Agastyar. He finally achieved the highest yogic realization at Badrinath near the Himalayan border. Is there an echo here of the story of Christian Rosenkreutz who sets off as an orphaned youth on a pilgrimage to the Holy Land and falls into the company of mysterious adepts who train him in ultimate wisdom?

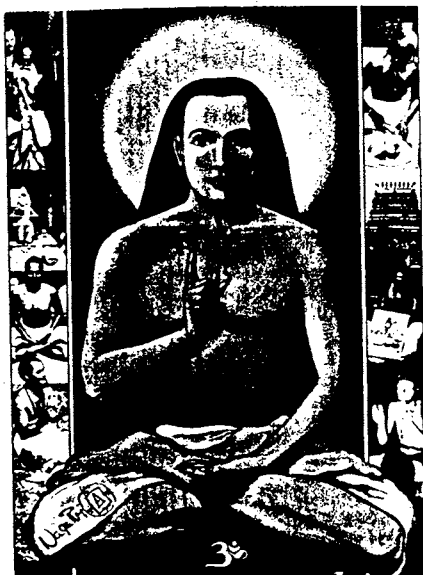

Yogi Ramaiah has so far avoided becoming a personality cult by shifting attention to his own guru, "Babaji", the immortal Yogin made famous in Yogananda's AUTOBIOGRAPHY OF A YOGI. This shadowy character remains a premier figure among that semi-mythical category of perfected immortal saints which include personages like Harikhan Baba and Bagwan Lakulisa. These beings allegedly inhabit remote regions of the Himalayas, emerging on rare occasion to reveal the more esoteric level of yogic attainment.

In recent times "Babaji" has become a New Age band wagon that everyone delights to jump on, from Sondra Ray and Leonard Orr, the father of the rebirthing

OM KRIYA BABAJI
NAMA AUM

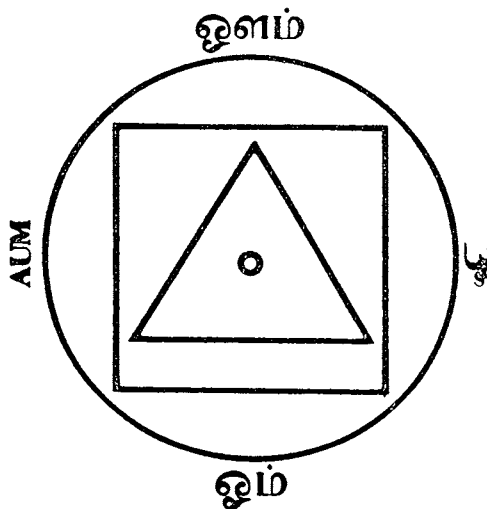

A most intriguing enigma might arise from consideration of Babaji's yantra, a geometric device used along with mantra for invoking the master's grace and guidance. This yantra consists of a triangle situated in a square in turn circumscribed by a circle. It calls to mind a number of 17th century western alchemical diagrams. Notable examples include the final engraving from Heinrich Khunrath's AMPHITHEATRUM SAPIENTIAE AETERNAE (4), the seventh key of Basil Valentine's TWELVE KEYS and the Rosicrucian seal on the diploma presented to Dr. Bacstrom by a mysterious

adept in 1794, published in Manly Hall's, **ORDERS OF THE GREAT WORK-ALCHEMY** (5). Stanislas Klassowski de Rolla explicates the meaning of Khunrath's emblem:

"Syzygy or conjunction of the macrocosmic Unity with the microcosmic triunity. The entire process of the elaboration of the Philosopher's Stone is symbolized here...(4)."

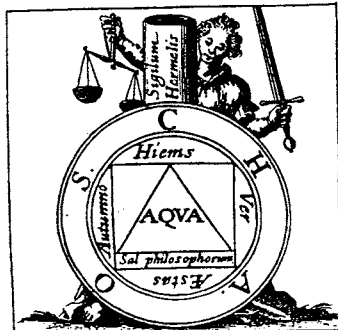
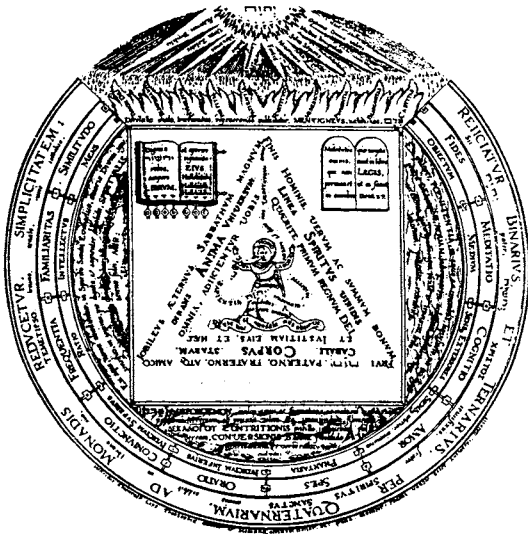

Handwritten text in Latin script, likely a transcription or commentary on the engraving above.

Handwritten text in Latin script, likely a transcription or commentary on the engraving above.



—From a copy of the last page of the Baetstrom Rosicrucian diploma. Dr. Baetstrom signed the article of the Society, and it was certified by the Comte du Chazal, F.R.C.

Most of the Hermetic adepts carried certain credentials by which they could identify themselves when need arose. These were exhibited only to such as were qualified to demand proof. Sometimes the adept bestowed some formal document upon his selected disciple as evidence of initiation. It is interesting that such documents are seldom if ever found on the bodies of the adepts or among the possessions of their disciples. Evidently these diplomas were held in the highest esteem and were destroyed before they could fall into the hands of the profane.

An example of these diplomas will indicate the obscurity which invariably surrounds documents of this kind. Dr. Sigismund Baetstrom, a distinguished student of alchemy, was initiated into a Society of Rosicrucians on the Island of Mauritius, September 12, 1794, by a mysterious adept who used the name Comte du Chazal. Baetstrom received a certificate signed by du Chazal, but the original document, if it has survived, cannot be found. Copies were made,

The history of the Tamil siddhars has yet to be written. Their writings remain scattered waiting for the scholarly treatment they deserve. The task of separating the complex mythic and actual historic biographies of these sages recalls the difficulty associated with penetrating the wisdom of the western alchemical tradition. Scholars can argue even against the historical Jesus but in the end a good dream is more powerful than any historical reality. The perennial wisdom at the root of Rosicrucian alchemy or the Tamil siddhar tradition transcends time and space. It is an ever present guide leading any sincere aspirant into the immortal realm of imagination and its central diadem of self-luminous Gnosis. In the light of Gnosis all sages from every continent throughout history are forever united.

REFERENCES

- 1. Kamil Zvelebil, "The Cittar: An Enigma", chapter 14 of **THE SMILE OF MURUGAN ON TAMIL LITERATURE OF SOUTH INDIA** (Leiden, Brill, 1973), p.218
- 2. Thiru N Kandaswamy Pillai, **HISTORY OF SIDDHAR MEDICINE**, (Madras, Manorama Press, Gov. of Tamil Nadu, 1979), p.254
- 3. Hugh Finlay, editor **INDIA, A TRAVEL SURVIVAL KIT** (5th edition, Hong Kong, Lonely Planet, 1993), p.1011
- 4. Stanislas Klassowski de Rolla, **THE GOLDEN GAME: ALCHEMICAL ENGRAVINGS OF THE SEVENTEENTH CENTURY**, (New York, Braziller, 1988), p.41
- 5. Manly P. Hall, **ORDERS OF THE GREAT WORK-ALCHEMY** (Los Angeles, P.R.S., 1940), p.34

Anyone seeking authentic information on the Tamil Siddhar Tradition should visit the **ARIZONA BABAJI YOGA SANGAM**, 5750 West Eighth Street, Yuma, Arizona, 85364, tel. 602-783-7230.

(Joseph Caezza has been a student of Yogi Ramaiah since 1986. He is a member of the Philosophers of Nature and a registered Pharmacist practicing in Rochester, New York.)

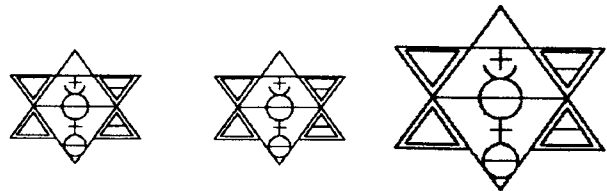

The Tarot: Structure and Use, Part 2

By Ned Darenuith

In our discussion we will talk about three “models” of the Tarot. By a model we mean an intellectual structure which provides guidelines for our interpreting the cards in any particular spread. If you haven’t noticed already there are lots of meanings for each card and it is not always easy to tell which one to use in a given reading. Using the models given here and specifying the type of information for which we are looking can go a long way to clarifying which meanings should be used to answer a particular question.

The first model which we will consider is what I call the functional model. It uses the tarot as a map to processes of change and transformation. It can be used to tell us where we stand in a growing process, whether it is a the growth of a business, or of our own spirit the Tarot can tell us where we stand.

The next model which we will consider is what I call the “situational” model. The idea here is that the Tarot can be used to tell us the exact situation in which we will find ourselves. Each card is used to describe something that may happen to us. These situations may be good or bad, pleasant or unpleasant, and that leads us to the third model which I call the “Qualitative” model. The qualitative model is used to decide what qualities an experience will have and as such is used a lot with the functional model to decide whether one wishes to go through that phase, or at least if it happens to be unavoidable to forewarn us of unpleasant consequences so that we can try to mitigate them as much as possible.

Reading the Tarot Cards

In actually reading the cards there are a few ideas to keep in mind in order to get the most out of a reading. The first thing to do is to remember that you are a translator and need to pay attention to the vocabulary and the grammar of the language from which you are translating. In the tarot the cards are the words which make up the vocabulary and the spreads are the grammar.

The idea that the cards are a vocabulary, that they are like the words in a foreign language seems clear enough, but what do I mean by the spreads as being like grammar? A spread is in some ways like a sentence, in particular it is like a sentence in a non-inflected language like English or German, as opposed to an inflected language like Latin. Now why do I say that a tarot spread is like an English or German sentence rather than a Latin one? Because in English or German the order of the words in the sentence is important to the overall meaning. In a sentence of English

for example the noun (and its modifiers) is always the first part of a sentence, the verb then follows it and is in turn followed by the direct object and if applicable the indirect object finishes it up. Changing the order of the words in a sentence will completely change the meaning of the sentence. This is different from say Latin where because of the declension of the nouns we can always tell what part a word plays in a Latin sentence by the ending which is put on it, which varies depending on whether it is a noun or direct object or what. Thus a Latin sentence is position invariant and maintains its meaning no matter how you arrange the words as long as you leave the endings alone.

In the Tarot we are in a position not unlike Chinese, in which not only is there no declension of nouns to indicate whether it is a subject or direct object, but there is no conjugation to indicate tense either! We must once again use the order of the cards to give us a clue as to whether what is indicated by the Tarot “words” happens in the past, the present or the future. All of this will be determined by the spread and the way the cards are set out. I hope that these ideas are leading you to realize why you always write down all details of every spread, because each detail has meaning for the ultimate interpretation, and big differences can hang on minor points!

How to Treat Your Cards

Treat your cards like a wise and respected friend, and be sure to talk to them often. What do I mean “Talk to them”, I mean just that, aside from consulting them often in order to develop rapport with them, you should just talk to them as if they were a person who was sitting there with you. When you take your cards out of their box say hello to them, and then ask them (nicely!) to help you find out what it is that you need to know. Then explain to them who or what it is that you are asking about, just as you might explain it to a person whose advice you sought. Explain exactly what information it is that you are seeking and tell the cards what spread you will use in order to get this information. Especially if this spread is new to you and your deck explain what each position in the spread is supposed to mean and the order in which the cards will be dealt into that spread. You should also decide in advance how many times you are going to shuffle the cards and tell the cards that also, in that way they will know how long they have to prepare an answer. And of course when you are done with the cards be sure to thank them! All of this may seem rather strange but it will work and if you follow these rules you will for whatever reason find yourself getting much better results sooner than a person who does not use them.

Choosing and interpreting spreads

Generally speaking it is best to avoid large spreads, especially when you are first starting this is particularly important because they can be so confusing. There are other reasons for avoiding them also and they have to do with information theory. There is of course a strategy for using large spreads which we will deal with later. For the time being we will concentrate on the strategy with small spreads. Most of the small spreads are for getting information on a single issue but the techniques which we will teach as we go along will allow one to get a great deal of information which will usually be very accurate.

As mentioned earlier there are three Models which provide complementary information. Each of these may be used to get a different view of the same thing. Let me give you some concrete examples. The functional model gives information about process and its unfoldment. It can be used to tell you where you are in a project. The functional model is value indifferent, which means that the cards themselves are neither good nor bad, pleasant or unpleasant. Though for some reason or another you may find the fact that you are at one stage of development than another or that the structure you are building may be weak in one area or another to be very unpleasant, however no such value can be gathered from the meaning of the card itself, that must be the result of further inquiry. As an example the Three of Swords represents a situation in which one is just getting one's intellectual foundations set in the functional model. It could be a turning point, for example, in a new area of study where suddenly you have insight into the basic principles and see where all of this is leading. You have not mastered the subject and you still have a long way to go, but you have set the center from which everything will grow. What qualities this experience will have, whether it will be quick or slow, easy or hard, pleasant or not depends upon the course of further inquiry.

The second model, the situational model, is used to give specific information about events and will tell you the general type of events to expect. Many of the events will be good or bad or some will be indifferent, some judgment can be given by the card itself, but to be more reliable it should be looked into more. To return to our example of the Three of Swords. As a situation it represents social isolation, however appearing with other cards it may indicate a welcome vacation to the mountains for retreat, or it could be a heartbreaking situation of loneliness and sorrow.

The third model is the qualitative model and it is derived from the situational model by taking the qualities that usually accompany the situation represented and applying them as descriptive modifiers. Once again to return to the Three of Swords, on a qualitative level it is unpleasant,

isolated and generally disagreeable. A meaning closely related to the qualitative is that of personal characteristics, here we see the qualitative as applied to the description of a person. The Three of Swords describes a person who is lonely and isolated.

In the third part of this essay (*see Stone #16*) will be given a more or less complete summary of the meanings of the cards from each of these perspectives.

Now let us see how we should go about doing a reading. The first thing to do is to decide upon a question. Be very careful about the wording and when you have finished write it down exactly as you have decided. Always write down the Date and time of the reading and if you move around a lot the place. The idea behind writing down the time and place of a question is to allow you at some later time to go back and do an analysis of it through Horary Astrology. Not only does this give you a chance to study and master Horary Astrology at the same time as the Tarot, but it may be useful to get more information or confirmation. For example if a Horary chart erected for the time of a question indicates the same general trends as the reading then you have a double confirmation of your reading, but if it seems to indicate the opposite then you should be very wary about the Tarot reading, especially if it is to be the basis of important actions.

After you have decided on the question, you should decide upon a spread. Each spread gives somewhat different information, and depending on what type of information you are seeking you will want to choose a different spread. The ubiquitous "Celtic Cross" Spread is useful for general purposes and that is one of the reasons why it is ubiquitous! However, there are occasions in which some of the positions which are used in the Celtic Cross spread will be useless to your inquiry, or may not give you the information which you desire. In that case you will want to try other spreads.

Next you need to determine the Significator. There are many ways in which one can determine a significator. Usually one chooses a Court Card since one is usually either asking about a person or for a person and that is often the easiest way to go about the matter. On the other hand if one is asking about a specific event which can be successfully characterized, one can choose one of the cards to represent it. For example in inquiring about a legal matter, one could use Justice to ask about the verdict and Judgment to ask about the punishment or reward arising from it depending on whether it was civil or criminal, etc.. We will deal later with the various ways which can be used to get a significator from the court cards.

The next thing to do is to put the significator back in the deck of cards, after you have explained to the cards that the significator is to be used to represent the object of inquiry and that its position in the deck after it has been shuffled is to represent the beginning of

(Continued on Page XXII)

Pow-Wow, Psalms, and German Magical Folklore

by Mark Stavish, M.A. © 1993

(reprinted from Mezlim, Samhain '93)

For the majority of people the term "Pow-Wow" is often exclusively associated with Native American shamanistic practices; however, for a small group of Americans it has a uniquely European meaning.

I don't remember the first time I heard the word "pow-wow" as it has to some degree always been a part of my upbringing. It was not until I was 12 or 13, however, that it became a meaningful force in my life, at the time of my conscious spiritual instruction and development. It was my maternal grandmother and her brother, my great uncle, that told me of the stories of their father, Augustus Tischler, and how he "pow-wowed" for them and others whenever they were injured, ill, or in need of help. With psalms, oils, water, breath, the Sign of the Cross, and laying on of hands, he was able to perform seemingly "magical" acts and "miraculous cures" for those to whom he rendered his services.

It is not exactly clear at what point he began his training as an apprentice in this uniquely German Christo-centric magical system of healing and "altering circumstances according to one's Will" although it was under a relative, and uncle, that its culmination took definite form and power.

Based heavily on Biblical passages, corrupted kabbalistic ideas, Divine Names, traditional uses of rhyme, incantation, oil, water, touch, and sheer belief, pow-wow has developed and survived for centuries (out of the Middle Ages) in German communities in Europe and North America. Like many similar folk traditions, its strongest adherents were, and still are, in the rural farm villages and regions where simple, direct, and meaningful spirituality was needed as a part of daily life. While pow-wow is not a secret, with most people knowing a little themselves or someone who can "pow-wow for them", it is a private affair in many respects and, as a result, has kept much of its oral traditions.

My great-grandfather's teacher would have by any magical or mystical system been considered highly adept at his craft and well suited to pass on his information to willing students. To those who knew him privately and semi-publicly, in his native eastern Germany (pre-1900 borders), he was known as "Wachendseele" or "The Awakened Soul". The nearest equivalent that I know of for such a title would be "Illuminati" or "Adeptus Minor" in the full sense of the title. He had, to those around him, attained the sphere of Tiphareth. The stories that exist describing his power are

few, but significant within the context of the pow-wow tradition: He possessed a magical book and was able to contact the living and instruct them consciously after his transition (death).

The book was similar to others within the tradition, in that while they are often able to close themselves when "they" don't wish to be looked at by a non-initiate, this book in particular was able to "freeze in place" anyone who did not have permission to view its contents. This was something Augustus personally experienced on one occasion, much to his surprise! With the accompanying "I told you so!", he was released from its power. Like many modern and ancient "Book of Shadows", these books are handwritten, few in number, and passed down along family lines or to a worthy student. There is also the suggestion that he may have belonged to one or more truly secret societies and been versed in the higher hermetic or mystical-magical teachings of the period.

Unfortunately, there is no known definition for the word "pow-wow". My great-uncle has told me that it is "a very old word, going back to biblical times", but nothing more. Some have suggested that it may have gotten its name after local contact with the native tribes in North America. However, no substantial answers to the origin of the phrase exist. Prior to immigrating to America, my great-grandfather had no contact with the Pennsylvania Dutch and none after arriving. He used no other phrase to describe what he did; it was simply "pow-wow".

Other phrases that denote a practitioner of the art are varied even in their translations, denoting the particularly familial and regional nature of the different practices that comprise the tradition. Even the understanding of one who is a "pow-wow doctor" changes, particularly among the Pennsylvania "Dutch" of Germans, one of the few places where this ancient folk art is still practiced to some degree. For some, "pow-wow" is simply as I have used it here, a healing art, or a magical belief system. For others, it is black magic and one who practices healing is a "Braucher" or "braucherei". In German "braucher" is tradition or custom, in the same sense as *kabbalah* is tradition in Hebrew; it can be used to denote either a secular or spiritual activity, or both. Here, we get some insight as to the Medieval origins of pow-wow.

In other systems within the tradition, a "braucher" is one who works almost exclusively with herbs, but still in a healing capacity; but one who practices the black magic is

a "hexerei" or "hexer". However, a "hexenmeister" can refer to one who paints hex signs common among the Pennsylvania Dutch. About these signs, E.G. Alderfer writes, "We know little about these forms and motifs except that they must have been developed in the dim Germanic past as symbols of spiritual or mystical elements now lost to memory." The words can also refer to various levels of magical attainment as we will later see in the Mennonite community, for example.

Among the things given to me by my grandmother was a list of Biblical Psalms, their accompanying Divine Names, and their use in healing and magic, as well as the "celebrated SATOR Square" which she claimed her father used to cure rabies.

It is understandable why the Psalms would be used, for not only did they contain the necessary Words of Power as many kabbalists know, but they were also used extensively among the illiterate and barely literate member of Medieval and later 17th, 18th and 19th century European and American society. The Psalms were said often at various stages of the liturgical year for both Protestants and Catholics. They were often memorized and already known to some degree.

Other Bible passages were also used, especially Ezekiel 16:6 for stopping the flow of blood. My grandmother swears by Ezekiel and her slightly blood stained Bible attests to such use. If this passage was not readily available, then the following "charm" could also be used to stop the bleeding:

Jesus Christ Dearest blood
That stoppest the blood
In this help (name of person)
God the Father, God the Son,
God the Holy Spirit Amen!
Help to this!

The fear of fire was a significant part of pre-twentieth century rural life. A swift fire could destroy a farm and its surrounding structures rapidly. To avoid this, or to contain it after it had started, many invocations and magical acts were employed, among them the use of the SATOR Square. I am told that one day when a flat, tar topped factory one structure away from where my grandmother and her brother lived caught fire, Augustus Tischler put it out with some such device.

As the fire began to rage out of control, and roofs were being hosed down to prevent the flames from leaping, he sat stubbornly on his porch staring at the flames with his iron teutonic will. His family pleaded with him to go inside as the heat was too intense, but he stayed, murmuring to himself over and over again. His reply was simple, "It will

not spread!" He stared at the flames as they fed on the black tar that comprised the roof, and then as surprisingly as it had begun, the fire began to diminish and die away.

To prevent fires from occurring, or to extinguish it once it had started, the SATOR Square was often employed. It was written on both sides of a plate and thrown into the fire. When placed as a protective device on or in the building to be protected, it is called "Ein Brief" or "Himmelsbrief" or "Heavenly Letter". Similar plates or "letters" were enclosed within the walls of the Ephrata Cloister. This series of structures, now maintained by the Pennsylvania Historical Society, was one of two communities established in the late 16th and early 17th centuries by German mystical Pietists, believed to be Rosicrucians, seeking to establish a commune in "the Wilderness" and await the Second Coming. Material from this group may have filtered into popular pow-wow practices and might be the source of its more alchemical, astrological, and High(er) magical elements.

Julius Sachse, the definitive authority on the early Pietist and Rosicrucian movements in America, states that not a single building was accidentally lost to fire where these plates or "letters" had been installed. Several buildings were destroyed purposefully to prevent the spread of infectious diseases during the Revolutionary War.

The idea of the "Himmelsbrief", or "Letter Written by God Himself" dates to the early Christian era; however, most of those in circulation date from one of several found in 18th century Germany, such as those of Holstein, 1724, or Magdeburg, 1783.

Another method, used in Somerset County (PA) was the following charm:

"Father God, please place a wall of living flame around (fill in the blank) for protection against danger, harm, accident, evil, illness, or fire."

The belief in the effects of the moon, and use of the various phases of the moon, waxing especially, is also an aspect of this art. One of many applications is to look at the increasing moon and say: "What I am looking at, increase. What I am rubbing, decrease," for warts, goiters, or any unsightly growths. My great-grandmother repeated this for her goiter, and it is also found in some of the pow-wow books that have been printed for general circulation. Moon cycles are also used for the planting, harvesting, and blessing crops. The preparation or herbal treatments, magical items or tools, and execution of magical activities also are effected by the cycles of the moon.

Among those books most easily found today and used in earlier days are John George Hohman's Der Lange

Verborgene Freund ("The Long-Lost Friend") published in Reading, Pennsylvania in 1819, and still in print. Hohman's "Friend" is second only to the Bible in importance to pow-wow practitioners. The next book or books is *The Sixth and Seventh Books of Moses* referred to as one volume. This collection of apocryphal writings is said to contain the highest magical teachings of the tradition. While most people (such as one's grandmother or grandfather) could do some simple charms, and a few could qualify as pow-wow practitioner or "pow-wow doctors", only the highest and most magically powerful could qualify as being able to do the charms and spells contained in this collection of writings.

In German Mennonite communities, there exist three levels of practitioners. Those who comprise the last are those who are considered to have given themselves over completely to the practice of their art and to either its application for the Will of God, or for temporary, selfish, Faustian gains that will cost them their sanity and their souls.

According to my grandmother, her father was familiar with these writings and capable of employing them when he wished. Her brother mentioned to me, that they, like many magical devices, are neutral and can be used for either healing or harm. This is the difference from general pow-wow, which is specifically a healing art.

Yet, somehow, within this framework of spells, charms, and mystic and magical sigils, those who practice pow-wow have, for the most part, always considered themselves "good Christians". Farm, church, and family are what essentially comprise the Pennsylvania German communities. The church has tolerated the existence of these practices, but couldn't eliminate them from the social order as they too deeply reflect the "imminent presence of God" in daily life. The constant scriptural references, affirmations of faith, and regular Sunday service attendance only made it that much more ingrained into the popular psyche on some level. If anything, the changing social structure of late 20th century America, the rapid decline of family and communal farming, and the encroaching bulldozers of suburbia into Southeastern Pennsylvania farmland have done more damage than any ecclesiastical bans.

The Pennsylvania Germans who came to this country, when it was Penn's Landing that recruited and welcomed them, were escaping the hundreds of years of religious wars and persecutions that plagued their homelands. This is reflected in their devotional zeal and millennialistic outlooks. It was the idea of the "New Atlantis" that fueled Johannes Kelpius and Conrad Beissel.

This mixture of over forty different European sects and regions that make-up Pennsylvania Dutch culture, what unites it, and is reflected in its native spirituality, with

pow-wow being but one expression of that, is the desire for spiritual, albeit mystical, longing (Sehnsucht) and the Time of the Lily (Lilienzeit) or Second coming. The shared common oppression united them, and forged literally a new people and a new language in America. Catholic piety, French Quietism, Eckhart, Boehme, folksongs, pastorals, Sufi, Kabbalistic, and theosophical adoration for the Virgin Sophia and her Heavenly Bridegroom fill the simple folk culture and spirituality of the Pennsylvania Germans and their other North American brethren.

Yet, while I am not of Pennsylvania Dutch extraction, I feel an immediate kinship with their beliefs and ideals. The power of their folk beliefs, even though many of them are pure superstition and holdovers from a truly more ignorant age, has a magnetic quality to it that let me know some of it rings true. The mystical longing, community beliefs and ideals, and waiting for the time of the Lilienzeit with each setting sun, run deep within me.

References

The Ephrata Commune: An Early American Counterculture by E.G. Alderfer. University of Pittsburgh Press, 1985.

German-American Folklore (American Folklore Series), ed. Mac E. Barrick. August House, Inc., Little Rock, AK, 1987.

"Convention, Power and Self in German Mennonite Magic" by James Martin Nyce. Doctoral Thesis, Dept. of Anthropology, Brown University (Providence, RI), 1987.

The German Sectarians of Pennsylvania 1742-1800 by Julius F. Sachse (Philadelphia 1910).

Pennsylvania Dutch Folk Spirituality (Sources of American Spirituality Series) ed. Richard E. Wentz. Paulist Press, Mahwah, NJ. 1993.

Special thanks to Dr. Robert Mathiesen, Dept. of Slavic Languages, Brown University.

IMPORTANT ADDRESS CHANGES!

PON Administration:

The Philosophers of Nature
125 West Front Street, Suite 263
Wheaton, IL 60187 U.S.A.
Phone: 708.682.3938 Fax: 708.665.2364
Email: alchemy@mcs.com
WWW: <http://www.mcs.net/~alchemy/>

Editor of The Stone:

Ken Miller, P.O. Box 161213, San Diego, CA 92176.
Email: StonePON@aol.com

Only a few copies left!

Attention Students of Qabala and the Western Mysteries...

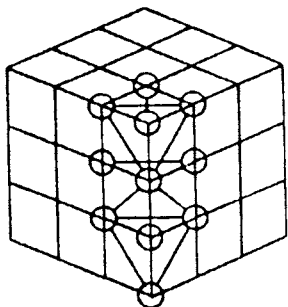

"In the study of Qabalah there is no more important glyph than the Cube of Space..."

Paul Foster Case

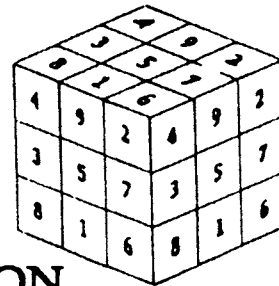

THE CUBE OF SPACE: THE CONTAINER OF CREATION

a book by Kevin Townley

Topics include:

- * Generation of the Cube of Space through geometry.
- * The Magic Square of Saturn.
- * Relationship of the Cube to the Tree of Life.

- * Placement of the Tarot (Minor Arcana) on the points of the Cube.
- * The Cube's relationship to the Macro and Microcosm.
- * The Cube of Space in the Four Worlds.

To order send \$45.00 plus \$3.00 for postage to
Archive Press, Box 11218, Boulder, Colorado 80301.

"As Above, So Below"

When you understand the process of Divine Creation on the macrocosmic level, you can apply those same principles on a personal (microcosmic) level!

The Philosophers of Nature unveil...

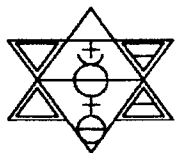

The O.R.A. Project OCCULT RESEARCH & APPLICATION

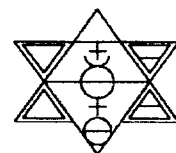

P.O.N. has for the last few years maintained a research group to work on various laboratory alchemy projects. Now we wish to form a group of those members who are interested in participating in research projects involving magic, kabbalah, and various other occult subjects.

Our first "face to face" meeting will be held during the 5th Annual PON Seminar in Colorado Springs, CO May 27-31. See page 15 for details on the seminar.

Try to be there!

If this interests you, please send a self-addressed stamped envelope to: Ken Miller, Post Office Box 161213, San Diego, CA 92176; or e-mail Ken at StonePON@aol.com

(You will receive a questionnaire that will allow us to assess your interests and talents. Any suggestions for research projects will be cheerfully considered.)

WANTED: The ORA project is looking for an English and/or Hebrew copies of The Book of the Angel Raziel (Sepher Raziel; also titled Raziel ha-Malach). An English translation is known in the British Museum: Sloane No. 3826. If you have a copy or translation please contact the ORA project. Thank you.

The Philosophers of Nature 5th Annual Seminar "Alchemists of the Rocky Mountains" Colorado Springs, Colorado. May 27-31, 1996

Join Us in Colorado

We are pleased to announce our 5th Annual Seminar. We believe that Colorado Springs will be a striking natural setting for our work. The second largest city in the state, Colorado Springs is located at just over 6,000 feet above sea level, at the foot of Pike's Peak, which rises to a majestic 14,110 feet.

All seminar events will take place at:

**The Franciscan Center
at Mount Saint Francis**
7765 Assisi Heights
Colorado Springs, CO 80919

Registration begins at Noon on Monday, May 27th. The seminar ends at 1:30 PM on Friday, May 31.

This seminar is open to members and non-members alike.

The Presenters

Special guest, Jean Dubuis, with Dr. Tamara Brandon, O.M.D., Kathy Gabor, Marcus Haubenstricker, Russ House, Kurt Kobylarz-Schmidt, Patrice Malézé, Kenneth Miller, Kevin Townley, Bill Van Doren, and others to be announced.

The Program

The programs include various topics on Magic, Qabala, Alchemy and Spagyrics. The Philosophers of Nature reserves the right to make necessary changes in this program. Unforeseen circumstances may result in the substitution of a presentation topic or speaker. You can always get the latest on the Internet...

Registration Fees

Members: \$495.00.

Non-members: \$575.00

NOTE: A member is someone who has paid their dues thru 12/31/96 or later, since the time we began an annual membership fee in 1994.

Contact Information:

Questions About The Conference:

Kevin Townley at 303.443.8199, or
Wade Coleman at 719.598.8126

Registration & Payment Information:

Sue House, Office Manager
The Philosophers of Nature
"CONFERENCE"
125 West Front Street, Suite 263-w
Wheaton, IL 60187 USA
Phone: 708.682.3938 Fax: 708.665.2364
Email: alchemy@mcs.com

Need a registration form, or the latest information?

Want help renting a car or finding local information?

Use the Internet...

<http://www.mcs.net/~alchemy/>

With links to Colorado Springs visitor information, weather reports, direct access to car rental and airline web sites, and the latest updates to the schedule.

He's back!

(THE LAST GREAT ALCHEMIST IN PRINT)

ALCHEMICAL WORKS:

Eirenæus Philalethes Compiled

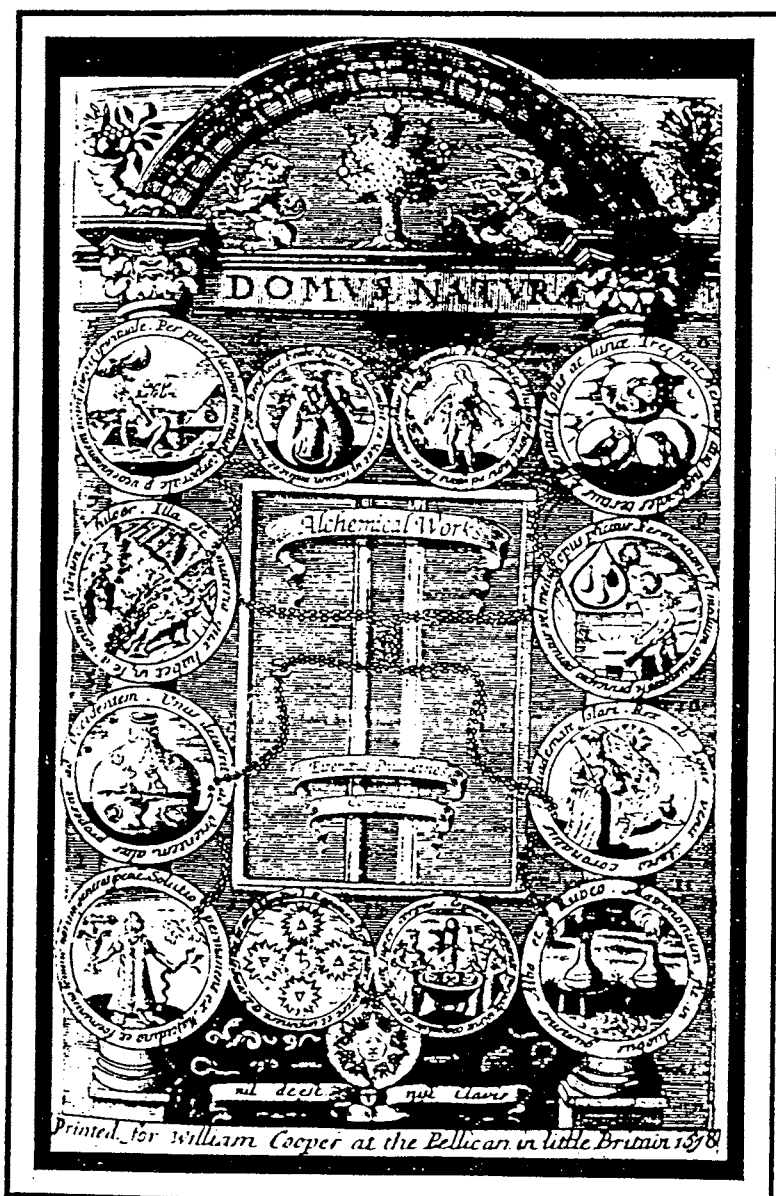

hard cover 592 pages indexed a.f.p. ISBN 0-9640067-0-7 \$60.00

\$65.00 U.S. Postage paid to:

LPN-USA

Box 11218

Boulder, CO. 80301

Eirenæus Philalethes, mysterious alchemical adept of the seventeenth century has elicited intrigue, study, and controversy for historians, littérateurs, and scientists since these works were published beginning in the mid-1600's.

This volume is unique. It is the only to contain all Philalethes' works currently available in English, and it is indexed.

Original format has been carefully preserved throughout, offering readers access to complete, authentic, and legible text and content for their enjoyment and studies, without having to resort to the microfilm copies previously available to most readers as the only source for much of the text contained within.

The practice of alchemy has been perennial for all of written history, woven through one civilization and into the next, often tying them together. It is a science, a philosophy, a mystery, and a quest. The very word connotes a magic transcending our limited beliefs about the laws of nature. It was used as a tool of charlatans, who did much through their deceit to destroy the reputation of the science. Much more often it has been a field of study for great minds. C. J. Jung spent his last twenty years illustrating its value in framing the workings of the subconscious through alchemy's rich use of metaphor. Sir Isaac Newton poured over Philalethes' tracts, finally preparing what he thought to be *Philosophic Mercury* in 1675.

The essence of alchemical writings has been consistent through the centuries, while the details have been inscrutably and defiantly deceptive. Philalethes is called the last great alchemist in print. This collection presents a treasure map for many uses.

ORA ET LABORA

Vol. 3 No. 1

© 1996, The Philosophers of Nature. All rights reserved.

March, 1995

NEWS FROM THE PHILOSOPHERS OF NATURE RESEARCH GROUP

THE EDITOR'S CORNER

by Russell House

The 5th Annual Philosophers of Nature Seminar in Colorado Springs is the best opportunity we will have in 1996 to exchange ideas and techniques, and laugh over our infinitely large ignorance of the workings of Nature.

A primary part of the mission of the association to provide people with access to those tools that they can use to accelerate their own evolution. The organizers of this seminar (primarily Kevin Townley and Wade Coleman) have arranged for a number of members to make presentations at the seminar in May. This group of members represents, at best, just a small percentage of the experience and wisdom that the association can offer.

It is my belief that every person who attends such an event can actively assist in making the seminar more successful, and thereby contribute to furthering the mission of the association.

This is pretty simple. There is no one who knows nothing, no one without insight. Much of the value of these seminars has been in the 'informal program' that takes place between scheduled events, at meals, and in the animated discussions that go well past midnight.

Every person who asks questions, who shares a technique they have discovered, who lets people know where to find useful texts and materials adds to the success of the seminar.

We hope that all of the readers of this newsletter will consider coming to the seminar, and that they will also come with an open mind and open heart, with a willingness to give as well as to receive. It can be a good exercise to look for opportunities to encourage

people in some way -- this engenders an attitude of Service, which can bring numerous rewards for all concerned.

The association will falter if we become dependent on being spoon-fed and take everything we are told and everything we read (including in the lessons) as truth. There are no masters here with all of the answers. If we are looking for them in the association, we will be sorely disappointed. It is not enough to be passive, and to repeat the phrases we have memorized, or the facts we have gleaned from the lessons.

At some point, it is mandatory that we do something. The lessons and presentations at seminars offer starting points for your own work. The work does not need to be complex to be beneficial. The observation and contemplation of Nature can be enhanced by structured work in a laboratory, or during a ritualistic working in Qabala, but it is also of value to begin using the refined sensibilities and eyes of the imagination (not fantasy), to watch the workings of Nature around you.

For example, one might study the mythological attributions of the Greek and Roman dieties and begin seeing how the people in your life express some of these qualities, in their mannerisms, in their expressions, and in the functions they perform. After some success, it is useful to examine one's self and see which of the resonances of energy symbolized by these god forms are more active in you. This may provide some seeds for meditation and suggest practical opportunities for your own work of evolution. At least, the equipment is not expensive!

Ora et Labora!

Spagyrics Lesson 8 - Revised

by Russ House

When lesson 8 of the Spagyrics Course was being rendered from French into English, the translator, Brigitte Donvez, encountered a difficulty. The lesson was primarily a chart of plants and their planetary rulers. Some of the scientific names used in the French lesson did not correspond to those used in the reference books available to the translator.

At present, we are looking over the lessons, and making improvements that make them more legible, complete and correct. Since some of the references were in question, the lesson was published with the unresolved entries identified. In the effort to resolve these issues, the entire section was proofread and several texts were used to resolve the problems.

Culpepper's Complete Herbal, by Nicholas Culpepper, W. Foulsham & Co. Ltd., England. This was the primary text, since it was apparently the source for the creation of the table in the original lessons. Even this classic text is not without error. For example, All-Heal, is identified as *Prunella vulgaris*. It is a plant 5 to 6 feet tall according to the description of Culpepper, and is under the dominion of Mars. In the same text, Self-Heal, a low-creeping herb, typically not more than a foot high is under the rulership of Venus. It is also identified as *Prunella vulgaris*. This error leads me to believe that the Latin names for the plants are a later addition to the text. Such errors are not numerous but must be considered.

Culpepper's Color Herbal, edited by David Potterton, Sterling Publishing, NY, 1983. This book draws heavily on The Complete Herbal, with the addition of modern medical references and color illustrations of the plants. It proved helpful since the Latin names of plants are indexed, whereas they are not in The Complete Herbal. Devil's Bit, described as 'venereal' by Culpepper under "Government and Virtues" was listed as 'not ascribed to a planet or astrological sign'. Venereal herbs are under Venus, just as jovial herbs are under Jupiter, and martial herbs under Mars.

Also of value was The Alchemist's Handbook by Frater Albertus, Samuel Weiser, 1981. This text gives charts which are intended as a list of attributions

assigned by Culpepper in his Complete Herbal. It is a good check list, and yet it has a few flaws. In several instances, two plants are printed on the same line, such as "vine viper's bugloss" and "sage samphire". In other cases, a two-part name is printed on two lines, such as "benedictus cardines". Further, Albertus lists Buck's Horn Plantain under Saturn. While Culpepper was not explicit about this species of plantain being under Venus along with the common plantain, it would be uncharacteristic for him to neglect mentioning a ruler changing within a plant species. There is no indication, at any rate, that it should be under Saturn.

J. M. Nickell's Botanical Ready Reference, Trinity Center Press, CA, 1976, is an extensive cross reference by scientific name and common name. This proved very useful, as did A Modern Herbal by Mrs. M. Grieve, Dorset Press, NY, 1992. In addition to having indices by scientific and common names, it offers complete descriptions of the plants, and cites Culpepper. This combination of features proved helpful in making some decisions.

The original French Spagyrics lesson was also an important resource. This edition has a French to English table of plant names which sorted out some problems. It is not included in the English-language lessons, since it is not common for English readers to use French-language references for identifying plant names. There were a few instances when plants were assigned to planets in error. These were generally because of naming problems: the Latin names of plants have changed from time to time with reclassifications by botanists, and often the species name used by the editor of Culpepper's Complete Herbal, is not a common species in France. I think that there were less than 5 or six such instances.

The list of plants in the lesson was corrected to agree with Culpepper, and to use the most widely accepted Latin name according to the references I have cited. That Culpepper was the original source is apparent because there were not more than two plants in the original lesson that were not classified by Culpepper. Further, the choice of plants is unusually like those

ORA et LABORA - March, 1996

catalogued by Culpepper, including many plants rarely available and therefore not in common use today.

It is worth noting that the Spagyrics lesson does not include all of the plants catalogued by Culpepper. The omissions are most notable under Saturn, the ruler of many highly toxic plants. For example, hemlock, henbane, black hellebore, and nightshade are not listed. NOTE: These plants are dangerous. This was done, presumably, for reasons of safety, since the lessons are received by people beginning practical work in spagyrics, and there is no reason for them to consider choosing any of these plants for their work. I

SATURN

1	Hordeum sativum	Barley
2	Fagus silvatica	Beech
2	Lotus corniculata	Bird's Foot Trefoil
1	Symphytum officinalis	Comfrey
1	Centaurea cyanus	Cornflower
1	Cuscuta epithymum	Dodder of Thyme
1	Ulmus	Elm
1	Polypodium vulgare	Female Fern
2	Fumaria officinalis	Fumitory
1	Aegopodium podogaria	Goutweed, Goat-Herb
2	Trientalis Europaeae	Green (Winter), Chickweed Wintergreen
1	Equisetum arvense	Horsetail, Shave Grass
1	Centaurea jacea	Knapweed
1	Polygonum aviculare	Knotgrass
1	Mespilus germanica	Medlar Tree
2	Verbascum thapsus	Mullein
1	Viola tricolor	Pansy
1	Populus nigra, P. alba	Poplar, Black And White
1	Plantage psyllium	Psyllium
1	Capsella bursa pastoris	Shepherd's Purse
3	Polygonatum multiflorum	Solomon's Seal
1	Asplenium ceterach*	Spleenwort, Common
1	Tamarix Gallica	Tamarisk
1	Bupleurum campestris	Thorough-Leaf, Hare's Ear
1	Androsaemum officinale	Tutsan

mention this here, only to be somewhat complete in discussing how this lesson was re-edited.

Note about the charts:

The number in the first column is meant as an indicator of the relative safety of the plant:

1. Plants which may be used with without special precautions
2. Plants which should not be used without an extensive study of documentation about the plant
3. Plants which are dangerous or toxic and should be used only with great caution.

SATURN - Continued

2	Osmonda regalis	Water Fern or Osmond Royal Fern
1	Epilobium	Willow Herb
3	Taxus baccata	Yew

JUPITER

1	Agrimonia eupatoria	Agrimony
1	Smygium olusatrum	Alexanders
1	Asparagus officinalis	Asparagus
1	Melissa officinalis	Balm
1	Vaccinum myrtillus	Bilberry
2	Borago officinalis	Borage
1	Myrrhis odorata	Chervil
1	Castanea vesca	Chestnut
1	Potentilla reptans	Cinque-Foil, Five-Finger Grass
1	Tanacetum balsamita	Costmary
1	Triticum repens	Couch Grass, Dog Grass
1	Taraxacum officinalis	Dandelion
2	Rumex, spp.	Dock
1	Chicorium endiva	Endive
1	Figus carica	Fig Tree
1	Asplenium scolopendrium	Hart's Tongue Fern
1	Sempervivum	Houseleek
2	Hysopus officinale	Hyssop
1	Carduus marianus	Lady's Thistle
3	Anemone hepatica	Liverwort
1	Pulmonaria officinalis	Lungwort

JUPITER - Continued

1	<i>Spiraea ulmaria</i>	Meadowsweet
3	<i>Melilotus officinalis</i>	Melilot
2	<i>Quercus robur.</i>	Oak
1	<i>Rosa canina</i>	Rose: Wild Briar Rose, Dog Rose
2	<i>Salvia officinalis</i>	Sage
1	<i>Crithmum maritimum</i>	Samphire (Small)
1	<i>Colchlearia officinalis</i>	Scurvy Grass

MARS

2	<i>Berberis vulgaris</i>	Barberry
1	<i>Ocimum basilicum</i>	Basil
3	<i>Juniperus sabina</i>	Creeping Juniper, Savine
3	<i>Ranunculus bulbosus</i>	Crowfoot, Buttercup
1	<i>Linum usitatissimum</i>	Flax, Flax Seed, Linseed
2	<i>Allium sativum</i>	Garlic
2	<i>Gentiana, spp.</i>	Gentian
1	<i>Crataegus oxyacanthus</i>	Hawthorn
2	<i>Gratolia officinalis</i>	Hedge Hyssop
2	<i>Humulus lupulus</i>	Hops
1	<i>Cochlearea armoracea</i>	Horseradish
1	<i>Rubia tinctorum</i>	Madder
1	<i>Imperatoria ostruthium</i>	Masterwort
2	<i>Urtica dioica</i>	Nettle
1	<i>Allium cepa</i>	Onion
3	<i>Bryonia dioica</i>	Red Bryony
2	<i>Rheum hybridum</i>	Rhubarb
1	<i>Centaurea calcitrapa</i>	Star Thistle
3	<i>Nicotiana tabacum</i>	Tobacco
1	<i>Dentaria bulbifera</i>	Toothcress, Toothwort
3	<i>Artemisia absinthium</i>	Wormwood

SUN

2	<i>Angelica archangelica</i>	Angelica
1	<i>Fraxinus excelsior</i>	Ash
3	<i>Laurus nobilis</i>	Bay Laurel
1	<i>Echium vulgare</i>	Blue-Weed Or Viper's Bug
1	<i>Sanguisorba officinalis</i>	Burnet
2	<i>Chelidonium majus</i>	Celandine (Greater)
2	<i>Centaureum cyanus</i>	Centaury (Small)
1	<i>Anthemis nobilis</i>	Chamomile (Roman)
1	<i>Trifolium cordatis</i>	Clover (Heart Shaped)
1	<i>Euphrasia officinalis</i>	Eyebright

SUN - Continued

2	<i>Heliotropium grandiflorum</i>	Heliotrope
2	<i>Juniperus communis</i>	Juniper
1	<i>Levisticum officinalis</i>	Lovage
1	<i>Calendula officinalis</i>	Marigold
2	<i>Rosmarinus officinalis</i>	Rosemary
2	<i>Ruta graveolens</i>	Rue
2	<i>Crocus sativus</i>	Saffron
2	<i>Hypericum perforatum</i>	St. Johnswort
1	<i>Potentilla tormentilla (+)</i>	Tormentil (See warning).
1	<i>Juglans, spp.</i>	Walnut
(+)	Contact with iron or steel causes tormentil to become toxic.	

VENUS

1	<i>Cynara scolymus</i>	Artichoke
1	<i>Rubus fruticosus</i>	Bramble
2	<i>Anchusa officinalis</i>	Bugloss
1	<i>Arctium lappa</i>	Burdock
2	<i>Nepeta cataria</i>	Catnip
1	<i>Cicer arietinum</i>	Chick Pea, Garbanzo Bean
1	<i>Tussilago farfara</i>	Coltsfoot
2	<i>Ligustrum vulgare</i>	Common Privet
1	<i>Galium cruciata</i>	Crosswort
1	<i>Scabiosa succisa</i>	Devil's Bit
2	<i>Lepidium sativum</i>	Dittander, Pepperwort
1	<i>Spiraea filipendula</i>	Dropwort
1	<i>Ribes glossularia</i>	Gooseberry
1	<i>Ajuga reptans</i>	Ground Pine, Bugle
1	<i>Alchimilla vulgaris</i>	Lady's Mantle
1	<i>Althea officinalis</i>	Marsh Mallow
2	<i>Mentha spp.</i>	Mint
2	<i>Chrysanthemum leucanthemum</i>	Ox-Eye Daisy
1	<i>Pyrus communis</i>	Pear Tree
1	<i>Vinca major & V. minor</i>	Periwinkle
1	<i>Primula officinalis</i>	Primrose
1	<i>Sanicula, spp.</i>	Sanicle
1	<i>Brunella vulgaris</i>	Self Heal, Heal All
3	<i>Rumex acetosa</i>	Sorrel
1	<i>Verbena officinalis</i>	Vervain
1	<i>Fragaria vesca</i>	Wild Strawberry
1	<i>Alchillea millefolium</i>	Yarrow

MERCURY

3	Solanum dulcamara	Bittersweet Nightshade
2	Calamintha officinalis	Calamint
1	Carum carvi	Caraway
1	Daucus carota	Carrot
1	Apium graveolens	Celery
1	Anethum graveolens	Dill
1	Inula hellenium	Elecampane
2	Foeniculum vulgare	Fennel
3	Mercurialis annua	Good Henry, English Mercury
1	Corylus, spp.	Hazel Nut
2	Lonicera caprifolium	Honeysuckle
1	Marrubium vulgare	Horehound
1	Lavandula officinalis	Lavender
1	Glycyrrhiza glabra	Licorice
3	Convallaria majalis	Lily Of The Valley
1	Adiantum capillus	Maidenhair (Common), Also Asplenium (White Maidenhair)
1	Morus, spp.	Mulberry
1	Avena sativa	Oats
1	Parietaria officinalis	Pellitory
3	Anthemis pyrethrum	Pellitory of Spain
1	Alliaria officinalis	Sauce-Alone, Garlic Cress

MERCURY - Continued

1	Satureia hortensis	Savory
3	Artemisia abrotanum	Southernwood, Lad's Love
1	Meum athamanticum	Spignel, broad-leaved
2	Majorana hortensis	Sweet Marjoram

MOON

1	Brassica oleracea	Cabbage
1	Stellaria media	Chickweed
1	Salvia sclarea	Clary Sage
1	Galium aparine	Cleavers
2	Lactuca sativa	Common Lettuce
1	Cardamina pratensis	Cuckoo Flower, Lady's Smock
1	Cucumis sativus	Cucumber
1	Iris versicolor	Iris, Blue Flag
1	Lysimachia vulgaris	Loosestrife
1	Hieracium pilosella	Mouse Ear
1	Saxifraga tridactyles	Saxifrage
1	Pimpinella saxifraga	Saxifrage
1	Veronica officinalis	Veronica, Speedwell
1	Trapa nutans	Water Chestnut
2	Nasturtium officinalis	Watercress
2	Lilium candidum	White Lily
1	Salix	Willow

Plants for Essential Oil Distillation

recommended by Russ House

In the article above, I have cited several texts that present correspondences between plants and the planetary energies. In addition to these another book has additional information: *The Practical Handbook of Plant Alchemy*, by Manfred Junius, Healing Arts Press, VT, 1993. It often gives information not available in Culpepper's text, and often does not agree with his attributions of rulership.

Many students of Alchemy and spagyrics want to distill essential oils from the plant material to make plant stones according to various methods. Not all plants contain significant amounts of essential oils. The following list gives plants with relatively high essential oil content.

Sun	Rosemary	1.0 - 2.0%
Moon	Clary Sage	0.8 - 1.0%
Mars	Coriander seed	0.8 - 1.0%
Mercury	Caraway seed	3.0 - 5.0%
	Lavender	1.4 - 1.6%

Jupiter	Anise seed	2.0 - 3.0%
	Juniper berry	0.2 - 2.0%
	Hyssop	0.8%
Venus	Peppermint	0.1 - 1.0%
Saturn	Cypress	1.3 - 1.5%

the reading. I like this idea because it gives the significator something to do. Other authors just have you put the significator down and shuffle the cards I think that the process of putting the significator in the deck is much more realistic because it imitates the fact that the person inquired about is immersed in the flow of events.

The cards should be shuffled and dealt and then one should make a preliminary judgment based upon how the cards appear in the spread. If this reading seems pretty straightforward then you can stop here after recording your results. If you find that parts of a reading seem contradictory or ambiguous then the following procedure can be used to "amplify the signal". Put all of the cards back into the deck, making sure that none of them fall next to each other and then ask the cards for more information in order to clarify the message. There are two ways that you can now proceed one is to shuffle the cards and when done go through the deck and pick out the cards of the original reading and the two cards on either side of them. One must be careful not to disturb the original order of the cards, because it is easy to miss one of the cards the first time through and if you do miss it and mess up the order of the cards you will not get the real message. Here's what I mean by not messing up the order. Suppose while going through the cards you discover one of the cards from your reading then you must take it out and mark the place say by putting each new subsection at right angles to each other and putting the cards which you have removed in the order that they came out of the deck. In essence you have to preserve the information about where each of the card triplets came from because if you miss one on the first run through then if it happened to be separated by one card from one of the other cards in the original reading which you found in your first run through unless you have preserved the proper order you will not get the true cards which originally were on either side of your card but rather the card that was three cards over.

This way will provide lots of information, and is in many cases satisfactory, however there is another method which gives even more information and that is to distribute the deck in the order of the astrological houses. This is done simply as follows: The cards are dealt from the left hand corner down in a circle into twelve stacks. The fourth stack should be the bottom of the circle and the seventh stack should be in the right hand corner. The Tenth Stack should be at the top of the circle. Now you should go through each one of these stacks of cards and check to see if one of the original cards from the reading showed up in that stack. If you find one of the reading cards then turn it over to mark it for further reading and if there is no card from the original reading in the house pile then ignore it. Once on learns the house meanings this can give one a great deal of information because not only does it qualify the meanings of the original cards but tells you in what area of life it is likely to manifest. In essence you are killing two birds with one stone.

Having found out which house the cards from the original reading show up in you will want to record all of the information about each pile. So record the cards from what is now the bottom up (remember it used to be the top?). Next make a record of each of the cards from the original reading and which cards show up around them and in what house they were found. Your reading will be based upon this information but you can get more information about what's going on in each house by using the techniques of Pairing and Counting.



End of Part Two, Continued in Stone #16

“Who Do I Contact When...

I have questions about my membership?"

I have problems receiving my lessons?"

I would like to subscribe to The Stone?"

I need back issues of The Stone?"

Contact Sue House, PON Office Administrator: Philosophers of Nature, 125 West Front St., Suite 263, Wheaton, IL 60187;
Phone (708) 682-3938.
Fax (708) 665-2364.

Email: alchemy@mcs.com

World Wide Web:

<http://www.mcs.net/~alchemy/>

I have an article or letter for The Stone?"

I have advertising for The Stone?"

Write, call, or e-mail the editor: Ken Miller, P.O. Box 161213, San Diego, CA. 92176. Fax (619) 275-3442.

E-mail: StonePON@aol.com

Please Note: MAILING YOUR INQUIRY TO THE WRONG ADDRESS COULD DELAY MATTERS FOR MONTHS.

• About The Stone

The Stone is published three times a year in March, July, and November, primarily for the benefit of the membership of the Philosophers of Nature. We hope to get members' feedback regarding what they would like to see in it. Articles, photographs, drawings, letters to the editor, and comments from members or others are solicited for submission to the Editor for evaluation. Submissions and advertising should be sent to Ken Miller, P.O. Box 161213, San Diego, California 92176. E-mail may be sent to StonePON@aol.com. Deadline for submissions and advertising are as follows: February 20th for the March issue; June 25th for the July issue; October 25th for the November issue.

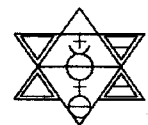

• Advertising

The Stone accepts advertising for both display and classified ads. Rates are as follows: Full page: \$100.00; Half page: \$60.00; Quarter page \$35.00; Classified ads are \$0.10 per word. For more information write the editor, Ken Miller at the address listed above, or e-mail him at StonePON@aol.com

• Subscription to The Stone & Membership Information

The Stone is included in the cost of membership. Non-members may subscribe at the rate of \$20 per year (three issues). Subscription requests and any questions about membership should be sent to the administrative headquarters: Philosophers of Nature, 125 West Front Street, Suite 263, Wheaton, IL 60187. You may leave a message for the office manager at (708) 682-3938.

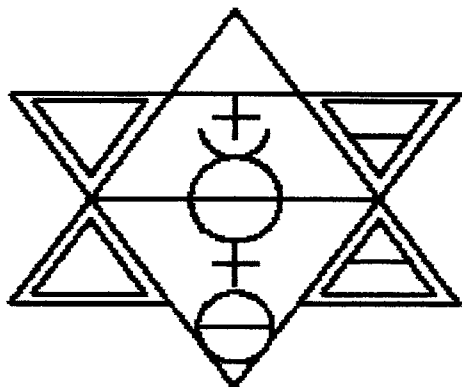

The Stone

Journal of The Philosophers of Nature

Issue Number 16

July 1996

Did they confect the Philosopher's Stone? An updated report on 20th Century testimony (c) 1995, 1996 by Tim Scott

(Ed.'s Note: This article is a substantial update to a previous piece published a few years ago in The Stone. The Ingaleses legacy has puzzled many an alchemist; and often they would come up in conversation when the subject turned to twentieth century alchemists who had "made it." Frater Albertus was known to have said that the Ingaleses were alive and well in India. Curiously, a few years after Frater died I received a phone call from someone who "knew" that Albertus was actually alive and well in India, having successfully made the stone of the wise. I was fascinated that the myth making had begun so soon and in such earnest (such was the tone of my caller). What follows is the result of much detective work, and while perhaps sobering in its conclusion, it serves to clarify an important part of early 20th century American alchemical history. Personally, I always thought it was weird that they had attained such success by concentrating on the work of Paracelsus. Read and Enjoy.)

INTRODUCTION.

In spite of the mountains of alchemical literature and history that have been written over the centuries, credible testimonies of personal experiences are still extremely scarce. If you limit them to 20th-century references you definitely have a candidate for one of the Shortest Books In The World.

This is not too surprising, perhaps, considering the enormous discipline and difficulty of the Great Work of alchemy. Further, it's not difficult to understand why someone who had developed a technique to cure all diseases, confer immortality and change common metals into precious would be somewhat reticent about his

accomplishments. Accounts of people who have attempted the Work and failed are equally scarce.

In This Issue...

Did They (Really) Confect the Philosophers Stone? An updated inquiry

by Tim Scott page 1

Report from PON Annual Conference, May 1996 in Colorado Springs

by Wade Coleman page 7

Meditations on the Cube of Space

by Kevin Townley page 9

Hermeticism and the Golden Fleece

by Joseph Caezza page 15

Mudra and Rosicrucian Healing

by John Eberly page 18

BEGINNING THE SEARCH.

With this background, I was originally led to the story of Richard and Isabella Ingalese by a sidebar in the "Alchemy" article of the (landmark) occult encyclopedia, *Man, Myth and Magic*, originally published in 1970. In this, they claimed, in 1927, to have not only suc-

The Stone, Issue Number 16, Jul. 1996. Published in March, July, & November by the Philosophers of Nature. Editor: Ken Miller. Subscription details on page XXII. © 1996 Philosophers of Nature.

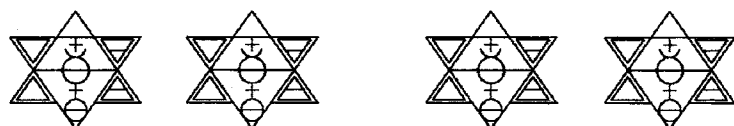

ceeded in confecting the Stone of the Wise, but even used it to resurrect a woman dead 30 minutes. This intrigued me no end, since there was no sequel to the story I could easily discover, and yet here they were, in Los Angeles no less (just 120 miles from my home). Why was no one interested in following this story up?

In my view, that sidebar was notable as much for the questions it left unanswered as for the incredible assertions it made. So I resolved to try to find out the story of this intriguing couple.

A few years after that, I was visiting the Mayflower Bookstore in Michigan (which was one of the finest occult bookstores I've ever visited) where I managed to acquire a reprint of Richard Ingalese's notes for a public lecture he gave on alchemy in 1927. (Originally published in Los Angeles by the J. F. Rowny Press, 1928. My reprint was one of Frater Albertus' "Golden Manuscripts" series in 1973 with the title "They Made the Philosopher's Stone." Art Kunkin has a copy of this as well as one of the original edition. On my request he compared them and reported to me that the reprint appears to contain the same information as the original.)

I also acquired (in person, at the Library of Congress in Washington, D.C., no less) a copy of an article on the Ingaleses, which appeared in the Nov. 1928 issue of the *Occult Review*. This contained more fascinating clues, the substance of which appears below.

[Totally irrelevant digressive anecdote about this article follows: I located the reference for the article in a periodical index first, which stated that it was printed in March 1928. When I requested the issue from the Library, and looked up the issue, the article was nowhere to be found. This was very dismaying, as I had only minutes left before the Library closed, and the next morning I had to leave the city. Leafing through the bound volume of the issues for the year, by pure chance I happened on the November issue which *did* have the desired article! When I think how close I came to missing it...]

In *The Occult Review* article, Mrs Ingalese explained to author Barbara McKenzie how she and her husband became interested in alchemy: "The years after middle life began to draw on, when much reading of works on alchemy left her in grave doubt as to whether the writers were dealing with a spiritual or a practical discovery...Mrs Ingalese frankly told me that at this time her primary interest in a possible discovery was to stay advancing age and perhaps add another score of working years to man's so-called allotted span." The couple then moved to Los Angeles

-I could not discover exactly why--for the express purpose of attempting to create the physical Philosopher's Stone. A suitable house was acquired and a laboratory outfitted, as they pored over the available books and manuscripts to choose a course of action. Everyone who has studied alchemical literature knows it is fraught with blinds, symbolism, hidden meanings, contradictions and omissions. Mrs Ingalese's psychic gifts proved to be of value as they winnowed the material.

Their original goal was to create the Oil of Gold. But, in Richard's pamphlet describing their work, he wrote, "...gold at \$240 a pound is an expensive thing to experiment with; and, after a while it dawned on us that the principle would be the same if we used copper at 15 cents a pound. So the experiments were transferred to the cheaper metal." (Compare to the cost of gold today! But the ratio of its cost to that of copper is approximately 4500:1 whereas the figures quoted above show a ratio of 1600:1.)

After three years of painstaking labor and a steady draining of their financial resources, Mrs Ingalese produced the first success: the red oil of copper. Richard wrote (in "They Made..."): "We thought that victory was close at hand, but found it was still some years away. The fifth year gave us the oil of sulphur, but not until we had many fires and explosions and two asphyxiations." I wonder what their neighbors thought of this! "The sixth year produced the oil of mercury, the basis of all Alchemy...By this time we had sold all our securities and had two mortgages on our home, but had determined to continue with the work until we met with success, if it took this life and all subsequent ones. But we had all the oils required to make the Stone, and, thus encouraged, we tried to crystallize and fuse them. In 1917 we succeeded in making the White Stone of the Philosophers." The Ingaleses continued the time-honored tradition of using animals to try new drugs. "We dared not try it on ourselves at first. But there was a third member of our family, a beautiful Angora cat of which we were very fond. We took a vote to see which of the three should test out the Stone, and the cat, neglecting to vote, was elected. It survived the first dose, and we repeated it on the following two days, with the cat becoming more frisky than usual...After that we tried it ourselves, each taking a dose at the same moment so we would incarnate together if it should prove fatal. But it proved beneficial and energized our bodies."

The writer for the *Occult Review* was less hesitant to sample the Stone. When Mrs Ingalese asked her if she would care to see and taste the Red Stone she wrote,

"I willingly accepted." She then goes on to describe how Mrs Ingalese "[dipped] a silver knife in the bottle and quickly restoppering it, placed the smear--it was little more--on my tongue, saying it must lie there and not be swallowed. I immediately noticed an intense bitterness, which is said to be the gold, but other metals I could not detect. In two or three seconds it had been absorbed or dispersed, so that not even a flavour remained in my mouth."

Returning to the account in Richard's lecture: "Encouraged by this success, we redoubled our efforts to make the Red Stone of the Philosophers, which is the one most mentioned in Alchemical writings. This effort was continuous from 1917 to 1920, when our quest was rewarded." Apparently, the Ingalese's work was supported in a more than verbal way: After creating and potentizing the Red Stone, Richard writes: "There were several elderly people whom we were under obligations to help in case our search proved successful, and we offered to share the results of our efforts with them; but, being wisely cautious, they preferred to wait until we had tried out the Stone for a year."

I am presuming they obtained investors for their work, in exchange for the promise to share the fruits of it with them should the experiment succeed. Perhaps these same investors held the said mortgages on their home; this information is still being researched. If these mortgages were legally recorded, the records will probably be retrievable from the County of Los Angeles.

"After that, our renewal club was formed and we all took the magic medicine ...Mrs Ingalese and I have not done as well as some of the other members of the group because of the condition we were in when we commenced the treatment. From 1911 to 1920, [the couple was then aged 57-66 and 49-54] though having the knowledge and the means to keep our bodies healthful we did not use mind or any medicine in that behalf because, we could not have known what effect the Alchemical products would have on us. From a physiological viewpoint, those were important years in our lives, since our bodies had reached an age when strict attention and care were necessary to prevent quick deterioration. But, even under those conditions, our bodies now attest the power of the Stone, as all who have known us for the last two decades can testify."

As to the Stone's efficacy, Richard makes some interesting observations: "...we tried the stone on many 'incurables.' The number of cases cured was remarkable, but we found it not infallible...We know

that the Stone restores virility in men at any age, and normal desire in both sexes..."If a woman has recently passed her change of life, it restores all normal functioning of the sex organs. But, if she has long passed that period, then, childbearing is out of the question."

Ms McKenzie adds: "The cure of a case of cancer, given up by all the doctors, was also claimed. After a few doses the disease was said to be arrested, and after some months' treatment was completely cured."

"I did not verify these statements," cautiously notes Ms McKenzie, "but record them as given." Richard also mentions: "...incredible as it may appear, I know of one alchemist more than 600 years old, and one whose age is more than 400, and another whose age is 200, and all of these look and function as do men in the prime of life at about 40 years."

THE DEAD RAISED.

But even this is not as astonishing as his matter-of-fact description of the resuscitation of a dead woman, the wife of a prominent local physician.

"Half an hour had elapsed and her body was growing cold. A dose of the dissolved White Stone was put into the mouth of the corpse without perceptible result. Fifteen minutes later a second dose was administered and the heart commenced to pulsate weakly. Fifteen minutes later a third dose was given and soon the woman opened her eyes. In the course of a few weeks the woman became convalescent, after which she lived seven years."

WHAT NEXT?

This is incredibly tantalizing and, prima facie, unbelievable. But what purpose could be served by Ingalese fabricating this story? Surely there must be some corroborating material somewhere. A whole host of other questions suggest themselves: What did the resuscitated woman finally die from, and at what age? What caused her to die in the first place? What other techniques (if any) were used to attempt to revive her? Why wasn't the Stone used again in the second place? Richard ended his pamphlet stating that, even at their advanced ages of 67 and 73, both he and his wife looked and felt young and extremely healthy.

"This is our testimony in behalf of Alchemy and the Alchemists, which each person may accept, or reject, according to his conviction, until such time as our bodies, now 67 and 73 years of age, respectively, by

their youth and vigor, will compel acceptance of our statements."

And then...? Besides Richard's statement, and the Occult Review article, I found none but passing mentions of the Ingaleses in the occult literature of the next 40+ years, until the above mentioned Man, Myth and Magic article. Even Cockburn's book, though published in 1940, makes no mention of them even though as practicing alchemists, you would think he would have had some interest in researching their techniques.

DID THE STONE GRANT THEM IMMORTALITY?

Unfortunately, the reality seems to be more prosaic. Research in Los Angeles records by kind volunteers unearthed the death records of both Isabella and Richard. It would be romantic to imagine that they faked their deaths and are living under different names in India, but the death certificates of both of them (which contain plenty of corroborating facts, such as the attending doctor's statement, history of their illness, results of autopsies performed, and details of the interment. If this is all a massive conspiracy, it's perfectly done.

Isabella died of "chronic myocarditis" in May 1934, and Richard of "pulmonary edema, senility" and related causes in October of that year. His death certificate shows him under a doctor's care starting about a week after her death. I actually have L A County certified copies of these certificates. [I'm going to eventually put all the info contained in them in an Appendix.]

Richard's death was reported by his nurse Paul Hamilton, who was the executor and beneficiary of his will. In the Will as recorded, this was "in recognition of the many services [Hamilton] performed" for both the Ingaleses. Inheriting Richard's estate was apparently not an unmixed blessing, as there was a \$5000 lawsuit against it. The 440 acres in San Diego in the Ingaleses name was granted to the plaintiff to satisfy that suit, and Hamilton conveyed their L A house to another person after that.

I am still trying to find more information about Hamilton. I have tracked him through the L A phone books for several years after Richard's death, then lost track. I don't have any proof for it, but I think he never married. (Part of the difficulty here is the commonness of his name.)

So now my researches are aimed at answering some of the following remaining questions. What happened

to their laboratory, their notes, and--for that matter--their stock of the White and the Red Stones? Is it possible that there is a cupboard in some old house or building in L.A. containing some vials of a panacea or an elixir of immortality? What about the other members of the "Renewal Club"? Would it not be enlightening to learn their later histories? What about the multi-centenarian alchemists Richard claimed to know? Did Richard and Isabella have any students carry on their work? If so, who were they? Did they publish anything?

I asked these questions of anyone I met who was interested in alchemy, but nobody knew the answer. One or two veteran alchemists remarked that they had heard that the Ingaleses had lived in New York previously, and that a preliminary search of L. A. records came up empty.

Frater Albertus, in the introduction to his edition of Richard's pamphlet, loftily states, "We are not greatly concerned here with the individuals known as Richard and Isabella Ingalese nor to their whereabouts up to the nineteen thirties and thereafter."

Here I must disagree with the revered Frater. Are we not, indeed? Perhaps I am too inquisitive for my own good, but it seemed to me that it would be intensely interesting to a practical alchemist to learn more about two of the incredibly few people who ever explicitly claimed have succeeded in the Great Work.

OTHER RANDOM BITS AND PIECES OF THE PUZZLE.

The first interesting thing my research revealed is that both Richard and Isabella changed their names after their marriage around 1896. Richard was born Richard Ward in Savannah, Georgia in 1862, and Isabella was born Mary Robbins in New York City in 1854. They lived in several places until 1910, when they moved to California. They spent one year or so in San Jose, then moved to Los Angeles around 1912. Mrs Ingalese was occupied full time as a psychic, healer and teacher, and her husband was a lawyer, who specialized in mining and corporation law.

She must have been married once before, as Richard's bio states that he married "Mrs. Mary Robbins Weller" in 1896.

In addition, they were also avid students of what was then called "New Thought" and wrote a number of books, including "Occult Philosophy" and "The History and Power of Mind," many of which can still be found in used bookstores today. [I will append a

complete bibliography of their writings to a later revision of this paper.] The two or three I've read contain no mention of alchemy at all and indeed are, frankly, indistinguishable to me from countless other "metaphysical" books which authors seemed to crank out in the early 1900s: vaporous metaphysical theories with no practical application.

Ingalese also wrote: "We have never made gold, nor gems. That is a branch that is exceedingly interesting; and when we have the leisure, we shall pursue that part of the art..." Did they ever go on to this phase of the work? Both Richard in his pamphlet and Isabella in her interview seem to be the model of rational, sensible people. They do not give the impression of being fanatics, charlatans or self-deluded. Ms McKenzie writes with admirable conservatism (for an occult writer): "These are big claims, and I was not in the least credulous regarding the matter, for time and direct observation of specific cases alone could justify the statements. But I was impressed by the modesty and care of the statements made by Mrs Ingalese." In fact, Richard gives several examples of charlatans, con-men and misguided seekers in the course of his talk, and makes the commonsensical observation: "If a person poses as a teacher, ask for some evidence of his knowledge before you enroll as his student...No honest man could object to such requirements." He is referring to alchemical teachers specifically, but certainly this is generally true. The next question that arises is: precisely how did they work? It is very difficult to find a clear path through the mass of alchemical literature, and teachers were no doubt hard to find in the early 1900s in Southern California.

The Ingaleses patiently read and collected alchemical books and manuscripts for more than a decade, and after a thorough examination of the available alchemical literature, Richard stated in his lecture that he agreed with this statement: "Some one has said, 'You can destroy all other books on alchemy, for their knowledge and more is contained in the alchemical writings of Paracelsus.'" Mrs Ingalese told the Occult Review's Mrs McKenzie that A. E. Waite's edition of *The Hermetic and Alchemical Writings of Paracelsus* were "the volumes that afforded her the most encouragement and help in her subsequent efforts." But as far as specifics go, neither Richard in his pamphlet nor Isabella in her interview vouchsafed any details.

[Note: Waite's edition of the Paracelsus material was first published in London in 1894, which was reproduced (rather beautifully) by University Press in 1967. I believe there may be a still later Weiser reprint. I am in the process of carefully reading the two vol-

umes to see if I can deduce, from the few clues Richard gave in his lecture, the techniques they used in their work.]

As a woman alchemist, Isabella Ingalese is extremely unusual; in fact none appear in the literature I'm familiar with except as partners or assistants to their husbands. (In fact, a study of these women would be extremely interesting. Nicholas and Perenelle Flamel and Thomas Vaughn and [?] come to mind. I mentioned this to my [then] wife, proposing the title "Alchemists and their women." She immediately retorted that a better title would be "Women and their Alchemists." Touche'!)

"PARACELSIA."

An interesting discovery I inadvertently made was that the Ingaleses recorded a legal document in 1919 in which they intended to form a cooperative community, with 11 others, on a 440 acre parcel of land in rural San Diego county, to be called: "PARACELSIA." This commune did not ever appear to manifest in the form they envisioned. In 1940 the property was acquired by another New Thought writer, Flower Newhouse, and has been operated continuously as a non denominational spiritual retreat. (I visited there and it is quite beautiful.)

A NOTE ABOUT COCKREN.

A tangential sidelight: It is interesting to note another 20th Century Alchemist who claimed to have achieved the Magistry. This was Archibald Cockren, who wrote a small book published in London in 1940. The first 120 of its 158 pages were devoted to historical and theoretical overviews of Alchemy, just as the first three quarters of Richard Ingalese's lecture was an overview of alchemical history and theory. Cockren then describes in a few pages, leaving out large and significant details, his laboratory alchemical work. Nowhere does he mention the Ingaleses, nor is there any indication he was even aware of their work, even though the *Occult Review* article was published in London in 1927. However, there are interesting clues in his writing, which led William Leo, in his 1972 book "Alchemy" to attempt to "fill in the blanks."

Cockren's book would, I think, repay a closer analysis and perhaps that could be the subject of a future article.

CAN ANYONE HELP?

If anyone reading this has any more leads or suggestions I welcome them. Since so far this version of

the paper is only published on the Internet, you who are reading this probably have email. So write to me at:

tims@vigra.com or tims45@aol.com

I welcome all correspondence about the Ingaleses, Cockren or my other research hobby, Franz Bardon.

Appendix A: Information from the Death Certificates of the Ingaleses.

Richard Ingales Sept 2, 1934 (City) No 11497 Vol 342

1. Place of death: dist no 1901 County: LA City: LA Local Registered no: 11497 Street and no: 5429 Hollywood Blvd (place of death) 2. Full Name: Richard Ingales Residence: 5429 Hollywood Blvd 3. Sex: male 4. Color or race: white 5. Widower 5a. If married, widowed or divorced, name of h or w: Isabella Ingales 6. Date of Birth: April 21, 1863 7. Age: 71 years, 5 months, 11 days 8. Trade: atty-author 9. Industry/business where work was done: office 10. Date deceased last worked at this occupation: 1930 11. Total years spent in this occupation: 40 12. Birthplace: Savanah (sic), GA 13. Father's Name: Wm Wade 14. F Birthplace: Savanana GA (sic) 15. Mother Maiden Name: Susan Prendigast (preueligast? hard to read) 16. M Birthplace: Savanna (sic) GA 17. length of residence city: 20 yrs (1914-1934) california: 20 yrs 18. Informant (signature): Paul Hamilton address: 5433 1/2 Hollywood Blvd LA 19. Burial, cremation or removal? Cremation Place: Hollywood Crematory Date: 10/4/34 20. Embalmer License No: 2300 Signature: W. Franklin Farnsworth Funeral Director: Le Roy Bagley Mortuary Address: 5440 Hollywood Blvd. 21. Filed: 10/4/34 22. Date of Death: 10/2/1934 23. Medical Certificate of death: I hereby certify that I attended deceased from 5/22/34 to 10/2/34; that I last saw him alive on 10/1/34 and that the death occurred on the above stated date at the hour of 10pm. The principal cause of death and related causes of importance, in order of onset were as follows: Pulmonary Aeduma Acute (onset 9-30-34) Arterio Sclerosis, softening of brain - senility (onset 9-25-34) Was there an autopsy: Yes Name, laboratory test confirming diagnosis: autopsy 27. Signature B. H. Sprague, MD 6630 Sunset Blvd LA CA

----- Isabell Ingales Jan 16, 1934 City No. 5966 Vol 337 Removals 337-R

1. Place of death: Dist No 1901 Local Registered No: 5966 County: LA City: LA Street and No: L.A. Co. Gen. Hosp. 2. Full Name: Ingales, Isabella Residence: 960 S. Menlo St. 3. Sex: Female 4. Color or Race: Cauc. 5. Married 5a. If married, widowed or

divorced, name of h or w: Richard Ingales 6. Date of Birth: Jan 30, 1856 7. Age: 78 years 3 months 16 days 8. Trade, profession, kind of work: None. 12. Birthplace: New York, New York 13. Father: Unknown 14. F Birthplace City or Town: Unknown State: Vermont 15. Mother Maiden Name: Eliza Hale 16. M Birthplace: City or Town: unknown State: unknown 17. Length of residence city: 22 yrs (1912-1934) california: 22 yrs 18. Informant: LA Co. Gen. Hosp. 1200 N. State St. 19. Cremation place: Hollywood Crematory Date: 5/18/34 20. Embalmer license no: 1990 signature: Clarence O Bagly funeral director: Le Roy Bagley Mortuary address: 5440 Hollywood Blvd 21. Filed: May 17 1934 22. Date of Death: May 16, 1934 23. Medical Certificate of Death I hereby certify that I attended deceased from May 14, 1934 to May 16, 1934; that I last saw her alive on May 16, 34 and that death occurred on the above stated date at the hour of 3 am. The principal cause of death and related causes of importance, in order of onset, were as follows: Chronic myocarditis (onset ?) Decompensation Eedema (onset 2 weeks)

Other contributory causes of importance: Chronic neptiritis

No operation, no autopsy

Name of laboratory test confirming diagnosis:

Physical exam & urinalysis 27. Signature:

J Herbert Marks, MD 815 So Hill St

Acknowledgments: I wish to thank Richard Merlin, Steve Peak, Art Kunkin, Pat Zalewski and a Mysterious Unnamed Other who have been invaluable for either moral support, encouragement, and/or real actual research. Without all of their help this project probably would never have gone very far.

----- History: Originally written 8/1/92, slightly edited 12/18/95. Largely updated between March and August 1996.

----- This file is currently located at: ftp://ftp.vigra.com/special/tims/ingales.txt

You can contact me via email at: tims@vigra.com Or more traditionally at: P.O. Box 19278, San Diego, CA 92159 (USA)

A final note: I intend to make a further sally to the Los Angeles area late October to look up more legal and property records. I am also carefully reading Paracelsus to try to discover more about exactly what procedures the Ingaleses used.



A Report on the Conference at Colorado Springs

by Wade Coleman

After the conference I wrote down some notes while the events were still fresh in my mind. Since I didn't take notes at the conference, I may have forgotten or misunderstood some of the information.

Beat Krummenacher's Lecture

Beat gave a concise lecture on the preparation of Spagyric tinctures as outlined in his book "Spagyric Tinctures - Tradition, Preparation and Usage". His book has been translated into English is available through Archives Press at PO Box 11218, Boulder, CO 80301.

Q: I have some beakers that have Canada Balm coated to the sides. I have used 95° alcohol as well as acetone with no luck removing the deposits.

A: For cleaning deposits on beakers add potassium dichromate with a small amount of sulfuric acid to the flask. Heat GENTLY and lightly swirl the mixture to remove the deposits.

Kurt Kobylarz-Schmidt's Lecture

A lot of stuff on mineral alchemy that was over my head. Other alchemists who work with minerals said that this lecture gave some good clues in working with antimony.

The shape of the Erlenmeyer flask is preferred for the boiling flask for distillation. Its shape compresses the rising steam just before entering and expanding into the glass helmet above.

Angel Water

The Angel Water is collected when the Sun is in Aries (Spring); use potassium carbonate (technical grade is preferred rather than reagent grade, as the reagent grade has been processed to the point that it loses some of its desirable properties) in large flat glass dishes. As it deliquesces collect, save and distill 3 times.

The Water molecule, H₂O is made of 2 hydrogen and one oxygen atom. Hydrogen is the element Fire, and the Alchemical Sun. Oxygen is the element Water and the Alchemical Moon.

The angle formed between the 2 hydrogen atoms is normally 104.5°. This angle can change. Each angular

distance corresponds to a different energy level of Water. One of these angles may be preferable in Alchemy.

[Theoretically, The angular distance between the two hydrogen atoms in water is normally given in as 104.5°, but there are several stable forms of water that have a different angular distance. This distance is a function of the 2 lone pairs of electrons that are in the outer shell on the oxygen atom. The greater the range of these electrons movement the tighter the angle between the 2 hydrogen atoms. As their movement is restricted, the angle between the hydrogen atoms increases. The wider the angle between the hydrogen atoms, the less polar and more volatile the water molecule becomes, that is, the boiling point decreases. It would be interesting to perform a qualitative study to determine if one of these angular distances is predominate in the collected dew when the Sun is in Aries.] (Explanation courtesy of Marcus)

Kurt believes that the Angel Water contains more Deuterium (a radioactive isotope of hydrogen that has a neutron in the nucleus) found in naturally occurring water.

Q: I use a DC 25 watt bulb with a vacuum to slowly sweat over my alcohol over a period of 3 to 4 days. What do you think of using light as a source of heat?

A: Use black body radiation (heat only) rather than direct light for distillation unless light source is FULL spectrum. Paint a coffee can flat black on the inside and out and cover the light source. This should be sufficient.

Q: Does the pollution of the city affect the collection of the dew?

A: Yes and No. Yes it affects it, but nature has a way of balancing things out. Do the best you can with available resources.

Kurt gave the following references in the form of a handout:

American Society of Dowsers
PO Box 24
Danville, VT 05828-0024
(802) 684-3417

Merck Index (chemical reference) - Centennial Edition
 PO Box 2000 RY-200
 Rahway NJ 07065
 (800) 659-6598 ext. 751

Cosmology

Church of E Yada di Shi'ite
 PO Box 139
 Rumney, NH 03266
 603-786-9746
 Send SASE for Catalogue

International Guild of Advanced Science
 2555 North El Cielo Road, Suite 565
 Palm Springs CA 92262

Jean Dubuis

Jean is coming out with some new lessons that outline an alchemical method that operates on the principle of charging specially prepared products with the energies from the occult or black sun.

[The Sun and the planets rotate in an elliptic orbit around a common center of mass. In an elliptic there are two foci, the sun is at one foci and the invisible sun sits at the other.]

This path work starts on the Tree of Life with the sephira Binah and descends down the Tree. Specially prepared products from the 3 Kingdoms (Animal, Vegetable, Mineral) are charged with the energies of the occult Sun when its influence is the strongest.

Rather than go into detail describing this method I will wait for the new lesson sets.

Q: Why is sea salt used in the animal preparation?

A: It is the only non-determined animal product whose preparation does not come with consequences.

Q: Can sea salt be used with Spagyric plant tinctures?

A: The subtle energy radiating from the sun and fixed in hydrogen becomes determined into a kingdom as it descends down the periodic chart. The non-determined form of this subtle energy is found in water because water is composed of two hydrogen atoms. When the undetermined Angel Water comes in contact with a specific salt it becomes determined. That is, when dew comes in contact with potassium carbonate it becomes determined to the Plant Kingdom.

To use sea salt in the preparation of plant tinctures, first collect the Angel Water using potassium carbonate and load the sea salt with this water [after purification].

Row 1	H	Hydrogen (undetermined) Water (H ₂ O)
Row 2	Li	Lithium (Psychic)
Row 3	Na	Sodium (Animal)
Row 4	K	Potassium (Vegetable)
Row 4	Cu	Copper (mineral)
Row 5	Ag	Silver (mineral)
Row 6	Au	Gold (mineral)

Marcus Haubenstricker's Lecture

Marcus described a problem of creating a plant stone from the chemical point of view. During the calcination process, certain volatile salts are altered which raises their pH so they are basic in nature. When these are added to the alcohol it reacts with any residual water creating alkaline conditions. The alkaline conditions may be breaking down the essential oils of the plant to potentially create fatty acid molecules and glycerin. This chemically resembles a soap. Without expensive experimental equipment, it is difficult to determine what reactions are taking place.

Marcus mentioned that John Reid has a book on the internet at <http://www.levity.com/alchemy> that details a plant preparation that may potentially get around this problem.

Marcus also noted that in drying you salt after filtration it is best to keep the heat below 50 degrees centigrade. Plant salts at high temperatures (100°C) tend to react with the glass vessels which cause etching. The etching process introduces silica compounds which contaminate the salt.

Marcus makes Spagyric Essences that are created following Paracelus' system of healing using astrological correspondences, and alchemical methods for capturing the strongest essence of the herb according to planetary rulership. For more information:

Al-Kemi
 500 N. Guadalupe #G510
 Sante Fe NM 87501
 (505) 989-1811

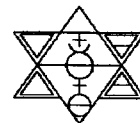

Meditations on the Cube of Space

by Kevin Townley (C) 1995,
adapted from the forthcoming book

In the first book on the Cube of Space there was a lot of information about the Cube, labeling its parts and looking at how the form is generated geometrically. I feel that the work, although a good introduction to understanding the Cube, falls short of being a particle guide to the application of the knowledge.

The following work may well be considered to be an introduction to the first volume. This work is designed to go back into the Cube and share various meditations utilizing the information that was offered in volume one.

Before getting into some of the deeper meditations concerning the Cube of Space it is necessary to address the question, what is the function of the Cube in the first place? The answer lies in the concept of the word container. A container is a form which holds something. That something can take any shape and serve any purpose the filler of the container chooses.

Lets take a very simple idea, jello. There is always room for jello. I remember as a child watching my mother filling the various containers which were decorated in different ways. When the jello congealed it had taken on the shape of the container. Some had ripples in them others had the shape of Bozo the clown. The point is that there was a substance which would take on the appearance of the container it was placed in. The big difference between jello and creation is that the container for the jello is already something you can put your hands on, something you can touch. With the cosmic jello or the prima materia of the alchemists the container is something of an etheric quality. We can however see this container with our minds eye. This container is called a creative image.

In Qabalistic studies a container relates to a particular quality. In the Hebrew aleph-beth the letter \aleph is the fabric of the container. The Hebrew letter \beth , is the boundary which separates that which is within from that which is without. If you could imagine trying to make jello without a container or perhaps trying to carry a gallon of water without something to carry it in you would quickly realize the function of the letter \beth . The result would be jello all over the place and a non expression of jello.

Dr. Paul Foster Case uses a powerful meditation from *The Book of Tokens*, to describe this. It is the opinion of

the author that if we truly understood the qualities of the letter \beth , or even the message given in this meditation, we would have a vast understanding of the need for containers. The meditation is given in its entirety for it will be referred to from time to time.

I am the hedge of protection,
Enclosing the field of existence.

In this field thou dwellest,
And I am thy defense
Against the darkness which is without.

Yet is this hedge of safety
Also a wall of limitation,
And the darkness against which it defendeth thee
Is the radiant Darkness of the Limitless Light,
Too brilliant for thine eyes.
For within the wall of limitation
Is the field of mine activity
In the world of manifestation.
This, also is that which the wise call
The path of the House of Influence,
For into it descendeth the influx of my power..

Because it seemeth to be set apart,
It is also the field of sin and punishment,
Because limitation is the root of failure,
And sin is but the missing of the target of perfection.

Yet as the archer gaineth skill
By reason of aiming again and again at his mark,
Though in the beginning he miss it a thousand
times,
so doth the fruit of sin,
which men call punishment,
Perfect the skill of my chosen ones.

Behold, sin and punishment are one,
And the fire of punishment
Is the fire that refineth my works.
Even in the sinner I am the Actor
And I, too, an the Sufferer
In the experience of punishment.

Thy pain is my pain.
Thy suffering my suffering
Thy sorrows pierce my heart,
Thine anguish is mine anguish.

I Stand not aloof, unmoved,

Watching my handiwork,

As a potter watcheth the clay upon his wheel.

Nay, not so,

For I am the clay,

And the wheel,

And the potter, too.

I am the work, and the worker,

And the means of working.

Take heed lest ye mistake these words.

Be not deluded by false reasonings.

The err who say,

“The Lord is the Doer of All,

Therefore may we do what pleaseth us,

For we can do naught of ourselves

Know that the error of their thought
Is the folly that any man do what pleaseth him.

This false reasoning

Is rooted in the delusion of separateness.

The appearance of separateness

Cometh of necessity from my self - manifestation;

And because nothing can prevail against me,

Even the worst of sinners shall come

In their appointed time, to liberation.

If thou canst grasp it,

That liberation consisteth in the breaking down
and the utter destruction of the hedge of protection

Which encircleth thee, and guardeth thee

From the terror of the Darkness which is without.

For when the work is finished in the field of CHETH
When the Abode of Influence hath served its purpose,

Then shalt thou know, O Israel,

That thou hast naught to fear,

Naught to be guarded against.

Then shall the dreadful Darkness

Be revealed to thy perfected vision

As the flashing radiance of Light Limitless,

And from the Field of sin and punishment

Thou shalt pass,

Into the boundless freedom

Of my divine perfection

The first verse of this meditation refers to the identification of the ONE Being to the “Hedge of protection.” Within this hedge of protection we live move and have our being. If this is a hedge of protection what are we being protected from? The meditation continues to explain that we are protected from the darkness which is without.

On the Tree of Life, there are the ten lights of Divine Emanation. These ten lights continually step down their power so that their energy will not destroy the weaker containers. So we can see this idea of containers serves a multiple purpose. In the first place it is a way of limiting the infinite potential of the Divine Mind. Second it is a way to keep this limited quality safe from being re absorbed back into the infinite radiant darkness.

If the container is a means of protection for its contents, from that which is its source, than that which is within the container is limited in its expression of the source unless it has access to more than what exists within the container.

With this idea of separation from the source we come to all the difficulties that face humanity. Each individual must deal with the illusion of separation. Unless the illusion is reconciled within each individual than that individual will express Divine consciousness in very limited ways. So in one instance the container protects and defines that which is within and at the same time limits the expression or awareness of the contents.

Our teachings in the Qabalah tells us that there is a boundless limitless light, which is referred to as the radiant darkness, which holds all the potential of the universe. It is the boundaries of a container which divides the manifested object from the unlimited potential. Without this container there would be no differentiation between possibilities and a specific center of expression, and nothing could be made manifest. So the letter \aleph which means field or fence sets up the limiting qualities of the Sphere of Saturn, where the No-thing becomes something.

On the Tree of Life, we have learned that the Sphere of Saturn is the first of the spheres to hold a planetary signature. The 18th path of \aleph descends from this sphere of Saturn and connects the sphere of Saturn to the sphere of Mars. This creates a powerful relationship between two planetary intelligences. The sphere of Saturn is the limiting power, while the sphere of Mars is the power of Force and Will. Mars is also associated with the building power as well as the power behind the destruction of form. What is form? Form is the container. So the Mars force, within the container Cheth, has to do with the building and destruction of the limiting power of Saturn within the container cheth. When a form is outworn it needs to be destroyed. When a form is destroyed another more useful form must come in its place.

There is a Buddhist chant which speaks to the need of continually expanding the consciousness of the container.

Gate Gate Para Gate
Parason Gate
Bodi Svaha

This chant speaks to the need to go beyond the present container. After a new frame of reference and our awareness is expanded we work at going beyond that and then going beyond that. This process of expansion continues until we reach the state of Budahhood

The center of Buddhist thought is about transcending the field of sorrow. If we refer back to the meditation on the letter \aleph , we read, "Because limitation is the root of failure, And sin is but the missing of the targaert of perfection." It is only through the continued effort of spiritual practice that we are able to transcend the "Field of sin and Punishment."

We live our lives under the illusion of separation, yet the One Life is continually aware of each of its centers of expression and at no time does it ever lose contact with these centers. On the other hand because of our limited awareness, we live with this feeling of separation from day to day. Unless we are able to expand our containers and let in more and more of the infinite beingness of the ONE BEING, we stop the growing process, feel more separated and therefore more fearful.

As we read further in the Meditation on the letter \aleph , we see, "That liberation consisteth in the breaking down and utter destruction of the hedge of protection, Which encircleth thee and guardeth thee from the terror of Darkness which is without."

Whether we are working with the creative forces in manifesting our hearts desire or we are refining our own containers so that they may become more receptive to Divine consciousness, we work at the balancing between destruction and building, limitation and expansion.

Let us now bring our focus back to the form of the Cube of Space. We begin by placing our attention on the three letters that were used to seal the six directions in space, $\aleph \aleph \aleph$. We already know from our studies that the letters $\aleph \aleph \aleph$ are three of the twelve simple letters associated with the signs of the zodiac. The letter \aleph is associated with the sign of virgo, the letter \aleph , is attributed to aries, and \aleph , is attributed to the sign of taurus. We also know that each of these letters have many other attributions of which a musical note and a color are two. There are several different color scales used in the working with the letters. The Queens or Briatic scale is the scale that will be used in this work. The Hermetic Order of the Golden Dawn and the Builders of the Adytum as well as the Philosophers of Nature use this color scale in their teachings. The reasoning for this is to employ the world of creative imagination to transform the crystallized patterns that keep our vehicles from continually growing in awareness and being the finest centers of expression for the ONE LIFE.

The following chart shows the attributions of the 22 Major Tarot Keys and their correspondence to the Hebrew letters, sound and color.

Tarot Key	Letter	Sound	Color	Name
Key 0	\aleph	E	Light Yellow	The Fool
Key 1	\beth	E	Yellow	The Magician
Key 2	\gimel	G#	Blue	The High Priestess
Key 3	\daleth	F#	Green	The Empress
Key 4	\aleph	C	Red	The Emperor
Key 5	ε	C#	Red - Orange	The Heirophant
Key 6	ε	D	Orange	The Lovers

Key 7	ז	D#	Yellow Orange	The Chariot
Key 8	ח	E	Yellow	Strength
Key 9	ט	F	Yellow Green	The Hermit
Key 10	י	A#	Purple	The Wheel of Fortune
Key 11	יא	F#	Green	Justice
Key 12	יב	G#	Light Blue	The Hanged Man
Key 13	יג	G	Blue Green	Death
Key 14	יד	G#	Blue	Temperance
Key 15	טו	A	Indigo	The Devil
Key 16	טז	C	Red	The Tower
Key 17	יז	A#	Violet	The Star
Key 18	יח	B	Red Violet	The Moon
Key 19	יט	D	Orange	The Sun
Key 20	כ	C	Red	Judgment
Key 21	כא	A	Indigo	The World

The way in which we will begin the meditations on the Cube of Space is from the center.

The center of the Cube is attributed to the letter ט, Tav. The letter Tav among many attributions is associated with Key 21 of the Tarot, rest, inertia, the Sabbath, and the seventh sacred planet Saturn. As discussed at great length in volume one, the planet Saturn and its Magic Square is the matrix for the Cube of Space. This seems to be consistent when we think of how form is generated from a seed from which it is planted. Even though the finished product looks little like the seed as it is placed into the ground, its intelligence is manifested in the outward appearance.

There are many ways in which we can approach the center of the Cube for there are several symbols which speak to the quality of saturn. The letter ט itself is a point of focus. When we use the Tarot, we can see the cosmic dancer poised at the center of the Cube with the letter ט in the lower right hand corner.

We have a powerful symbol that represent the intelligence at the center of the Cube of Space. The center of the Cube of Space is the place where all form comes into manifestation. This begins with the limiting power of saturn .

Before we begin the first meditation it is important to remember the reason for doing these things in the first place. We are aspirants on the Path of Return. In order to accelerate our process in making conscious connection with the Divine One, within whom we live, move and have our being, we must reach for it. This connection is available to all those who aspire to make that connection.

All meditations therefore must begin with the intention of making ourselves receptive to this Divine Consciousness. This begins as Basil Valentine would say "with a certain Heavenly Intention." It is always helpful to have yourself in a protected environment where you wont be disturbed. This is probably unnecessary to say to most readers yet is a gentle reminder just in case you forgot. The time to do these meditations will vary from individual to individual, so you will need to set up your schedule according to your own needs. The most important thing is to set yourself up with a spiritual discipline and be consistent. Inconsistent spiritual work is like going on a diet, and eating two triple cheese burgers with an order of fries and capping it off with a diet coke.

Practice these meditations sitting in a comfortable position. Begin with quiet rhythmic breathing that fills the lungs, including those nooks and crannies that seldom receive the Life Breath and exhaling completely. This should be accomplished without sounding a steam engine that's about to blow a pipe. After a few moments of quieting yourself, you will be ready to start.

Meditation #1

Begin with the intonation of these four Divine Names:

Eheyah	א ה י ה	E-C-F-C
Jehovah	י ה ו ה	F-C-C#-C
Elohim	א ל י מ	E-F#-C-F-G
Adonai	א ד נ י	E-F#-G-F

These names as most of you already know represent the qualities of the Atzulithic world, the world associated with abstract ideas.

We begin by chanting these names in order to attune ourselves to the highest levels of consciousness we are presently capable of contacting.

Following these intonations place your attention on the center of the Cube and the symbols associated with it. If you have any other symbols that add to this idea they could do as well, however, it is vital that you use the proper symbols that truly evoke the consciousness of the intelligence desired.

Place your attention on Key 21 and envision yourself in the center of the Cube of Space. As you do this image the color blue-violet emanating from the center of your being, forming a small cube:



This small cube is in the center of the larger cube and is the 27th central cubic unit of the Macrocosmic cube presented in The Cube of Space. Intone the note A natural to the mantra

ah-oo-um. Repeat the mantra three times.

See yourself emerge from the center and radiating the blue violet light. What is taking place is the formation of a center of expression that will radiate its intelligence to the six directions in space.

The letter א is the still point at the center of the Cube. From that point radiates the six directions in space. This is accomplished through the agency of the three Mother letters א, מ, ש. These are the letters that emanate from the center that was established in the first meditation.

In the Book of Formation, These three letters were used as vehicles to take the power of the One Life and bring its Holy Influence into limitation. Through the movement from the center outward these Mother Letters carried the six permutations of the Holy Name י ה ו ה to the six directions in space and created six of the seven pairs of opposites. The seventh pair of opposites were actually generated in the first meditation. This pair of opposites is **Dominion and Slavery**.

In our journey towards the ONE we must learn to listen to the instruction that comes from the center of our being. This center is synonymous with the center of the Cube of Space. The three Mother Letters ש מ א tells us what we must do, and that is to Hear the message that originates in the center. When we place the order of the Mother Letters as א מ ש, which is actually a reversal in the order in which the six directions are sealed, we have the word Shemiah (א י ש), to listen, or hear. This spelling is minus the letter י. It is interesting to note that the missing letter י is actually present in all of the twenty-two letters.

This second meditation therefore is focused on the idea of listening to the stable and perfect intelligence which dwells at the center of all creation. The symbols used in this meditation are

the three Tarot Keys, 0 The Fool, 12 The Hanged Man, and Key 20 Judgment. These Keys represent the letters **K**, **D**, and **V**, respectively.

Drawing all of this together we can see that the three Mother Letters are the mothers of Air, Water, and Fire. It is through the agency of Akasha, the invisible Alchemical Earth, that which is "תהו ובהו" "formless and void," that these elements come forth into manifestation, and create the boundaries of time and space. Through the mixing bowl of the elements, Akasha, the subtle principle of hearing beckons all aspirants to come to its source and consciously connect with the undistorted beauty of the ONE SELF.

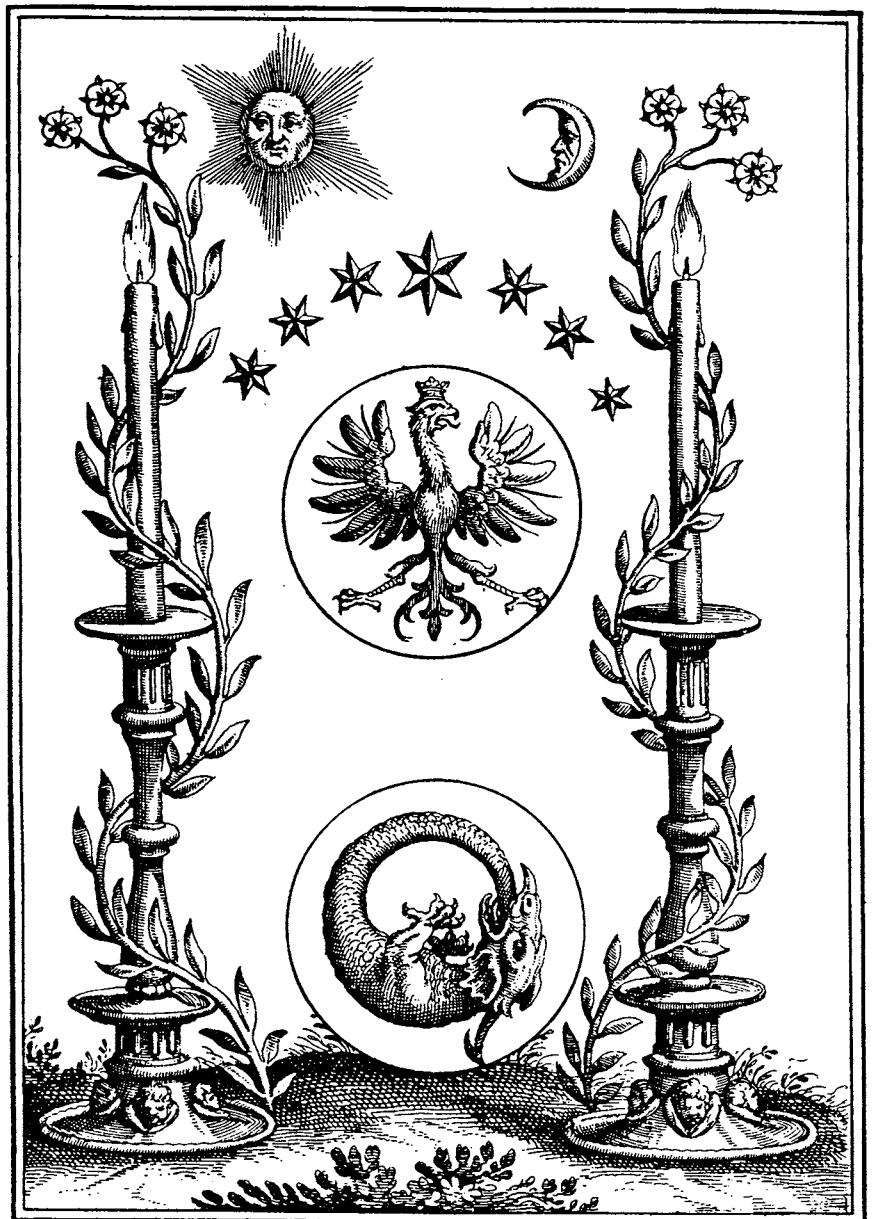

HERMETICISM AND THE GOLDEN FLEECE

By Joseph Caezza

Every century and upon every continent a handful of exceptional men are born who possess the innate ability to read the signatures of nature directly, to see immediately into the mystery of continuous creation and to know pristine reality revealed by the power of imaginal identification. Such vision differs radically from twentieth century pedestrian academic mentality. These sages have bequeathed us a legacy of artifacts fine as the thread of Ariadne in the form of the good texts of Hermetic Alchemy. These tomes speak from the vein of the forge and the crucible, a mother load in the vast mine of collective imagination about mankind's origin and ultimate destiny. They articulate with artful genius the same message of the hero's journey embodied in the great world myths. A generation ahead of mythic Cadmus, a generation behind Homer's Ulysses, Jason's quest for the Golden Fleece constitutes a fabulous example of the archetypal process of Nature referred to in the Emerald Tablet of Hermes Triismegistus as "the operation of the Sun".

The greatest alchemical adepts, Artephius, Nicholas Flamel, Salomen Trismosen, Michael Maier, Philalethes, Dora Pernety and Fulcanelli among many others have spoken at once with pornographic explicitness and again with exasperating obliqueness about the bench-top laboratory manipulations revealed in the circumstances of Jason's voyage. Joscelyn Godwin in his brilliant forward to Antoine Faivre's contemporary survey, *The Golden Fleece and Alchemy* remarks that C. G. Jung anchors Jason's argo along with the Hermerle great work solely to the psychic level of personality integration while ignoring how, why, what and with what, adepts actually do in their laboratories. Faivre too, pays gross negligence to this central aspect of the royal art which concerns itself with a combination of prayer, study and working hands-on directly with matter. "ORA, LEGE, LEGE, LEGE, RELEGE, LABORA ET INVENIES", declares the motto of the **MUTUS LIBER** of 1677, "Pray, Read, Read, Read, Read Again and You Shall Find".

Western alchemy represents a highly specialized version of the age old quest for mystical communion with the essential archetypal process of Nature. Adepts seek to recapitulate this process with symbolically affective laboratory gestures, chemical manipulations and of course, with the indispensable cooperation of providence. But what do they actually do in their laboratories?

Betty Dobbs in her monumental study, *The Foundations of Newton's Alchemy or The Hunting of the Green Lyon*, addresses this central issue of laboratory procedures in their 17th century European context better than any modern professional scholar. She explains that adepts worked their methodologies with simple manipulations and a few key materials. She provides an excellent translation of Sir Isaac Newton's *Clavis*, a recipe that entails the chief substances symbolized in the Jason myth.

According to the myth, Chrysomellos, the winged ram sent by beneficent Olympian deities rescues a child from the homicidal plot of his stepmother, carrying him safely to the eastern shores of the Black sea. Here the miraculous ram becomes a sacrifice, its fleece hung upon an oak tree in a grove sacred to Ares and guarded by a dragon. The scenario refers metaphorically to the descent of the Divine from above the highest sepheroth, Kether, down the Kabbalistic tree of life to the lowest sepheroth, Malkuth, Earth in the presence of the element Antimony, who's vital spirit, philosophic mercury, remains still in tact. Matter has become the prison of spirit. Insightful wisdom and artful alchemical manipulation may release it.

Renaissance alchemists represented antimony by the symbolic rams horns that also identify the zodiac constellation Ares. Antimony, a metalloid or semi-metal was perceived as below lead in an infant or childhood state in the natural process of metallic evolution fully mature in the element gold. It was also symbolized as a cross above a circle which additionally identified Earth, the divinely perfect circle of gold buried under the cross of nature upon which man is crucified.

Gold, more than a metaphor, blatantly and beautifully bears the solar signature. Its perfect state defies oxidation or attack by any single acid giving way only to aqua regin, a combination of nitric and hydrochloric acid. Luster and permanence testify to its Divinity within the confines of the metallic realm.

Ares, known to the Romans as Mars, also indicates the element Iron, rich in philosophical sulfur, the source principle of the luminous animating functional fire of Nature. It comprises the compliment of philosophic mercury. Iron finds use in purifying stibnite, the chief ore of antimony in the classic reduction process: $Sb_2S_3 + 2 Fe = 2Sb + Fe_2S_3$.

Newton spent years of study and labor working out the details of this reaction and its product at the root of animated philosophic mercury. Small iron nails are heated red hot in a crucible. Powdered antimony ore is added along with saltpeter and tartar to serve as fluxing agents. After several fulminating episodes sponsored by repeated additions of saltpeter the molten material is poured into a conical mold. Pure antimony sinks to the bottom topped off by a layer of scoria which easily separates after cooling. Signs of correct crystal purity include a star pattern on the surface of the antimony, hence the name star martial regulus.

In a major episode exactly reminiscent of Cadmus, Jason must sow serpents teeth into a field. From these seeds spring an army of ghost warriors who fight each other to death. The seed of gold, the serpent teeth are extracted from the layer of scoria above the purified antimony, the mercurial serpent, using sal ammoniac, ammonium chloride in the procedure of sublimation. This seed after purification is then sewn into meticulously prepared philosophical mercury. This metallic mixture then sealed hermetically in a flask undergoes a long gradually heated fermentation. Color changes clearly mark the major stages of this incubation along with the emergence and dissolution from the molten mass of many strange forms described metaphorically in the Jason myth as a battle of ghost warriors. Newton and other adept authors describe these forms as fast growing metallic trees. An anonymous contemporary operator recently perceived these forms as rapidly sprouting heads of cauliflower that soon dissolved back into the putrefying chaos contained in his hermetic flask.

The ultimate product of this labor mythically known as the golden fleece refers to the philosopher's stone. This red powder projected into molten base metal effects an apparently miraculous transmutation into gold. Recent discoveries by Stan Tenen and others, (GNOSIS No. 3 and 28) of the geometric revelation hidden in the Torah's Hebrew letter code that model mathematically the fractal process of a seeds germination into fruit containing self propagating seed within itself, illuminates this alchemieal gesture of projection. During this gesture rearrangement of base metal subatomic particles catalyzed by the propagated potency of Divine Presence unfolding flower-like from the philosopher's stone, creates a well known wonder of alchemy.

This wonder of alchemy testifies with unquestionable proof to the level of personality integration achieved by the operator. Unlike the vague proofs of successful psychotherapy the adept has a tangible token artifact.

Alchemy of the forge and crucible variety thus embodies the profound idea of sacred science. Our late twentieth century civilization moves ever closer to the rediscovery of this tradition. Yet the only way to exhaustively understand the symbolic implications of the Jason myth in its alchemical context is to become an alchemist and to execute the great work.

But does salvation require a laboratory? The archetypes projected into external substance may be manipulated at a strictly internal level. The symbols of western alchemy occur in familiar forms in Tantric Yoga. The European "Royal Art" of alchemy pursues the same goal as the Royal Raja Yoga of India. In the most remote past European and Hindu cultures sprang from a single root whose core experience of Gnosis presented itself in myths and related esoteric disciplines of spiritual reintegration.

J. Nigro Sansonese, a contemporary yogin as well as professor of math and physics delivers a brilliantly argued thesis in his recent The Body of Myth. Expanding the tradition of C.G. Jung and Joseph Campbell he explicates the anatomic, physiologic and neurologic basis of the great world myths. Such myths trek out the physical geography of man's body as the spiritual current moves up the spinal ladder of ascending attention to culminate in the ecstatic rapture of gnosis.

According to Sansonese myths reveal in esoteric language the stages of bodily transformation leading to contemplative trance. He includes an entire chapter on Jason and the Argonauts. Jason's ship, the argo refers to the cranium. The fifty argonauts represent the five senses withdrawn from fragmented external experience yet focused on the inward journey into trance. Two of these argonauts, the Dioscuri, Castor and Pollux are esoteric descriptions of alternate nostril breathing.

The rowing contest between Jason and Hercules constitutes a further example of alternate nostril breathing just previous to the experience of trance symbolized as the heros collapse from exhaustion into unconsciousness. The author speaks from his own experience of meditative absorption when he describes minutely perceptible changes in the sutures and sinuses of the skull during breathing which correlate to elements of the stages in the argonauts journey.

Finally Sansonese dissects the name "Jason" to reveal its two syllable nature as an onomatopoeic rendering for the physical gesture of respiration. Convincing evidence appears in the ancestral lineage of Jason. His

great-grandfather was Aeolus, god of the wind. Also relevant are yogic breathing exercises that assign onomatopoeic syllables to inspiration and expiration such as HAM-SA, SO-HAM or SI-VA. These arguments might seem eccentric and vague. Perhaps only another yogin could appreciate their depth and profoundness.

Contemporary scholars have barely touched the phenomenological relationship between yoga and alchemy. Certainly they pursue identical goals. Mircea Eliade in his now classic encyclopedic survey, Yoga: Immortality and Freedom, includes a brief chapter on yoga and alchemy. He notes that there are certain moments when the "osmosis" between these two disciplines is perfect.

The Hermetic scholar, Manly Palmer Hall speculates on the etymology of the symbolic rose of the Rosicrucians derived from Ras, wisdom or Ros, dew which recall Rasayana, the Ayurvedic science of longevity involving alchemically produced herbal and metallic medicines but more specifically "rasum", the nectar of immortality produced in the brain. Normally this secretion is destroyed by normal body function but yogic manipulations such as the headstand and kerchari mudra preserve and cultivate this substance.

During kerchari mudra, the tongue, artificially lengthened over years of ardent discipline inserts back and up into the nasal passage to block the normal flow of rasum. Such a practice is thought to function like the golden fleece to preserve health and even restore lost youth.

The greatest Hindu sages write about the spiritual accomplishment of Gnosis using the metaphor of the philosopher's stone. Jnaneshwari (1275-1296) certainly one of the foremost saints of the past millennium wrote an exquisite commentary on the Bhagavad Gita, Hinduism's central scripture. He composed this work at the age of fourteen, without formal education by direct knowledge resulting from Divine grace. He describes with unparalleled depth the symptoms of bodily transformation effected by the yogic process of spiritual awakening. His commentary contains no less than 17 references to the philosopher's stone that explicitly transmutes base metal into gold. Often these references describe the way divine grace transforms its recipient.

The seventh century South Indian sage, Thirumoolar in his classic, Thirumandinium, an esoteric masterpiece of 3000 verses, explains man's path to immortal divinity. In verse 2709 he declares that the name of God, Siva, is an alchemical vehicle that turns the body

into immortal gold. His poetry resonates with the deathless nature of spiritual attainment.

Another great South Indian saint, Rarnalinga Swamigal (1823-1874) dissolved his perfected body into blinding white light just as another earlier sage, Manickavnsagar had done in the seventh century. As a child Ramalingar delivered brilliant scriptural discourses and commentaries without any formal education. He too claimed direct knowledge bestowed by divine grace. In his classic testimony, The Divine Song of Grace, Ramalinga describes the transmutation of his dense physical body into a body of light:

"Oh God! The Etemal Love, just to bestow upon me the golden body, You, Universal Love, have merged with my heart, allowing yourself to be infused in me. Oh Supreme Love, You with the Light of Grace have alchemised my body". (Canto 6, Chapter 1, Verse 480)

This verse resounds with the import of the gesture of alchemical projection where a minute quantity of the philosopher's stone transmutes molten base metal into gold. Ramalinga's body cast no shadow and attempts to photograph him revealed only his clothing. The esoteric level of such accomplishment defies any attempt at vain academic analysis.

So too, a deeper understanding of the quest of Jason and the Argonauts defies the limit of ivory tower scholarship. The golden fleece beckons to every man as a road map of the soul's origin and ultimate destiny. Exhaustive study of the map will always be an optional first step. Genuine accomplishment emerges only when we take up the quest and join Jason on his hero's journey.

SELECTED BIBLIOGRAPHY

Dobbs, Betty Jo Teeter, The Foundations of Newton's Alchemy or The Hunting of the Green Lyon, Lyon Cambridge, 1975

Faivre, Antoine, The Golden Fleece and Alchemy, SUNY, Albany, N.Y. 1993

Jnanadeva, Sri, (Jnanashwar), Bhavartha Dipika, also known as the JaanashWari, Samata, Madras, 1954

Natarajan, B., editor translator, Thirumoolar's Thirumandinium, ITES, Madras, 1979

Pernety, Antoine-Joseph, An Alchemical Treatise on the Great Art, Weiser, York Beach, ME. 1995

Sansonese, J. Nigro, The Body of Myth: Mythology,
(Continued on Page XXII)

MUDRA AND ROSICRUCIAN HEALING

By John Eberly

In the Fame and Confession of the Fraternity of R: C: Commonly, of the Rosie Cross (1652) translated and introduced by Eugenius Philalethes, a pen name of Thomas Vaughn, the original eight Rosicrucian brethren including father Christian Rosenkreutz made a solemn pact containing six articles. The very first of these articles which constitute oaths among honorable men, was this: "That none of them should profess any other thing, than to cure the sick, and that *gratis*."(1)

While we can assume that this group was in possession of alchemical preparations capable of any conceivable healing, it has been stated that the arrival of the physician constitutes 90% of the cure. The idea of magnetism, or an understanding between healer and patient in which the person with depleted energy "borrows" from the other possessed with an overabundance, is as old as sympathetic magic.

"Inasmuch that they brought forth the sick into the streets, and laid them on beds and couches, that at the least the shadow of Peter passing by might overshadow some of them." -Acts 5-15

Mudra is a sanskrit word which literally means "seal" ("pact"?). It carries various meanings in the context of hindu yoga and tantrism, the most common being a body position or sacred posture. *Any* attitude of prayer might be considered mudra in this context.

Cornelius Agrippa at first calls the practise used by magicians, "ridiculous gesturings" and goes on to relate these hand gestures to mathematics and planetary influence which might "...with sacred silence worship the gods that rule over the world".(2)

Early christian iconography is full of hand gestures of blessing and benevolence. As in most christian symbolism, gestures and body postures of Christ and the saints are part of the elaborate non-verbal expression designed to convey the religion to a largely illiterate faithful. Like mudras, this potent form of information suggests that non-verbal communication is more powerful than the spoken word.

Recently psychologist Albert Mehrabian, studying the communication between two persons concluded that "only 7% of the message's effect is carried by words, while 93% of the total impact reaches the "listener" through non-verbal means...Feelings are conveyed

mainly by non-verbal behaviour."(3)

In hindu tantra, the mudra hand gestures are meant to provoke a subjective reaction in the mind of the adept. They are not only representative of body postures but are also archetypal signs which signify divine powers brought into the material realm. They are related to *nyasas*, which are projections of divine entities into various parts of the body. In the "Soma-Shambhu-Paddhati", no fewer than thirty-seven hand mudras are described. In the "Gheranda-Samhita", there are twenty-five such "seals", which, the text states, are to be kept secret with great care. They have great curative and rejuvenating power and activate the gastric fire known as the *jathara-agni*.

The "Gheranada-Samhita" describes the *khecari-mudra*, a transformation involving actual physical alteration in this way:

"One should (gradually, over a period of time) cut the tongue's frenum and move the tongue constantly, milking it with butter and pulling it out by means of an iron implement. When the tongue has been elongated to the point where it can reach the spot between the eyes, one is fit for the *khecari-mudra*."

The tongue is turned back and slowly inserted into the 'skull cavity' (*kapala-kuhara*)...This mudra is said to prevent fainting, hunger, thirst, lassitude, disease, ageing, and even death. It is also stated to create a "divine body" (*deva-deha*), immune to snake bites and the elements.(4)

One form of Rosicrucian physical transformation, more akin to the hand gesture school of mudra than the more drastic account just related, is also called "somatic alchemy":

1) The index finger and thumb of the right hand form the vowels, I, A, O, (line, angle, circle; together comprising a wheel, in Latin *Rota*, the very ancient name of God: JAO. These three signs also denote the phallus, the vagina, and the uterus, the mudras employed by the Balinese *Pedanda* (priests).

2) Voluntary control over the normally involuntary blood flow is obtained by concreting the thoughts on the finger positions and simple syllables.

3) An objectively measurable rise in temperature is developed in the finger which is being contemplated.

4) This attracts a quantity of Od (excess energy) which is over and above the individual's own requirement, at the same time, and

5) it is systematically incorporated in the body-with the exception of the head-by means of manipulations performed in a downward direction.

6) In this way the invisible body (the "salt" body) is fortified, loosened and finally made independent. ("The homunculus in the Philosophical Egg," i.e., the human body.)

7) During this physiological Magnum Opus the performer smells sulphur on the finger "magnets" contemplated and tastes the salt and mercury on them;

8) He also perceives (mentally) the recognized alchemical color scale of black, white, peacock's tail, green, yellow, vermillion.(5)

Considering 1) above, we may note that the Greek I. A. O. according to Frater Achad in his short work titled "I. N. R. I. - DE MYSTERIIS ROSAE RUBAE ET AUREAE CRUCIS" is the "Formula whereby the L. U. X. may be drawn from the Cross, and the Key-Word found, and the Word be subtly extracted therefrom. Without this knowledge how cans't thou give the true Signs of thy Grade? Let us therefore analyse the Keyword, as did our Antient Brethren: I. N. R. I. (Roman) Yod. Nun. Resh. Yod. (Hebrew). Virgo, Isis, Mighty Mother. Scorpio, Aphopis, Destroyer. Sol, Osiris, Slain and Risen. Isis, Aphopis, Osiris. (Egyptian). I. A. O. (Greek)."(6)

Concerning 7) above, we may look at the footnote concerning "Magnesia" in the passage* by Thomas Vaughn found below in the present essay, "See NOVUM LUMEN CHEMICUM, Tract, iv. A certain unctuous vapour, consisting of Sulphur and Mercury, is said to be liberated in the spring-time and attracts the Mercury of the air, giving life to all things. It is said in the epilogue that 'the inmost heart of our Magnesia' corresponds to 'the respective centres of the sun and earth.' The Salt of the sages is hidden in 'the womb of Magnesia.'"(7)

Various definitions abound concerning "magnesia" in alchemical terms, however, most often it is considered the universal substance, the "fire in the air", that which is found everywhere in all seasons.

Geographically, Magnesia is a mountainous district of eastern Thessalia in Greece (the land roughly east of a line between present day Larisa and Volos). The inhabitants of this region were at one time worshippers of the moon as Diana, twin sister of Apollo (the sun). Diana's annual festival was held at the hottest time of the year, and featured lighted torches. Creative fire reflected in nature seems to be the emphasis of her rituals. The predominance of mountains in the geographical Magnesia is mirrored in "magnesia's" alchemical symbolism; mountains receive the sun's first light, which radiates downward to earth below where it mixes with the shadows of Diana's sacred groves. Light and heat infiltrate the coolness of shadow and earth, which yield up the magnesia which ascends. The gesture of the priest/priestess with arms upraised to the dawn, then bringing the arms slowly downward is symbolized (among other mysteries) by the Star of David. Knowledge is that which "dawns", while faith is the grace which spreads down from on high.(8)

To return to Thomas Vaughn, in his work titled "EUPHRATES or The Waters of the East"* (see above) he states,

"The Magnesia then--as Sendivogius hath written--is generated in the winter, and not without reason, for then the heat of the earth is strongest and best able to digest the nutriment that comes down from heaven and concoct it to a vicous sperm. But in the spring and summer seasons, when the sun hath chased off the frost and the central and celestial luminaries have--by their mutual mixture and conflux of beams--relaxated and dilated the pores of the earth, then there is a way made for the sperm to ascend more freely, which subliming upwards is attracted and intercepted by the vegetable kingdom, whose immediate aliment it is.

...we say this sperm is made of the vapours or clouds, and the vapours are made by elevation and depression of the elements...And this bears a double sense, for we must know that the earth is charged with many particular natures--as minerals of all sorts and cadaverous relics; for our bodies also lodge in the earth when the spirit of life hath left them. All these, as well as the earth itself, suffer a rarefaction and resolution of substance; for into these vapours, saith Raymund Lully, "are resolved all bodies produced from the elements, that they may enter into new generation."(9)

Alchemically the sun is the masculine principle operative in nature, the moon being the passive receptive female principle. Conjoined, these principals effect the "Chemical Wedding".

The building-up of the life-force (prana) is the essential feature of certain so-called "sex magic" rituals, common to tantra and some forms of Chinese alchemy. This technique involves "raising the semen" instead of expelling it, in order to supercharge the organism.

The left-hand tantric sex ritual called *maithuna* involves a consecrated male and female couple who for the duration of the rite are considered to be the gods Shiva and his divine consort Shakti. The woman herself, in this godly form, is considered to be a mudra, the heavenly "seal". The goal of the ritual is to diffuse the sexual energy throughout the bodies of the participants.

One of the most accepted and all-pervasive ideas in alchemy concerns how the material creation contains a spark of light retained from the Light of the Creator. In the immediate realm of creation, emblematic and textual references abound referring to the physical sun as the retainer or lense directing the light of God magnetically, or "electrically".

"Nowadays, anyone who denies the effectiveness of magnetism should be regarded not as a skeptic but as an ignoramus." -Arthur Schopenhauer (1778-1881)

The organizational attraction of the planetary bodies depends on the sun's gravitational pull which dominates space in all directions outward to a distance of 2.4 light-years. Einstein considered gravitation to be the curvature of space itself. Magnetic fields are invisible forces that are only knowable through their effects although the structure of gravitational forces and magnetic fields are "there" whether they are revealed or not.

The sun makes up more than 99.95% of the mass of our solar system and is our only significant source of light and heat. The word "healer" is similar to "heliotrope" and indeed the Greek *heilen* and *helios* have similar roots.

The "sun-salutation" is one of the most basic series in hatha-yoga involving body postures.

Laya yoga, the yoga of meditative absorption, is a general term that broadly describes techniques that dissolve the thought-processes by such means as breath control and mudra. One example of this type of mudra-yoga involves visualizing the god Shiva in his brilliant phallic form. After six months of this practise, one comes to enjoy powers and longevity up to three hundred years.

The present writer once participated in a controlled

experiment involving bio-feedback when that science was in its infancy. What was observed at that time concerning raising body temperature and control over the vascular system generally has since been applied for healing purposes following acts of prayer and meditation.

A form of laya-yoga practised by Rosicrucian healers ostensibly for the purpose of building up extra healing energy involves bodily exposure to the sun.

"I then raised my hands toward heaven for some time, so that my ten fingers were extended toward the sky, and in this way absorbed more electrical matter."
-Karl von Eckartshausen (1752-1803) (10)

In the following remarkable passage, the 20th-century adept G.I. Gurdjieff discloses to his disciple Olga Hartmann that although some priests may nowadays be ignorant of the content of certain ritual gestures, this by no means *affects the power of the gesture*.

"One gorgeous morning when, as always, we were up early, I went out towards the beautiful avenue of lime trees and was filled with such a feeling of beauty of Nature and happiness that I lifted both of my arms up in the air. At this moment, Mr. Gurdjieff said to me, "What are you doing?" I did not know that he was there behind me. He told me, "This is the gesture of a priest before making Holy Communion, to bring the higher forces down. The priests have now surely forgotten what this gesture means and perform it quite mechanically, but it is really a gesture which can bring higher forces down, because our fingers are a kind of antenna." And he said to me, "Don't do it without understanding what you are doing." (11)

In his collection of short autobiographical essays entitled *Episodes* Pierre DeLatre, the "Beatnik-priest" describes his (reluctant) entry into Presbyterian ministry at the hands of forty ministers in the short chapter called "Ordination",

"A hand settled on my head. Another hand. Another hand on top of those. Hands upon hands piled up, a great, heavy heap of hands shuddering there all over my skull and down my ears while voices said my name and blessed me. I felt a hot bolt of energy melt my brain to white light, then a warm glow through my whole body...these brothers were transmitting to me the blessing being sent through their hands by God." (12)

DeLatre goes on to admit that those *ministers* who have broken themselves open to allow the living force of God's love into their bodies are subsequently able

to pass this force of love on to others regardless of the theological orientation of the minister or of the recipient.

"And Aaron raised his hand and blessed the people."

-Leviticus

9:22

In the Book Bahir (Sefer ha-Bahir), an early Qabalistic text, we find a commentary to this quote from Leviticus in "Section 124":

"And what is the reason for the raising of the hands and blessing them with a benediction? This is because there are ten fingers on the hands, a hint to the ten *sefirot* by which the sky and the earth are sealed. And those ten correspond to the ten commandments, and within these ten all 613 *mitzvot* (Note: the sum total of the Jewish commandments found in the Hebrew Decalogue) are included."(13)

The ten cosmic dimensions found in the Sefer Yesirah (Book of Creation), are: up, down, east, west, north, south, beginning, end, good, and evil. God "seals" his actions in the universe by way of His holy name and attributes.

Dr. E. Tromner, in his book on hypnotism asserts that, "...human beings in particular have two sorts of magnetism in them, a healthy and an unhealthy kind. The healing of diseases takes place when the magnetism of a healthy person draws that of the ill person to itself and paralyzes or cancels it."(14)

The Hawaiian *Kahuna* healer Papa Auwae, who is regarded as the elder and leader of this tradition of herbal-spiritual healing responded in a recent interview when asked if he could perform "death magic" as well as the usual miraculous life-giving healings,

"Yes, that's easy! It's just between you and whom ever you wish to destroy. When my great-great-grandmother taught me, she taught me both the good of God and the evil of the devil or bad spirits. So I have them both to use."(15)

"By stretching forth thine hand to heal; and that signs and wonders may be done by the name of the holy child Jesus." -Acts 4-30.

In the very next chapter of the New Testament, Peter invokes the wrath of the Spirit of the Lord and upon hearing his *word* Ananias and Sapphira (related to the *sefirot* ?) fall dead at his feet!

Stephen Hawking (who rejects Einstein's "mysticism") has stated that "when you have strong gravi-

tational fields, they can create matter". He goes on to say, "The positive energy of matter is exactly balanced by the negative energy of the gravitational field."(16)

Legend asserts that the Maghrebi saint Abu Madyan became the disciple of Abu Yaza, a Dukkala Berber who lived at Fez and also at Taghyah. Abu Yaza was "on the heart of Moses". When Moses returned from his Lord on Mt. Sinai, God clothed his face in a blindingly fierce light. Once, when Abu Madyan looked upon his shaykh Abu Yaza, he was struck blind by the light he saw there until, "Abu Madyan rubbed his eyes with the garment that Abu Yaza was wearing and recovered his sight."(17)

Hebrew, Christian, and Islamic scripture abound with instances of God's healing and blinding light poured forth from his chosen ones.

What compels the proton to bond with two electrons to create the hydrogen atom? This bonding creates a new body, the *mudra* formed in the Chemical Wedding of Life. There would seem to be an undeniable union of opposites through mutual attraction or repulsion beneficial to the whole system.

Healers are in constant sympathy with the internal/external forces surrounding them in order to balance opposition and perfect healing. This dissolution of the individual into relationship by attraction is also known as Love. The Creation is constantly "healing itself" by an intricate system of balance which involves active participation by agents such as the holy brethren of the eternal Rosy Cross who have realized the secrets of universal nature.

Alchemically, illness is an imbalance and/or non-alignment of the salt (physical), sulphur (soul), and mercury (spirit). When one is ill, one ultimately surrenders oneself to the Other; it is a time of pause, reflection, and quite often, prayer. It is a period of helplessness, when we are dependant on the skill of the physician, which ultimately depends on the faith of the patient and the grace of God. A constant prayer in these times of dependancy and need might follow, "Dear God, bless and guide these healing hands!"

"Upon this account they say, that a man by his affection, and habit only, may act upon another...when it is fixed upon God for any good with its whole intention, doth oftentimes affect another's body as well as its own with some divine gift."

-Cornelius Agrippa(18)

NOTES

1. See: Allen, Paul M. A Christian Rosenkreutz Anthology. Blauvelt, Spiritual Science Library, 1968.
2. See: Agrippa, Henry Cornelius, The Three Books of Occult Philosophy, Book II, Chapter XVI "Of the Notes of Numbers, Placed in Certain Gesturings". St. Paul, Llewellyn, 1995.
3. Quoted by Fabun, Dimensions of Change, pp 199-200.
4. See: Feuerstein, Georg. Encyclopedic Dictionary of Yoga. New York, Paragon House, 1990.
5. Paraphrased by the present author from P. de Kat Angelino: Mudras auf Bali, Hagen i.W., 1923, via Willy Schrodtter. A Rosicrucian Notebook, Weiser, 1992, pp 78-79.
6. See: Achad, Frater. I.N.R.I. DE MYSTERIIS ROSAE RUBEAE ET AUREAE CRUCIS. Edmonds, Sure Fire, 1989.
7. See: Waite, A.E. The Works of Thomas Vaughn - Mystic & Alchemist. New Hyde Park, University, 1968.
8. For more on the esoteric symbolism of mountains as pivotal points of reference in a decidedly non-geographical sense, see, for example, "The Holy Mountain, A Rosicrucian Allegory", by Thomas Vaughn, in A Christian Rosenkreutz Anthology, pp 337-340; in the same anthology, one may note the castle on the hill mentioned on p 79 of Andrae's "The Chemical Wedding of CRC". See also the excellent treatment of what is surely the origin of some of these holy mountain themes in ancient Mazdean Persia in Henri Corbin's works, especially Spiritual Body and Celestial Earth: From Mazdean Iran to Shi'ite Iran.
9. The Works of Thomas Vaughn, ed. by A.E. Waite, pp 407-408.
10. Aufschlusse zur Magie aus geprüften Erfahrungen-An Explanation of Magic in the Light of Experience, Munich, 1791-92, Vol. 1, pp 188.
11. See: de Hartmann, Thomas and Olga. Our Life With Mr. Gurdjieff. San Francisco, Harper & Row, 1983, pp 149.
12. DeLatre, Pierre, Episodes, St. Paul, Greywolf Press, 1993, pp 31-32.
13. See: The Early Kabbalah, Joseph Dan, ed., New

York, The Paulist Press, 1986, pp 59-60. See also: A.E. Waite, The Holy Kabbalah, New York, Citadel, 1995.

14. E. Tromner, Hypnotismus und Suggestion, Leipzig, 1908, p 7.
15. See: "The Big Kahuna-An Interview with Papa Aua-wae", by Tom DeMoss, Gnosis magazine, No. 39, Spring 1996, pp 34-37.
16. See: Dialogues With Scientists and Sages-The Search for Unity, by Renee Weber. Chapter 11, "If there's an edge to the universe, there must be a God" - Stephan Hawking interview.
17. See: Chodkiewicz, Michel. Seal of the Saints, Islamic Texts Society, 1993, p 74. Also see: Eberly, John al-Kimia-The Mystical Islamic Essence of the Sacred Art of Alchemy, Anamnesis, 1995, p 68.
18. Ibid., Occult Philosophy, Book I, chapter 65.

BIBLIOGRAPHY

- Avalon, Arthur. The Serpent Power-The Secrets of Tantric and Shaktic Yoga. New York, Dover, 1974.
- Incognito, Magus. The Secret Doctrine of the Rosicrucians. New York, Barnes & Noble, 1993.
- Jones, Franklin. The Method of the Siddhas. Los Angeles, Dawn Horse, 1973.
- Rawcliffe, D.H. Occult and Supernatural Phenomena. New York, Dover, (reprint) 1952.
- Ridpath, Ian. The Illustrated Encyclopedia of Astronomy and Space. New York, Crowell, 1979.
- Schrodtter, Willy. A Rosicrucian Notebook. York Beach, Weiser, 1992.
- Weber, Renee. Dialogues With Scientists and Sages - The Search for Unity. New York, Viking-Penguin, 1986.

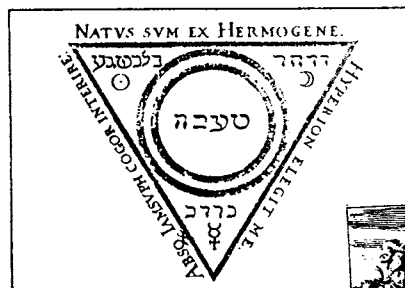

Hermeticism & Golden Fleece

continued from page 17

Shamanic Trance and the Sacred Geography of the Body, Inner Traditions International, Rochester, VT. 1994

Srinivasan, C., An Introduction to the Philosophy of Ramalina Ilakkia Nilayam, Tiruchi, 1968

About the author: Joseph Caezza has been a student of the South Indian, Yogi Ramaiah since 1986. He is a member of THE PHILOSOPHER'S of NATURE and a registered pharmacist practicing in Rochester, N.Y.

Joseph Caezza, 201 Valley Rd., Rochester, NY 14618. Phone: 716-256-2662 or (716) 424-1360

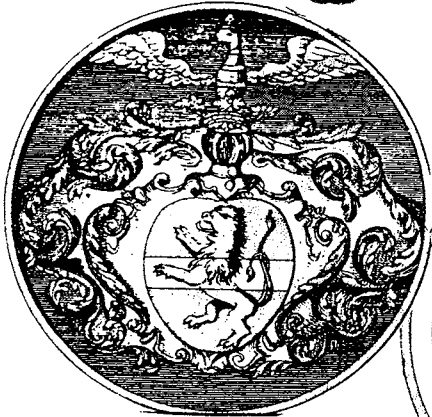
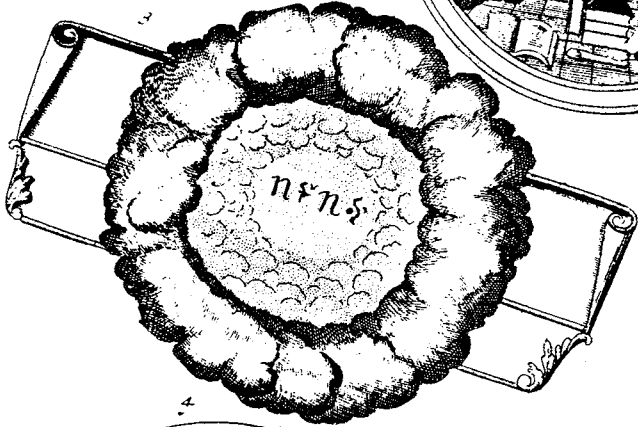
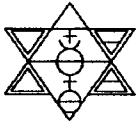

“Who Do I Contact When...”

- I have advertising for The Stone?”
- I have an article or letter for The Stone?”
- I have questions about my membership?”
- I have problems receiving my lessons?”
- I would like to subscribe to The Stone?”

I need back issues of The Stone?”

Contact Sue House, PON Office Administrator: Philosophers of Nature, 125 West Front St., Suite 263, Wheaton, IL 60187; Phone (630) 682-3938 Fax (630) 665-2364

Email: alchemy@mcs.com
 World Wide Web:
<http://www.mcs.net/~alchemy/>



• About The Stone

The Stone is published three times a year in March, July, and November, primarily for the benefit of the membership of the Philosophers of Nature. We hope to get members' feedback regarding what they would like to see in it. Articles, photographs, drawings, letters to the editor, and comments from members or others are solicited for submission to the Editor for evaluation. Submissions and advertising should be sent to Russ House at the PON headquarters, address listed above. Deadline for submissions and advertising are as follows: February 20th for the March issue; June 25th for the July issue; October 25th for the November issue.

• Advertising

The Stone accepts advertising for both display and classified ads. Rates are as follows: Full page: \$100.00; Half page: \$60.00; Quarter page \$35.00; Classified ads are \$0.10 per word. For more information write or email Russ House at the address listed above, or e-mail him as above.

• Subscription to The Stone & Membership Information

The Stone is included in the cost of membership. Non-members may subscribe at the rate of \$20 per year (three issues). Subscription requests and any questions about membership should be sent to the administrative headquarters: Philosophers of Nature, 125 West Front Street, Suite 263, Wheaton, IL 60187. You may leave a message for the office manager at (630) 682-3938.

ANNOUNCEMENT: JEAN DUBUIS GIVES SEMINAR - OCT 18 - 20

WHEN:

Saturday-Sunday, October 19-20, 1996.

9:00 AM until 5:30 PM. Registration begins at 9:00 AM on Saturday. There will be a lunch break beginning at noon. Hotel restaurant will make special fast service lunches available. There are numerous restaurants within walking distance.

FRIDAY NIGHT Introductory Session:

At the hotel from 7:00 until 9:30 PM on Friday, October 18, 1996. Mr. Dubuis will present an overview of the topics of the two-day workshop. It is also an opportunity to meet with people of similar interests and to ask questions of Mr. Dubuis or officers and members of The Philosophers of Nature. Not sure if you are interested in the 2-day workshop? Come on Friday night and see.

WHERE:

Holiday Inn, "Monterrey Room", 1250 Roosevelt Rd, Glen Ellyn, IL 60137 Tel: 630.629.6000.

ACCOMODATIONS:

Available at the hotel at a special rate of \$69.00 per room per night with 1 to 4 occupants. To receive these special rates: reserve your room immediately and state that you are with The Philosophers of Nature. Special rates may not be available at this late date.

TRANSPORTATION:

Special limo rates are available from Airtran O'Hare: \$26.00 to or from O'Hare, \$34.00 to or from Midway. You must call in advance to make arrangements. 1.800.851.0200.

COST (for Friday night -- Sunday):

	Member	Non-Member
Individual	\$160.00	\$180.00
Couple	\$255.00	\$290.00

Mid-morning and mid-afternoon snack breaks on Saturday and Sunday are included in the cost.

INSTRUCTOR:

Mr. Jean Dubuis founded Les Philosophes de la Nature (LPN) in France in 1978, as a research society for alchemy, qabala and esoteric studies. He developed an extensive series of correspondence courses which are available in English and French from The Philosophers of Nature. Mr. Dubuis has more than 63 years of esoteric work upon which to draw, making him a most interesting speaker. He has a solid background in electronics and nuclear physics, and many years of practical work in Qabala and Alchemy.

TOPICS:

Mr. Dubuis will speak about topics in his new course on esotericism, as well as on some topics of value to practicing Alchemists and Qabalists.

REGISTRATION:

If you plan to attend you will need to act quickly.

Please contact The Philosophers of Nature immediately at 630.682.3938.

You can make payment with Visa, MasterCard and America Express, or by check.

An invitation from The Philosophers of Nature...

Are you one of the millions who use the Internet or one of the various online services? We would like to hear from you. Visit our web site at <http://www.mcs.net/~alchemy/> or send us email at alchemy@mcs.com. We always enjoy the chance to visit with you.

THE STONE

THE JOURNAL OF THE PHILOSOPHERS OF NATURE

© COPYRIGHT 1996, THE PHILOSOPHERS OF NATURE

ISSUE NUMBER 17

NOVEMBER - DECEMBER 1996

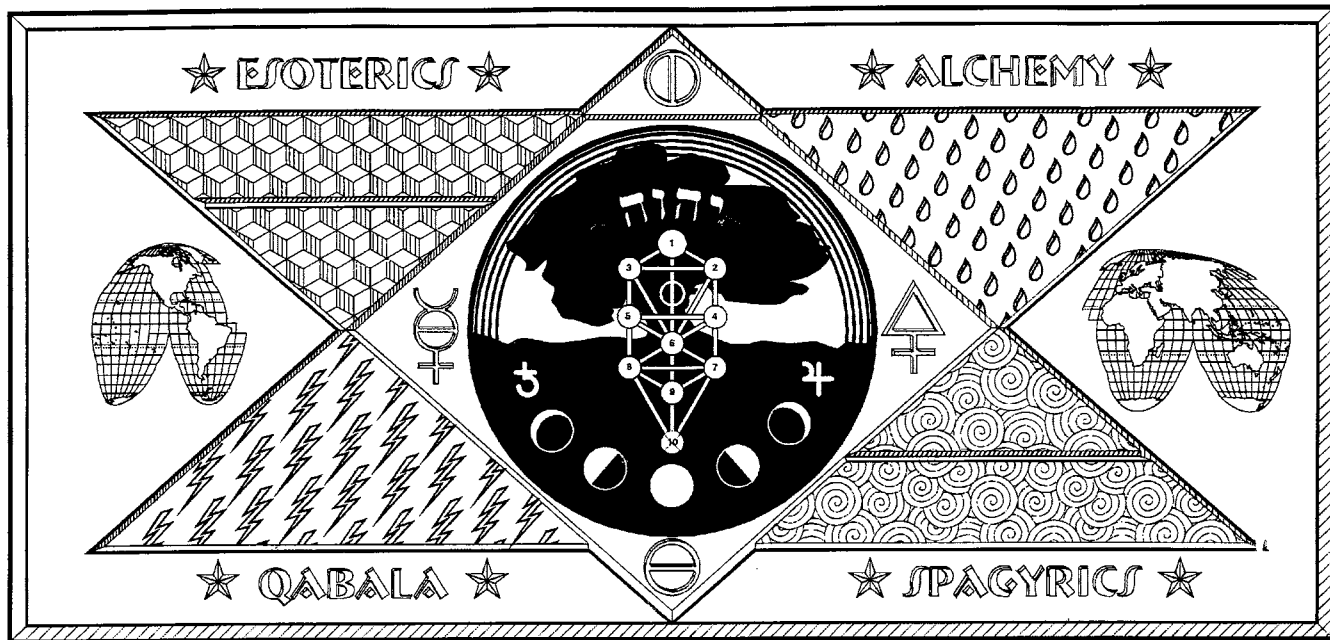

In This Issue

Article or Feature	Author	Page
♀ A Message from the New President	Russell House	2
♀ An Open Letter to Subscribers of The Stone	Rick Grimes	4
♀ A Poem: "Beauty"	Jim Dery	6
♀ Birth Announcement	PON	6
♀ Announcement: Research Projects	Russell House	7
♀ A Speculation on the Unspoken Essential	Joseph Caezza	8
♀ al-Kimia, The Sacred Art	John Eberly	11
♀ Resources	PON	19
♀ Practical Tips	PON	20
♀ Video Tapes Available	PON	21
♀ Seminar News	PON	22
♀ Cover Art	Rick Grimes	Cover

Editor-in-Chief: Rick Grimes; **Production:** Le Philosophe Inconnu

Published six times per year by The Philosophers of Nature

Price: \$5.00 US

The Philosophers of Nature

125 West Front Street, Suite 263, Wheaton, IL 60187 USA

Tel: 630.682.3938 Fax: 630.665.2364

Email: alchemy@mcs.com Internet: <http://www.mcs.net/~alchemy/>

© Copyright 1996, The Philosophers of Nature. All rights reserved.

A Message from the New President

by Russ House

I look forward to continuing to work for our association in a new role, by serving as its President. It has been my pleasure to have worked closely with Past Presidents Bill Van Doren and Kevin Townley, who have capably served the P.O.N. I want to assure you that their interest in the association and its ideals is as strong today as ever, and that they support the development of a more member-oriented association.

Each person who takes on such a role has a different set of priorities, experiences and skills. For this reason, I want to share with you my vision for the P.O.N., not only so that you will know what the Board of Directors is working toward, but more importantly, so that you can participate in that vision if you so choose. I hope that you will want to share in unfolding that vision into a reality.

The Board will focus its combined energies on increasing member involvement and stimulating active research. We are working to expand the publications into new languages so that we can become a truly global association. This will be done within the context of a larger vision.

I believe that this vision is in accord with the ideals that Jean Dubuis had when he created the association nearly twenty years ago. Most people who know of the P.O.N. will agree that it is a unique organization. We think that there are no other associations that openly communicate about modern research in alchemy and qabala in the manner that we do.

Still, we are unique in a more fundamental and significant way. Since the beginning, the P.O.N. has maintained a focus on *inner freedom*. The purpose of the organization has been to provide individuals with tools to assist in their evolution and self-becoming. The P.O.N. has chosen to function as a research group rather than as a secret society, or fraternal and initiatic group. In this way, the P.O.N. can build on traditions and practices of the past without the stagnation that comes from blind obedience to dogma.

It is mandatory that we maintain our focus on the core values and ethics of the association. As long as we dedicate ourselves to the Great Work of evolution and the ideals of Service to Humanity, as long as we are respectful of the inner freedom of those with whom we come into contact, we are deserving of the name *Philosophers of Nature*. This is a magnificent aim, but while the vision from the mountain top is inspiring, the Work is done in the valley.

To be certain that the activities fit with the intent, it is necessary to have a plan. In this case, we decided to follow Nature. We began at the highest level with a definition of our *being*, then sought to derive our *purpose*, and determine the *form* and *activities* that would best suit the Work in today's world.

Essentially, the *being* of P.O.N. has not changed since we began, but it was necessary for us to articulate it in order to renew our contact with that level. We did this by examining our beliefs and values:

Our Core Beliefs and Values:

- *We hold serving humanity in its evolution to be the Highest Good.*
- *We will operate in accordance with the laws and principles of the Fama Fraternitatis.*
- *We consider the following a guiding principle:*

“Do not believe because you saw the written word of an ancient sage;

Do not believe on the authority of masters or priests;

But accept as truth and conform your life to what agrees with your experience, and after a profound study satisfies your reason and leads to your good.

- Siddhartha Gautama -- (Buddha)”

Next, we took a look at our *purpose* and then established a mission for the association.

Our Purpose:

"To serve humanity through the open dissemination of information that genuinely contributes to its evolution, with a particular focus on the Western esoteric tradition, Alchemy and Qabala."

Our Mission:

"To conduct any and all activities in harmony with our values, beliefs and purpose, that ensure our continued service. By the year 2000, we will have become known to 10,000 individuals through lessons, seminars, newsletters, videos, lectures, publications, Internet publishing and other means. In the next 2 years, we will distribute some materials in other languages besides English and French."

Finally, we sought the *form* and *activities* through which to best accomplish this *purpose*. This was the most difficult task in some ways. In studying this problem, one soon sees that there is a gap to be bridged between the clear vision from the mountain peaks, and the labor in the misty valleys. We recognized that while we can approach the ideal structure, we are limited in various ways, such as by the number of members, the necessities of observing the laws, and the need to protect the association. Just as there is no change possible in the *being* at the highest level, there is a continual need for readjustment in the lowest level (of *form* and *activities*), to adapt to changing conditions and opportunities.

Organizational Structure:**The Board of Directors:**

Russ House -- President

Jim Gilmour -- Board Secretary *pro tem*

Walter Griffin -- Board Treasurer

Rick Grimes -- Director of External Affairs

Suellyn House -- Director of Member Services.

A new Board of Directors has been established, whose members are able to meet face-to-face in the Chicago area. These individuals worked together for six months as an Advisory Team, making regular reports to the Board regarding key issues such as organizational structure and direction. It is a

pleasure to announce that this dedicated and capable group will be working together to enhance the level of service to members, and expand into new activities.

Four of the board officers have previously served one or more terms on a board of directors of an esoteric society having significant assets. Four own or have owned businesses; two have had more than 10 years of formal study in practical alchemy. All have had formal study in ritualistic esotericism, mysticism or qabala with an average of nearly 26 years of formal study and training.

Key Positions for Expansion of Service:Jean Dubuis -- *Liaison to Europe*Our *Research Directors* – See article on Page 7Ken Miller – *Regional Manager, Western States*

Others to be announced

Under the direction of the Regional Managers, the Advisory teams will serve a critical role in shaping the association. In this way, members can actively participate in determining the *form* and *activities* of the association. We are looking for volunteers to offer new ideas, organize events, offer constructive criticism of the Board, and to make the association more constructive and effective than ever before.

In conclusion, I would like to thank some of those who have made it possible for the P.O.N. to exist: **Jean Dubuis, Bill Van Doren, Kevin Townley, Ken Miller, Brigitte Donvez, Patrice Malézé, Marc-Gerald Cibard, Hans Nintzel**, and the long list of office managers, seminar instructors, volunteers, typists, artists, proofreaders, transcribers, translators, contributors of articles, people who told their friends about us, seminar organizers, financial supporters, and complainers.

Most of all, we owe our existence to **you**, the members, subscribers, and seminar attendees. Without you none of this would be possible -- or even necessary. I hope that you will join our Advisory Team so that we can learn from you. Please call me at 630.682.3938. An answering machine is always available. The best time to reach me is on weekends or after 8:00 PM Central Time. Send email to alchemy@mcs.com for a rapid reply.

An Open Letter To The Subscribers of The STONE

By Rick Grimes,
Director of External Affairs
The Philosophers Of Nature

Change is inevitable to all things. Youth gives way to maturity, darkness gives way to dawn, and organizations move, hopefully, forward into new territory. Such is the case with The Philosophers Of Nature.

If you are reading this issue of *The Stone* you are an old subscriber, a new subscriber, or one who is investigating The Philosophers Of Nature (PON) as a possible companion on your path of personal evolution. To all of you I wish to say, "Welcome." Welcome to the next phase of the PON's growth toward new heights and a broader scope. Our veteran subscribers are aware of some of our past challenges such as mailing *The STONE* on time, correctly collating ordered lessons, and legal issues delaying the release of seminar video tapes. To our patient and loyal members who stayed with us through these trials we extend our heartfelt thanks and appreciation. I am pleased to inform you all that we have prevailed through these trials and are now poised to launch what I call, **Phase III**.

First, a little history: **Phase I** began about eight years ago when, in cooperation with Mr. Jean Dubuis [founder and Past President of Les Philosophes de la Nature in France], the originators of The Philosophers of Nature in the USA procured his wonderful lessons in Esoterics, Qabala, Spagyrics & Alchemy. This was possible because Hans Nintzel, in his continual searching for valuable alchemical contacts had found the LPN in France. The lessons were then translated from the original French into English over a period of about seven years. Translating such meaningful material is expensive, and proofreading it is maddeningly tedious. Mr.

Dubuis' lessons are expansive and thorough, which implies an enormous commitment just to read them let alone correctly translate them. However, within this process and in spite of the difficulties PON was founded in the United States. The success of this initial phase was due to the generous efforts, time, money, and leadership provided by Past Presidents Bill Van Doren and Kevin Townley, the translation skills of Brigitte Donvez, and the long-standing efforts of Ken Miller, who held the communication lines together as editor of *The Stone*. Due to the foresight of Bill, Kevin, Brigitte, Ken, and Hans, Mr. Dubuis' legacy of rare knowledge and high wisdom is forever available to English-speaking seekers worldwide.

The contribution of these founding members, and others who are too many to mention here, will ever be honored and appreciated within PON for they built the foundation upon which all that shall proceed is based. Though we can expect their support and

"Our membership is growing, both domestically and internationally, therefore, our goals are formulated to establish a solid basis for continued service to all members."

interest in the ongoing development of PON we must appreciate their need to pursue other obligations to their families and professions. After all, over the past eight years they have given, and I mean *given*, more than could reasonably be expected of them.

During **Phase II**, which began early in 1992, PON's growth occurred under less than perfect conditions as some key people lived in separate States. This fact caused difficulties through communication delays and occasionally impaired important meetings; and then, there are the ongoing cost challenges. Undaunted, the directors expanded their publication scope from just lessons to memberships accompanied by the newsletter, *The STONE*, then two years old. Later that year, PON's next logical addition became evident -- a seminar. Sue and Russ House assumed the huge responsibility of hosting, organizing, and coordinating the seminars here in the United States. Also, they generously offered their own home as the site for the first two seminars. Thanks primarily to

them the seminar program has been, and continues to be, a great success.

Phase II also includes the initiation of our video program. Every seminar is recorded and safely archived. Previous seminars are available through VHS tape sales which are now a vital part of the PON's service. Imagine the virtues of viewing one of Flamel's workshops, or sitting in Basil Valentine's lab while he explains and demonstrates his theories about antimony? That same virtue is contained in our ongoing video record.

So -- where are we now?

Phase III begins with a new Board of Directors who all live in the Chicago area and lack the obstacles that plagued the previous board; we can now meet easily and work together efficiently. The new board will operate fiscally within well-defined protocols and the parameters of a clear mission. Our membership is growing, both domestically and internationally, therefore, our goals are formulated to establish a solid basis for continued service to all members.

Elements of expanding service include:

The PON lessons:

These valuable lessons are undergoing an upgrade in print quality, page format, typo correction, and -- in some instances -- material expansion.

Important Announcement: *Complete sections of the courses can now be bought and will be shipped in their entirety as bound volumes. Keep your eye on the next issue of **The STONE** for ordering information. Reformatted lessons will be announced as they are completed.*

Video Tapes:

We are finally in a position to release for sale a rather impressive selection of past seminar Video tapes. Please note: Where handouts were given in seminars, those same handouts will be copied and provided with

their respective video tapes. Look for the video announcement and order form in this issue.

The STONE

- A. **The STONE** will get an update in format, style, and content, with an emphasis toward interaction with subscribers through contributed articles, lab reports, and Q&A sections.
- B. Subscribers will receive **The Stone** six times a year [every odd month] and *ON TIME!*
- C. **The Stone** is now published in English, however, the translation of **The STONE** and the lessons into other languages is also an important part of our long range plans.

The WEB:

PON is on the WEB! If you haven't visited the PON Internet site, please do.

Go to <http://www.mcs.net/~alchemy/>. You'll find Jean Dubuis' lesson samples, a list of past **STONE** articles, a few *sample Stone* articles, and, as they occur, important announcements including upcoming PON Seminars with WEB links to hotel accommodations, car rental services, flight reservation services, and much more. For those of you interested in alchemical resources the PON web page is a *must have* bookmark in your web browser.

For there to be long term durability the PON organizational task requires great concentration upon its structure. At this point in time, Sue and Russ House, Walter Griffin, Jim Gilmour, and myself, are here in Chicago and willing to make the required effort. Once the new structure is smoothly in place we all desire a robust involvement from members -- anyone, anywhere, who would want to succeed us in our positions and serve either on an advisory team or on the Board of Directors. With the ease of communication we enjoy today it is reasonable to assume, and perhaps even desirable, that future members of the Board of Directors be located in more diverse locations including different countries. But, the essential point is this: besides experiential

qualification, effective board participation requires only one additional requirement; a commitment to do the job efficiently for the term of the accepted office.

By all means please feel free to make suggestions, offer your critiques, or just drop me a line to let us know how we're doing. With your help and participation, the PON will continue to grow into a world wide beacon for true enlightenment.

In Love, Peace, and Light, I remain your Brother in the work,



ABOUT THE STONE

The Stone provides a forum for articles (5000 word maximum), conference announcements, research summaries and other items of interest to PON members and our subscribers. Authors should, if possible, submit manuscripts as an email attachment to alchemy@mcs.com using a plain text (ASCII format) or mail them on disk along with unmarked, printed copies. Publication decisions are normally made within four to six weeks. Selected articles from *The Stone* will be republished on the PON Internet site of PON at the discretion of the editors.

The Stone is published every two months, and is normally mailed on the 2nd Monday of the odd-numbered months.

Subscriptions to *The Stone* are \$30.00 US per year for non-members, and are free to active members. Membership dues are \$30.00 US per year. Subscriptions are for January through December – all back issues for current year are sent to new subscribers. Add \$10.00 for foreign postage. Make payment by credit card or by check drawn on a bank with a US branch.

Send all inquiries to: **The Philosophers of Nature**
125 West Front Street, Suite 263, Wheaton, IL 60187 USA

This poem is one of the newer creations of a long-time member in Canada. One of his works was recently published in the Best Poems of 1996 by the National Library of Poetry. Jim has had some of his works appear to him line by line, and he transcribes them.

BEAUTY

by Jim A. Dery

*Seeing creation through the eyes of God
 Viewing the world from above.
 Looking through luminous white clouds
 Softly drifting across the sky.*

*Watching a bird as it sings to it's young
 Feeding their many open mouths
 Til they have had their fill.
 Being alive with a feeling of joy in existence.*

*Riding out with the waves
 And coming in with the tide
 Eternally aware of each moment
 As a dazzling jewel in a vast ocean of experience.*

Prisca and Beat Krummenacher-Geiger
 of Switzerland announced
 the birth of their son,
Valentin Florian,
 on October 1, 1996.

Congratulations !

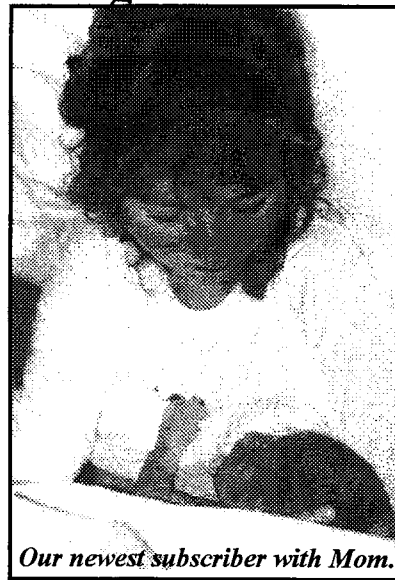

Our newest subscriber with Mom.

Research Programs -- Ora Et Labora

by Russ House

The Philosophers of Nature is a research organization, which disseminates the findings of its members through lessons, video tapes, lectures, and various publications. In the earlier stages of the association's development, it has not been possible to carry out new research in any coherent way that added to the research lead by Jean Dubuis and others in France. For the most part, except for some few seminars, there has not been a significant release of information from other sources.

Our members do conduct research, but generally in isolation. Each new piece of information can not build upon the work of others. In a sense, we are lacking the 'seed crystals' to help act as a foundation and point of collection so that we might accomplish something together.

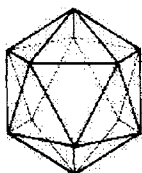

We are happy to announce that we have identified some 'good seeds,' who can help us to bear good fruit. These individuals are Ken Miller, Curt Kobylarz-Schmidt, and Walter Griffin, each a research director for a specific project.

There are three separate research areas, whose names create the phrase "ORA ET LABORA".

ORA represents the Occult Research & Application project. Ken Miller of San Diego, California first announced this project in *The Stone* in July 1995. Research subjects will include magic, qabala and other occult subjects. Ken recently gave an insightful presentation at the PON seminar in Colorado Springs; he offered an interesting and thought provoking explanation of the belief systems of the time of noted magician Cornelius Agrippa.

ET represents the Entrainment Technology project. This will include research on devices using light, sound, magnetic fields and electrical stimulation to entrain brain waves. Research Director Walter Griffin of Chicago, Illinois has had many experiences using various devices for this purpose, including

commercial units, as well as prototypes developed by Jean Dubuis using new technology. Walter made a presentation about his experiences and answered questions for many interested people during the most recent PON seminar in October, in Glen Ellyn, IL.

LABORA is the Alchemical and Spagyric research project. (As a joke, I considered naming it "Laboratory Activities Bordering On Real Alchemy".) Curt Kobylarz-Schmidt, Research Director, has offered energetic, information-packed presentations at the annual seminars in 1994 and 1996. The video tapes of these presentations are in high demand (see ad on back page) because they offer practical information not otherwise available. Curt lives in Anaheim, California.

These individuals are not responsible for *doing* the research, even though they are each actively involved in such. Their primary responsibility is in stimulating, supporting, encouraging, and organizing research activities by our members. Each will also publish progress reports regarding the research projects in *The Stone* or in special supplemental papers each six months. As there are three projects, this means that there will be a research report published in each issue of *The Stone*, beginning with the January 1997 issue.

If you would like to participate in research in one or more of these fields, please forward your name, address, telephone number, email address (if available), and your specific interests to the research directors:

ORA Project	(reports in May & November)
c/o Ken Miller, PO Box 161213, San Diego, CA 92176 USA Email: kdmusa@aol.com	
ET Project	(reports in March & September)
Philosophers of Nature "ET" 125 West Front Street, Suite 263, Wheaton, IL 60187 USA Email: WalterG@fs-gate.uchicago.edu	
LABORA Project	(reports in January & July)
Philosophers of Nature "LABORA" 125 West Front Street, Suite 263, Wheaton, IL 60187 USA Email: alchemy@mcs.com Type "LABORA" in message.	

The Unspoken Essential

by Joseph Caezza

I recall with great joy the event of Manfred Junius's first American Alchemical class at the Texas home of Hans Nintzel in July of 1990. German born Junius, the author of the now classic *Practical Handbook Of Plant Alchemy* had spent 18 years as professor of Biology at the University of Calcutta in India where he also won the *Sangitacharya*, the highest title awarded to a student of classical Hindustani music. Junius mastered Ayurvedic medicine as a student of the internationally known authority, Dr. Bhagwan Dash and furthered his knowledge of the western Hermetic tradition with the Swiss Alchemist Augusto Pincaldi. Hans Nintzel, who has yet to be recognized for his efforts to preserve our tradition, put together a one of a kind teaching event featuring this towering pinnacle of Alchemical wisdom.

Many former students of Frater Albertus were momentarily reunited. Albertus's *Alchemist's Handbook* remains an outstanding guide to the laboratory operator. An explosive energy echoed through the intense dialogue of attendees. People of the most diverse backgrounds indulged the precious opportunity to share personal experiences. The air resonated with tales of power and healing miracles. As a seed only germinating our organization, **The Philosophers Of Nature**, marked a great stride in its embryonic growth in the presence of warmth and nourishment.

I recall the veteran Alchemist, Art Kunkin, interrupting Junius's lecture to explain that beyond all the brilliant discourse there was an *unspoken essential* to the Great Work. This essential by its very nature can not be explicated. One either knows it or one does not.

Kunkin, the founder of the notorious *L.A. Free Press* of the sixties went on to pursue a distinguished career as an esotericist. He studied alchemy with Frater Albertus, served as librarian at Paracelsus College and more recently assumed temporary leadership of the Philosophical Research Society after the death of its legendary founder, Manley Palmer Hall. Perhaps it was his personal experience in the Tibetan Alchemical Tradition of Bon Dzog Chen that caused Art to make his remark about the unspoken essential. What was he talking about? No one seemed to know.

“Our Great Work is not technology but perception refined beyond the labor of applied artistic intensity to the level of pious contemplation and exalted prayer.” ... Joseph Caezza

Classical Hermetic texts refer cryptically to the "*Materia Prima*", the obvious starting point of the Great Work. The nature of this material is not communicable. Lao Tzu tells us "The name that can be named is not the Name. The way that can be walked is not the Way. (1)" Adepts emphasize that the *materia prima* is everywhere to be found and at all times available yet overlooked by the multitudes as useless.

Martinus Rulandus's classic *Lexicon of Alchemy*, (1612) presents fifty different descriptions of the *materia prima*. The present edition of this tome lists an additional eighty-four names of this ambiguous yet essential starting point of alchemical manipulation.

"The matter of the Magnum Opus is the subject on which the philosophers exercise their practical science. All who have written on this art have concealed the true name of this matter, as the chief key of chemistry. Having potentially all the qualities and properties of elementary things, they have given it names of all kinds of things. It is the fifth element, a quintessence, the material beginning and end of all things (2)".

Morienus, twelfth century Christian anchorite describes the nature of the *materia prima* to the Arab King Khalid:

Morienus: *"As an authority has said, it is therefor both rich and poor, for the generous and the greedy, for him who runs and him who sits. It is cast in the streets and trampled in the dung. But let none take pains to extract it. Fools have often wasted much zeal on the dung in hopes of extracting it. But they have acted in ignorance. The wise know that this unique thing is hidden and that it is what contains the **four elements** within itself having power over them."*

King Khalid said: *"Tell me where the sources of this thing are, whence it may be gathered as there is need of it."*

But Morienus fell silent and casting his gaze downward, reflected deeply for some time. Then he raised his head and spoke: "Truly, this matter is that created by God which is firmly captive within you yourself inseparable from you, wherever you be, and any creature of God deprived of it will die. "...

"What more can I tell you? For this matter comes from you, who are yourself its source, where it is found and whence it is taken, and when you see this your zeal for it will increase. Consider this, and you will find that it is true" (3).

Creation is continuous. At each moment the universe coagulates and dissolves. That moment of imbalance between past and future, that critical cubic centimeter of Divine possibility is a moment of instability where we perform our Alchemy outside of time and the normal succession of nature. Moments of eternity, ruptures sponsored by profoundly deepened perception create gaps in the normal sensual experience where we may commune with that essential archetypal process of nature. Such communion will inspire us to execute the proper gesture in the appropriate milieu at the correct time.

Our Great Work is not technology but perception refined beyond the labor of applied artistic intensity to the level of pious contemplation and exalted prayer. We read the texts not for the sake of

discovering recipes or techniques but rather to cultivate mystic perception. Thus the texts are ends in themselves and the greatest adepts have most often been monastic representatives of the traditional religions.

The attributes of stone, concrete stoneness, its density, concentration and passiveness provide the best description of this amplified qualitatively enhanced perception. This underlying substratum of consciousness supports the sensual experience of life. What are the senses and who do they inform? The elegant relation between senses and elements too often eludes us. Sight perceives fiery light. Smell perceives air. Taste perceives water. Touch perceives earth. The ear perceives quintessential harmony. Hence adepts admonish us to concentrate and purify the four elements because nothing is separate outside of our sense perception.

An appropriately applied Alchemical perception allows the normal space time continuum, the veritable fabric of the universe, to snag within our Hermetically sealed vessel. An opening is created. This rupture facilitates a moment of eternity within the nuclear structure of the worked substance.

Perception is reality. Alchemical consciousness has no toleration for the false separation of experience into subject and object. We must learn to see with our hearts.

The heart sees where the mind is blind. The senses must be reeducated. To truly "know" our worked materials we must identify with them to the extreme of coital fusion. The consequences of this union constitute a creative state analogous to the origin of the universe. Here is the ONE that is ALL. Hortulanus explains: "Our stone is made the same way the universe is created." (4) The Sri Yantra of Tantrism is a living signature of this concept. (*Fig. 1*)

Our first duty after Divine invocation involves observance of the laws and ordering principles of Nature; Sulfur, Mercury, Salt and their corresponding elements: Fire, Air, Water and Earth.

Figure 1: Sri Yantra

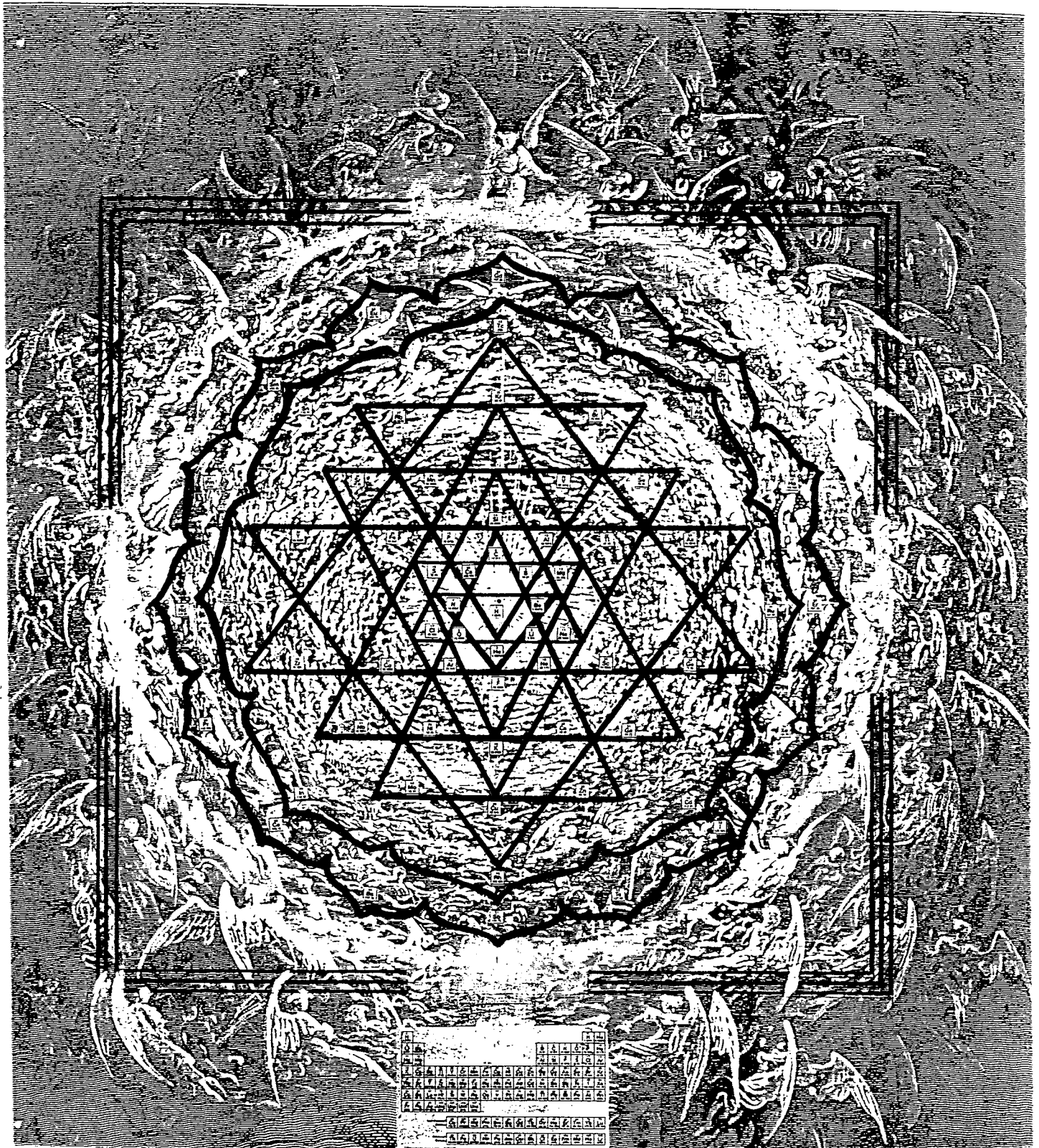

The next step referred to by the great Benedictine Monk, Basil Valentine, as "the true and unadulterated preparation" concerns the familiar laboratory manipulations. Our applications must correspond accurately to the deepest laws of Nature. The perception of the operator must be as pure as possible. Attention must be powerfully applied to the creative process. Concentration must be highly focused. Then the subatomic level of the materials worked transforms. The worked materials behave in a radically different way. Apparently dead matter revives enlivened not by our efforts but with the indispensable aide of Providence. The archetypal process of Nature now reveals herself in the well-known color changes that marked the stages of the Great Work. Live natural color is always only a cyclical happening that defines the stages of natural growth. Our incubating Hermetically sealed flask displays the classic pattern of creative unfolding as the ordering principles of Nature are brought to the surface of perception.

Our error remains our radically incomplete habit of perception. Such habit separates us from the fullest possible experience of the world. Could this be the *unspoken essential* of the Great Work?

REFERENCES

1. Lao Tzu; *Tao Te Ching*, The Texts of Taoism, The Sacred Books of China, trans. James Legge, Ed., Max Muller, Vol. 39, Oxford University Press, 1891
2. Rulandus, Martinus; *Lexicon Of Alchemy* (1612) Frankfurt, Zachariah Palthenus, pg. 220
3. Stavenhagen, Lee; trans. *A Testament Of Alchemy*, Brandeis University Press, (1974), pg. 27
4. Internet resource:
<http://www.colloquium.co.uk/alchemy/hortulan.html> Chapter XI

al-Kimia, the Sacred Art

by John Eberly

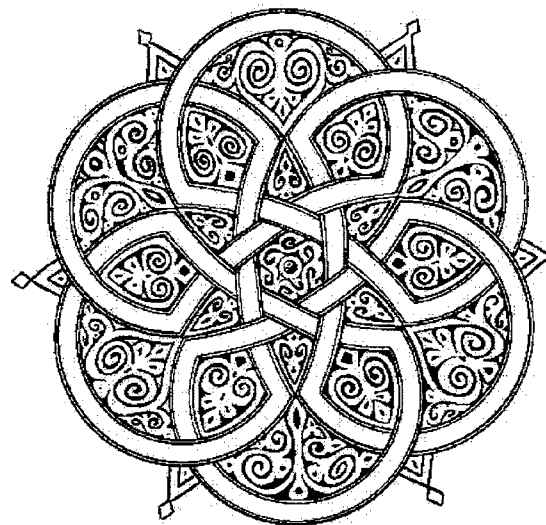

"al-Kimia, the Sacred Art" is culled from Chapter 9 of John Eberly's book al-Kimia: The Mystical Islamic Essence of the Sacred Art of Alchemy, Anamnesis Press, 1995, available directly from the author at 11105 S. Partridge Rd, Partridge, KS 66567.

"This gold is our male, and it is sexually joined to a more crude white gold -- the female seed: the two together being indissolubly united, constitute our fruitful Hermaphrodite." - Philalethes

It is common when reading alchemical texts for the reader to observe consistent references to the practice of al-Kimia as "our art", "this art" or "the art" or descriptions of the way to accomplish an alchemical process: "by art" or "with art." This use of the term art refers to the alchemist's understanding not only of the concepts and theories of all the Arts, but also implies the plastic applications involved in undertaking any actual *work* of art.

This is the *Ars Magna* in which there is no context concerning the word art that cannot be applied also to the whole concept of Alchemy. The Arts in the modern world have been

specialized and separated into arbitrary categories; whereas the art of al-Kimia, which encompasses these categories and beyond, has remained all-inclusive.

What follows is a brief discussion on the subject of color, followed by an equally cursory glance at some of the arts of antiquity and some of their apparent relationships with al-Kimia and esoteric Islam. The correspondences drawn are at times broad; it should become obvious that this subject generally deserves more time and space than is admitted in the present study.

With some variation the primary colors usually correspond to the four active elements found in al-Kimia: Fire/Red, Air/Yellow, Water/Green, and Earth/Blue. Fire is hot and dry, Air is hot and wet, Water is cold and wet, and Earth is cold and dry.

The Resala-ye lama'at was resala-ye estelahat of 'Iraqi edited by Dr. Javad Nurbakhsh, states:

"Redness represents strength in the traveling of the Path.

Yellowness is said to represent weakness in the traveling of the Path.

Blueness is said to represent the blending of loving-kindness (*mahabbat*) with whatever is other than loving-kindness.

Greenness represents absolute perfection."(1)

By dividing them into seven: the group of four primaries already mentioned representing Nature, and another three that relate to Spirit, usually white, black and orange (or sandalwood); by assigning these colors to the planets that rule each day of the week, an alchemical marriage is performed which is closely related to the marriage of the quaternary of the elements Fire, Air, Water, and Earth, and the principal ternary Sulphur, Mercury, and Salt.

In classical alchemical terminology, the *Nigredo* or black stage of the alchemical work is generally associated with putrefaction. The *Albedo* or white stage is most often associated with a step in

the calcination process although it may obviously have other connotations as well. The *Rubedo* stage represents the formation of the Red Solar Stone or the Red Sulphur, the *kibrit al-ahmar*.

It is interesting that with few exceptions, the Sun is identified with the male and the Moon with the female. (2) In the symbolism of al-Kimia the former represents sulphur and the later mercury. When these two are joined in marriage, the *Conjunctio* is achieved, the spiritualization of the material. The Sun is symbolic of the Light of God, which reflects brightly upon the Moon, symbolized by the heart or *qalb* in Sufism. The mirror heart of the mystic manifests and embodies the light or *Nur* of the Divine.

Isaac Newton, an oft forgotten practitioner of Alchemy, in 1666 found that when white light passed through a prism, it divided into bands of color that make up the visible spectrum. This led to the theory of color as light vibrating at different wavelengths, which when combined produce a white light.

Henry Corbin in his essay "The Realism and Symbolism of Colours in Shi'ite Cosmology" in the book of his collected essays entitled Temple and Contemplation, (3), describes the color theory of the Shi'ite alchemist Shaykh Muhammad Karim-Khan Kirmani (d. 1870). In this Shaykh's view, which is clearly Platonic, color exists as an archetype. Yet like all archetypes which proceed from the One source they exist *potentially* in this union and therefore exist before they are manifested as colors discernible to our physical eyes. Perhaps from the point of view of Unity these two theories have more in common than initially "meets the eye."

In another book by Henry Corbin titled The Man of Light in Iranian Sufism, (4) one finds another alchemist, the Sufi master and founder of the Kobrawiyya Order, Abo'l-Jannab Najmo'd-Din ibn 'Omar al-Kobra (b. 1145 A.D.). Kobra formulated a theory based on *tajalli* or theophany, in which a person becomes a receptacle for divine perceptions by developing

specifically the sensory and supersensory organs of perception.

Another work on Kobra edited by F. Meier titled Fawaih al-gamal wa fawatih al-galal, states Kobra's description of this theory in action:

"When you see before you a vast expanse opening out toward the distance, there is clear air above you and you see on the far horizon colors such as green, red, yellow, and blue, know that you are going to pass through that air to where those colors are. The colors pertain to spiritual states. Green is the sign of life of the heart (this being the highest state). The color of pure fire indicates the life of spiritual concentration' (himma), which denotes power (of actualization). If this fire be dark, that betokens the fire of exertion and shows the seeker to be weary and afflicted after the battle with the lower ego and the Devil. Blue is the color of the life of the ego. Yellow is the color of lassitude. All these are supra-sensory realities that speak with him who experiences them in the two languages of inner tasting (dhawq) and visionary apperception. These are two reliable, mutually corroboratory witnesses: what you behold with inner vision you also experience within yourself, and what you experience inwardly you also behold with inner vision." (5)

When the Man of Light approaches the color green, he sees a circular Sun-like countenance, which Kobra recognizes:

"This face is, in reality, your own face and this sun is the Sun of the Spirit which oscillates within your body. Then your entire body is immersed in purity, and at that moment you see before you a person made of light, who generates lights. The spiritual traveler, too, then experiences his entire body as generating lights. It may be that the veil will fall from all individuality, so that you see totality through the totality of your body. The faculty of inner vision is opened first in the eyes, then the face, then the breast, then in the whole body. This person of light in front of you is called by the People

(Sufis) the 'Suprasensory Guide', and is also known as the 'Suprasensory (Personal) Master' or the 'Suprasensory Scales (of Judgment).'" (6)

The unity of the warp and the weave of the beautifully designed carpets of the Middle East make use of color theory much in the same way that Persian miniatures are conceived and produced. The art of dyeing fabric utilizes a process of tincturing the color from plants and other substances and thus stands as one of the original alchemical manipulations of Nature.

Much has been written on the esoteric arts of Islam which include calligraphy, architecture, miniatures, and book illumination, which often

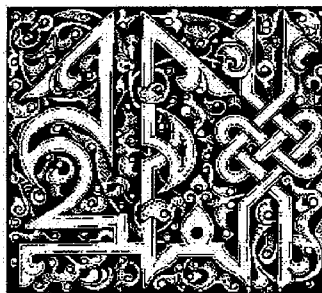

incorporate elaborate calligraphy including the *arabesque*. In general, Islamic artwork denies the human physical form in favor of the geometric. Stylized flora and other creaturely forms derived from

Nature are, however, often considered acceptable and not in danger of "idolization".

The unique exceptional beauty of the Persian miniature is usually found accompanying historical text or poetry. The letters written by al-Hallaj were said to have been illuminated and colored upon precious material. Manichaean illuminated holy books belong to this tradition as well as early Christian iconography.

Tradition tells us that when Muhammad ordered the removal of all idols from the holy Kaaba, the original temple believed to have been built by Abraham in Mecca, the inside walls were covered with paintings of pagan deities also destined to be painted over. Muhammad placed his hands over an icon of the Virgin Mary and the child Jesus and also a tiny painting presumed to be of Abraham. These were spared the blank painted overlay.

Two authors, often identified with the Traditional school, S. H. Nasr and Titus Burckhardt have written many works on the subject of Islamic art including the former's Islamic Art and Spirituality, and Knowledge and the Sacred; and the later's Mirror of the Intellect, and Sacred Art in East and West. (7) These distinguished scholars have each treated at length the importance of the Void in Islamic art which is considered as negative space in the West. (8)

The Void, which is at once dynamic and stable, is the perfect model for the ground of all being, the place wherefrom all things proceed and recede (or re-seed) in Absolute Unity. The Void is related to both *fana* (annihilation) and *baqa* (subsistence) in Sufism, and the path of *via negativa* in Christianity. It is the silence of the sages, the blank tablet awaiting revelation. It is represented by the "whiteness" of which 'Iraqi says: "*(Whiteness) represents the integrity achieved through complete attention to God and severance from what is other than God.*" (9)

The Void then, considered "hidden treasure", wishes to be revealed by imagery, cipher, and symbol; in a conscious form.

"I was a hidden treasure and I loved to be known, so I created the world so that I might be known."

-hadith qudsi

The alchemist is the consummate artist who reveals God to Himself by ultimately acting as a *nabi*, a prophet sent to himself from Himself. By *anamnesis* or self-remembering his Divine origin, he recalls and activates this cosmic presence and purpose. He is a spiritual evolutionist working on, at least, the physical plane.

Thoth-Hermes (Mercury) traditionally is considered to be the intermediary or originator of all language, of all arts and sciences, all alphabets, in short, the angel or god-like messenger of all symbolic knowledge emanating from God. An alchemist is the one who reveals by *art* the Hermetic identity realized by

remembrance, or *zikr*, the Word, or Name of God.

In their texts, Islamic alchemists rarely depend on symbol beyond what is found naturally occurring in revelatory language. The practice of using secret symbols and alphabets, however, abounds in the alchemical texts found in Europe in the Middle Ages. The origins of these practices may be traced directly to early Hermeticism and consequently to systems such as *jafr*.

In the middle period in European history, alchemical art most often takes the form of engravings, emblems, and paintings which are frequently incorporated in illuminated texts. Contemporary scholar Stanislas Klossowski de Rola has accomplished much in renewing interest in these arts with his books *The Golden Game: Alchemical Engravings of the Seventeenth Century*, and *Alchemy: The Secret Art*. Adam McLean's work in this vein is also worthy of note, especially his commentaries, which are most "illuminating." His entire *Magnum Opus Hermetic Sourceworks* series is highly recommended.

Perhaps the doctrinal non-human-formal rigidity of the arts of Islam forced the hand of artistic total abstraction, based in greater part on a geometry in which a continually diminishing variable approaches zero as its limit, the Void.

What comes out of the "Void from which all things proceed" in the general world of abstract figurative arts must remain the subject of large, unwieldy art history tomes.

It is necessary to look at a few broadly related abstract forms and attempt to attribute at least part of their symbolic significance to al-Kimia, the Sacred Art.

The *Ishtar Gate* from Babylon, Iraq (c. 575 B.C.) was one of the eight gates leading into the city of Babylon, where Nebuchadnezzar built his palace complete with the *ziggurat* which is

considered to have been the Biblical Tower of Babel.

The gate, which has been restored and installed in the Vorderasiatisches Museum in Berlin, is faced with beautiful glazed brick in a background of royal blue with geometric ornamentation in white and gold. Widely spaced stylized bulls and dragons in raised relief are composed of several separately molded and glazed bricks.

According to Babylonian tradition, the goddess Ishtar, who is identified with the planet Venus, which governs both love and war, descended to Hades to get the *water of life* with which she restored to life the dead Thammuz. Thammuz is then described as dwelling in the midst of a great tree at the center of the earth. The description of the divine which descends, the reference to calcination (Hades), and the *return* with the elixir (the water of life) for the dead one resurrected to life at the point of the divine center, and the tree of knowledge which may be identified as the *Tuba*, evokes a striking alchemical allegory.

The *arabesque* and the geometrical intricacy of Islamic art which has its spiritual/material antecedent in the weaver's loom is related to the Animal Style of the "Barbaric" European nomads. The Animal Style influenced the illuminated complexity of some Hiberno-Saxon art, especially illuminated gospels such as the Irish Book of Kells (c. A.D. 760-820). The hide and seek aspect of this artistic development has affinity with the Islamic Void from which exegesis, and for that matter its opposite concealment, proceeds. Again, a point of reference may be the use of *jafr* in the interpretation of al-Qu'ran, however; the concept of a divinity which is hidden and also at times revealed is complex and indeed *the original model*.

The search for the origins of the highly abstract and so-called monstrous symbolic bestiaries of the illustrated alchemical texts of Medieval Europe may begin where the art of al-Kimia as we know it began, in ancient *Kem* (Egypt).

In *Kem* a prelogical hieroglyphic picture script carries a series of meaningful correspondences in silence with alchemical emblem texts, such as the Mutus Liber by Altus (1677). (10) When an attempt is made to decipher this silent correspondence we are inevitably confronted with the larger mystery of our own symbolic existence. When reason is confounded in this way a void appears which may precipitate revelation.

The contemporary West places emphasis upon literal meaning in the interpretation of two-dimensional and three-dimensional art. According to this viewpoint Art must exist by explanation only, and this process is defined absolutely by the choice and the arrangement of language. If the explanation is satisfactory, then a confident explanation follows that attempts to resolve what the work of art might "mean". In the end, this art criticism only serves to perpetuate itself by verbal expression, an oral and consequentially literal supposition of meaning in which symbol refers to symbol and serves language and logic but by no means brings about a complete understanding (which must include a "non-understanding") of the artwork.

What stands under the surface, at the same time it exists on the surface for the organs of perception, is essentially a non-verbal experience, a silent recognition by spirit of symbol. The act of looking then becomes a means to activate a form of spiritual participation in which subject and object become One. in this perception in which the external experience joins with the internal consciousness is found pure *form* devoid of the processes of verbal expression, memory, and even creative imagination. To participate with image it is not a simple matter of the visual contemplation of the object, but also a search for the artist, the gesture of the hand, the thought behind the gesture, the alchemical process of looking and transforming Nature into Art.

Students of revelatory texts, including all good alchemical texts, do well to slowly savor even the image of a single word and to look at the text

again and again at different intervals of time to gain the basic intent of the artist/author, the gesture of grace, which is only relevant to the *present moment*.

"A single cup is sufficient to reveal the flavor of a wine, and a single word from a hesychast can reveal to those with taste his whole inner condition and activity." (11)

-John Climacus

Of course, hieroglyphics often accompany larger paintings as a running pictographic text, and to carry on the initial comparison, certainly most alchemical engravings are found in text books. Consider Michael Maier's (1568-1622) remarkable Atalanta Fugiens, (12) which combines fifty outstanding engravings with fifty accompanying epigrams in Latin with their own translation in German verse, with fifty fugues which musically correspond to the artwork and the text!

With the incredible bias of the English language ill-fitted to a scarcely glimpsed and much less understood (since the deciphering of the Rosetta Stone in 1821) Egyptian world-view based on *formal* intuition, now let us, like so many amateur Egyptologists, forge ahead blindly through the corridors of time and space to the image of the Sphinx, that most ancient and silent of sages, who, as Fulcanelli says of Nature generally: "...does not open the door of the sanctuary indiscriminately to everyone." (13)

The Sphinx, a hybrid of man and beast shall be the symbol, the model for this next step of our study. This monumental sculpture, inscrutable and still as *stone*, was and presumably remains a central symbol of *Kem*, or part of a "text" of al-Kimia which can be deciphered and read by adepts much like the sculpture and architecture of the French cathedrals examined by Fulcanelli. (14) Tehuti or Thoth, the figure associated with Hermes in ancient Egypt, is himself depicted as a hieroglyphic Ibis-headed hybrid.

Certainly the Pyramids are early al-Kimical symbols which culminate in the point of divine origin (15) and then proceed downward, like the rays of the Sun (*Ra*) in the expansive gesture of the Divine Mercy (*ar-Rahman*). The symbol of the triangle is synonymous with sulphur, or Sol, the Sun, which ancient Egyptians believed was coalesced in the earth as metallic gold.

The *ziggurats* of early Mesopotamia served a different and yet similar function as artificial mountains, high places designed for ritual worship in which proximity encouraged the union of participant and deity.

The *idea* as a *form*, as a messenger of God flying from the Void to the Earth may be considered in the concept of an angel. Birds are also traditional symbolic intermediaries between the material and spiritual worlds. The union of the idea of bird with angel in Mazdean Iran becomes, in later usage, an emblem of the Holy Spirit. (16)

At the gate of the Palace of King Sargon II, are found large relief sculptures of lion-like beings with the bodies of bulls, diagonally elevated wings, and human heads with long curly beards and many-tiered divine headdresses. Compare these wonderful and fantastic beings with the image found in a version of the *Ripley Scrowle* drawn by James Standysh in the 16th century on page 96 of Stanislaw de Rola's Alchemy: The Secret Art, which bears a caption that begins: "The bird of Hermes is my name..."

The "Night Journey", or *Mi'raj*; the ascension of Muhammad to the "Lote tree of the uttermost limit," the nearest proximity allowed to being in the presence of God, was accomplished by his riding a fantastic horse-like being with wings called *al-Buraq*. This mount was supplied by the Archangel Jabriel. In India, *al-Buraq* is depicted with the face of a woman and the tail of a peacock and has been described as being symbolic of the intellect. The peacock is also an alchemical symbol for the multiple color changes which occur during the purification of the base material.

River deities and other "monsters of the imagination" found throughout antiquity are subtle links between the spiritual and material. In Greek mythology the *Chimera* is a fire-breathing monster with a lion's head, a goat's body, and a serpent's tail. It is said that the Sphinx, and the Nemean Lion, which Heracles killed as his first labor, were the offspring of the Chimera and Orthos, a two-headed dog killed by Heracles in the course of completing his tenth labor.

Pan, the god of pandemonium, panic, and pantheism was the offspring of Hermes and Dryope, a nymph of Lemnos who was changed into a tree; she is also associated with a fountain called Pegae. Pan is described as a being part-man and part-goat, who invented the flute with seven reeds, signifying the seven planetary spheres. The name Pan signifies the *All*, and his domain is at once universal and particularly identified with Nature in the wild. His sun-like face and upturned horns, which represent the traditional symbol of the moon, remind one of the Crescent (moon) and Star (sun), the central symbol(s) of Islam. The embodiment of symbolism found in Pan makes him the perfect image of the philosophic Mercury, which is at once solar and lunar. For a wonderful representation of Pan, see the illustration by an anonymous artist of the 14th century reproduced on page 75 of *Alchemy: The Secret Art* by Stanislas Klossowski de Rola.

Gargoyles in Medieval cathedrals have often been thought of as reminders of Hyle or Chaos, and the presence of the irrational as the basis or intrinsic element of an otherwise reasonable order.

The lofty position of these hybrids on the tops of the cathedrals Fulcanelli defines as virtual textbooks of Alchemy, however, suggests that they also may symbolize steps in the process or even the completion of the Work, the new thing, the marriage of opposites which spiritually transforms Nature and resolves all conflict, all

duality. In his masterwork *Le Mystere des Cathedrales*, (17) Fulcanelli identifies a figure in stone as The Alchemist in the vicinity of the highest part of the main axis of the North tower of the cathedral of Notre Dame in Paris. On page 14 of the book entitled *Notre Dame de Paris* is found a photo with a broader angle than the plate containing Fulcanelli's Alchemist in *Le Mystere des Cathedrales*. In this photo we see that The Alchemist is situated next to the sculpture of a curious Gargoyle with the head of a dog or lion and the claws of an eagle; a muscular human frame and prominent feminine breasts.

Plate two of a group of four plates from Steffan Michelspacher's *Cabala, Spiegel der Kunst und Nature*, (Augsburg, 1616) contains a hybrid beast with three feminine udders which also bears the characteristics of the Four Holy Living Creatures: the Bull's horns, the Man's face, the Lion's body, and the Eagle's talons.

In the text attributed to Hermes Trismegistos titled *The Poimondres* (19), there are several references to the bisexuality of God and the sacred androgynous nature in which mind (*nous*) is male and substantive, while thought (*epinoia* and *ennoia*) as process, is considered female. The conjunction of the two sexes becomes a sacrament of the heavenly love found in all beings, indeed, found in all of creation.

Paracelsus defines the Rebis as a bisexual thing combining the two antitheses in the highest and most desirable degree of the process of transmutation-totality.

Fulcanelli refers to the Rebis as, "...a double matter, at once both dry and humid, the amalgam of philosophic gold and mercury, a combination which has received a double occult property, exactly equilibrated, from nature and from art." (20)

The alchemical marriage of philosophical sulphur and mercury, sun and moon, as a central symbol of Alchemy is often depicted in paintings found

in later European texts by a two-headed human being with the sexual apparatus of both male and female. This is the symbol, the culmination of the union of opposites in the coitus, the compelling force at work in the universe, Eros.

Concerning the *erotism* which mixes the forces of death and life in a sensual form of the creative act crystallized in the image of the androgyne or hermaphrodite, a term which comes from the joining of Hermaphroditos, the son of Hermes and Aphrodite, the goddess of Love, with the body of the nymph Salmacis, George Bataille says:

"It is the common business of sacrifice to bring life and death into harmony, to give death the upsurge of life, life the momentousness and the vertigo of death opening on to the unknown. Here life is mingled with death, but simultaneously death is a sign of life." (21)

This sacrifice of a most intimate aspect of presumed individuality for the sake of the creation of the truly individual perfected nature is the holy art and union of life in which each part is invited to participate and join with the whole in the unity which denies all opposition.

The *art* of al-Kimia is nothing if not an articulation and manipulation of this basic and naturally sacred process.

Notes To Chapter Nine

1. Traqi. Resala-ye lama'at was resala-ye estelahat, Ed. by Dr. Javad Nurbakhsh. Tehran, 1974. See also the 12 vol. encyclopedia: Sufi Symbolism by Dr. Javad Nurbakhsh for a thorough examination of virtually all aspects of the science of Sufi symbolism.
2. However, this is not always the case. See: "The Marriage of Sun and Moon" by Arthur Verluise in 'Avaloka, A Journal of traditional Religion and Culture', Vol. IV, No. 1 & 2, pages 30-39.
3. See: Henry Corbin, Temple and Contemplation. KPI. London, 1986, Chapter One.
4. See: Henry Corbin, The Man of Light In Iranian Sufism. Shambala. Boulder, 1978.
5. See: F. Meier. Fawaih al-gamal wa fawatih al-galal. 1963.
6. *Ibid.*, pages 31-32.
7. See: John Eberly, al-Kimia: The Mystical Islamic Essence of the Sacred Art of Alchemy, Bibliography.
8. See: Nasr's essay "The Significance of the Void in Islamic Art" and also Burckhardt's essay "The Void in Islamic Art".
9. See: the first section of Note 1.
10. See: Adam McLean. A Commentary on the Mutus Liber. Phanes, Grand Rapids, 1991.
11. St. John Climacus. The Ladder of Divine Ascent. Palest Press. Ramsey, 1982. pg. 273. A *hesychast* is one who is master of the 'prayer of the heart' or the 'Jesus prayer' which works on the inner being of the Christian practitioner much in the same way as the *zikr* in Sufism, or the Hindu *mantra*.
12. See: al-Kimia: Bibliography.
13. Mary Sworder. Fulcanelli Master Alchemist: Esoteric Interpretation of the Hermetic Symbols of the Great Work. A Translation of Fulcanelli's *Le Mystere des Cathedrales*. Brotherhood of Life. Albuquerque, 1984, page 175.
14. *Ibid.*
15. See: al-Kimia: Chapter Eight, "Shu'ayb ibn al-Husayn al'Ansari Abu Madyan" for the symbolism of Mount Qaf, and also see: al-Kimia: the "Preface".
16. For the related symbols of the Phoenix and the Simorgh see Chapter Eight, Note 23, and text.
17. See: Note 13 above, plate in-between pages 72 and 73.
18. Winston, Richard, Notre Dame de Paris. Newsweek. New York, 1971.
19. Hermes Trismegistos. Corpus Hermeticum, "Libellus".
20. See: Note 13 above, page 160.
21. Bataille, George. Erotism: Death and Sensuality. City Lights. San Francisco, 1986, page 91.

RESOURCES:

We want to list useful references for laboratory equipment, supplies, and materials to support the efforts of our researchers. Please inform us of new suppliers, and let us know if supplier addresses and phone numbers change. We do not list suppliers of medicines for internal use, for practical reasons.

Alchemical Resources**Al-Kemi**

1807 2nd St., Suite 9
Santa Fe, NM 87505 USA
Tel: 1.505.988.7315 (Noon -- 10 PM MST)
Glassware for alchemical work

Bryant Laboratory, Inc.

1101 Fifth St.,
Berkeley, CA 94710 USA
Tel: 1.510.526.3141
or 1.800.367.3141
Fax: 1.510.528-2948
Mail-order labware and chemicals

Centaur Forge, Ltd.

117 North Spring St.,
PO Box 340, Burlington, WI 53105-0340 USA
Tel: 1.414.763.9175. Fax: 1.414.763.8350
Temperature crayons, forges, blacksmiths' supplies, such as tongs, aprons, etc.

David Shannon

6649 E. Rustic Drive, Mesa, AZ 85215 USA
Tel/Fax: 602.985.0557
Minerals by the specimen or in bulk from a first-class mineralogist

Dr. Michael's Herbs

5109 N. Western Ave.
Chicago, IL 60625 USA
Tel: 1.312.271.7738
Herbs

Hagenow Laboratories

1302 Washington St.
Manitowoc, WI 54220 USA
Tel: 1.414.683-3339
Bargain priced labware and supplies by mail-order

TRIAD

125 West Front Street, Suite 275
Wheaton, IL 60187 USA
Email: majrcana@aol.com
Request price listing.
Stibnite, Alchemical books, Marseilles Tarot Deck, high purity essential oils, hard-to-find items.

Books**Banton Press**

Mark Gordon Brown
Dippin Cottage
Isle of Arran, KA27 8SB, UK
Handmade, perfect bound paperbacks of facsimile reprints; 20 alchemical titles, plus other topics.

Chthonios Books

7 Tamarisk Steps
Hastings, TN34 3DN, England
Tel/fax 01424 433302
(+44 1424 433302 internationally)
Scholarly titles from publishers worldwide which deal with Esoteric Studies, and second-hand books.

J.D. Holmes

PO Box 623
Edmonds, WA 98020 USA
Fax/Phone 206.771.2701
Series of inexpensive reprints of alchemical works.

Kessinger Publishing

P.O. Box 160, Kila, MT 59920 USA
Tel: 406.756.0167
Fax: 406.257.5051
Email: books@kessingerpub.com
<http://www.kessingerpub.com>
Over 1000 titles on Hermetic and Masonic topics

Phanes Press

P.O. Box 6114
Grand Rapids, MI 49516 USA
<http://www.phanes.com>
Publishes & distributes books which relate to the spiritual and philosophical traditions of the West.

R.A.M.S.

Hans Nintzel
733 Melrose Drive,
Richardson, TX 75080 USA
Photocopies of translations of alchemical texts.

Todd Pratum Book Company

P.O. Box 985
Healdsburg, CA 95448 USA
Tel: 707.431.2634 Fax: 707.431.0575
Specialist in Philosophy, History of Religions, Mythology, and Metaphysics. Old, New & Rare.

Entrainment Technologies**Tools for Exploration**

47 Paul Drive, San Rafael, CA 94903-2118 USA
<http://www.tools4explore.com>
Light/sound machines and consciousness tools

Newsletters

Caduceus: The Hermetic Quarterly

Cinnabar,

P.O. Box 95674, Seattle, WA 98145 USA.

A quarterly journal of the Hermetic tradition. Subscription prices are \$18 US per year within North America and \$25 US per year overseas; checks should be made payable to Cinnabar.

Cauda Pavonis: Studies in Hermeticism

Stanton J. Linden, Editor,

Cauda Pavonis, Dept of English,

Washington State University,

Pullman, Washington 99164-5020 USA.

Published twice each year, in the spring and fall. Now in its fifteenth year, it publishes scholarly material on all aspects of alchemy and hermeticism and their influence on literature, philosophy, art, religion, and the history of science and medicine. Annual subscription cost is \$10.00 for individuals, \$12.00 for libraries and foreign subscribers. Checks should be made payable to Cauda Pavonis; foreign subscribers should pay by checks drawn on banks with American branches.

Ambix, The Journal of the Society for the History of Alchemy and Chemistry

Scholarly articles and reviews of books on all aspects of the history of alchemy and chemistry, published in March, July and November. The annual subscription to the Society costs £20.00 (\$32). This should be sent to Dr. N.G. Coley, 24 Kayemoor Road, Sutton, Surrey, SM2 5HT, UK. Members receive the current volume (3 parts) without further payment. Most back issues are available at £15.00. For non-members, libraries and institutions, the annual subscription to Ambix is £38, and most back issues are available at £24. Orders for non-members should be sent to Black Bear Press Ltd, King's Hedges Road, Cambridge CB4 2PQ, UK.

Internet

The Philosophers of Nature

<http://www.mcs.net/~alchemy>

We maintain an updated resource list on our site

The Alchemy Virtual Library

<http://www.levity.com/alchemy/>

Over 28 megabytes of information on alchemy in all its facets organized by Adam McLean.

PRACTICAL TIPS:

Judging the temperature of glowing bodies, such as crucibles, when no pyrometer is available:

oF	oC	Subjective color
750	480	faint red glow
850	580	dark red
1000	730	bright red, slightly orange
1200	930	bright orange
1400	1100	pale yellowish orange
1600	1300	yellowish white
>1700	>1400	white (yellowish if seen from a distance)

Another means to judge temperatures is to use specialized *temperature crayons* that have calibrated melting points. One brand, called *Tempilstiks* is available to indicate more than 100 different temperatures in the range from 100 to 2500 degrees Fahrenheit. They have a tolerance of plus or minus 1% of their rating (for example, a 2500 degree indicator can be off by 25 degrees in either direction). They are free from lead or sulfur. One source is Centaur Forge, Ltd., a supplier to blacksmiths. You can find contact information in our **Resources Listing**.



SEMINAR NEWS:

As we go to press, there is not time to give an adequate synopsis of the excellent seminar by Mr. Dubuis held in Glen Ellyn, IL, October 18-20. The surveys we received from those attending the seminar, as well as the comments made to us indicate that this was the finest presentation by Mr. Dubuis to date. We are pleased to announce that the tape of that seminar, *Portæ Lucis: Volume 1, An Introduction*, is now on sale. It introduces his new system for *making an Eternity Contact using simplified methods*. Many keys are given.

Those who attended the seminar will be looking for some specific materials. At the present time, we are able to offer small specimens of native diamond, galena, silver and gold. We are reviewing suppliers and plan to drop the prices for native gold... call for current prices. We will refund any overpayment. At the time of this printing, prices are as follows:

Item No:	Description:	Source:	Approx. Size:	Price Ea,
DI-010	Diamond, Industrial grade octahedral crystal	South Africa	1 mm.	\$23.00
DI-015	Diamond (as above) *	South Africa	1.5 mm	\$27.00
DI-020	Diamond, native, cubic	Africa	2 mm	\$28.00
AU-002	Gold nugget, high purity	Alaska	1 to 2 mm	2 pcs. for \$15.00
AU-004	Gold nugget, high purity	Nigeria	2 x 4 mm	\$24.00
AU-004	Gold nugget, high purity	Nigeria	4 x 6 mm	\$45.00
AR-001	Silver dendrite crystal group, very pure *	Mexico	Small	\$32.00
AR-002	Silver dendrite crystal group, very pure	Mexico	1 - 2 cm fronds	3 pcs. for \$16.00
PB-001	Galena, cleavable, high quality	Kansas & IL	25 x 25 mm	\$4.00
PB-010	Galena, cleavable, high quality	Kansas & IL	25 x 25 mm	10 pcs. for \$32.00

Please make checks payable to Philosophers of Nature.

Add \$3.00 for US postage, \$5.00 for Canadian, \$8.00 for all other countries.

*Please allow 4-6 weeks for delivery. Supplies are limited. * Only 1-3 pieces available, specify second choice*

Got your curiosity? Get the new Jean Dubuis tapes advertised on the back page...

UPCOMING SEMINARS -- 1997

In response to the requests of people attending the most recent seminar of Mr. Dubuis, there are tentative plans for Mr. Dubuis to return to the US to work very specifically on the "Portæ Lucis" method of Eternity Contact. We are waiting for confirmation from France, and will make announcements to subscribers and members when we have the details.

Jean also plans to join us for the Colorado Springs seminar, July 17-20, 1997, along with numerous other lecturers. We will be making final announcements as soon as possible.

**Remember to Renew...**

Your PON membership or subscription expires with this issue (on December 31), unless you have previously paid your 1997 fees.

**JEAN DUBUIS HONORED
as 20th Century Alchemist**

Earlier this year, Jean Dubuis was named on the Alchemy Forum¹ as one of the "people who has become identified as continuing the alchemical tradition, and in this sense have become icons representing the continuation of alchemy in the 20th Century".

The other 20th Century Alchemists identified in this online newsgroup were Armand Barbault, Alexander von Bernus, Eugene Canseliet, Roger Caro, Archibald Cockren, Fulcanelli, Simon H., Manfred Junius, Alexandre Lachance, Lapidus, Augusto Pincaldi, Frater Albertus, and Solazaref.

1. An email forum on the Internet, as a feature of the Alchemy Virtual Library, operated by Adam McLean. See <http://www.levity.com/alchemy/> for subscription information.

Announcement:

P.O.N. SEMINAR VIDEO TAPES NOW AVAILABLE!

Good News – Bad News – Great News – Unbelievable News!

Good News:

The Philosophers of Nature has removed most of the obstacles that have kept us from releasing the majority of our video archives of our seminars. This has been a long and frustrating delay for all of us.

Bad News:

Just as we were completing this hurdle, a very expensive Super VHS camera stolen from the studio of Rick Grimes. Rick has lovingly devoted his time and the use of his equipment to tape, edit and produce the video tapes since the beginning in 1992. Sadly, Rick and the PON have lost the use of an important tool, a key component in the final production stages.

Great News:

We are releasing tapes despite this! And quickly, because we know you are waiting on them. In fact, we are releasing several important tapes right now, and are taking orders for them.

Unbelievable News:

We are selling these tapes at the unbelievable price of **\$19.95 per set of two tapes** including postage with up to 6 information-packed hours per tape!

We said that you wouldn't believe it, but it is true. We are selling these tapes as a service to our members and subscribers so that they can have the information NOW. These specific tapes that we have selected are in demand because of their important content.

The fine print:

There is a catch, and we want to make sure that you understand what it is before you order. The tapes are of lower quality than the standards we have set for our video productions. Despite that, these are better than our 1992 tapes in terms of sound quality (which is quite good with one exception that we will note), and of a slightly lesser quality in terms of video resolution. There was no editing done... you see what the camera caught, including paper shuffling, and thoughtful pauses.

When we are able to obtain the necessary equipment to reproduce these tapes using Super VHS technology, and to enhance the soundtrack in the one place that it is impaired, we will discontinue this offer, and release the tapes in a near-broadcast quality. At that time, the prices will increase accordingly.

In short we want you to have the information now if you want it, while we are working on the new editions. We think that you will be pleased with these tapes.

ORDERING INFORMATION

Item No:	Lecturer:	Title and Topic:	Date/Place:	Price:
VHS-D-10	Jean Dubuis	Portae Lucis Volume 1: An Introduction <i>A widely acclaimed seminar on new techniques for Eternity Contact using simplified methods</i>	Oct 1996 Illinois	\$19.95 2 tape set
VHS-K-10	Curt Kobylarz-Schmidt	Quantum Physics, Alchemy & Chemistry <i>The first of his information-packed seminars for PON ...and... "The Stone of the Wise and Unwise..." considered to give keys into metallic fermentation (sound quality is at very low level)</i>	Sept 13, 1994 Illinois May 30, 1996 Colorado	\$19.95 2 tape set
VHS-G-10	Jack Glass and Russ House	Introduction to Spagyrics & Alchemy <i>a hands-on two-tape set tape showing how to get started with plant alchemy, working toward a plant stone</i>	Sept 12-14, 1994 Illinois	\$19.95 2 tape set
VHS-T-10	Kevin Townley	The Cube of Space and other Cosmological Things <i>the author of The Cube of Space elaborates on this all-important Qabalistic symbol as the Container of Space.</i>	May 28, 1996 Colorado	\$10.95 1 tape

MORE TITLES TO BE ANNOUNCED IN THE NEXT ISSUE... and on our web site at <http://www.mcs.net/~alchemy/>

POSTAGE PRICES: US postage included. Canadian customers should add \$6 per set. For other countries, please add \$10 per set. Please use the enclosed order form. All seminar handouts (if used by the lecturers) are included with the tapes. Allow 4-6 weeks for delivery. Offer may be withdrawn at any time. No returns without authorization. Tapes copyright PON, 1996. Copying prohibited by law.

THE STONE

THE JOURNAL OF THE PHILOSOPHERS OF NATURE
 © COPYRIGHT 1997, THE PHILOSOPHERS OF NATURE. ALL RIGHTS RESERVED.

ISSUE NUMBER 18

JANUARY - FEBRUARY 1997

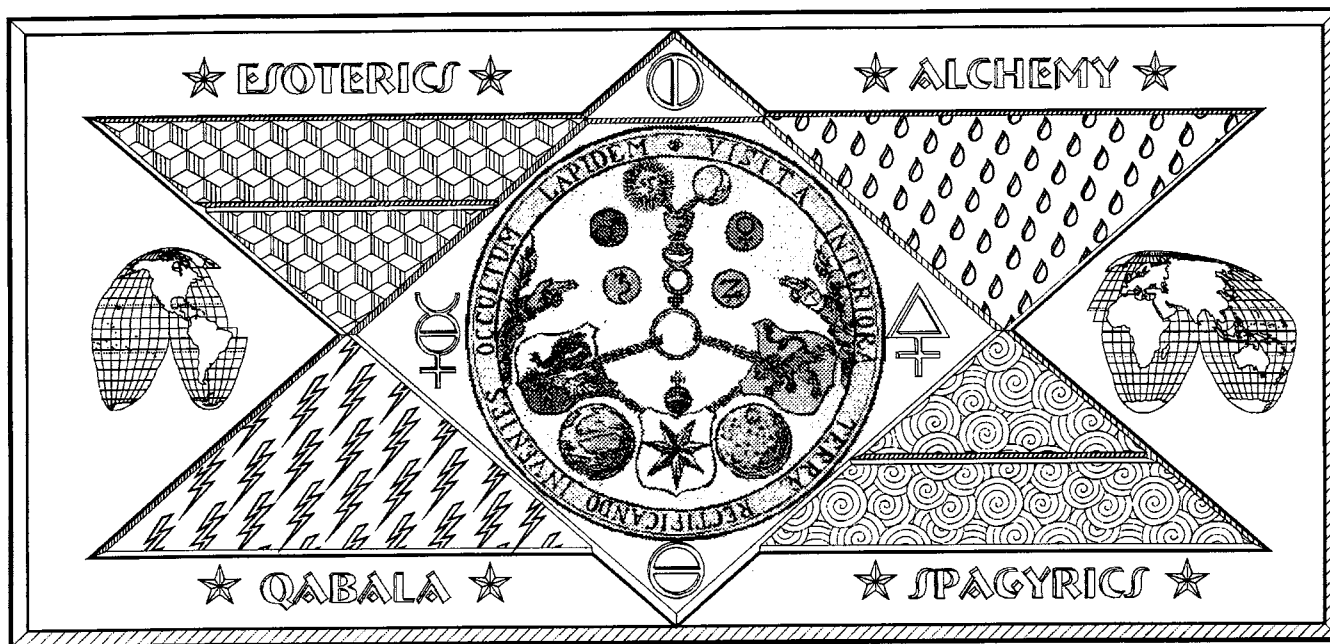

IN THIS ISSUE

Article or Feature	Author	Page
♀ A Message from the President	Russell House	2
♀ Preparation of a Powerful Spagyric Elixir without a Lab	Jean Dubuis	3
♀ Who Were the Alchemists?	Joseph Caezza	4
♀ Curt's Expansion of Wade Coleman's Report	Curt Kobylarz-Schmidt	6
♀ Spirit of Sea Salt and Curt's Steel Retort	Curt Kobylarz-Schmidt	8
♀ Motorized Amalgam Mill	Trem Williams	9
♀ The Volatilization of Salt of Tartar	Arthur G. Fehres	10
♀ Concentration of Wine Vinegar by Freezing	Russell House	11
♀ An Interview with Orval C. Graves	Russell House	12
♀ Research Notices & Minerals for the Crystal Systems	PON / Dubuis	15
♀ Resources	PON	16
♀ Practical Tips: Drilling Glass	Russell House	17
♀ Seminar News	PON	17
♀ Minerals for the Portae Lucis Work	PON	18
♀ Video Tapes Available	PON	19

Editor-in-Chief: Rick Grimes; **Production:** Le Philosophe Inconnu

Published six times per year by The Philosophers of Nature

Price: \$5.00 US

THE PHILOSOPHERS OF NATURE

125 West Front Street, Suite 263, Wheaton, IL 60187 USA

Tel: 630.682.3938 Fax: 630.665.2364

Email: alchemy@mcs.com Internet: <http://www.mcs.net/~alchemy/>

A Message from the President

by Russ House

This issue of *The Stone* will have content almost exclusively related to Alchemy. This includes the first LABORA project report from Curt Kobylarz-Schmidt. There are some articles of historical and scholarly interest, but the emphasis is on practical information – things you can explore in your laboratory.

Frankly, most of the practical articles are intermediate to advanced in nature. The work on the Spirit of Sea Salt requires safety equipment and practical skill – it is not for those just beginning to experiment. Some of the other works, such as that on Volatilization of Tartar Salt are excellent for those who want to cross the bridge between the Plant and the Mineral work. I think that many readers are starving for something to ‘chew on’ and I hope that this issue will bring them new ideas.

For those who would like a simple and convenient process, the article by Jean Dubuis will make a good starting point. If you have no laboratory, then use drinkable ‘pure grain alcohol’ of 190 proof. If you are already working in Spagyrics, then prepare and use a ‘philosophical alcohol’ from grape wine. I am sure that for those in the Northern Hemisphere that the season for acorns has passed, and that many readers do not know how to distill high-purity alcohol. In this case, there is no time like the present to start.

Perhaps you are working a little, or perhaps you have not really begun. Start by setting a goal – that of making the Elixir described in the article. Find out when the acorn season occurs in your locality, and find oak trees near your home. (If there is mistletoe there, you are quite fortunate.) Take an inventory of your skills, your present equipment, your level of practice, and most important of all, how much time you can devote to getting ready by the deadline – acorn season.

You will need some distillation equipment, inexpensive red grape wine, a hydrometer for measuring the strength of the alcohol, and potassium carbonate. The latter can be used for drying the wine spirits. While this is not mentioned in the article, Jean stated this in his October lecture.

A basic distillation train will do, particularly if the distillation is very slow, and the distillate is rectified (redistilled) several times. Slowly and patiently redistill the clear alcohol-rich distillate, leaving the cloudy and

watery residue behind. A rapid rise in temperature at the still head will indicate that the distillate is carrying more water. Continue until at least 90% is achieved, as shown by an alcohol hydrometer (pictured at right). If you are reading the Spagyrics lessons, then use the method given in the lessons to dehydrate the alcohol with dried potassium carbonate.

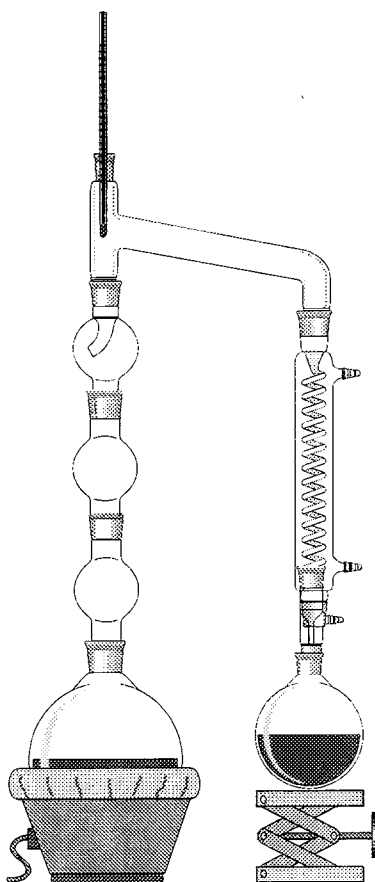
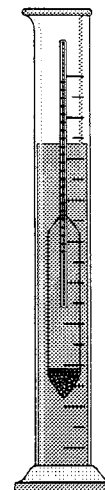

It is possible to achieve 93-94% pure wine spirits (alcohol) in a single distillation using the setup at left, but this is more expensive than a simple distillation train. I first saw this method used by Patrice Malézé in Paris, and have found it to be the simplest and easiest method of producing good wine spirits. There are other adaptations that will work, which are limited only by your imagination and ingenuity. I give this method because I know for a fact that it will work. A 5 liter flask for the red wine in a heating mantle is ideal. The distilling bulbs should be between 500 and 1000 ml. *Al-Kemi* should be able to supply these. See the **Resources** listing. A

Kjeldahl trap is above these

If you have sub-freezing temperatures where you are, perhaps you will want to take advantage of the opportunity to concentrate some red wine vinegar. This is a useful product in plant and mineral/metallic work. I have enclosed a brief explanation of the process in this issue.

With good wishes for you on your Path,

ORA ET LABORA!

Russ

Preparation of a Powerful Spagyric Elixir Without a Laboratory

by Jean Dubuis

The tradition says that France was, in the pre-Christian era, inhabited by people called the Gaulois. These Gaulois had priest-magi-healers called Druids.

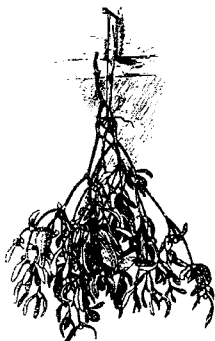

It is said that in these ancient times, serious epidemic illnesses would decimate the Gaulois. But one day, a druid prepared a remedy using oak mistletoe and this elixir was able to miraculously heal the populace of that time. This was later celebrated in feasts known as "Au gui, l'An Neuf" that could be translated as "New Year by the Mistletoe".

One day, after I had given a lecture on Spagyrics in which I had mentioned mistletoe, a man of respectable appearance came to see me and said: "Since you are an alchemist, if you were given mistletoe, could you prepare its elixir? Our Druid is very sick, but he doesn't know how to make the elixir any more." My answer was: "I think that I have some chance to succeed."

On Christmas eve, two people showed up at my place. They were carrying a big parcel wrapped in a white sheet, containing about 200 liters of branches, leaves, and fruits of oak mistletoe. They would not tell me where this mistletoe came from.

Oak mistletoe cannot be found in the French forests, and at the turn of the century, botanical books stated that not more than 12 oaks were known to bear mistletoe in the entire French territory. I thought afterwards that the oak this mistletoe came from was located in a private park of a renowned French family.

I started working, but oak mistletoe is very hard to work on, especially because it generates a gum that clogs the tubing (in soxhlets and other

devices) and which resists all kinds of acids.

After some two years of work, the elixir was almost ready and it performed miracles, but not on the Druid who had died in the meantime.

Since oak mistletoe could not be readily found, I have tried to make the elixir with mistletoe from other trees, such as that from apple trees and poplars, since this is very common in France. But none of them has the remarkable properties of oak mistletoe.

One day when I was looking at the front page of the book of the Alchemist Urbigerus, the image presenting the "spring of life" issuing from the trunk of an oak provided a revelation -- It is not the mistletoe that heals, but the vital energies of the oak, accumulated by the mistletoe as a parasite of this tree. Thus:

Making the Elixir

If the vital energies that heal come from the oak, these are abundant in the fruits, in the seeds of the tree.

During the gathering, the oak acorns are ripe and fall on the ground. They should be gathered preferably before they have stayed a night on the ground and before any rain. These are to be wiped dry. Place these in a glass flask and cover them with an alcohol of the best possible quality, 90 percent minimum, but more is better. Seal the flask immediately. Place the flask on a source of gentle heat. The incubator at 40 degrees Celsius is ideal, but above a refrigerator is enough. If the source of heat is not continuous, things will still happen, but more slowly. Still, never exceed 50 degrees

Celsius. Carefully avoid lunar light on the flask. After a few days, the tincture becomes green-yellow, then yellow, then slowly turns to **Red**.

For a nice bright red, it takes between 6 to 18 months, depending on the conditions of heat. When the bright red is reached, the elixir is ready. The dosage of the elixir is of 10 to 20 drops in a glass of water the first thing in the morning for 1 month. Do not eat before.

In a Druid Wood

Once in the stillness of a druid wood
Where ancient oaks retained primordial night,
Within a ring of phallic stones I stood
And heard the ravens calling in their flight.
Then from the altar table rude and gray
There rose a solemn word more sad than death,
And something lunar tinged the light of day,
A female power, a sighing, chilly breath.
"Fir is to yew as silver is to lead,
My newly born sweet child and lover king,
O burden of my tears, my newly dead,
Crown of the oak and feather of the wing."
This spoke the holy presence in the gloom
Not with Her lips but from Her ageless womb.
-- Victor H. Anderson

Who Were The Alchemists?

By Joseph Caezza

It has been estimated that in the past 2000 years over 100,000 tomes have been written on Western Alchemy (1). Certainly many of these works were the products of cranks and dilettantes but who were they emulating? What ineffable mystery were the sincere authors attempting to communicate?

Although in the West it is thought to concern the transmutation of base metals into gold, many of today's best scholars agree that Alchemy defies any strict definition (2). Research into its enigmas might best begin with a historical inquiry into the identity of the best known "adepts". These individuals stood distinctly separate from the fanatic "puffers" who constitute a major source of ridicule toward this whole field. "Puffers", so called because of their use of the bellows, relate to "adepts" just as "quacks" relate to allopathic physicians. A meticulous study reveals the true adept to be sincerely religious, inclined toward natural science and generally free from the greed and vanity that compelled the puffer.

Morienus, who apparently lived during the seventh century, dwelled as a Christian hermit in the mountains near Jerusalem. He was known to send large annual donations of gold to the Christian Church there thus attracting the attention of the Arab king, Khalid, whom he initiated into the secrets of Alchemy (3). Gerber (8th century) was an alchemist and physician initiated into an austere Sufi fraternity (4). Sufism represents the ascetic system of Islamic mysticism that stresses contemplation as a vehicle to ecstatic union with the Divine. Roger Bacon (1214-1292) was a Franciscan monk (5). Ramond Lully (1235-1315), allied for a time to the Franciscans was initiated by Arnold de Villanova. Lully in his turn initiated John Cremer, a Benedictine monk who allegedly held the position of abbot of Westminster. Albertus Magnus (1193-1280) and his illustrious student, Thomas Aquinas (1225-1274) both were Dominican monks esteemed in the annals of alchemistic philosophers as adepts (6). Certainly the most famous of fourteenth century adepts, Nicholas

Flamel, accomplished the alchemical magnum opus after deciphering the now classic, *Book of Abraham the Jew: Priest to the Jewish People*, which was intended to help devout Jews pay their Roman taxes. Flamel supposedly used a mysteriously acquired fortune to build hospitals and restore Parisian churches (7). The best known adept of the fifteenth century was the semi-mythical Basil Valentine, a Benedictine monk, prior to St. Peter's at Erfurt.

Another great alchemical author of the fifteenth century was Sir George Ripley, a Carmelite monk who supposedly donated 100,000 pounds sterling worth of alchemically produced gold to the Knights of St. John of Jerusalem (8). Pope John XXII (1316-1334) has also been indicted as an alchemical adept and a significant work on transmutation is ascribed to him. He bequeathed a mysteriously acquired fortune to the church that consisted in part of eighteen million florins of gold bullion rumored to be the product of his labor (9). Dom Anthony-Joseph Pernety (1716-1796), a Benedictine monk, authored a recently republished classic on Alchemy renowned for its encyclopedic clarity (10). Even Martin Luther is quoted for praising Alchemy, "not only for its practical utility but for its verification of church doctrines" (11). A recent article in the prestigious journal, *Nature*, sympathetically explored Sir Isaac Newton's preoccupation with Alchemy (12). Was it mere nonsense that engaged the minds of so many great men?

Not only Newton but two other of the most distinguished seventeenth century scientists, G. W. Leibniz and Robert Boyle, "the father of modern chemistry", clearly accepted the theory of alchemical transmutation. The contemporary scholar, B.J.T. Dobbs, exhaustively chronicles the mystic climate of this age in her now classic, *The Foundations of Newton's Alchemy Or the Hunting of the Green Lyon* (13). Herein she tracks the final thirty years of Newton's life spent in diligent quest, a quest in the vein of the forge and the crucible for the Lapis Philosophorum, the Philosopher's Stone. In her brilliant sequel, *The Janus Face of Genius: The Role of Alchemy in Newton's Thought*, Dobbs

concedes that Newton's primary alchemical compulsions emerged from the purest religious aspirations for mystic Truth (14).

Why are there artifacts of gold in the British Museum supposedly produced by transmutation(15)? Why are these specimens exponentially more pure than the technology of their respective ages usually produced? Why are there so many eye witness accounts of transmutation? Why did an Imperial Edict in 144 B.C. China decree public execution for anyone caught preparing gold by alchemical means? Why did the Roman Emperor Diocletian order the burning of all Egyptian alchemical manuscripts in 290 A.D.? Why also did Henry IV outlaw the alchemical production of gold in seventeenth century England?

If Alchemy was indeed the quest for mystic communion with the essential archetypal process of nature then the adept sought to recapitulate this creative process with symbolically effective laboratory gestures and chemical manipulations and of course, with the indispensable cooperation of Providence. Just as all life evolves toward Divine Perfection, so too do metals evolve toward gold. It is this essential process of evolution that the alchemist accelerates with the product of his labor, the catalytic Philosopher's Stone, the red powder that transmutes base metal into purest gold. The enigmatic reality behind such a magnum opus can not be explained but only demonstrated. In just such a manner religious gnosis demands direct personal experience rather than pedestrian faith.

REFERENCES

1. Pauwles, Louis and Bergier, Jacques. 1983. *The Morning of the Magicians*, Scarborough, p. 66.
2. Grossinger, Richard. 1983. *The Alchemical Tradition Through the Late Twentieth Century*, Io31, North Atlantic, p. 240.
3. Stavenhagen, Lee. 1974, *A Testament of Alchemy*, University Press of New England, p. 5.
4. Holmyard, E. J. 1968. *Alchemy*, Penguin, p. 71.
5. Waite, A.E. 1970. *Alchemists Through the Ages*, Steiner, p. 63.
6. Klossowski De Rolla, Stanislas. 1988. *The Golden Game*, Braziller, p. 114.
7. Ibid. 5, p. 108.
8. Ibid. 5, p. 135.
9. Ibid. 5, p. 310.
10. Pernety, Antoine-Joseph, 1995. *An Alchemical Treatise on the Great Art*, Weiser.
11. Courdert, Allison, 1980. *Alchemy*, Shambala.
12. Gregory, R. 1989. *Nature*, vol. 342, Nov 31, p. 471.
13. Dobbs, B. J. T., 1975. *The Foundations of Newton's Alchemy or The Hunting of the Green Lyon*, Cambridge.
14. Dobbs, B.J.T., 1991. *The Janus Face of Genius : The Role of Alchemy in Newton's Thought*, Cambridge.
15. Powel, N., 1976. *Alchemy*, Doubleday.

Announcement: **Practical Work on Spagyrics now available from The P.O.N.**

In 1994, the booklet *Spagyric Tinctures – Tradition, Preparation and Use* by Beat Krummenacher appeared in an English translation by Karin Di Giacomo. The rights have since been obtained by The PON. In this invaluable booklet, the contemporary Swiss alchemist and spagyrist explains the methods of Zimpel, Glauber, Krauss and Heinz, before setting forth his own method of preparing spagyric remedies. Paracelsus' ideas on the *Arcana*, and important ideas on the polarity of remedies as healing agents or as poisons are developed at some length. This is a most useful map for finding one's way in the Spagyric realm... we think that it will provoke some thinking about one's own practice, and suggest improvements that can be tested for their value.

The cost of \$16.95 for this ring-bound 49-page booklet includes postage in the US.

See order form for foreign postal costs.

**Curt's Expansion of Wade Coleman's
"A Report on the Conference at
Colorado Springs"
from *The Stone* -- July 1966**

by Curt Kobylarz-Schmidt,
Director of Research, LABORA project

I am adding a few notes to the review of my lecture at the PON Conference as I understand the difficulty in understanding some advanced metallic alchemical operations, as few students (since the demise of Frater Albertus' PRS) have been taught *anything* concerning the metallic kingdom of Alchemy. This is due to the fact that the operations are lengthy (2-3 weeks time is barely minimal), and to the somewhat dangerous nature of working with strong acids and alkalis, and somewhat poisonous materials with students *untrained in the chemical handling of such items and the supervision required for the safety of all*. There is also *the problem of the transportation of such items* (as most cannot be taken aboard airline flights).

This is not to *scare* anyone from this aspect of the Work -- as the results are extremely fascinating, exciting, AND very Powerful as agents for physical and conscious (spiritual) change/transformation. As an aside, we know as Students of Alchemy that the word SPIRIT means the Alchemical Mercury, which is in physical terms -- ENERGY. Energy can be manifested as a stored (a static or potential) form, or as energy in motion (kinetic) which manifests as WORK DONE. Energy can also occur as Inertial Energy ("An object at Rest tends to stay at Rest, and an object in Motion tends to stay in Motion"). Thus the cup of coffee, tea, espresso, or whatever to "get going" in the morning -- that is to overcome that Inertial Resistance to get our butts out of bed. Notice that once we get going, we tend to keep going (unless we dislike what we are doing -- our job or whatever). But the principle still applies. The more Alchemical Mercury or Energy we can manifest, the more we can Learn, Study, Meditate, Assimilate, and Accomplish. No different from getting a faster Micro-Processor computer chip -- the faster the speed (in Megahertz)

the more the machine can process/do/accomplish. How did I get off on this track -- I only intended to add to my lecture review. Well, the Alchemical Mercury is manifesting, as mental excitement, which increases respiration rate, which increases the Chi/Prana intake, which increases my energy/excitement level and gets me to go rambling on (rambling with a focused direction/attention -- at least I hope!).

To get to what I intended to initially write (I feel as if I needed that little bit of Prologue and as an Introduction as to why a lot of Metallic Work isn't being done). In my 1994 lecture in Chicago, I showed a lot of extractions that can be made using a Distilled and Elevated RAIN WATER as an Alkahest. Michelle Auger also did a fine presentation along similar lines, and I was surprised at the parallel work we were doing. He presented these as "Vitriols," which opened up other doors for me, as I obtained similar substances, but didn't know their name.

Everyone helps each other as we become connected on the Inner Planes -- whether we are Conscious of it or not. Jean Dubuis' Research Group meeting at the end of the seminar gave me additional clues and triggered off a new direction for me. Thus, my 1994 seminar deals mostly with what may be called "The WET Work".

As an aside -- I strongly advise studying and working with Rain and Dew waters. These are the best Alkahests I have found, and are much safer to work with than strong acids.

My second lecture in 1996 [Colorado Springs- which I'm finally getting to] deals with what may be called "The DRY Work". Or rather "A Dry Work". The real emphasis was really on making one aware of how the Alchemical Mercury in metals can be "lost" - - similar to which is a furtherance of LPN Mineral Lesson #8 "That which is Philosophical" -- by Jean Dubuis. Thus the title of the lecture "The Stone of the WISE -- or What happened to my Philosophical Mercury?". Anyway -- the gist of what I was showing was how to first IDENTIFY, and then NOT LOSE the subtle part of the Alchemical Mercury. I

showed by many examples from books that it has always been there, though disguised. Antimony was one example discussed, and this was used to refer to the Flamel process the LPN discussed a lot, and how the Philosophical part of the Alchemical Mercury is lost in the first Detonation (it must be "dexterously baked" as described by Basil Valentine and referenced in the video). [See list of available videos]

The main emphasis was that I was trying to show a Chemical/Physical means for explaining nuclear transmutation as the Old Ones have described. The most significant factor I can find so far is the DEW Water (Distilled Angel Water, called by the LPN the "Angel Water of the Angel Water". It appears to contain a significant amount of naturally occurring Deuterium Oxide (Heavy Water, D_2O) as made by the Sun [The Father is the Sun, the Mother is the Moon.....]. I have obtained Infra-Red Spectra on my Dew and Rain Water, and compared it to the IR Spectra of commercially purchased Deuterium Oxide (Spectrum Chemicals Manufacturing Co., Gardena, CA Item # D10002 - Deuterium Oxide, 99.8% pure) -- and THEY AREN'T the SAME. The problem is that all current D_2O occurs a by-product of nuclear reactors, and this is synthetically prepared by Man and not by Nature. Around 30 years ago it was obtained from sea water by distillation and electrolysis, but that is far too expensive to do NOW with thousands of gallons of synthetic D_2O being produced daily in nuclear reactors. NOTE: if ANYONE has a source of 'old' D_2O -- say like 30-40 years old sitting in some old lab storage, I would appreciate getting a small 5-10 ml sample of it to run infrared tests. Contact the Philosophers of Nature at their published address if you know of a source -- I will publish the results in a future "Stone". In fact, I may send Russ House the IR scans of what I have to put in his scanner and publish here.

Deuterium is an isotope of Hydrogen [$2H$], and is not radioactive as mistakenly mentioned in the review; Tritium [$3H$], another isotope, IS radioactive. This is easy to confuse if one is not familiar with isotope chemistry, and especially at the rate I spew data out in my lectures (there is just never enough time, and I like to be very thorough....). With a neutron in the

nucleus and only one electron in the outer orbiting shell, if we tie up that electron, we have access to the nucleus, and if we can free the neutron ("Make the Volatile FIXED, then make the Fixed VOLATILE") we have a scientific method of showing nuclear transmutation. A neutron (or neutrino) is usually what physicists use to bombard other atoms to FORCE a transmutation. The nucleus of any atom MUST be reached for transmutation to occur. I have written out the chemical equations (and explained the nuclear part) on the white board in the video, and passed around a Fixed Alchemical Mercury, and shown slides of a mineral being acted upon by this Mercury and turning black, and then green within a few days, continuing to a silvery-white after a longer period of time (several weeks).

I have written a lot more than I had intended, but I felt a need to further clarify the intent of my lecture, and to advise viewers what to look out for and to focus on. I do not wish all my efforts to go unheeded, and I wish my labors to be used by others to accelerate what they are doing. The least would be to encourage (or re-encourage) you to not give up -- there are still signs of hope and light on the Horizon....

Curt

A note from Curt in October 1996:

"By the way, I prepared 3 types of Living Aqua Fortis -- Living Nitric Acid, from Chile Saltpeter and: Chalcantite [$CuSO_4$], Native Ferrous Sulfate [$FeSO_4$], AND the Green Lion [Iron and Copper Sulfate]; I used proportions of 150 grams of $NaNO_3$ to 50 grams of the corresponding, in a glass retort; the Ruby color from the Iron and Green Lion sulfates were GORGEOUS!. All yielded around 30 ml of the Aqua Fortis. None were clear - yellowish to greenish tinged; smell had a fragrance to it. Also working on a Living Mercury Sublimate from the living sea salt acid + Cinnabar; the sublimate comes in beautiful long needles, glistening and shining like crystal. The needles are similar to the Vitriols that I get from metals (rain water over pyrite ore, with air excluded - from the 1994 lecture)."

Spirit of Sea Salt

by Curt Kobylarz-Schmidt,
Director of Research, LABORA
project

I used a mixture of Pacific Ocean sea salt (which I collected and evaporated slowly), some of the gray Celtic sea salt, some salt from Salt Lake City, Utah which I collected and a little sea salt from the health food store. The proportions were 80%, 5%, 10%, 5% in the order above.

The product is very oily in consistency.

Polyethylene tubing, leading to near the bottom of flask of rain water. Remove this tube if acid runs out, or when the heat is turned off, as it will suck the water and spirit back into the 500 ml flask, as it did to me once.

Once-distilled rain water. The rain water will absorb a lot of gas before it saturates (when white fumes appear above the rain water). It took me 3 times to saturate about 8 ounces of rain water.

Concentrated (98%) sulfuric acid

Drip the acid SLOWLY

Sea salt and a little reagent-grade hydrochloric acid

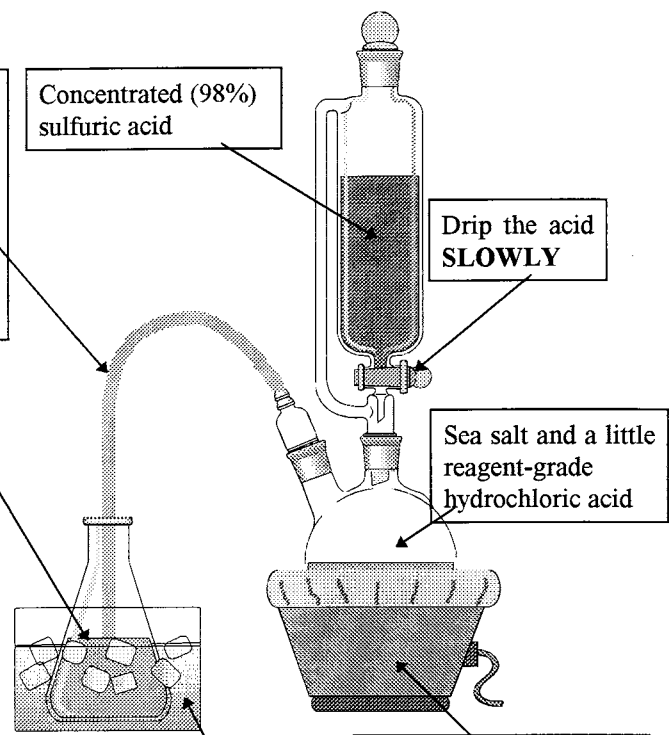

Water and ice cubes as this is an exothermic reaction and gets hot!

500 ml 2-neck flask in heating mantle. Set to about 20 Volts AC.

SYNOPSIS OF SPIRIT OF SALT PROCESS:
Concentrated sulfuric acid is slowly dripped over sea salt warmed in a heating mantle. The resulting gas is lead through tubing to the bottom of a flask of distilled rainwater which is kept in an ice bath. The process is continued until the sea salt is exhausted of its acid spirit, and if necessary, the process is repeated with fresh materials until the rain water becomes saturated with the acid spirit.

SAFETY WARNING: This is a dangerous process, and requires precautions including: appropriate training to handle mineral acids safely, safety glasses, gloves, protective clothing, and adequate ventilation.

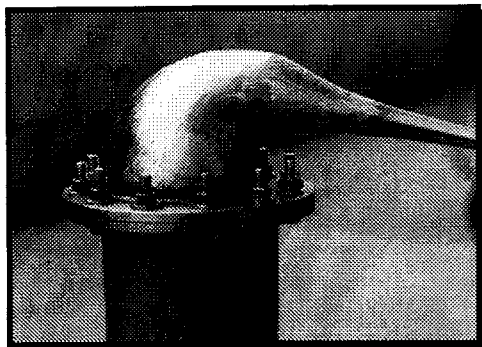

In 1993, Curt sent us these photos of a stainless steel retort which had recently been fabricated for him. The retort head, pictured at left, is a casting. The flange was also cast, ground, drilled and welded. The photo at the right shows the entire retort, the body of which was made from 5 1/4" tubing, the bottom was cast, ground and Heliarc welded. The cast and ground removable end joint is 24/40 for fitting into condensers and similar apparatus.

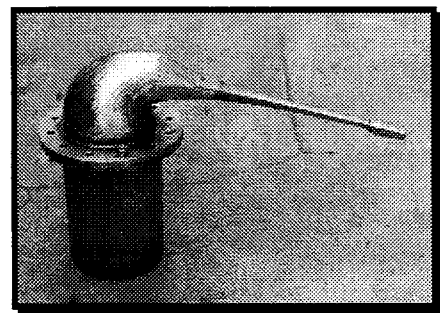

Motorized Amalgam Mill

by Trem Williams

A brief description will help you to see this machine in better perspective. The base is a $\frac{3}{4}$ " thick round steel plate. The upright is fitted into it and welded on the bottom side to prevent turning. The two aluminum plates are drilled and then have a saw kerf (*a cut*) through the hole in order to slide the plates up and down and rotate them on the shaft. They both have a bolt on the outside of the bore in order to tighten the plates into whatever position one desires.

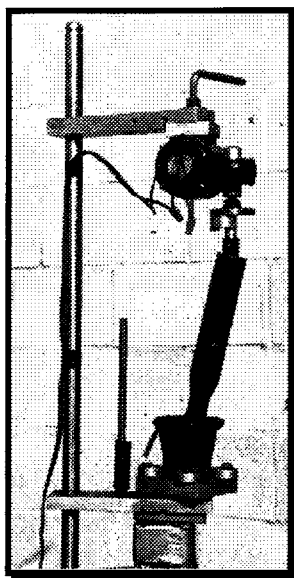

The gear head motor is one similar to those available from American Science and Surplus (see Resource listing elsewhere in this issue – Ed.). It is a series wound motor which means that it has brushes and would be called a universal motor, meaning that it can be operated on AC or DC current. It is marked to be used on 120 Volts DC, so it can be controlled with a lamp dimmer. I happen to be using a speed controller designed to work with DC motors but a regular wall mounted light dimmer will work. The unit runs at 100 RPM when full voltage is applied.

The motor is mounted to a small aluminum plate, which in turn is tapped in the center so a locking bolt can be tightened from the top to hold it in any position. The motor came with the brass disk on the output shaft so I drilled and

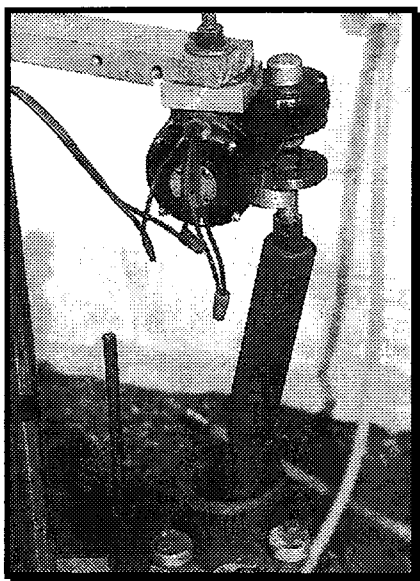

tapped it in about 8 places. Each hole is an incremental distance from the center so I could have various offset angles for the pestle.

The pestle is a cast iron sash weight taken from an old window frame. It was lathe-turned on the lower end to conform to the shape of the mortar. The top was cut off and bored out about two inches in depth and a diameter large enough to accept the flexible container which is nothing more than a 4-inch piece of black rubber garden hose. The hose has a wooden plug in the lower end to keep the hose from collapsing when torque is applied. The aluminum piece under the brass plate and the top of the cast iron pestle are both cross drilled in order to pin the hose into place. I use a cotter key on the upper part of the hose and a small bolt and nut on the top of the pestle.

The mortar sits on an aluminum plate which is drilled out in the center to fit the shaft of a small gearhead motor available from W. W. Grainger in Chicago. The mortar motor rotates in the same direction the pestle rotates so if anything binds up while grinding, it will relieve the strain automatically. This works much better than trying to run the motors in opposite directions.

The plate has 4 holes drilled and tapped at the appropriate spacing to accommodate the aluminum disks which have holes drilled off center. By rotating the disks and then tightening the bolts, the mortar is securely held in place.

When the machine is assembled, there is complete adjustment in all the angles and rotational speeds.

I took a Maple Leaf gold coin (.9999 fine gold), and shaved it with a Dremel grinding tool using a burr type bit. Then I put the shavings into the grinder and ran it until the gold dust would pass through a gold screen coffee filter, I have no idea how fine the screen is but the gold looked like dust when it was finished. It took about four days to grind $\frac{1}{3}$ of an ounce.

For your convenience, color pictures are available at:
<http://www.mcs.net/~alchemy/stone18mill.html>

The Volatilization of Salt of Tartar

From *QUINTA ESSENTIA* No. 1, 1976

A translation from the German with comments
in [brackets] by Arthur G. Fehres

During the Quinta Class 1975 (Switzerland), Frater Albertus had read to the students thereof the precise instructions on how to prepare the volatile salt of tartar. Mr. Siegfried Seifert has now been successful in finding the original text in the library and has rewritten the Old German text in the German of today. To the student it is now very valuable to be able to read the complete treatise here on the volatilization of salt of tartar.

The following has been taken out of "Selected Rare Chemical Secrets" by Kenelm Digby, Hamburg 1684: An effective and true method to volatilize salt of tartar and to make the spirit of wine workable.

Take one pound well calcined tartar [One pound of crude tartar results in just over six ounces of the salt. Pulverize the tartar and calcine in the open air, grind again in a warm mortar and calcine again. This will give you a well calcined tartar.] And expose to the air [spread out in flat dishes] out of the sun [to facilitate absorption of moisture] until it becomes liquid. [This can take several weeks depending on the moisture content in the air. Alternatively one can use distilled rain water and leech out the salt through filtering or soxhlet extraction.] Then filter and distill off the moisture. [Evaporate in flat enamel dish and keep breaking up the forming salt until all is dry.] After that, calcine the tartar [first pulverize in warm mortar] and let it glow for 6 to 8 hours followed by exposing it again to the air till it runs, then filter, distill and calcine as before. This is to be repeated ten times. [Most important is to get all the carbon out. This is readily done as follows. When the black calcined tartar has run into a liquid through exposure to the air or with sufficient distilled rain water let it stand for a day. Then evaporate to dryness, grind and calcine, which will quickly change the black to gray. After leeching this calcinate, the filtrate is free of carbon and colorless, which otherwise looks like honey.]

Then dissolve the tartar in distilled vinegar (Spanish or French vinegar) [any wine vinegar will do]. The whole secret lies in the correct distillation of the vinegar which has to take place in the water bath, but so gently that no phlegm comes over.

When you notice that sour drops are coming over, you increase the heat to such a degree that you can count to 8 or 9 in between each drop. Continue the distillation in this way till the remaining looks like syrup. Then increase the heat again till the distillate starts to smell and continue distilling till most of the residue is dry.

Rectify [redistill] the last obtained strongest distillate on its own and add it to the weaker distillate. Keeping the phlegm for later use, rectify [redistill] then the two combined and as often till after distillation there remains no residue at all on the bottom of the vessel [if putrefaction of the grapes is complete redistillation upon redistillation will prove to be unnecessary]. Each time take a clean distillation flask and continue distillation till the flask is dry inside. The result is not a stronger spiritus aceti, which it does not need to be, but nevertheless it will work. [The stronger the acetic acid solution the more alchemical sulphur is drawn out, which after drying is calcined into carbon.]

Then take 7 or 8 ounces of our salt of tartar and dissolve as much or more in the before mentioned spiritus [aceti] and when you let it stand, it will throw out a black residue [which is carbonized alchemical sulphur and appears only after calcination]. Then filter [unnecessary], distill [evaporate in enamel dish and reduce to powder] and calcine as before, but not with as strong a heat as it should hardly glow (1 hour is sufficient). Agitate it for as long as it is warm and dissolve again in the freshly distilled vinegar [of same strength] as before, let the residue [carbon] settle out, then again filter, distill and calcine as before. [Lastly one should filter, evaporate and reduce to dry powder.] Repeat this procedure until there occurs no more sediment [i.e., until no more alchemical sulphur is extracted and therefore no more carbon forms when calcined], which will happen after 7 or 8 times, that is when you have done your work well.

When it is absolutely dry, take one ounce of it for the following test. Put it in a clean flask and pour over it spiritus vini, not just moistening it, but enough to make it flow well. Let it stand [macerate] for 24 hours [or longer] well stoppered in gentle heat [blood temperature], then distill in gentle heat [not to complete dryness]. If the spiritus vini cohobates and the phlegm distills over, then proceed with the whole quantity. [Water is the medium between the salt and the spiritus vini. The spiritus should contain about 20% water].

If not, you have to dissolve the salt further in vinegar, filter, distill and calcine as before, till you see that the spiritus binds with the salt (that will not take long). [Repetition seems to accelerate alteration of chemical compounds.]

Then go about the rest of the salt in the same manner as with the one ounce [using all or some of this ounce as a 'starter']. Imbibe with spiritus vini and distill. Continue imbibing and distilling till the spiritus vini distilling over again is as strong as you poured over it. In here lies the secret to sublime it.

Dissolve the impregnated salt of tartar in the phlegm of the distilled vinegar or in a weak spiritus vini [I recommend warm distilled rain water] (not more than necessary to dissolve). Shake well, then the salt of tartar will soon dissolve and the unwanted part will be thrown out as a sediment. Decant that which has dissolved, filter and distill off the phlegm of the vinegar or the weak spiritus vini, then the dry spiritus or the dry water will rise moisture free like pure icicles. [This distillation requires very gentle heat and is best done under vacuum.]

This is the true volatile salt of tartar and spiritus vini in the form of a salt. It is the vegetable menstruum that dissolves leaf gold into an oily substance with gentle heat.

The tartar which remains at the bottom of sublimate should be put with that which remains undissolved in the phlegm of the vinegar or weak spiritus vini and work it again with spiritus vini. First it should be calcined (not for as long and not with such a strong heat as before).

Then expose to the air till it runs and much more residue will remain. After that, filter and distill and dissolve it again in distilled vinegar as before. By repeating this process step by step three times there is more achieved than before with the whole process together, for the tartar has changed its nature. [Each repetition seems to improve the 'learning ability' of the compound.]

Imbibe further with spiritus vini. This time you can work as much spiritus vini on it and sublime as many pure crystals as you want.

Concentrating Wine Vinegar by Freezing

by Russ House

A few years ago I took numerous 1 gallon containers of red wine vinegar, and poured approximately 20% out of each bottle to prevent bursting from ice expansion. The vinegar that was poured out was put into clean 1 gallon glass jugs. All of the jugs were set on the patio during a harsh winter, with the caps set very loosely on the top. Each morning the bottles were checked to see if they had frozen. If a bottle had frozen, then it was turned upside down over a large funnel inserted into the neck of a clean jug. The dark red liquid was decanted, leaving the pale pink ice behind. This ice binds much of the water in the vinegar. The ice is then discarded. For the sake of speed, I rinsed out the ice with hot water and left it in the sink, so the bottles could be reused as required.

The bottles containing vinegar that had been frozen once before were labeled. These are treated in the same manner – allowed to freeze, the liquid retained in a labeled bottle, and the ice discarded. This is repeated several times.

Be careful to rinse any vinegar off the skin after it has been 'twice frozen', as it is sufficiently concentrated to burn the skin. I worked outside to avoid problems from spilled vinegar.

When time permits, the concentrated vinegar is distilled. Acetic acid mixed with water forms an azeotrope, meaning that it is difficult to purify acetic acid/water mixtures by distillation. The Spagyrics lessons should be consulted on the distillation process. Keep the red-brown residues from distillation as they are useful in the work.

An Interview with Orval C. Graves

by Russell House

This interview was conducted on October 31, 1990. I had reached Mr. Graves at his California home, having met him in 1989 at San Jose, California during an Alchemy class. I regret that Mr. Graves has since passed away.

Mr. Graves was the librarian for AMORC during the 1930's and 1940's, and was responsible for starting the practical Alchemy classes that were given from 1940 until 1945 at Rose-Croix University, where he served as Dean. These classes had a well-known student, Albert Reidel, or Frater Albertus. In addition, to Frater Albertus, I met often with George Fenzke, and was acquainted with Ralph "Willy" Randall, and Orval Graves who participated in these classes. Another student was Hiram Syndergaard, who was a character in the mainly fictional *Alchemist of the Rocky Mountains* by Albertus. In the August-September, 1945 issue of *The Rosicrucian Digest*, there is an announcement that "Dr. H. T. Syndergaard of Salt Lake City is presenting brief courses in chemistry, physics and anatomy and supervises the Alchemical Laboratory. Soror Laura James of Bakersfield instructs the classes in elementary and transcendental alchemy, or hermetic philosophy. Staff assistants this year are Frater Ralph W. Randall in herbalism and alchemy, and Frater George Fenzke in alchemical experimentation." In the RCU class photo for 1945, both George Fenzke and Frater Albertus can be identified.

First of all, I read to Frater Graves the text of my article (which was prepared for and subsequently published by AMORC in several languages) that related to the classes in the 1940's so that he could verify its accuracy. He explained to me that he always encouraged the Alchemy class students to follow the ways of Paracelsus for general techniques and background. Dr. A. Whaley assisted them in trying to replicate some of the government research on making synthetic stones. Incidentally, I saw and handled a large, brilliant cut diamond of several carats which belonged to Orval Graves, which had been made by F. Jolivet-Castellot, a French alchemist who was involved with AMORC. It had been a gift to Graves from the son of Jolivet-Castellot. (Years later, Frater Albertus

wrote of an only partially successful transmutation experiment following the methods of Jolivet-Castellot which was conducted in these classes).

In these Alchemy classes in the 1940's, they made some diamonds that were, essentially, "hard carbon", said Graves. At that time, a friend of Graves who lived in San Francisco at the time of this interview, was growing emeralds through a crystallization process. The gentleman chose not to patent the process, but rather built walls around his home where he produced the synthetic gems – the finest manufactured emeralds.

The DuPont company was making stones, such as sapphires, at the time and were of help to Graves and his students, sending samples, and explaining some of the tricks in their process. The classes were not able to duplicate all of the processes, since they were using Alchemical furnaces rather than the high-powered electrical furnaces used by DuPont.

(Graves wrote in an article, *The Munificent Alchemist* – see below – that "...semi-precious and precious stones have been made at the Rose-Croix University by a process similar to that of St. Germain. A famous jeweler of two continents has spent three months testing a topaz which was made at Rose-Croix University and has pronounced it one of the finest he has ever seen".

Frater Graves explained that there was a wonderful spirit of harmony in the old classes, and that people would take turns staying up all night, as some of the processes required that the furnace and condensers were kept at specific temperatures both day and night for prolonged periods of time. We then discussed the "Alchemical Laboratorium" kits that AMORC developed at that time and sold until the early 1980's.

OG: Did you get one of them?

RH: Yes, I did.

OG: Oh good. Did you happen to get one when they were making

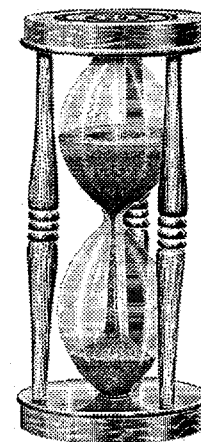

what they call the alembic, the alchemist's condenser?

RH: What I had was a simple tube that went from the flask through a bowl of water. Did you have a different one at another time?

OG: Yes, when we started out, but it was too expensive. We started out making the condenser out of metal, real hard metal, and it could withstand the strain, but they were too expensive and they didn't sell. But that's about all that I could add other than that the research library was encouraged to find the modern authors and research. I think that that's where (Albert) Reidel got his idea of carrying on with his various contacts around the country.

RH: Did you use the book *Alchemy Rediscovered and Restored* by (Archibald) Cockren much?

OG: Yes we did. That had, as I recall, a comparison between the oils of metals and the oil of the various herbs. And as you probably know, George (Fenzke) had perfected that for the herbs.

RH: Yes, he was quite a fellow. He kept up with things after studying at the college (AMORC's Rose-Croix University), and then with Albert (Reidel) for awhile.

OG: Yes. He sent me a letter from Germany. That someone had discovered over there and was working on our type of laboratory Alchemy. And evidently he encouraged them and has contact, but Reidel's group has kind of gone by the wayside but they had nobody there to encourage them.

RH: I think that there were probably among his students some people like George (Fenzke) who, had they had the interest, could have taken things on, but I think Mrs. Reidel only wanted someone who would do exactly like Albert.

OG: And then Albert got off on the Hebrew ladder of the Qabala and things of that sort, and he went a little bit overboard. Which is very interesting (Qabala), but I didn't think it stays close to Paracelsus. I tried to encourage everybody, even though they didn't understand it, to follow Paracelsus. And I still think he's the best with that book (the two volume collection of writings edited by A. E. Waite). What's similar to it, did you hear of Richard Ingalese, did I mention his name?

RH: Yes, you did at the class in 1989, and I've read *They Made the Philosopher's Stone* that he wrote.

OG: Well, he wrote twelve books. If you could find any one of them it would be worth it, but a couple of them are really into Alchemy, laboratory Alchemy, as we followed Paracelsus. They're very hard to find. I have all but two of them, I think. One of them had to do with *History and Power of Mind*. You have probably heard of that. That was as popular as the Bible was for a few years, but that was more or less mental alchemy – that wasn't the physical. His book on reincarnation and another one, I can't recall the exact title, but it had to do with the old masters. He never identified who the masters were. But after he got his oil of metals he disappeared and no one has ever seen him or his wife again. I've heard of him. (*Laughter*). Down near Los Angeles where he was supposed to have talked and studied, and I tried to interview different people and they couldn't give me information at all.

RH: Do you know the formula that you had in classes in the 1940's for St. Germain's tea? How did you happen to find that?

OG: Well, it was very natural. There was a man from Holland who was an AMORC member, a Dutchman and a young man -- you might have run across him. He didn't have time to attend the Alchemy class but he got interested in it and I told him about St. Germain and so on, and he said that someone over there in Holland had the formula, and he compared it and got some notes out of the ... have you seen the book *St. Germain* by Manly P. Hall?

RH: Yes, I think I have seen that one. I am familiar with the one that Isabel Cooper-Oakley wrote.

OG: They were similar. And so, he put great store – I've double-checked two or three cross ways and then it came out very similar. I think it's one of the most potent books on St. Germain's tea that I've ever seen. The references to it, anyway.

RH: Right now I am trying to get some of the European flowering ash, or the manna resin to make up a little bit (of the tea). It's not so easy to get.

OG: No, it isn't. I remember that we had a very, very difficult time. In fact, we had (*laughs*), we didn't have it very long. You know, you get such a small amount.

But, I've given up and haven't tried to use that formula. For awhile you could get it in health food stores (*this was a product of Frater Albertus which was distributed through ParaLabs*), but it didn't have the manna and it didn't have a couple other things in it. So, I just stick to melissa. (*Incidentally, it was after Graves efforts to follow Paracelsus in all things that melissa became the first herb used in the AMORC classes, as it was considered by Paracelsus to have more quintessence than other herbs. The tradition was passed down to the students of Frater Albertus, to the AMORC classes that were revived in 1989, and in the first lessons of The Philosophers of Nature – Jean Dubuis got his start with one of the old AMORC lab kits.*)

RH: That's pretty good stuff isn't it?

OG: Did you ever hear of that little tonic, "bitters" that's in health food stores?

RH: Yes, like Swedish Bitters?

OG: Yes, that's the one. You saw what they said about Paracelsus on that.

RH: Yes, I went through quite a bit of Paracelsus' writings and I've never really seen quite the same formula.

OG: (*Laughter*). No. I agree with you.

RH: I wonder if there was really an exact formula that was produced from, or if it was more or less the spirit of some of his ...

OG: Well, this is my off the cuff thing to you – you follow the process and let the formula come out of its own accord. Test it. I think that Cockren's book kind of hinted at that. But the formula, St. Germain's formula, did vary from time to time, but that (*one*) we got from Holland, he claimed that he got it from some native over there, that I liked a bit better than some of the other ones.

The interview was then finished.

In the 1940's, Graves wrote a number of articles for the AMORC magazine, many on Alchemy. These were always quite interesting, and reflected his skills in finding unusual information, a task helped by the rare documents he would have access to as librarian and university Dean.

In one of them, *The Munificent Alchemist*, Graves addressed the life and exploits of one of his favorite personalities – Comte Saint-Germain. In the article, he mentions correspondence by a nobleman named Graffer, that indicated that St. Germain's secret of his elixir for long life was usually obtained from herbs. The secret of this elixir was once given to Prince Youssouppoff of Moscow. St. Germain often gave of this herbal elixir to the poor and the weak. Despite his generosity, there were problems in discovering the formula of this tea – *aqua benedetta* as it is sometimes called, and one druggist spent 10,000 Crowns in search of this medicine.

George Fenzke's notes from a 1940's AMORC Class gives the following formula:

St. Germain's Formula

- ◆ Senna -- 2 grams
- ◆ Manna -- 15 grams (Note: this is a gummy product from the European flowering ash tree, *Fraxinus ornus*)
- ◆ Anise -- 1 gram
- ◆ (Fennel flowers) "*or elders*" is handwritten
- ◆ Elder -- 4 grams

Below is handwritten: "use four", one implication being that either Fennel or Elder flowers are used, but not both. Graves' article indicates that there are five ingredients.

Manna is difficult to obtain, but is available in Sicily. The methods of manna production are an endangered tradition, and it left mostly to the old people to harvest. Manna is easily soluble in water, as it is a sugary product from tree sap which hardens in the air. Before drying, the sap has a violet cast. I have seen the tree growing at Fountainebleu near Jean Dubuis' home in France.

Often manna is infested with moths as they lay their eggs in the product. They can be easily filtered out of the solution. The formula should be considered as a tea, rather than as a traditional elixir with strong alcohols. The formula as a whole should help to purify the body and facilitate removal of toxins.

RESEARCH NOTICES:

ORA Project Has New Director of Research

Mark Stavish has accepted a position as the new Research Director for the ORA (Occult Research and Application) project. Mark has written a number of articles for the PON on various topics, and is currently working on a book on Alchemy. In fact, the publication *Ariadne's Web* will be printing some selections from this book beginning with their December 1996 issue, and spanning the two following issues. The emphasis is on practical alchemical work, but with a blending of practical esoteric/magical techniques.

Mark is a very sharing, energetic and knowledgeable man, who has a knack for getting things done. Plan to hear more from Mark in the next issue of *The Stone*. The Founding Director of ORA, Ken Miller, will continue his involvement in this research project.

Entrainment Technology Project On Hold

In the last issue, we announced that Walter Griffin is leading the ET (Entrainment Technology) Project. Based on recommendations made by Walter, the Board has suspended the ET project for the time being, primarily for the reason that we question whether or not the project will further the stated mission of the association. We have accepted the resignation of Walter Griffin as a Director of Research, and are not actively engaged in mind machine research projects at the present time. Walter remains active as Board Treasurer.

How to Become Active in Research

If you would like to participate in research in one or more of these fields, please forward your name, address, telephone number, email address (if available), and your specific interests to the research directors:

<p>ORA Project (reports in May & November) c/o Mark Stavish, Director of Research 58 Carey Avenue, Wilkes-Barre, PA 18702 USA Email address pending – for the present, use: Email: alchemy@mcs.com Type "ORA" in message.</p>
<p>LABORA Project (reports in January & July) Philosophers of Nature "LABORA" Director of Research - Curt Kobylarz-Schmidt 125 West Front Street, Suite 263, Wheaton, IL 60187 USA Email: alchemy@mcs.com Type "LABORA" in message.</p>

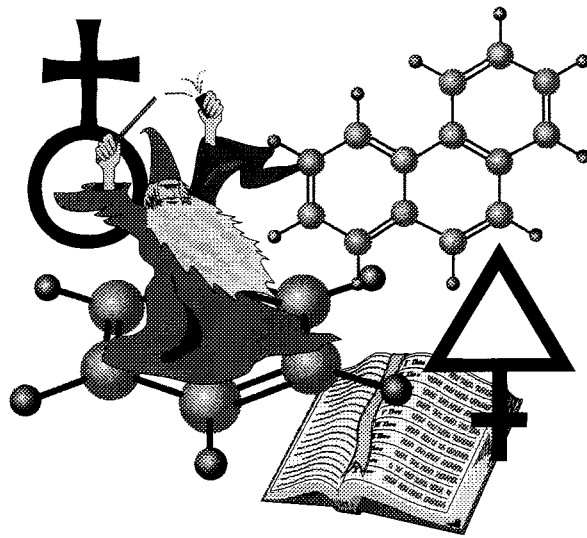

Some Minerals from the various Crystalline Systems

from a handout by Jean Dubuis
 at the October 1996 Lecture in Glen Ellyn, IL
 Notes in (parenthesis) by Russ House

Cubic	<ul style="list-style-type: none"> • Diamond (Carbon) • Galena (Lead Sulfide) • Iron Pyrite (Iron Sulfide)
Quadratic (Tetragonal)	<ul style="list-style-type: none"> • Cassiterite (Tin Oxide) • Zircon (Zirconium Silicate)
Orthorombic	<ul style="list-style-type: none"> • Sulphur (Sulphur) • Cerussite (Lead Carbonate)
Monoclinic	<ul style="list-style-type: none"> • Wolframite (Manganese Iron Tungstate) • Gypsum (Hydrated Calcium Sulfate)
Triclinic	<ul style="list-style-type: none"> • Chalcantite (Hydrated Copper Sulfate) • Rhodonite (Manganese Iron Magnesium Calcium Silicate)
Rhombohedral (Trigonal)	<ul style="list-style-type: none"> • Cinnabar (Mercury Sulfide) • Calcite (Calcium Carbonate) • Corundum (Aluminum Oxide)
Hexagonal	<ul style="list-style-type: none"> • Zincite (Zinc Manganese Oxide) • Pyrrhotite (Iron Sulfide) • Beryl (Beryllium Aluminum Silicate) • Quartz (Silicon Oxide) • Graphite (Carbon)

RESOURCES:

References for laboratory equipment, supplies, and materials to support the efforts of researchers. Please inform us of new suppliers, and let us know if supplier addresses and phone numbers change. We do not list suppliers of medicines for internal use, for practical reasons.

Alchemical Resources
<p>Al-Kemi 1807 2nd St., Suite 9, Santa Fe, NM 87505 USA Tel: 1.505.988.7315 (Noon -- 10 PM MST) <i>Glassware for alchemical work.</i></p>
<p>American Science and Surplus 3605 W. Howard St., Skokie, IL 60077 USA Tel; 1.847.982.0874 Fax: 1.800.934.0722 http://www.sciplus.com/ <i>Request catalog (available in USA and territories only). Science & hobby kits, motors, electrical components, educational and office supplies, novelties and toys.</i></p>
<p>Bryant Laboratory, Inc. 1101 Fifth St., Berkeley, CA 94710 USA Tel: 1.510.526.3141 or 1.800.367.3141 Fax: 1.510.528-2948 <i>Mail-order labware and chemicals.</i></p>
<p>Centaur Forge, Ltd. 117 North Spring St., PO Box 340, Burlington, WI 53105-0340 USA Tel: 1.414.763.9175. Fax: 1.414.763.8350 <i>Temperature crayons, forges, blacksmiths' supplies, such as tongs, aprons, etc.</i></p>
<p>David Shannon 6649 E. Rustic Drive, Mesa, AZ 85215 USA Tel/Fax: 1.602.985.0557 <i>Minerals by the specimen or in bulk.</i></p>
<p>Dr. Michael's Herbs 5109 N. Western Ave., Chicago, IL 60625 USA Tel: 1.312.271.7738 <i>Herbs.</i></p>
<p>Hagenow Laboratories 1302 Washington St., Manitowoc, WI 54220 USA Tel: 1.414.683-3339 <i>Bargain priced labware and supplies by mail-order.</i></p>
<p>TRIAD 125 West Front Street, Suite 275, Wheaton, IL 60187 USA Email: majrcana@aol.com <i>Request price listing. Stibnite, Alchemical books, Marseilles Tarot Deck, high purity essential oils, hard-to-find items.</i></p>

Books

<p>Banton Press Mark Gordon Brown Dippin Cottage Isle of Arran, KA27 8SB, UK <i>Handmade, perfect bound paperbacks of facsimile reprints; 20 alchemical titles, plus other topics.</i></p>
<p>Chthonios Books 7 Tamarisk Steps Hastings, TN34 3DN, England Tel/fax 01424 433302 (+44 1424 433302 internationally) <i>Scholarly titles from publishers worldwide which deal with Esoteric Studies, and second-hand books.</i></p>
<p>J.D. Holmes PO Box 623 Edmonds, WA 98020 USA Fax/Phone 1.206.771.2701 <i>Series of inexpensive reprints of alchemical works.</i></p>
<p>Kessinger Publishing P.O. Box 160, Kila, MT 59920 USA Tel: 1.406.756.0167 Fax: 1.406.257.5051 Email: books@kessingerpub.com http://www.kessingerpub.com <i>Over 1000 titles on Hermetic and Masonic topics</i></p>
<p>Phanes Press P.O. Box 6114 Grand Rapids, MI 49516 USA http://www.phanes.com <i>Publishes & distributes books which relate to the spiritual and philosophical traditions of the West.</i></p>
<p>R.A.M.S. Hans Nintzel 733 Melrose Drive, Richardson, TX 75080 USA <i>Photocopies of translations of alchemical texts.</i></p>
<p>Todd Pratum Book Company P.O. Box 985 Healdsburg, CA 95448 USA Tel: 1.707.431.2634 Fax: 1.707.431.0575 <i>Specialist in Philosophy, History of Religions, Mythology, and Metaphysics. Old, New & Rare.</i></p>
Entrainment Technologies
<p>Tools for Exploration 47 Paul Drive, San Rafael, CA 94903-2118 USA http://www.tools4explore.com <i>Light/sound machines and consciousness tools</i></p>

Newsletters

Caduceus: The Hermetic Quarterly

Cinnabar,

P.O. Box 95674, Seattle, WA 98145 USA.

A quarterly journal of the Hermetic tradition. Subscription prices are \$18 US per year within North America and \$25 US per year overseas; checks should be made payable to Cinnabar.

Cauda Pavonis: Studies in Hermeticism

Stanton J. Linden, Editor,

Cauda Pavonis, Dept. of English,

Washington State University,

Pullman, Washington 99164-5020 USA.

Published twice each year, in the spring and fall. Now in its fifteenth year, it publishes scholarly material on all aspects of alchemy and Hermeticism and their influence on literature, philosophy, art, religion, and the history of science and medicine. Annual subscription cost is \$10.00 for individuals, \$12.00 for libraries and foreign subscribers. Checks should be made payable to Cauda Pavonis; foreign subscribers should pay by checks drawn on banks with American branches.

Ambix, The Journal of the Society for the History of Alchemy and Chemistry

Scholarly articles and reviews of books on all aspects of the history of alchemy and chemistry, published in March, July and November. The annual subscription to the Society costs £20.00 (\$32). This should be sent to Dr. N.G. Coley, 24 Kayemoor Road, Sutton, Surrey, SM2 5HT, UK. Members receive the current volume (3 parts) without further payment. Most back issues are available at £15.00. For non-members, libraries and institutions, the annual subscription to Ambix is £38, and most back issues are available at £24. Orders for non-members should be sent to Black Bear Press Ltd., King's Hedges Road, Cambridge CB4 2PQ, UK.

Internet

The Philosophers of Nature

<http://www.mcs.net/~alchemy>

We maintain an **updated resource list** on our site.

The Alchemy Virtual Library

<http://www.levity.com/alchemy/>

Over 28 megabytes of information on alchemy in all its facets organized by Adam McLean.

PRACTICAL TIPS: Drilling Glass

by Russ House



I have had occasion that required drilling a hole in glass without breaking it. My father once told me of a way to use the back part of a drill bit, and to use turpentine on the glass as a cooling agent, but I never tried this. Over a year ago I ran across some information on the Internet, which happened to coincide with my needing to drill a hole in the center of a thin glass circle. The material was about 3/64" thick. I was able to make 2 pieces successfully and break only one, using a process based on the following:

A variable speed electric drill or a hand drill can be used. For small pieces such as I was doing I used a small Sears-brand rotary drill as used by hobbyists (a Dremel-type drill), with hardened dental bits.

Various manufacturers make specialized carbide-tipped drill bits for drilling glass from 1/8 to 1/2" diameter.

With the bit held in your hand, carefully make a small chip in the glass where you want the hole to be centered. This will help prevent the drill bit from 'wandering' while drilling.

Use a cutting agent such as kerosene or turpentine to keep the bit and the glass cool. This is necessary to prevent damage to the drill bit, and to keep the glass from breaking.

Drill at slow speed (not above 200-300 RPM), while stopping every minute or two to dip the bit in the cutting agent. If whitish smoke begins to rise from the hole, stop immediately, dip the bit in the cutting agent and wait for it and the glass to cool before proceeding.

The most critical time is when the bit is almost all of the way through the glass... go slow and use less pressure and more cutting agent.

Wear eye protection at all times, and wear gloves if there is any danger of being cut by breaking glass.

MINERALS FOR THE PORTÆ LUCIS WORK:

This path for *making an Eternity Contact using simplified methods* was quite clearly explained in the excellent seminar by Mr. Dubuis held in Glen Ellyn, IL, October 18-20. The surveys we received from those attending the seminar, as well as the comments made to us indicate that this was the finest presentation by Mr. Dubuis to date.

Those who attended the seminar, and those who have viewed the video tape of that seminar, *Portæ Lucis: Volume 1, An Introduction*, will be looking for some specific materials. At the present time, we are able to offer specimens of native diamond, galena, silver and gold. As we anticipated in the November 1996 issue, we were able to significantly reduce the prices for native gold. All gold is shown as an approximate weight in dwt (pennyweight). Our 0.3 dwt samples average about 4 x 6 mm, and cost \$16.50 as opposed to the \$45.00 cost in the previous price list. The 0.1 dwt samples contain from 1 to 4 pieces of gold to make the appropriate weight. NOTE: We have refunded any overpayment and have sold gold only at these reduced prices. At the time of this printing, prices are as follows:

Item No:	Description:	Source:	Approx. Size:	Price Ea.,
DI-010	Diamond, Industrial grade octahedral crystal	South Africa	1 mm.	\$23.00
DI-015	Diamond (as above) *	South Africa	1.5 mm	\$27.00
DI-020	Diamond, native, cubic	Africa	2 mm	\$28.00
AU-201	Gold, native	California	0.1 dwt	\$6.00
AU-202	Gold, native	California	0.2 dwt	\$11.50
AU-203	Gold, native	California	0.3 dwt	\$16.50
AU-204	Gold, native	California	0.4 dwt	\$22.00
AU-205	Gold, native	California	0.5 dwt	\$28.00
AU-206	Gold, native	California	0.6 dwt	\$32.00
AR-001	Silver dendrite crystal group, very pure *	Mexico	Small	\$32.00
AR-002	Silver dendrite crystal group, very pure	Mexico	1 - 2 cm fronds	3 pcs. for \$16.00
PB-001	Galena, cleavable, high quality	Kansas & IL	25 x 25 mm	\$4.00
PB-010	Galena, cleavable, high quality	Kansas & IL	25 x 25 mm	10 pcs. for \$32.00

Please make checks payable to Philosophers of Nature.

Add \$3.00 for US postage, \$5.00 for Canadian, \$8.00 for all other countries.

*Please allow 4-6 weeks for delivery. Supplies are limited. * Only 1-3 pieces available, specify second choice*

Got your curiosity? Get the new Jean Dubuis tapes advertised on the next page...

UPCOMING SEMINARS -- 1997

In response to the requests of people attending the most recent seminar of Mr. Dubuis, there are tentative plans for Mr. Dubuis to return to the US to work very specifically on the "Portæ Lucis" method of Eternity Contact. We are waiting for confirmation from France, and will make announcements to subscribers and members when we have the details.

Jean also plans to join us for the Colorado Springs seminar, July 17-20, 1997, along with numerous other lecturers. We will be making final announcements as soon as possible.

Did you like the lab apparatus that was pictured in this issue?

This was created using the CD-ROM based clip art called chemCLIPART, as well as clip art in Corel Draw version 6.0. For, chemCLIPART contact:

Indigo Instruments,
600 Main St., P.O. Box 888
Tonawanda, NY 14150-0888 USA

Internet: <http://www.indigo.com>



Remember to Renew...

Your PON membership or subscription expired on December 31, 1996 unless you renewed or had previously paid your 1997 fees.

Announcement:

P.O.N. SEMINAR VIDEO TAPES NOW AVAILABLE!

Good News – Bad News – Great News – Unbelievable News!

Good News:

The Philosophers of Nature has removed most of the obstacles that have kept us from releasing the majority of our video archives of our seminars. This has been a long and frustrating delay for all of us.

Bad News:

Just as we were completing this hurdle, a very expensive Super VHS camera was stolen from the studio of Rick Grimes. Rick has lovingly devoted his time and the use of his equipment to tape, edit and produce the video tapes since the beginning in 1992. Sadly, Rick and the PON have lost the use of an important tool, a key component in the final production stages.

Great News:

We are releasing tapes despite this! And quickly, because we know you are waiting on them. In fact, we are releasing several important tapes right now, and are taking orders for them.

Unbelievable News:

We are selling these tapes at the unbelievable price of ***\$19.95 per set of two tapes*** including postage *with up to 6 information-packed hours per tape!*

We are selling these tapes as a service to our members and subscribers so that they can have the information NOW. These specific tapes that we have selected are in demand because of their important content.

The fine print:

There is a catch, and we want to make sure that you understand what it is before you order. The tapes are of lower quality than the standards we have set for our video productions. Despite that, these are better than our 1992 tapes in terms of sound quality (which is quite good with one exception that we will note), and of a slightly lesser quality in terms of video resolution. There was no editing done... you see what the camera caught, including paper shuffling, and thoughtful pauses.

When we are able to obtain the necessary equipment to edit and reproduce these tapes using Super VHS technology, and to enhance the soundtrack in the one place that it is impaired, we will discontinue this offer, and release the tapes in a near-broadcast quality. At that time, the prices will increase accordingly.

In short we want you to have the information now if you want it, while we are working on the new editions. We think that you will be pleased with these tapes.

ORDERING INFORMATION

Item No:	Lecturer:	Title and Topic:	Date/Place:	Price:
VHS-D-10	Jean Dubuis	<i>Portæ Lucis Volume 1: An Introduction</i> <i>A widely acclaimed seminar on new techniques for Eternity Contact using simplified methods. Highly recommended.</i>	Oct 1996 Illinois	\$19.95 2 tape set
VHS-K-10	Curt Koby larz-Schmidt	<i>Quantum Physics, Alchemy & Chemistry</i> <i>The first of his information-packed seminars for PON ... and... "The Stone of the Wise and Unwise..." considered to give keys into metallic fermentation (sound quality is at very low level).</i>	Sept 13, 1994 Illinois May 30, 1996 Colorado	\$19.95 2 tape set
VHS-G-10	Jack Glass and Russ House	<i>Introduction to Spagyrics & Alchemy</i> <i>A hands-on two-tape set tape showing how to get started with plant alchemy, working toward a plant stone</i>	Sept 12-14, 1994 Illinois	\$19.95 2 tape set
VHS-T-10	Kevin Townley	<i>The Cube of Space and other Cosmological Things</i> <i>the author of <u>The Cube of Space</u> elaborates on this all-important Qabalistic symbol as the Container of Space.</i>	May 28, 1996 Colorado	\$10.95 1 tape

POSTAGE PRICES: US postage included. Canadian customers should add \$6 per set. For other countries, please add \$10 per set. Please use the enclosed order form. All seminar handouts (if used by the lecturers) are included with the tapes. Allow 4-6 weeks for delivery. Offer may be withdrawn at any time. No returns without authorization. Tapes copyright PON, 1996. Copying prohibited by law.

A simple distillation train such as that pictured at left is not particularly expensive, and is suitable for most of the routine distillation requirements for a student of Spagyrics. This is suitable for the distillation of spiritus vini from red wine, for example, though not as efficient as the setup which appears in the article on page 2 of this issue.

The large flask can be heated using a heating mantle, or a sand bath. For example, an iron dish with the bottom covered in clean sand, is set on a heat source, whether a gas burner (caution when distilling flammables!) or an electrical heater. The large flask is clamped into place with the bottom of the flask touching only sand – not the bottom of the metal dish. More sand is added, to cover the flask to perhaps $\frac{1}{4}$ of its height.

Boiling beads should be used in the large flask to smooth the boiling action, and to avoid “bumping”. Stopcock grease, or high-vacuum silicone grease should be applied to all ground-glass joints to prevent them ‘freezing’ when heated.

The apparatus shown has an adapter just above the receiving flask to permit using vacuum to aid in the distillation. This is a useful method, covered more extensively in the *Spagyrics* course.

We encourage our readers to practice safety in every procedure that they do. We suggest that you begin every work by inner attunement in whatever way that you chose to use, and that you practice visualizing every step in your work – every setup, every procedure – in great detail **before** you begin to work. This develops valuable visualization skills, and greater attunement, as well as leading to safer practice in your laboratory.

Ora et Labora!

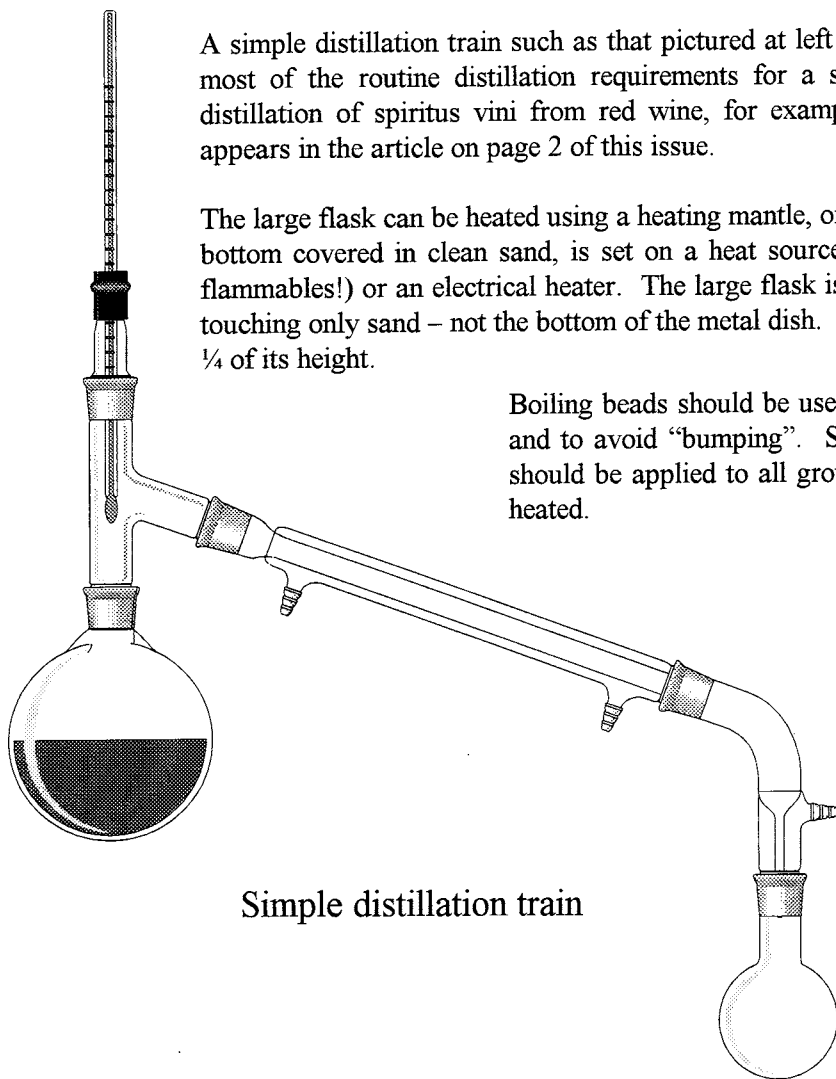

Simple distillation train

ABOUT THE STONE

The Stone provides a forum for articles (5000 word maximum), conference announcements, research summaries and other items of interest to PON members and our subscribers. Authors should, if possible, submit manuscripts as an email attachment to alchemy@mcs.com using a plain text (ASCII format) or mail them on disk along with unmarked, printed copies. Publication decisions are normally made within four to six weeks. Selected articles from *The Stone* will be republished on the PON Internet site of PON at the discretion of the editors.

The Stone is published every two months, and is normally mailed on the 2nd Monday of the odd-numbered months.

Subscriptions to *The Stone* are \$30.00 US per year for non-members, and are free to active members. Membership dues are \$30.00 US per year. Subscriptions are for January through December – all back issues for current year are sent to new subscribers. Add \$10.00 for foreign postage. Make payment by credit card or by check drawn on a bank with a US branch.

Send all inquiries to:

The Philosophers of Nature
 125 West Front Street, Suite 263,
 Wheaton, IL 60187 USA
 Email: alchemy@mcs.com

THE STONE

THE JOURNAL OF THE PHILOSOPHERS OF NATURE

© 1997, THE PHILOSOPHERS OF NATURE. ALL RIGHTS RESERVED.

ISSUE NUMBER 19

SPECIAL SEMINAR EDITION

MARCH-APRIL 1997

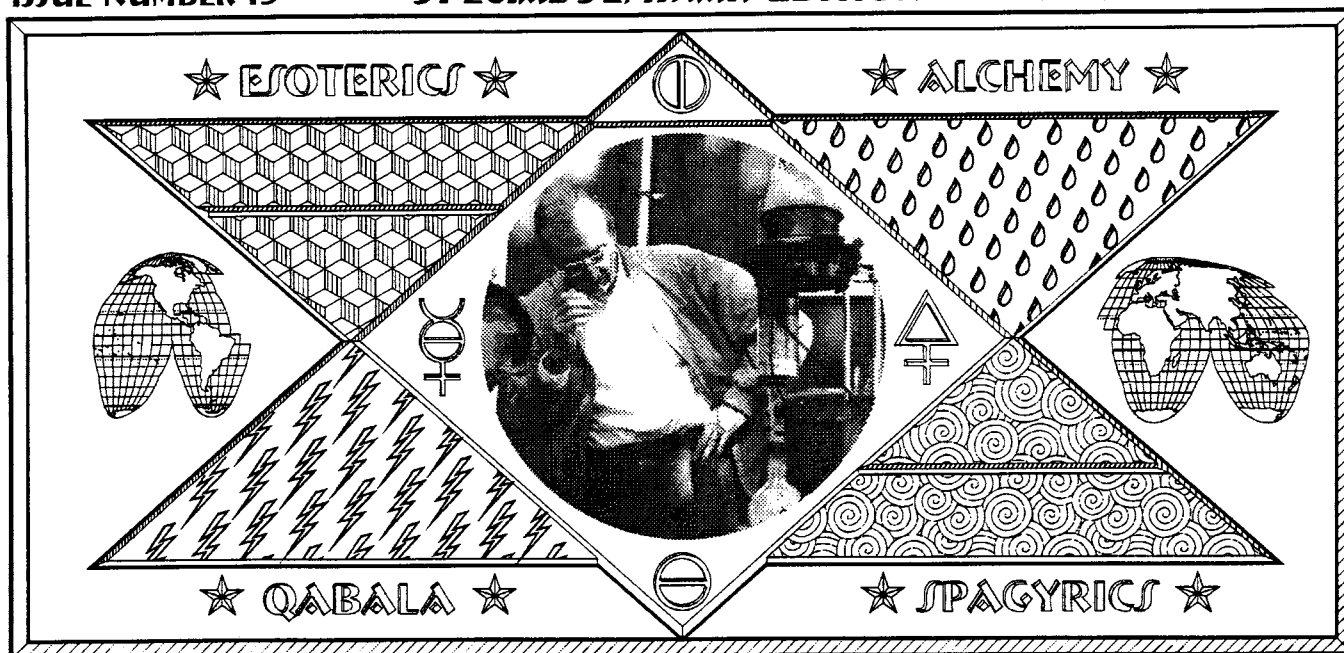

IN THIS ISSUE

	Article or Feature	Author	Page
♀	A Message from the President	Russell House	2
♀	THE 6TH ANNUAL PON CONFERENCE - JULY 17-20, 1997	PON	3
♀	An Interview with Mark Stavish	Russell House	4
♀	Problems on the Path of Return: Pathology in Kabbalistic and Alchemical Practices	Mark Stavish, M.A.	11
♀	An Interview with John Reid, III	Russell House	24
♀	An excerpt from: <u>The Minor Opus</u> ; Chapter 5: Alkahest of the Vegetable Kingdom.	John H. Reid III	28
♀	Minerals for the Portae Lucis Work	PON	29
♀	Video Tapes	PON	29
♀	Cover Photo: Jean Dubuis and Patrice Malézé (at left) test equipment for production of Butter of Antimony from Stibnite, Winfield, IL, 1993.	Russell House	Cover

Editor-in-Chief: Rick Grimes; **Production:** Le Philosophe Inconnu

Published six times per year by The Philosophers of Nature

Price: \$5.00 US

THE PHILOSOPHERS OF NATURE

125 West Front Street, Suite 263, Wheaton, IL 60187 USA

Tel: 630.682.3938 Fax: 630.665.2364

Email: alchemy@mcs.com Internet: <http://www.mcs.net/~alchemy/>

A Message from the President

by Russ House

Get ready for some good advice. Mark your calendar for July 17th through the 20th. Contact your travel agent, and book a flight to Colorado Springs. Plan to arrive on the afternoon of the 16th so that you can have some time to unwind in the pleasant mountain air before the seminar begins. It will be a really great time that you will remember for years to come. Get ready to make new friends, and to renew your connections with your companions on the Path of Return. Prepare to stretch your imagination in an inspiring setting in the Rocky Mountains.

In brief, come to the 6th Annual Seminar of The Philosophers of Nature – you will be glad you did. Among the lecturers, you will see some old favorites return, as well as some that you will be excited to meet for the first time.

The seminar is the focal point for this issue of The Stone. Inside this issue are details on the event, as well as interviews with a number of the lecturers, and articles from them, so you can get to know them a bit better before the seminar.

Rather than have you wait two months to read the second part of some lengthy contributions, we have chosen to omit two of our regular features, the Resource Listing and Practical Tips, to make room. They will be back in the next issue, along with articles from Joe Caezza, Beat Krummenacher, and others.

In the May - June issue, we will publish the report of the ORA (Occult Research and Application) project. This activity is lead by Mark Stavish. We have just received his paper "A Kabbalistic Guide to Lucid Dreaming and Astral Projection", which is based on research conducted by Mark this Winter. The paper gives some theoretical background, and the detailed steps for performing the experiment which, "will help spiritual aspirants to have interior contact at night with their Higher Self, or Interior Master". We think that you will enjoy this practical approach.

Spring is the time of renewal and new life in Nature's cycle. The Philosophers of Nature has likewise prepared for this season, through the darkness of the Winter,

waiting for the increased Light of the Sun to herald the new forms that will come to bear fruit in the proper time.

While it is premature to give all of the details of the unfolding plans, I would like to share the good news. Over the past months, we have been in contact with several members in other countries who would like to help in making our work available to students in their native languages. To this end, there are preparations, in various degrees of maturity, to publish the course materials and other papers in German, Spanish and Portuguese. More information on our progress should appear in May issue of The Stone.

I know that our members are interested in the status of the new course on Esotericism being written by Jean Dubuis. Jean completed the main work of the course before the end of 1996. After reviewing the work, Jean decided to expand upon it, to add more depth where possible, and to add supplementary instructions that help make the material more easily understood. This process of revising the course is in progress.

The video *Portæ Lucis, Volume 1: An Introduction* contains the main points of the practical work as well as the theory which is covered in the new course.

It is too early to say when we will offer an English translation of the completed course. I feel certain that it will be at some time after the conference in July. Perhaps at the conference and in the July issue of The Stone, we can announce the publication date of this long awaited work.

It is with great pleasure that I invite you to read this issue of The Stone. Let it offer inspiration, encouragement and refreshment, until we meet again. If at all possible, I hope that we can meet in Colorado Springs in July.

With good wishes for you on your Path,

ORA ET LABORA!

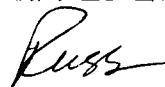

**THE 6TH ANNUAL
PHILOSOPHERS OF NATURE
CONFERENCE
JULY 17-20, 1997**

Franciscan Center at Mount Saint Francis
Colorado Springs, Colorado

CONFERENCE LECTURERS

JEAN DUBUIS, the founder of Les Philosophes des la Nature, and author of the courses of the Philosophers of Nature, will present the theoretical background and methods from the new course in Esotericism that he is developing. This will be Jean's 9th trip to the U.S. for the PON.

CURT KOBYLARZ-SCHMIDT, a chemist and alchemist, and Director of Research for the LABORA Project (Laboratory Alchemy) will speak on Alchemy in the metallic realm.

JOHN REID, III, author of The Minor Opus, a work on Plant Alchemy, will speak on practical alchemy.

MARK STAVISH, Director of Research for the ORA Project (Occult Research and Application) for PON will speak on practical esoteric and qabalistic practices.

REGISTRATION INFORMATION

EARLY REGISTRATION FEES:

(Registration postmarked, faxed or emailed before May 15, 1997, and all fees paid in full)

Members: \$375.00.* Non-members: \$425.00

REGISTRATION AFTER MAY 15:

(We suggest that you send a deposit of \$100.00 by May 15, 1997, to reserve your place)

Members: \$425.00.* Non-members: \$475.00

FOR COUPLES:

Add \$190.00 to the price above for a couple if either registrant is a member; for non-members, add \$210.00

* **NOTE:** A member is an individual who has paid annual dues of \$30.00 through 12/31/97.

FEES INCLUDE FOOD AND LODGING. Rooms are double occupancy with some triple occupancy available.

ROOM ASSIGNMENTS are on a first come, first served basis. All rooms are non-smoking. The maximum number of registrants will be 100. There are accommodations for 70 persons on site.

TO REGISTER, send the enclosed registration form to:

The Philosophers of Nature "CONFERENCE"

125 West Front Street, Suite 263-w

Wheaton, IL 60187 USA

Tel: 630.682.3938 Fax: 630.665.2364



**SEMINAR LOCATION AND
TRAVEL INFORMATION**

THE FRANCISCAN CENTER is less than 30 minutes from the Colorado Springs airport. For directions, please call the center:

Franciscan Center at Mount Saint Francis

7765 Assisi Heights, Colorado Springs, CO 80919

Tel: 719.598.5486 Fax: 719.260.8044

LIMOUSINE SERVICE is available from Pikes Peak Limoseen, Tel: 719.577.4486.

CAMPING may be available at the scenic Garden of the Gods, Tel: 719.475.9450

INTERNET RESOURCES:

Travel information is available on our web site, at <http://www.mcs.net/~alchemy> as well as any updates to the seminar program.

CONFERENCE SCHEDULE ON FOLLOWING PAGE.

WE HOPE TO SEE YOU IN COLORADO...

CONFERENCE SCHEDULE

Note: The Philosophers of Nature reserves the right to make necessary changes in this program. Unforeseen circumstances may result in the substitution of a presentation topic or speaker. Any program updates will be made available as known. This schedule is accurate as of 3/3/1997.

DAILY BREAKS will take place around 10:30 AM and 3:30 PM, in addition to ample time for meals and relaxation.

WEDNESDAY, JULY 16

2:00 - 9:00 PM -- The grounds are open for arrivals.
6:00 PM -- Dinner (must reserve at time of pre-registration)

THURSDAY, JULY 17

8:00 AM -- Breakfast
9:00 AM -- Registration, Introductions of Speakers
9:45 AM -- Jean Dubuis: The Portae Lucis Path in Esotericism
12:00 Noon -- Lunch
2:00 PM -- Mark Stavish: Topics on Practical Qabala
5:00 PM -- Free Time
6:00 PM -- Dinner
7:30 PM -- Mark Stavish: Topics on Practical Qabala

FRIDAY, JULY 18

8:00 AM -- Breakfast
9:00 AM -- Jean Dubuis: The Portae Lucis Path in Esotericism
12:00 Noon -- Lunch
2:00 PM -- Curt Kobylarz-Schmidt: Topics in Alchemy
5:00 PM -- Free Time
6:00 PM -- Dinner
7:30 PM -- Curt Kobylarz-Schmidt: Topics in Alchemy

SATURDAY, JULY 19

8:00 AM -- Breakfast
9:00 AM -- Jean Dubuis: The Portae Lucis Path in Esotericism
12:00 Noon -- Lunch
2:00 PM -- John Reid, III: Topics in Plant Alchemy
5:00 PM -- Free Time
6:00 PM -- Dinner
7:30 PM -- Open Forum with Board of Directors of PON,
Questions and answers on courses and research.

SUNDAY, JULY 20

8:00 AM -- Breakfast
9:00 AM -- Jean Dubuis: The Portae Lucis Path in Esotericism
11:15 AM -- John Reid, III: Topics in Plant Alchemy
12:00 Noon -- Lunch
1:00 PM -- Wrap-up, announcements, and farewell
2:00 PM -- Closing of Conference

An Interview with Mark Stavish

by Russ House

Mark Stavish is the Director of Research for the Philosophers of Nature ORA Project (Occult Research & Application). Mark also serves the PON as a Regional Director for the Northeastern United States. We are looking forward to his presentations at the upcoming seminar in July 1997 in Colorado Springs. Mark was interviewed on Saturday, February 15, 1997.

RH: *Mark, can you tell our readers a little about yourself?*

MS: My professional background is in theology as well as communications, which is a bit of a joke, because everyone thought when I was in undergraduate school that I would become a televangelist, which probably would have been a very profitable thing to do. My graduate training is in counseling and I did drug and alcohol counseling on the family level for quite a few years. Recently most of what I have been doing has been free-lance writing as well as some correspondent work for area papers, and until recently I was also doing public relations work for a local hospice.

My professional background has always been in the area of psychology or theology and how they affect us in our daily life, and communicating that to others, finding a way of involving others within it and making it easy for them to understand and applicable.

My personal background as far as esotericism has been something very personal since it has always been a part of my life in one fashion or another. My family did have a tradition of occult practices that they brought over with them from Europe and which they had practiced there for God knows how long, as we are not really sure. They are related to traditional folk practices and Medieval Qabala.

RH: *Did these practices through your family influence your writings on German Pow-Wow traditions?*¹

MS: Yes. That is really a semi-autobiographical piece, and that is what prompted it because it was a family thing, and really limited to a few members of the family, because their belief is that it goes through a gender transmission,

¹ *German Magical Folklore*, published in Issue 15 of *The Stone*, in March 1996.

from opposite sex to opposite sex. It kind of limited it, also according to interest -- not everyone is interested in it. I wanted to see if other people or other traditions existed and did similar things, and as I found out a lot of the general beliefs and ideas, as well as some of the particular practices were identical with other folks' experience in some of the German communities of South East Pennsylvania.

RH: *Your great uncle was a member of A.M.O.R.C.*¹

MS: He joined A.M.O.R.C. back in 1927 and was a member of several other Rosicrucian bodies, as well as the SRIA² and even The Brotherhood of Light, in California. But A.M.O.R.C. was what really shaped his beliefs and practices for the rest of his life from that point on and as a result of having grown up next to him, that is physically as neighbors, A.M.O.R.C. has influenced a lot of my beliefs from middle teens onward. It influenced my viewpoint of what practical mysticism or esotericism was.

Along those lines, it is interesting to read the old Rosicrucian monographs from that time. He got them sometimes just after they were written, and some of those lectures are very different from what members receive today, and at the same time there are some which are identical. It is just interesting to see those old lectures, the wording, the language and letters from Harvey Lewis³ to him, regarding his practices and work with the exercises and experiments, and it is really a kind of link with the past, a very direct link in that way. It is interesting for those who have some sort of psychometric ability to hold that kind of relic.

RH: *A lot of your articles and a lot of our conversations have been influenced by, or revolved around different historical occult movements. Are there other affiliations, or authors and ideas besides A.M.O.R.C. which were influential for you?*

MS: Of course, with A.M.O.R.C. there was T.M.O.⁴ which is a sister order that exists only because of A.M.O.R.C.'s support. Unfortunately, for political reasons, that is, Martinist political reasons, it is not recognized

¹ The Ancient and Mystical Order Rosae Crucis, based in San Jose, California.

² The Societas Rosicruciana in Anglia, a quasi-Masonic organization which served as a nucleus for the formation of the Hermetic Order of the Golden Dawn.

³ Harvey Spencer Lewis (1883-1939) was the first Imperator of A.M.O.R.C.

⁴ The Traditional Martinist Order.

in Europe as legitimate, although personally I think that it probably has more claim to legitimacy than several current Martinist groups in existence, only because its attitude is broader and more tolerant. So that is what got me interested in late 19th Century French occultism, and as I took that route, I delved more into the characters and personalities, the people and beliefs of that period.

Now, of course, the Golden Dawn⁵ was a big part because that is what most people come across in the search for usable information on anything ceremonial, and most of what is in existence is either directly a part of the Golden Dawn or a spin off from it. So, kind of a melding of those two beliefs, that is the magical ideas of the Golden Dawn with the more mystical theurgic ideas of Martinism has also shaped my beliefs. It seems that this is why I also feel very comfortable with the Qabalistic approach of the PON, because at least from my perspective in PON I see the blending of those two ideas.

RH: *The author of the PON courses, Jean Dubuis, was also involved with A.M.O.R.C., The Traditional Martinist Order, and other Martinist Order lineages, as well as having studied the Golden Dawn methods, Mathers' works⁶, and the Sepher Yetzirah.*

MS: I had this conversation with someone last night who is involved with quite a few of these French orders, as well as the Elus Cohen,⁷ and he and I agreed, almost simultaneously stating that the PON material on Qabala although very heavily Golden Dawn influenced is really ingenious in the way that it approaches Qabala, the way it deals with it and the way that it uses Qabala not as magic per se, that so many people are familiar with, but it uses it as a means of ever expanding the awareness of Cosmic Consciousness. So within it you have that which is theurgy, the magical manipulation of powers and symbols, and the mystical surrender in the goal of Cosmic Consciousness united into one. While it has some lumps and bumps that will be smoothed out over time, the system that is presented is

⁵ The Hermetic Order of the Golden Dawn, founded in England in 1888.

⁶ S. L. MacGregor Mathers was a prominent and influential member of the Golden Dawn.

⁷ The Elus Cohen, or Elect Priests, are a theurgic order which was founded by Martines Pasquales in 1755 in Bordeaux, France. Louis-Claude Saint-Martin and Jean-Baptiste Willermoz were among the disciples of Pasquales.

really unique despite its heavy reliance on Golden Dawn material.

RH: You have touched just now on the mystical approach versus the occult approach and how they might come together. Do you see your own practice as being more mystical or more occult?

MS: I would say that it definitely is more mystical, because the idea of integration, of return, of the ever expanding awareness of Cosmic Consciousness is in the forefront. While I may lapse from that from time to time in terms of personal experimentation or a more practical need, that is what I ultimately seek and that is what I ultimately use the rituals (or lack thereof) for. You have to remember that as far as magic goes – this was brought up at the conference I recently attended in Italy – magic, at least from the Golden Dawn, and even the Crowley¹ perspective, really has only two functions. One is personal development, and the other is very practical, pragmatic need – that is doing something in the material world. It's interesting that we have to try and balance those two. The occultist is often painted as someone who puts too much emphasis on the pragmatic where magic is a tool to an end, and yet we have to be careful that we're not overly mystical and lose touch with our material reality as well. The two are flip sides of the same coin and we have to keep that ever in mind.

I would like to say that I am a theurgist, someone who tries to blend the two together, as best I can, but if you had me pick, I'd say that I am more of a mystic.

RH: This past August when we visited in your home, we talked a bit about some of your work, with a direction toward the community that you live in. Is that something that you are comfortable speaking about?

MS: Sure. One of the things that I have always had trouble with, and I'm why I'm really glad that the PON exists, and this is covered in an article that I am working on, is that alchemists, to point the finger at them, are really their own worst enemy. You see the same with mystics and occultists, and esotericists as well. There is always this hiding, hiding and hiding. And very often people use that kind of secrecy or continual reference to the veiled initia-

tion as a means of hiding what they don't know, as opposed to using it to protect what they do. I don't think we have to be too careful about protecting it – not at this point in the game, not at this point in history where we are.

I firmly believe that we are at a key time in history, in which those occultists who feel comfortable with themselves and what they do have an obligation to share their knowledge with others when it is appropriate, when that time comes. And it could be in way that I had to do, that I felt somewhat forced to do this Summer, which was to come to the defense of the tradition. That was when Occultism was being seriously maligned in the press, unjustly and inaccurately. I felt obliged to set forth and say "this is not true, what you are saying is wrong", and then to say why it was wrong and give evidence for that.

I think that we need to do that. We hide too much. In a sense, we surrender our culture to the mouths that are loudest, and those mouths right now happen to be some form of bizarre political correctness on one hand, and another form of extreme conservatism on the other. That's kind of like being caught between the French revolution and the Spanish Inquisition. We have to come forward and defend what is right and true when called upon. That can be difficult. That is part of what I call community education.

RH: Haven't you had some opportunity to be involved in education for community servants regarding occultism, magical practice and related things?

MS: Yes. I am being considered by the State Training Board for the State of Pennsylvania as one of their consultant trainers for all things having to do with alternative religions, because their concern is where does occultism or alternative religions become something which we have to observe as possible avenues for criminal activity. As many people know, criminals use anything to cover their tracks, sometimes occultism is used as a means of manipulation.

My job would be to explain to law enforcement and mental health professionals, the difference between something which is different, and something which is criminal. That can be a fine line. Fortunately, we have a Constitution to help us.

RH: How do you see the ORA Research group progressing? It just beginning, and in its infancy, but you have

¹ Aleister Crowley (1875-1947) was an influential, if notorious, author and adventurer who published extensively on magick. Initiated into the Golden Dawn in 1898, he was later a member of the Ordo Templi Orientis (O.T.O.).

already set forth some objectives. Where do you see it going, and what would you like to see?

MS: We have several people who have expressed an interest in participating in the experiments. The experiments will be finalized sometime before the Seminar in Colorado Springs in July, and probably already in the hands of those wishing to participate. We have several levels of experiments, some of which are very long term, because the experiment itself is very ambitious in terms of what it is intended to achieve. That will take time. We have others which are much shorter, and can be done in several weeks or several months, in twelve to thirteen weeks.

So there are opportunities available to anyone who wants to participate. But if people do decide to participate or experiment, they should remember that it is an experiment, and will possibly require that you set aside some of other esoteric activities for a period of 8 to 15 weeks, and really dedicate yourself to daily participation in the project that is outlined.

I hope that the ORA projects will expand on the base of knowledge that PON has available to it, not so much in adding new things, but in finding new ways of applying what we already have. To paraphrase Einstein: "We don't need to think more, we just need to think differently", finding different ways of using what we already have, flexing different muscles in different ways. That is what I hope for it to do, as well as for us to produce some literature, through The Stone, or through monographs, or lectures, that are unique and interesting contributions. I don't see ORA as being something that is going to produce a massive amount of material, what I see is something that is going to produce good and useful material.

RH: *How do you see your lectures or workshops at the PON Seminar in July 1997 relating to daily life and practice for people, and what will be the nature of the topics covered?*

MS: One of the topics will I definitely will be talking about is for the paper that is going to be published in The Stone and possibly in other publications as well, is on the

various pathologies that can take place when people undertake Qabalistic or Alchemical research.¹

What we tend to forget is that in most forms of esoteric activity, about 80% or 90% of it is really psychotherapy. People don't always want to do the psychotherapy work, they want to skip around that and go straight to the spiritual part because that is a lot easier. When we undertake the Path of Return, the path of healing, of making whole, which is what therapy is about, we need to realize that we have to look at parts of ourselves that are not always very pretty. There are practical things that we can do with that area, that we can recognize, and the Tree of Life, and path working in particular shows us what those pathologies very well may be, and when they occur on the path, that is one the stages of development.

"[At the seminar]...we are going to be doing some things on practical ceremony and practical ritual, how to use it on a day to day basis, and why it is important, why you need to do it. Just basics in how to draw the sigils, how to draw the pentagrams, how to intone the divine names properly, what it means to vibrate the names, how to proceed on the Elemental work..."

We are going to look at how to use the Tree of Life, in the work of integration, what are the benefits of the doing the path, and also point out "OK, there is a sharp curve up ahead – this is what it may bring out in your personality as well, be aware of this, and here us how you might deal with it". I think that's very practical and very important today because too many people get engaged in

esoteric work thinking it can fix all of their problems, when in reality it's going to bring a lot of them to the surface. And, that's all right, as long as you are willing to deal with them.

The other topics haven't been solidified yet, but we are going to be doing some things on practical ceremony and practical ritual, how to use it on a day to day basis, and why it is important, why you need to do it. Just basics in how to draw the sigils, how to draw the pentagrams, how to intone the divine names properly, what it means to vibrate the names, how to proceed on the Elemental work, that is work with Air, Earth, Fire and Water, Spirit or Akasha, because it is very important to work on those things before you jump into planetary work, which work you must do before you do Zodiacal work. It is a nice, and progressive system, but sometimes we jump too fast, try to jump away from the Earth and it gets us into trouble.

¹ The article immediately follows this interview.

RH: *I seem to recall very much the same caution in the Cicero's book, Self-Initiation into the Golden Dawn Tradition,¹ that there must be a mastery over the elemental works before the planetary and zodiacal. It does seem that it is very necessary to have people point out the curves, when there is all of this wealth of information laid out on the table today. That was not the case 75 or 80 years ago.*

MS: You can only point out the curves, as you say, when you have experienced them yourself, or you have experienced enough of them that you can look far enough up the road to see what's there, as well as read the map, that is what is nice about the Tree. The Tree is a very effective map, and when you learn how to read it you learn how to figure those things out.

We tend to put too much emphasis in the popular world, and in the New Age world, about Qabala and Alchemy being just psychotherapy. We see this with a lot of Jungians. As a result of this, because of that lack of emphasis on the more practical aspects that PON approaches in terms of the laboratory work, people said "Enough of this. I know there is laboratory work there, I know there is a technique there, and I don't just want just the psychotherapy anymore". I think that people have now gone in the other direction, so those of us who are doing laboratory work, or those of us beginning laboratory work or ritual work need to look at these missing symbols and find that balance.

RH: *Up until now we have not spoken about your involvement in spagyrics and alchemy. Would you care to speak on that?*

MS: As I mentioned to you, my whole thing with Spagyrics came about really because of you. You were famous for your classes out in San Jose (at A.M.O.R.C.'s Rose-Croix University), with Jack Glass, and I always wanted to attend them. I even signed up one year, and my arrange-

ments fell through by a peculiar set of circumstances. That same year, you also were not teaching, so I was glad in the end, because I would have gone out there to be disappointed, to take a class on what I found out was just some form of herbalism instead of genuine plant alchemy.

When I saw the ad for The Philosophers of Nature seminar, I thought, these things are great but I don't know any of these guys, like this Jean Dubuis fellow, but I do know Russell House and I do know Jack Glass, so I went out to Chicago for the 3rd Annual PON Conference at the Wild Rose Camp, and went to your classes and that is what got me started.²

Also my experience with Dubuis, and interviewing him and watching him lecture. He had hit on Qabalistic ideas that I knew well but to me they were just theoretical at that point, I was simply playing around with them, and I thought might be real, I'm just myself, I had no one else to discuss this kind of conceptual framework with. That's what sold me on the Philosophers of Nature, and what got me into Spagyrics. My approach has been to treat Alchemy as an extension of Qabala, because that is my original framework. I am always trying to see where they

interrelate and overlap, and I see a strong resemblance between much of the early plant work, because that is all I have done so far although I am theoretically familiar with what is done in the metallic work, is the strong relation between it and talismanic magic.

RH: *I think that this area, the relationship between talismanic magic and Alchemical or Spagyric work, is something that is hinted at, and some keys given, through the PON courses, and Jean's lectures in particular. I think that it is a very rich area and that it offers the way for the person for whom Spagyrics is the framework to incorporate Qabalistic concepts and practices to enrich*

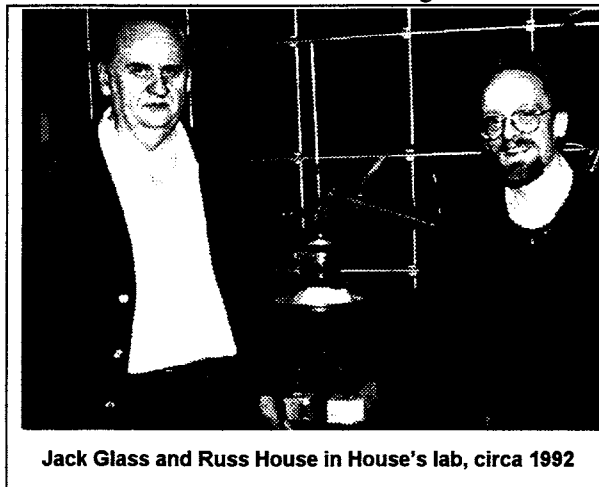

Jack Glass and Russ House in House's lab, circa 1992

¹ By Chic Cicero and Sandra Tabatha Cicero, published by Llewellyn Publications, St. Paul, MN.

² This seminar was videotaped and was offered by the PON as *Introduction to Spagyrics & Alchemy*. While temporarily discontinued, it should be available by May, 1997.

it, just as you found a Spagyric practice can enrich a Qabalistic path. Certainly, they seem to coincide.

MS: This is going back to what I said about pathology, and you can say more about this than I can, but my guess is that a lot of people get into Spagyrics and rush through it because they want to get to the 'real thing', they want to get to the metals. In rushing through it they don't learn a lot of the basic ideas that can only be experienced over time, internally, by handling the materials, by experiencing the heat, by experiencing the cold, by experiencing the cycles of the moon, and the effects of the medicines upon themselves psychically. In rushing through it, they cheat themselves, and then they get to the metal work and they are ill prepared and they just have frustration until they psychically, internally catch up.

The same is true with Qabala. I know because I did it as well in some areas. There is this rush through the elemental work, and then you find that you haven't built a foundation that can sustain the psychic pressure of spheres above the Sun (Tiphereth) to use a metaphor. We want to contact Mars and Jupiter and Saturn, and this weight is so heavy, this psychic pressure is so intense, and yet we have no foundation for it to rest on. We need, in a sense, a four-story sub floor or sub-basement for the apartment building, and all we have poured is a concrete slab for ourselves psychically. I think for those people who have some experience in that, who realize that there is a need to go slow, but they don't want to completely abandon their Qabalistic work, that there is a cross over, in the areas where the internal manipulation of energies that they have learned Qabalistically can be applied for the plant work. As you have said, alcohol, responds very powerfully to psychic influences. I have seen that myself.

Many people get into plant work and don't want to dump \$500 or \$1000 into glassware before they start doing everything. They need to have some experiences and I think that by drawing the parallels between talismanic magic and Spagyry for folks who are just beginning that it will allow them to have those positive experiences – "Hey,

this works, I like it, it's the direction I want to go", before they drop a lot of money into labware that they may never use, or just get frustrated if they just don't understand it. It serves two purposes: it helps people to have experiences and know they want to go further, and it helps them to use what they already know.

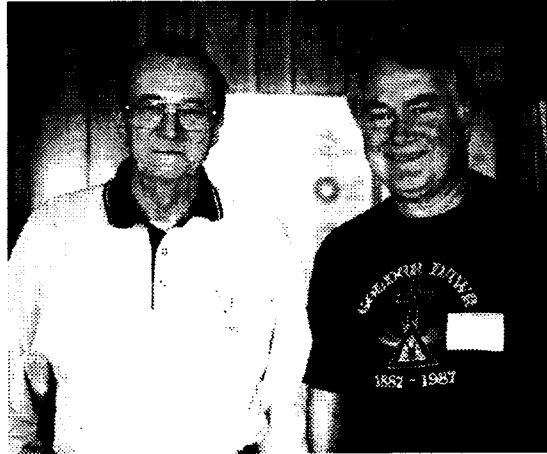

Jean Dubuis and Hans Nintzel, Winfield, IL, 1993

RH: *You were in Colorado in May 1996 for the Portae Lucis presentation by Jean Dubuis. I have a sense that what was given in this lecture, and in more detail in Illinois in October 1996, offers a sketchy framework that can allow someone to integrate Spagyrics with elemental and planetary work. I think it is not unfair to call it a path of talismanic magic. Do you think that this path offers a good way to explore some of these things?*

MS: Based on the Colorado conference, I was very impressed with how he tied in the use of Spagyrics. It was definitely present. He was saying for the Saturn contact to use a tea of horsetail. A tea is fine, however those of us who have a stone or a tincture, or some other kind of medicine which we have prepared may just as easily substitute that. We must charge or load the product with the elements of Earth, Water, Air and Fire, in many ways identical to the procedure given by Franz Bardon in his work Initiation Into Hermetics.

Many have this reference on their shelves and may not know its use -- how to load a tea, tincture or elixir with the elements. I have been doing that with crystals and stones, and there will be a report of this available through the ORA project on these experiences. In those, we are going back to the elemental work, and learning how to direct psychically that quality and load something with it and layer it, not just one element, but all four, and then power spirit or Akasha, on top of it, and to tincture it with an aspect of a planet. I think that people forget, or don't even know, that each of the planets contain all of the elements just as the Earth does. Except, what we do in talismanic magic, is give it a coloration of the planet that we pull in.

So, Dubuis was telling us how to do that with a tea, as well as with the mineral or metallic product, the gold or the

diamond chip, or even with a piece of marble or stone for the Earth. It is very practical, incredibly practical. Once again, the procedure he laid out was so fantastically simple that it was scary, because I know it works. I think that many alchemists and Qabalists who are really into Hod, and this is part of the pathology, forget that it is a dead path. It is not an active path, and they can get so caught up in these ideas, and details, and details, and machinations, configurations and manipulations like using gematria and notarikon. That they forget that the real power comes either from going straight up from the Moon to the Sun, or by going over from Netzach to the Sun.

Dubuis gave us a straight path in the Portae Lucis material – straight up like an arrow. So I am looking forward to having more experiences with that. I am also a little apprehensive (laughs).

RH: I know that there are a number of articles that you are working on, and a book as well. What can we look forward to seeing in print soon?

MS: In the Winter of 1998, I will have two chapters in Book VI of The Golden Dawn Journal by Chic and Tabatha Cicero, published by Llewellyn. The feature topic is Alchemy. One is on the history of Alchemy in the United States, the past 300 years, and another on my experiences with plant alchemy and how it relates to talismanic magic with lots of hints and pointers for people who want to give that a try.

I also have several articles, thanks to your extensive input, which are going to be appearing in Ariadne's Web, on plant alchemy as a three-part series. I also expect, though it is not yet confirmed, to have two articles published in Venture Inward (a publication of the A.R.E.¹), one on Hermetic Qabala, and another on Alchemy.

As far as the book goes, the first draft is almost completed, and perhaps something will be said on it at the conference. I am really pleased with the material and thankful for everyone who has helped out and I expect some more help between now and its final correction. It goes over what was talked about here, that is the relationship between plant alchemy and talismanic magic.

¹ The Association for Research and Enlightenment, the Edgar Cayce Foundation.

You asked earlier about history. I think that history is important, and a big section of the book is dedicated to the history of Alchemy because I think we overlook that. Only by going back to the past do we see where things are similar and different. We had a great lecture in May on Renaissance Magic (by Kenneth Miller), and how that is different from our modern view of magic.

When you look at Alchemy as well, whether it be Chinese or Indian or Islamic, their words and the way they view things affect their outcome – their perspective affects their outcome. That is reflected in their language. I think it is important for us to try as best we can to see things from their point of view when we read that material. It is like when you are looking at an alchemical manuscript or a Qabalistic diagram – try and see it if you can through the eyes of the person who has made it, try and see it through their perspective. It can be a difficult thing, but I think we get more insight that way. A little closer to the truth.

RH: I appreciate the time you have given for the interview and the many efforts you have made on behalf of the PON. Do you have any final comments?

MS: It has been a pleasure and joy being involved with the Philosophers of Nature. PON has been very good to me personally, in terms of my own inner development, and in terms of the friends I have made. It is a real joy to be able to work with people who while they are free thinkers, and that has its problems, are so willing to get into it with you, and mix it up with you about ideas and practices and beliefs. The discussions are good, the lectures are good, and the internal experiences that I have taken from that have been very good.

I am glad that I can share that with other people, and hopefully bring them into the fold if they would like to have those same kinds of experiences, if that is the path for them. So, thank you. ⊕

Articles by Mark Stavish published in earlier issues of The Stone:

- “Kabbalah and the Hermetic Tradition” – Issue 12, March 1995.
- “The Sign of the Cross” – Issue 14, November 1995.
- “Pow-Wow, Psalms, and German Magical Folklore” – Issue 15, March 1996.

Problems on the Path of Return: Pathology in Kabbalistic and Alchemical Practices

by Mark Stavish, M.A.
Copyright 1997 Mark Stavish

Mark Stavish, M.A. holds degrees in Theology, and Counseling, and has been studying and practicing esotericism for over twenty years. He is the current Director of ORA, the Occult Research and Application Project of The Philosophers of Nature, and his writings have appeared in numerous occult, New Age, and magical publications. The author welcomes responses, comments, or criticisms, of this article, as it is a "work in progress". Personal experiences are most welcome.

Individuals who would like to participate in research projects involving alchemical, kabbalistic, or hermetic orientations may contact the author at: P.O. Box 2920, Wilkes-Barre, Pennsylvania, 18702. Research results will be published in The Stone, and be made available to all participants.

Soul Ladder

"To the left of the house of Hades under a graceful white cypress a well offers spring water. Don't drink there. Find the well by the lake of memory. Guardians protect the cold water. Tell them:...." - The Hymns of Orpheus

Psychological Effects of Pathworking

The effects of pathworking are to a greater or lesser degree well documented. Once the basic concepts of what each sphere represents in terms of psychological elements on the Tree of Life are understood, then the links which they form are realized either through ritual, mythological metaphor, meditation, or a combination of the above. However, in the rush to realize magical powers, altered states of awareness, celestial beings, and interior worlds, one of the most significant and important facts of pathworking and all magical work in general is often overlooked.

The majority of all so-called magical, mystical, alchemical, or esoteric work, as much as 90% of it, is nothing more than glorified psychotherapy.

In fact, few people stay with any system long enough to realize the genuinely spiritual aspects of the Work they are doing. The need for genuine self-honesty and purification on the level of the ego and the repressed areas of the subconscious, before the refined and powerful forces of the soul can shine freely and effectively through the ego and not be overly distorted by it, must be recognized by stu-

dents if they are to derive full benefit from the Work they are doing.

To this end, the following examples of kabbalistic pathworking are being given, as well as possible psychological benefits as well as pathologies which their working (particularly out of sequence) can evoke within the psyche of the operator. While no single path is ever worked exclusively, only realized as such by our outer self (i.e. ego), the effects are seen predominantly when particular paths are undertaken as ritual or esoteric operations. The paths are numbered in a working sequence for a reason, it is best to follow that sequence if disharmony and psychic disruption is to be held to a minimum. Each of us carries within us the seeds for healthy and unhealthy uses of the forces we are made from and contain. Whenever we approach a particular sphere or spheres, we also approach their reflection in the *qliphoth*, as the *qliphoth* is nothing more than imbalanced force or an excess of a particular virtue, so much that it becomes a vice.

Dr. Israel Regardie¹ stated that it is important for the would-be magus to undertake psychological counseling prior to, or as an adjunct with, esoteric training. Unfortunately, this is rarely done, and few psychotherapists are qualified to undertake the dual task of mental health clinician *and* initiator. The reverse is also true of many would-be initiators and their qualifications, or lack thereof, to be a valuable psychotherapist. A true psycho-therapist, or healer of the soul, is as rare as a genuine *psycho-pomp*, or guide of the soul. This abyss is made even larger by the failure of esoteric movements to place enough emphasis on personal growth, and the therapeutic community's failure to even attempt to understand the experiential significance of ritual and the possible legitimacy of *esoteric* practices.

While many therapists and esotericists are familiar with the writings of Carl Jung and have applied them in some form to their respective work, the realm of therapy that is most important to esoteric students during practical alchemical and ritual work is more closely akin to Freud than Jung. Depth psychology is often overlooked in the rush to the mountaintop, and Jung has been gutted by many of his would be advocates of his psychoanalytical content. Yet

¹ *The Middle Pillar*, Israel Regardie, Llewellyn Publications, St. Paul, MN, 1991. See also, "Israel Regardie, The Golden Dawn and Psychotherapy" by Chris Monnastre and David Griffin, *Gnosis*, No. 37, Fall 1995.

even both of these systems combined will only give a glimpse into the interior worlds, as they lack effective techniques for the kind of initiation that most esotericists seek.

The works of the Italian Renaissance hermeticist Marsilio Ficino are of immense value, in that they bridge the gap between psychology and magic to a great degree. Unfortunately, they can be difficult to obtain, and deal with a style of kabbalah stylistically different from the more famous modern schools, such as the Hermetic Order of the Golden Dawn and its off-shoots. Some of Ficino's insights will be considered as well.¹

Despite this lack of effective interface between the parent art and science of occultism and its insolent step-child psychology, some inroads have been made to bridge the gap both in terms of technique and theoretical understanding. The most effective to date being Psychosynthesis, as outlined by Roberto Assagioli, Piero Ferrucci, and Jean Hardy. Peter Roche de Coppens, Ph.D. (The Nature and Use of Ritual for Spiritual Attainment, 1985; The Invisible Temple, 1987) has begun an effective synthesis and comparison of the effects of basic kabbalistic work and its relationship to *Psychosynthesis*, however, a look at the effects of Pathworking as explained in any psychological framework or school appears to be lacking.

Psychosynthesis

"I am a child of the earth and of starry heaven, but my race is of heaven." The Hymns of Orpheus, cont'd.

The fundamental premise behind *Psychosynthesis* is that we must first construct, purify, and then surrender our sense of self (ego) if we are to realize our spiritual nature as expressed in transpersonal and humanistic psychology. We possess within us several overlapping and interpenetrating fields of awareness.

One of these fields represents our repression, feelings of fear and guilt, libidinal (sexual-psychic-creative) drives, and other forces that risk bringing chaos into our world, as well as power, if directed and controlled. This is our *lower unconscious* (Yesod and Elemental forces).

We also possess a field of *middle unconscious* (traditional subconscious) into which we have our imaginative facilities, memory, and ready access information needed for daily life (Chesed -Yesod).

A *higher unconscious*, or *superconscious* (Keter), which is the transpersonal or genuinely untainted spiritual aspect of our awareness.

And a middle area of awareness around which all of this stuff revolves, or sense of self the "I". Outside of it exists the *collective unconscious* (Binah-Hockmah) of our clan, tribe, nation, world, and all of creation.

Then there is the Self, or *Higher Self* (Tiphareth), which we seek to express in and through the little self, and in the functions of the various levels of our unconsciousness. These levels are designated as unconscious for the obvious reason that they exist and function within our psyche regardless of whether we are aware of them or not. We only become conscious of the effect they have in our lives when we seek to break through the layers of external conditioning that have been used as reference points for our sense of being.

This movement from psycho-spiritual sleep to wakefulness is the Work of the initiate. The results of its successful completion, or at least working completion, can be seen in the expression of a powerful, harmonious, intuitive, and creative personality that is generally unaffected by the petty, worldly entrapments that seek to draw us away from the powerful resources of our central Self.

As the self (created by the world and our response to it) is progressively undone and reconstructed so that it may identify to greater degrees of efficiency with the Self, conflicts arise and are resolved. When Self and self become, even if momentarily a functioning conscious unit, then the opportunity for even greater influx of Light, Life, and Love come through turning our attention to the realms of the superconscious (Keter). This however, would constitute the Work of the Paths above Tiphareth, and the 13th Path in particular, as part of the Middle Pillar exercise.

¹ The Planets Within – The Astrological Psychology of Marsilio Ficino, by Thomas Moore, Lindisfarne Press, Hudson, NY, 1990.

How one makes these attempts at parallels between the Tree of Life and psychological models such as presented by *Psychosynthesis* is somewhat arbitrary. Exact matches across the board rarely occur. Function is what designates similarity, and function in Kabbalah is often a matter of perspective more than anything else. Several models exist for placing the Worlds on the Tree as well as their psycho-spiritual functions. The models put forth by Z'ev ben Shimon Halevi are quite different from the generally accepted Golden Dawn models of the psyche. However, since it is these models, derived from interpretations of late 19th and early 20th century British occultism that most students are familiar with, it is their designations of the Worlds and Spherotic function that will be applied.

In Hardy's work, *A Psychology with a Soul*, these areas of consciousness are examined in light of the traditional hermetic methods and kabbalah. Ferucci in *What We May Be* takes his mentor, Assigoli's thesis, and explains consciousness in laymen's terms, devoting substantial material to the pathologies that can arise in psycho-spiritual work.

"Pathology of the Sublime"

"This you know. I am parched and perishing." - The Hymns of Orpheus, cont'd.

"Whoever acts like an angel makes a devil of himself" - Pascal.

While the four major existential fears of annihilation and death, responsibility and freedom, aloneness, and meaning, (*Existential Psychotherapy*, Yalom) are the fears most deeply rooted in the ego (Assiah/Malkooth) and can be said to be a result of the transient nature of the Elements from which it is created, these conflicts are not the result of internal instinctual strivings, or of encounters with our internalized images of significant adult authority figures during the infantile stage of our development (as in Freudian work), but with inescapable givens of our existence in this world (Yalom, p. 8.) The pathological responses to psycho-spiritual work, that is work that seeks to reshape and reform the outer for the exposure and glorification of the Inner, is more deeply rooted in our interior impulse of

involution, the very force and cause of our 'descent' from potential being into creation so that we might ascend and become an actualized Being.

In *What We May Be*, Ferucci describes seven basic forms of spiritual pathology, or psychological dysfunction which may occur during periods of psychological integration and awakening of consciousness to spiritual realities. While it would be easy to suggest that each of the following forms of dysfunctional response to the awakening process can be assigned to either a planetary or sepherotic function, in truth, they may occur at any time, and more likely have

their occurrences during the Paths more than the Spheres.

The pathologies most often encountered are: repression, projection, compensation, desacralization, defensive pessimism, routinization, and dogmatization. (Ferucci, p. 155-162)

Ferucci states that *repression* of the sublime is the most common defense mechanism of the ego and is often the

cause for deep melancholy, a subject treated at length by Ficino. It results in our feelings of loss, dissatisfaction, boredom, and feelings of inauthenticity. (Binah/Saturn)

Projection results when we encounter the divine, accept it as real, but refuse to make it a part of ourselves, and instead, see it as a manifestation of another person, place, or thing. This is the belief in a savior without having to do any work on ourselves, or guru worship in some form. However, it also includes the obsession with 'spiritual technologies' such as aura meters, 'energy field enhancers', crystals, or the mythological idealization of native or indigenous religious forms. Messianic projections either in the form of a returning Christ, a new avatar, or extra-terrestrials also fall into this category of pathology when they take the place of psycho-spiritual development instead of supporting it. This form of spiritual laziness is accompanied by feelings of self-doubt, anger, frustration, and low self-esteem, as we do not feel capable of being the qualities idealized and instead see them only as possessed by another, resulting in anger at our own unworthiness. (Yesod/Luna)

"Projection results when we encounter the divine, accept it as real, but refuse to make it a part of ourselves, and instead, see it as a manifestation of another person, place, or thing. This is the belief in a savior without having to do any work on ourselves, or guru worship in some form."

Compensation is the embracing of views, ideals, or activities opposite of those sought and experienced in the transpersonal and spiritual realms. Love results in anger, lofty experiences in base living, or similar forms of embracing the opposite of what we seek. (Netzach/Venus)

Desacralization is the destruction and minimizing of anything that is representative of the superconscious or spiritual. (Hod/Mercury)

Defensive pessimism is seen in individuals who see their problems as insurmountable. They are easily discouraged and indulge in self-pity, resulting in resentment and stifled self-expression. To some degree, Millennialism, Apocalypticism, or obsessions with "Earth Changes" or persecution for believing in a non-traditional form of worship fall into this category. (Tiphareth/Sun)

Routinization manifests when the superconscious is formally accepted, but is so organized that the creative element is stripped from it. Slogans, empty rituals, and other trademarks of partial understanding are seen here. Concrete truths from the past are held in preference for spontaneous and creative experiencing of the truths themselves in the present in the consciousness of the individual. This is a particularly dangerous pathology that tends to strike organizations and groups focused around a single leader. (Chesed/Jupiter)

Dogmatization is the opposite of *routinization*, in which spiritual realities are affirmed so strongly that it becomes a duty that must be done for others, humanity, the environment, but never for one's self. The idea of growth becomes simply another goal on a long list of goals, and the genuine joy it offers is lost in its metamorphosis into duty. (Geburah/Mars)

It may seem strange that someone who has entered onto a spiritual path, or at least one of self discovery should seek to avoid the very thing they are seeking. However, the human ego is a strange and complex creature, and like any living organism, often fights change. As new energy and expanded awareness is experienced and increasingly rooted to daily life, the ego and all that it has built up begins to feel threatened. The new ways of living, feeling, praying, loving, and being are so different, even if in reality they are only minor initiations so to speak, from the ego's perspective, they might as well be an intrapsychic coup d'état!

However, as Ferrucci states, journeys into the Inner Worlds are not without their own dangers, even into the higher ones.

"Intense spiritual stimulation may bring inspirations, but it may also penetrate directly into the lower unconscious, where it throws light on and excites demons, instinctual energies, forgotten memories, and so on. These then tend to rise to consciousness, causing all sorts of trouble to the surprised conscious personality. When the demons are thus aroused, the contrast between different sides of our nature is felt with particular intensity." (p. 160)

He also points out that intense *mental stimulation* from transpersonal contacts may result in insomnia, as well as delusions of knowing the answers to everything, often through complex associations and correspondences. *Abstraction*, a pathology most common to the mystical, can result in a rejection of the physical world, and an inability to integrate spiritual experiences into mundane life. Emotionally, *hypersensitivity* may result in an over identification and sympathy with the world's pain. The peaks and depths of human experience can become difficult to bear if not recognized as being part of humanities cycles of evolution. Hypersensitivity can also result in the belief of having 'found it' and being insensitive to the needs of others to find 'it' on their own. Feelings of *inadequacy* and *suicidal tendencies* can also result for some from superconscious contacts. This is the result of our not realizing that we are a part of those things we experience, and not separate observers or bystanders. Some can even *burn out*, or 'bliss out' from rushing in too quickly for superconscious experiences. (Ferrucci, p. 158-161)

This is not meant to detract from the genuinely 'magical' results that can occur from esoteric exercises, but instead to show that true spiritual development can only occur in a conscious complex where psychological health exists. Until the vehicle is made ready, everything is just 'house cleaning'.

Pathworking and Fairy Tales

"Give me cold water from the lake of memory." -*Hymns of Orpheus, cont'd.*

The relationship between esoteric Pathworking and childhood fairy tales is well established. However, in our quest for individuation, self-reliance, and separation from our

parents, social rules, and religious-sexual taboos and restrictions, we abandon our childhood means of development for a more active one in the material world of experience. To guide us in picking our experiences, we leave behind our old fairy tales and chose new ones, be they the modern mythologies of *Star Wars* and *Star Trek*, or soap operas of a different sort, such the long running shows of *Dallas*, *M.A.S.H.*, or similar movies or musical themes. While most entertainment offers little genuine entertainment value and is mostly designed for the absorption of our life force and time, all forms of story telling offer a moral lesson and cosmological view whether we recognize it or not.

The view of the universe offered in *Star Trek* is slightly different than *Star Wars* in that it has yet to answer certain existential questions and address the spiritual question sufficiently. *Star Wars* on the other hand from the beginning offered us 'the Force' and introduced two generations to the ideas of spiritual warriorship, our personal and collective Shadow (Dark Side), redemption, and the unity of creation as an experiential reality, and not just an abstraction of quantum physics. The same is seen, or heard, in the endless tails of suffering, failure, alcoholism, and neediness in country and western music, or the unrequited love in jazz and blues, turning towards drugs and alcohol as a result. Rap and heavy metal offer their own metaphors, cosmologies, and world views as well.

In short, all that we watch, listen to, and participate in has the potential be a pathworking on some level. However, what separates such randomness and potentially harmful psychic exchanges, is that kabbalistic Pathworking is organized, progressive, and ultimately transpersonally oriented.

The words of child psychologist Bruno Bettelheim (*The Uses of Enchantment*) are applicable here:

"Each fairy tale is a magic mirror which reflects some aspects of our inner world, and one of the steps required by our evolution from immaturity to maturity. For those who immerse themselves in what the fairy tale has to communicate, it becomes a deep, quiet pool which at first seems to reflect only our own image; but behind it we soon discover the inner turmoils of our soul - its depth, and ways to gain peace within ourselves and with the world, which is the reward of our struggles."

Initiation

"Initiation essentially aims to go beyond the possibilities of the individual human state, to make possible the transition to higher states and finally to lead the individual beyond any limitations whatsoever." Rene Guenon, Aspercus sur l'initiation (Glimpses of Initiation)

The function of these esoteric, or psycho-spiritual exercises, is to make us aware of a broader sense of what we are, and what we may become if we so desire it. They are to assist us in fulfilling the Greek adage, "Know Thyself in order to know the universe and the gods!" In our 'becoming' the alchemists claim, we realize that we are in many ways self-created beings. Much of what we do, are, and experience, we are directly or indirectly responsible for, despite our cries to the contrary. We are as the golden adepts say, a 'son of his works'.

Until this century, the most common method of esoteric learning was either through a teacher-student relationship, or affiliation with an esoteric lodge. The principal means of instruction and initiation was often ritualistic, and would involve one or more persons who has experienced the ritual or its equivalent previously. The initiator, and/or initiatic team, would proceed to create a condition wherein the energies of the psyche would be awakened and brought to the surface of consciousness. However, for this to work effectively, it requires that those energies being awakened in the initiate already be alive and well in the psychic body-consciousness of the initiator. This is a critical point, and the failure of this condition being met, is the principle cause for esoteric initiations as a whole being of questionable value.

These sudden flashes of insight and alteration of consciousness can in some instances be called initiations, some being minor, and others more significant. Unfortunately, the concept of initiation in esoteric circles is filled with many misconceptions, and in psychology, it has no equivalent term or phrase, although several might be suggested.

The writings of Von Durckheim combine depth psychology, Christian mysticism, and Zen practices in such a fashion as to allow for the realization of one's interior life with Christ, a purpose in harmony with both *Psychosynthesis*, and traditional Western esoteric Pathworking. His writings are a significant contribution to this area, even though they use the language of orthodox Christianity, and are a valuable

tool for bridging this gap between psychology, mysticism, and even esotericism.

The Paths

"They will give you water from the sacred spring and you will live a lord among heroes." - *The Hymns of Orpheus, concluded.*

The '+' or '--' notation after each Path designates that Path as one which 'returns' energy to the initiate's consciousness (+) on the Path of Return up the Tree of Life, or does not (--). Those Paths which return power can be seen as more active and energetic in orientation, those which do not, more passive and reflective in design. In reality, each combination of psychological potentialities, or Pathworkings, returns something to the consciousness of the mind traveling them. *Returns* is not even the proper word, for such qualities have always existed in the soul, but only in *potential*. It is through the experiences of life incarnate, and the desire, the need, to make sense of it through psycho-spiritual philosophies, techniques, and initiations, that it becomes a reality, or *actualized in our consciousness*.

Those who have done esoteric work, particularly kabbalah, will find that in the beginning the Sphere and Paths are very rigid entities. However, as one works with them, and they become internalized, they become more fluid and interrelated on a level that cannot be expressed in words. It is these progressive interior experiences that allows one to experience levels of spiritual initiation.

We say that these initiations are part of *progressive interior experiences*.

This delineates the psychological, the mystical, the genuine transpersonal aspect of growth from the purely sensational. The experiences undertaken by students of kabbalah, alchemy, or *Psychosynthesis*, are *progressive*. That is they build on the previous experiences and have a direction or purpose. They are *interior* states, in that they are wholly personal, even if experienced in a group or in the presence of others. They may match the descriptions given by others in traditional writings, but are the 'property' of the one who experiences them. They are an internal response to the pleadings of the self for expansion and integration. They cannot be experienced for another, nor given to another, except by highly integrated individuals known as adepts. Even then, the gift is just the psychic equivalent of a 'jump

start' as one does to a dead or weak automobile battery on a cold day. They are also, as the word says, *experiences*, not thoughts, ideas, conjectures, or philosophical postulations, but experiences often of a profound and energetically charged nature.

The Paths are thirty-two in number, ten belonging to the Spheres and twenty-two to the connections between them. They are arranged in hierarchical order, ranging from the most dense (32) to the least dense (11). In the order given here, the names of the sepheroth have been substituted with their planetary equivalents for those who are unaware of traditional kabbalistic terminology.

32: Earth to Moon - uncontrolled psychic impressions, lack of discrimination or 'testing of the spirits', possible obsession or even possession (in the most extreme). Willingness to believe anything that comes over the psychic 'chat line'. (+)

31: Earth to Mercury - an abstraction of mentalism to the extreme. Too 'scientific or rational', and ignoring of the spiritual or even psychic (possibly as a rejection of its pathological aspects. From no discrimination to all discrimination. (--)

30: Moon to Mercury- Psycho-scientific babble. Lack of discrimination in areas of magical, occult, or alchemical information. Belief in extreme forms of conspiratorial thinking, a rational form of irrationalism. The more bizarre, the better, and more easily believed. A UFO goes from being as defined, an *Unidentified Flying Object*, to an identified alien space craft from beyond the solar system. Everything they read they believe, "National Inquirer" thinking, or even X-Files as hidden social history being disseminated for our indoctrination. (+)

29: Earth to Venus - Naturalism taken to the extreme with no logic or reason, purely emotive. This would be an example of the radical environmentalist who wants everyone to give up technology and live in a fictional harmony with nature. In its own way it is very materialistic and earth bound. A nature religion without a god. (--)

28: Moon to Venus - Psychic powers of a natural sort, i.e., highly sexual and primitive. An idealizing of the ancient ways and craft religions without a genuine historical context of their reality. Sexual magic gone haywire. Fairy

tale fantasies of a Golden Age of magic as an escape from the reality of modern civilization. Where as one escapes into technology in the 30th Path, here they escape from it into a false and idyllic view of the 'natural world'. (--)

27: Mercury to Venus - This path represents the balancing of the intellectual forms of the mind with the emotional creative forces of the mind through and act of will (symbolized by the planet Mars). This is a struggle for many who find that they prefer the playground of abstraction and theory to the reality of generative and creative power. It is an uphill swim, literally and figuratively, as it goes against the current of Mezla. When it is accomplished much power is returned to the initiate and the foundations of the fundamental task of psychological preparation has been completed This allows for much energy to flow into the work, but is still an energy of diffusion and stimulation. The flow of force can lead to an increased sense of complacency at having done what few have accomplished, and a fear of having to proceed further on the path to the Path of Death and surrender. This brings vibrant light to the astral world, and a power to exercise control over it. The sphere of illusion can reign hard at this point, as well as unresolved psychological issues that reject their coming death if further progress is made. As a result, the initiate may seek to escape up the Pillar of Severity or Mercy, thereby believing that they can avoid the inevitable. (+)

The lunar world of yetzirah is the astral world and has three fundamental aspects symbolized by the spheres of Hod (intellectual) Netzach (emotional) and psychic/imaginative (Yesod). When they are combined as an effective unit, the initiate can think, feel, intuit, and create on the astral level. This level or world can then be experienced in depth on several more levels symbolized by the remaining planets or spheres. When the initiate tires of this world, or receives an impulse to proceed, a greater degree of Solar forces will be felt. These impulses are from the mental world of Briah, and provide the impetus for the initiate to cross the threshold to higher realms of purer awareness.

When this World of Briah, the Solar world as it is called because it is dominated, or all things in it are perceived through the intuitive powers of the Sun (Tiphareth), the often confusing image-dominated realms of Yetzirah fall behind. This does not mean that they are forgotten, or even ignored. Quite the contrary! These foundation experiences are built upon, and even further strengthened by the purer,

more direct methods of experience provided by Briah. In the emotional, dream-like, image-filled world of yetzirah, the relationship was always one of 'subject-object', similar to our earthly experiences, only with the added advantage or disadvantage of having our thoughts become reality before us. In Briah, the relationship changes to one of pure knowing, without having the often confusing world of symbols get in the way.

In Atzilooth, the relationship changes again, to one of pure being. This however, is for the most part, beyond the scope of most practical work.

In Pathworking, the Veil of the Second Death, that of the ego and the astral images it has built up, occurs when contacts with the Briah are made, particularly through the 26th, 25th, and 24th Paths. If these Paths are avoided in the crossing, that is, the initiate attempts to go straight up the Pillar of Severity or Mercy first, severe repercussions may occur which will be examined later.

These three Paths are called the Veil of the Second Death or the Dark Night of the Soul. They are trying paths, meant to purify us of our mental, emotional, or psychic fears and attachments. While esoteric work is meant to do this all the time, it is through the conscious decision to pursue one or more of these paths that we accept the responsibility of recognizing and purifying what maybe very unpleasant aspects of our personality that we may have felt were previously done away with.

These unrefined aspects of our psyche and/or ego (id) act as filters between our awareness and pure experience of the Light Within. Thus, each time we make the decision to limit the effects of a vice on our personality, we are in effect removing one or more of the threads in the web of our mind that prevents a fuller realization of Cosmic Consciousness. Through repetitive Pathworking, in a systematic manner, we remove those threads in an orderly and balanced manner, thereby assisting in a more harmonious series of interior experiences. However, making it easier does not make it easy! An orderly and systematic approach only reduces negative side effects, it doesn't eliminate them.

When a sufficient level of awakening has occurred on the Solar level, or as some say, on the level of the soul, the sign language of the psyche gives way to direct conversation with one's Self. This Divine Spark is seen as not existing

at the level of Tiphareth, as it belongs to Kether (Crown), but may be talked to openly and directly. Or more accurately, at this level, *we listen* to it more openly and directly. While communication has taken place previously, it is only when we transcend the limitations of our own unconscious prejudices and preferences that we can hear the Voice of God Within. But to get there, a part of us must die. Herein are the three aspects, or Paths, of the Dark Night of the Soul.

24: Mercury to the Sun - This path requires that we let go of our nice, neat, little boxes that we have created in order to understand the universe, so that we can go from understanding to experience. It is a path of extreme obstacles in that a leap of faith is required where the mind would rather intellectualize. This is a particularly difficult path for those who enjoy explaining the nature of things through symbols but can never put it plain language. Gemetria, notarikon, and secrets hidden in similar manners are a trap that this path represents when they are seen as an end in themselves and not a means to stymie the intellect so that it can be transcended, similar to the fashion of a Zen koan. The need to meet physical masters in a mysterious fashion, or belief in the power of egregores is here. To free oneself from the gravitational pool of 'spiritualized materialism' in all of its forms is the task present here. The collection of esoteric pedigrees, titles, diplomas and lineages is the curse. Mistaking the form for the essence. "My way, lodge, order, group, teacher, etc. is better than your way, teacher, etc.." can be seen to some degree here. In the 30th Path tools are made, here they are hung onto, and become obstacles to our real interior development if we believe that we must have them in order to do the Work. Instead of being stepping stones, they become stumbling blocks, and our rituals, meditations, work, what have you, lacks power and the commitment that comes from the experience of really knowing. Intellectual pride mixed with spiritual pride born of ignorance and fear is the test of this Path. (--)

25: Moon to the Sun - This Path represents the uniting of our subconscious and psychic realm with our ability to consciously enter into a genuine spiritual contact. This Path is very experiential and direct. For some, the entering may occur only when asleep or when the psychic mind can be fully entered into, and through sincere desire, transcended. It is often described as part of the Way of the Mystic (the Middle Pillar) and while it does not directly impart power to the initiate, it does impart transcendent states of bliss, harmony, and genuine spiritual insight. The

problem with it is that one may make the mistake of having seen the Light, and mistaking themselves for the Light. In essence, their perception of God, i.e. God of their realizations, for the God of Creation. They may even see themselves as a channel for this newfound wisdom, and believe themselves to be invested with a messianic mission. (--)

26: Venus to the Sun - This Path is more difficult emotionally than the other two in that it goes against Mezla and imparts power to the initiate on the Return. It requires a facing of one's own death and mortality more so than before. Here the Terror is more powerful than before, as the ego knows what is in store for it and seeks to build strength through a variety of physical, emotional, and psychic delusions. Here the so-called *kundalini* is more active, and a certain amount of it flows palpably through the psychic centers. This inner fire brings about a reassertion of those things which we previously thought we had put behind us, but which still hang on in the sock drawers of our mind. In essence, it brings about a so-called 'Mid-life crisis' in the initiate, regardless of their physical age. (+)

All of the Paths associated with Tiphareth or our Solar element bring with them on some level the risk of spiritual pride. This is because the solar fire, that is the energy of our core being as it reflects the Light of our Highest Self, God if you will, empowers all that it touches. Thus, if not sufficiently cleaned out, our intellectual delusions and feelings toward self and the world will be exaggerated in Hod (Mercury). Our passions and creative instincts and impulses, whether they be artistic, sexual, or simply as emotional expression will be exaggerated in Netzach (Venus). In Yesod (Moon), our sense of spiritual communion, purpose, and mission will be empowered or distorted depending on our degree of psychological health.

What can make this even more confusing is the lack of adequate language to describe the various states and levels of experience. We talk of one Tree, but Four Worlds, and a Tree within in World, or even sphere. Fortunately, computer programs give us some useful metaphors to help explain the ancient metaphors we are using. Each sphere can be seen a text inside of a greater file. Every time we open one, we have the opportunity in some fashion to open another related to it. Each sphere is like a 'window' that when opened, can cause an internal cascade of connections to other related 'windows' or files. Only when we have fully explored all of the file (spheres) in a folder (World)

are we able to see how it all hooks together. In essence, create these internal files, folders, windows, so that we can digest the material in small pieces. In reality, we are working on all spheres and paths simultaneously. However, we only become aware of them one at a time. When we have a sufficient level of understanding of all spheres on some level, then we are said to have working knowledge of a World. With each World, this knowledge, via experience, deepens, and so does our degree of initiation. We are also given glimpses of what lies ahead at certain points along the journey. When we experience the harmony of the physical world, we get an impulse to sense what lies beyond it (the psychic, Yetzirah). When we experience the central unity of the emotional-astral world (Yetzirah) we get a glimpse of the awesome guiding intelligence behind it in the World of Briah. When the harmony of this world is experienced, we get a sense of what remains on our journey home. Thus, we can travel each path four times, for each of the levels of possible experience. It is however, in the world of Yetzirah, that the most important part of our Work is done. It is on the lowest path, those leading up to Tiphareth on some level, that we need to focus our attention if we are to go beyond the Veil of the Second Death and be of genuine Service and not just self-serving under the guise of spirituality.

All of the Paths may be experienced on the level of Yetzirah, but not all of them are directly, or principally concerned with it. Those Paths leading to Tiphareth are concerned with the structure and purification of the ego, our sense of self and how we deal with the world. Those Paths leading from Tiphareth in the world of Briah are concerned with our expressing of those values in daily life, and as service and sacrifice. They are more concerned with the experiencing and directing of the energy of the Soul (Superconsciousness). The Paths leading beyond the Abyss, and in the world of Atziloth are concerned principally with contacting directly the undifferentiated energy of God (Collective Consciousness). This is why work on the lower Paths is so critical. If one jumps to the higher paths, or works them out of order, then they risk triggering impulses within themselves and environment that they will be unprepared for. The energy will not flow smoothly, it will eradicate blocks as it goes, and psychic, physical, or social ills may result from it. Once the energy hits a block, it will flow like water through whatever channel is available, be it a weakness or a strength.

Skipping the Center

As a result of some of these blocks, some seek to avoid the conflicts and sacrifices that occur along the Way of Return. This is most dangerous when the initiate seeks to cheat nature's demands and climb up the sides of the Tree, that is enter the higher realms of the superconsciousness (Tiphareth) without having made the required sacrifice of the ego's dominant features. This happens when the Path between Mercury and Mars, or Venus and Jupiter is chosen prematurely.

23: Mercury to Mars - This path will give the initiate additional focus and energy for their chosen work, but if prematurely taken, it can bring arrogance, intellectual pride, militancy in one's esoteric, intellectual, or material life that is disproportionate to what is required, and as such, be qlipothic. Destruction of what is imperfect in others, justification and rationalization of military adventurism may occur. Extreme criticism of others in their activities, with a need to correct (or fine tune) another's statements, actions, thoughts, etc. will occur. Self-righteousness coupled with failure will be seen, since no other emotion than anger, fear, bitterness, and distrust or outright dishonesty are expressed. Fear of uncontrolled change. (--)

21: Venus to Jupiter - The problem presented by a premature awakening of this Path is that the sense of beauty and sensuality present in Venus is strengthened by the material needs of Jupiter. In short, selfishness, greed, debauchery, are reinforced. The desire for fame, fortune, and glory at whatever expense can be seen. (--)

Since the preference for which Pillar to climb will most likely result in earlier preferences, that is an opening of Venus without Mercury will lead to a high strung and irrational approach to one's endless material and sensual desires, but if Mercury is open, then the probability of them manifesting is likely. Here one uses their intellectual powers simply as a means to satisfy their earthly desires and lust for power.

If Mercury is opened, but Venus isn't and the energy flows toward Mars out of the ego's fear of emotional power and need to be reduced in priority for the Solar light to be more pronounced, then neuroses, anxieties, and fear will dominate, as the initiate only has the power of 'well laid plans' which never manifest before them. Since there is no real

passion, even in the most selfish sense, there is no psychic or creative power present.

The problems then presented are simple. The power of the higher sphere must be abandoned and the proper corrections made, or the more highly refined psychic energies unleashed will fall like a weight upon the unrefined and weak psychic structure below, reducing it to rubble. If the energy (under direction of a panicking ego) seeks an escape from this 'fall', then it can only increase the complexity of the issues stated by climbing to the top of their respective pillars; follow the course of *involution* not *evolution* on their return to Tiphareth; or attempt further premature Path crossings, this time across the Abyss, resulting in possible long term psychological damage.

The problem placed by the Abyss, or *Daath*, is that it represents Knowledge, or a state of Awareness, not accessible to the limitations of the ego. That is, it is access to unrestricted Deity and as such shatters all restrictions. On the descent, the energy coming through Daath begins to form the nucleus of our ego, so on the ascent, this same energy can only undo or de-form the ego if any is present. Daath is crossed several times, and can even to some degree be seen in our experiences of our unconscious with its psychic, sexual, and repressed drives and inhibitions (Yesod). Here we are taken back by the new world of dreams, fantasy, and psychic reality that awaits us, but must first face the Terror of the Threshold that awaits us. This terror, loss of control, and devastating encounter with genuine reality would only crush the ego we have so carefully built up over the ages and our whole sense of being with it, if we did not first, slowly, layer by layer undo and rebuild ourselves from self to Self. This is not to say that those who have crossed the Abyss *in some form* do not

have egos or a sense of self in the world, but that through training, experience, and Divine Grace, they have been able to temporarily set it aside so that they may enter into higher states of awareness.

Ficino and Renaissance Psychotherapy

Marsilio Ficino¹ was a fifteenth century priest and physician whose work, *Libri de Vita* was first published in 1489, and was subsequently the most popular of all his writings. Like most medical texts of the Middle Ages and the Renaissance, Ficino's work liberally used astrological symbolism and methods for prescribing cures for various diseases. Just as genetics would be taken for granted in a modern medical text, in Ficino's period astrology would be as well.

RESEARCH NOTICES

HOW TO BECOME ACTIVE IN RESEARCH

If you would like to participate in research in one or more of these fields, please forward your name, address, telephone number, email address, and your specific interests to the research directors:

- **ORA PROJECT** (reports in May & November)
c/o Mark Stavish, Director of Research
58 Carey Avenue, Wilkes-Barre, PA 18702 USA
Email address pending – for the present, use:
Email: alchemy@mcs.com Type "ORA" in message.
- **LABORA PROJECT** (reports in January & July)
Philosophers of Nature "LABORA"
Director of Research - Curt Kobylarz-Schmidt
West Front Street, Suite 263, Wheaton, IL 60187 USA Email:
alchemy@mcs.com Type "LABORA" in message.

What set Ficino apart however, was his suggested use of talismans for the curing of diseases, in particular *melancholy*, a disease ruled by Saturn, and as such, its bordering on crossing the fine line into magic, in an era where even the accusation of such practices could cost one their reputation or life.

Ficino's natural magic was similar to many of the ideas put forth by psychologists today, only he structured it in the language of the period, *and*, had genuinely magical (i.e. Neoplatonic/Greco-Egyptian) applications through the use of talismans.

In summary, Ficino stated that we are, or become, the images that we surround ourselves with, and that we can 'draw down the life of the heavens' through the application

¹ Giordano Bruno and the Hermetic Tradition, by Francis A. Yates, The University of Chicago Press, Chicago, IL, 1964.

of plants, food, scents, colors, and animals that correspond to a particular planet (i.e. quality) which we seek.

Ficino prescribed for his clients that they surround themselves with the images of universal harmony, as well as those representing particular virtues. Paintings, murals, mechanical clocks of the solar system, anything which the mind could imagine, was to be put to the use of reminding the observer of the underlying influences it represented. In fact, Ficino and his contemporaries would go so far as to say, not just represented, but incarnated, thus moving Ficino from pure psychology into magic.

Crossing this threshold from pure practical psychology into the realms of magic is a critical step, both internally and externally. In doing so, Ficino, or one practicing his 'prescription for what ails us', no longer is just a passive participant in creation, but an active agent in its unfoldment. The powers move from being a closed, internal, personal experience, into an interchange with cosmological forces, accessible to all of us.

The same theory of association and connecting *spiritus* was applied to music and song, through singing the invocations of the Orphic Hymns.

Most of the images suggested by Ficino are similar to those presented in the *Picatrix*, and are composed mainly of planetary symbols with the ancient gods in their normal forms. The use of these mundane images, is justified, as working only with the 'worldly forces' and not 'demonic' or 'spiritual ones', and is thus, 'natural magic'.

Thomas Moore points out in the introduction to his work, *The Planets Within*, that for Marsilio Ficino, the soul pervaded and embraced everything. To encounter the soul and its power, Ficino suggested the use of images, like so many hermeticists before and after him, and suggested the constant and regular use of imagery. Psychological health for Ficino could even be measured in the degree that a person used imagery in their lives and had a well-nourished imagination. Not unlike our later-day psychotherapist and magician Dr. Israel Regardie who is often quoted as saying, "Invoke often!"

The principal idea behind Ficino's psycho-spiritual hermeticism is in the practice of experiencing an imminent deity. By recognizing our psychological tendencies through astrology (or reflection or therapy) we can begin to develop

our strengths and minimize our weaknesses. This is done primarily through experiencing those qualities we seek to embody through association.

If we surround ourselves with beauty, we become beauty. If we surround ourselves with wisdom, we become wisdom, and so forth. Images are formed in the mind, and as much as possible, created in the material world. Thus, divinity is not limited to abstraction, and flights of fancy, but made incarnate in our daily experiences.

In the ritual setting, the decorations of the temple will often be colored, scented, and resounded with those things most closely associated with the spheres/planets involved in the pathworking. Images both internal and external will be imagined and created to focus the consciousness on the task at hand. Here we see a direct connection between Renaissance magic, modern magical pathworkings, psychology, and initiation.

Alchemical Pathologies

"Remember - many pretend; few know." - Hymns of Orpheus

The difference between the alchemical methods of return and kabbalistic methods is more in the technique than the actual effect. Just as an alchemist creates tinctures, medicines, and alchemical products such as oils, or Stones, the kabbalist produces talismans, charged (or 'loaded') objects, such as crystals, metals, or fluids. Both are designed to have effects on the psyche of those who use or come into contact with them, and are outer manifestations of the inner development of the one who prepared them.

To some degree, much of what has been said about the Paths on the Tree of Life is applicable to those undertaking alchemical Work. Since each sphere has its own equivalent in the metallic and plant kingdoms, and many students of alchemy follow the planetary paths on the Tree when creating tinctures of Stones, the same warnings as well as insights may apply.

In alchemical Work, the student first begins with plant materials, and then proceeds through the metallic, and mineral realms. Each of these realms, or Kingdoms, represents a deepening of the previously learned material, through its application on a new level. The effects of a plant medicine may last for only a week or so, but the effects of a metallic medicine of the same planetary corre-

spondence will have a much deeper and more permanent effect. The effects we are talking about of course, are changes, i.e., broader and more comprehensive expansions of consciousness.

The effects of these medicines may be most readily seen in the psychic or dream world of those who ingest them. Since the effects of plant medicines are the most transient and gentle to our psychic physiology, they will most likely make themselves known when we are most passive and receptive to their influences, such as periods of rest, meditation, or sleep. The effects of metallic or mineral medicines are more profound, and have a greater potency and chance of breaking through and effecting our daily awareness without our having to be receptive to them.

It is for this reason, along with needed safety and procedural conditioning, that we are advised to undertake the Lesser Work of plants before we undertake the Greater Work of the Metallic and Mineral Kingdoms.

There is however, a subtle point being made here. The Plant Kingdom for the most part represents our psychic, or Yetziric nature (Lower Astral/Emotional), whereas the Metallic Kingdom represents our personal World of Briah (Higher Astral/Mental). In short, jumping into the Metallic Work without plant preparation is the alchemical equivalent of starting kabbalistic Pathworking with all of the Paths above Tiphareth, while having done none of the Paths

below it!

The Plant Kingdom concerns itself mostly with the areas of the psyche, and material creatures that are most easily effected by the moon. Lunar tides are taken into account when certain forms of ceremonial magic are performed, as well as when plant tinctures are prepared, worked on, and completed. This concern with the subtle effects of lunar forces on the mind, emotions, and fluid nature of the operator and its being transferred to the medicine being prepared, demonstrates this point.

"...jumping into the Metallic Work without plant preparation is the alchemical equivalent of starting kabbalistic Pathworking with all of the Paths above Tiphareth, while having done none of the Paths below it!"

While this overlap of kabbalah, The Tree of Life, and alchemy strays from the path set down by Paracelsus, it is one that most modern students of alchemy are familiar with, either through the writings of Frater Albertus,

Manfred Junius, the Rose+Croix University Alchemy Classes (AMORC), or the teachings of The Philosophers of Nature (PON).

Taking this model a step further, failure in one or more of the procedures of spagyry or alchemy signifies an internal 'gap' or 'pathology' in the psychic body (emotional-mental make up) of the operator. A gap which needs to be identified internally, and repaired, if the process is to succeed in the outer world of creating medicines. The failure to create a medicine designed to heal primarily the psyche of oneself or others signifies that the one creating it has yet to heal that part of themselves. Hence the alchemical maxim, "You cannot make gold unless you have gold".

ABOUT THE STONE

The Stone provides a forum for articles (5000 word maximum), conference announcements, research summaries and other items of interest to PON members and our subscribers. Authors should, if possible, submit manuscripts as an email attachment to alchemy@mcs.com using a plain text (ASCII format) or mail them on disk along with unmarked, printed copies. Publication decisions are normally made within four to six weeks. Selected articles from *The Stone* will be republished on the PON Internet site of PON at the discretion of the editors.

The Stone is published every two months, and is normally mailed on the 2nd Monday of the odd-numbered months.

Subscriptions to *The Stone* are \$30.00 US per year for non-members, and are free to active members. Membership dues are \$30.00 US per year. Subscriptions are for January through December – all back issues for current year are sent to new subscribers. Add \$10.00 for foreign postage. Make payment by credit card or by check drawn on a bank with a US branch.

Send all inquiries to:

The Philosophers of Nature
125 West Front Street, Suite 263, Wheaton, IL 60187 USA
Email: alchemy@mcs.com

This gap in our 'wholeness of Being' is only further emphasized in more complex Work, be it alchemical, kabbalistic, or both. The more complicated the psychic state, the more pure it is, and less personal, the greater the chances of fragmenting of the personality, or personifying these states, so as to make them manageable. The more complex the psychic state is, the more it will take on the sense (from our perspective) of being, or needing, personification. (Alchemical Studies, C.G. Jung, Princeton University Press, 1983. P. 53)

Here, maybe the biggest risks to the alchemist are rushing into 'more advanced Work' before they are ready; minimizing the importance or effect of plant work; and over materializing the Work. That is, becoming so familiar with the chemical and material aspects of what they are doing, that they are unaware of its psychic equivalent within themselves. That is, if Mercury is the chemical equivalent of alcohol, or even actual Hg, what does that translate into in the psychic realm of the operator? If I am creating the Red Stone, or Philosophic Mercury, what does this mean as far as internal changes within my psyche? If I can only achieve in the outer once I have achieved in the inner, what does this chemical problem translate into as far as my personal maturity and growth goes?

While it may appear that the differences between the ceremonial path and the alchemical path are great, in reality they are quite small and suffer from the same strengths and weakness. Both fall under the domain of Hod/Mercury, the area of the mind and intellect, and are susceptible to the same obstacles on the Path.

Summary

To undertake the task of the Path of Return, we need to recognize the many facets of our psyche, how they relate to one another and interact, the problems and potentials that are set forth at each step of the journey. To this end the Tree of Life is a useful diagram, map, and tool. Only in its application however, do we find the subtleties that exist

within us. By "making haste slowly" we can unravel the tangled web of our interior life so that the Inner Light, the Light of initiation can be revealed. When this is done, the promise of Comte de Gabalis to his student is understood, but only if we undertake the task set forth:

"I praise the Eternal Wisdom for inspiring me to conceal from you none of her Ineffable Truths. How happy you will be, my Son, if she is gracious enough to put into your soul the resolutions which these High Mysteries require of you. Soon you will command all Nature, God alone will be

your Master, and only the Sages your equals. The Supreme Intelligences will glory in obeying your desires, the demons will not dare to be found where you are, your voice will make them tremble in the depths of the abyss, and all the Invisible Peoples who dwell in the four Elements will deem themselves happy to be the minister of your pleasure. I worship Thee, oh mighty God, because thou hast crowned man with such great glory, and hast created him a Sovereign Monarch of all the works of Thine hands. My Son," he added,

turning towards me, "do you feel within yourself that heroic ambition which is the infallible characteristic of the Children of Wisdom? Do you dare seek to serve God alone, and to master that which is not of God? Do you understand what it means to be a Man? And are you not weary of being a slave when you were born to be a Sovereign? ...consider seriously whether you will have the courage and strength to renounce everything which might prove and obstacle in attaining that eminence for which you were born."¹

Questions we will all be able to answer someday. ⊕

¹ Comte De Gabalis, by the Abbe N. Montfaucon de Villars, published by The Brothers, New York, New York. 1914.

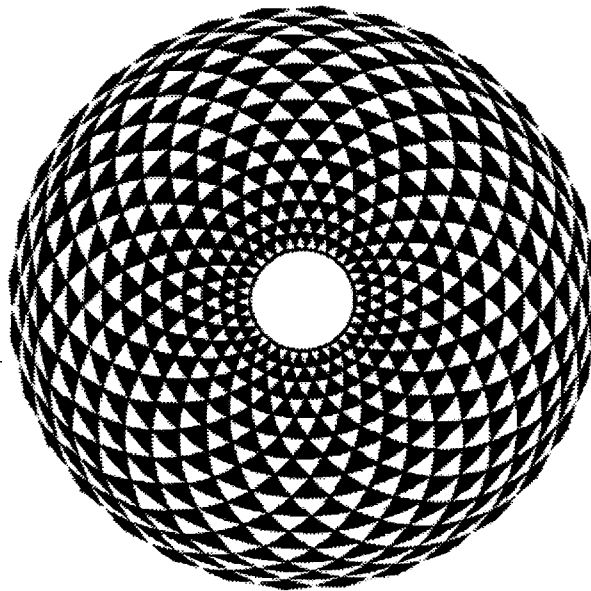

An Interview with John Reid, III

by Russ House

John is the author of The Minor Opus, a work on Plant Alchemy. We are delighted that John has been able to set aside the time to make a presentation at the 6th Annual PON seminar in Colorado Springs, his first for us. This interview was conducted via email between February 19 and 24, 1997.

RH: John, please tell us something about yourself, how you got involved in Alchemy, your major influences.

JR: I was introduced to the subject of Hermetics by a magician when I was about 23 years old. The first two books I got on the subject were Initiation into Hermetics by Franz Bardon and A Compendium of Alchemical Processes. The very first alchemical experiment I tried was "Silver Transmuted into Gold by the Action of Light". It of course did not work, but it was fun to build the apparatus to conduct the experiment.

Sometime after this I got my first book by Frater Albertus titled Alchemist of the Rocky Mountains. The funny thing was, I was actually looking for the Alchemist's Handbook also by Albertus. The guy at Weiser said they were out, but, by the way he had a signed and numbered copy of another book by the author. I got it and it changed my life.

Within three years I had a library that contained a complete set of Alchemical Laboratory Bulletins, Parachemy and Essentia¹ magazines, and most of the other books and material published by Albertus and the college. I would say that my greatest influence in alchemy would definitely be Albertus.

Manfred Junius' book on plant alchemy² was also a tremendous influence. The lectures given by Jean Dubuis at the first PON seminar (October 1992 in Winfield, Illinois) helped tremendously. Also, there were persons that I meet

along the way who were kind enough to explain certain intricacies of the work to me.

RH: Your book, The Minor Opus, has been published on the Internet at Adam McLean's excellent Alchemy site (<http://www.levity.com/alchemy>). It has prompted a lot of interest. For those who have not read it, what does it cover?

JR: The intent behind the writing the book was to freely share any information and processes concerning the plant and mineral work that were revealed to me from the work I was doing in the laboratory.

Hopefully it will help the student understand the differences between what is spagyric and alchemical. In a nut shell the book covers the production of herbal products according to the spagyric method and gives detailed instructions on how to go about this, including the production of a spagyric plant stone.

It also takes a crack at trying to introduce the novice into the art of alchemy. I have also attempted to explain -- I hope lucidly -- about the

philosophy of alchemy, the three essentials as I understand them, and the four elements.

The final part of the book gives detailed instructions on the preparation of the Archæus of Water and the creation of an alchemical plant stone or the Opus Minor.

RH: What do you see as the fundamental difference between spagyrics and alchemy? Is it a real distinction, or is there some overlap between them?

JR: Well, on the one hand, the spagyric technique is the foundation of the alchemical art, at least as far as the manual operations go. But every spagyric product is definitely not alchemical. There is a little debate brewing in certain circles as to which particular method of preparing herbal products deserves to be called truly spagyric. Fundamentally spagyria is separation, purification and recombination of the matter being worked on. By itself the operation is very Newtonian or mechanistic, but when combined with the other two branches of Hermetic science it becomes something much more. What alchemy does is to take the

"The Art of Spagyria is not content with just bottling the sun, its true aim is to cause a dawning of realization in the conscious mind of man about his true nature. Again I have to point out that this is not a merely intellectual exercise, it is rooted in an altered perception of reality."

¹ These three publications were produced by Albertus's Paracelsus Research Society, and the Paracelsus College, which grew out of the original society. Now out of print, they are sought after for their practical information.

² The Practical Handbook of Plant Alchemy, published by Inner Traditions.

spagyric processes a step further; it demands an interaction between the alchemist and his matter. This interaction is brought about by "conscious intent".

RH: *Is it a difference of method?*

JR: Yes. The very fact that the alchemist perceives that he is able to interact with his matter, sets up a relationship with the matter, that is just not present in the mind of a mechanistic worker. The view the alchemist fosters is one of an organic, living, symbiosis between himself and his matter.

Because of this he will take great pains to produce by hand (art) all of the ingredients used in preparing his Magistry. This includes the collection of water used in the fermentation processes, solve and coagula of the salt etc.

The alchemist does this because he wishes to nurture the etheric vitality found in his subject, indeed he seeks to increase its virtue. This relationship starts out as a merely intellectual exercise, but as time goes on the work changes the practitioner. A fundamental shift occurs in the consciousness of the alchemist, and his perception of the world changes. He realizes that the fundamental impetus that God uses to continually create and sustain the universe is love. He also realizes that because God is omnipresent, so too is the original creative impetus of love omnipresent. It is this energy, this chi, this life force, that the alchemist seeks to incorporate into his products.



Mortars & Pestles
Photo: Russ House

RH: *Do you plan to bring the book out in print again?*

JR: At present the book is being translated into the German language. I would like to bring the book back into print in an English version. If this is done it will definitely be an expanded version with more detailed coverage on the water work and other experiments in the mineral kingdom.

RH: *Do you use astrology in your work? Does it play a major or a minor role?*

JR: Yes, astrology used properly is an indispensable aid in the work, but it can quickly become a very complicated thing that refuses to let you begin a work for years. For this reason I use a person's natal chart to define what energies, or lack thereof, a person is born with. This you could say is the diagnosis.

In order to prepare a medicine I prefer to use Astro-cyclic pulsations based on the 7 & 12 phase cycles promoted by Albertus. My understanding of their use is as follows. The 7 phase cycle represents the mental or spiritual energies that are to be worked with, it is associated with the 7 planets of the ancients, and the 7 days of the week. The 12 phase cycle represents the material conditions, the moon's phases, and its approximate 28 day trek through the signs of the zodiac. Depending on the need, 7 & 12 phase cycles, can be used that span a number of years or microseconds.

RH: *Is some knowledge of Qabala important in having practical success?*

JR: Yes. If spagyria represents the mechanical operations of the Hermetic science, and astro-cyclic pulsations (astrology) show the ambient etheric energies present for use, then Qabala gives us a framework in which to discern the proper uses and manipulations of this energy.

It is said that God represents, on the one hand, the deepest passion or desire one could imagine. And, on the other hand, He represents the complete and absolute fulfillment of the previously mentioned desire. These two halves when joined create bliss, because what ever need or desire God has, it is automatically and completely satiated.

Hermetic wisdom states that every manifestation in the universe has love as its fundamental impetus. Any appearance to the contrary is due to a lack of understanding on

the part of the onlooker. Ageless wisdom goes on to say that this vision of evil actually originates from within us. A better way to put this is that acceptance of the illusion gives form and credibility to that which is a lie.

I am not saying that what our senses report to us should be ignored. I am saying that what is reported by the senses is not the entire truth. The universe is the being of God, and God never created anything that is inimical to its own nature. Evil, in and of itself, is a lie and does not exist, yet the old Qabalists warn us not to deny the existence of evil. For a long time I had a problem in coming to terms with this apparent paradox.

The best I can come up with is the example of $2 + 2 = 3$. Everyone knows that this statement is a lie. Yet we can see it and move our fingers over the printed form. In this respect the world of matter is the world of illusions and lies. On this plane, that which is not believes itself to be, and it will beseech you to accept its existence. Yet it truly is not because it has no lawful basis or foundation in the archetypal, creative and formative worlds, because it is not true -- it is a lie, it never was.

One of my mentors stated to me that Christ was able to cure the sick and maimed not because he fixed something that was broken, but because he saw and affirmed the truth behind form, the true nature of our being. Which simply is this, that the universe is divine in origin, and what we call matter is created and sustained through the mental imagery of God.

It is said that when the alchemist reaches a state of adeptness, his will is one with the One Will. He is then able to control the currents of the life-force and negate any appearance of disharmony before him. Until this state is reached the admonition of the old qabalists should be heeded, or in the immortal words of the Rolling Stones at the end of the "Midnight Rambler" "I'll stick my knife right down your throat baby and it hurts!"

RH: Do you incorporate Qabalistic practice as part of your work, or is it used more to provide a theoretical background?

JR: When you are practicing alchemy you are doing, living, Qabala. The work finds its expression through your life. The glyph allows you to discern meaning, or the spirit behind the forms of life's expression. The more you under-

stand something, obviously the better you are able to utilize it.

Qabala not only shows effect, but also cause. Over time this builds a confident feeling of control in one's life. I think this brings us back to the phrase I used earlier about "conscious intent". The premise of all this is simple and is stated something like this: All matter in the three kingdoms of nature that is not on a level of consciousness equal to that of self-consciousness experienced by man is considered to be in the domain of sub-consciousness. Sub-consciousness itself uses deductive reasoning, and is amenable to suggestion (control) from self consciousness.

The Art of Spagyria is not content with just bottling the sun, its true aim is to cause a dawning of realization in the conscious mind of man about his true nature. Again I have to point out that this is not a merely intellectual exercise, it is rooted in an altered perception of reality.

This shifted perception is born from the alchemist placing his habitual daily actions and thought patterns under the most intense scrutiny. When this is done the seeker finds themselves realizing that their daily experiences are actually populated with events that have taken on a flavoring or tinting extrapolated from habitual thought patterns. They will in fact be amazed to find that many of their life's experiences are born from their most vividly intense mental imagery and are uncomfortably close to being carbon copies of this habitual imagery.

In the end this exercise develops faith and plants the seed thought which is the basis for the radical shift in perception I have been speaking about. This is especially potent I think, if the individual has been using their innate ability to create from mental imagery improperly, and the life they see before them is a living hell. I say this because when the correlation between thought and experience is realized consciously, sub-consciousness simply deduces the following: If my habitual negative thought patterns have created my present undesirable environment, then habitual positive patterns of thought will create a desirable environment.

When this happens the alchemist steps into a new world, filled with possibilities he never before dared to dream of. This creates an attitude that is, in almost every way, contrary to the natural man. Conscious intent now takes on much deeper meaning.

Combine this with the use of sound and color as Qabala teaches and you step onto the threshold of science that postulates that there are chemical reactions that can only be instigated by the conscious trained mind.

RH: John, I have been rereading the section in your book on the alkahest. I find it fascinating. One of the things that immediately attracted me to your work is the role of vinegar on the mineral aspect of the plants which opens a number of avenues not otherwise possible. Your alkahest is something more than 'just alcohol', and yet alcohol is involved. Can you walk us through the process, and explain the steps? (Note: This chapter is re-printed in this issue.)

JR: All right. Alcohol is distilled from red wine. This alcohol needs to be as pure as possible, anywhere from 96 to 99% pure (190 proof ethyl alcohol). Be sure to save the phlegm from the rectifications, as well as the colored tincture from the original distillation.

Red wine vinegar is concentrated by freezing, the container is then inverted, and the frozen mass allowed to partially thaw, and drip into another container. The bottom container will contain concentrated red wine vinegar, the top one a colored ice plug. This procedure is repeated at least seven times. Be sure to save the colored water from the ice plugs. A distillation is performed on the concentrated vinegar. You will end up with a clear concentrated vinegar in the receiver, and a colored tincture left in the distillation flask.

In the book, I separate the distillate into two fractions, based on temperature. This involves some complicated distillation techniques and is not necessary.

Pour the water from the ice into the tincture of vinegar. Boil this liquid and the tincture of wine down to a honey like consistency in separate pots. Use a heat lamp to bring both to complete dryness, it will look like hardened tar. Grind both of these to a powder. Place these, spoonful by spoonful, into a hot crucible and kiln. Perform a calcination on this until they are snow white.

Use the phlegm of the wine distillation to extract the water soluble salts. Use repeated solve and coagulas to ensure their purity. You can energize these salts by allowing them to repeatedly deliquesce outdoors during spring.

Take the alcohol and cohobate it with its dual body, allow it to circulate over night. Exhale it off gently (vapor distillation). Let all cool and repeat the process. This should all be done 7 times. Stopper the receiver with the alcohol. Add just enough of the phlegm from the alcohol to take the salts into solution. Litmus test will show this to be an alkaline solution. Add just enough of the vinegar to bring the solution to neutrality. Evaporate off all the liquids to expose the salts.

Assemble the distillation train. In the receiver have some of the rectified alcohol. The end of the take off tube must be under the level of alcohol, or else you will lose your spirit when it comes over. Into the retort place the neutral body. Heat the distillation flask in a hot sand bath. In the space of an hour or so a spirit will rise from the body and unite with the spirit of wine. Stopper the receiver immediately after distillation is done. The residuum in the distillation flask should be calcined again, salts extracted, made neutral and the entire process repeated. Keep this up until all or most of your body has united with the spirit of wine.

Our spirit of wine and spiritualized body are rhythmically circulated in their flask, in a body temperature incubator. Simply heat during the day and let it cool at night. This is done for 14 days. When done you will have a product that extracts the sulphur from an herb or crystal in little time.

RH: Was this process for the alkahest influenced by your reading of some of the modern or classical authors?

JR: Yes. Manfred Junius' Practical Handbook of Plant Alchemy and Basil Valentine's Triumphal Chariot of Antimony.

RH: What do you see as the purpose of the alchemical path?

JR: Realization. What I mean by this is the unfoldment that happens to the alchemist's consciousness as he does this work. Slowly he/she begins to realize the true nature of their being. When this happens the alchemist realizes that what he once considered as his "personal" volition, is actually a vehicle of expression through which the One Will works to bring about manifestation.

RH: Thanks, John, for making the time to share with our readers. We look forward to your workshop at the upcoming seminar.

An excerpt from: The Minor Opus

by John H. Reid III

© Copyright, 1992, 1997 by John H. Reid III. All rights reserved.
Reprinted with the permission of the author.

Chapter 5: Alkahest of the Vegetable Kingdom.

In spagyrics there is a special menstruum called an alkahest. This product is able to extract the spagyric sulfur from plants and minerals in a very short time, thereby saving the alchemist much time and labor. This menstruum is really very easy to prepare. It requires only patience and diligence in the work.

Take one gallon of red wine and rectify it seven times as was described earlier. When completed save the alcohol in a mason jar labeled as such. Be sure to also save the phlegm left from the rectifications. The dark-colored tincture that remains after the rectification is to be boiled off gently. In the bottom of the container, you will see a honey-like pitch. Dry this by evaporation until it forms a gum or hardened tar-like substance.

Take three one gallon plastic containers of red wine vinegar and place them into the freezer without their caps. Allow the vinegar to freeze overnight. Take the containers from the freezer and invert them allow the vinegar to drip out of the containers into another one. After a few hours you will find a strong-smelling colored water has filled the second container. In the first is left a plug of frozen water. Repeat this procedure at least seven times and your water will be sharp and very penetrating. Be sure to save the water from the ice plugs. Take the sharp concentrated vinegar after its seven rectifications and place it into a distillation flask. Assemble a distillation train and apply heat. Distill slowly and you will get a fraction that comes over at 100 degrees C (water) and another that comes over at 103 degrees C and peaks at 105 degrees C (concentrated vinegar). You must switch receivers between the time when all of the water has distilled over and the corrosive spirit starts to come over. Be sure though not to burn the colored tincture by urging the fire to rashly. Pour the tincture in the receiver into a mason jar marked "tincture of vinegar." This procedure should be repeated three more times. But only distill off the water and do not make the spirit fly.

Pour the water that was left from the ice plugs into the colored tincture left after the distillation. Dry this liquid into a gum or hardened tar as you did the body of its sibling.

Grind both gums to a powder. Place them spoonful by spoonful into a crucible and calcine them to whiteness. In the beginning you will see the impurities burn away from their bodies and rise as a smoke (use a hood or do it outside). When they have become purified to a snowy whiteness they are ready. Use the clear phlegm saved from the rectification of the alcohol to extract the true body of our spirits from the calcined matter. The body of the spirits is the base of our operation. They must be exceedingly pure. To test their spirituality take them outside on a clear spring day. If truly pure they will turn to liquid and leave no trace of solid behind. When gently heated to remove the moisture of the atmosphere they will turn solid again.

Take the rectified alcohol and cohobate it with its dual body. Exhale it off gently (i.e., vapor distillation). Let the apparatus cool and then cohobate the spirit onto the body once more. Distill again and cohobate seven or more times, the more often the better.

Add just enough of the phlegm from the alcohol rectification to dissolve the bodies. Add just enough of the vinegar so nature will find her balance. Evaporate off all liquids. Assemble the distillation train. In the receiver have some of the rectified alcohol. The end of the take-off tube must be under the level of the alcohol or else you will lose your spirit when it comes over. Into the retort place the body. Heat the distillation flask in a hot sand bath and you will see in the space of an hour or so the body rise and come to unite with the spirit of wine. Let the apparatus cool. Remove the spirits in the receiver and place them into a well-closed flask. Be sure to put back in enough alcohol to submerge the end of the take-off tube.

Calcine the matter left in the retort. Add enough phlegm or distilled water to dissolve what is in the retort. Add the rectified vinegar as you did before and distill as you did before. Keep this operation up until all or most of the body has united with spirit of wine.

Take the flask containing the spirit and the body and circulate in rhythm with the sun and moon for fourteen days. After the circulation is completed, let the flask cool. The body now spiritualized will always come over with the united spirit. Keep this menstruum, this magistry, in a bottle closed very tightly. It will separate the spagyric sulfur from an herb in very little time. It will also work on crystals, when they are prepared according to our art.

⊕

MINERALS FOR THE PORTÆ LUCIS WORK:

This path for *making an Eternity Contact using simplified methods* was quite clearly explained in the excellent seminar by Mr. Dubuis held in Glen Ellyn, IL, October 18-20. The surveys we received from those attending the seminar, as well as the comments made to us indicate that this was the finest presentation by Mr. Dubuis to date.

Those who attended the seminar, and those who have viewed the video tape of that seminar, *Portæ Lucis: Volume 1, An Introduction*, will be looking for some specific materials. At the present time, we are able to offer specimens of native diamond, galena, silver and gold. All gold is shown as an approximate weight in dwt (pennyweight). Our 0.3 dwt samples average about 4 x 6 mm. The 0.1 dwt samples contain from 1 to 4 pieces of gold to make the appropriate weight.

Item No:	Description:	Source:	Approx. Size:	Price Ea.,
DI-010	Diamond, Industrial grade octahedral crystal	South Africa	1 mm.	\$23.00
DI-015	Diamond (as above) *	South Africa	1.5 mm	\$27.00
DI-020	Diamond, native, cubic	Africa	2 mm	\$28.00
AU-201	Gold, native	California	0.1 dwt	\$6.00
AU-202	Gold, native	California	0.2 dwt	\$11.50
AU-203	Gold, native	California	0.3 dwt	\$16.50
AU-204	Gold, native	California	0.4 dwt	\$22.00
AU-205	Gold, native	California	0.5 dwt	\$28.00
AU-206	Gold, native *	California	0.6 dwt	\$32.00
AR-001	Silver dendrite crystal group, very pure *	Mexico	Small	\$32.00
AR-002	Silver dendrite crystal group, very pure *	Mexico	1 - 2 cm fronds	3 pcs. for \$16.00
PB-001	Galena, cleavable, high quality	Kansas & IL	25 x 25 mm	\$4.00
PB-010	Galena, cleavable, high quality	Kansas & IL	25 x 25 mm	10 pcs. for \$32.00

Please make checks payable to Philosophers of Nature.

Add \$3.00 for US postage, \$5.00 for Canadian, \$8.00 for all other countries.

*Please allow 4-6 weeks for delivery. Supplies are limited. * Only 1-3 pieces available, specify second choice*

Announcement:

P.O.N. SEMINAR VIDEO TAPES

Some months ago we announced the release of 'student grade' video tapes from several important seminars. These were sold at prices between \$10.95 and \$19.95 per set, as unedited tapes which were duplicated with a noticeable loss in video quality. Still, we knew many of our members would benefit from having these tapes. Essentially we decided to sell video tapes that were priced so low that they were as affordable as an audio tape, but with the benefit of being at least somewhat more enjoyable and informative to use. The response was overwhelming – we had a hard time keeping up with orders.

We have decided to withdraw this offer effective with the publication of this edition of The Stone. All orders which we already have received will be filled on a first-come, first-served basis, but we will not accept new orders for these tapes. Over the next 60 days we will determine which tapes are to be released in a higher-quality edition. An announcement will be made in the next issue of The Stone. We regret any inconvenience.

The PON has just purchased a new video camera, made possible through the strong sales of the 'student grade' videos.

Announcement: Practical Work on Spagyrics now available from The P.O.N.

In 1994, the booklet *Spagyric Tinctures – Tradition, Preparation and Use* by Beat Krummenacher appeared in an English translation by Karin Di Giacomo. The rights have since been obtained by The PON. In this invaluable booklet, the contemporary Swiss alchemist and spagyrist explains the methods of Zimpel, Glauber, Krauss and Heinz, before setting forth his own method of preparing spagyric remedies. Paracelsus' ideas on the *Arcana*, and important ideas on the polarity of remedies as healing agents or as poisons are developed at some length. This is a most useful map for finding one's way in the Spagyric realm... we think that it will provoke some thinking about one's own practice, and suggest improvements that can be tested for their value.

The cost of \$16.95 for this ring-bound 49-page booklet includes postage in the US.

See order form for foreign postal costs.

The Philosophers of Nature
125 West Front Street, Suite 263, Wheaton, IL 60187 USA

NEWSLETTER BACK ISSUE ORDER FORM

Send	Issue	Main Articles/Topics	Price	Total
<input type="checkbox"/>	#1 Fall 1990	What is LPN-USA? Spiritus Aceti Oleosus; 20th Century Masters on the Physics of Alchemical Transmutation; Spagyrics (by Jean Dubuis); Universality of Alchemy	\$ 4.00	\$
<input type="checkbox"/>	2/3 Winter '90 Spring '91	1990 Visit with Dubuis; Exploring Sin and Karma (Dubuis); Primum Ens Melissa; Seminar report - Manfred Junius; Seminar report - Dr. Nawrocki; Complementarity & Alchemy	\$4.00	\$
<input type="checkbox"/>	#4 -Fall 1991	Superstitions & Alchemy (Dubuis); Bhasma of Zinc; Seminar report - Junius; Spagyric Lab Notes	\$4.00	\$
<input type="checkbox"/>	#5 Spring 1992	Nature & Alchemy (Dubuis) Tincture of Tartar; Dilemmas in Alchemical Language; A Call to Service; Update on Changes in Organization; Vacuum Fractionation	\$4.00	\$
<input type="checkbox"/>	#6 Fall 1992	"Chemist" Alchemists; Did They Confect the Philosophers Stone? Distinguishing Spagyrics & Alchemy; Seminar Report - Canada 1992; Angelic "Great Table" in Enochian Magic; Esoteric Tourism; Spagyric Lab Notes	\$5.00	\$
<input type="checkbox"/>	#7 Spring 1993	Recent Changes in LPN-France; Hermetic Myths and Rosicrucian Fables; Who Was Franz Bardon? Tincture Tartari; Seminar report - Illinois, 1992; Taoist Yoga & Alchemy	\$5.00	\$
<input type="checkbox"/>	#8 Summer '93	Spagyric Lab Notes; The Spagyric Technique; Comments on Chinese Alchemy; The Alchemy of Politics; Research Update - Flamel Path; Research Project notice; Name change to Philosophers of Nature	\$5.00	\$
<input type="checkbox"/>	#9/10 March 1994 July 1994	Message from President (Van Doren); Organization Charter; Copyright Proposal: Old Distilling Apparatus; How to Make the Stone; Vinegar of Antimony; Acetate Paths; Operative Couplings of Zodiacal Signs; Currents of the Cube of Space (Townley); Newton & Flamel - Antimonial Regulus	\$5.00	\$
<input type="checkbox"/>	#11 Nov. 1994	Message from New President (Kevin Townley); The Moon: Rotation & Reflection; Psychopathology & Occultism; Oraculum; Cleaning Amalgam from Crucibles; Creating the Seven Planetary Ens; PON Annual Report - 1994.	\$5.00	\$
<input type="checkbox"/>	#12 March 1995	Secrecy, Revelation & Desire; No Master, No Servant; Kabbalah & the Hermetic Tradition; Glamour; Homemade Retort for Mercury Distillation; Force Fields, Fulcanelli & Flamel; Freemasonry -Introduction; <i>Ora et Labora - 3/95</i>	\$5.00	\$
<input type="checkbox"/>	#13 July 1995	Presidential message (Townley); News about Alchemy; Tour of France; How to Prepare Wine Spirits; Survey of Occult Fiction; PON on the Internet; <i>Ora et Labora - 7/95</i>	\$5.00	\$
<input type="checkbox"/>	#14 Nov. 1995	Notes from the Editor; Rosicrucian Conference in Bohemia; Hermeticism & Esoteric Islam; The Sign of the Cross; Spiritual Implications of Nuclear Power; Structure and Use of Tarot (Pt 1); <i>Ora et Labora - 11/95</i> .	\$5.00	\$
<input type="checkbox"/>	#15 March 1996	Editor's Message; The Open Door of Alchemy; Structure and Use of Tarot (Pt 2); German Magical Folklore; <i>Ora et Labora - 3/96</i>	\$5.00	\$
<input type="checkbox"/>	#16 July 1996	Did they confect the Philosopher's Stone (on the Ingalese myth), Report on Annual Conference, Meditations on the Cube of Space (Townley), Hermeticism and the Golden Fleece, Mudra and Rosicrucian Healing.	\$5.00	\$
<input type="checkbox"/>	#17 Nov-Dec 1996	Message from the New President (House), Open Letter to Subscribers, Research Announcement, A Poem: "Beauty", A Speculation, on the Unspoken Essential, al-Kimia -The Sacred Art, Practical Tips, Video News	\$5.00	\$
<input type="checkbox"/>	PACKET-A	ALL ISSUES 1-17 (15 newsletters)	\$55.00	\$
<input type="checkbox"/>	PACKET-B	ANY 5 ISSUES - Send me the 5 issues checked above	\$20.00	\$
POSTAGE - North America -- No postage for 1-4 issues. PACKET-A/B, add \$4.00 for Canada & Mexico. Europe, Asia, Africa -- \$3.00 for 1-4 issues. PACKET-A/B, add \$6.00. Australia, New Zealand, Pacific Rim -- \$4.00 for 1-4 issues. PACKET-A/B, add \$8.00.				\$
			TOTAL	\$

Fax your credit card order 24 hours a day to 630.665.2364

Please check payment method

Check Enclosed (payable to The Philosophers of Nature) Credit Card (Visa / Master Card / American Express only)

Card No: _____ Visa MasterCard American Express

Signature _____ Expiration: _____
MONTH YEAR

PLEASE NOTE: CREDIT CARD STATEMENTS WILL SHOW CHARGES MADE TO TRIAD LABS

SHIP THIS ORDER TO:

Name
Address
City, State, Postal Code
Phone <input type="checkbox"/> Home <input type="checkbox"/> Work ()

Please allow 4-6 weeks for processing

THE STONE

THE JOURNAL OF THE PHILOSOPHERS OF NATURE

© 1997, THE PHILOSOPHERS OF NATURE. ALL RIGHTS RESERVED.

ISSUE NUMBER 20

MAY-JUNE 1997

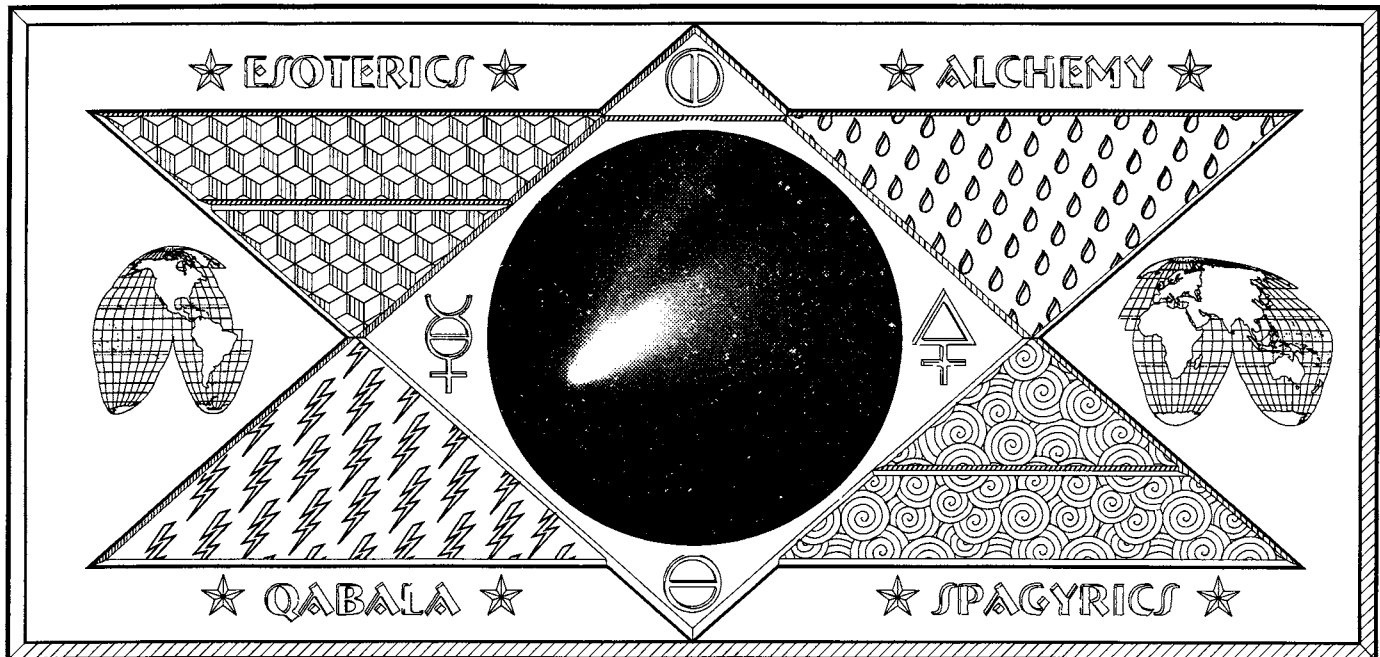

IN THIS ISSUE

	Article or Feature	Author	Page
♂	A Message from the President	Russell House	2
♂	THE 6TH ANNUAL PON CONFERENCE - JULY 17-20, 1997	PON	4
♂	An Interview with Curt Kobylarz-Schmidt	Rick Grimes	5
♂	Alchemical Gardening	Rick Grimes	11
♂	Verdigris, Green Lion and Vitriol: The Basis of the Philosopher's Stone	B. Krummenacher	14
♂	Yantras and Alchemy (Part One)	Joseph Caezza	16
♂	ORA PROJECT REPORT for May:	Mark Stavish, M.A.	20
	A Qabalistic Guide to Lucid Dreaming and Astral Projection		
♂	An Interview With Dolores Ashcroft-Nowicki (Part One)	Mark Stavish, M.A.	26
♂	Video Tape - Update	Rick Grimes	32
♂	Resources	PON	33
	Cover Photo: The Comet Hale-Bopp	NASA	Cover

Editor-in-Chief: Rick Grimes; **Production:** Le Philosophe Inconnu

Published six times per year by The Philosophers of Nature

Price: \$5.00 US

THE PHILOSOPHERS OF NATURE

125 West Front Street, Suite 263, Wheaton, IL 60187 USA

Tel: 630.682.3938 Fax: 630.665.2364

Email: alchemy@mcs.com Internet: <http://www.mcs.net/~alchemy/>

A Message from the President

by Russ House

The Philosophers of Nature is making progress toward the mission statement that we announced in Issue 17. We explained that our purpose is "To serve humanity through the open dissemination of information that genuinely contributes to its evolution, with a particular focus on the Western esoteric tradition, Alchemy and Qabala."

Since this is a rather general statement, we also defined a mission with more tangible goals for the next few years, which is "To conduct any and all activities in harmony with our values, beliefs and purpose, that ensure our continued service. By the year 2000, we will have become known to 10,000 individuals through lessons, seminars, newsletters, videos, lectures, publications, Internet publishing and other means. In the next 2 years, we will distribute some materials in other languages besides English and French."

One of the most recent milestones toward the accomplishment of our mission was our participation in an upcoming television program. We were contacted in March by a segment producer for the "Ancient Mysteries" series to ask that we represent Alchemy today. This program should be broadcast not later than late summer this year, and we suggest that you watch for it on the Arts and Entertainment network.

During a filming session of more than 6 hours, we demonstrated the process of a dry distillation of a metallic acetate, as an example of a classical alchemical experiment. We think that the visual impact of this process will prove interesting to viewers, and lend credence to the Philosophers of Nature as an association for practical studies in Alchemy.

We were given an excellent opportunity to talk about the Philosophers of Nature, the nature of the courses, and our objectives as an association. We believe that we presented the association successfully, although we will have to wait, along with the rest of you to see how well the writer/producer treats the material.

Sue spoke on the 'feeling' aspects of Alchemical practice in contrast to its purely 'technical' aspect.

Our biggest technical problem was the need for frequent retakes due to passing cars and planes, and the birds that couldn't read the "Quiet On Set" signs. The quality of the production should be excellent, as the crew and equipment were first-rate (the camera alone cost over \$80,000). The segment producer was well researched and went to great lengths to help assure that the message presented will represent modern alchemy in a credible way. One of our main objectives was to help bridge the gap between modern alchemists and the general public. Our interest was to present alchemists in a way that helps to remove the image of 'deluded irrational gold-makers' and to present alchemists as normal people who use alchemical practice as a tool for self-discovery and spiritual development. I believe that our members will be pleased.

We anticipate that this television program, and the subsequent video sales, will present us to an audience many times larger than the 10,000 that we hoped to reach by the year 2000. We also believe that it will lead to other opportunities to express our ideas through the popular media in the next year.

I would like to share an idea that can help each of our members and readers: if you set out to accomplish something in the proper manner, you can, even if you find that you have set your sights on the stars. This is often said, but little understood. How do you think we got the PON on television? We didn't call anyone - they called us. People who are playing crucial roles in our other mission-related work "just appear", as necessary, as if by magic. How does this work?

The members of the present board agreed upon and wrote down the ethics and values which they shared and which would set the limits of all thoughts and actions. Writing things is in itself a magical act - it will tend to "fix" energies. (The term *grimoire* shares common roots with the word "grammar".) Then we formally established a guiding purpose, and a specific mission in a similar way. All of these were linked together and coherent, with no conflict of purpose or intent. This was done in the utmost sincerity of purpose, with acceptance of

the responsibility for action and work that was necessary. In this way, a spiritual condition was created in the inner worlds, that continually encourages manifestation in all lower worlds. This is, simply said, an act of Magic. It can be done without robes, wands and incense, but not without will, love and strength of purpose. It was done with respect for the freedom of individuals and within the possibilities of Nature's law. If our actions, thoughts and desires are in accord with our beliefs, then we will continually strengthen our common visualization, and have an easier time with our work.

I share this, because it is easy to pass by such a simple formula, and to look for something more elaborate and effective. I am sure that everyone has a goal, an achievement that they would find very fulfilling and rewarding. For many, there is an underlying lack of confidence, a feeling that their dreams are out of reach. They do not want to share their dreams with others, for fear of ridicule, of being told that they are a dreamer, and need to accept the limits of their reality.

At least share your dreams with yourself! Have a dialogue with yourself and you may find that you are already carrying with you all of the fears and doubts that you think others would use to try and convince you that you cannot have what you want from life. If you don't have time to talk to yourself in your oratory, do it in your car or in the bus on the way to work, or when you are doing the laundry. Persist until you have the confidence to share your dreams more openly. Years ago I was an aspiring blues and rock guitarist, and one of my dreams was to perform with Buddy Guy and Junior Wells, two of the leading Chicago blues musicians. It was a rather remote dream for a small-town boy in Kentucky. Eventually I ended up living in Chicago, and decided to share my dream with the musicians themselves. As a result I was invited to meet Eric Clapton, another of my heroes, at Buddy Guy's club, during a jam session they had scheduled. Two weeks later, I performed on stage with Buddy Guy and Junior Wells for a 45 minute set. It is still one of the fondest memories of my life. It is normal to have fears about realizing one's dreams, but it is possible to have an ardent desire that will overcome all obstacles... don't let your present circumstances and challenges get in the way.

Whether you want the Philosopher's Stone, or to know your Inner Master, you must do something about it. Perhaps the best formula is in our traditional closing, in its admonition to pray and work. You will understand more if you realize that every thought and dream is a *prayer*, and that every choice and action is *work*. With this, we say,

ORA ET LABORA!

Russ House

ABOUT THE STONE

The STONE provides a forum for articles (5000 word maximum), conference announcements, research summaries, and other items of interest to PON members and our subscribers. Authors should, if possible, submit manuscripts as an email attachment to:

turpen@starnetinc.com

Use a plain text (ASCII format) or mail them on disk along with unmarked, printed copies to:

Rick Grimes - Editor

The STONE

800 N. Clark Street #317

Chicago, IL 60610 USA

Phone: (312) 654-1766

Fax: (312) 225-1371

Publication decisions are normally made within four to six weeks. Selected articles from *The STONE* will be republished on the PON Internet site at the discretion of the editors.

The STONE is published every two months, and is normally mailed on the 2nd Monday of the odd-numbered months.

Subscriptions to *The STONE* are \$30.00 US per year for non-members, and are free to active members. Membership dues are \$30.00 US per year. Subscriptions are for January through December - all back issues for current year are sent to new subscribers. Add \$10.00 for foreign postage. Make payment by credit card or by check drawn on a bank with a US branch.

Send all inquiries about subscriptions or membership to:

The Philosophers of Nature

125 West Front Street, Suite 263, Wheaton, IL 60187

USA

Email: alchemy@mcs.com

**THE 6TH ANNUAL
PHILOSOPHERS OF NATURE
CONFERENCE
JULY 17-20, 1997**

Franciscan Center at Mount Saint Francis
Colorado Springs, Colorado

CONFERENCE LECTURERS

JEAN DUBUIS, the founder of Les Philosophes des la Nature, and author of the courses of the Philosophers of Nature, will present the theoretical background and methods from the new course in Esotericism that he is developing. This will be Jean's 9th trip to the U.S. for the PON.

CURT KOBYLARZ-SCHMIDT, a chemist and alchemist, and Director of Research for the LABORA Project (Laboratory Alchemy) will speak on Alchemy in the metallic realm.

JOHN REID, III, author of *The Minor Opus*, a work on Plant Alchemy, will speak on practical alchemy.

MARK STAVISH, Director of Research for the ORA Project (Occult Research and Application) for PON will speak on practical esoteric and Qabalistic practices.

REGISTRATION INFORMATION

REGISTRATION AFTER MAY 15:

(We suggest that you send a deposit of \$100.00 immediately, to reserve your place)

Members: \$425.00.* Non-members: \$475.00

FOR COUPLES:

Add \$190.00 to the price above for a couple if either registrant is a member; for non-members, add \$210.00

* **NOTE:** A member is an individual who has paid annual dues of \$30.00 through 12/31/97.

FEES INCLUDE FOOD AND LODGING. Rooms are double occupancy with some triple occupancy available.

ROOM ASSIGNMENTS are on a first come, first served basis. All roomsq are non-smoking. The maximum number of registrants will be 100. There are accommodations for 70 persons on site.

TO REGISTER, send the enclosed registration form to:

The Philosophers of Nature "CONFERENCE"

125 West Front Street, Suite 263-w

Wheaton, IL 60187 USA

Tel: 630.682.3938 Fax: 630.665.2364

**SEMINAR LOCATION AND
TRAVEL INFORMATION**



THE FRANCISCAN CENTER is less than 30 minutes from the Colorado Springs airport. For directions, please call the center:

Franciscan Center at Mount Saint Francis

7765 Assisi Heights, Colorado Springs, CO 80919

Tel: 719.598.5486 Fax: 719.260.8044

LIMOUSINE SERVICE is available from Pikes Peak Limousine, Tel: 719.577.4486.

CAMPING may be available at the scenic Garden of the Gods, Tel: 719.475.9450

INTERNET RESOURCES:

Travel information is available on our web site, at <http://www.mcs.net/~alchemy> as well as any updates to the seminar program.

CONFERENCE SCHEDULE ON FOLLOWING PAGE.

***WE HOPE TO SEE YOU IN COLORADO ...**
and we hope you enjoy the articles from lecturers Curt
Kobylarz-Schmidt and Mark Stavish in this issue.*

CONFERENCE SCHEDULE

Note: The Philosophers of Nature reserves the right to make necessary changes in this program. Unforeseen circumstances may result in the substitution of a presentation topic or speaker. Any program updates will be made available as known. This schedule is accurate as of 5/7/1997.

DAILY BREAKS will take place around 10:30 AM and 3:30 PM, in addition to ample time for meals and relaxation.

WEDNESDAY, JULY 16

2:00 - 9:00 PM -- The grounds are open for arrivals.
6:00 PM -- Dinner (must reserve at time of pre-registration)

THURSDAY, JULY 17

8:00 AM -- Breakfast
9:00 AM -- Registration, Introductions of Speakers
9:45 AM -- Jean Dubuis: The Portae Lucis Path in Esotericism
12:00 Noon -- Lunch
2:00 PM -- Mark Stavish: Topics on Practical Qabala
5:00 PM -- Free Time
6:00 PM -- Dinner
7:30 PM -- Mark Stavish: Topics on Practical Qabala

FRIDAY, JULY 18

8:00 AM -- Breakfast
9:00 AM -- Jean Dubuis: The Portae Lucis Path in Esotericism
12:00 Noon -- Lunch
2:00 PM -- Curt Kobylarz-Schmidt: Topics in Alchemy
5:00 PM -- Free Time
6:00 PM -- Dinner
7:30 PM -- Curt Kobylarz-Schmidt: Topics in Alchemy

SATURDAY, JULY 19

8:00 AM -- Breakfast
9:00 AM -- Jean Dubuis: The Portae Lucis Path in Esotericism
12:00 Noon -- Lunch
2:00 PM -- John Reid, III: Topics in Plant Alchemy
5:00 PM -- Free Time
6:00 PM -- Dinner
7:30 PM -- Open Forum with Board of Directors of PON,
Questions and answers on courses and research.

SUNDAY, JULY 20

8:00 AM -- Breakfast
9:00 AM -- Jean Dubuis: The Portae Lucis Path in Esotericism
11:15 AM -- John Reid, III: Topics in Plant Alchemy
12:00 Noon -- Lunch
1:00 PM -- Wrap-up, announcements, and farewell
2:00 PM -- Closing of Conference

An Interview with Curt Kobylarz-Schmidt

by Rick Grimes

Curt is the Director of Research for the Philosophers of Nature LABORA Project (Laboratory Research & Application). Curt's vast experience in laboratory Alchemy along with his traditional background in Electrical Engineering, Chemistry, and Quantum Physics makes him a most unique individual. I can personally verify that, as I've known Curt for over twenty years; we studied together with Frater Albertus at PRS. For those of you attending the upcoming seminar in July 1997 in Colorado Springs, Curt will make a positive impact not soon forgotten. I interviewed Curt on April 10, 1997.

RG: Curt, I know that you are a rather multi-dimensional being, and I think that our readers may not realize the extent of your varied interests and background. Please tell us a little about yourself.



Curt Kobylarz-Schmidt in his laboratory

CKS: Well, my life has had turns of event that sort of led me in different directions that I never planned. I was born and raised into the Roman Catholic faith, and was fortunate

to be exposed to the Church Mass and Rituals when they were all in Latin, and more likened to Ceremonial Magic and more mystical in nature than today. I was an altar boy, went to a Catholic Grade and High School and had to learn Latin which is a good root language. At thirteen I started formal piano lessons and also began playing a pump reed organ at my elementary Catholic school. I only mention this first to let people know where I am coming from; that the balance of Arts (music) and Science were important in my life as they are today. In my opinion, one without the other leads to an unbalanced personality; you can't be just right- or left-brain dominant.

At eleven my interests expanded to include science, photography, and electronics. By the age of thirteen I started questioning all I had been taught when I saw that my parents (and others) would simply do as *they* were taught without questioning anything. I would sit in the woods and try to determine the 'rightness' or 'wrongness' of what I had been taught. Later on, I discovered this type of prolonged thinking was called 'meditation'.

In high school a few of the girls were into Astrology but I was so much into science that I didn't see it as being scientific or logical enough to value study. I have to laugh at myself now, because at my 20th year class reunion I explained the scientific proof of Astrology to these same women.

Around the age of 19 I began to study the writings of T. Lobsang Rampa. I noticed that many of the Astral Projection experiences he described were similar to psychedelic experiences I had previously. This led me to a man who introduced me to Astrology and the basics of chart construction and interpretation.

From there I began the study of Magic, The Golden Dawn, Franz Bardon, Aleister Crowley, Dion Fortune, Israel Regardie, W.E. Butler, and Gareth Knight, which led me to the study of the Qabala. Via correspondence I had with Israel Regardie I discovered practical Alchemy. Following his recommendation I contacted Frater Albertus at the then Paracelsus Research Society, obtained his book and other publications on Alchemy, and started doing the lab work at

home. It took two years to finish my degree in Electrical Engineering before I could attend the PRS classes.

By the time I attended the PRS Prima Class, I had already prepared plant tinctures, and started on a plant stone. Interestingly, Frater came to me in a dream a week before I attended the first class. The new students never saw him until he arrived at 8:00 AM for the very first class session, and I was shocked to see the man from my dream; I had already met him and didn't know it.

When I returned from Prima class (with a ton of Alchemical texts he allowed the students to remove and Xerox at the local University, including the works of Basil Valentine), I was working in the lab day and night (when I wasn't working my day job as an engineer). At the PRS I made close friendships with experienced students who would answer my questions, which helped me advance faster (Frater's once-a-year class wasn't enough for me).

Later that summer, while visiting a fellow Prima student in Michigan, I met Carl Stahl of Bay City, Michigan - an excellent Alchemist and one of the worlds top Sidereal Astrologers. An author of self-published books and a monthly newsletter, Carl also

generated the earliest Ephemeris of the planet Vulcan. I called Carl about every other week filling notebooks with information I haven't yet tried. Carl could get the oils of all the metals effortlessly, and was the only person who had successfully made the Firestone from Antimony. He transmuted a silver coin to gold over a Bunsen Burner in front of me and a few others one summer. He also introduced me to reproducing any Alchemical/Spagyric substance using a rain water Archeus blend and simple digestion. One summer he had extracted over 18 gallons of an extract from one piece of licorice root weighing around an ounce (28 grams or so) and using a Soxhlet extractor. Carl told me the extraction was carried on for around 6 months, but eventually he got tired of having his equipment tied up. He said that apparently it could go on forever. I still have a pound of his extract of licorice, a black, sweet resinous substance when dried.

Thanks to my wonderful friends and my lab efforts, Frater Albertus allowed me to go to two classes each year instead

“Carl [Stahl] could get the oils of all the metals effortlessly, and was the only person who had successfully made the Firestone from Antimony. He transmuted a silver coin to gold over a Bunsen Burner in front of me and a few others one summer.”

of just one. So, over time, I also met many other students in those classes. In 1971 while in Santa Monica I re-met Bill Van Doren, who had been in my PRS Prima class, and he informed me that translated lessons from the French Philosophers of Nature were available. I inquired, and the rest is history.

Actually, about 5 years ago after studying with Native Americans, attending sweat lodges, vision quests, a Sundance, and numerous other rituals, and 2 years with a Qi-Gong Master, who spoke only Mandarin Chinese, something suddenly awakened and it all made sense to me. I guess if you shake someone hard enough and long enough, something will happen. I'm just one of those late bloomers.

RG: In metallic alchemy, what, in general, are the main paths as you see them?

CKS: By metallic alchemy I believe you refer more specifically to the the Great Work, the production of the metallic equivalent of the plant stone. Well, so far we know that there is a so-called Dry Way and a Wet Way. This is the Ying / Yang, Female /Male, Negative/Positive way things polarize in this physical 3-D manifestation. All of Alchemy (and Chemistry) is really based on this principle. In Chemistry it is called "Equilibrium". The Alchemical picture is more complex, since multiple energy sources are considered other than *just* the physical (Alchemy was first, before Chemistry; the problem with Chemistry is mainly with Academia - if you can't measure it with current technology - then it doesn't exist; tomorrow it may if a new gadget/analytical tool appears). Anyway, everything is based on the equilibrium or ying/yang of Water \rightarrow H₂O \rightarrow H-O-H \rightarrow (H+) (OH-). The (H+) is the acid/*Wet* way, and the (OH-) is the alkali/*Dry* way. Note that both ways will use liquids at some point - the *Wet/Dry* referring to the method used in the end when the substances are mixed to get a final result - the *Wet* way employing liquids (including oils), and the *Dry* way utilizing all dry powders/salt

An example of a *Wet* way would be the way of the acetates (using acetic acid), and an example of the *Dry* way would be the method I showed at the 1996 seminar using an ore (Realgar) and a fixed alkali salt I theoretically called

Potassium Deuterioxide (KOD), which I have recently discovered does really exist in the books (in European sources).

RG: I know that you are an officer of a dowsing association. Can you tell us something about your involvement, and how you have used dowsing in Alchemy and in other fields?

CKS: I have been the president of the Orange County, CA Chapter of the American Society of Dowsers (ASD) with main headquarters in Vermont. It's kind of a position I 'fell' into (I never ask for these things), but it turned out to be very valuable for me. My favorite dowsing device is the pendulum, and then the (Cameron) Aurameter. I use dowsing to determine things such as times to start, ratios of substances to mix, proper pH's, heating temperatures and durations, etc. I find it especially useful to determine what tinctures to use for a particular purpose, how much, how frequently to take, and how long to use the substance in

"I plan on teaching Dowsing basics at the upcoming seminar in Colorado Springs (1997), as Jean Dubuis has mentioned the use of Dowsing occasionally as a means of tapping your higher sources."

question. I plan on teaching Dowsing basics at the upcoming seminar in Colorado Springs (1997), as Jean Dubuis has mentioned the use of Dowsing occasionally as a means of tapping your higher

sources. Dowsing, like all other esoteric training methods, are simply crutches that we use for a while and then eliminate. In dowsing, we try to reach the state of what is called "deviceless" dowsing, which is the step next to a increased awareness or intuition. I have noticed that as I used the pendulum more and more, I noticed a certain 'feeling' before the pendulum started to move, and so eventually all I had to do was ask the question and observe the 'feeling', and thus not even need the pendulum. Everything is merely a 'crutch' we use until we are 'healed', and then we discard the 'crutch' (or training wheels).

RG: Do you think the chasm between alchemy and traditional science will be reconciled?

CKS: Of course! It's a natural process of evolution, and the fact that everything really comes from 'inner planes' or 'inner dimensions', meaning that we are really just receivers of inner thoughts and make them manifest in physical matter. All of science is advancing so fast, especially in the realms of Chemistry and especially Physics, that a lot of the

old theories are being publicly and openly blown apart and admitted as wrong (the scientists of the newer generation are openly honest). A good low-cost magazine to watch for these changes is Scientific American in the United States. The publication Nature is really at the top of the list, but is very expensive, and all the exciting releases are republished in the above mentioned and a lot of other publications. I kind of see my purpose here as attempting to do that very thing, since I am involved in the sciences and Alchemy, and it was my going back to school for Analytical Chemistry that opened a bunch of doors in Alchemy, especially Quantum Physical Chemistry.

RG: How does traditional chemistry aid you in your alchemical research?

CKS: As mentioned above, Analytical Chemistry and Physical Chemistry (the Physics branch of Chemistry). I have little use for Organic Chemistry, especially in the synthesis of compounds, as they are not natural and don't follow the ways of nature for the most part. But there is always good in anything, and the structure of organic compounds is very valuable, and how they react with other things. Some of the older synthesis methods are valuable, especially the condensation methods of alcohols and ketones. If you know the Alchemical methods, and have worked on them for a while like I have, and then go back to studying Chemistry as I did, you will recognize things you never would have recognized the first time you studied it, as it was all too new to you. It's like a good book that you read and re-read, and every time you re-read it, you discover new things, new worlds that were there all the time that you didn't recognize.

Again, it all boils down to one thing, *awareness*. The more aware

we are, the more we discover that all the mysteries of life are and always have been right in front of us - all around us; we just weren't aware of them.

The old Chemistry books are very valuable, like the reprint of the 1872 Wagner's Chemical Technology by Lindsay Publications, and that 1771 Encyclopedia Britannica Chemistry section that Carl Stahl retyped and indexed. These are the bridges between old Alchemy and Modern Chemistry, just before they were beginning to change over to modern (synthetic) methods. Natural products and methods were still in use, and they actually show a lot of the Alchemical methods in clearer ways than some of the old Alchemical masters and writers described them. I have gotten a lot of clues from those two books.

RG: Has traditional scientific study hindered you?

CKS: There has really been no hindrance, as I merely ignore what I don't need or find of use. It's just a matter of discrimination. Since Alchemy is in every aspect of our lives, there is no branch of study on this planet where we can't find some aspect of Alchemy operating and then learn something from it. Even basket knitting or weaving shows the aspects of 'pattern' and 'symmetry' - aspects that are

always operating in Alchemy and Life (two names for the same thing). Truth has a way of manifesting in everything, no matter how hard man tries to hide or confuse it; with awareness and discrimination we can find the truth anywhere.

RG: What is the one crucial question you seek to answer through alchemy?

CKS: That's a tough one, as I don't see any one question as especially crucial. The only "one" thing I am seeing more of, is the

RESEARCH NOTICES

HOW TO BECOME ACTIVE IN RESEARCH

If you would like to participate in research in one or more of these fields, please forward your name, address, telephone number, email address, and your specific interests to the research directors:

- **ORA PROJECT** (reports in May & November)
c/o Mark Stavish, Director of Research
P.O. Box 2920, Wilkes-Barre, Pennsylvania 18702 USA
Email address pending - for the present, use:
Email: alchemy@mcs.com Type "ORA" in message.
- **LABORA PROJECT** (reports in January & July)
Philosophers of Nature "LABORA"
Director of Research - Curt Kobylarz-Schmidt
West Front Street, Suite 263, Wheaton, IL 60187 USA Email:
alchemy@mcs.com Type "LABORA" in message.

way the 'old ones' described the "Alchemical / Philosophical Mercury" as 'one substance' that becomes 'the many' by fixation and differentiation, or as we may see it, as energy becoming denser and assuming various forms or energy patterns. Our universe/physical plane of manifestation is basically an electronic one, as all matter is composed of atoms, which in turn is composed of charged (electrical) particles. Particles can become waves and vice versa, and so everything comes and goes out of "light" or photons. The Alchemical Mercury is the only thing I see "one" of; kind of like the statement that there are many paths but they all lead to the "one" source.

RG: Besides dowsing, what other topics do you plan to cover in Colorado?

CKS: Dowsing is one of the things I plan on teaching as a tool that I feel obligated to teach, as another possible lost art that I feel is a very easy to learn method which is very useful for getting in touch with one aspect of your inner self, plus it's just so darned useful for anything one has a question for (and we all should have *plenty* of those).

I plan on covering and emphasizing what I would call "Practical Alchemy In Daily Life" - that is, how to recognize the Alchemy going on all around us, as in our food preparation, identifying the essentials and being careful not to lose or destroy them - but digest them for maximum physical energy.

I will also have additional information on the dry way I showed at the last seminar, some interesting work and discoveries with the Vinegar of Antimony, some work with nitre and how to make a living nitre (potassium nitrate) from Chile saltpeter (sodium nitrate). The Chile saltpeter (NaNO_3) is easily obtainable in a raw, natural form, but the potassium salt is almost impossible to obtain in a raw natural form. This nitre, like the 'vitriols' of metals, comes forth in beautiful long needles (all the 'vitriols' of metals that I have made *always* come out in a long, beautiful, needle-like crystalline form). Also, I believe this to be a method for the very short dry way that is only very occasionally mentioned, but the method I believe all the great

masters used, especially when they traveled, as few materials are needed. I don't know how far I will progress with this method myself, as my business keeps me extremely busy now, and that comes first.

Speaking of work, I will have a particularly interesting showing of an Alchemically produced combination of Colloidal Platinum, Gold, and Silver (which I just recently found out is called "electrum"), and which appears to have what I sense as "etheric superconducting" properties. As usual, I will bring a quantity for all to try and sample. The whole idea IS to raise all our vibrations, and what better way could there be than to do so in a group, with that synergistic effect of a beautiful group mind resonating together for the purpose of speeding up the evolution of mankind (as if it isn't moving fast enough already!).

I also would like to show an easy method for the production of the Spirit of Sea Salt, that I find so

useful, and the preparation of a Living Butter of Antimony that sublimates 100 degrees Fahrenheit *lower* than the chemically produced one (and published in tables), and it sublimates in beautiful crystals that reflect light into a myriad of prismatic spectral light. One way to identify an Alchemical or living product is by its beauty; all the substances I have personally produced (and even those in the classes I teach) are physically beautiful and vibrant in form and color.

RG: Will the beginner in alchemy find your presentation too advanced?

CKS: As usual, I present the material on multi-levels, from the technically correct (for the scientists), to the simplest of explanations, trying to link them all together. Any time I use an apparently complicated scientific term, I explain it and show its derivation as a simple concept, constantly trying to blow away the academic facade of elitism. I speak the language of the scientist so our Art will come out of the darkness of hocus-pocus secret mysticism and strange brews, so that even though a particular student may not understand all the technicalities immediately, it will be there (on the video tapes) for future viewing and

"I will also have additional information on the dry way I showed at the last seminar, some interesting work and discoveries with the Vinegar of Antimony, some work with nitre and how to make a living nitre (potassium nitrate) from Chile saltpeter (sodium nitrate)."

understanding - plus - as our work is mentioned to someone in the sciences, they can view the tapes and see what they are familiar with - spectra of compounds, or chemical equations. This is what I hope to be the beginning of the proof of the validity of our Art.

The Great Ones before us only used the terms and descriptions that were available to them at the time. My only problem is that I tend to talk fast, as I get too excited and have a hard time containing that energy, and in my desire to share and give all that I can, my "cup runneth over" at times. I don't believe in withholding information - there's just too much out there to yet receive and give out, an infinite amount in fact. No need to hold out on infinity. As an aside, I see Jean Dubuis as the PON "infinity contactee", working out of the Sphere of Binah - which is in the Sphere of the Unmanifest, unknowable, and unspeakable - it can only be *experienced* - so as we are all one group soul, we all have access to his experiences - since we are all ONE. I for one, have learned, and have been lead down paths I never imagined, by a single word, or idea he presented to us. It only takes a small key to open a large lock, which in turn opens a door to inestimable glittering jewels of beauty and knowledge.

RG: What are some of the pitfalls you would instruct the beginner in metallic work to avoid?

CKS: That's a difficult one to answer, as there are so many paths in the metallic work. One thing I do strongly suggest that will not only save anyone a great deal of lost time, not to mention minimizing the inherent dangers from accidental poisoning, burns, inhalation of fumes, etc., which is inherent in working with metals, is to do some homework before you work on a particular metal. Study all the physical and chemical properties of the metal and ores and look at the possible combinations. The easiest way is to get a copy of the Merck Index (an old used one is fine), and look up the particular metal, note its properties (what it dissolves in, its color, smell, toxicity, dangerous compounds to avoid that it may form, etc.), and then scan all the compounds before and after it to get an idea of what may or may not be formed. This often clarifies an old Alchemical recipe, and I have often come up with better, higher yield methods, easier purification, etc. by consulting this one book. Another good reference is the Handbook Of Chemistry And Physics (CRC-Chemical Rubber Company; again a used one is fine. Any used book store always has copies of the above mentioned two books). This one is easier to scan for

similar and nearby compounds rapidly. The Merck Index also has tables of what to do in case of accidental poisoning, symptoms, numbers to call, antidotes, and other useful info. As Frater Albertus always taught us, learn the *Theory* first before commencing the *Practice*.

RG: I know how busy you are these days, Curt, so - on behalf of our readers and myself - I thank you for spending some time with us today. We'll look forward to seeing you in July, at the Seminar in Colorado.

⊕



"To those steadfast in love and devotion I give spiritual wisdom, so that they may come to me.

Out of compassion I destroy the darkness of their ignorance.

From within them I light the lamp of wisdom and dispel all darkness from their lives."

Sri Krishna
from The Bhagavad Gita

Alchemical Gardening

by Rick Grimes

The intent of this article is to establish not the *last* word about alchemical gardening, but rather the *first*. By this approach I hope to stimulate an ongoing dialogue within the worldwide scope of *the STONE* so that we may grow in our understanding of natural, lawful, gardening.

Concern about the environment, overpopulation, earth changes, global disease, and a dozen other serious issues, stalk our daily lives. Realistically, what can we expect in 5, 10, or 20 years? It's impossible to say, exactly, but we know we'll need to eat, and we'll need medicines, and we'll need a sound and productive natural world. This is certain.

More specifically, increasing toxicity in our air, water, and soil, which eventually seeps into our food, directly affects our health. Meats and dairy products carry anti biotic residues and hormone growth enhancers; fruits are sprayed; vegetables are radiated; and many prepackaged foods carry propyl derivatives.

In view of these considerations, more and more people are taking the responsibility of augmenting their food resources with back yard gardens, organically grown food, stored food, and "controlled environment" food production such as the biodynamic principles of farming. Yet, I dare say, the vast majority of these well intentioned people are unaware of the nutritional potential of adding *Alchemically* managed food production principles to their methods.

I would hope that those of you who presently produce garden foods, herbs, and flowers, either on a grand or modest scale, will lend your knowledge and experience to this forum. It will make a great contribution to those interested in following your example. So - let's get started, shall we?

What is an Alchemical garden?

One might say that an alchemical garden combines traditional organic gardening technique and practice with Hermetic principles and concepts. The Alchemical Gardener (AG) follows the natural inclinations of their plants by managing them *consciously*. Nature does not reject assistance in creating more perfected products in her laboratory of sunshine, soil, moon glow, and dew/rain. The gardener has only to fully understand the nature of the plant and its relation to these four elements - fire, earth, air, and water.

Plants were not first evolved to feed man, but rather to perpetuate their species. Then, perhaps it can be said, they glory in feeding beasts, bugs, and human beings. An alchemical gardener succeeds by first, acknowledging the plant's particular nature within Nature, and secondly, by understanding its qualities and characteristics - body soul and spirit, and thirdly, by forming an interactive relationship with the plant. Do I mean, *talk to plants*? If that's what it takes, YES! Native peoples do, and they have forgotten more about the spirit of plants than we will probably ever know. One will be well served to commit to these basic principles in the ongoing production of one's food and medicine.

For example, the commercial approach to plant production is first focused on quantity of yield per acre. This approach necessitates an emphasis on faster growth, bigger, heartier produce that will still look good when it arrives at market. But there is a price to pay in the long term as soils deteriorate, losing trace metals and minerals that are not replaced with commercial fertilizers. Most commercial fertilizers infuse the primary plant nutrients into tillable soils, but lack the 40 to 50 additional trace elements that are found in naturally rich virgin soil. In the United States, for example, after 200 years of farming our top soils, and thereby depleting them, these nutrients are largely lost to us today; thus the need for supplements in our diet.

To the alchemical gardener nutritional virtue is a factor, of course, but a secondary one. They will first be concerned with the health of the plants, secondly, with the quality of their reproduction, and thirdly, with their perpetuation *without* diminution. Once these factors are addressed satisfactorily, the AGs will then focus on their plants as food or medicine.

Speaking of medicine, *the best medicine for Man is wholesome food*. An old and wise idea indeed, but how can we combat deficient soil, insects, plant diseases, the plundering of birds and beasts, and still produce a wholesome yield? The answer lies not only in combating such foes externally but also by helping nature fight from within the plant itself. Nature is better at it than we are, anyway.

The secret of our combat is to promote the survival of the fittest by helping nature produce the fittest plant strains through conscious selection. Soils are conditioned by proper preparation, composting, rotation, and recycling. Animal and insect invasion can be reduced through proper

plant association (companion gardening), natural plant sprays, and mechanical devices. Plant disease resistance can be strengthened by augmenting the plant's immune system. Seed selection, soil preparation, natural fertilization, and conscious harvesting all have a direct bearing on plant immunity. Let's start with an example: *The Tomato*.

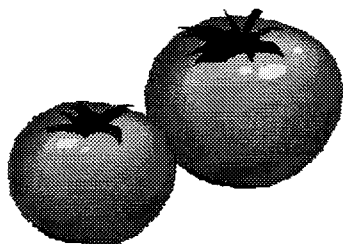

The tomato is a care package for the seeds it contains; it does not know it is food for humans. When ripe, all of the sugars, acids, minerals, proteins, and such as are required for its seeds, are contained therein and in the correct ratio. Should the tomato happen to fall onto poor soil the pulp would provide the proper nourishment to its sprouting seeds, which can then thrive until the roots reach beyond the soil conditioned by the decomposed tomato. At this point the plant is on its own to grow in the surrounding soil. Likewise, the seed kernels are basically the first care package for the actual SEED which is a minuscule vortex of Spirit smaller than an atom.

Soil:

The tomato's soil should ideally contain sandy loams with a mix of ingredients similar to those found in the tomato, plus those additional elements needed for strong stalks and healthy leaves such as iron, potassium, sodium, nitrogen, and so forth. If your tomato bed soil is deficient use the tomato as your guide. They also grow well in any type of fertile, well-drained soil.

Plant Maintenance:

Regularly water, spray with garlic or other organic sprays, weed, fluff the soil, and smile a lot while working. You may wish to play soothing music, sing, chant, pray over your plants, or ignore them altogether (ignoring is NOT neglecting). Then, when you are finished get out of the way, leave them to Mother's care, and just go have a nice cup of spicy tea and watch your garden grow. *There will be*

more practical maintenance tips in the next issue of The STONE.

Harvesting:

Perpetuation of strong tomatoes is accomplished by always saving the best tomatoes from each harvest for SEED - *do not eat them!* Eat the other tomatoes but *never* eat the best and most beautiful examples. The selected tomatoes are then carefully opened for drying.

Separate the seeds from the pulp and dry both in a dry dark place free of dust and pollens. Once the pulp is dry grind it up into powder and save. You can use a coffee grinder, a mortar and pestle, or any other method that will powder the pulp. Skinning the tomato before drying may make powdering a little easier. If the dry pulp exhibits some waxing when you attempt to powder it, do the best you can. The waxing means there is the presence of the plant's essential oil. Sort the seed and remove any that appear deformed, shriveled, or discolored. At the end of the first season you will have enough dried pulp and good seed to plant the following season's crop.

Save all stalks (with roots) and leaves, wash thoroughly and dry, then calcine to a light gray ash. Save for the next season. Prior to reinvesting the ash into your tomato beds, it is good to first mix your ripened compost mulch into the soil. Alchemical principle suggests this be done in the fall in climates that receive vitalized winter snows, while in milder climates one might prefer the early spring *before* the spring rains; personal preference should dictate here. Once

the soil is enriched it is time to add the calcined ash (stalks, roots, and leaves). Note that the ash contains the *charged* and *refined* mineral salts selected by, and prepared within, the plants during the previous season.

“Perpetuation of strong tomatoes is accomplished by always saving the best tomatoes from each harvest for SEED - do not eat them! Eat the other tomatoes but never eat the best and most beautiful examples.”

Mix the ash with enough pure sun warmed water (rainwater that has NOT touched the ground is preferred) to fully dissolve the salts in the ash; if desired the water's alkalinity can be checked with pH paper. This is then sprinkled onto the tomato beds until it has all been evenly applied. The ash residue (caput mortum) that may remain in the sprinkler container, devoid of soluble salt, is then dried and evenly mixed back into the soil.

Technical Notes:

1. The charged rain water will more completely open the salts, especially those salts that would tend to be insoluble in grounded water. The recycled salts attune the soil of the tomato beds with the signature vibration of the previous crop which *includes* your energy. An evolutionary process has begun here. Sunshine and spring showers will add the final touch to your soil's readiness.

2. The ashes should be mixed into the *charged* (ungrounded) rain water in earthen pots set on a wooden table or plastic containers - never metal containers which could ground and thus discharge the water. Always stir the mixture with a wooden stick or spoon, or a plastic stir. Again, if you stir with metal the charge will go through the metal stir, into you, and into the ground. If you only have a metal rod to stir with you might wear rubber gloves or rubber boots to prevent the charge from escaping. We want to put that *divine fire* (the electric charge) into the ash (salt) water that will then carry the charge to the specific ground in which the tomatoes will grow.

Planting:

Follow your own preferences as to planting time. From new to first quarter moon is the preference of many. It is also recommended that your seeds be soaked for 10 to 15 minutes in rain water containing a moon-charged quartz crystal (do not soak in direct sunlight). Soak no more than 20 minutes before planting. The point of this is to augment the spiritual charge to the seed, but not soften their kernels too much.

For climates that experience an early frost date the more experienced gardeners often field plant their tomatoes. Mix and mound the soil in your tomato beds, make a hole with your finger, sprinkle about a quarter teaspoon of red pulp powder into the hole and drop in your tomato seed/s, and press the hole closed. When all the seeds are planted mix the remaining pulp with (rain) water and evenly sprinkle all of it on your tomato beds.

For northern climates that have a late frost date you may prefer sprouting your tomatoes in your house / greenhouse before planting in your beds; this is by far the most common way of working with tomatoes. Simply follow your traditional methods and procedures using the alchemical processes where appropriate. Normally the young plant will survive transfer to the outside beds when they are about eight inches tall. When placed in the beds the plants should have ample room to mature without depleting the soil, perhaps 12 to 18 inches between each plant.

Follow this routine for 7 seasons; selecting only the *best* examples of your tomatoes for SEED. Re-cycle the salts each year, which will increase the potency of your soil, and at the end of the seventh season I suggest you trade about 25% of your tomato seeds with another AG who is also on their seventh season. You want to introduce new, but equally evolved, genetics into your tomato strain. Do this each seventh season so your strains contain the full component of a 7-year cycle. In this way you will eventually produce extremely fit, beautifully nutritious, tomatoes that are inherently better able to resist disease. Generally, you would follow these same principles with your other plants while at the same time following the particular requirements of those plants. By involving yourself in this way you will eventually develop a psychic *feel* for your garden and what's in it.

Following installments will include tips on garden designs, tools, tricks, natural methods of insect control, seed collecting, non toxic disease control, beneficial plant associations, and more. My hope is that much of this information will come from you, our readers and fellow alchemical gardeners. Remember what I said at the beginning; I'm presenting the *first* word on this subject, not the last. We need your help in making this feature a valuable asset for all STONE readers. This is *practical* alchemy at work, and it will be a lot of fun as well.

Rick Grimes

Bibliography: I recommend three books that I like;

- Square Foot Gardening, by Mel Bartholomew - ISBN 0-87857-341-0,
- The Complete Book of Plant Propagation by Graham Clark & Alan Toogood - ISBN 0-7063-7079-1
- The Practical Handbook of Plant Alchemy by Manfred M. Junius - ISBN 0-89281-485-3

Web sites you might enjoy:

- HERBWEB (Tim Johnson) <http://www.herbweb.com/>
- Michael Moore's site:
<http://chili.rt66.com/hrbmoore/ManualsOther>
- Southwest School of Botanical Medicine
<http://chili.rt66.com/hrbmoore/homepage/HomePage.html>
- Life Extension Foundation <http://www.lef.org>
- Biodynamic Gardening
<http://www.tiac.net/users/seeker/biodyn.html>
- Virtual Garden <http://pathfinder.com/vg/>
- BLOOM includes "*The Plant Encyclopedia*"
<http://homearts.com/cgibin/metascr...plantc1.htm+/mktbaner/mplanten.gi>

What do you recommend?



Verdigris, Green Lion and Vitriol: The Basis of the Philosopher's Stone

by Beat Krummenacher

The designations 'green lion' or 'verdigris' are found in many alchemical works. From the context, it often emerges that with them is meant the *vera prima materia* to the philosopher's stone, therefore the true first matter, from which is gained the basis to the philosopher's stone by corresponding processing. This raw material is also often concealed under the household name 'vitriol'. Indeed the semantic fields of these household names vary from author to author, so that often it is difficult to recognize what actually is to be understood by it.

The following remarks should serve to throw light into the darkness of this important alchemical theme. For in reality, one can only work successfully who is able to distinguish these household names from each other in their sophisticated meaning and to theoretically and practically understand them.

Many have understood with vitriol (of the philosophers) the common verdigris. They thought they would not need to cook for long to manufacture the philosopher's stone from it. Only, such practitioners have then cooked longer than they could live, or they have enjoyed from their soup and might have died awfully...

'Verdigris' is a translation from the Latin and originates from 'viride Hispanus', Spanish green. This was the name of an imported inorganic green dye from Spain in the Middle Ages. Then, common synonyms were: Span green, copper green, copper rust, aciniar, viride aeris, flos aeris, fiza, viride prassium and many more. It dealt with green colored copper salts, mostly with basic acetates, also often with sulphates.

Today, one understands with 'verdigris' a poisonous green cover, emerging under the influence of atmospheric oxygen and vinegar fumes on copper or brass, which thus chemically consists of copper acetates. With it the present meaning deviates from the earlier only insignificantly.

The verdigris used in alchemy was often equated with 'vitriol', but has nothing in common with the ordinary verdigris. Was the alchemical vitriol perhaps the 'vitriolum Romanum' of the drugstores? The alchemists often said that

their matter is to be gotten cheaply and simply. This salt, the similarly green copper sulphate, had an important significance in the Middle Ages. And because it was often confused with the related verdigris due to its color and characteristics, it is hardly astonishing that many searched for the 'veram primam materiam' in the 'vitriolo Romano'. Is the answer perhaps to be found in the word 'vitriol'?

The present understanding of the household name 'vitriol' unfortunately brings no enlightenment, because one understands with it iron sulphate as a rule, or in further meaning all bivalent metal sulphates. The derivation of the word is taken from the Latin 'vitrum' (glass). One assumes the introduction of the household name 'vitriol' for such greenish salts because crystalline iron vitriol resembles pieces of broken green glass. 'Roman vitriol' (vitriolum Romanum) was mostly especially called this, cohered with it, as this sort counted as the best green one. It was mainly used for dyeing and consisted basically of iron vitriol, to which alum (potassium aluminium sulphate) was often added. Roman vitriol was identified in the pharmacies and in the Frankfurt's fair list of 1582 as pectone, therefore it was gained through the evaporation of naturally occurring vitriol solutions. Besides that, the 'Goslaric vitriol' or 'German vitriol' was also widely used. This contains, besides its main constituent of iron vitriol, still further metal sulphates.

With it the matter becomes always more complicated, as now we already have a whole palette of applicants for the vitriol of the philosophers. Helpful in the search for the mysterious substance is the conscious enclosure 'of the philosophers' by the alchemists. With it they clearly mark that their vitriol is not the vitriol 'of the common', but that 'of the philosophers', thus it surely cannot be identical with 'Roman' or 'Goslaric' vitriol and/or verdigris in any composition. Likewise, it clearly emerges from this, that the Green Lion can not be iron copper vitriol, as Manfred Junius has taught in his courses.

Then, what was or is the genuine vitriol of the alchemists? We are led more closely to an understanding by trying to understand the meaning of the word 'vitriol'. 'Vitriolum' is a contraction of the initial letters of the following Latin sentence: *Visita Interiora Terrae Rectificando Inveniens Occultum Lapidem Veram Medicinam*. Or in one of the possible translations: "See in the interior of the purified earth, and you will find the secret stone, the true medicine".

Thus vitriol was a code name for the original substance of the philosopher's stone. It should also become understandable with it, that verdigris or common types of vitriol are not the true Vitriol of the Philosophers. This becomes clearer still, if one takes seriously the warnings of fair alchemists, who wrote there among others: "You must take in our work the vitriol of the philosophers, and not the common".

The household name 'vitriol' stands therefore not only synonymously for the Green Lion of the philosophers as a substance, but it is also a symbol for the whole process of the operis magni. This illustrates a copy of the text of the Tabula Smaragdina (Figure 1), stamped among others in: Secret figures of the Rosicrucians of the 16th and 17th century, Altona 1785, p. 17. It concerns a circular emblem, which simplistically reproduces the process to the philosopher's stone, around whose edge the cited Latin sentence winds itself. By the way, it is typical in alchemical works, that the same household name was widely pulled near for different matters or process steps, and conversely an individual matter or process step was illustrated with different names. The alchemists had consciously chosen this action "to forbid the unworthy the access to alchemy", as they said.

Many have thought the alchemists wanting to point to a green salt with vitriol. Thus it only was understandable and obvious to hold verdigris and copper salts, among others, as being the vitriol. The synonymous household name 'green lion' for the Vitriol of the Philosophers points to it also. But this also is misleading. Let us hear what is said about it in Hermes Trismegistus' True Old Natural Way: "The green lion: With green they want to indicate its growth. They call it however allegorically a lion due to its power and intensity, because it is able to kill and to murder everything".

Thus common verdigris or vitriol is not the Vitriol of the Philosophers or their Green Lion, also not the *vera prima materia* of the alchemists.

In fact, it is still more complicated. For with Vitriol of the Philosophers the alchemists marked - taken literally - not only one important substance for the opus magnum, but their two:

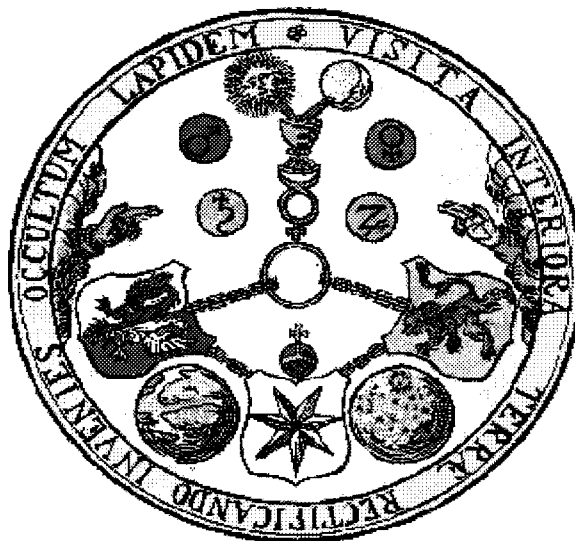

Figure 1

Take a matter out of nature, which the sages have shown you and which is called 'materia remota', 'materia cruda' etc. Thereby, it concerns a mineral which is still quite easily obtained today. Work up this mineral until you arrive at a salt, which is marked as 'first vitriol of the philosophers'. This first dissolution is mostly colorless or easily yellowish. Rarely, it can actually appear greenish- to green-colored, according to the origin of the minerals used. The quite laborious processing steps of the materia remota lead to the purification of the crude earth,

thus it is spoken of the 'terra rectificando'.

Then one must see in to the interior of the purified earth. Another formulation of the essential reaction step, which should be indicated with it, is the following: "Sweep the interior to the outside", or more concretely: "Learn to transform the vitriol into a fluid and an oil through the application of fire". One receives as a product an easily volatile, combustible spirit, the so-called 'spirit of philosophical wine'. This is compared to the ordinary spirit of wine, because it owns similar characteristics, however it is called 'philosophical', since it is much more penetrating. Furthermore one receives further reaction products, which often are marked as 'philosophical vinegar'. Basil Valentine in the chapter 'About vinegar' writes of it: "... I however must announce you this, that this is not the vinegar of the philosophers, for our vinegar is another drink. Namely, the matter itself, for the philosopher's stone is made from the azoth of the philosophers, which must be prepared and be brought in a certain order through the common distilled azoth, also the spirit of wine and other waters before".

Thus the processing of the first vitriol leads to the 'spirit of philosophical wine' and the 'philosophical vinegar'. After that, different salts are treated with their help, whereupon

the 'second green vitriol of the philosophers' is first gained, often truly in the form of a salt.

The reversal of this second vitriol of the philosophers reveals the concealed nature inside there, in the form of the 'philosophical mercury' and the 'philosophical sulphur'. The mercury appears as a pale to yellowish, often milky clouded fluid (lac virginis), the sulphur as a ruby-red oil, called 'blood of the green lion' or 'our philosophical sulphur'. If one finally has together with it both the material foundations of the great work, so the rest is a pure work of nature and not especially more difficult, even if the following process of the mild boiling in the hermetic vessel after the addition of the silver and/or gold ferment may still last for months. In the end the philosopher's stone will be received as the culmination of the whole work, which additionally is the universal elixir or the true medicine of the philosophers.

Considering the above-mentioned remarks, it will be easier to read the texts of the alchemists in their true light. Each may strike it lucky who seriously searches for the true vitriol of the philosophers!



Announcement:

Practical Work on Spagyrics now available from The P.O.N.

In 1994, the booklet:

Spagyric Tinctures - Tradition, Preparation and Use
by Beat Krummenacher

appeared in an English translation by Karin Di Giacomo. The rights have since been obtained by The PON. In this invaluable booklet, the contemporary Swiss alchemist and spagyrist explains the methods of Zimpel, Glauber, Krauss and Heinz, before setting forth his own method of preparing spagyric remedies.

Paracelsus' ideas on the *Arcana*, and important ideas on the polarity of remedies as healing agents or as poisons are developed at some length.

This is a most useful map for finding one's way in the Spagyric realm. We think it will provoke some thinking about one's own practice, and suggest improvements that can be tested for their value.

**The cost of \$16.95 for this ring-bound 49-page booklet includes postage in the US.
See order form for foreign postal costs.**

Yantras and Alchemy

Part One

by Joseph Caezza

Alchemy has been described as the path of accelerated return. All of Nature is a living projection from a Divine center followed by a slow return to the source. The laboratory operator engages in a cooperative participation in this process. The ancient symbol of gold, a circle surrounding a central point, ⊙, testifies to this dynamic impulse of return to creative origin. Laboratory practice remains an exercise of spirit in the finest Platonic Tradition.

Formal Tantric worship utilizes yantras, geometric symbols of cosmic unity, with the same essential intention that an operative alchemist utilizes laboratory apparatus. Yantras constitute refined aids to contemplative discipline. As objects of ritual adoration they embody a most sublime metaphysics that functions to elevate the soul to pristine gnosis. The Sanskrit root "yam" refers generally to any kind of support for energy and the specific term "yantra" refers not only to the well known geometric devotional designs but to various apparatuses used in Tantric Alchemy. A familiar example is the *Tiryak Patana Yantra* used for distilling mercury (figure 1).

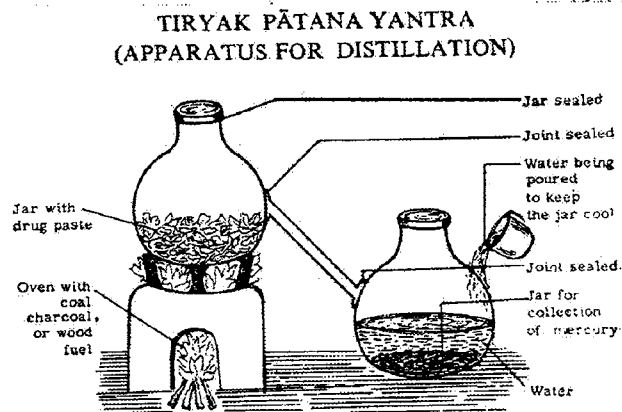

Figure 1.

Another example is the *Dola Yantra* in which crushed gems or metals are tied into a cloth sack and suspended in a simmering liquid (figure 2)¹.

¹Dash, Vaidya Bhagwan; *Alchemy and Metallic Medicines in Ayurveda*, Concept Publishing Co. New Delhi, (1986) pg. 208, 203

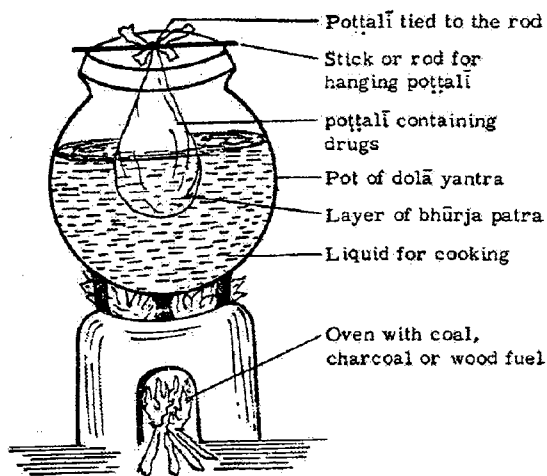

Figure 2.

The alchemical admonition, "Solve et Coagula" refers to the injunction to dissolve and recrystallize matter in order to fabricate an exalted truly Philosophical Stone. Just so ritual yantra practice indicates the dissolution and re-coagulation of the universe until the achievement of the simultaneous identity of these two apparently opposing processes.

Madhu Khanna has authored the most exhaustive contemporary study of this subject in his recently reprinted: Yantra: The Tantric Symbol of Cosmic Unity. Herein he explicates the metaphysical foundation of practice as an amalgam of three principles: the function principle (kriya rupa), the power principle (shakti rupa) and the form principle (akriti rupa)¹. These abstract concepts bear striking resemblance to the alchemical principles of sulfur, understood as "functional consciousness", mercury, as "sustaining substance" and salt as "fixing form" in the cosmology taught by the Hermetic adept R. A. Schwaller de Lubicz to his student Andre Vandebroek. Vandebroek expounds these principles in his memoir, Al-Kemi².

Khanna describes the function principle as the capacity of a yantra to reveal the cosmic truth of human experience and further offer instructional guidance during the natural expansion of psychic force in its evolutionary return. Sulfur

¹Khanna, Madhu; Yantra: The Tantric Symbol of Cosmic Unity, Thames And Hudson, London, (1994) pg. 11

²Vandebroek, Andre; Al-Kemi, Inner Traditions-Lindisfarne Press, Great Barrington, MA.(1987)

"functions" when it burns thus demonstrating the light hidden in dense dark matter. Its yellow color indicates the solar signature of inevitable spiritual destiny.

The yantra power principle actualized by daily ritual reinforcement endows the diagram with life. Vital substance conjures the notion of mercury in its deepest alchemical sense. The principle of mercury grants living metals their evolutionary impulse toward gold. Three dimensional yantras known as "merus" cast out of panchalokam, a combination of five precious metals, are sometimes fabricated with a core of solidified mercury (figure 3).

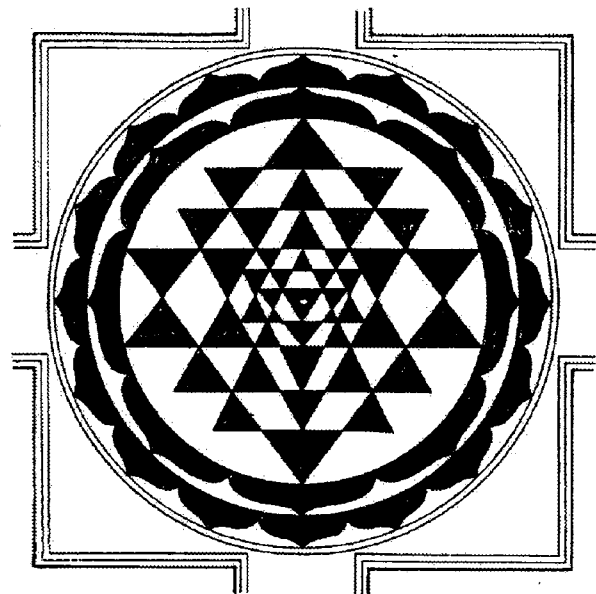

Figure 3.

The form principle of yantras refers to their ability to reveal the inner structure of the diverse aspects of Nature. All natural objects have a gross visible shape and an esoteric geometric form. Alchemy understands "salt" as the repository of form. Evolution of consciousness from stone to light proceeds through the kingdoms of the mineral, vegetable and animal apparently culminating in man. Experience expands consciousness. The perishable forms of Nature in a perpetual sequence of dissolutions and coagulations adapt themselves to accommodate the expansion of consciousness. Lead for example progresses during vast time spans into tin, iron, copper, mercury, silver and finally achieves perfection in gold.

In each kingdom there exists a salt that records experience of continuous incarnations and modifies succeeding forms to adapt to expanding consciousness. In the vegetable kingdom the salt is leached from the ashes of the plant. In man it occurs most abundantly in the thigh bones. Alchemical salt serves as a hook or magnet for volatile mercury and sulfur, the spirit and soul.

Andre Vandenbroeck's *Al-Kemi* exposes the clandestine collaboration between Schwaller de Lubicz and the mysterious alchemist, Fulcanelli. Fulcanelli's highly acclaimed work, *Le Mystere des Cathédrales* (The Mystery of the Cathedrals) explains the Gothic Temples as textbooks of alchemy written in stone but this insight probably originated with Schwaller. Such a possibility appears highly credible considering Schwaller's later work on the architectural symbolism of the Egyptian temple at Luxor. Due out in early 1997, the long awaited release of the English translation of Schwaller's magnum opus, a two volume set, *The Temple of Man*, the result of 15 years of on-site study at the Luxor temple reveals Egypt's deepest esoteric wisdom. Its launch has been heralded as the publishing event of the decade. Both Gothic Cathedrals and the Luxor temple share common features that symbolize mans unfolding spiritual evolution. Yantra metaphysics saturates the presence of the great Gothic Cathedrals from their foundation architecture to more familiar instances for example the rose window of Notre Dame and the Chartres Maze.

Madhu Khanna's study contains an entire chapter devoted to architectural yantras. He stresses that such yantras function not as blue print ground plans for temples but rather schematize the metaphysical principles upon which temple construction takes place. Stella Kramrisch's monumental two volume set, *The Hindu Temple*, constitutes the most exhaustive study to date on this subject. Lama Anagarika Govinda outlines his tradition's application of these same principles in his *Psycho-Cosmic Symbolism of the Buddhist Stupa*. However Adrian Snodgrass's two volume *Architecture, Time and Eternity* takes its place as the finest analysis of the esoteric principles supporting sacred buildings from every major planetary tradition. His work firmly oriented on a foundation of the Platonic doctrine of symbolism deserves the attention of anyone seeking a deeper understanding of alchemical metaphysics.

Each Hindu god is thought to have a distinct yantra that embodies its subtle form. Certainly the most famous visual

image in all of Tantrism remains to be the Sri Yantra (figure 4) which serves as a manifestation of the Great Goddess. Sri Yantra is thought to contain all other yantras within itself.

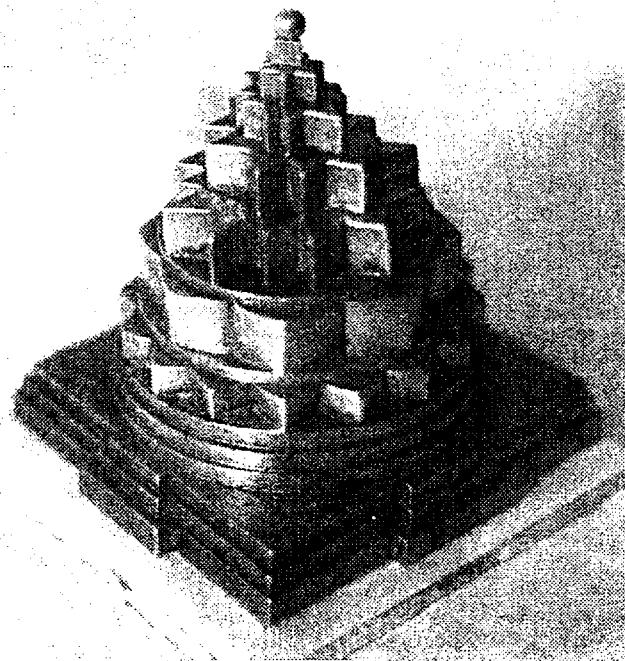

Figure 4.

The Sanskrit scripture, *Yoginihrdaya* declares: "When She, the Supreme Shakti, out of her own will assumes the form of the Universe, observing her own self effusion, the Sri Yantra is born." The scholar Douglas Renfrew Brooks interprets this: "The Sri Yantra represents the process by which the originally unified, undifferentiated divinity assumes the binary character of masculine and feminine, Siva and Shakti, and creates the universe through an on going process of devolving particularization. The Sri Yantra not only represents the process of creative devolution but its actual form. It symbolizes the universe's primordial structure and at the same time, the index of reality that forms its structure"¹. Creation thus remains the essential form of the Great Goddess. Is this an echo of such Hermetic models as the Qabalistic Tree of Life or the Golden Chain of Homer? Could alchemy be the direct personal perception of creation as ongoing revelation?

¹Brooks, Douglas; *Auspicious Wisdom*, SUNY Albany, NY (1992) pg. 115

Could alchemical laboratory manipulations be like the Tantric ritual hand gestures, mudras and nyasas, an attempt to make this perception into an actual tangible reality? Hortulanus in his commentary on the Emerald Tablet explains: "Our stone is made the same way the universe is created".¹

The Sri Yantra (figure 4) in its three dimensional meru appearance as a series of stacked plates (Figure 5) embodies a dynamic perception of creation as ongoing revelation.

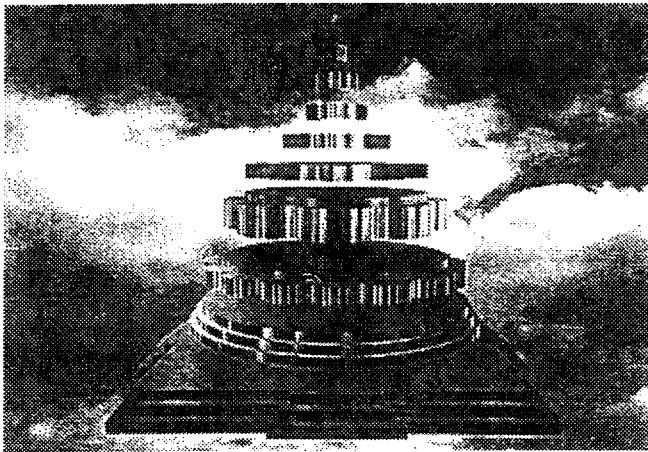

Figure 5.

The square base represents the earth element. Succeeding lotuses correspond to water and air. Then a series of triangular plates describe fire and the more ethereal varieties of substance approaching the undifferentiated bindu apex. An elaborate correspondence between these elemental levels and the chakras pierced by the rising kundalini bridge the gap between theoretical ritual practice and actual contemplative experience.

Sri Yantra's essence of nine intersecting triangles constitute two of the most fundamental cosmologic functions, creation and dissolution, well known in the alchemical dictum, solve et coagula. The Sanskrit scripture, *Yoginirhridaya*, declares: "The five downward pointing shakti triangles identify creation (coagula) and the four upward pointing shiva triangles identify dissolution

(solve)". The schematic interlocking of the process evokes the revelation of continuous creation.

The practical daily utility of the Sri Yantra involves its use as a contemplative aide in exhaustively elaborate rituals. One hundred and eight goddesses populate specific locations on the yantra in a generally clockwise spiraling path to the center. Systematic worship of each goddess from the outer square perimeter to the undifferentiated central seed source comprises the method of dissolution, *samharakrama*, (solve), whereas the alternative method of tracing the creative process from the center outward is known as *srstikrama*, (coagula). Daily ritual practice over the course of months and years inscribes a pattern of cosmic reintegration into the psyche of the devotee until experiential Gnosis of Genesis dawns unsolicited.

In 1994 I traveled to the village of Devi Puram just outside the metropolis of Anakapali in the state of Andhhara Pradesh, India for the dedication of a unique temple built in the form of a Sri Yantra meru. (Figure 6)

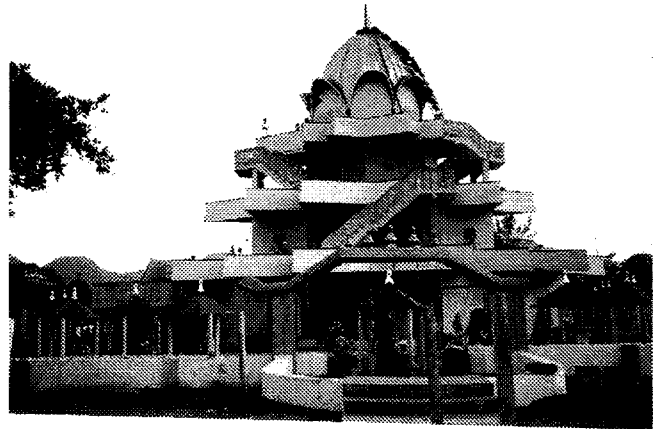

Figure 6.

The square base measures 108 ft by 108 ft and rises to the height of 54 ft in 3 stories. One hundred and eight life-size statues of the various erotic forms of the goddess have been placed at strategic locations within this temple to depict the natural sequence of creative regeneration.

This temple had been built under the guidance of the living saint, Sri Amritananda, formerly known as Dr. N.P. Sastry, a nuclear physicist, who's spiritual visions instigated the revival of Tantric worship in this far off the beaten track location. Amritananda had initiated me into the most

¹ <http://www.levity.com/alchemy/hortulan.html>

superficial aspects of this tradition a few years earlier. A story is told about how one of his chief assistants, a man named Pratap, was one day fashioning a small meru out of an amalgam of mercury when to his surprise the entire mass mysteriously transmuted into gold. Such an unprecedented phenomenon endorses the fundamental homology between yantra worship and alchemy.

After performance of ritual yantra worship the air hangs heavy with the scent of fresh flowers, incense and camphor offerings. A proud priest may explain his ability to bring the Goddess down to earth. Potent vibrations of spiritual energy characterize a momentary field of force as celebrants indulge the vague notion of "sacramental grace". The alchemist on the other hand upon executing a magnum opus has fabricated in his laboratory a tangible artifact, the red stone, who's power to transmute base metals into gold and heal the sick bears living testimony to what good Catholics still call "actual grace". Hermes in his Emerald Tablet declares: "Her power is greatest if it be changed to earth". Both gestures indicate the undeniable unity behind the diversity as all of Nature, a living projection from the Divine center, reintegrates into its source.

*Part Two of Joseph Caezza's Yantras and Alchemy will appear in the next issue of **The STONE**.*



ORA PROJECT REPORT

A Qabalistic Guide to Lucid Dreaming and Astral Projection

by Mark Stavish, M.A.

Director of Research, *ORA Project*,
The Philosophers of Nature (PON)

Copyright 1997 Mark Stavish. All Rights Reserved.

Mark Stavish, M.A. holds degrees in Theology, and Counseling, and has been studying and practicing esotericism for over twenty years. He is the Research Director of ORA, the Occult Research and Application Project of The Philosophers of Nature, and his writings have appeared in numerous occult, New Age, and magical publications. The author welcomes responses, comments, or criticisms, of this article, as it is a "work in progress". Personal experiences are most welcome.

Individuals who would like to participate in research projects involving alchemical, qabalistic, or hermetic orientations may contact the author at: P.O. Box 2920, Wilkes-Barre, Pennsylvania, 18702. Research results will be published in The Stone, and be made available to all participants.

Introduction

The projection of consciousness has been an integral part of Qabalistic teachings, from the *Merkavah* (Chariot) Riders and their journeys to the starry Palaces (*Hekelot*) of the invisible world, to Traveling in Spirit Visions with the early adepts of *The Hermetic Order of the Golden Dawn* in the 19th and early 20th centuries. While a wide variety of approaches has been formulated to assist the disciples of these diverse schools, much of their techniques require an extensive amount of preparatory teachings and/or ritual assistance. For those who have little or no knowledge of traditional 10-12th century *Merkavah* doctrines, or no interest in learning the necessary signs, symbols, and invocations for Golden Dawn style techniques and their 'spin offs', yet want a Hermetic approach to their inner world, there is a solution. It is also simple, direct, and does not require an extensive amount of visualization or creative imaging.

The following experiment was carried out over a three month period, from December 1996 to February 1997. During that time, no additional ritual methods were performed, either for personal development, or in a group, in order to assess the value of the technique as it stood alone. The majority of the experiments occurred at night before going to sleep, and about half the time in the morning upon waking while still in a borderline state.

It is designed for those who would like to have an 'out of body experience' but lack either the necessary visualization skills required of so many of the present techniques, or who have had violent experiences leaving their body, and would like a more gentle approach to the astral planes.

It can be carried out by either the experienced 'traveler' or the beginner with equal ease and, possibly, similar results.

Theoretical Background

The theoretical background behind this experiment is strictly Qabalistic, and is applicable to either the traditional *Tree of Life* (Golden Dawn), the revised *Tree of Life* as

applied to the *Portae Lucis* material¹, or the Palaces as outlined in the *Sepher Zohar*. In short, any systematic outline of the interior body-world of humanity can be applied, as long as it has concise easy to visualize symbols for the various planes of consciousness.

The working assumption is that we as conscious beings originate in the *Ain Soph Aur*, or Limitless Mind of God. We incarnate through various stages of increasing density and matter, into the present world, in order to gain the experiences that will allow us to go from 'potential beings' into Self Actualized, or Self Created Beings. In our journey of development we take on characteristics and 'bodies' of various vibrations, and on our 'return' we shed these bodies in exchange for increasingly subtle bodies and worlds of Light. These Worlds are categorized in the Gnostic, Qabalistic, Hermetic, and Alchemical texts under different names and numbers, but share the same essential qualities and functions overall. That is, they go from the most dense world of material Earth to the most subtle of Infinity, or the point of our origin, the Mind of the Creator.

Within our physical body we have various organs of psychic perception called psycho-spiritual centers in modern Western esoteric nomenclature, and *chakras* in Sanskrit. These centers correspond to several levels of our physiology. That is, on just one level, our nervous system and plexus, as well as our endocrine system of hormone-secreting glands. Other correspondences exist as well, but for our purposes these are the ones used most commonly and efficiently.

Astral projection is often suggested through the solar plexus, but for many this can be an unnerving and unsettling experience. Other suggestions are purely visual, such as rising out of your body like a mist, or as having a second 'body of light' present next to your physical one. It is said that advanced practitioners can project their consciousness at the time of their death through the upper centers, thus 'dying consciously'. The centers suggested here are the top and front of the head, or the "Crown" and "Third Eye" centers, associated with the pineal and pituitary glands. Some even use the back of the head, the medulla oblongata, or brain stem.

¹ Presentation by Jean Dubuis, at the 5th Annual Philosophers of Nature Conference, Colorado Springs, Co. May 20-24, 1996. Mr. Dubuis is currently working to complete a new course.

In the Indian texts, each *chakra* is associated with a particular power (*siddha*), which is awakened in the aspirant, and as such, allows the student to then project their consciousness through the different psychic centers in increasing complexity and subtlety until finally the Crown is reached.

In Qabalistic practices however, the centers are rarely used as such but instead, intense visualization of the ethereal Worlds is used until they are progressively realized, or rituals combined with more generalized energizing of the psychic body are used, either alone or in conjunction with these visualized worlds. The modern variation of this often involves the use of Tarot cards or the Hebrew letters, and is called Pathworking. Eastern Orthodox monks have used intense visualization on the solar plexus, as a small sun, as a method of achieving exteriorization, and some schools use the heart as a center of displacement. However, the previously mentioned methods are the most commonly used to date.

Alchemists use tinctures or medicines to assist in the projection of consciousness. Although these should not be confused with hallucinogenic or psycho-active drugs, the effects of alchemical medicines generally occur when their user is relaxed, sleeping, or in meditation. They, in effect, assist the projection of consciousness. That is, they expand awareness, rather than induce or cause it directly. It is possible to take an alchemical medicine and drive a car unimpeded.

In Eastern techniques, the number of psychic centers attributed to the body vary in number depending on the school in question. In general, it is said that we have at least seven major and five minor psychic centers. Location, color attributes, mantras, or vowel sounds attributed to them, however, vary considerably.²

According to Sri Aurobindo, the throat center is associated with the externalization of mental forces, and the link between the higher and lower mental spheres. Like in some color scales of Qabala, gray is associated with this center.³ In *Serpent of Fire: A Modern View of Kundalini*, Darrel Irving points out that the *Vissudha* chakra is presided over by the dual deities of *Shakini* and *Shiva*. Each is five faced,

²For a very effective and simple approach to awakening the psychic centers see: *Wisdom of the Mystic Masters* by Joseph Weed.

³*Kundalini, Evolution and Enlightenment*, Edited by John White. Anchor Press, Doubleday, Garden City, New York. 1979. P. 83.

representing the five Elements, and three eyes, showing physical and psychic perception, or knowledge. Shakini is seen as Light itself, and Shiva, like the Hermetic ideal, is androgynous, half white and half gold. The center is associated with the purification of intelligence, the psychic substratum or ether (*akasha*), and hearing. The color given is smoky-purple. As with Sri Aurobindo's color, purple is also sometimes given as associated with the throat center in modern Qabalistic works.¹

Along with the remaining upper two psychic centers, these three constitute the only centers whereby *direct psychic perception* is possible.²

In the West, the Throat center is less well defined, although it shares in all of the above named characteristics. In *Kabbalah of the Golden Dawn*, Pat Zalewski states that the throat center is associated with the thyroid gland and controls respiration. As with yoga, each of the preceding centers is associated with an Element, starting with Earth, Water, Fire, and Air. While not stated, it might be presumed that the Throat center is then the first center to be associated with Spirit, or Quintessence, as in yoga.

Here however, we run into a problem regarding the attributes associated with this area. In alchemy, the throat is ruled by Mercury, the god of Air, as well as magic, voice, and initiation. In the systems generally used (i.e. Golden Dawn), no planetary attribute is given to the throat. Instead, it is the sepherothic realm of *Daath* that presides over this region.

Daath is Hebrew for 'knowledge' and maybe that is the best attribute for things associated with the mind, speech, and magic. However, for many kabbalists, Daath is a region better left alone, and feared more than the so-called Qlippoth, or Demonic realms. How did Daath come to be seen with such awe? Mostly from the second-hand reports of book learned occultists repeating what they read. Although, if we keep in mind that *Daath is Knowledge*, then some interesting correlations can be drawn.

Isreal Regardie states:

¹ *The Sword and the Serpent* vol. 2 of *The Magical Philosophy* by Melita Denning and Osborne Phillips. Llewellyn Publications, St. Paul, MN. 1988, pp. 188, 189.

² White. From *The Restored New Testament* by J.M. Pryse. P. 432.

"This central point between two symbolic pillars of the opposites, the place of balanced power from which the working of the opposites may correctly be viewed, is the implication of DAAS [Daath], which is the name of this shadowy Sephirah. Rightly, it *is* shadowy, and the word is used advisedly for in the majority of us who have not cultivated the difficult art of avoiding the opposites, the development of this new principle has proceeded with the utmost slowness. It is a new factor of adaptation or equilibrium, especially between the two broad divisions of consciousness - the ego on one hand with its desire for adjustment to modern life with its refined and non-natural conditions, and on the other hand with the superficial level of the instinctual life, concerned with primitive things, of self-assertion and the unbridled gratification of its every whim and caprice."³

and further on:

"DAAS (sic), the shadowy Sephirah, which develops in the course of evolution as we learn the domination of our mental and emotional propensities, is situated at the nape of the neck. Its position is at a point on the spine just below the occiput, about one or two inches above the larynx, and its diameter may be imagined to be about four inches in extent. It is conceived to be a symbolic link, self-induced, and self-devised, between the higher Genius on the one hand, and on the other, the ego, the conscious self referred to that group of characteristics clustered around TIPHARAS (sic)."⁴

Regardie also refers to Daath as "The Link" between the Higher Self and the ego, or waking brain.

Gareth Knight states that Daath is where 'pure force takes on form'⁵ and that it is "the highest unity in the world of forms"⁶, and "Daath is the highest point of awareness of the human soul regarded as a soul..."⁷

"The Daath powers in balanced function, of course, give the type of person with a mission or sense of destiny who will have sufficient detachment to cut his way through any

³ *The Middle Pillar* by Isreal Regardie, Llewellyn Publications, St. Paul, MN. 1991. P. 113.

⁴ Ibid. p. 116.

⁵ *A Practical Guide to Qabalistic Symbolism* by Gareth Knight. Samuel Weiser, Inc., York Beach, Maine. 1978. P. 102.

⁶ Ibid.

⁷ Ibid.

obstruction to his aims, at no matter what cost, and who has absolutely no concern for what danger the future may have in store; such is his faith in his powers and acceptance of his destiny.”¹

Unfortunately, most of what is said regarding Daath, like the other spheres, is of a cosmological nature, and difficult to apply to our individual consciousness. The abstract ideas associated with it, coupled with vague warnings and trepidation are not directives on how to approach this sphere within our psyche (*and very real* psycho-spiritual, semi-physical center!) in a positive and growth oriented manner.

Possibly what Knight is saying, on a personal level, is that the psycho-physical sphere associated with Daath allows for the highest awareness in human consciousness when it is progressively opened. When this occurs, many of the fears, obstructions, and psychological malfunctions that have previously plagued us, fall away under the intense awareness of our true power and presence as Beings becoming consciously Divine.

In summary, maybe the fears are real, in that once we cross the Bridge of Knowledge, there is no turning back. Once we go from the theoretical to the experiential, we cannot return to ignorance. When innocence is lost, it is gone for good. Thus, we can cross the ‘bridge’ several times: from the material world to the psychic; from the psychic to the more abstract mental realms; and from the mental to the highly spiritual, from which none is said to have returned. Most of what is reported about Daath may be in relation to this last and highest reality.

The function of this technique, is to assist those who desire it, to cross their personal psychic bridge from the visible into the invisible with consciousness and memory.

Mercury, Hermes and the Psychopomp

Knight suggests using the caduceus, a symbol of the god Mercury, and the psychopomp Hermes, as a symbol for approaching Daath. This relationship of the Throat Center to Mercury must not be overlooked, for it is this very relationship that we are seeking to establish within ourselves. To be able to enter into the psychic realms with the aid and assistance of our Higher Genius, as well as our human intellect, and to make use of the information upon

return to waking consciousness. We want, in effect, to do as Hermes does, “Walk Between Two Worlds” and unite them within our psyche.

The symbol for Mercury is the stylized caduceus in the form of the combined symbols of Luna (Moon), Sol (Sun), and Terra (Earth). Combined they state the function of this part of our psychic anatomy. The upturned lunar symbol represents our brain, nervous system, and psychic functioning, resting upon the Solar symbol beneath. The Sun, is our spiritual power, life force, and intuition. It sits astride the symbol for matter, or the equal armed cross. The Cross of the Four Elements is the symbol of material existence, and is at once our physical bodies as well as the material world we live in.

In the symbol for Mercury, we see that the terrestrial energies, or matter, are dominated, by the Solar forces of the Sun, and Soul. However, these spiritual forces are in turn dominated by the intellect and physical brain of man. That is, the brain directs them, or represses them, depending on the spiritual health of the aspirant.

It also illustrates a unique point. That is, the relationship between the heart, sun, brain, and spiritual awakening.

As messenger of the gods, Mercury assists in the transfer of knowledge, and not in the creation or interpretation of that knowledge, these functions being left to the brain and psychic heart. The heart is the seat of intuition, the Voice of the Soul, and the Interior Master, only through its awakening can we become conscious and free beings. However, the energy of the awakened heart, with all of its love, must be transferred to the physical brain for insight and understanding. In doing so, it requires the assistance of the Throat center. Once in the brain, the energy must also be able to return to the heart, or send information there for spiritual consideration, via the Mercurial Center.

Herein lies some confusion for some folks. It is said that the heart is the center of intuition, yet it is in the pituitary body of the physical brain that intuition is realized in mundane consciousness. Is it not possible to simply awaken the pituitary body without the needed functions of the psychic heart?

The answer is yes. To understand this somewhat confusing relationship between the heart, pituitary gland, and our spiritual awakening, we need to realize that according to

¹ Knight, p. 105.

esoteric tradition both of these organs are Solar in nature, and as such effected by the material and spiritual Sun. Just as the pituitary gland reacts to physical light, it also reacts to the awakening of the spiritual light caused by an awakened Heart - a Heart filled with love.

The brain in general is Lunar, but certain aspects of it respond to other planetary influences in their specific functions.

This need to awaken both the heart and brain, is what is required for travels through the psychic realms. An awakened heart with no brain is subject to an extreme lack of practicality; and a brain with no heart can function psychically, but only in a cold and detached manner. The 'thinking heart' and 'feeling brain' are what Mercury help us to establish. In doing so, the polarity is overcome through union and the material and remaining psychic forces of our body are brought into play in a harmonious manner.

The use of blues and purples is said to show the relationship between Daath, and the ideas of a Higher Mind (Blue/Chesed) and Yesod (Purple). Thus, the Daath, or sphere of Knowledge that we are contacting through our meditations is our personal one, and not that of the transpersonal or Cosmic Daath on the Tree of Life, of which so many dangers have been written and attributed.

It is also the synthesis of the *Supernal Upper Trinity* in a form we can approach and understand more easily¹

Also, if Yesod, or the gateway and principle sphere of the astral realm is a reflection of Daath "on a lower arch" as our British fraters and sorors are so fond of saying, then meditations on the "Daath" sphere in ourselves should not only sublimate the sexual creative powers of Yesod, but also allow us to enter into astral consciousness more fully and completely.

Some Additional Thoughts From the East

In Chinese and Mongolian Chi Kung, meditation on the throat center is used precisely for these purposes: (1) sublimation of the sexual force², and (2) assisting in the conscious projection of consciousness and the induction of lucid dreaming. It is the connecting center between the

¹ Knight, p.111; Dubuis, 1996.

² The thyroid is a secondary sexual organ.

heart and the brain. "Taoists who practice Dream Yoga focus on the throat point when going to sleep so as to consciously cross the bridge between the waking state and the dream state. Being able to dream lucidly helps one gain greater control of one's Chi (internal energy) and also enables one to consciously bridge the gap between life and death."³

Conscious dreaming is used to awaken the "Seventy-Two Magical Abilities", in order to prepare them for eventual transfer to the waking, material world. This is an interesting number, as it matches the number of permutations of the "Great Name" of God, or *Schemhamphoresch*. Theoretically, each of these Names, Signs, Seals, and correspondences⁴ could be awakened using the technique outlined in this article.

As in India and Western techniques, the throat is associated with air, spirit energy, and consciousness in Taoist practices.

The Technique

*The Philosophers of Nature*⁵ suggest three methods of projecting consciousness: mental, astral, and ethereal projection.

The first technique suggests using the Throat center for projection, and states that the dis-alignment of the physical and psychic bodies will occur at the level of the neck. It is this basic idea that the following experiment is based upon.

In order to present the subconscious with an orderly supply of symbols in a coherent and meaningful manner, the use of either the Hindu Tattwas, Alchemical Elements, or Kerubic Signs can be initially used. Afterwards, the planetary signs of the seven principle planets are used in their place. This progressive use of the same symbols allows the subconscious to understand that these symbols are meaningful and are the official means of transferring consciousness from one level to another.

³ *Awaken Healing Light of the Tao* by Mantak & Maneewan Chia. Healing Tao Books, Huntington, New York. 1993. P. 223-34.

⁴ See: *Kabbalah of the Golden Dawn* by Pat Zalewski, Llewellyn Publications, St. Paul, MN. 1993. P. 15-36 and p. 187-223.

⁵ *Qabala Lesson Number 65*, PON, Wheaton, IL. Copyright 1989.

If done repeatedly, the symbols will not be needed after a period of time, and if done with good heart and mind, one may potentially realize their own 'interior level' during one of the dream states provoked.

While full-scale astral projection may not immediately occur, the degree of lucid dreaming, dream memory, and even a limited increase in one's 'magical voice' will be experienced. It is up to each aspirant to make the most of these 'out-of-body' dream states, and increase their level of intensity so as to realize full and controlled projection of consciousness.

Unlike other methods of projection, through regular practice, the method outlined here will in most cases work gently and progressively, i.e. increased dreaming, then lucid dreaming, and finally astral projection, thus allowing for an acclimation of consciousness to these new states of being.

Step One - Obtain a set of symbols for the Four Elements and Spirit, and the Seven Planetary Signs. Start with Earth, then progress to Water, Air, Fire, and Spirit as the days proceed. The basic procedure will not change, only the symbols used to attain projection. Therefore, it is best to use symbols that you can easily visualize, either in gold, phosphorescent white, or their complimentary colors.

Step Two - When going to sleep, or even just relaxing a few minutes, turn your attention to the area of your 'Adam's Apple' and imagine a brilliant blue-black (or indigo/ultra-violet) sphere there, about the size of a tennis ball. Make it brilliant and translucent, as though it were illuminated from the inside, with its center point around the thyroid gland. It should be large enough to also touch the back of the nape of the neck, and if done very large (as Regardie suggests)¹, it may even have its farthest edges at the bridge of the nose and brushing the thymus gland, or heart. What is important here, is that the image is three-dimensional, and not just as a flat plate in front of you. Thus, the sphere, or ball, will encompass your neck, and parts of your head. Your imagination is internally directed. It is all right to imagine the organs mentioned if it aids in visualization, otherwise, stay with the bright, translucent color and imagine that this is all there is, lose yourself in it. Place yourself in its center, look around at an infinity of singular color of slightly different shades and hues.

¹ *The True Art of Healing* by Israel Regardie. Edited by Marc Allen. The New World Library, San Rafael, Ca. 1991. P. 32.

Step Three - After achieving familiarity with the first step, and you can enter into the indigo sphere at will and be comfortable there, imagine your chosen symbol for Earth present with you. See it brilliant and before you, with the qualities of Earth present, its heaviness and density, and simply stay with the symbol for a while, or until you fall asleep. Do this symbol for five to seven days, then move on to the remaining symbols. After you have completed all of the Elements, including Spirit, then proceed on to the Planetary symbols.

Step Four - With the planetary symbols you have several choices on how to approach. Firstly, you can simply move through them, starting with Luna, and progressing up the Tree of Life. Secondly, you can start with Saturn and progress down. Thirdly, you can simply alternate through them according to the ruling planet of the day. Since it is desirable to spend several cycles with each symbol, the third method offers the easiest and least tedious way of working through them without worrying about breaking off in the middle somewhere and having to start that symbol over again.

Note your experiences in your daily notebook and see what, if any, connections exist from week to week between the symbols of each planet.

It is desirable to spend at least five to seven cycles with each planetary symbol, or between six and seven weeks working with them as you fall asleep. This, added to the previous four or five weeks working with the Elements, makes a total of ten to twelve weeks of nightly work. Upon rising in the morning, a minute or two can also be spent visualizing the symbol of that day as well, as long as you don't fall back to sleep!

Those wishing to supply information regarding their experiences to the ORA Project may do so by sending a copy of their notes after the completion of the exercise to: Mark Stavish, M.A., ORA Project, Philosophers of Nature, P.O. Box 2920, Wilkes-Barre, Pennsylvania 18703-2920. Materials can not be returned and will be entered into the research files of PON for future reference. Please include a brief biographical sketch regarding your esoteric background, with particular emphasis on qabala, alchemy, and ritual magic, if applicable.

ORA is the Occult Research and Application Project, and is designed to find new applications for existing Hermetic knowledge, as well as re-create and examine traditional knowledge and techniques for use in the contemporary world. ⊕

An Interview with
Dolores Ashcroft-Nowicki,

June 10 1996.

By Mark Stavish, M.A.

Part One

Dolores Ashcroft-Nowicki has illumined tens of thousands of students in the methods of the Western Mystery Traditions in her various roles of teacher, lecturer, and author. In addition to writing ten books, she is the founder and Director of Studies of Servants of the Light (SOL), one of the world's leading esoteric schools. Co-founded by W.E. Butler, a student of the late Dion Fortune, SOL teaches practical methods of Magic, Qabala, and Occultism, through a course of personal study lasting four years: The following interview was conducted in Lansdale, Pennsylvania, prior to Mrs. Ashcroft-Nowicki's Philadelphia lecture.

Stavish: *What is magic?*

A.N.: That is a widely asked question. Magic as far as I'm concerned is a combination of art and science. It's an art because of the traditional parts of things, the graceful gestures, the sonorous invocations, the use of color, sight, sound, all of these things make it very much an art form. Yet it is also a science as well because we expect something to come of what we do. Although I have no scientific training as such, I'm coming around very, very rapidly, to a logical connection with physics. So if I have to define magic, we can go back to Dion Fortune saying it's the art of altering one's consciousness at will. That in a sense still holds. It is a diverse science that holds within itself both constructive, positive elements of a scientific nature and these beautiful artistic imaginings. Using and creating these almost dreamlike inner landscapes in which we can live, move, and have our being.

Stavish: *How then, does magic differ from the psycho-therapeutic techniques of creative imagination or visualization, such as you would do in Psychosynthesis or a similar school?*

A.N.: You know, there's not a lot of difference. There is a very thin, thin line. I continue to say that I wish we had another word other than magic. It's too hackneyed. It no longer means what we are doing or we are attempting to do.

We have to find another terminology, this NLP¹ stuff is beginning to sort of offer new ways of explaining things, offering new terms, but so is quantum physics. Magic is first and foremost a way of belief. In magic, I say, "I believe I can control certain elements of my environment, I believe I can control certain aspects of my endocrine system, through imagination, visualization, breathing techniques," which in a sense come into the scientific aspects. So magic is a combination, it's a soup, a delightful combination of art, imagination, visualization, fantasy, with a healthy dose of solid basis, because it is a science. The thing is, we've lost the keys.

Stavish: *What are the keys?*

A.N.: The keys are, or were, the training methods used by the ancient mystery schools. I mean when you think about it, in the ancient Egyptian world, everybody presented their child, at age seven, to the priest at the temple. They were tested over three days, those who showed any form of talent, in the occult sense, were taken into the temple for training. Now this was great for the parents in the sense they no longer had to clothe, feed, or hopefully educate those children. It was great for the children in that they got a chance that was not given to a lot of others. It was great for the temples, they had an ongoing inflow of talent. But how did they train them? We've got hints and tips, we've got little bits on the papyri, we've got little bits of ideas that came down to us through folklore, through myth, and any and every way possible. But we don't have, in our hands, a complete curriculum of the ways in which they trained these youngsters, the way in which they induced altered states of consciousness and the projection of the mind.

Stavish: *You have said your friends see you as compulsive about writing things down. I've seen in my experience with most magicians that they are notoriously poor at transmitting their science.*

A.N.: They never used to be. I had it pounded into my head that if you were doing meditations, you wrote down what came. It didn't matter if it was sloppy, fragmentary, or if it seemed to have very little going for it. You wrote it down because three or four days later, you might just get the key. I'm in the middle of an unfoldment within myself, mentally, spiritually, and even sort of in my basic understanding of some things. It's been going on now for about eighteen

¹ Neuro Linguistic Programming - [Editor's note]

months. Every now and then, somebody will say something to me, and I'll think, 'Oh! That fits in!', and I hurriedly make a little note. I'm with a few people, who I've sort of taken into this little paradigm I'm working on. People say, 'Have you read such and such a thing.?' There is a sentence in there, or a paragraph, or this person is talking about something. And it all fits in. Or there is a dream, a lucid dream. And I'm finding that I'm not the only one working on this. It's like the *Hundredth Monkey*. I'll have people writing into me saying, "I've had a very interesting realization. It's this . . .," and I say, "Join the club," and write back saying, "Here, have this."

Stavish: *It is like you're all baking a cake, but have different pieces of the recipe.*

A.N.: Yes, yes. You see, here we are going into another thing I'm compulsive about. What I don't like is the way lots of people sit on what they have and will not put it out. Now I'm aware that there are some things that you cannot put out until you have most of the puzzle. Otherwise your New Agers, with two pounds of incense, a new robe, and three books of Aleister Crowley's, thinking they are an Ipsissimus, can send themselves three different ways to Hell. So you have to have a responsible attitude toward this. Once it's there, once you've got it you can say to people, "Hey, try this." I think the way people hang on, "We can't give you that. That belongs to our Third Degree." And I think this is what they said to Crowley.

Stavish: *Recently, several new organizations have been started, in particular the Philosophers of Nature, because it found that many alchemists were starting from the beginning, reinventing the wheel, because the transmission of the knowledge was not happening. So much of magic, Qabala, and the Hermetic tradition has become secrecy bound. In SOL's Website, you recommend Regardie, and make no mention of Crowley.*

A.N.: No, but when people say to me 'What do you think of Crowley?' I have an answer. I have great respect for the man. I have a great sympathy for the terrible upbringing he had, I also think he was his own worst enemy. His cynicism was his downfall. But I notice that the people who are his greatest denigrators go into a lodge and work his kind of magic. It's not that I don't acknowledge him. It's that I regard his stuff as dangerous for newcomers. But, when you reach a point where I think you're going to make a good supervisor, or possibly head a working lodge, then I

will say to you, "Go ahead and read Crowley, and know where he is deviating because of his own weird sense of humor." The guy did have a lot of problems, but he also did get quite a bit right.

Stavish: *You've said that the Western Traditions were in danger. Are they also like Crowley, their own worst enemy?*

A.N.: Oh yes.

Stavish: *What are they in danger of, or from?*

A.N.: It is in danger of falling down under the weight of its own crassness. Nobody really wants to work anymore. Nobody has the dedication to say, "It's going to take me ten years to get through this thing."

Stavish: *That is related to what I am so often reminded of, that we have no Masters in the Western traditions, as opposed to the Eastern Traditions, or at least purported to be, and many have commented to me, that there is no discipline in the Western Traditions, compared to the Eastern traditions. How do we bring discipline to the Western Mystery Traditions? And, where are its Masters?*

A.N.: Discipline. You see, I was trained in the *Society of the Inner Light*. Now that requires that you spend a certain amount of time in meditation, it also requires that you spend this time in early morning, because they say you're closer to the sleep state at that point. You're more likely at that point to almost, but not quite drop off, which brings about a lucid interlude. You're required to write this down within ten lines, not five pages for every entry. If you have to use ten pages, you're not listening to what is being told to you in your meditation. Also, they like you to be able to condense what you've realized into something short, sharp, and explanatory. They expect you to have at your fingertips, a comprehensive knowledge of two traditions or pantheons, whichever you like to call them. You're expected to study, to read, and they give you a book list. Now we follow something similar to this in the SOL. We are a little bit more forgiving, we allow you fourteen lines, instead of ten. And I say to people, more than fourteen lines and its going to get crossed through. So, if your best realization part is in there, it's not going to be read. We know that there are people who work split shifts, so we don't say that you've got to do it at this time, but we do say we want a minimum of fifteen minutes. In the sense that if you're not

going to get anything after fifteen minutes, you're not really going to get it after twelve more minutes, or sort of an hour. I don't believe in hours and hours of meditation. The mind gets tired and starts to fold in on itself. We do have a reading list, it is fairly comprehensive, it includes fictional works as well as non-fictional. We say to people, if you're going to be a magician, you're going to have to have geology, paleontology, archeology, art, history, as many languages as you think you can cope with, music, a sense of color, mathematics. There are maybe twenty-three-ologies, that you can use, because magic is so comprehensive a subject.

I think that the Western Masters, however, are mostly withdrawn. They tend to work through what we term the mind touch, overshadowing, or more rarely, the Indweller.

Stavish: You have to be a Renaissance person.

A.N.: Yes, exactly. And using that term, one of the things I have been trying to get into my students' heads, is that we have to begin to think in a new way. The old way of thinking is straight ahead. We must learn to do what the Greeks did in Thales, when Myles, started to think around corners with abstract thought. There is Cerphalies, there is Anixaimander, and Anaximedes in that little tight community in Miletus where they all started thinking in that new weird way which has been quite well put by Julian James in the *Breakdown of the Bicameral Mind*. I don't agree with everything, but certainly, it is a book that everybody should read. We are at another kind of Renaissance now, and if we don't start to think in new ways, like quantum physics, which is a new way, we're not beginning to think at right angles. Edward DeBonno some years ago started the idea of lateral thinking. With the magician, it's not just the idea of thinking around a corner, not just a question of coming up to this idea and going on, going at right angles. It's a question sort of like a star burst, it goes in every direction.

Stavish: So it is three dimensions and even a fourth dimension.

A.N.: Exactly! Because there is a point at which the three dimensions is not enough. It's like an empathic link with the universe as a whole. Now we can have empathy between people, between us and the animals around us. Some people have an empathy between them and the plant world. My husband can plant a wooden pencil and I'll swear it will come up and bud! But there is something more. To have an

empathic link with the wholeness of everything is to suddenly come alive. And to use a 'Gurdjieff-ism', to 'wake up'. The trick is to keep awake.

Stavish: Where do you see this new direction in magic and thinking going, and why do we need it now?

A.N.: Science, pure science, is, in a sense, leading us astray, with the development of certain types of uses for nuclear devices. Leading us astray with the idea that everybody has got to have everything that they want even if it means polluting the entire environment. It is a case of "let's just keep one or two canisters of the smallpox virus because we'll never know when we might need it". Science is becoming very much a Dark Power, in many ways.

Stavish: That is almost an Anthroposophic view.

A.N.: And I'm not too gun on Steiner, there is lot of his stuff that I don't go for. He's a bit prissy. But magic you know, and this quantum physics stuff, are getting closer and closer together. One of these days, the quantum physicist is going to wake up and find he's a Magister Templi (Master of the Temple), and the Magister Templi is going to wake up and find he or she is a quantum physicist. They are getting so, so close, and it is worrying the hell out of pure physicist who are thinking we are getting close to this weird stuff now. But on the other hand they can't deny what they are finding. Whereas a lot of forward thinking magicians are saying this stuff is great. This stuff is explaining what the Egyptians have been telling us for ages, you know. The trouble is people look back at what they perceive as a Golden Age of Magic. It wasn't all that golden. They had as many problems as we have, different ones, but they certainly had them. Then everything went to hell in a basket when Rome fell, and the Dark Ages, with little pockets of Light here and there, and all of a sudden this wonderful Renaissance. It was like being given a second chance, everything began to surge forward.

Stavish: What we don't hear about is that many of these artists and their sponsors were esotericists and were involved in the promotion of occult ideas.

A.N.: And they were all wealthy people who had the time to do these things. We don't. I mean I have to go out, I don't take anything, not even a penny. None of the supervisors, not even my husband who is the other Director of the SOL. We take nothing. I go out and I lecture and I write. That is

how I earn a living. I can't afford to sit at home, and do what I would really like to do, which is sit down and research and write. Nobody can these days. The last time they did this was in the Golden Dawn. They were people mostly who were wealthy.

Stavish: And the Golden Dawn never had more than several hundred members at its height.

A.N.: It wasn't that big, and those who were in it didn't have to go out and do a nine-to-five. Florence Farr¹ was a pretty mediocre actress; she relied a lot more on other talents than her thespian ones. That isn't to say that she wasn't a damn good magician at that time -- she was.

Stavish: There seems to be reactionary tendencies toward magic, at least in America. The Golden Dawn styles of magic are what most people are familiar with. With that comes Crowley and his reaction to Victorian social and sexual values, and we have that here today as well. A lot of people studying magic find that their old values no longer hold, others use magic as an excuse to disregard any values they may have held or been brought up with.

A.N.: They certainly do. But that's one of my big beefs about the New Age, but let me say, not all of the New Age is as bad as it seems. When it is good it is good, when it is bad, oh is it bad.

Stavish: Not unlike modern magical groups.

A.N.: Oh boy, yes indeed! There is not a lot in the middle road in the Western Mystery Tradition. But yes, there always comes a point, where morals and ethics loom large. Now you can't have two outlooks on this. People say either, 'I'm this great magician and nothing applies to me', or people sort of stick to the ethics and morals within their areas, that they have grown up with. I'm a kind of in between point, because I was trained by (W.E.) Butler who was trained by Dion Fortune who was of the old school. My mind is always forward looking, and I am of myself in my own particular work looking toward that time ahead of my own, but I am stuck in the middle. Which is why the SOL has always been described as a bridge builder. We are not a cult, we don't teach a belief. We teach a method

¹ Florence Farr was introduced to the Hermetic Order of the Golden Dawn by W.B. Yeats, and was the mistress of George Bernard Shaw.

of training your occult talents. We don't say to you, "You've got to be Christian," like the Inner Light does now. We don't care if you're a Muslim, a Sikh, or a Roman Catholic. We don't care what the hell you are. If you want to be trained in this kind of stuff we will train you. What we will tell you is that it will give you a better understanding of your own belief system. All we offer is training.

Stavish: Many esoteric groups say that, but when push comes to shove, many of the individuals take on the belief; the new system becomes their religion. That is, they take on the philosophy and ideas, they become so ingrained through their experiences and practices, that it becomes their religion. That is why when somebody asks me 'What are you?' It is a difficult question to answer in a single word. I know many esotericists in the same position.

A.N.: Well, again we are coming up against terminology. There should be a word that you can say 'Yes, I am a . . . !'

Stavish: I know some who simply say 'I'm a Hermeticist.'

A.N.: Well that covers a multitude of good and bad. We are at a point, Mark, where it's white water, and it comes at the end of every hundred years, and more so at the end of an Age, where we are approaching or already within.

Stavish: The New Age movement is fundamentally built on a vision of doom. It is contradictory, but on one hand you have the belief in Think and Grow Rich, and on the other hand, the belief that the world will end in the year two-thousand. But even within the Hermetic tradition, going back to French esotericism and Fulcanelli, there is a sense of an historical as well as an initiatic understanding of the Apocalypse, and that is something I don't see Western esotericism addressing. Is Hermeticism essentially apocalyptic?

A.N.: I think that there is something in the human psyche, that when it approaches a big mark up point it tends to get doom laden. In the year one-thousand people were giving away everything they owned, including large castles, to beggars at the gate, you know, and preparing to be taken up into the New Kingdom. When it didn't happen they came along and swiped it all back. I think that this is something that is deep in the human psyche, that come hell or high water you're going to have this sort of doom and gloom aspect. I'm a confirmed optimist. I think that the Apocalypse is going to be in this new way of thinking. Some-

where between now and 2020, there has got to be a break through. Not just in science, we've done that, but a breakthrough in the human mind. We are going to be able to grasp a concept, a way of thinking. We are going to be able to make a realization, that encompasses our species. I think that is what it is. The feelings of doom, of hopelessness comes from that part of the combined human group mind that says, "I'm not going to make it. I won't be able to change," and if you don't change, you're going to go under.

Stavish: Will this translate into a change in the physical reality we know?

A.N.: I think, perhaps, there will be concern with the way we are able to use our brains. Let me put myself out on a limb here and say something that I said yesterday. I think it won't be long before we see the first of the mutants. And I'm not saying that in a sort of Hollywood occult movie sense, but mutants in the way of people who already border on P.K., empathy, telepathy, there is great emphasis on empathy coming into the people, even at my age. I'm what is known as a psychic sensitive, I'm not an objective clairvoyant. If there is anything around, I can tell you what it's like, where it is going to go, and what it is doing, but I also have a gift of empathy. I can take a group, any number of people, give me an hour, and I will bind them into group mind that you will be able to taste when you come into the room. People that I am close to, I can pick up on, and it doesn't matter what parts of the world. If they are in great pain, great mental distress, I will pick up on it. And more often than not, pick up a phone and say, 'Yes John., Yes Elizabeth' and this little voice comes, 'I wish you wouldn't do that!'. Empathy is the easiest of the magical talents to develop. Because we all have it to some degree. We just don't recognize it as a magical talent.

Stavish: I know several people who began their occult work with a sense of empathy, or even developed psychic abilities. However, after a period of time, they begin to lose those abilities. This is somewhat of a problem with the qabalistic students I've met, because they read books, such as Dion Fortune's Mystical Qabala, and it is so compartmentalized, that it actually reinforces interior barriers rather than diminishing them.

A.N.: Qabalists all over the place are compartmentalized. They think in little boxes. This is what I meant in a sense by thinking around corners and thinking in different ways. They have to climb out of the box. Strangely enough, with

the Qabala, once (Pico) Mirandola had started the ball rolling, everybody climbed on the Qabalistic bandwagon for a couple of hundred years, and then all of a sudden they stopped. People began to take the Jewish idea that what was written mustn't be changed. Everything's got to change. If it doesn't change it dies. The first thing we've got to do, is say, 'Yeah, I'll change this. I'll change that.' Dion Fortune started it, but she didn't go far enough when she said it's the Yoga of the West. She began to Westernize it, and let's face it, the Qabalah is basically a Middle Eastern sort of concept, and she began to expand it into the Western way. But she didn't go far enough, and she died before she could really do anything about it. However, she was slowing down. She was in a sense, coming to the end of her flowering. I doubt if she would have taken it much further. Charles Seymoure went right afterwards. Christine Hartly retired, a wonderful lady, superb seer, she didn't do anything once she lost Seymoure and Dion Fortune.

Stavish: Seymoure was her magical partner and Dion Fortune was her magical tutor.

A.N.: Yes, yes. Then Ernest Butler comes along. But Ernest was compartmentalized in the sense that he was an ordained Christian priest in the Liberal Catholic Church. Although it came out of Theosophy it was still bound with conventions. So he tried, and passed on to me, seed ideas. He said to me, quite out of the blue one day, "Take what I can give you, but change it before you use it." I didn't understand what he said until three or four years later.

Stavish: Some of the criticisms of Qabala is that it is too difficult, complex, and overly symbolic. Some students even seem to get locked in the symbolic matrix, as an endpoint in itself, not progressing to the truth behind the symbol.

A.N.: You see, symbols were made to be doorways. You don't stop at a symbol and say, here, this is an equal armed cross with a circle around it. You're supposed to go through that symbol and find out what's behind it. I find this mind boggling, I really do. You see, I had an advantage. I was born into an occult minded family. Nothing was hidden, anything that they knew I knew. I was encouraged to sit at the table and talk with grownups. O.K. I was an only child, this was reasonably easy. My Father has encouraged me every step of the way. I was brought up with the idea that if you didn't know, you stuck at it until you found a thread somewhere, and you followed that thread

and found out. So for me, a symbol is just a beginning. To what is behind the symbol. It is not just a pretty decorative pattern. You take it and you chew it.

Stavish: How do you chew it?

A.N.: You take it apart. You look at it, and can use any one of a dozen ways. I teach my people to use what we call association hooks. Look at it, wait and see if another symbol comes up, add that to the first one. Wait and see if another one comes up. When you've finished all that lot, kind of sit and look at the symbol. Use the Jewish or Indo-Tibetan idea that every letter of the alphabet is a living being. You do that with a symbol, and you make a friend of your symbol. And you give it a name. "Hi Fred! How are you doing?" And the symbol sits there and says, "I'm doing O.K. What would you like to know today?" "Well listen Fred, I've been thinking. You know, you're always drawn in this way, can you give me an aspect of yourself that was before this?" "Well, let me think," says Fred, "I used to be drawn like this . . ."

Stavish: So then, do you actually dialogue with the symbols?

A.N.: Oh, yes. The crazier a thing is, the more it's going to work.

Stavish: Is that like in the Sufi and Tibetan traditions where they have what's called "Crazy Wisdom" or the belief that the more bizarre a thing is, the more it will break down our conventional barriers?

A.N.: Exactly! Exactly! I again, go back to my family. We've got a nutty sense of humor. It is one of the whole things about the family. Ernest used to say to me, and it is one of the ways in which he broke his own mold, he never used the term subconscious or lower self, he used to say that is the Power Self, that is the Foundation, that is your Yesodic (Hebrew: *Foundation*, or autonomic nervous system) thing -- the machinery of your personal universe. This is where all the power is, unfortunately it is as dyslexic as hell and can't read! So you have to feed it images. I was brought up believing that all magic is the basis of fantasy, imagination, visualization, and desire. Those are four, nice solid, little foundations, and you build on those. Now, "George," the Power Self, is immensely powerful, and is linked not only to your consciousness, if you allow it, but also to your Higher Consciousness - The Power Self, or

Yesod, which touches everything. Yet, we're sitting here on this immense knowledge, and nobody's taken notice of it, because everybody says, 'Subconscious, the Lower Self, poohoo.'

Stavish: That is the major problem that occurred in the last century with the Theosophical Society, and the reason for the formation of magical societies such as the Brotherhood of Luxor, the Hermetic Order of the Golden Dawn, and the reason for much of the cross-organizational membership. The Theosophical Society wasn't teaching anything practical, and it brought with it the Victorian/Indian prohibitions about sexuality. Since the subconscious and Lower Self are intimately related to sexuality, they felt something was 'wrong' with it.

A.N.: Oh, you know about that!!

The End of Part One

In Part Two (July-August issue of the STONE), Ms Ashcroft-Nowicki discusses, among a wealth of other things, her book on sex magic, The Tree of Ecstasy.

For those with Internet access, the entire interview appears on our web page at: <http://www.mcs.net/~alchemy/stone20a.html>



ATTENTION!! **Readers and Writers**

According to Webster's International Dictionary the words **cabala**, **cabbala**, **cabalah**, **kabala**, **kabbala**, **kabbalah**, **qabbala**, or **qabalah** all refer to a system of occult theosophy or mystical interpretation of the Scriptures.

PON accepts all of these spellings as correct, however, to avoid offending our reader's or contributing writer's personal choice of spelling, the PON editors will only use the generic spelling, '**Qabala**', in all articles and other written applications appearing in *The STONE*.

An *exception* will be made when referring to book titles that include a version of the word *Qabala*. To those submitting articles; please underline all titles referenced in your submission. It will be assumed that your written titles are correct and therefore, they will be printed as received.

Thank you.
Rick Grimes - Editor-in-Chief

MINERALS FOR THE PORTÆ LUCIS WORK:

This path for *making an Eternity Contact using simplified methods* was quite clearly explained in the excellent seminar by Mr. Dubuis held in Glen Ellyn, IL, October 18-20, 1996. The surveys we received from those attending the seminar, as well as the comments made to us indicate that this was the finest presentation by Mr. Dubuis to date.

Those who attended the seminar, and those who have viewed the video tape of that seminar, *Portæ Lucis: Volume 1, An Introduction*, will be looking for some specific materials. At the present time, we are able to offer specimens of native diamond, galena, silver and gold. All gold is shown as an approximate weight in dwt (pennyweight). Our 0.3 dwt samples average about 4 x 6 mm. The 0.1 dwt samples contain from 1 to 4 pieces of gold to make the appropriate weight.

Item No:	Description:	Source:	Approx. Size:	Price Ea.,
DI-010	Diamond, Industrial grade octahedral crystal	South Africa	1 mm.	\$23.00
DI-015	Diamond (as above) *	South Africa	1.5 mm	\$27.00
DI-020	Diamond, native, cubic	Africa	2 mm	\$28.00
AU-201	Gold, native	California	0.1 dwt	\$6.00
AU-202	Gold, native	California	0.2 dwt	\$11.50
AU-203	Gold, native	California	0.3 dwt	\$16.50
AU-204	Gold, native	California	0.4 dwt	\$22.00
AU-205	Gold, native	California	0.5 dwt	\$28.00
AU-206	Gold, native *	California	0.6 dwt	\$32.00
AR-001	Silver dendrite crystal group, very pure *	Mexico	Small	\$32.00
AR-002	Silver dendrite crystal group, very pure *	Mexico	1 - 2 cm fronds	3 pcs. for \$16.00
PB-001	Galena, cleavable, high quality	Kansas & IL	25 x 25 mm	\$4.00
PB-010	Galena, cleavable, high quality	Kansas & IL	25 x 25 mm	10 pcs. for \$32.00

Please make checks payable to Philosophers of Nature.

Add \$3.00 for US postage, \$5.00 for Canadian, \$8.00 for all other countries.

*Please allow 4-6 weeks for delivery. Supplies are limited. * Only 1-3 pieces available, specify second choice*

Announcement:

P.O.N. SEMINAR VIDEO TAPES

The production and sale of our 'student grade' video tapes has been **discontinued** as of the last issue of *the STONE*. These were sold at prices between \$10.95 and \$19.95 per set, as unedited tapes which were duplicated with a noticeable loss in video quality. Still, we knew many of our members would benefit from having these tapes. Essentially we decided to sell video tapes that were priced so low that they were as affordable as an audio tape, but with the benefit of being at least somewhat more enjoyable and informative to use. The response was overwhelming – we had a hard time keeping up with orders.

We are now negotiating with a commercial video duplication company to come up with a better quality video product at a fair and reasonable price. Over the next 60 days we will determine which tapes are to be released in the higher-quality edition. An announcement will be made in the next issue of *The STONE*. We regret any inconvenience.

The PON has just purchased a new video camera, made possible through the strong sales of the 'student grade' videos.

Other Announcements:

The new course from Jean Dubuis will not be complete for about 4 more months.

The member surveys are still coming in, so we will print them in the next issue of The STONE.

Don't delay any further, Make your Seminar Reservations - NOW!

and . . .



Remember to Renew...

Your PON membership or subscription expired on December 31, 1996 unless you renewed or had previously paid your 1997 fees.

RESOURCES:

References for laboratory equipment, supplies, and materials to support the efforts of researchers. Please inform us of new suppliers, and let us know if supplier addresses and phone numbers change. We do not list suppliers of medicines for internal use, for practical reasons.

Alchemical Resources**Al-Kemi**

1807 2nd St., Suite 9, Santa Fe, NM 87505 USA
Tel: 1(505) 988-7315 (Noon -- 10 PM MST)
Glassware for alchemical work.

American Science and Surplus

3605 W. Howard St., Skokie, IL 60077 USA
Tel; 1 (847) 982-0874 Fax: 1 (800) 934.0722
<http://www.sciplus.com/>
*Request catalog (available in USA and territories only).
Science & hobby kits, motors, electrical components, educational and office supplies, novelties and toys.*

Bryant Laboratory, Inc.

1101 Fifth St., Berkeley, CA 94710 USA
Tel: 1(510) 526-3141 or 1(800) 367-3141
Fax: 1(510)528-2948
Mail-order labware and chemicals.

Centaur Forge, Ltd.

117 North Spring St.,
PO Box 340, Burlington, WI 53105-0340 USA
Tel: 1 (414) 763-9175. Fax: 1(414) 763-8350
Temperature crayons, forges, blacksmiths' supplies, such as tongs, aprons, etc.

David Shannon

6649 E. Rustic Drive, Mesa, AZ 85215 USA
Tel/Fax: 1 (602) 985-0557
Minerals by the specimen or in bulk.

Dr. Michael's Herbs

5109 N. Western Ave., Chicago, IL 60625 USA
Tel: 1 (773) 271-7738
Herbs.

Hagenow Laboratories

1302 Washington St., Manitowoc, WI 54220 USA
Tel: 1 (414) 683-3339
Bargain priced labware and supplies by mail-order.

TRIAD

125 West Front Street, Suite 275,
Wheaton, IL 60187 USA
Email: majrcana@aol.com
*Request price listing.
Sibnite, Alchemical books, Marseilles Tarot Deck, high purity essential oils, hard-to-find items.*

Books**Banton Press**

Mark Gordon Brown
Dippin Cottage
Isle of Arran, KA27 8SB, UK
*Handmade, perfect bound paperbacks of facsimile reprints;
20 alchemical titles, plus other topics.*

Chthonios Books

7 Tamarisk Steps
Hastings, TN34 3DN, England
Tel/fax 01424 433302
(+44 1424 433302 internationally)
*Scholarly titles from publishers worldwide which deal with
Esoteric Studies, and second-hand books.*

J.D. Holmes

PO Box 623
Edmonds, WA 98020 USA
Fax/Phone 1.206.771.2701
Series of inexpensive reprints of alchemical works.

Kessinger Publishing

P.O. Box 160, Kila, MT 59920 USA
Tel: 1 (406) 756-0167
Fax: 1 (406) 257-5051
Email: books@kessingerpub.com
<http://www.kessingerpub.com>
Over 1000 titles on Hermetic and Masonic topics

Phanes Press

P.O. Box 6114
Grand Rapids, MI 49516 USA
<http://www.phanes.com>
*Publishes & distributes books which relate to the spiritual
and philosophical traditions of the West.*

R.A.M.S.

Hans Nintzel
733 Melrose Drive,
Richardson, TX 75080 USA
Photocopies of translations of alchemical texts.

Todd Pratum Book Company

P.O. Box 985
Healdsburg, CA 95448 USA
Tel: 1 (707) 431-2634 Fax: 1 (707) 431-0575
*Specialist in Philosophy, History of Religions, Mythology,
and Metaphysics. Old, New & Rare.*

Entrainment Technologies**Tools for Exploration**

47 Paul Drive, San Rafael, CA 94903-2118 USA
<http://www.tools4explore.com>
Light/sound machines and consciousness tools

Newsletters**Caduceus: The Hermetic Quarterly**

Cinnabar,

P.O. Box 95674, Seattle, WA 98145 USA.

A quarterly journal of the Hermetic tradition. Subscription prices are \$18 US per year within North America and \$25 US per year overseas; checks should be made payable to Cinnabar.

Cauda Pavonis: Studies in Hermeticism

Stanton J. Linden, Editor,

Cauda Pavonis, Dept. of English,

Washington State University,

Pullman, Washington 99164-5020 USA.

Published twice each year, in the spring and fall. Now in its fifteenth year, it publishes scholarly material on all aspects of alchemy and Hermeticism and their influence on literature, philosophy, art, religion, and the history of science and medicine. Annual subscription cost is \$10.00 for individuals, \$12.00 for libraries and foreign subscribers. Checks should be made payable to Cauda Pavonis; foreign subscribers should pay by checks drawn on banks with American branches.

Ambix, The Journal of the Society for the History of Alchemy and Chemistry

Scholarly articles and reviews of books on all aspects of the history of alchemy and chemistry, published in March, July and November. The annual subscription to the Society costs £20.00 (\$32). This should be sent to Dr. N.G. Coley, 24 Kayemoor Road, Sutton, Surrey, SM2 5HT, UK. Members receive the current volume (3 parts) without further payment. Most back issues are available at £15.00. For non-members, libraries and institutions, the annual subscription to Ambix is £38, and most back issues are available at £24. Orders for non-members should be sent to Black Bear Press Ltd., King's Hedges Road, Cambridge CB4 2PQ, UK.

Internet**The Philosophers of Nature**<http://www.mcs.net/~alchemy>We maintain an **updated resource list** on our site.**The Alchemy Virtual Library**<http://www.levity.com/alchemy/>

Over 28 megabytes of information on alchemy in all its facets organized by Adam McLean.

PRACTICAL TIPS: Herbal Calcination**From Our Members**

Calcining Tip: A method that preserves the subtle salts of herbs that usually fly away in open flames:

Obtain a tin cookie can, cake box, or paint can - with lid. Remove all paper labels and make sure it has no paint on the inside. Poke a small hole in the lid.

Cut your selected dried herb into small pieces and wrap in aluminum foil sealing it as best you can, place in the container, and attach the lid securely. [For those who might be concerned about aluminum contamination - place the herb in the can by itself. The foil just helps contain the resinous tars that will be produced.]

Place the can in a fireplace, an incinerator, or on a grill. When the smoke stops coming out of the hole in the lid your herb will be near completely charred. Leave it in the fire for another hour, then remove and allow to cool. *PLEASE use tongs or asbestos mittens to remove the container - it will be HOT!*

Remove the cool herb - now completely charred - and grind to fine powder in a mortar. The tarred resins can be removed with alcohol or acetone. While still in solution in the menstrum (alcohol / acetone) mix it into the powdered charcoal - *allow to air dry - do not ignite*. The intense heat of an open flame will carry off the subtle salts and all your efforts will be for nothing.

Put the dry powdered herb into your calcination dish and cover with a fine steel screen. Calcine now in open air to oxidize the carbon until the ash is light gray to white. In the latter stages you will notice the sublimating fine salts ascend and attach themselves to the screen. This is the prize that would otherwise be lost in the open flame - subtle, light, and ethereal salt. To recover these salts wash the screen gently in distilled water, then use the same water to leach the remaining salts from the ash. Recover salts by coagulation [gentle distillation] and repeat the process until the salts are pure white.

RG

THE STONE

THE JOURNAL OF THE PHILOSOPHERS OF NATURE

© 1997, THE PHILOSOPHERS OF NATURE. ALL RIGHTS RESERVED.

ISSUE NUMBER 21

JULY-AUGUST 1997

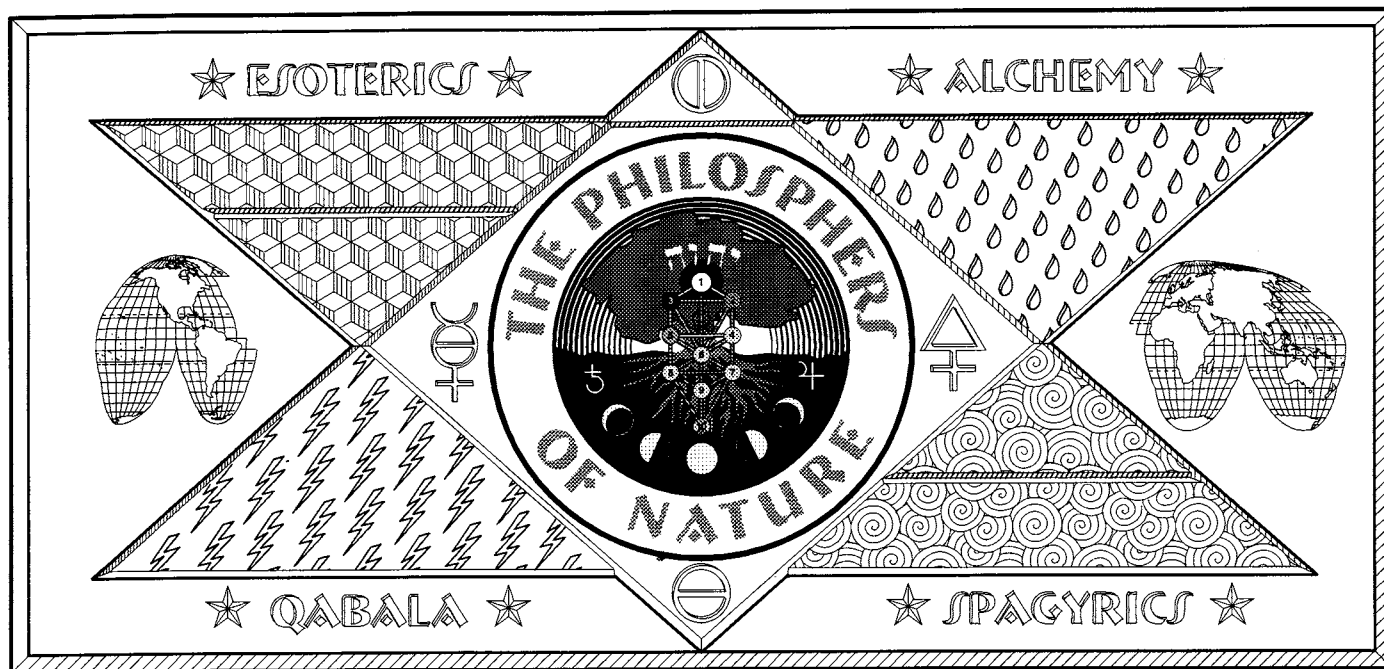

IN THIS ISSUE

Article or Feature	Author	Page
A Message from the President	Russell House	2
P.O.N. MEMBERSHIP SURVEY	PON	3
Yantras and Alchemy (Part Two)	Joseph Caezza	5
Alchemical Gardening (Part Two)	Rick Grimes	8
Self Healing*Archaeous	Rawn Clark	11
An Interview With Dolores Ashcroft-Nowicki (Part Two)	Mark Stavish, M.A.	19
Practical Lab Tips	Russell House	31
IMPORTANT VIDEO TAPE ANNOUNCEMENT	PON Board	31
A Conference in Prague, Czechoslovakia	New York Open Center	31
Upcoming PON Workshop in Plant Alchemy	PON	31
Upcoming PON Workshop in Mineral Alchemy	PON	32
Cover Art: The New PON Logo	Rick Grimes	Cover

Editor-in-Chief: Rick Grimes; **Production:** Le Philosophe Inconnu

Published six times per year by The Philosophers of Nature

Price: \$5.00 US

THE PHILOSOPHERS OF NATURE

125 West Front Street, Suite 263, Wheaton, IL 60187 USA

Tel: 630-682-3938 Fax: 630-665-2364

E-mail: alchemy@mcs.com Internet: <http://www.mcs.net/~alchemy/>

A Message from the President

One of the most important things that the leaders of any enterprise can do is listen. In November 1996, we mailed a survey to each of our members so that we could listen. We want to be certain that we are making the improvements that our will benefit our members.

We promised our members that if they would respond to the survey that we would do every reasonable thing to meet their expectations. Originally we had planned to publish the survey results in March, 1997, but other projects, and the rapidly growing issues of *The Stone*, delayed the publication until now.

The survey results are published immediately following this message. First, I will share a few comments with you about what we learned.

Some comments:

Members often indicated that their responses were based on experiences that are not recent, particularly in the areas of course quality, on-time mailings (for the courses and *The Stone*). Based on concerns expressed by members more than a year ago, we made necessary changes, and have shipped every issue of *The Stone* on time for the last 10 months.

Have you ever wondered where our members live? 79% are in the US, 9% in Canada, 8% in Europe, 3% in the Pacific Rim, and 1% in South America. Several of our South American members receive lessons at US addresses for forwarding, and are reflected as US members.

In the US the largest membership is in California (21%), the next largest concentration is in Illinois (11%), followed by Colorado with 8%. New York has 7%. Texas and Washington state each have 6%. The next largest groups are in Florida, Massachusetts, Maryland and South Carolina, with a range from 2% to 4%.

While we do not publicize the size of our membership, we will say that we have had a 36% increase in membership in the past 12 months. A large part of the growth is international, with a significant number of the contacts coming through the internet. This growth does not reflect the French-language readers of our lessons that we serve. When we consider them, we are

supporting the needs of 55% more people than in the prior year.

Our expansion has created some 'growing pains'. It takes nearly every spare hour that our volunteers can find away from their professional demands and the ordinary business of life to keep things moving. Despite their efforts, there are phone messages that can not be answered for weeks at a time, and there are always a few dozen letters and emails that are held up for one reason or another. We had one member who neglected to indicate the country of their residence, so we could not fulfill their order for several months. Others have waited for months for video tapes due to unexpected demand, and resulting production problems. Although it is rare, we have shipped the wrong lessons to members... often the work keeps the office crew busy until 2 or 3 AM, and mistakes are easy to make. Still, our members are, by and large, incredibly understanding.

Despite your generosity, we want to be the best association possible, and we want to offer first-class service. For that reason, we asked some leading questions in our survey, so that we could get some sense of priority, and focus our limited resources where they mean the most to our members.

One thing that we are doing in response to the survey is offering more seminars. The first choice of location is in the Chicago area, and a lot of our members indicate an interest in mineral alchemy. To support that need, I will be presenting an intensive two-day workshop in the Chicago area in September. An announcement appears in this issue.

Mark Stavish, a frequent contributor to *The Stone*, and our Director of Research for our ORA project, is holding a number of seminars on Plant Alchemy and Qabala. One will be held in Massachusetts, and another is being planned for the Washington/Vancouver area. A notice appears in this issue.

Remember to look for a program on Alchemy on the "Ancient Mysteries" series on the A&E network. We have not received notice of the scheduling, but think that it will be aired in August or September.

We hope that you will enjoy the issue. Rick and our contributors have done an excellent job once again.

Ora et Labora!

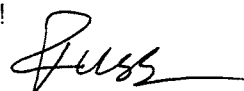

Results of September 1996 Membership Survey

A survey was sent to all members with The Stone mailing of September 1996. Approximately 34% of the members responded. Only one board member responded to the survey.

There are four types of responses:

Rating: Rate the service as Excellent (5.0), Very Good (4.0), Good (3.0), Fair (2.0), Poor (1.0).

Yes or No: The percentage responding "yes" are indicated.

Preference: Select from the list and rank your preference as 1st choice, 2nd choice, etc.

Written: The member's ideas were written and returned with the survey. (Not listed due to space limits).

Question:	Type	Response	Rating
COURSES: GENERAL QUALITY OF SERVICE AND PRODUCT			
Do you get the right lessons in your mailings?	Rating	4.46	VG +
Are all of the pages there?	Rating	4.19	VG
Are the photocopies clear and easy to read?	Rating	4.11	VG
Is the paper quality satisfactory?	Rating	4.04	VG --
Do you receive the mailings on a timely basis?	Rating	3.89	Good +
Are the prices for the lessons reasonable?	Rating	3.89	Good +
Fundamentals of Esoteric Knowledge			
Is the course informative?	Rating	4.40	VG
Is the course at an appropriate level for you?	Rating	4.14	VG
Is the course free from errors in language & spelling?	Rating	3.63	Good
Do you find the course attractive and easy to read?	Rating	3.76	Good
Are the pictures and drawings satisfactory?	Rating	3.71	Good
Qabala			
Is the course informative?	Rating	4.15	VG
Is the course at an appropriate level for you?	Rating	3.92	Good +
Is the course free from errors in language & spelling?	Rating	3.73	Good
Do you find the course attractive and easy to read?	Rating	3.31	Good --
Are the pictures and drawings satisfactory?	Rating	3.69	Good
Spagyrics			
Is the course informative?	Rating	4.44	VG
Is the course at an appropriate level for you?	Rating	4.27	VG
Is the course free from errors in language & spelling?	Rating	3.31	Good
Do you find the course attractive and easy to read?	Rating	3.56	Good
Are the pictures and drawings satisfactory?	Rating	3.81	Good
Mineral Alchemy			
Is the course informative?	Rating	4.31	VG
Is the course at an appropriate level for you?	Rating	4.09	VG --
Is the course free from errors in language & spelling?	Rating	3.73	Good
Do you find the course attractive and easy to read?	Rating	3.69	Good
Are the pictures and drawings satisfactory?	Rating	3.67	Good
COURSES: Format and new distribution policies:			
I would prefer to receive my lessons as:			
• 3-hole punched	Yes / No	55%	Medium
• a bound booklet for each 'year'	Yes / No	39%	Medium
• plain unpunched paper	Yes / No	6%	Weak
I would prefer that the lessons are:			
• printed on both sides	Yes / No	36%	Medium
• printed on one side only	Yes / No	15%	Weak
• either is OK	Yes / No	39%	Medium
Would you like for courses to be available on CD-ROM?	Yes / No	39%	Medium

Do you have a PC?	Yes / No	67% Strong
Are you using the Internet on a regular basis, or plan to in 1997?	Yes / No	55% Medium
Did you know that each 'year' is shipped complete in one mailing?	Yes / No	70% Strong
Did you know that you can order as many 'years' as you want?	Yes / No	52% Medium

COMMUNICATIONS:

Are problems quickly resolved to your satisfaction?	Rating	4.08	VG
Are your calls returned on a timely basis?	Rating	3.96	VG
Are your letters or email answered on a timely basis?	Rating	3.92	Good +

THE STONE Newsletter:

Do you receive the mailings on time?	Rating	3.17	Good
Are all of the pages there?	Rating	4.35	VG
Are the photocopies clear and easy to read?	Rating	4.06	VG -
Is the content informative?	Rating	4.17	VG

MEMBERSHIP:

Have you ever been a member?	Yes / No	100.00% Strong
Are you member now (1996)?	Yes / No	100.00% Strong
Are you renewing your membership for 1997?	Yes / No	100.00% Strong
Is the \$30.00 fee is reasonable for 6 newsletters plus other benefits?	Yes / No	97% Strong

I would like for there to be:

- More video tapes Yes / No 30% Weak
- Supplies Yes / No 39% Medium
- T-shirts, sweatshirts Yes / No 30% Weak

SEMINARS and WORKSHOPS:

Have you attended any of our events?	Yes / No	55% Medium
Are you interested in attending future events?	Yes / No	91% Strong
Are the prices for seminars reasonable?	Rating	3.38 Good
Where are you most likely to attend our seminars: (Put "1" for 1 st choice, "2" for 2 nd , etc.).		1 st Choice 1 st or 2 nd Choice
• Chicago, IL	Preference	25-30% 30-35%
• California (Bay Area)	Preference	10-15% 25-30%
• Colorado	Preference	10-15% 20-25%
• California (Southern)	Preference	5-10% 20-25%
• Miami, Florida	Preference	5-10% 10-15%
• Seattle/Vancouver (Write-In)	Preference	5-10% 5-10%
• Canada (Toronto), New England, Washington, D.C.	Preference	0-5% 5-10%
• Atlantic States, Texas, Australia, Michigan, UK (Write-In)	Preference	0-5% 0-5%

What particular topics would you like to see in our next event?

- Spagyrics Yes / No 61% Strong
- Mineral Alchemy Yes / No 61% Strong
- Qabala Yes / No 55% Strong
- Esotericism Yes / No 45% Medium
- New Courses of Jean Dubuis Yes / No 45% Medium
- "Mind Machines" Yes / No 24% Weak

What are the best months for you to attend seminars?

- July, August Yes / No 60-65% Strong
- Jun Yes / No 55-60% Strong
- Apr Yes / No 30-35% Medium
- May, Sep Yes / No 35-40% Medium
- Jan, Feb, Mar, Oct Yes / No 20-25% Weak
- Nov Yes / No 10-15% Weak
- Dec Yes / No 0-10% Weak

Yantras and Alchemy

by Joseph Caezza
Part Two

Editor's note: An editorial error occurred in Yantras and Alchemy, Part One, [The STONE, issue #20, pages 17 & 18]; Figure 3 and Figure 4 should be transposed. We apologize both to the reader and the author. RG

Tantric ritual worship utilizes yantras, geometric symbols of cosmic unity, with the same essential intention that an operative alchemist utilizes laboratory apparatus. Both disciplines rest upon similar metaphysical foundations that clarify the man / cosmos relationship as an interplay of principles and elements. Implicit within this interplay is the fundamental experience of unity within the diversity of Nature and the dynamic impulse of reintegration into the creative source.

Certainly the best known yantras remain those of the DASA-MAHAVIDYAS (figure 1), the ten great wisdoms known as the ten forms of the great Goddess.

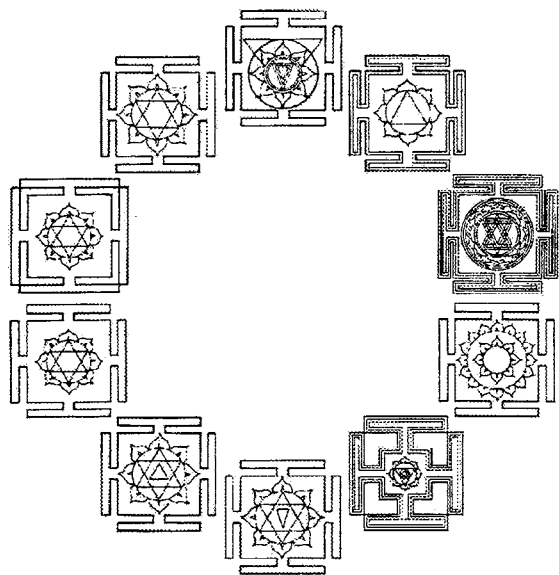

Figure 1: Yantra Cluster of the Ten Great Wisdoms

These icons depict the power of time and the cycles of life that Hermes Trismegistus describes as THE OPERATION OF THE SUN in his EMERALD TABLET. They express aspects of the universal archetypal process of nature. This process noted in the admonition: SOLVE et COAGULA, refers to the dissolution and re-coagulation of the various forms of

matter in Nature until as the adepts admonish: the fixed becomes volatile and the volatile becomes fixed, matter reintegrates into spirit.

Kali, the first and foremost of the ten forms of the Goddess constitutes symbolically the supreme primordial generative energy. Although popularly depicted in her destructive form she is the power of time and the functional cause of material Nature. Her favorite haunt is the cremation ground where she goes about naked, her body adorned with a necklace of human skulls. She bears a sword in one hand and a severed head in the other. Pop movies such as the Beatle's HELP, INDIANA JONES AND THE TEMPLE OF DOOM and the more recent TEMPTRESS have made Kali a familiar image in late twentieth century culture. Curt Kobylarz-Schmit in his legendary 1996 presentation, THE STONE OF THE WISE AND UNWISE, remarked on the mysterious homology between the element 'Potassium', known in Latin as Kalium and the regenerative mythology of the Hindu Goddess Kali.

The Merk Index describes Potassium as a violently reactive metal whose soft silver luster tarnishes black upon exposure to the air. Tradition recognizes the Goddess Kali's intensely black skin to be among her foremost attributes. Potassium is the seventh most abundant element in the Earth's crust and a key metal of the vegetable and animal kingdoms. Like other metals in the alKALI column of the Periodic Table, Potassium causes burns if touched and produces an explosive reaction with water to form an alKALI or base. Hydrogen, the bindu or seed element (see: figure 1 in THE STONE No. 17) is classified on the Periodic Table in the first column of alKALI metals. A correct understanding of the functional power of the Goddess Kali is the key to vegetative regeneration. The term 'Potassium' derives from 'potash', ashes of vegetable matter especially wood. Alchemical salt derives from leached ash. A critical ingredient in many elixirs is the salt extracted from the ashes of specific medicinal herbs. Adepts admonish us: SAL METALLORUM EST LAPIS PHILOSOPHORUM, the salt of metals is the stone of the philosophers.

Ash holds an especially auspicious place in Hindu religious culture. Ritual supply "vibhuti" shops, literally "ash" shops routinely sell it as one of the most common sacred objects. Wandering holy men dispense ash as a blessing. Siva, Kali's consort is known as Bhasma-Priya, ash loving. Yogis belonging to alchemical brotherhoods

indulge in the ash bath, Bhasma-Snana , covering their bodies with ash. The virtue of such an act is thought to be a panacea for all ills. Ayurvedic medicine utilizes Bhasmas, metallic ashes as powerful remedies.

Kali's yantra (figure 2) usually consists of a nest of downward pointing triangles situated in a lotus of eight petals. The petals denote the essential elements: earth, water, air, fire, ether, mind, intellect and ego-sense. These elements indicate the fundamental composition of the phenomenal world.

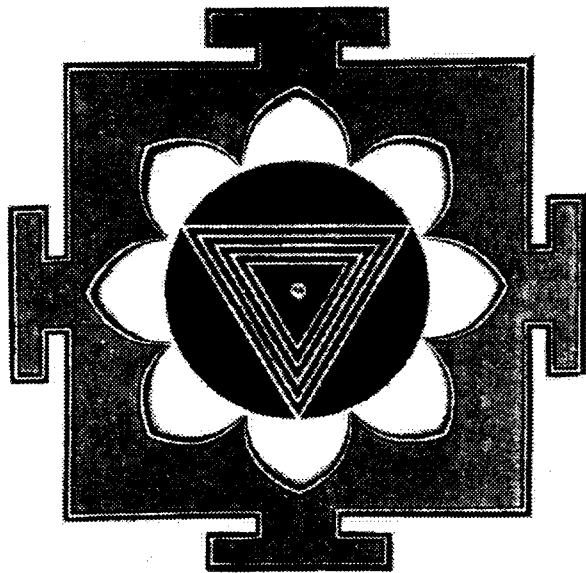

Figure 2: Kali Yantra

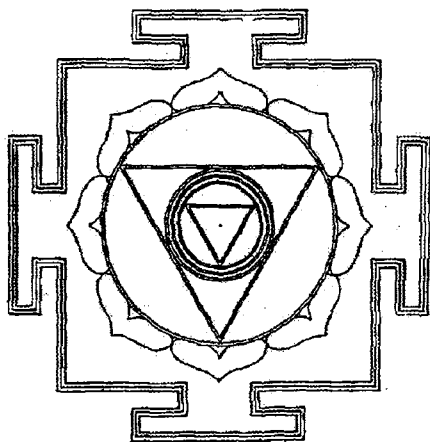

Figure 3: Chinamasta Yantra

Chinimasta, another alchemically intriguing form of the Goddess is represented by a yantra (figure 3) that bears vague resemblance to the tenth key of Basil Valentine

(figure 4).

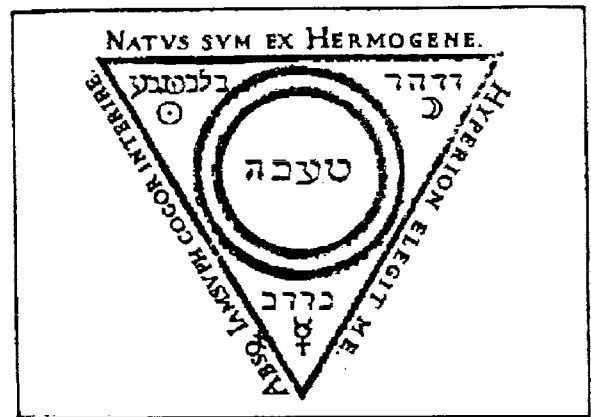

Figure 4: Valentine's 10th Key

Chinimasta, a more extreme extension of Kali, symbolizes transcendence of the senses by cutting off her own head, the seat of the senses (figure 5).



Figure 5: Chinamasta Icon

She tramples a copulating couple to further manifest sensual transcendence. Her icon explicitly represents spiritual resurrection. After beheading herself she continues to dance. Three streams of blood flow from her neck. She drinks the central stream apparently representing kundalini flowing up the central channel. The icon of Chinimasta also evokes the alchemical praxis of the Roger Caro school which Curt Kobylarz-Schimdt explicates as the "dry" path. Herein a metal sulfide, commonly realgar or cinnabar is imbibed with an alkaline solution causing it to give up a red oily quintessence which floats to the surface. This red oil is decanted and later reimbibed. The metal sulfide, for

example the mercury and sulfur of cinnabar represent the copulating female and male trampled by Chinimasta. Chinimasta is the al-Kali-ne salt prepared from ashes usually derived from oak, lime and dew. The red quintessence analogous to Chinimasta's blood is said to have transmutative virtue.

Adam McLean in Volume 6 of the Magnum Opus Hermetic Sourceworks series, The Rosary of the Philosophers, briefly notes the similarity between the icon of Chinimasta and the first woodblock print from the Rosarium series (figure 6).

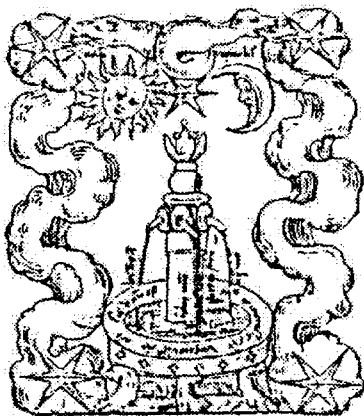

Figure 6

The homology of symbolic forms goes deeper. The copulating couple trampled by Chinimasta is represented in the fifth woodcut (figure 7).

Her essential symbolism of resurrection appears in the nineteenth and twentieth woodcuts (figure 8). These depict the fourth and first glorious



Figure 7

mysteries of the Roman Catholic Rosary.

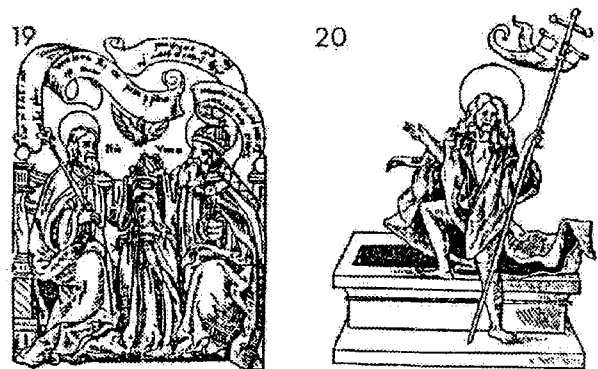

Figure 8

When I first encountered the living saint, Sri Amritananda, of Andarpradesh, India, formerly known as Dr. N. P. Sastry, from his days as a nuclear physicist, I explained to him how this apparently macabre image of Chinimasta had long haunted me. He initially remarked ah, Chinimasta, regeneration through self sacrifice! The alchemical implications of such a remark need no explication.

A few years later I visited him in India just a few days before the dedication of his unique temple built in the form of the Sri Yantra (see: THE STONE, No. 20). He asked me to paint images of the ten forms of the Goddess on a dome shaped auxiliary temple used for fire sacrifice. I placed the image of Chinimasta strategically to face the main yantra temple (figure 9).

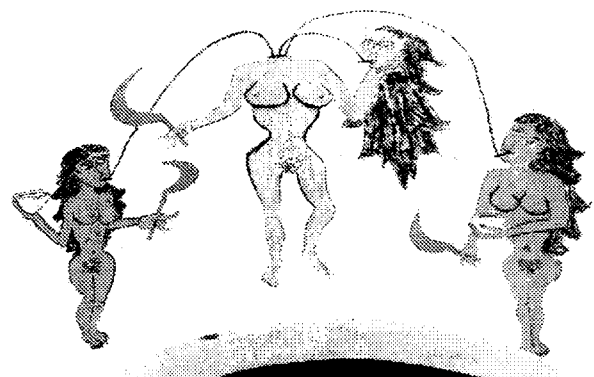

Figure 9: Painting of the Goddess CHINAMASTA on a dome temple wall in Andarpradesh India.

Certainly the same impulse that generated the Tantric icon of Chinimasta also manifested itself in the woodcut illustrations of the 1550 edition of The Rosary of the

Philosophers. The unspeakable esoteric dimension of this impulse depicted as a fountain with three spouting streams or the three streams of blood flowing from the headless body of the Goddess might illuminate the ultimate mystery of physical regeneration. A recent eyewitness account of Kaya-Kalpa, the yogic science of attaining a glorified immortal body calls to mind these images:

The old swami exhaled loudly and a kind of white, thread-like material began coming out of his mouth. He caught it with his hand and drew it out. He cut it into three pieces. After pausing to perform ritual worship, he held one piece in his hand, chanted some mantras and dropped it in the fire. Then he took the second piece of the threadlike breath, chanted mantras and placed it into the fire. Finally, he took the third piece and followed the same routine, but this time he did not put it in the fire but simply carried it near the fire and ate it.

After a while, the old swami's belly began to swell. It got bigger and bigger until it burst. A bright, young body, radiant in character, came out from the belly of the old swami. The bright, radiant young body took the dead body of the old swami and threw it into the fire of the ceremony and left the place.

(1) Certainly the phenomenology of this Kaya-Kalpa process is far beyond the comprehension of the uninitiated. It seems to hint at the deeper esoteric significance of Chinimasta drinking her central stream of blood as a prerequisite for regeneration. The final Rosarium woodcuts depicting the bodily assumption of Mary into heaven and the resurrection of Christ imply a similar physical regeneration. Here appears the consummate alchemical accomplishment. The fixed becomes volatile and the volatile becomes fixed. The adept achieves the simultaneous identity of these two apparently opposing states.

Reference:

1. Satyeswarananda Giri, Swami, Babaji: The Divine Himalayan Yogi, Sanskrit Classics, San Diego, 1984, pg. 81

Acknowledgment: To Thomas Ramsay for his insight into the Caro praxis Chinimasta connection.



Alchemical Gardening

by Rick Grimes

Part Two

To those who enjoy putting their hands into rich garden soil there is nothing better than dark loam. It smells of life, it feels of life, its cool dampness invites seed to nurture and bring forth a succulent harvest. Yet, no matter how wonderful the loam or poetic our point of view, the hard facts are these: a garden cannot become beautiful, wonderful, abundant, and productive by itself—there is no magic. It needs help from a conscientious gardener. It needs to be maintained.

The first requirement of a good maintenance plan is proper tools that fit the size and type of garden plot you plan to make, or manage already. The basic tools are a trowel, a small shovel, rakes, both stiff and spring, lopping shears, hose, water wand, sprinkling can, gloves, a one handed cultivator claw, and a hoe. A garden cart, a few buckets, a ball of twine, and a tape measure are handy, too. With these, one can basically manage any reasonable sized back yard garden. However, with a minimum of three small hand held tools (see figure 1) an apartment dweller can even make an area of their patio into a surprisingly productive garden with a variety of vegetables and flavorful herbs.

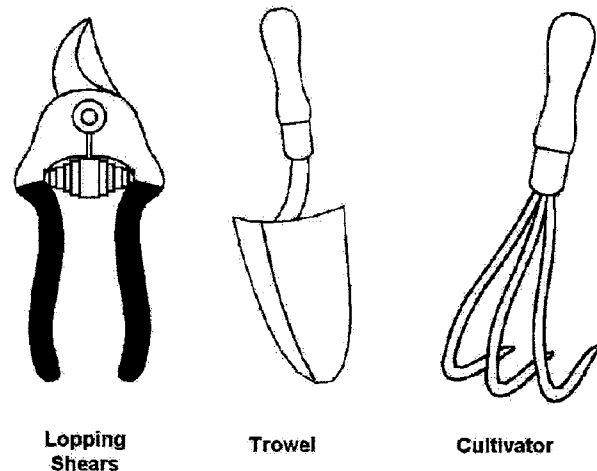

Figure 1

Plotting :

Plotting is the next aspect of a well organized garden as it is key to the highest production at the lowest cost in time and effort. Those of you who garden and live in homes that have ample yard space most likely have

traditional row gardens. Back yard garden plots that are laid out in rows will normally cover areas as small as 6' x 6' to as large as perhaps 20' x 100'. Anything larger might be classified as a professional garden. So often these gardens start with great energy and enthusiasm going into them but soon lose out to weeds and insects and a discouraging low yield for the gardener. Row gardens require more tools, more compost and fertilizer, and much more time than do the alternative square foot type plots. Since most experienced gardeners are comfortable with larger plots and their successful upkeep, I will focus on the square foot concept for the new gardener or the gardener who only has confined space to work in. For those of you who are interested in this approach I highly recommend Square Foot Gardening, by Mel Bartholomew.

For example: The townhouse or apartment dweller who may be confined to a small yard, a patio, or just a balcony in a high-rise apartment or condo, can manage a productive garden. If you are that person and you've longed to get your hands into soil, the square foot approach may be your answer. In figure 2 you will see the perimeter of a small 12' x 10' yard lined with 12" square vegetable and herb plots contained in one foot boxes.

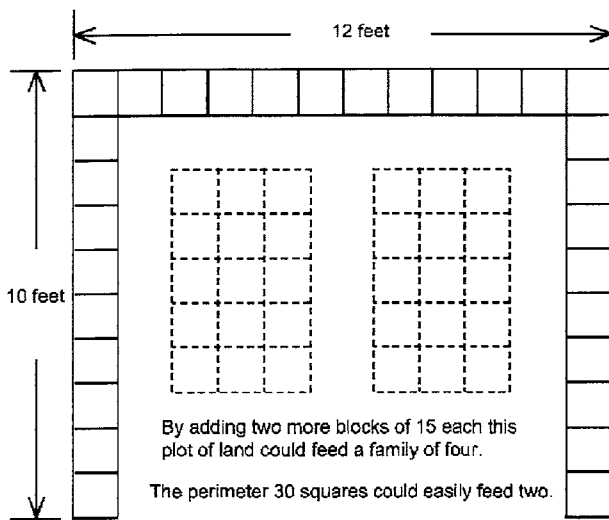

Figure 2.

The next illustration, Figure 3, shows a 4' x 4' tiered block in the small back yard that is both esthetically pleasing and productive. Also in figure 3, for the more adventurous gardener one-foot square boxes can be arrayed in many novel ways that give a pleasing appearance and easy access, without sacrificing

production goals. There is no limitation to what you create as long as you can get to the plots easily. A mixture of round containers, square box containers, large rocks, and selected trees and shrubs will make a beautiful garden that produces results. Just add a pond and you'll have paradise.

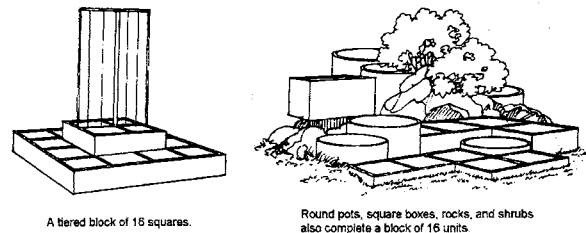

Figure 3

Balconies offer more possibilities than one would think. Carrots, lettuce, radishes, tomatoes, spinach, and even small squash, can be grown on patios. Figure 4 shows how one could manage on a small balcony with one-foot containers and herb boxes hanging on the railing.

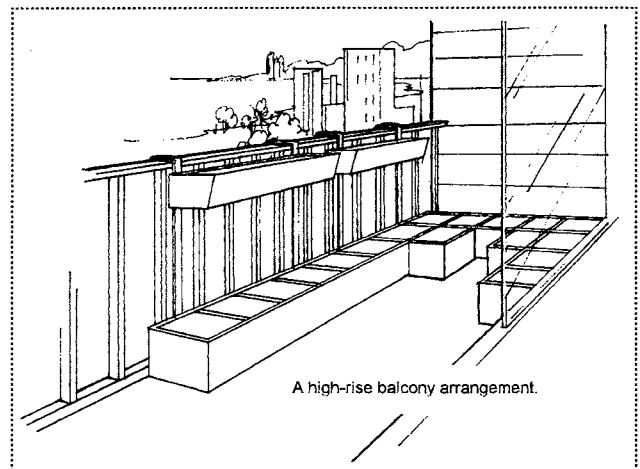

Figure 4

In square foot gardening a "Block" is a plot 4 feet by 4 feet or 16 square feet. This will supply one person through the growing season. (Two people will require three blocks but no more than 4). With a vertical frame at one end of the block, Mel Bartholomew asserts that if one were to begin planting in March, harvesting until the warm weather when you would plant your tomatoes, you would have harvested 4 heads of Oak Leaf Lettuce, 16 standard sized carrots, 9 bunches of spinach, 32 radishes, 16 scallions, 4 heads of Salad Bowl lettuce, 16 beets – plus 4 bunches beet greens, 5 pounds sugar snap peas, 4 heads Ruby lettuce, 9 Japanese turnips, 8 bunches Swiss

chard, 1 head cabbage, 4 heads romaine lettuce, 1 head cauliflower, 1 head broccoli, and 16 small, round carrots. "Amazing," you might say. "From only 16 square feet in two months!"²

Once your spring crop is harvested you can then plant your summer crop in the same 16 square feet. Your maintenance time is reduced to practically nothing in proportion to the yield you will realize. It takes about an hour a week to weed, water, cultivate, and control pests, in each block. If you plan to harvest your seeds allow the *best* plants to go to seed. In some cases you may wish to separate the seed producing plants into another block or a pot to allow for the next series of plantings in the block to proceed without interruption. Remember to save the plant leaves, stems, and roots for recycling (see part 1, The STONE, issue #20).

For an apartment with a small patio, I recommend a 3' x 3' block per person instead of 4' x 4' each, unless you do have the room. See figure 5.

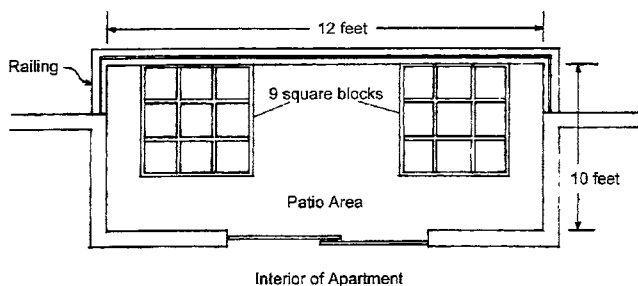

Figure 5

Also, there are innovative ways to create elevated garden beds to a waist high level which eliminates having to bend over. A similar design can be fashioned to easily accommodate a wheelchair bound gardener.

Maintenance:

During the one hour (or less?) per week maintenance you will probably use your claw to loosen the soil around each plant while at the same time adding any additional compost mixture, especially if you are feeding earth worms that you have put into the soil. Then, mist the plant leaves only if they are heavy in dust, otherwise allow them to remain dry. Water the soil by using *warmed* water by cupfuls at plant base or by watering the whole bed with a sprinkling can. Have a cup of coffee or tea while the soil soaks, then you can easily pull out weeds that have started to grow – roots and all.

Pick off any shriveled buds, brown leaves, or infected plant parts, then make your insect inspection and spray where appropriate, and that's about it

Pest control:

There are hundreds of books on the subject of garden pest and insect control, organic and inorganic sprays, powders, whistles, ultrasonic devices, and old fashioned scare-crows. This little article is not the place to explore this subject, but a couple of suggestions are worth mentioning. Years ago, when I lived in Salt Lake City, I was told by an old neighbor who had a rather impressive organic garden, that garlic was the best thing for keeping away insects.

She put two to four large fresh garlic cloves in a pint of warm water and blended them thoroughly. Next, she filtered the thickened liquid through a fine strainer and put the filtered liquid in a spray bottle, diluting with warm water if necessary. Then she sprayed her plants while the liquid was still warm, and only when the sun was up, to quickly evaporate the water leaving the garlic oil on the plant and leaves. She did this once a week or after every rain shower.

Other powerful plant derived pesticides like pyrethrum, or rotenone, are excellent and break down readily, preventing ill effects to animals or humans. Lady bugs and praying mantis are friends and should be encouraged to live in your garden. Salt water baths and clear water rinses will help control green worms and aphids, respectively. The best approach is *preventive* from the start. Make sure you start with healthy disease free plants, and good rich pH balanced soil. Use mulch devoid of seeds, meat or milk products, diseased plants, or toxic chemicals, and inspect your plants every day.

Another tip from a reader. For protecting back yard gardens from foraging rabbits, it is recommended that Marigolds be planted tightly around the perimeter of your garden plot. Rabbits don't like the Marigold pollen.

Drainage:

Drainage is important so you don't have "Wet Root". A layer of gravel in the bottom of a pot, or box, will usually eliminate the problem as long as you don't over water. It is good to have drainage holes in the bottom of pots that allow the water to drain into a an evaporation tray. To prevent unwanted drainage and staining on a patio, the box can be lined with plastic sheeting with a

1" - 2" layer of gravel in the bottom. See figure 6.

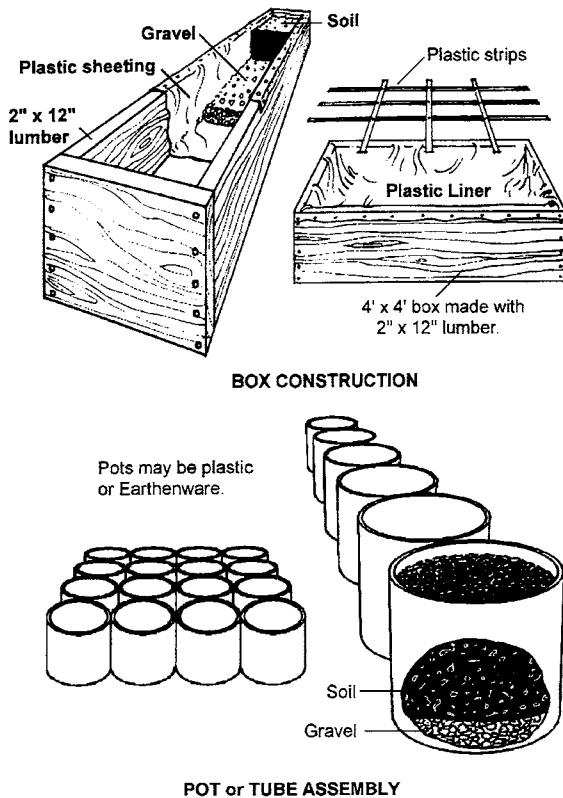

Figure 6

Preparation of your block:

The block can be made using 2"x 12" boards, or rows of 12" to 14" diameter pots or tubes.

Concluding thought:

Imagination is your greatest asset when designing your little square foot garden. It can be as innovative as you want to make it. A personal garden is a wonderful alternative to grocery shopping and though they don't supply all your needs, they offer an enjoyable recreation, some food, and the satisfaction of the harvest -- even in the city.

Bon appetite!



Self-Healing Archaeous

By Rawn Clark

Until fairly recently, the most common philosophy underlying the treatment of disease was the idea that healing could be best accomplished by strengthening the body's own natural mechanisms of self-repair. The vision of today's western medicine however, has shifted focus from strengthening the human body, to artificially regulating it; and from healing the human body itself, to destroying the bodies of specific invading organisms. Perhaps in moderation this is a wise and appropriate tactic for our times -- times in which it seems the human immune-system faces insurmountable challenges -- but dare we head so recklessly and with so little forethought, toward completely writing-off our bodies' own natural powers?

I for one, say "no". I think we must cherish and nurture these powers. If we combine them with our western medical approach, perhaps then we will find the ability to transform space with our changing environment. This at least, has been my particular approach to healing, and it is a bias which you will find echoed throughout this Archaeous.

Healing is a topic which concerns me both practically and philosophically. For example, I do not equate "healing" with "cure", though I really like it when they coincide! I see that struggle, pain, and death, are each as healing in their own ways as are ease, pleasure, and re-birth. They are all inevitable in life, so for "health" to really mean anything, I believe it must encompass them all and empower one to creatively adapt to them all. To me, "health" does not equal "living forever". My personal sense of health, is defined by the quality of my life, not by its duration.

Self-healing is a part of my magical practice. As such, my approach to self-healing is as varied as the magical Traditions I have practiced -- multiplied, of course, by my unleashed imagination. The specific techniques of the Self-Healing Archaeous, stem directly from my work with Franz Bardon's excellent book, "Initiation Into Hermetics".

Like Bardon, the Archaeous defines three "bodies" which correspond to three "realms": Mental, Astral, and Physical. The healing effects of the Archaeous are achieved through the conscious manipulation of these three bodies, and most especially, through their

integration.

At every step in the Archaeous, one works in conscious cooperation with the pathways of influence and power which Nature herself provides. The technique mimics one of Nature's most essential processes: Integration + Separation + Re-integration . . . the rhythm of life itself. To this fundamental equation, is added the practitioner's own magical will, along with the focus of healing.

Prerequisite to beginning work with this Self-Healing Archaeous, I recommend that you undergo a sincere process of self-discovery. We each come to know ourselves by our own unique paths -- some with concentrated effort, some with apparent ease, some only by graduation from the "School of Hard Knocks", etc. -- so I won't presume to dictate how you specifically should go about this task. It is imperative that you understand however, that for healing effects to reliably result from the Archaeous practice, you must have first healed (by whatever means) the most basic wounds which frighten you away from self-knowledge. If these wounds are still raw within you, then please address them prior to pursuing the Archaeous. Otherwise, the Archaeous may prove distressing to you, and you will risk manifesting only the negative pole of the healing continuum.

When approached from a well grounded and honest knowledge of one's self, the healing effects of the Archaeous will be affirmative of one's inner health, and will directly externalize it. As is Nature's way, what you sow, will determine what you eventually reap.

RAWN'S SELF-HEALING ARCHAEOUS

Stage #1) Healing through discerning and integrating your three bodies –

Integrating the Physical:

Situate yourself comfortably. Turn your attention to your feet and relax them completely. Intimately experience every physical sensation that your feet relay to you at this moment.

Slowly move your attention up your legs, relaxing and connecting with each vein, muscle, bone, organ and patch of skin. Continue upward in this manner till you have established a clear and relaxed awareness of your entire physical body.

Though certainly healing in its own right, this primary step of connecting closely with your physical body, is a common one and therefore is not counted among the Archaeous' thirteen enumerated "levels" of healing. In effect, this step corresponds to zero and, quite appropriately, it is where the Archaeous both begins and ends.

Integrating the Astral:

With your awareness thus spread evenly throughout your physical body, expand your focus outward a few inches till you sense your astral body's vibrant energy. Though difficult to adequately describe, once it is encountered and experienced, the feeling of the astral body's "bright" energy will be unmistakable.

Generally, it is physically stimulating -- for some people, it is dangerously so. Therefore, it is best to approach a conscious sensorial contact with your astral body, in controlled and small

increments. Begin with just a few brief moments of contact with this energy, and then immediately restrict the focus of your awareness back down to the dimensions of your physical body.

Whatever energy you feel stimulating your physical body, must then be consciously integrated into your physical muscles, bones, organs, skin, etc. By mentally guiding this bright astral energy into your physical body, into your very cellular structure itself, you effect the first level of healing in the Archaeous.

Acclimate your physical body to your astral energy slowly. Your goal over time, is to be able to comfortably sense your entire astral body and consciously integrate it into your physical body. Your focus at this point is not to be upon "astral travel" or the separation of your astral form from your physical; rather, it is to be exclusively

When approached from a well grounded and honest knowledge of one's self, the healing effects of the Archaeous will be affirmative of one's inner health, and will directly externalize it. As is Nature's way, what you sow, will determine what you eventually reap.

upon the integration of the two.

Again, a note of caution is in order: The astral body acts as a matrix for the physical body. Its bright energy is the medium through which the mental body determines the nature of its physical vehicle. The character of the astral energy, is that it is shaped by the mental level (thought and will); and in its own turn, it shapes the physical level.

Therefore, when you consciously (mentally) connect with your physical body and then expand that awareness to include your astral body, you will have opened nature's own pathways of healing. Consciously integrating your astral matrix into your physical body, grounds this bright energy into physical manifestation, bringing your physical body into closer accord with your astral matrix.

At this level of work, your magical will substitutes for nature's unaided will. If you have not performed the preliminary work of self-discovery and have not crafted an intimate knowledge of your inner self, you may find nature's power to be more than your will can manage. The danger is that nature's power, when mishandled, can easily become the relentless cause of unexpected side-effects. In this Archaeous process, whatever your mental body has expressed -- consciously and unconsciously -- through your astral matrix, will be powerfully impressed upon your physical structure. If you are at peace within yourself, then the Archaeous will be immediately healing and will bring your inner peace outward. But if you are filled with inner turmoil, the Archaeous' healing will be very painful as your inner turmoil progresses outward.

Integrating the Mental:

Having reached the stage at which you comfortably experience your physical body, simultaneously permeated with the bright energy of your astral body, turn your attention inward upon your conscious awareness itself. This is your mental body. You have, in fact, been directing this whole exercise with your mental body.

When you first turned your attention to your feet, it represented a movement of the focus of your conscious awareness. You contracted, shifted, and then expanded this focus, eventually including your entire physical and astral bodies within its purview. These are the actions of one's mental body, and are representative of its fluidity, adaptability and subtlety

At first, its dimensions are difficult to discern, but this is

only because our mental bodies are an utterly integral part of our experience of self and of our mechanisms of perception. In sensing the dimensions of your mental body, you must strive to see the forest from amidst the trees, so to speak.

Hold these thoughts in mind now as you consciously shape and shift the focus of your awareness, working up from your feet till you have reached the point where you are aware of your entire, relaxed physical body. Spend some time in this state, actively meditating with the idea that the parameters of your awareness, are also the parameters of your mental body. Learn to sense those parameters first; and then once they are known, work toward conscious control of them.

Now expand those mental parameters till they include your astral body, keeping in mind the following two points: #1) It is your mental body which is expanding. #2) Your mental body experiences this expansion through the sensoria of your astral and physical bodies.

Consciously permeate every bit of your astral body's energy, and carefully integrate your mental body into your astral form. When you have intimately joined your mental and astral forms, turn to integrating them thus united, into your physical body. Spend some time in this state, meditating on the awareness of your three bodies joined together.

This is the second level of healing in the Archaeous, and completes the first and most important stage of the Archaeous -- *conscious integration*.

Stage #2) Healing through separating and resting your three bodies --

Vacating the Physical:

Sit comfortably or lay down in a place where you are certain you will not be disturbed. I advise that you also cast a magic circle of protection around your body.

With the full awareness of your three bodies well integrated, restrict your mental body's focus and concentrate on the feel of your bright astral energy. Now attempt to slowly and gently stand up with only your astral and mental bodies, leaving your physical body seated (or lying).

This may (or may not) take many hours of repeated

experiments to accomplish. If you have difficulties at first, then begin by trying to move only your astral-mental arm, and slowly work your way to a whole body movement.

You will find that your astral-mental body feels very, very like your physical body. This is so because it is really your astral body which houses your senses . . . the physical organs of sense, are merely the apparatus through which the astral body perceives the physical world. So, whether a stimulus is generated in the physical or the astral realm, the mental body still perceives it through the sensoria of the astral body.

At the same time, you will find your astral-mental body to have very different abilities than your physical body. At first you may want to fly off in celebration of the sense of freedom which the separation of your astral-mental body generates. For the purposes of this Archaeous however, you must fight this tendency for the moment and not stray more than a foot or two from your physical body. Your focus here, should be upon a gentle, controlled separation and not upon "travel".

When you have succeeded in standing up with your astral-mental body, turn around and examine your physical body. Concentrate intently upon the separation of your sensoria from your physical body. Transfer the control of your physical body's breathing to the rise and fall of your astral-mental body's heat.

Concentrate upon the sensations throughout your astral-mental body, and let go of those you may still be receiving from your physical body.

Only in death is the astral-mental completely severed from the physical. While you live, no matter how advanced your magical skills, there will always remain a thread-like connection between your three bodies upon their separation. This thread of connection is a very real thing and is injured in very real ways by "snapping" -- either back into your physical body, or abruptly out of your physical body. To prevent trauma to your astral-

mental umbilicus, take great care to: a) make sure you will not be physically disturbed while you work; and b), always separate your bodies gently and slowly.

This thread of connection also means that you cannot completely separate your astral-mental sensoria from perception of (at least the stronger) physical stimuli. These are simply Nature's ways. Nonetheless, you can isolate your awareness and then, even though some physical sensations may still impose themselves upon your astral-mental sensoria, you can limit the extent to which they draw your attention back into your physical body. By turning and examining your

physical body, you increase the reality of your separation. This increases further as you shift your full awareness of sensation from your physical body to your astral-mental.

If you are comfortable standing still in your astral-mental form, then slowly walk around, straying no more than a few feet from your physical body. Concentrate on all the astral-mental sensations of walking, feeling the movement of your astral-mental limbs and the touch of your astral-mental feet upon the floor.

Now turn again to your physical body. Observe that its rhythm is slowing and that every part of it is completely relaxed. This is the resting of your physical body and is the third level of healing in the Archaeous.

Vacating the Astral:

Turn your attention now as completely away from your resting physical body as you can. Concentrate again, upon the feel of your astral-mental form alone. Lay down on the floor, making sure to feel each movement of your astral-mental body.

Slowly, and this will take control since your impulse will be to fly off, arise from your astral body, with your mental body alone. Disconnect your mental body from all astral sensations as thoroughly as you can. Observe your astral body from directly above and watch as it too slows and rests. This is the fourth level of healing in the

By turning and examining your physical body, you increase the reality of your separation.

Only in death is the astral-mental completely severed from the physical. While you live, no matter how advanced your magical skills, there will always remain a thread-like connection between your three bodies upon their separation.

Archaeous.

Resting the Mental:

Still your mental body and turn its focus inward and away from your astral and physical bodies. Enter into a passive meditation for several minutes and rest your mental body. Note how it slows and clarifies. This resting of your mental body is the fifth level of healing in the Archaeous and completes the second stage -- *conscious separation*.

As each of your bodies rest, they naturally revert to a more pristine and healthful state, very similar to the physical effects of sleep. The act of letting them rest separately, decreases the input from one level to the next, thus increasing the depth of their rest. Without the active impress of the astral energy, your physical body rests more calmly and completely than even in sleep since it is undisturbed by dreaming. Likewise, your astral body, separated from both physical and mental input, rests as it rarely does in the course of a normal human life. And freed from both astral and physical restraints, your mental body can be led to a very deep state of restful calm.

Allow at least five minutes of rest for your mental body. Adding in your working time, this will equal about ten minutes of rest for your astral body, and at least fifteen minutes for your physical body. If you have worked through the separations in less than ten minutes, then extend your mental body's rest until your physical and astral bodies will have rested at least these approximate amounts of time.

Stage #3) Healing through re-integration of your three bodies --

Re-integration of the Astral-Mental:

Arouse your well rested mental body and turn your attention to your reclining astral body. Gently and willfully re-join your mental and astral forms. Re-integrate them, thoroughly permeating every aspect of your bright astral energy with your conscious awareness. Stand up with your astral-mental body, paying very close attention to the sensorial details of your astral-mental movements.

The re-integration of your well rested astral and mental forms is the sixth level of healing in the Archaeous.

Re-integration of the Physical:

Turn your attention now to your rested physical body. Gently and willfully re-join your astral-mental form with your physical body. Consciously lead the bright astral-mental energy into each and every cell of your physical structure, re-integrating your three bodies completely. Perform this final re-integration with careful attention to its thoroughness.

While it is important to not return too abruptly to normal waking consciousness and to the animation of your physical body; it is nevertheless of equal importance that you do return to this state, and that you return as completely as possible. Once you have re-inhabited your physical body, gently increase your connection with it, and slowly work your way to its full re-possession. Finalize your grounding back into normal waking consciousness with a gentle physical movement such as running your hands lightly over your entire body -- from the top of your head, down to your toes.

Under no circumstances should you transit directly from the re-joining of your astral-mental with your physical, to standing up and physically moving around. The conscious integration of your three bodies is the most healing aspect of the Archaeous practice, so if your re-integration is only partial, the healing benefits will likewise be only partial (i.e., non-existent, or at best unpredictable).

Having first integrated, then separated, rested, and now finally re-integrated your three bodies, you will have reached the seventh level of healing in the Archaeous. This marks the completion of its third stage -- *conscious re-integration*.

These seven levels of healing constitute the basic formula of the Self-Healing Archaeous. This equation is based upon the number 3 and is expressed as a three-fold process (integration+separation+re-integration), enacted upon a three-fold being (mental+astral+physical). Another way of putting it would be: $(3 / 1) \times 3$.

When you have mastered this triple-triple process, the next step will be to turn to the inclusion of the number 4. This is done by factoring in the four universal Elements: Fire, Air, Water and Earth. Harmonizing the Elements in each of your three bodies, opens you to still further levels of healing possible with the Archaeous: viz., $(3 \times 4) \times 3$.

Stage #4) Healing through the Elemental balancing of your three bodies --

Mental Equilibrium of the Elements:

Work through the first two stages of the Archaeous, up to the point where you have separated and rested your three bodies. The following will replace the third stage of the Archaeous proper: Arouse your rested mental body and fill it with equal portions of the four pristine, universal Elements. Follow the sequence of: Earth-Water-Air-Fire, starting with Earth at the "foot" of your mental form, working upwards and ending with Fire at the "top". Balance the Elements in your mental body and rid yourself of any excess you may have accumulated. Bask joyously in this re-vivifying Equilibrium! The Elements thus balanced in your mental body, is the eighth level of healing in the Archaeous.

Only now, at this stage, do we turn to astral and mental "travel". Such travel, when entertained without a prerequisite Equilibrium of the Elements, can easily do harm to your health.

Astral-Mental Equilibrium of the Elements:

Turn your attention now to your reclining and fully rested astral body. Gently sink down into it and regain full awareness of it. Consciously permeate it as before, linking your astral and mental bodies intimately together. When you are ready, stand up with your astral-mental body, paying close attention to reconnecting the astral sensations. Stand still and closely integrate your astral and mental bodies.

Consciously vitalize your astral body with the Elemental Equilibrium of your mental body. Bring the balancing influence of your re-vivified mental body firmly into all aspects of your rested astral energy.

Now fill your astral-mental body with equal portions of the four pristine, universal Elements: your astral-mental legs with the Earth; your gut with the Water; your chest with the Air; and your head with the Fire. Balance the Elements in your astral-mental body and rid yourself of

any excess you may have accumulated. Bask anew in the re-vivifying Elemental Equilibrium! This marks the ninth level of healing in the Archaeous.

Physical-Astral-Mental Equilibrium of the Elements:

Look now to your well rested physical body, and gently re-enter it. Extend yourself into its every cell, reconnecting fully with the awareness of your three bodies together. Animate it carefully and thoroughly with the balancing influence of your astral-mental Equilibrium.

Now fill your physical-astral-mental body with equal portions of the four Elements as before. Balance them, and then rid yourself of any excess. Concentrate upon the sensations caused by this re-vivifying Equilibrium of your three bodies united. Integrate every bit of astral-mental energy you can into

your physical structure, consciously guiding it into every cell of your physical body. Release whatever excess energy remains.

The difference between mental travel and astral-mental travel is comparable to the difference between a daydream and a genuine dream. The greatest difference is that in astral-mental travel, like in dreaming, we have a full sensorial experience; whilst in a daydream or mental travel, we rarely have any sensory impressions other than sight and a mental form of "hearing".

Visualize your mental body as actively brightening and willfully giving direction to, the astral. Also visualize the physical conforming its structure into agreement with this renewed astral template. This final integration and balancing should be pursued with the utmost care and concentration.

This is the tenth (and a truly profound!) level of healing in the Archaeous. Inculcating the Elemental Equilibrium throughout your three bodies in this direct manner is "advanced" work and should be approached

with due reverence. Attainment of the integrated physical-astral-mental Elemental Equilibrium, marks the completion of the fourth stage of the Archaeous -- *conscious balancing*.

Only now, at this stage, do we turn to astral and mental "travel". Such travel, when entertained without a

prerequisite Equilibrium of the Elements, can easily do harm to your health. This is not to say that one must first pass through the specific process of this Archaeous to safely approach astral-mental travel. Equilibrium of the Elements comes to one by any number of routes. I cannot count the number of people I have encountered who possess this Equilibrium unknowingly, having attained it simply through the "school of life"! For many of these people, astral travel is an easy matter with no ill effects. Whatever your perception of the state of your internal Equilibrium is at this moment, be sure to pause before continuing and honestly evaluate the reality of its status. If you find imbalance, then for the sake of your health, please attend to the correction of this imbalance before you engage in astral-mental travel.

Stage #5) Healing through mental and astral travel.

Mental Travel:

Proceed as in #4 up to the point where your mental body has attained an Equilibrium of the Elements. Instead of turning your attention back to your astral body, you will turn your awareness outward. Travel beyond your circle with your balanced mental body, leaving both your astral and physical bodies behind; and, in your own unique way, seek out experiences which will augment your healing and clarify your Equilibrium. Try not to lose track of your focus upon healing during your travel.

When your travel has reached its natural conclusion, return to the circle containing your astral and physical bodies. Focus your awareness firmly back into your circle and examine your astral body. Proceed as in #4 with the process of balancing and re-integrating your astral-mental body and then your physical-astral-mental body. Pay close attention to incorporating what you have gleaned from your mental travels, into your astral and then physical bodies.

Often times, specific physical acts are required to fully ground the healing lessons of your mental travel into your physical body. Always follow through with the accomplishment of these tasks, or as noted in the re-integration of #3, your final results may be only partial.

Upon completing your final re-integration, focus upon the triplicity of your physical-astral-mental body. As you arise and begin physical movement, do so with the full awareness that your three bodies are working in unison.

Mental travel is common to our everyday experience, though perhaps as I have outlined it in this Archaeous it is not recognizable as such. Essentially, mental travel is any projection of your thoughts towards a focus other than your astral-physical sensoria. Intense thinking is a form of mental travel, as are daydreaming, meditation, etc. The focus of our conscious awareness (what we generally experience of our mental body) is a very subtle vehicle, capable of whatever our imagination contrives for it to do.

The mental travel of the Archaeous differs from common mental travel such as a daydream, because it is here made a conscious act of self-will and given the specific focus of healing. Furthermore, the Archaeous always ends with the thorough re-integration of your mental body and the lessons of your travel, into your physical-astral-mental unit. In common mental travel however, we

rarely take thought of re-integrating our attention thoroughly back into our physical awareness . . . consequently we spend a certain part of our time engaged in only partial contact with our physical realities.

When the lessons gleaned from your mental travel have been consciously integrated into your united physical-astral-mental body, you will have attained the eleventh level of healing in the Archaeous.

Astral-Mental Travel:

The difference between mental travel and astral-mental travel is comparable to the difference between a daydream and a genuine dream. The greatest difference is that in astral-mental travel, like in dreaming, we have a full sensorial experience; whilst in a daydream or mental travel, we rarely have any sensory impressions other than sight and a mental form of "hearing".

By consciously uniting your mental and astral bodies, you access a fuller sensorial experience for your travels. This integrates your otherwise strictly mental lessons, at the astral and mental levels simultaneously; consequently, the subsequent physical integration is more complete and more readily achieved.

Along with expanding your mental experience into a

sensorial one, the inclusion of your astral form will also tend to limit your travel possibilities. In other words, you will find that there are places you can reach with your naked mental body, but which you will find impossible to reach with your denser astral-mental body. Consider these factors well, and plan your astral-mental travel before you begin.

Proceed as in #4 up to the point where your astral-mental body has attained an Equilibrium of the Elements. Now venture outward with your fully integrated astral-mental body and seek your healing experience.

Under no circumstances should you separate from your astral form during your astral-mental travel . . . it is unwise to leave your astral form unattended in any place other than within the confines of your protective circle. If your healing takes you beyond the limits of your astral form, then plan ahead and divide your journey into mental and astral components. Accomplish your mental travel first; return to your circle and re-integrate your astral-mental body; and then, accomplish your astral tasks.

When your astral-mental travel is complete, return to your circle, orient yourself, and then follow the usual process of thoroughly balancing and re-integrating your physical-astral-mental body. This is the twelfth level of healing in the Archaeous and marks the completion of its fifth stage -- *conscious travel*.

Stage #6) Healing through integrated self-expression.

When you have mastered the foregoing, turn your will toward the prolonging of your integrated physical-astral-mental awareness.

Upon completing your final re-integration, focus upon the triplicity of your physical-astral-mental body. As you arise and begin physical movement, do so with the full awareness that your three bodies are working in unison. Sense the intimate details of your physical, astral and mental bodies simultaneously, and extend this awareness for as long as you are able. Work to make each moment and the actions which fill it, a fully conscious and intentional physical, astral and mental experience.

At first, the maintenance of this intensely focused awareness will be possible only for a few brief moments. With perseverance, you can willfully teach yourself how to expand those moments into seconds, then minutes, and

eventually into hours.

Self-expression of your integrated physical-astral-mental being, is the thirteenth, and ultimate, level of healing in the Archaeous and concludes its sixth stage -- *conscious being*.

* * * *

Completed March 23, 1997, at 8:45pm, PST. At this very moment, rising in the East, the ruddy disk of the partially eclipsed full Moon, with its small, crowning crescent of brilliant white, lies counterpoint in the sky to Comet Hale-Bopp, whose star-like core and twin tails fill the North-western horizon. Mars stands directly above the Moon, having already cast his redness into her pool of unveiled earth-shadow.

Awestruck by this magnificent celestial display, I am moved to offer this Archaeous as a humble gift of thanks to so generous a Universe! -- Rawn Clark



Woodcut: "Mercury and the Artisans"
by Hans Sebald Beham – 16th Century

An Interview with Dolores Ashcroft-Nowicki,

June 10 1996

By Mark Stavish, M.A.

Part Two

Part One ended as Mark and Delores were talking about the Power Self, or Yesod, which touches everything. Delores said, "Yet, we're sitting here on this immense knowledge, and nobody's taken notice of it because everybody says, 'Subconscious, the Lower Self, poohoo.'"

To which Mark replied, "That is the major problem that occurred in the last century with the Theosophical Society, and the reason for the formation of magical societies such as the Brotherhood of Luxor, the Hermetic Order of the Golden Dawn, and the reason for much of the cross-organizational membership. The Theosophical Society wasn't teaching anything practical, and it brought with it the Victorian/Indian prohibitions about sexuality. Since the subconscious and Lower Self are intimately related to sexuality, they felt something was 'wrong' with it."

Delores then exclaimed, "Oh, you know about that!!"

Now, we begin with Mark's next question:

Stavish: *How did you get the idea of writing a book on sex magic, The Tree of Ecstasy, since that is an idea so often related to the Eastern teachings of tantra?*

A.N.: Well I'll tell you. First of all, I was brought up with the whole idea that sex was a real good thing. Nobody ever told me that it was dirty, or it was wrong, or 'no dear, please don't touch yourself there'.

Stavish: *So, then, your parents were hippies, before there were hippies.*

A.N.: My parents definitely were not hippies, they were very straightly brought up. But, if I asked a question, I was given an answer. I've had two marriages, and between my two marriages six, or maybe you could call it seven lovers. Also, a part from, and besides my Qabalistic and hermetic training, I have a deep and abiding love for the Craft (traditional English witchcraft). In my training, I was made privy to some

very, very ancient and traditional Craft. In order to protect this, it was needed that I give blood oath to protect these things. But the blood oath was also mixed on a sexual level, the fertility of the land, the people, and the cattle. I worked with that particular group of people for four and a half years. I had copied all their stuff down by hand, because it was beginning to split up, and it was essential, fertility was a part of it, and the tradition was over one-thousand years old. I also went through Gardnerian stuff, not because I either thought a great deal of Gardner's stuff, it was mostly Doreen Valiente,

Gardner mostly went around and collected it. He missed half of it, they saw him coming, believe me Mark, they gave him what they thought he'd like. I have got, in my possession, more chants, and old songs, and old ways than Gardener ever thought possible. He was into this sort of 'star-clad' 'sky-clad' stuff, and believe me, in England, anytime of the year, it's too bloody cold to go sky-clad. It was an excuse to take their clothes off. I've never been one to deny what it is after all a God given gift, if we are going to use the G word. Because, very early, I understood the Yesodic center, is that around which all creation, and all magic flows. It is the be all and end all of magic.

Magic is sexual because it is creative. But you try telling that to people and they go nuts. Then you get people like Yvonne and Gavin Frost writing about tantra, when they haven't a clue what tantra is. I was sent their book on tantra for review, and I sent it back to the publisher and said, 'Look at this tripe!' I mean they're saying, you know, sort of come in and be a tantrist. Grab a partner and you know, either or, and sort of just find a hole basically and use it! This is not tantra. You go to the East and a Tantra guru will say to you, now you sit down and work for five years, and you don't even look at a member of the opposite sex.

Stavish: *One school of tantra suggests that sexual imager is to be used only symbolically. It is used for arousal, but was never meant to be taken seriously, as ritual intercourse. The old stories told about the Medieval Rosicrucians is that they took 'water spirits' for wives, and such, but that actual sexual acts were not part of the training. They wanted all the benefits of sexual imagery, without the actual practice of ritual intercourse. One Wiccan authority comments on homosexual covens as being a uniquely American contribution, and Gareth Knight has strong feelings about homosexuality in a magical context. What are*

your views of homosexuality, particularly in the magical context?

A.N.: As I said, I was trained in the Inner Light, which regards any form of homosexuality as, not only perverse, but an actual disease and they've come under a lot of criticism for this. I stuck my neck out fifteen, sixteen years ago, and said I thought this was wrong, that if anybody came into the SOL and were homosexual, as long as their intentions were right we would train them as far as they wanted or were able to go. Which we say of anybody - we will train you as far as you are able to go. Not everybody can make it through to an Adeptus Minores, and attain realization of their Higher Self. People are going to want to stay at a certain level, they are content, it is their first incarnation if you like working in the mysteries. They don't want to go farther. Others come into it, progress to where they left off last time, and are raring to go. I got vilified, and hauled over the coals, and slung out, well requested to resign from the Inner Light, because they felt there was a conflict between my working with the SOL and the Inner Light at the same time. So, yes, in a way I got kind of removed, and this was basically one of the reasons. Because I said, I don't care what your sexual proclivities are, what I do want is dedication, application, and loyalty.

Stavish: *Some esotericists have told me that they have trouble working with homosexuals in magical work, but not in mystical work. The reason offered was that magical rites required a polarity that wasn't as obvious in mystical undertakings, and that there might be on an unconscious level some form of reaction either magnetically, sexually, unconsciously, or all of them. Gareth Knight, in A Practical Guide to Qabalistic Symbolism, has some very strong positions on this subject.*

A.N.: Yes, he really has a great problem with this. So do most of the people who come out of the Inner Light, it is so ingrained. If I were pushed up against a wall and threatened, I would have to say, that magic does require polarity, particularly when working in a lodge format with a magic ritual. I get over that, by saying to people when training them, if you have a homosexual of either sex, try to put them opposite one of their own kind who is their polarity.

Stavish: *You are referring to the ritual circle and the stations of the officers?*

A.N.: Yes, so that we are still getting in a sense, a male/female polarity. I would, for instance, put a dominant male in the East and for lack of a better word, a subordinate male in the West. Then I would say you've still got a polarity. It may not be as good or as forceful as a true male/female, but it will work to a degree. You know, you've got to accept the fact that nothing is ever going to be as good as the real thing. But you can use what you've have, providing you do it as best as you can.

Stavish: *The reason I bring this up is because it is a real technical problem, and good partners, particularly magical partners are hard to find. People have a preconceived view that we must be open to everything, and that there are no boarders or boundaries but that this a technical problem that can effect magical groups, and even friendships.*

A.N.: The ideal is two male, two female working together, but why cut off your nose to spite your face if you've got somebody either a male or female who is lesbian or homosexual, who is perhaps a very good psychic, or clairvoyant, or upholders, who don't have anything particular to say, but who are very good at pouring power in. One obvious way is not to put them into situations where they must not have polarity. Put them either as the Seer or the Seers. Put them in as the Guardian. Give them an androgynous male female symbol. After all, people who go on about this, if you're into Qabala, look toward the heavenly androgyny. You do have a precedent there don't you? Don't throw the baby out with the bath water sort of thing.

What I do have a problem with, I don't like all female or all male groups. That does not work. It does work, in what shall we sort of say, male or female rites of passage type things. That's O.K. That's not High Ceremonial Magic. It doesn't need polarity, you can get away with it. That's why the Old Craft people, the Old Religion sort of do a lot of this kind of thing, but in High Ceremonial Magic you do have to find ways in which people who are of one sexual proclivity or another can work, and can offer service, and any power or talents that are within them. You just can't say to people, I don't like the way you're made and sling them out. There are people that are within those areas, who are capable, dedicated, and do powerful work. Those talents have to be used, you don't let talent go to waste, wherever it comes from. In talking about this, as I've said before, I've been working with something the last eighteen months that is based on this idea that area, that point within the human being, this

Yesodic Center, is far more powerful than we have ever thought. It is the point of creation.

Stavish: The alchemists acknowledge the gradient transition of creation from one phase to another. Within Qabala, this is stated, but there seems to be an almost built in dualism, in the idea that the material universe is so far separate from the origin point, that we need to go through all these different levels to get back. This is particularly strong in the Golden Dawn material.

A.N.: Yes, but if you fold it the Tree at Tiphareth, the center point of harmony, Malkooth, the material universe, and Kether, the origin point of creation, are the same. But then so are Yesod, our sexual-unconscious/Power Self and Daath, Awakened Knowledge.

Stavish: I was thinking earlier when you talked about thinking at right angles, that Daath is often said to be 'a right angle' from being into non-being, and non-being into being.

A.N.: It is Knowledge, Daath is Knowledge. It is the apple on the Tree, and the Lightning Flash of creation is the snake. Ernest said to me that you can have all the knowledge in the world, but unless you understand it, it won't become wisdom.

Stavish: Why are there so many warnings about rituals that involve crossing the Abyss of Knowledge, or even meditations on Daath? In planetary work, we can't work on Saturn unless we bring it down to Daath, or cross it on some level.

A.N.: I'll tell you something about that. All this hooah about the Abyss. Humanity has been building bridges over large chasms as far back as it could put two bricks together. If you can't cross the Abyss in your imagination, then get out of the ball game. It is one of the biggest myths, and it is there as a psychological barrier, and if you have anything in you, you will head up and over that, without any trouble. Whoever did that Indiana Jones, was it [Steven] Spielberg? I'm convinced this man knows his Qabala. In the Holy Grail, when you've got Indiana Jones trying to get up the courage to put one foot out, and I thought, if that is not the art of going into Kether, nothing is. The *Abyss* is to protect those who do not have the courage. That's not to denigrate. There are some people who say, I can't do this but I'm going to try. There is in some people, such a desire for knowledge, such a desire for understanding,

that they will go into a state of non-being to look for it. You do, you get whirled into this point, where the point is you, and you are also everything outside the point. That brings on an enormous sorrow, because you're everything and you're nothing. You want to get back, and yet you don't want to leave, and you go into a state of total acceptance. You give up yourself. Then you move into Hockmah.

Stavish: This seems to be the contradiction of magic?

A.N.: Magic is full of paradoxes. Magic is a paradox.

Stavish: In the East you give up your will, and you take the teachings of the guru unquestionably, or you work toward renunciation. In the West, it is more like Roberto Assagioli's Psychosynthesis, where you must build something before you can give it up. We build up our will, talents, abilities, ego, and then at some point we surrender them. However, we spend so much time building it up, that often we don't want to give it away.

A.N.: You know, the Golden Dawn has levels of initiations, the SOL has three. When we take people into initiation, they've reached a point of responsibility. You are now responsible for everything that you think, that you are, that you do, and by accepting responsibility for all of this, you lift that responsibility from the Savior of the Age. If we put it in a Christian context people grasp it. It is almost like saying, to the Christ, I'll lift you up so that the pressure is not on the nails.

Stavish: That is a Sign of the Station of the Cross. We carry the Cross of Christ with us.

A.N.: Exactly. But, there is a point where that no longer becomes enough. We start to get proud of the responsibility, I can do this because I'm willing to take responsibility. There comes a point where that Still Small Voice Within says, it's time to take the next step. The next step is, give the responsibility back to me. Now at first that seems like an easy thing to do. But now, when you're giving it back, you're giving it back consciously. Before you had that first initiation. If things went wrong, the Savior of the Age accepted it for you, and took the burden. Then you took on the responsibility and got very proud of it. Now you're giving it back, and everything that you say, or do, or become, or whatever, you say to yourself, 'Am I going to be hanging on this guys feet again?' Am I going to be putting more nails in again, I have to sit down and think about this.

Stavish: When I interviewed Jean Dubuis, the founder of PON (Philosophers of Nature), he said, that we have to be very careful about giving demonstrations of psychic and esoteric truths, because it can put a burden on people that they are not ready to bear. It becomes a form of psychic rape, in that at death a person could always say, 'Father I didn't know!' and now they are responsible.

A.N.: That is why with our second initiation, the first is offered, but with the second they have to come and say 'I am ready'. It happened to me. Ernest used to say, an initiation comes either spiritually and out of the body, or physically, but one always carries the promise of the other. My husband said to me some years ago, and I said out of the blue, "I'd like to go to Chartres." Now I am not particularly Christian, yet I say that as an ordained priest in the Liberal Catholic Church. For some unknown reason, that was where I had to be at that particular time. I went to Chartres for three days, and was totally lost in this magnificent place, with all this wonderful stained glass. But it wasn't the Christian concept that was drawing me there, it was something else. I was there when they opened the damn thing in the morning, and they had to throw me out at night. I lived in the place. The last morning I went there and, though I had seen just about everything, I thought, 'What do I want to repeat?'; there was a Mass going on in the little side chapel Our Lady of the ' . . . ' Now, my French is very rusty, but I went in and knelt down with all the old ladies in black and got up when they got up and knelt down when they knelt down. I always managed to cross myself in the wrong way.

Halfway through, something hit me and I had the most intense physical pain I think I've ever had. Childbirth is a doddle compared to what I was going through, and the sweat literally poured off me, it was dripping off my face and it was icy cold. I thought I don't know what is happening to me, maybe I'm having a heart attack. But it is in the wrong place, it was all hitting me in the solar plexus. Right in the middle of all this, somebody is saying to me, "Now give the responsibility back to me." I caught on right away, and said, "no, I'm happy where I am thanks." And it went on, and went on, and it went on until in the end I said, "All right, I'll give it to you." This immediate release, and it was like being cushioned, or cocooned in a light that was both light and dark. For the first time I had a concept of black light. Which had nothing whatsoever to do with the Satanic or evil, it was still light.

Stavish: What some call the Primordial darkness.

A.N.: Yes, it was quite incredible. I went back, and I couldn't explain it, or talk about it for the better part of ten days. Mike kept asking, what happened at Chartres? And I kept saying, I can't tell you. I don't know what happened at Chartres. But at that point, everything in my life, both everyday and magical, and this is going to sound daft, got edged with light. It opened up areas, both in my physical brain, and in my mind, that I hadn't been using before. A few days later, the contact behind the school said to me, now you are ready, now I can indwell, but only if you allow it. And there was absolutely no hesitation, that was it. It did change a lot of things.

Stavish: You call the SOL a fully contacted school. What does that mean?

A.N.: Ernest, who was a very good medium and trance subject, was in the Inner Light, and came to Dion Fortune. He said to her, 'I have been told to leave, there is work for me to do.' She said, 'By whom, and he said, by this particular entity, and there is work for me to do.' Dion said, 'Give me twenty-four hours.' She then came back to him [in the Inner Light] and said, "Go with my blessing, there is work for you to do. The contact will be with you know and for the rest of your life.' Ernest went away, and together with Gareth Knight and John Hall setup what was then the Helios course. When Gareth, wrote the first six lessons and decided to do something else. Ernest said, all right, I will finish the rest of the lessons, and the contact came and said, 'Right, now hear this,' and Ernest sat down and he wrote all these lessons. That contact more or less said to him, 'What I'm giving you is the core of a school that has been in existence before, but when its time in that era was finished the core was lifted away and stored. Now it's time for it to come back for the next time. Here it is.'

So the whole school has grown up around this contact. We've now reached a point, were good though Ernest's course was, and I never thought when I was younger I would say this, it is now getting to the point where it has to be replaced. And it is scaring the hell out of me that I'm going to have to be the one to replace it. I still have this little bit of hero worship toward Ernest that thinks anything he did can't be surpassed. What the other half of me says is not surpassed, but upgraded, uplifted, and updated. The contact was passed to me, he overshadowed Ernest for many years, and now I'm landed with it. But it has this disconcerting habit of waking me up at three

thirty in the morning, and I wake up and write things down, switch my computer on, and this that and the other. He says, 'You take this and you do that, and this is how you do that, and this is how you work up the Tree.' And I say, 'This is how Ernest did it,' and he says, 'No, no. This is how you are going to do it.' So I'm now in the process, of remaking, rebuilding, and re-energizing, the lessons. Ernest's work is still good. And basically, it is a mild form of tantra because what it is doing is bringing up the energy from the Yesodic, or sexual, center to the thousand petal lotus, if we are going to use an Eastern term, to make it realized. People don't usually catch on to this until about lesson forty-four when they say, 'Oh' and the light dawns. He uses tarot cards, rituals, Path-working, or guided meditation, and other methods to bring this about.

Stavish: I sort of sensed that, in that Ernest was trained in India in his early days, and while he tells us not to do pranayama, he hasn't completely washed his hands of Indian yoga.

A.N.: Oh no. He didn't mind people doing hatha yoga, but the breathing things contradicted, and sort of negated the breathing stuff that we do. So this is what he was saying, don't try and put too many eggs into one basket. But, the course as he wrote it, is getting in a sense too loose. Like knicker elastic, its been in the wash too many times, and your underclothes are beginning to slide down over your hips! When the Helios course was written there was nothing else like it. This was in the early sixties. It was like manna from heaven for a lot of people. They didn't realize that this stuff was available. But now, you've only got to look at the plethora of occult book shops. The world and his wife are writing books! It needs to be updated, because so many people are coming into SOL with enough knowledge to take them through the first year. The only thing that is different about Ernest, is that he wrote trip up lessons. The infamous, lesson five for instance. People hit that and their lives go berserk. I've gotten into a habit now, and I tell people that hit lesson number five, or if your lucky number is six, that your entire life is going to go to hell in a basket. You're going to change everything from your politics to your socks. What is happening, is that the inner level pressure, is saying, 'That is an interesting mind, well we don't need this and we don't need that, and by the way, your wife's not going to be too much good to you, so she can go as well', and people are sort of getting divorced, and moving to other counties, and giving up fifty thousand pound a year jobs and going into a twelve and a

half thousand pound job because it feels better.

Stavish: That seems to go against the promise of the New Age movement though. Magic and mysticism are offered as panaceas to our ills, yet the reality is, that once we start down this path, the cracks in our personality and life aren't filled in, instead they are dug up and we are forced to rebuild from scratch. This causes many of them to throw up their hands, and give up their studies altogether.

A.N.: Our people comeback. We just had one, who left twelve years ago. Its wonderful! That says to me that the school is good, that the contact is good, and that it is still there, that the work has validity. Because they've been able to carry it, the seed with them, they've nearly always said, "I kept on doing the Noon Salute or I kept on doing the evening review". And I think, well all right then. That is what we mean by the word 'contact'. If there is no contact, if there isn't that link, that arch thread, then they don't comeback, because there is nothing to comeback to. It's like the idea in Scientology, that if you link once with somebody, either mentally, or very deeply socially or sexually, the link is there between you. Now we sort of use that in a different sense to Scientology. Where the teacher behind the course says, yes, I'll have you. Bang. You're branded. And then, whether you go, or whether you stay, you are his. And at some point, he will real you back in, and will say, 'Now do you understand?' and you will say, 'Yes, I am ready to go on'.

Stavish: Like the biblical story of the prodigal son.

A.N.: Yes.

Stavish: You spoke earlier about magic having the basis of its belief, the idea that we can in some way become masters of our lives, our destinies. Yet, so often, people who study magic are materially worse off than their neighbors, and their esoteric studies are criticized as having a negative impact on their standard of living, and quality of life.

A.N.: Ernest Butler was a priest and felt that poverty and spirituality went hand-in-hand. Israel Francis Regardie, dear Francis, read me the riot act and said, "what the bloody hell is this guy teaching you if you've got to worry about the electricity bill you can't be spiritual. Go out and earn yourself some money, girl!" So I kind of fell between two stools. So I spend my time working very hard. I spend my days, doing sixteen, seventeen hour

days most days. It is quite a holiday to come over here really. I don't take holidays, because I come over here and I have whole days when I get to just sit and talk to people or I even get to go to bed early, or watch television. I went to the pictures the other night, and the movies as you would say over here. I saw "Mission Impossible" and thoroughly enjoyed it. I don't often get time to do things like this. I'm in the office by nine o'clock, and I come out of it about ten or eleven. It is easier now that my husband Mike is retired. That's what's nice about this work, you don't have to retire.

Stavish: This seems to be a reoccurring theme with many magicians, particularly neo-pagans. There is a very good book written called, Never Again the Burning Times, by Loretta Orion, which examines the neo-pagan community in the U.S., and how many of them earn a living. Most of those surveyed make less than the average wage. This contradiction between philosophy and material reality, causes many to ask them the questions: if you can control you destiny, why don't you have a better quality of life?

A.N.: There are different sort of ways of looking at quality. I don't have a big house. The biggest room in my house is not as big as this one. I have an outside leau, not as well as, instead of. However, I have put two children through university, and I travel the world. I don't drive, I prefer to look at scenery and let other people drive.

Stavish: But you also live on a small island.

A.N.: Yes, I also live on an island. I've traveled the world. I don't go hungry. I am not young enough, or have the figure for Christian Dior clothing, so long as it hides all the faults in my rapidly aging body, that's all it really needs. I can afford to by books, and to go out once or twice every two or three months to dinner. I don't need any more. If I could have one luxury it would be to travel business class. I'm fed up with going in the cattle truck! But, on the other hand, the people who I come over to speak to pay what they can afford to hear me, or take whatever teaching I can, but they can't afford to send me backwards and forwards business class. But that is a small part, I really do get around. South America is really the only place that I haven't been to. I've had riches! To have a penthouse in New York, and an apartment in Montmartre, and a flat in London, I can't live in anymore than one at a time. On the other hand, Mark, if I want, I have a place in Sweden, Australia, New Zealand, Spain, Hong Kong, Bali. These are people who have said to me

'Dolores, anytime you want to come, this is your home.' I have homes with families. I don't need anything else.

Stavish: Let's talk about angels.

A.N.: What are they not? They are not the fluffy, Victorian, Armoni dressed, curly headed, beings of somewhat doubtful sexuality that Victorians loved so much! We really get most of our ideas about angels from people like Michael Angelo, and Raphael, and of course, the Victorians. But, they're aliens. Lumps of energy floating around that have been ensouled for one particular thing. You don't get an angel, apart from the archangels, that seem to think and correlate thoughts, and feel in the same way, or near enough to the same way that human beings do. Most of them, are sort of small bundles of energy, they pop-up, sing halleluia, praise the Lord, or some other thing, and then disappear again.

The cherubim are the angelic hosts of Yesod, the Almighty Strong Ones, who are imagined by Qabalists to go around stark naked, bulging with muscles, like Arnold Swartzenegger without the loin clothe.

Stavish: Like when he beamed-in in "Terminator"?

A.N.: Yes. Each one, you've got the Chasmalim, or Brilliant Ones; the Seraphim, or Fiery Serpents, as opposed to the Cherubim, the Ashim, the souls of Fire, the Eralim, Fiery Circles with wings, Thrones, princes, dominions, all these things that have got [a body?], this means that there is a concept of form that is different for each one of these. We are not talking about the archangels here, but about the angelic hosts.

Durer, when he was depicting some of the archangels, took things literally. He gave them a body that was sort of like a star burst, and actual Doric columns for legs, because they were described as having legs like columns. Then again a vague cloud with two eyes because the features could not be perceived. This is closer to what an angel is, or might be seen as. I was taught to perceive them, and to use them symbolically, as geometric shapes, because, those are basic forms.

Stavish: This is one of the criticism of Qabala, that it is too anthropomorphic, and that the constant visualization of divine beings in human form is in itself a kind of astral trap. To really understand them, we need to understand them as abstract energies. This is where geometric meditations, meditations on the names

spelled in Hebrew, or some other form, come in instead of making them look like glowing humans with wings, robes, and great hair.

A.N.: Once I get students past a certain level, where their minds are loose enough to start putting new concepts in. I tell them to look at angelics, and even their concept of a creator, as an energy pattern. Now, in a sense, the Tree of Life is an energy pattern. You've only got to look at that, and that's almost like looking at the pattern of an atom. It looks somewhat different with the tail at the end, but still an energy pattern. And again, we are coming back to quantum physics here; quantum physics is getting to the point where it is saying we are all made up of particles. If you look at this in a cosmic sense, we are physical bodies, with a series of cosmoi, with huge spaces between them. This is enough to starting turning a new student's mind brown around the edges. It starts to smolder a little. But if you start them by saying anything with regard to an angelic host in Binah, the Sphere of Understanding, think of it as a triangle. Because that is the geometric shape of Binah.

With Hockmah, the Sphere of Wisdom, a strait line, and if you must slap wings on something, slap it on that. A winged staff, you've got a caduceus. You've got to get into their heads, and then you've got a wedge in, a foot in the door, you can start to open up their imagination. Dion Fortune put her finger right on it when she said, "The Masters as we know them are all imagination." You have to take that sentence apart and look at it syllable by syllable almost, to get what she's all about. I remember, saying to my contact once, "Well, at the moment you're a disembodied voice, what do you look like?" and the response was, "What do you want me to look like?" Of course, me with my sense of humor said, something tall, dark, handsome, and well muscled. Which immediately got projected into my mind. And I said, that'll do, do you drive a car as well? But, again what I have is a symbiotic relationship with something that is not and never has been and never will be human.

I don't attempt to explain it more than that. I don't care if the people I say it to think I'm a nut, I know what I've got, and how I've interacted with it for the better part of a quarter of a century, so it doesn't really worry me what other people think. But, I've said to this companion of mine, how does this work, why is it so important that you are part of my actual particle makeup, and what I got back was something totally amazing. Have you ever come across the concept of the fairy wife or fairy

husband?

The fairies do not have souls, as tradition says, but if they can become one with a human being, they share a soul. What I got was something, almost, like this is where the whole thing began. There are those who are able to accept this symbiotic relationship when it does happen because it gives the entity, who is so old, the capability of being a teacher because it has all the knowledge. It is not human, yet it lived in a cosmos beyond, maybe three or four nights of Brahma away, and it has opted to serve, and therefore is held in the dream of the Brahma when it sleeps.

Stavish: These are the Cosmic Masters who are so often referred to?

A.N.: Yes.

Stavish: There seems to be some contradiction in one sense. Their are those who say that Masters do exist, and to some degree do become incarnate.

A.N.: You're talking about the Lords of Humanity. I'm talking about the Lords of Mind. The order descends from the Lords of Flame, to the Lords of Form, to the Lords of Mind, and to the Lords of Humanity.

Stavish: What are their differences?

A.N.: Lords of Flame are the entities that come out of the Dream of Brahma at the beginning of a cosmos, and who take upon themselves the building of the laws that will direct that cosmos. And we're talking about things like gravity, centrifugal force, all of the things that must be in place before things can actually begin to happen. After this has been worked out, and the framework of the cosmos has been put together, things begin to take form. Then, out of those Laws come the suns, the stars, the planetary systems. When those are in place, and they are the work of the Lords of Form, which, if it is possible, must encourage life to form. And of course it doesn't have to be oxygen breathing, two legged, and what have you. That is their work.

When one of those life forms starts to look up and say, "I wonder what they are. I wonder what I am?" That's when the Lords of Mind come in. The Lords of Mind are the teachers, at least as we in the occult world speak of teachers. Eventually, human beings begin to, or part of a life species begins to, go beyond the rest of the species

and they become what the old Egyptians called, Just Men Made Perfect, the Justified Ones, which is when they begin to take on the responsibility of teaching their own species. And for a while you get the Lords of Mind and the Lords of Humanity working together. Menaleck, the son of Solomon and Balckis, is considered to be the Ethiopian Master. Hypatia was one of the justified ones. All the way through history you get human beings who have evolved to the point where they can start to teach their own kind. They can free themselves from the *need* to incarnate, although they can incarnate if they choose, and can say, "I have been human. I have walked the Earth." The Lords of Mind cannot say that.

Stavish: Is this part of the mutation you mentioned earlier, these Just Men Made Perfect?

A.N.: This is the beginning of it. My contact said to me that, 'This, the Aquarian Age, is the last Age when we will provide a savior. After this it is up to you.' That is a terrifying thought, to provide your own savior of the age. This means with the Age of Capricorn, we are going to be lumped with the Lord of Humanity as the Savior. What the Lords of Mind are saying is, "We won't Indwell, or Overshadow, another savior after this one, we will help you one more time. Then you've got to do it yourself, you're grown up, you've come of age."

Stavish: The idea of the Avatar, the avatar is that point in the Ganges or other rivers where you can descend and enter into the water. That is the root of the word, and the descent, or Overshadowing as it is called, is part of the avatar's incarnation process. It was pointed out to me that an avatar only appears when and where it is needed most. And while so many take joy in this idea of a Savior, what they forget is that it has got to get really bad before one generally appears. Darkness is the cause, and the Cosmos is saying "we're going to give you a shot of B12 here to get you going." Jump start the engine.

A.N.: I think all the way along, these saviors seem to have come from special blood lines. I know there's a lot of people screaming about genetic engineering and all that but, if you like, the bodies are genetically engineered so that they produce, from what I understand, a very loose etheric body that can be shoved over to one side. This allows something else to take its place, which acts and reacts with its surroundings, and chooses a group around it that it can teach, and therefore, provide a nucleus to go on and out. It is like a miniature explosion.

You sort of get an atom, that atom then becomes, in a sense a double, because it has got an Indweller, or Overshadowing, and then the explosion moves out effecting all the other particles who then become little nuclei themselves. But this destroys the center one, and it will always be destroyed. As Osiris was destroyed, as Orpheus was destroyed as the Nazarene was destroyed, they don't last long. For one thing, the enormous amount of energy that is needed just burns them up. The endocrine system just goes haywire.

Stavish: How does this fit into the two theories that say, either the Christ force will return in the form of a single person, such as another Jesus, or instead, will be a general descent of consciousness on all of humanity?

A.N.: Of an understanding. An ability to use more of the physical brain than we're using at the moment. Colin Wilson is very hot on this. We've had many a discussion on this idea, he's got this into his head, and I quite agree with him. We are capable of doing, understanding, creating, of expanding so much more than we are doing. We're just afraid. We're looking at Indiana Jones hesitating on the edge of that abyss again. I mean now we're looking at our entire species. It's sort of got one foot out, waving around, and thinking, "Do I dare put this foot down?" Can I trust? And we are not trusting ourselves. How many times Mark have you had a thought in your head, and it's come up trumps, and you've sort of thought to yourself, 'Christ if I've only put the money on that horse!' or 'If only I bought that lottery ticket.' I was watching the Pennsylvania Lottery a few days ago and amusing myself by forecasting the numbers. The only one I didn't get right was the last one. But of course I hadn't bought a ticket!

I have one of the most totally useless pieces of prognostic talent you could ever wish to have. I will sometimes say to my husband, "Do you remember such and such? I would love to see that again." Then, within ten days, it will be on the television. I can smell it coming, and it rings a bell in my head.

The last time I was over here, April or May, I was laying in bed the night before I left Philadelphia, and thinking, what I really want at this moment, is to get to Boston, find I'm the 10 millionth passenger, and that they are going to give me a free ride first class, with a bottle of champagne, and a bunch of flowers. I turned over and went to sleep. I got to Boston. The girl said, "I'm sorry Mrs. Aschroft, we're full back there." I thought, 'Oh,

they're going to bump me!' Instead, they decided to upgrade me. I get on, and went home first class, plus champagne. The only thing I didn't get was flowers. And Mark, you really can't carp with two out of three.

Stavish: That reminds me of the old saying, be careful what you ask for, you just might get it. Especially when we take on this role of being our own savior, and we become responsible not only for our actions, but thoughts as well. Along this line, I've found that many ceremonial magicians are excellent at visualizing complex symbolic imagery, but when it comes to a straight forward visualization of, as you've said, "I want an upgrade on my flight, or a better job, or something similar but very tangible and concrete, in their lives," they often fail.

A.N.: It's because they don't believe. They don't let go of the thought form they've created, and allow it to do its thing.

Stavish: We were talking about angles, I was wondering if we could go back to that for a little bit. Are Guardian Angles just our Higher Selves, or is it a distant relative watching over me as some have claimed?

A.N.: I think occasionally, a relative that's gone over may hang around for awhile to see a much loved grandchild or child, through a difficult period. I don't regard that as a Guardian Angle. I often tell a story in my workshops of a picture my late mother-in-law gave my daughter when she was five years old, called, "The Guardian Angle". This was of two small children playing near the edge of a ravine, chasing butterflies. They are over the edge, they're gone, they have not a hope in hell, they are on their way down. And there is this benign stupid looking thing with wings going He's not doing his job! These kids are gone. They're dead, already.

Stavish: The Guardian Angle is not to escort us to the afterlife, but to protect us from getting there prematurely.

A.N.: Exactly! It's not doing its job. I really do think, in a sense, that we are our own Guardian Angles. But we don't listen to ourselves. What we don't listen to, is what I am continually telling people in which nobody really, to get down to the nitty gritty believes, is that there is a piece of Divinity in us. And nobody believes that. They say, Yes, yes, we know that

Stavish: Isn't that why we invoke the gods?

A.N.: Yes, because we can't believe. It's got to be out there. If its not out there, then it isn't real. Yet, this, I really cannot go along with. This is where it is (pointing to chest). In a sense we are our own Savior, our own Guardian Angle. If we think of God as "Our Father which art in Heaven..." we are shoving it out there again. This is a real cop out. That way we can blame, but if it is in here [pointing to chest again], we have to accept it. We make our own universe, and we make our own lives, and we make our own environment, and when we, our species, can be totally individualized and recognize ourselves as Malkooth (the Kingdom) joined with Kether (the Crown, or origin point) [we become] Khala the Bride on the Throne and Crowned by Kether. Then, in a sense, Osiris comes together, all of the bits have been put together, including the all important phallus, the important creative point. Around which everything seems to evolve, but everybody is pussyfooting around it. "We, really mustn't talk about this, it isn't nice." Some occultists are more prudish than you can shake a stick at.

Stavish: One of the things I remembered most about angelic forces, like when you call on archangels, some people think that they are calling on some guy named Michael, instead of looking at what that means in Hebrew, "Who is like God". So when we call on Archangels, we are really calling on these qualities, or ideals, not individuals.

A.N.: When you call them, you are invoking them from within yourself. I mean you can do this another way. You can take the spelling of the name in Hebrew. Here is Mem, here is Heh, here is Lamed, and you can say to yourself, these are symbols, and get a power out of these as well. I make my lot, take the letters themselves apart, and make up little vignettes of the little hieroglyphics. Make a path-working out of this. Some amazing stuff comes out of that.

Stavish: This reminds me of some of the old medieval schools of Qabala, in which the Tree of Life is dispensed with, and only the Hebrew letters, and Divine Names, or mantras are used for meditation. The letters are then seen as energetic patters, and if linked together, to form a Name, they would then be imaged like a sine wave on an oscilloscope or similar energy reading devise.

A.N.: Yes, exactly!

Stavish: It is suggested that when we draw the sigillum, or those funny little lines, of the various names over magical squares or talismans, we are really drawing the literal energetic pattern of the forces invoked.

A.N.: I think it is, I really do. This comes back to what I was saying, that, these particles of which we are made, of which anything is made, including those energy patterns we would call angles, are vortexes. If you take a particle down, past neutrinos, you get vortexes, little whirlpools of energy. This is amazing, because what it really means, is everything is the same. Everything is one of those, in various combinations. And if that is what everything is, that is also what the space in between everything is. And therefore, nothing is separate. Which, again we are going into quantum physics here. I can say the cup and I are one, and as I touch it, there is nothing between 'I' and the cup. The edges are blurred, the energy of the cup, and the energy of my fingers are interacting, that is why I can say, I can feel it. If I could alter my perception, I could put my finger straight through it, because basically, if I expanded the universe of that finger, it would be particles, miles and hundreds of thousands of light years between each one. So, theoretically, I should be able to move through it, it is a fourth dimension.

Stavish: Do you then believe that physical time travel is possible? I noticed that it is the topic of your upcoming London workshop with J.H. Brennan.

A.N.: I think it is. I really do. We have an exercise, called points of focus. A point of focus, is a point in time, in which you want to be, or want to zero in on. We use it mostly, in a watching aspect. But I teach them to be very specific. I want a date, and I want a time line. That then limits you, because you can't know what you are going to see or where your going to be at that moment. I've had people get a little wary of this, because they tend to have their mind materialize half in and half out of something, and then they have to comeback and readjust and go on. I think it is possible [that things like that can happen.] For lack of a better example, let's take old Ezekiel and his vision. It occurred to me more than once, that maybe one of our lot landed, or possibly someone from further ahead than us was sitting down and scaring the life out of this little guy, who probably left a vast wet trail behind him. You know, then we've got Elijah, who actually left, he lifted off!

Stavish: This leads into an area not well discussed in

the Western traditions, but is well explained, complete with techniques, in the Eastern traditions of Manchurian, Tibetan, and Chinese yoga, the idea of the 'Rainbow Body'. Where at the end of their life, the adept literally takes the physical body with them. You have Jesus doing it, Mary, even Mohammed complete with his horse is said to have ascended bodily into Heaven.

A.N.: And you've got disappearances. We've got guys who walk into the middle of a field and disappear. We've got a small boy who goes out to feed the horse in the barn, yells twice, dad come and get me, and he's gone. There is a phenomenology going on, and some of the things we do not, at the moment, have a handle on. But, I for one am not prepared to say this is impossible. Because I don't know.

Stavish: How can we know for certain?

A.N.: Nothing is certain, the universe is a whole pattern of uncertainty. Brahma can wake up inside his dream. He can have a lucid moment, and where the hell are we then? Which brings us to the aborigine dream time. I once asked an aborigine when did the dream time happen, and he looked at me as if I was totally nuts, and said, it hasn't stopped! It always has been, it always will be. And there are quite a few aborigines who disappear.

Stavish: In *First Steps in Ritual* you give a rite called the 'Defender of the Land'. Yet in the United States, occultists tend to keep to themselves, and often fall into what is called counter-culture. Historically however, they have always been the ones that have pushed us forward, whether it be Francis Bacon, Thomas Jefferson, or the people they knew and we've never heard of. Yet, in this country we are almost handing over our culture to those who would be its worst defenders, the fundamentalist Christians, or left wing, who would have everything fall apart and not value any of the struggles that have gone on. Why have esotericists surrendered their role of being at the forefront of defining cultural norms?

A.N.: I think you will find this idea of the defender very much alive, for instance, one of my lodges, Lodge Merlin, has somebody on watch on the shores. I think for the moment, what you're talking about is happening here in this country. In a sense it is all apart of your adolescence. You are, after all, only two-hundred years old, and just moving into your rebellious teen stage. Years and years ago, Llewellyn put out *Gnostica*, and I

wrote an article in which I said I thought, the American race would become very much the prime esoteric race. I based this on the fact, that I thought the Red Man, the American Indian would vanish, and he would vanish into the blood line of the Americans, and be the binding substance, the mechanism by which all were drawn together, because he was the first, and in a sense would be the last.

While you still have areas where there are all Jews, Italian, Hispanics, until that goes, until somebody decides to stir the soup, you can't be one. When the red man, in a sense, becomes the binding agent, then America will recover its spirituality. He will be the link, and his will be the power, and he will reclaim the land he had to give up. He won't do it as the American Indian, but as the Higher Self, if you will, the spirituality of this race. I am firmly convinced that America has an enormous future. It is going to have to fight quite hard for it. I think that it's got to go down into the dark before it rise out. But then all adolescents go down into the dark, before they rise up and become human beings!

Stavish: That goes back to the role of the avatar. We only have the opportunity to see the light when things are really unpleasant.

I noticed that there is no mention of Enochian magic in the material you have on your website. Why all the warnings about Enochian, and its purported dangers?

A.N.: Enochian is very tonal. I was trained as an actress and singer many years ago. Sound has a very strange effect on me. I can go straight into a trance where it is concerned, without any hesitation. One of our supervisors left many years ago in order to take up Enochian. He's a very, very, competent occultist and a very good ritualist; quite a down to earth person. Yet two years later he was a nervous wreck. He'd set aside one room in his house as a temple, furnished it, and for two years almost every day had spent some time in there either practicing a call, or doing longer Enochian rituals.

It started with him going in one day and finding all of the furniture piled in one end of the room. He put it back again, and said to himself, 'This did not happen.' It happened again, and again, and finally one day he found his alter upside down. He de-consecrated the entire place and shut it up. And said, 'I can't do this anymore.' Whatever it was he thought, 'Well, maybe he doesn't want to do it anymore,' but it did. He began to find things around the house, all bundled in a corner, or standing on

top of one another. He came in one day, and found two of his books, one flat, one on edge, and a glass of water standing on top. He tried everything, he blessed the house, cleansed the house, and called in a priest and had it exorcised. One of the things people don't know about exorcism, is that you can't really use exorcism on things that are older than Christianity. In the end he gave up all forms of the occult, sold all of his books, but not before he damn near came to the edge of a nervous breakdown.

Stavish: Jean Dubuis said to me that the 18th century French rite of the Elus Cohen is similar to Enochian in that it shakes up the system so dramatically, that when the pieces re-arranged themselves, you pay a heavy price. Why is Enochian so hard hitting?

A.N.: It's sonics. Sound is the basic vibration of the universe. All those little vortices may get sent going the other way. Sound is really very powerful. We haven't gotten quite to grips with that now. I know for fact that there are defense systems based on sonics. I say I don't do any (Enochian), but I was persuaded by Herbie Brennan a couple of years ago, at a Masters Class, to join in an Enochian ceremony, which was for invisibility. Now your talking about forty odd people here. Granted all of them are fit to be in a Masters class, some five six years and some a lot longer. We're half way through this and I'm sitting there and I look down, now - I have trouble with heights, and what I'm looking at is total space. I'm thinking, I didn't see that. Afterwards we come out of that, and I say, "Didn't you see that? There was nothing there!" He says, "I didn't see anything." This was a Saturday night. My daughter was driving up from Yorkshire, the following morning. Now where we held this is in a place called Wellington Park, and it is up on a hill. From the top of the hill you can see six counties. Tammy was driving up. We were saying isn't this a beautiful day, you can see Worchester, and Silvershire, and Lincolnshire, and Tammy was going round and round, because she couldn't find the place. When she finally got there, two and a half hours late. She said, "The fog was incredible." We said, "What fog." She said, "What have you two been doing, making yourselves invisible?" She didn't even know we were doing this particular ritual. We always have to kind of knock ourselves out. We have to get out of ..., we have to accept that we can do these things.

Stavish: What advise can you give to aspiring esotericists?

A.N.: Record everything, no matter how small, because your going to be able to refer back to it. If you record things, you're going to find, patterns of things, and patterns are important, because you can then see the patterns form before it happens. You can prepare for them, and go into the experience. You are not afraid of the experience, and record it as it happens. The only way to do that is to record it. It is no use saying, "Oh, I've got a good memory, I'll remember that." I'm sure you've experienced the same thing. You've woken up in the middle of the night and thought, that's a brilliant idea, I'll remember that, and in the morning, zilch. So, no, I do not go to bed unless I have either a tape recorder or a pad and a pen. I put it down. People don't realize; just imagine if people like Dion Fortune had a tape recorder. We would have her voice, we would have had her thoughts, we would have a blow by blow account of her development. Even Ernest, who pounded these things into my head, did not make his own recordings. For some reason, we don't want to make things permanent, to put things down. We are afraid that when we go to read it, it is going to sound to daft. To make a record, means that we can leave something behind. It is a map into a country that we are exploring.

Stavish: How did Shakespeare put it, "The undiscovered country"?

A.N.: "... the burne from which no traveler returns." I said to Pat coming over here, "I wish that at the last moment of breath, we could slam one of these things (a tape recorder) into some body's brain." Not to long ago I said to somebody that nothing in the universe has the reality that we grant to it. It is only because we have organs of sight, and organs of hearing that we can actually hear and see things. What we are actually perceiving are waves, and we translate them into objects. There is a point at which you can actually reverse that, and pass into a nothingness, which is pretty much what was down there [below me during the Enochian ritual].

Stavish: Is that the use of the symbol then? To take the concrete and trail the line backwards, through the abstract, to the infinite?

A.N.: Yes. It's like going back to the Ain Soph, the Primordial Nothingness from which all creation came.

Stavish: Some people say that there is a limit to how far we can go while incarnate. That we can't really experience some of these higher levels on the Tree. Is

that an absolute statement, or one that's relative?

A.N.: I think its relative. To be quite honest, I think that human beings can go as far as they want to go. The only thing that stops them is fear. Fear is a powerful emotion.

Yeah, there are things that I'm scared of, but God, my curiosity is bigger than my fear. My Gemini mind hates to think there is anything there that it doesn't know about, and I'll press on. My Scorpio ascendant is saying "don't do that" lets sit here and think about it, what's around the corner, and my Leo mid heaven is saying, can we make money out of this?"

Oh God, I love life! I really do!!

⊕ *This entire interview appears on our web page at: <http://www.mcs.net/~alchemy/stone20a.html>*

ABOUT THE STONE

The STONE provides a forum for articles (5000 word maximum), conference announcements, research summaries, and other items of interest to PON members and our subscribers. Authors should, if possible, submit manuscripts as an email attachment to:

turpen@starnetinc.com

Use a plain text (ASCII format) or mail them on disk along with unmarked, printed copies to:

Rick Grimes - Editor

The STONE

800 N. Clark Street #317

Chicago, IL 60610 USA

Phone: (312) 654-1766

Fax: (312) 225-1371

Publication decisions are normally made within four to six weeks. Selected articles from *The STONE* will be republished on the PON Internet site at the discretion of the editors.

The STONE is published every two months, and is normally mailed on the 2nd Monday of the odd-numbered months.

Subscriptions to *The STONE* are \$30.00 US per year for non-members, and are free to active members. Membership dues are \$30.00 US per year. Subscriptions are for January through December - all back issues for current year are sent to new subscribers. Add \$10.00 for foreign postage. Make payment by credit card or by check drawn on a bank with a US branch.

Send all inquiries about subscriptions or membership to:

The Philosophers of Nature

**125 West Front Street, Suite 263, Wheaton, IL 60187
USA**

Email: alchemy@mcs.com

PRACTICAL LAB TIPS and IDEAS

From various Members

Water Bath tip: Put a cap full (tablespoon) of mineral oil on the surface of your water bath to prevent the evaporation of the water. By retarding evaporation you are free from having to repeatedly check the water bath to prevent it from going dry.

Announcement:

**A Work on Practical Spagyrics
available from PON**

Spagyric Tinctures: Tradition, Preparation and Use

by Beat Krummenacher

The contemporary Swiss alchemist and spagyrist explains the methods of Zimpel, Glauber, Krauss and Heinz, before setting forth his own method of preparing spagyric remedies.

This is a most useful map for finding one's way in the Spagyric realm. We think it will provoke some thinking about one's own practice, and suggest improvements that can be tested for their value.

The cost of \$16.95 for this ring-bound 49-page booklet includes postage in the US.

A Conference in Prague

presented by

The New York Open Center

Prague, Alchemy & The Hermetic Tradition in association with Gnosis & Esotera Magazines & Universalialia, The Association of Czech Hermeticists August 29-September 2, 1997

In the year 1600 Prague was the greatest center in Europe for the study of alchemy and hermetic philosophy. This year, 1997, the Open Center is presenting a parallel event to a summer-long festival of art, music and cultural events in honor of Prague's historic importance. The Open Center's conference on alchemy and the hermetic tradition will seek to enter with full imaginative force into this half-forgotten but remarkable epoch.

Program Topics:

- Alchemy & the Pagan Imagination
- Tycho Brahe, Kepler, Rudolf II & the Prague Hermetic Renaissance
- John Dee & Renaissance Magic
- Alchemy in the Age of Rudolf
- Of Angels & Dragons: The Visionary Tradition in Alchemy
- Rudolfine Prague: Sunset of the Renaissance
- Royal Outsiders: Rudolf II & Ludwig II
- Cartesian Mysteries

Afternoon Workshops and Vltava River cruise will be available

FOR MORE INFORMATION GO TO:

<http://www.levity.com/alchemy/>

*This notice is posted as a service to our readers.
The Stone does not accept advertising.*

PLANT ALCHEMY SEMINAR – Open to the Public

October 11 9:30am-4:00pm, at Unicorn Books, Arlington, Massachusetts

The Philosophers of Nature is hosting a one day workshop on basic plant alchemy. PON Research Director Mark Stavish will cover theory and practice of making basic alchemical tinctures for personal healing and initiation. The relationship of alchemy to qabalah, spiritual growth, 'dream yoga', psychology, and laboratory practices will be explored. Open to the public. For information/registration contact: The Philosophers of Nature, 125 West Front Street, Suite 263, Wheaton, IL 60187. Email to alchemy@mcs.com or fax 630.655.2364. Cost is \$50/person, \$75/couple.

Announcement:

P.O.N. SEMINAR VIDEO TAPES - UPDATE!

The production and sale of Video Tapes has been DISCONTINUED.

Due to the high unit cost and the production problems we have encountered the PON Board of Directors has decided to discontinue video production and sales at this time. Though we are convinced of the video tape's value, and hope to offer good quality copies for sale in the future, we must stop for now. Be assured that all PON seminars will continue to be video taped in their entirety and hopefully, we will be back in production soon.

Video status and updates will appear in *The STONE*.

We understand your disappointment and regret any inconvenience.

---The PON Board of Directors

AN EXCITING ANNOUNCEMENT!



The Way of the Acetates: A Workshop on Mineral Alchemy

Presented by Russell House
in Winfield, Illinois

Saturday - Sunday, September 20-21, 1997
Informal Session on Friday September 19th

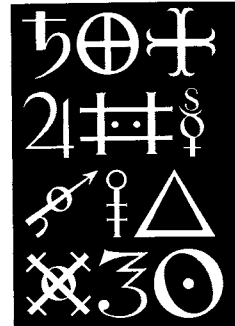

PREREQUISITES: In order to make this class effective, we require that registrants have previously worked in the laboratory, so that they will be comfortable with the use of typical laboratory glassware and apparatus. This should include experience in procedures such as filtration, evaporation of solutions to obtain dissolved salts, and distillation of solvents such as alcohol. Registrants who are prepared by this experience will have an idea of the sort of concentration and awareness required for safe practice in the laboratory, as well as the ability to critically observe phenomena in the laboratory. Registrants must contact the instructor to discuss their previous lab work before confirmation of registration. We will also limit the attendance so that those who attend can actively and safely participate in the experimental work.

Those who do not have this experience but would like to begin acquiring it through practice in the Plant Kingdom will be pleased to know that one or more events will be scheduled before June, 1998. Announcements will be made in The Stone.

REGISTRATION OPEN TO 10 MEMBERS... ACT NOW

WHEN: Saturday-Sunday, September 20-21, 1997. Saturday: 9:00 AM until 8:30 PM. Sunday 9:00 AM until 5:30 PM. Registration begins at 8:30 AM on Saturday. **FRIDAY NIGHT Informal Session:** All who arrive on Friday evening can meet after 7 PM to get acquainted and meet with old and new friends.

WHERE: at the home of Sue and Russ House in Winfield, IL, approximately 40 miles west of Chicago. Directions provided in the registration packet.

ACCOMMODATIONS: Available at area hotels and motels. A list of hotels and restaurants will be provided in the registration packet.

TRANSPORTATION: Transportation is needed to and from your hotel. Carpooling advised. Limo and taxi information will be provided. Air travel into O'Hare International Airport or Midway is equally convenient.

COST: \$125.00 per person. Couples are \$200.00. Open to members only. Lunch, mid-morning and mid-afternoon snack breaks on Saturday and Sunday are included in the cost. Extensive handouts are provided.

INSTRUCTOR: Russ House has been working in laboratory alchemy since 1982. For several years he concentrated his efforts on the way of the acetates. Russ was an instructor in Laboratory Alchemy for AMORC's Rose-Croix University International from 1990-1993. Since 1986 he has been a member of the Philosophers of Nature, and is currently serving as the President of the association. In 1997 Russ demonstrated an acetate distillation for the "Ancient Mysteries" television series, which will be aired later this year.

TOPICS: This is a practical workshop. The subject is the preparation and dry distillation of the metallic acetates, one of the "Humid Ways" known to Edward Kelly, Ripley, Weidenfeld, Becker, Hollandus and numerous others. It is one of the ways of preparing alkahests which are active in the metallic kingdom. This is an interesting path which one cannot exhaust in a lifetime of study. Preparation and purification of the material, its distillation, separation and rectification will be shown in the lab. Suggestions to re-integrate the materials will be discussed and referenced in the relevant literature.

For registration and information, contact:

The Philosophers of Nature, 125 West Front Street, Suite 263, Wheaton, IL 60187.
Phone 630.682.3938 Fax 630.665.2364 Email: alchemy@mcs.com

THE STONE

THE JOURNAL OF THE PHILOSOPHERS OF NATURE

© 1997, THE PHILOSOPHERS OF NATURE. ALL RIGHTS RESERVED.

ISSUE NUMBER 22

SEPTEMBER-OCTOBER 1997

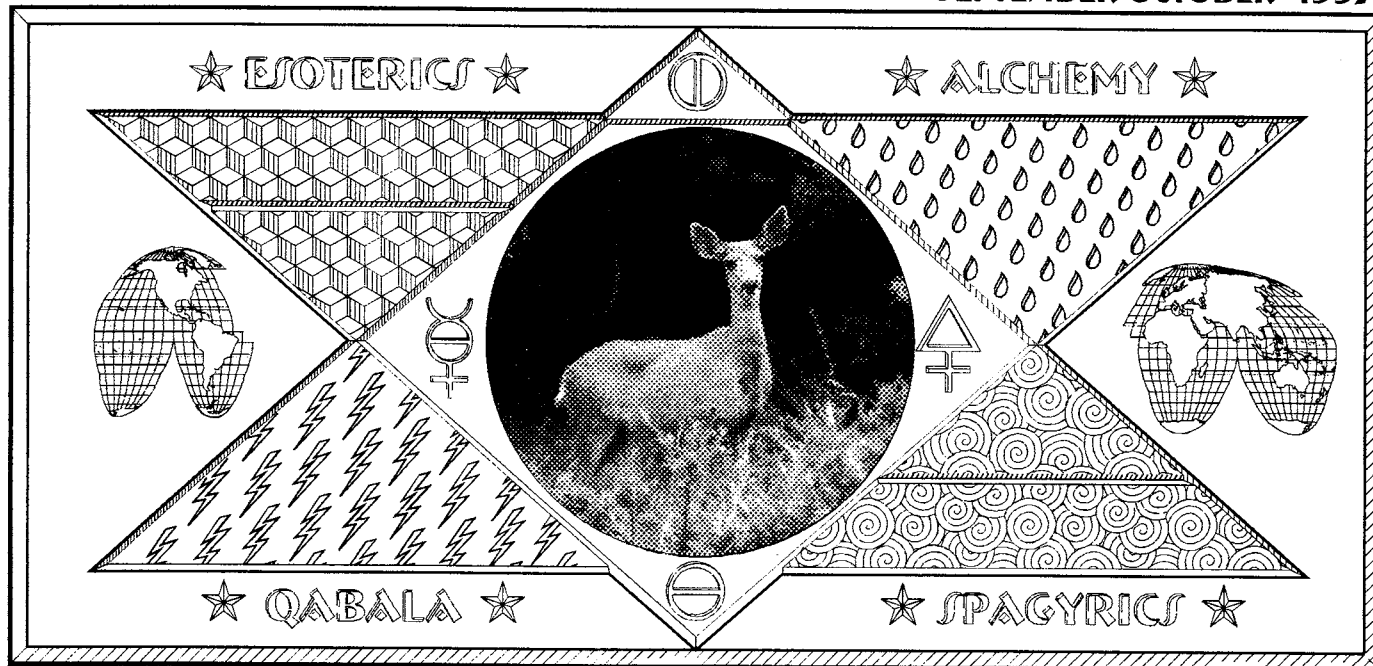

IN THIS ISSUE

Article or Feature	Author	Page
♀ A Message from the President	Russell House	2
♀ ROCKY MOUNTAIN HIGH	Charlotte Smith	3
♀ An Interview with Rawn Clark	Rick Grimes	6
♀ Rawn's Commentary On The Emerald Tablet of Hermes	Rawn Clark	8
♀ Yantras and Alchemy (PartThree)	Joseph Caezza	15
♀ Sacred Breath, Sound, and Form In Alchemical Initiation	John Eberly	18
♀ Alchemical Gardening (PartThree)	Rick Grimes	23
♀ RESOURCES	The STONE	27
♀ Video Tape - Update	Rick Grimes	29

Cover Photo: Our Deer Spirit of the Rockies

Seminar Photo

Cover

Editor-in-Chief: Rick Grimes; **Production:** Le Philosophe Inconnu

Published six times per year by The Philosophers of Nature

Price: \$5.00 US

THE PHILOSOPHERS OF NATURE

125 West Front Street, Suite 263, Wheaton, IL 60187 USA

Tel: 630.682.3938 Fax: 630.665.2364

Email: alchemy@mcs.com Internet: <http://www.mcs.net/~alchemy/>

A Message from the President

by Russ House



Perhaps some of you saw the segment of "Ancient Mysteries" on Alchemy that was broadcast on the Arts and Entertainment Network last month. Sue and I watched it with more than a little trepidation, since we were to play a role in the program. Several months earlier, a producer and camera crew came to our home for a filming session that lasted almost seven hours. We knew that there would be

only a few minutes, if that, of our interviews shown on the air.

In retrospect, I think that it went well. In the one or two minutes that we were allotted, it is certain that we did little to vindicate alchemy. Hopefully we did not bring further disgrace to the Noble Art. It was interesting to see a working alchemical laboratory on television, but unfortunately some of the beautiful camera work that the crew captured did not make it into the final product. The segment producer, David Mrazek, had done his research well, and I regret that more of our responses to his probing questions were not selected for the final production. Perhaps if I had pretended a huge interest in making gold and attempted to be a little more eccentric, I could have been a media superstar. According to Andy Warhol's prophecy, that eventually everyone would be famous for 15 minutes, Sue and I each have another 14 minutes to go.

One bit of good fortune was that I was forced to start cleaning the laboratory a few weeks ahead of schedule. I had planned to get it back in order for the class here in September, and by the time that the camera crew arrived, much of the work was done.

Still, every spare moment of the last two months has been spent cleaning the lab and reviewing materials. The amount of clutter in the lab was phenomenal, but now it is nearly ready for work again.

I am certain that some of you have a laboratory like mine, which suffers from lack of use. During one winter I opened a drawer only to jump back in alarm at the movement of a field mouse taking shelter there. If the only creature stirring in your lab is a mouse, then it is possible that you have forgotten some of the rewards that laboratory work can offer. For many, work in the laboratory forms the background for profound inner work, a continuation of the work of meditation and prayer in the oratory. It is possible to forge an interior link with the highest aspects of self, and to find confirmation of one's highest ideals and intent. If you have any inclination to clean out your lab, or to start putting one together, I would like to encourage you to do so.

I look forward to conducting research again, after nearly three years of absence from any sustained projects. I will share some technical ideas and suggestions in future issues of *The Stone*, and look forward to seeing the contributions of others along the same lines.

I would like to thank several dear friends for encouraging me to get back to work. Also, each of the board members has been very supportive and together they have made it possible for me to take the time to prepare for the upcoming seminar.

Ora et Labora!



*Front row L to R: (standing) Patrice Maleze?, Jean Dubuis, Etienne Cornaille, (seated) Mark Stavish, Sandi Halverstadt, Charlotte Smith, Sue House, Carolyn Nunnelee, and Felix Valdes. Second row, standing: Rick Grimes, Curt Kobylarz-Schmidt (sitting?), Jack Glass, Dorothy Bates, Walter Griffin, Laurel Wood, Vie Engel, Raoul Tollmann, Rolan Pirtle, Mary Rooney, Nadine Pettry, and Jim Roederer. Back row: Ray Cullen, John Reid, Judith Maxwell, Mike Applegate, Sky Jelsma, Jim Gilmour, Jhershiera Jelsma, Beat Krummenacher, Alec Gathercole, Dale Halverstadt, Norm Engel, Frank Stoffa, Dan Noreen, and Russ House.
Not in the picture: Karen Hall, Martin Schnase, Lorraine Gathercole, Paul Bartscher, Micah Neill, Ray Stewart, John Foldan, and Jesus Borrego.*

Rocky Mountain High

By Charlotte Smith

Further development of the Portae Lucis Path in Esotericism by Jean Dubuis became the centerpiece for a series of stimulating presentations and discussions at the recent PON Conference. Held at the Franciscan Center at Mount Saint Frances, just west of Colorado Springs, the altitude and rarified air symbolized the level of exchange between novices and experienced alchemists alike.



The Franciscan Center

Participants, which totaled 43 in number from as far away as Australia, began arriving early in the week to enjoy a

day or two of sightseeing before the first community dinner on Wednesday, July 16. All meals were served cafeteria style in the cozy dining room at the center, providing a convivial setting for the renewal of old friendships and the beginnings of new relationships.



Break Talk: Beat, Dorothy, Jim Gilmour(back to camera), Jack, and Walter.

Single attendees who welcomed roommates were skillfully paired by Sue House, resulting in late night discussions and the opportunity to explore common interests.

Thursday morning began with introductions and the first of three morning seminars by Jean Dubuis as he developed further the Portae Lucis Path first introduced to PON

members last summer in Colorado and in October at Chicago. Patrice Malieze again assisted ably in the translation and Etienne (last name) provided technical assistance.

While a complete explication is not possible in this brief seminar description, Jean's presentation was videotaped by Rick Grimes and will be available at a future date. Jean continues to write the lessons which will describe completely his procedures for increasing one's potential for a contact with eternity.



Jean Dubuis

Mark Stavish, Director of Research for the Occult Research and Application Project (ORA), presented information Thursday afternoon and evening on several ongoing research studies. He described several simple rituals which participants can use in their daily lives to further explore the Kundalini force and the experience of lucid dreaming and astral projection. PON members interested in participating can contact Mark at P.O. Box 2920, Wilkes-Barre, PA 18701, 717-823-1039 or e-mail: mstavish@juno.com.



Mark Stavish

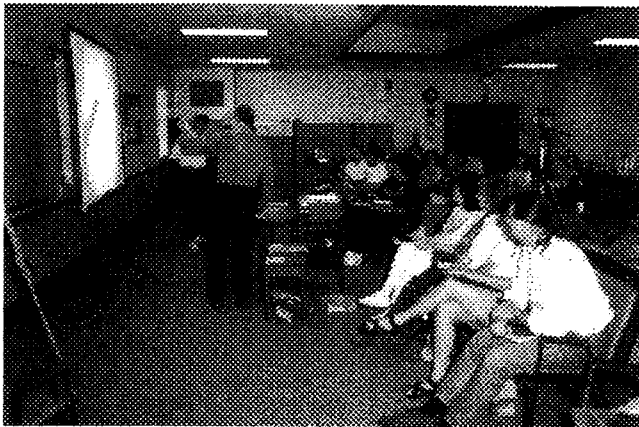

Elegantly simple, this path provides an alternative for those for whom the traditional alchemical way may prove too time consuming for today's hectic pace.

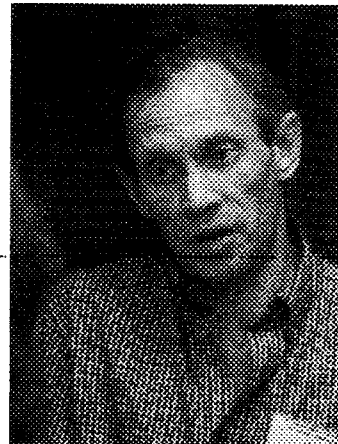

Curt Kobylarz-Schmidt

Friday afternoon and evening participants were treated to hands-on alchemical work by Curt Kobylarz-Schmidt, including a practical demonstration of "Practical Alchemy In Daily Life". Curt described his research into colloidal preparations of platinum, gold and silver.

Projected slides graphically illustrated his laboratory and the step-by-step processes which he uses.

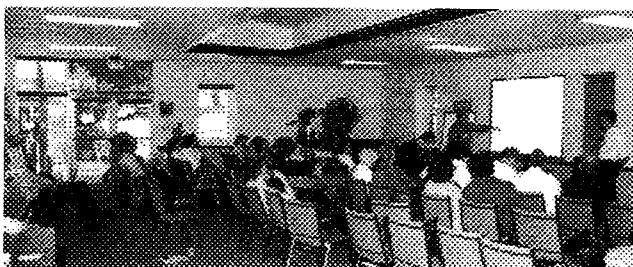

Jean Dubuis with translator and PON member, Patrice Maleze.



Carolyn Nunnelee, Rolan Pirtle, Felix Valdes, and Charlotte Smith chat with Curt.



John Reid III

John Reid III renewed our understanding of the work of Rudolph Steiner Saturday afternoon. By studying the relative capillary action of mistletoe sap and gold chloride in relation to solar and lunar eclipses, Steiner's students developed a methodology for determining the optimum conditions for harvesting herbs for medicinal use. John and his cohorts are continuing this research.

John then took us through a detailed slide presentation of his work involved in producing a plant stone, including the importance of maintaining the proper mental imagery during the procedures.

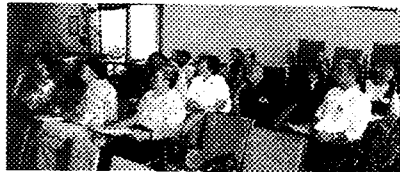

The seminar's formal sessions were enhanced by the equally valuable informal encounters between participants.



Relaxation and socializing

Curt also presented an impromptu dowsing demonstration after which he, Mike Applegate, and Frank Stoffa serenaded the group on piano and violin.

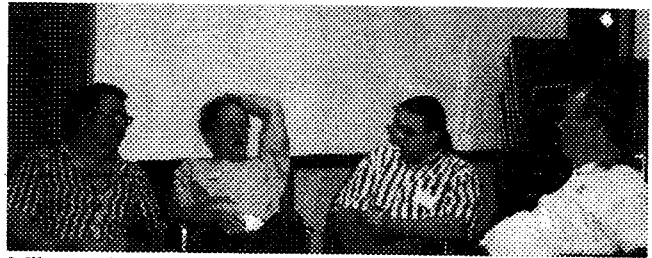

Mike Applegate, Russ House, Mark Stavish, & Ray Cullen.



We were greeted on numerous occasions, "Up close and personal," by a small herd of deer complete with antlered buck, several does, and a young fawn.

Participants also took advantage of the nearby Garden of the Gods, the Nicola Tesla museum, a new age bookstore, and other local sites of interest.

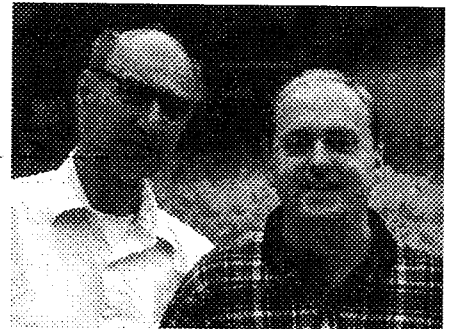

Frank Stoffa and Raoul Tollmann

Many thanks to Russ and Sue House who again exerted superhuman efforts to insure smooth communications before and during the seminar.

Based on the results of a membership survey, next year's major seminar is planned for summer in the Chicago area. Dates and seminar offerings will be announced when available. Mini-seminars will be offered in Chicago and Mark Stavish will be presenting PON concepts to different groups around the country.

There is only one remedy for missing this great seminar; be sure to come to the next one!

A note from the editor: The editorial staff apologizes for the delay in getting this issue of The STONE to you. We are enjoying the advantage of a faster, better, even *gentler* computer, however, a retrograde Mercury paid us a visit, and like old Aunt Blanch and Uncle Willard he stayed, and *staye d, ...and!*

It took two weeks of debugging to get three days of computer upgrading to run properly, but Mercury has moved on now, so you can be sure that we will do everything to avoid a delay in the future.

And thank you for the kind words of satisfaction and encouragement many of you have shared with us. - RG



ATTENTION!! ***Readers and Writers***

According to Webster's International Dictionary the words **cabala, cabbala, cabbalah, kabala, kabbala, kabbalah, qabbala, or qabalah** all refer to a system of occult theosophy or mystical interpretation of the Scriptures.

PON accepts all of these spellings as correct, however, to avoid offending our reader's or contributing writer's personal choice of spelling, the PON editors will only use the generic spelling, '**Qabala**', in all articles and other written applications appearing in *The STONE*.

An *exception* will be made when referring to book titles that include a version of the word *Qabala*. To those submitting articles; please underline all titles referenced in your submission. It will be assumed that your written titles are correct and therefore, they will be printed as received.

Thank you.
Rick Grimes - Editor-in-Chief



An interview with Rawn Clark

by Rick Grimes
August 21, 1997

Rawn Clark is one of The STONE's regular contributors offering well written insightful articles drawn from his extensive esoteric experience. The following interview will bring a more personal view of Rawn Clark to the readers of The STONE. I hope you enjoy reading it as much as I enjoyed conducting it.

RG. Briefly, what is your professional or working background?

RC. I've had many "sources of income" but never a "career". Over the years I've worked as a dishwasher, a motion picture laboratory technician, a medical secretary, a professional housecleaner, a non-profit office manager, and as an artisan/craftsperson. Six years ago, I was diagnosed with A.I.D.S. and have lived since on a meager disability pension. The transition from full-time employment to complete un-employment (i.e., from lower-middle class to official poverty) was very educational and squeezed out the last vestiges of my western tendency toward self-definition based upon "what do you do for a living?". My answer became very simple: "I live!".

RG. What was the catalyst that attracted you to your esoteric work?

RC. The first moment I recognized that there was "work" to do was when I was about 4 or 5 years old. It was the first day that the "magic didn't work" and I realized that I'd lost something precious. That was when I began the "work" of reclaiming the magic that till then had been so innocently spontaneous. In the 34 years since that day, I've come to realize that "esoteric work" has been my focus for many lifetimes, so defining a specific catalyst other than my inherent nature itself is very difficult.

RG. How has your professional experience helped or hindered you in your esoteric work?

RC. I have learned that whether it be interaction in a workplace or in a community, it is important to NOT exclude this from one's esoteric work.

These are wonderful opportunities for us to manifest our sublime self-realizations and to integrate them into our physical life experience. My professional workplace was also my esoteric workplace! How well we treat ourselves and others is a critically important aspect of esoteric work and the journey of self-realization, so I try to make good use of every opportunity for interaction that arises.

RG. Which area are you most comfortable with; Qabala, Spagyrics, or Alchemy?

RC. Qabala.

RG. Can you tell us why you were drawn to Qabala?

RC. For me, Alchemy has been an "area of study", in which I hope to gain more practical experience. Qabala on the other hand, is something I've been practicing for a number of years and with which I'm quite experienced. My understanding of Alchemy is for the most part theoretical, but my understanding of Qabala is extremely practical.

RG. What do you most want your readers to gain from your articles?

RC. I guess the primary goal of my writing is to stimulate the expansion of my reader's perspective. I try to present my personal experience in practical terms, without extraneous fuss, and in such a way that a reader can access a likewise practical experience of my subject. I hope that this will encourage my readers to gain their own unique experience of things. I also hope that my writing will encourage readers to challenge their preconceptions and expectations -- the both of which can be barriers to true inner growth.

RG. Do you have any tips to help them read you more effectively?

RC. Franz Bardon's excellent book "Initiation Into Hermetics" served as the framework for my own training, so familiarity with it is often helpful in understanding what I'm trying to say in my more practical articles (such as the "Self-Healing Archaeous"). Aside from that, I tend to condense a lot of meaning into my words. I slave over them and choose them carefully, sometimes spending hours on a single paragraph! The result is that it may take

two or three equally careful readings to get to the meat of what I'm saying.

RG. What are your views about the present state of society's spiritual life?

RC. I cannot help but place the present state of affairs into the context of the whole of time's passage. In this context, we are at a specific point in our evolution, no more or less significant than any other point along the continuum. We are maturing nicely, as it were, but still have a long way to go. As always, the evolution of society reflects the evolution of individuals. Therefore it behooves us to look to our own inner development -- self-crafting who and how we are in the world is how we forward society's spiritual evolution.

RG. In your view what is the most spiritually detrimental aspect of modern human life? And, to end on a positive note; What is the most beneficial aspect of modern human life?

RC. I don't feel that there is any aspect of human life (modern or ancient) that can be said to be "spiritually detrimental". Certainly aspects of life often test us and trouble us, but this is simply nature's way of stimulating our personal evolution. It is important to realize that each of life's moments is an opportunity for us to manifest 'spirit'. In fact, this process *is* 'spirit'. There is nothing about life which is NOT spiritual . . . even the most mundane act is a spiritual expression. The root issue then is not the nature of the external factors of detriment or benefit that we may encounter; but rather, how *clearly* do we express the influx from more-inclusive states of Self. Clarity of Self-expression is a function of internal perspective, not of external influences. The old saying, "Where there's a will, there's a way" is very apt here, for history proves that self-realization can be achieved regardless of the limitations imposed by one's particular physical circumstances.

RG. Thank you, Rawn. That gives us a deeper look into you, the man behind the words. Now, we'll proceed to your article for this issue of The STONE ; "Rawn's Commentary On The Emerald Tablet Of Hermes." First published in Caduceus: The Hermetic Quarterly Vol.2, No. 3: Fall 1996

Rawn's Commentary On The Emerald Tablet Of Hermes

By Rawn Clark

Prologue

The Emerald Tablet (ET) of Hermes is the foundation of western Alchemical thought and practice as we know it today. Alchemy is, essentially the practical application of the Hermetic Philosophy, contrary to the common perception which sees Alchemy as a mere lust for gold. In my commentary, I will examine the ET as a statement of Hermetic and Alchemical philosophy.

The exact origin of the ET lies shrouded in mystery. Opinions vary widely, from the scholarly theory that it originated in the early period of Arabic alchemy, to the speculative fantasy of an Atlantean origin. The original document has not survived and all we are left with are translations of it. There are in fact, quite a few different translations of the ET available, and I have chosen to use the 12th century Latin translation from Steele and Singer (1928:p.492). I have however, constantly referred to my library of translations (14 in all) throughout my commentary, as each difference in wording produces a slightly different interpretation. I have tried to blend the meanings of the many into my comments upon this single version.

In the past 200 years, several Arabic translations have been discovered and rendered into English as well. One of these Arabic versions contains lines that claim the ET to be the testament of a person named 'Balinas', who enters a cave and sees Hermes sitting there holding an "emerald" (meaning "green stone", not necessarily that it was specifically an emerald) tablet upon which were written certain words in ancient Syriac. Apparently, Balinas left the cave and subsequently wrote down (or transmitted orally) what he saw engraved upon Hermes' tablet. Whether historically accurate or not, these lines preface the ET with a valuable mythological image: the inner search for meaning.

THE EMERALD TABLET OF HERMES

1) **TRUE, WITHOUT FALSEHOOD, CERTAIN,
MOST CERTAIN,**

- 2) **WHAT IS ABOVE IS LIKE WHAT IS BELOW,
AM) WHAT IS BELOW, LIKE THAT
WHICH IS ABOVE, TO MAKE THE
MIRACLE OF THE ONE THING,**
- 3) **AND AS ALL THINGS WERE MADE FROM
CONTEMPLATION OF ONE, SO ALL
THINGS WERE BORN FROM ONE
ADAPTATION.**
- 4) **ITS FATHER IS THE SUN, ITS MOTHER IS
THE MOON,**
- 5) **THE WIND CARRIED IT IN ITS WOMB, THE
EARTH BREAST FED IT.**
- 6) **IT IS THE FATHER OF ALL WORKS OF
WONDER IN THE WORLD.**
- 7) **ITS POWER IS COMPLETE IF TURNED
TOWARDS EARTH, IT WILL SEPARATE
EARTH FROM FIRE, THE SUBTLE FROM
THE GROSS.**
- 8) **WITH GREAT CAPACITY (WISDOM) IT
ASCENDS FROM EARTH TO HEAVEN.
AGAIN IT DESCENDS TO EARTH, AND
TAKES BACK THE POWER OF THE ABOVE
AND THE BELOW.**
- 9) **THUS YOU WILL RECEIVE THE GLORY OF
THE DISTINCTIVENESS OF THE WORLD.
ALL OBSCURITY WILL FLEE FROM YOU.**
- 10) **THIS IS THE WHOLE MOST STRONG
STRENGTH OF ALL STRENGTH, FOR
IT OVERCOMES ALL SUBTLE THINGS,
AND PENETRATES ALL SOLID THINGS.**
- 11) **THUS WAS THE WORLD CREATED.**
- 12) **FROM THIS COMES MARVELOUS
ADAPTATIONS OF WHICH THIS IS THE
PROCEDURE.**
- 13) **THEREFORE I AM CALLED HERMES
THRICE-CROWNED BECAUSE I HAVE
THREE PARTS OF THE WISDOM OF THE
WHOLE WORLD.**

14) **AND COMPLETE IS WHAT I HAD TO SAY
ABOUT THE WORK OF THE SUN.**

Commentary

1) **TRUE, WITHOUT FALSEHOOD, CERTAIN,
MOST CERTAIN,**

Emerald Tablet (ET) begins by stating that its words are universally re are many, many levels of Truth, and the ET here specifies that its apply on all of these levels. In this way, the ET gives us a key by which to test our understanding of its words...if at any level of our experience, these words do not ring true, then our understanding of them must needs be broadened.

2) **WHAT IS ABOVE IS LIKE WHAT IS BELOW,
AND WHAT IS BELOW, LIKE THAT WHICH
IS ABOVE. TO MAKE THE MIRACLE OF
THE ONE THING.**

Here the ET defines THE ONE THING as an Infinite Continuum. The ABOVE (or any of its variant translations) establishes two concepts: 1) starting point from which there is an ABOVE; and 2) an unlimited upwardness. The term BELOW likewise, establishes: 1) the starting point from which there is a BELOW; and 2) an unlimited downwardness. The statement that ABOVE IS LIKE WHAT IS BELOW, and vice versa, places them on a continuum of likeness. This creates an Infinite Continuum with only one THING clearly defined -- the Center, from which ABOVE and BELOW stretch infinitely.

In an Infinite Continuum, Center occurs any and every who, what, when, where and why. There is no point along the Continuum from which ABOVE and BELOW do not extend infinitely, and thus, equally. In this sense, the Infinite Continuum is a ONE THING.

I call this ONE THING: Self. It includes all THINGS and all not-THINGS, and is perhaps the most inclusive and powerful Continuum we can posit. Such a Continuum places us in relation to a bird in a tree, an other person, a substance worked with in an alchemical laboratory, an

Archangel, disparate aspects of our personality, a river, to essentially anything we can imagine.

Within the Continuum, there is no such thing as a MIRACLE in that the implies an occurrence outside of Nature's Laws. The perspective of Hermetics is that what we assume to be miraculous is merely the interplay of nature's Laws in ways that we do not comprehend, and not a breaking of those Laws. With that in mind, the ET's statement of the MIRACLE OF THE ONE THING, implies that only at the level of the whole of the Infinite Continuum, is the truly miraculous an actuality; and, that everything we do here within the Continuum, is merely the manipulation of Nature's Laws.

3) **AND AS ALL THINGS WERE MADE FROM
THE CONTEMPLATION OF ONE, SO ALL
THINGS WERE BORN FROM ONE (by)
ADAPTATION.**

Having established the Infinite Continuum of Self -- THE ONE THING -- the ET now turns to a discussion of the production of life within this Continuum. The ET posits the ONE as "All Mind" and states that all THINGS arise from the CONTEMPLATION (meditation) of this ONE. Each of these THINGS, within the Continuum of Self, are self-conscious aspects of the ONE, of the All Mind, mirroring the power of the ONE, and must follow the methods of the ONE. So, as the ONE "makes" THINGS by CONTEMPLATION, these THINGS must then "birth" what they desire by a similar process -- by ADAPTATION of the process followed by the ONE.

- 4) **ITS FATHER IS THE SUN, ITS MOTHER IS
THE MOON.**
5) **THE WIND CARRIED IT IN ITS WOMB
(belly), THE EARTH BREAST FED (nursed) IT.**
6) **IT IS THE FATHER OF ALL WORKS OF
WONDER IN THE WORLD.**

The ET now describes this "adapted" process of creation. As it applies to all things, my discussion here will, of necessity, be able to cover only a few aspects of its applicability.

The imagery used is that of the human generative process (FATHER, MOTHER, WOMB, BREAST FED), which is concurrently correlated to geocentric symbols

(SUN, MOON, WIND/AIR, EARTH). As an equation, it looks like this:

(FATHER/SUN + MOTHER/MOON +
WIND/WOMB + EARTH/BREAST)
= equals =
**FATHER OF ALL WORKS OF WONDER IN THE
WORLD.**

FATHER/SUN :

This is the archetype of Force (as opposed to Form), of light (as opposed to dark), of Fire (as opposed to Water), of thought (as opposed to physical matter). It is half of a polarity -- its existence implying the simultaneous existence of its opposite pole (**MOTHER/MOON**).

Force, energy, creative intent, Mind, Yod, whatever level of this archetype one employs, It always seeks expression in Form. In an Hermetic sense, each specific vibration seeks expression through the levels of vibration which are directly below it. So each specific vibration is the expression of that which lies above it, and simultaneously, expresses itself through the levels below it. The creative process outlined in this section of the ET, is a "downward" movement of Force into Form (the "upward" movement of Form into Force, comes later). The sperm of the **FATHER**, seeks the egg of the **MOTHER**; the rhythm of the **SUN (12)** is bound to the **EARTH** by the rhythm of **MOON (13)**; the Individuality expresses itself through the personality, the mental infuses the astral; the light knows itself only when piercing the dark; Chokmah enters Binah.

MOTHER/MOON:

This is the archetype of in-Form-ing. It is the continuous movement of energy down the scale of vibration, expressing itself through ever denser manifestation. It receives the **SUN**'s rays, changes them, and then reflects them to the **EARTH**; it wraps its **WOMB** around the egg which has captured the seed; it is the first Heh of Yod-Heh-Vav-Heh; Binah transformed by the seed of Chokmah from her state of Dark Sterile Mother, to that of Bright Fertile Mother. Creation Is primarily a **MOTHER's** Work, and this is shown by the next symbols which are aspects of the **MOTHER** archetype.

WIND/WOMB:

In classical Hermetic treatment of the Elements, Air is seen as the product of Fire and Water, representing a

synthesis of the two. Air acts as the intermediary between Fire and Water, and is in effect, produced by their interaction. Each, implies the existence of all three -- they exist only in combination. If we posit Fire as "upwardness", and Water as "downwardness", then Air would be a state of non-movement, a center between the two. Air has no movement of its own accord, yet adopts any movement which is impressed upon it. In the ET's equation, the movement impressed upon the Air is downward. Here the Air is **WIND**, implying a Force behind it, and stressing that it is an expression of this Force. This expression acts as a **WOMB**, carrying the creation through gestation to birth. The Air clearly acts here as the agency of a downward Force in its accretion of Form.

In Qabalistic terminology, this is Tiphareth as the product off Chokmah and Binah; but in its active downward flow towards Malkuth. The Vav of YHVH in its aspect of seeking downward expression through the Heh-final. This is the inclusion of the other planetary influences into our earthly experience by the cycles of Sun and Moon. This is the Individual Self of the "Adept's consciousness", which expresses itself through the personality and physical body.

EARTH/BREAST FED:

Fire + Water + Air = Earth, is a common conception of the Element's relationship; but at an archetypal level. Practically and functionally however, Earth is experienced as an individual Element just like Fire, or Water. This is the archetype of Form itself. Whereas Water is the tendency to Form, Earth is the product of this tendency, the final clothing given to Force in its descent into expression. The **EARTH** nourishes the creation, giving it solid and independent form.

This is Tiphareth clothed in Yesod, and manifest in Malkuth. The Heh-final of YHVH. This is the Individual Self, expressed through the personality, within a physical body.

FATHER OF ALL WORKS OF WONDER IN THE WORLD:

These four Elements combined, plus the Fifth -- the conscious awareness of the creator -- result in independent life. Here, the ET symbolizes this by describing the result as a **FATHER**, which brings us back to the beginning of our equation, like the Uroboros, finding its end in its beginning in an endless cycle of self discovery. This nascent **FATHER** is said to generate **ALL WORKS OF**

WONDER IN THE WORLD. Note the distinction here between **WORKS OF WONDER** and **MIRACLE**, implying that within the Continuum, the **FATHER** obeys the Laws of Nature.

Of paramount importance in the process of creation outlined in the ET is the factor of the creator's conscious awareness. It is the Fifth Element, the Quintessence, and though assumed throughout, it is never directly named. While the expression of the higher through the lower is a natural phenomena, it is only through the addition of conscious awareness that it produces the **FATHER OF ALL WORKS OF WONDER IN THE WORLD.**

7) ITS POWER IS COMPLETE (*integra*) IF TURNED TOWARDS EARTH. IT WILL SEPARATE EARTH FROM FIRE, THE SUBTLE FROM THE GROSS.

The product of the ET's downward equation of creation, is a **FATHER**; or in an Elemental sense, a **FIRE**. This is an active Force, though clothed in denser layers of vibration than **FATHER/SUN**. This **FATHER/FIRE** is none other than the Quintessence clothed in physical Form -- the power of conscious awareness as expressed through the human being.

The ET states that this power of conscious awareness is **integra** (whole, complete, entire) if **versa fuerit** (turned-toward, cast to) the earth. This means that conscious awareness at the human level (**FATHER/FIRE**), re-establishes contact (implying then, a participation in the Whole) with its more archetypal expressor (**FATHER/SUN**), when it is turned inward to the Self clothed in densest matter (**EARTH**).

This turning inward upon itself, is what initiates the cycle of return, and brings us to the next equation, that of Force arising from Form.

Whereas the ET's first equation was a downward one of the addition of Form onto Force, this new **FATHER** causes an opposite action, one of separation of Force from Form. The power of this introspection is two-fold: A) it will **SEPARATE EARTH FROM FIRE**; and B) it will separate **THE SUBTLE FROM THE GROSS.**

With 'A', we see it separating the denser **EARTH** (physical manifestation) from the initial inspiration of its

subtler **FIRE**. This is the Quintessence working upon itself, from the ground up, so to speak. Its effectiveness begins from the starting point of its densest manifestation, separating itself from its Self. This is a very apt description off the process of human introspection, or of alchemical putrefaction and fermentation. Here the Fire acts upon the Whole, and separates the **EARTH** from its **FIRE** (itself), consciously shedding its clothing of matter.

With the **FIRE** thus freed from its **EARTH**, the ET leads us to the perspective of 'B', where there is a reaching down, and a separating of the **SUBTLE**, this time, from the **GROSS**. 'A' (**FIRE-minus-EARTH**) and 'B' (**GROSS-minus-SUBTLE**) are the same processes, but on different levels and as seen from different perspectives: 'A' from **BELOW**, and 'B' from **ABOVE**. The action of the **FATHER/FIRE** is one of separation throughout, but in 'A' that action is a movement from **BELOW** toward **ABOVE**; and in 'B', it is an action from **ABOVE**, reaching down into **BELOW** to raise it to **ABOVE**.

This outlines a double process of separation. First the **EARTH** is removed from the **FIRE**, which implies an ascent of conscious awareness, from **EARTH** to that of **FIRE**. This **FIRE** then acts upon itself anew, separating its own essence from its **GROSS** aspects. As a whole, it is a process of the **FATHER/FIRE** self-consciously releasing its Self from Form -- almost a direct reversal of the initial creative process.

8) WITH GREAT CAPACITY (WISDOM) IT ASCENDS FROM EARTH TO HEAVEN. AGAIN IT DESCENDS TO EARTH, AND TAKES BACK THE POWER OF THE ABOVE AND THE BELOW.

Conscious awareness, now liberated from its clothing of Form, rises upward through the levels of vibration within the Continuum. It does so with **magno ingenio** according to the ET. This term translates roughly as "great (*magno*) natural ability or talent (*ingenio*)", and is often posited as **WISDOM**. It is a very subtle force, one which implies an inherent ability -- a natural aspect of the Self-realized awareness.

This ascent is from **EARTH**, or the clothing of Form (the **BELOW**), to **HEAVEN** (the **ABOVE**), or a state of no-Form, and completes the ET's second equation of 'Force from Form'.

The descent of Force into Form, and its subsequent ascent back to a Form-less state, is however a process of a Self-conscious awareness, an awareness that learns throughout the process. The Force that originally descended into Form, is no longer the same, now that it has ascended -- it has changed and been transformed by the experience of Form. It now has the power, the **WISDOM** if you will, to descend anew into Form, bringing with it the increased awareness of its nature as a Force. Through its second descent into Form, Force integrates its **ABOVE** aspects within its **BELOW** aspects, and becomes a clear expression of the whole Continuum of **ABOVE** and **BELOW** (again we are brought back to the beginning of our equation, illustrating that the Uroboros is not merely a circle, but a spiral). The result is a Self-aware Force, consciously clothed in Form, intentionally uniting the **ABOVE** with the **BELOW**.

- 9) **THUS YOU WILL RECEIVE THE GLORY OF THE DISTINCTIVENESS (LIGHT OF LIGHTS) OF THE WORLD. ALL OBSCURITY (DARKNESS) WILL FLEE FROM YOU.**

The ET presents a three-fold equation: 1) Force descends into Form in an act of creation (a four-fold process); 2) Force acts upon its in-Formed self, consciously ascending to a Form-less state (a three-fold process); and 3) Self realized Force descends anew into Form, seeking to consciously express its Self therein (a one-step process). Through this sequence, Force acquires a degree of Self-realization, re-connects with the powers of its true source, and is transformed into a new **FATHER** which **RECEIVES THE GLORY OF THE WORLD**.

Another active Force is produced, this time with the symbols of "light" attributed to it (an important echoing of **FATHER/SUN**), and is clearly a higher octave of the **FATHER OF ALL WORKS OF WONDER IN THE WORLD** (the **FATHER/FIRE**). This new **FATHER/LIGHT**, has the power of Understanding and Wisdom, which illumines all darkness. Notice the progressive shift from a physically active Force, to a mentally active one.

- 10) **THIS IS THE WHOLE MOST STRONG STRENGTH OF ALL STRENGTH, FOR IT OVERCOMES ALL SUBTLE THINGS, AND PENETRATES ALL SOLID THINGS.**

Here the ET describes this new **FATHER/LIGHT**, the completely Self realized awareness. It does so in three parts, echoing the three-fold pattern we see throughout.

Part 1: **THE WHOLE MOST STRONG STRENGTH OF ALL STRENGTH**. This is another triple-superlative, similar to the opening line of **TRUE, WITHOUT FALSEHOOD, CERTAIN, MOST CERTAIN**. **STRENGTH** implies a usable storehouse of Force and here we see that this Force is applicable on all levels. It is even effective with all other levels of Force, as this **FATHER/LIGHT** is the **MOST STRONG** of all the active Forces within the Continuum. Please note the similarity between this aspect of the **FATHER/LIGHT** and the initial 4-fold process of creation -- both are downwardly active, initiated from **ABOVE** upon **BELOW**.

Part 2: **IT OVERCOMES ALL SUBTLE THINGS**.

This is the **FATHER/LIGHT**'s upward power to surpass any upward tending thing. The second part of the ET's 3-fold equation, that of the upward movement of Force from Form, is echoed here and attributed as a power of the **FATHER/LIGHT**.

Part 3. **PENETRATES ALL SOLID THINGS**.

This is the **FATHER/LIGHT**'s downward power to inhabit (express itself through) any denser vibration of matter. The active Force represented here is equivalent to the third part of the ET's equation, that of the conscious re-descent of Force into Form.

FATHER/LIGHT, the product of the ET's three-fold equation, mirrors the attributes of the **ONE THING**, the whole of the Infinite Continuum. It appears capable of an equal creativity, but only *within* the Continuum -- an octave lower than **THE MIRACLE OF THE ONE THING** -- an expression of it.

This, of course, implies an infinite, cyclic process of continual recreation, wherein this **FATHER/LIGHT** becomes the Creatrix to a new generation of **FATHER/LIGHT**, and so on.

- 11) **THUS WAS THE WORLD CREATED.**

This is a very deep statement. The Divine Pymander (Librum I:Corpus Hermeticum) describes a similar sequential, cyclic process of Force descending into Form,

becoming self-aware and then creative anew, followed by another descent further into Form. The eventual result is "the world". This is also seen in Qabala as the Kethric Light descends into Malkuth, and becomes creative anew at each step of the way.

This says something very important about the world around us. It says that everything is alive. Every thing, every person, animal, tree, rock, drop of water, pile of dung, everything, is alive and is the product of the **ONE THING**. Each thing has the power of the **FATHER/LIGHT** tucked away inside of it...no matter at what level of manifestation we look, this is true, without falsehood, certain, most certain.

12) **FROM THIS COMES MARVELOUS ADAPTATIONS OF WHICH THIS IS THE PROCEEDURE.**

The **THIS** from which come **MARVELOUS ADAPTATIONS**, is **THE WORLD**. Here we see into the heart of Alchemy as the ET states that every natural thing has the **FATHER/LIGHT** within it, and each thing is therefore the seed of its future self. It is at the level of **MARVELOUS ADAPTATIONS** that we humans intervene, for we must, as physical beings, work with the substance of **THE WORLD**. We work *within* the Continuum, mirroring the powers of the **ONE THING**, performing **MARVELOUS ADAPTATIONS** as opposed to the **MIRACLE** of the **ONE THING**.

Conscious awareness within a physical body, is an example of Force within Form, of the **ABOVE** inhabiting the **BELOW**. This is what we have to work with -- this is **THE WORLD** upon which we turn our **FIRE**, our **FATHER/LIGHT**, and self-craft our future selves. What has preceded this point in the ET, has been a description of the natural processes of the formation of our prima materia -- **THE WORLD**. Only now do we come to the procedure by which we create our **MARVELOUS ADAPTATIONS** (the Stone), and this is revealed in the two closing lines:

13) **THEREFORE I AM CALLED HERMES THRICE-CROWNED, BECAUSE I HAVE THREE PARTS OF THE WISDOM OF THE WHOLE WORLD.**

14) **AND COMPLETE IS WHAT I HAD TO SAY ABOUT THE WORK OF THE SUN.**

These lines break down to three sections in echo of the overall three-fold nature of the ET:

A) **THEREFORE I AM CALLED HERMES THRICE-CROWNED. THEREFORE** implies a sense of consequence, and **I AM CALLED** implies a second-hand knowing. This is the initial bringing of Force into Form...the novice studying, praying and experimenting...the **FATHER/LIGHT** turning upon itself with its **FIRE**, in cyclic **ADAPTATION** of the process of the **ONE THING**...the seed rotting in the earth, dynamizing the power which will inevitably spring forth.

HERMES THRICE-CROWNED is a very potent and broad symbol; one which I cannot do justice in the space of this short commentary. Briefly, it is a symbol of the Three-In-One, an image of thesis, synthesis and antithesis combined. It is Sun and Moon, and every thing that lies between these two archetypes. More to the point in this context, is that it represents the power that Center has within an Infinite Continuum -- it can occur anywhere and/or everywhere, and is in effect a mobile, self-directed agent of the Whole. That Hermes is **THRICE-CROWNED**, is an indication that this power is active on the three levels of physical, astral and mental (Salt, Sulphur and Mercury).

Section 'A)' clearly mirrors the first part of the ET's basic equation: the creative descent of Force into Form, the inevitable, natural result of which is the **FATHER/FIRE** who initiates the subsequent ascent:

B) **BECAUSE I HAVE** (the) **THREE PARTS OF THE WISDOM OF THE WHOLE WORLD**. -- Here there is a sense of personal knowing, of **I HAVE**, indicating individual experience. The actual possession of the three **FATHERS** is implied by the term **WISDOM**, the Supernal Fire. And here we also see that they are powerful *within* the Whole Continuum. This represents the achievement of the second part of the ET's equation, that of the ascent of Force from Form. There is also an indication that this process is to be accomplished three times (mentally, astrally and physically). Please note how this **WISDOM OF THE WHOLE WORLD** is a slightly different expression of the **FATHER OF ALL WORKS**

OF WONDER IN THE WORLD (which I've designated with the term **FATHER/FIRE**).

C) **AND COMPLETE IS WHAT I HAD TO SAY ABOUT THE WORK OF THE SUN.** -- As in part three of the ET's equation, the procedure of **MARVELOUS ADAPTATIONS** is made **COMPLETE**, whole, entire (an echo of "*integra*") by the conscious re-descent of Force into Form. Here this is symbolized by the phrase **WHAT I HAD TO SAY**, which implies a past-tense, intentional expression of an idea (Force) through words (Form -- remember now, this was supposedly inscribed upon green stone!).

WORK OF THE SUN is another broad symbol. In short, it points here to the fact that this is an active process *within* the Continuum. The **SUN-Tiphareth** connection points to this being a Yetziratic, or creative, process, carried out by the Individual Self. In a Qabalistic sense, this constitutes a metallic Work, specifically that of gold. It is furthermore Mercurial, in that it is predominantly Fire mixed with Air(Helios). The **SUN** also implies a specific rhythm, symbolically uniting the 4-fold Elements and the 3-fold Principles in its journey through the 12-fold zodiac.

This 3-fold procedure of **MARVELOUS ADAPTATIONS** is very similar to the ET's archetypal equation; yet has distinct differences, occurring as it does, on a lower octave *within* the Continuum.

And so the Emerald Tablet of Hermes ends. "*Integra*" by virtue of its having finished with the decent of its essential Force into the Form of instructions for our enlightenment.

Epilogue:

The ET outlines an essential three-part equation:

- 1) The creative descent of Force into Form (a 4-step process).
- 2) The ascent of Force from Form, in a conscious act of Self-realization (a 3-step process).
- 3) The re-descent of Self-aware Force into Form (a 1-step process).

In the first part of the equation, the **FATHER/SUN** acts as the initial agent of the **ONE THING**, producing the **FATHER OF ALL WORKS OF WONDER IN THE WORLD**, or the **FATHER/FIRE**, as I have designated it here. The **FATHER/FIRE** is the active agent of the second

part of the equation, and produces the **FATHER/LIGHT** who re-descends in the third and final part.

This equation cycles three times throughout the ET. In the first cycle, the **ONE THING** produces the initial **FATHER/LIGHT**; the second cycle is that of the **FATHER/LIGHT**, acting upon itself, producing **THE WORLD**; and the third cycle is represented by human action, those **MARVELOUS ADAPTATIONS** performed upon the prima materia of **THE WORLD**.

These are just a few of my observations of the meaning contained within the Emerald Tablet. It is one of the "root texts" of humanity...a bit of archetypal poetic symbolism, which presents a different glimmer of Wisdom to each who approaches it, each time it is approached. Over the years that I've studied the ET, meditating upon it and experimenting with its precepts, I've come to see it as a brilliant beacon of Wisdom's light...so different from my first impression of it as something so dense I'd never penetrate its enigma.

I pray that my commentary inspires you to consider the ET in your own way, pulling from it your own portion of Wisdom.

Blessed Be!

Rawn Clark
8 Feb 96



*"Minimise the common about
yourself...
and
...maximize the uncommon."*

----- Old proverb.

YANTRAS AND ALCHEMY

by Joseph Caezza
PART THREE

Alchemy concerns itself with the cycle of Creation; germination, growth, death, regeneration and its implicit perfection hidden in a play of parts emanating from and returning back into cosmic wholeness. Nowhere in Nature does this cycle reflect more obviously than in the phases of the waxing and waning moon. The ultimate mystery of time itself, the mystery of Being, at the root of Alchemical and Tantric mysticism presents itself in the symbolic icons of the Nitya Kalas, the sixteen aspects of the lunar cycle. Primordial Shakti, the Great Goddess divides herself initially into the sixteen lunar fractions (kalas) that constitute the basis of an elaborate system of correspondences.

Sixteen results from multiplying the three qualities of material Nature: sattva (sulfur), rajas (mercury) and tamas (salt) by the five elements (earth, water, air, fire, ether) and then adding the first creative transcendental Nitya Kala who resides at the bindu seed center of the Sri Yantra.(1). Among other things these Shaktis correspond to the sixteen vowels of Sanskrit, the petals on the throat chakra and form the basis of an elaborate mathematical progression that provides a model of the four great ages of cosmic time.

Perhaps nowhere in the English language have the metaphysical foundations of Alchemy been more profoundly explicated than in R. A. Schwaller deLubicz's EGYPTIAN MIRACLE. His account of the mythic anomaly of the Theban "Great Ennead" of fifteen neters, archetypal divinities, and their relation to the lunar phases bears bizarre similarity to the Tantric symbolism of the Nitya Kalas ($10 - 1 = 9$; $16 - 1 = 15$). Schwaller insists that "we can understand nothing, that we can know nothing that is not initially triangular"(2). The unmanifested divinely creative Pythagorean Tetractys becomes manifested in Nature as the Pentactys, the fifteen unit form (Figure 1). Both images function as yantras and after deep contemplation reveal the wonder of continuous creation. The unutterable source unit added to the fifteen unit form results in sixteen. Mythologically Toth-Hermes, the master of Time, takes his place as the fifteenth finger breadth on the Egyptian Royal Cubit. He presides over the lunar phases by conducting the solar barque on its celestial circuit.

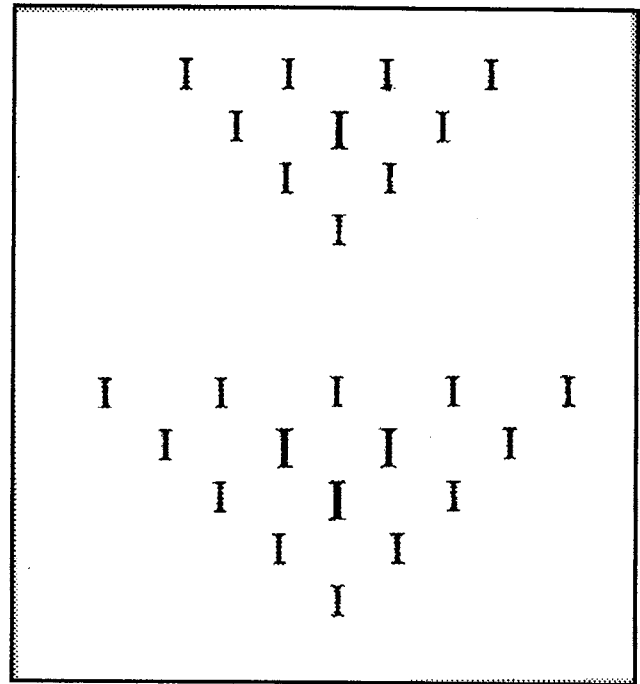

Figure 1

In the Tantric system each phase of the moon defines a specific Goddess with a unique function. Taken together they are Adya Nitya, the all beneficent; Kamesvari, the fulfiller of desires; Bhagamalini, who charms and incites; Nityaklini, grants fortune and supernatural powers; Bherunda, frees from evil influence; Vahnivasini, makes one master of the forces of Nature; Mahavajreswari destroys cruelty; Duti, destroys fear and bestows prosperity; Tvarty, grants beauty, fame and learning, Kulasundri, bestows esoteric knowledge (Figure 2);

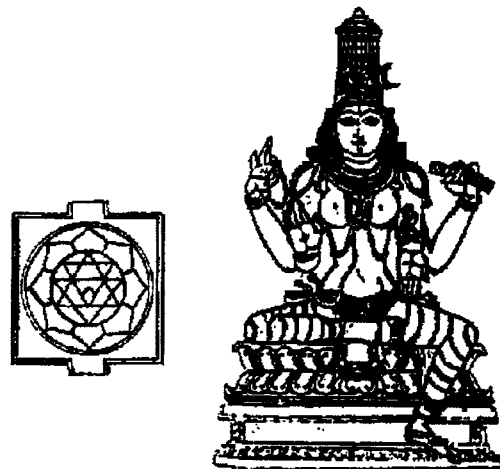

Figure 2

Nitya Nitya is beneficent; Nilapataka bestows mastery over evil Nature; Vijaya, grants conquest and prosperity; Sarvamangala, is totally Beneficent; Jvalamalini, bestows knowledge of one's previous births; Chitra grants objects of desire. Each Goddess resides at a specific location within the Sri Yantra and each has her own specific yantra, mantras and ritual propitiation (Figure 3). The Nitya Kalas stand as guardians to the innermost sanctum of the Sri Yantra by surrounding the Trikonam, the central triangle.

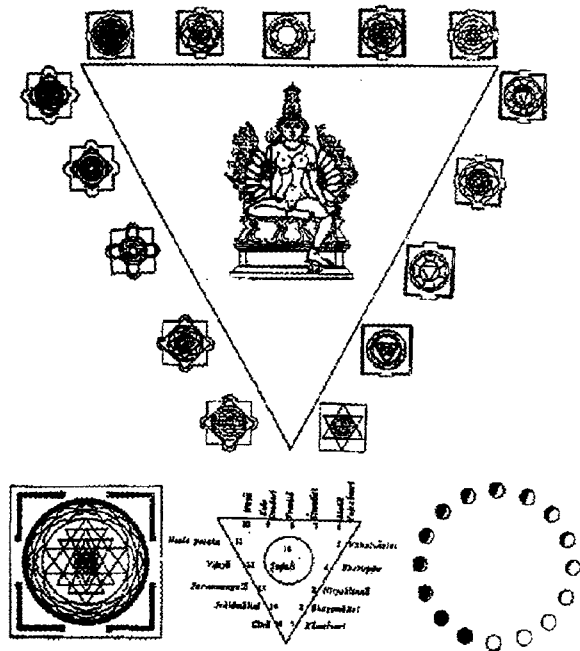

Figure 3

The most popular form of Sri Yantra contemplative worship entails recitation of a brief litany known as Khadgamala. Khadgamala, literally "the garland of the sword", a list of one hundred and eight names of yogini Goddesses who reside at specific locations on the yantra begins starting from sites on the outer square perimeter and spirals generally counter clockwise to the center. These Yogini Goddesses remain distinct and subordinate to the Nitya Kalas. Before reciting these yogini names and simultaneously contemplating their successive locations on the Sri Yantra which maps onto the subtle body of chakras the devout worshiper must make preliminary invocations, purifications and pay homage to the Nitya Kalas.

While Khadgamala may take only ten minutes to perform the most elaborate form of Sri Yantra worship known as the Navavarana puja may take longer than five hours. This

ritual is usually performed on full moon nights and on the nine nights of the Navaratri holy season usually observed in Autumn.

Navavarana puja begins with a highly esoteric rite known as the Sri Kramam. After initial invocations the devotee uses the letters of the Sanskrit alphabet and potent bija mantras to identify the parts of his subtle and physical body with that of the Great Goddess and her three dimensional Sri Yantra form. An elegantly sophisticated system of hand gestures and ritual accouterments figures into the preparation of a sacramental beverage, amirtam, the nectar of immortality, that calls to mind the communion host of the Roman Catholic Mass. The rays of the sun and moon are invokes into various natural ingredients; herbal waters, milk, honey and clarified butter among other substances and meticulously mixed in a process that recalls the laboratory manipulations of an alchemical magnum opus. The Nitya Kalas play a major role in this rite. Contemporary rumor explains that the mantras used in this ritual alter DNA expression, ensure spiritual enlightenment and even make the devotee physically immortal!

I originally moved to Rochester, N.Y. with the specific intention of studying yantra worship at the Rajarajeswari Peetam. The Peetam is a religious community composed almost exclusively of South Indians dedicated to preserving the authentic and intensely rigorous aspect of Tantric ritual. Their library contains a collection of over fifteen thousand volumes, much of it in Sanskrit and Tamil. This compliments the main Temple hall presided over by a five foot two inch high black granite image of the great Goddess. The wall behind the main statue features posters of the Nitya Kalas and their corresponding yantras (Figure 4).

Kenneth Johnson, in the climactic chapter of his, THE FULCANELLI PHENOMENON, entitled "The Ultimate Mystery" attempts to reconcile the iconographies of Tantric Yoga and Alchemy. He dwells at length on the lunar kalas explaining that the sixteenth kala "is in some way connected with the concept of time standing still and that it bisexualises man and woman and rejuvenates to an extraordinary extent"(3). Yantra contemplation clarifies the turbid quality of his observations.

The sixteenth Nitya Kala is the unutterable incomprehensible seed center. She is unconditioned BEING, the hidden



Figure 4

God of the Jews. She is absolute unity known to Lao Tzu as Tao, the “mysterious female”. All attempts at rational explanation fail. With the products of the Hermetic magnum opus her presence can be demonstrated but never taught. She is discovered only by direct revelation.

The enigmatic homology of symbolic forms presented by Western Alchemy and Tantric Yoga have long haunted the greatest scholars. Mircea Eliade noted that there are certain moments when the “osmosis” between these two disciplines is perfect. The contemporary Sanskritist, Dr Douglas Brooks argues that present Tantric practice emerged out of archaic alchemical insight. The recent release of THE ALCHEMICAL BODY: SIDDHA TRADITIONS IN MEDIEVAL INDIA by David Gordon White poses an exhaustively researched thesis of the “work in two parts” (karmayogo dvidha). Yogic techniques and alchemical operations were practiced simultaneously by the greatest adepts. “As in metals so in man” declares a popular admonition. White escorts us on a

dazzling excursion through the laboratory processing of mercury and its concomitant parallels in the practice of Tantric Yoga. This volume is a stupendous feast for anyone seeking authentic information on this great enigma.

The lunar experience instigates a wide variety of practices. A popular item of yogic folklore states that any disease may be cured simply by staring continuously at the full moon from the moment of moonrise until the moment of moonset. More complex methodologies utilize vaginal secretions taken at strategic moments in the lunar cycle amalgamated with mercury to fabricate the Philosophers Stone. Well known to western tradition is the collection of the lunar rays in the form of dew, understood as the unspecified procreative secretions of the Great Goddess. Successful animation of certain operative materials for example corrosive sublimate or sea salt may be affected simply by prolonged exposure to lunar rays. These are external applications of an internal process where the subtle body perceived as a bipolar microcosm situates the sun in the abdomen and the moon in the cranial vault. Physical regeneration depends upon sublimation of semen up the spine into the down turned crown chakra visualized as a lunar fraction. When renewed to completeness it radiates all sixteen lunar digits. Yet such completeness remains unachievable without the seed digit, the sixteenth kala. Yantra contemplation functions to provide this essential ingredient by focusing attention to the center imagined in the Tantric tradition as a sixteen armed sixteen year old girl (Figure 3).

Appreciation of lunar symbolism begins with the simple pedestrian experience of wondrously perceiving the moon. Sustained contemplation leads one naturally to an ever deepening intensity of perception. One must see not just look. James Joyce remarked that “Any object intensely regarded, may be a gate of access to the incorruptible eon of the gods”. The moon remains perhaps the choicest object for such regard. The Nitya Kalas and their yantras bear living testament to an ever present promise of renewal.

References

- (1) Khanna, Madhu; YANTRA: THE TANTRIC SYMBOL OF COSMIC UNITY, Thames and Hudson (1994) pg 65
- (2) Schwaller de Lubicz, R.A.; THE EGYPTIAN MIRACLE: AN INTRODUCTION TO THE WISDOM OF THE TEMPLE, Inner Traditions (1985) pg 86

(3) Johnson, Kenneth Rayner; THE FULCANELLI PHENOMENON, Neville Spearman (1980) pg 265

SELECTED BIBLIOGRAPHY

(1) Brooks, Douglas Renfrew; THE SECRET OF THE THREE CITIES: AN INTRODUCTION TO HINDU SAKTA TANTRISM, University of Chicago, 1990

(2) Brooks, Douglas Renfrew, AUSPICIOUS WISDOM: THE TEXTS AND TRADITIONS OF SRI VIDYA SAKTA TANTRISM IN SOUTH INDIA, State University of New York, 1992

(3) Guthrie, K.S. (transl.) THE PYTHAGOREAN SOURCEBOOK AND LIBRARY, Phanes, 1987

(4) Iamblichus; THE THEOLOGY OF ARITHMETIC: ON THE MYSTICAL, MATHEMATICAL AND COSMOLOGICAL SYMBOLISM OF THE FIRST TEN NUMBERS, Phanes, 1988

(5) Schneider, Michael, A BEGINNERS GUIDE TO CONSTRUCTING THE UNIVERSE, THE MATHEMATICAL ARCHETYPES OF NATURE, ART AND SCIENCE: A VOYAGE FROM ONE TO TEN, Harper Collins, 1995

(6) TANTRARAJA TANTRA, ed. Sir John Woodroffe, Madras, 1954 (The ultimate Sanskrit scriptural authority on the Nitya Kalas) See also: NITYA SHODASIKARNANA and VAMAKESWARA TANTRA

(7) White, David Gordon; THE ALCHEMICAL BODY: SIDDHA TRADITIONS IN MEDIEVAL INDIA, University of Chicago, 1996

(8) Zvelebil, Kamil; THE POETS OF THE POWERS: FREEDOM, MAGIC AND RENEWAL. Integral Publishing 1993

INTERNET RESOURCES

- (1) <http://ccat.sas.upenn.edu/george/yantra.html> Meticulous instructions on construction of the SRI YANTRA
 (2) <http://srividya.org> Home page of the Rajarajeswari Peetam
 (3) <http://www.shreemaa.org>. Authentic TANTRA wholly devoid of the bogus hypersexuality usually associated with this tradition



SACRED BREATH, SOUND, AND FORM IN ALCHEMICAL INITIATION

By John Eberly

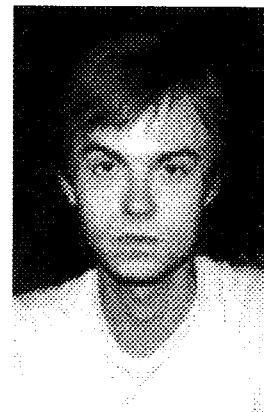

In the beginning is the word, the Holy Word. It is the *Natursprach*, the language of the signatures of nature; it is the ancient Hindu seed word; it is the secret name of the pharaoh; it is the unpronounceable name of the Hebrew God; it is the Jesus prayer; it is one and therefore all of the Muslim's ninety-nine most beautiful names of God; it is the incantation of the magician; it is, and can be, as we shall see, any word or utterance under the right conditions and circumstances.

When we speak of the word as something sacred and holy we articulate the most basic gift of communication: that which occurs when God first breathes life into the clay of creation. This holy breath is known in Islam as the *nafas-r-Rahman*, the "breath of the Merciful." The sweet air that we breathe, the essential substance commonly and constantly shared and yet so sublime that we most often take it for granted, is awakened into the body with the first inhalation at birth and exhaled, "expressed," indeed, *pressed out* at last, by the angel of our death. Breath is the reality behind the appearance of the word, and as such can only be approached and revealed by its outer garment of primordial sound.

Jacob Boehme (1575-1624) in the early seventeenth century wrote of the total potency of universal forces in his first book and called that sum total of all power the Salitter. He divided this concept in two, one which exists in and of light, a heavenly Salitter; and the earthly, or "dark" Salitter. We experience the shadow-side of this duality on earth through the generation caused by the penetration of the sal, or thirsty salt of the earth; by the niter charged in the clouds and dispersed in rain water and also found in morning dew. The sixth of seven "qualities" which Boehme gives to Salitter is sound, and Salitter in it's expression, or discharging sound is called Marcurius (Mercury).

The holy breath, expressed into the earthly realm via the soul, or sol, or sulphur, (the light, or "sun" of God), is articulated by the mercurial spirit in the garb of pure sound. The life-giving word is received (or more precisely, craved) by the salt-body, the matrix, the earth mother which constantly generates form. Yes, this is a love story!

In the Hindu traditions, all elemental sound-forms of mantras come from the seed-mantra, *Om*. In Tantra, a Sanskrit word derived from the root *tan*, which means to expand, sound and form are interdependent. Form becomes the result of a sound vibration of a certain density. Sound, invisible as breath, and universally comprehended, becomes a secondary basis for our awareness: following the initial inspiration of the newborn comes the inevitable scream.

Labbayka-Llahumma labbayk,

Here I am Lord! Here I am!

-The beginning of the central recitation used all the days of the Hajj, the Muslim pilgrimage to the Kabba in Mecca.

A Hindu master once replied in response to a question from a potential disciple concerning the bestowing of the mantra, or sacred word, "I can give you a mantra, of course, but until you realize that every breath you take is holy, the mantra will do you no good."

During the nineteenth century, enemies of Mushtaq Ali-Shah, a celibate Sufi master and *majdhoub*, or one "crazy for God," sent a prostitute in an attempt to draw him out of his mystic state. Mushtaq endured her pestering awhile and finally exclaimed, "whore! Begone!" The moment in which the woman heard the master utter the word "whore" she became enlightened, and this word, uttered with the same life-giving breath of benevolence with which Jesus inspired the dead body of Lazarus, became her constant prayer.

The famous Sufi poet Kabir received his holy word in the following way: One morning before dawn the young Muslim lay down upon the stairs leading to the river where the Hindu master Ramananda came for his early

morning bath. As Kabir expected, when the master stepped on his body, he exclaimed "Ram! Ram!" Thus revealing and simultaneously bestowing his mantra upon Kabir.

A common factor in both the initiation of the prostitute and that of Kabir: However unusual the circumstances may appear, all of the necessary components for the transformation of the individual are apparently present and in place. Timing may seem random in retrospect, yet it is the essential and elemental *present* which "fixes" the event in eternity. The prima materia must be ready and intuitively and perfectly placed in time before the spirit will enter and smash all clocks. The thirsty salt of individual consciousness is quenched by the mercury of holy spirit sound/word and is consumed in the living fire of the One soul/sol. The initiate remembers a divine origin-purpose-destination by means of a subtle return to the breath of the Merciful through sound.

Zikr is a Persian form of the Arabic word *dhikr* which literally means "remembrance." It is traditionally a prayer, or simply a name of God which the Sufi master inculcates through breath and sound in the disciple. Exactly like the "Jesus prayer" of the Christian hesychasts which also has its origin in the ancient model of the Hindu

A Hindu master once replied in response to a question from a potential disciple concerning the bestowing of the mantra, or sacred word, "I can give you a mantra, of course, but until you realize that every breath you take is holy, the mantra will do you no good."

mantra, the *zikr* is to be repeated with every breath. When breathing in, the Sufi concentrates on God's external attributes summed up in the name(s). When breathing out, one takes refuge in God's essence, the invisible reality behind all manifestation. The disciple's concentration upon the *zikr* invokes the Master, and by remembering the Master with every

prayer/breath, the disciple eventually remembers God, the origin of being.

"I breath only when You accompany my breathing;
You cause my spirit to flow in its channels"

-Abu Nasr Sarraj Tusi

The inner alchemy of this sort of prayer seeks to establish the remembrance intellectually and then transforms the physical heart of the practitioner until a state beyond the

limitations of such concepts as “intellect” and “physical” is reached.

Ibn ‘Arabi (d. 1240), the “Sultan of the Gnostics,” who revived and revised ancient knowledge much like Pythagoras (who articulated theories concerning sacred sound which we still use today) long before him, describes this desired state of unknowing in relation to the practice of the zikr in his book *Kitab wasa’il al-sa’i’l*:

“The invocator (dhakir) ought not to preoccupy himself with the significance of the dhikr (zikr) but simply with the dhikr itself. He must make it his sole support, without understanding (in a speculative sense) its meaning, and he must say to himself: ‘This is an act of worship which has been proscribed for me, and I act in conformity with that order.’ When the invocator believes this firmly, the dhikr operates according to its specific virtue and according to what its essential reality requires.” In the same work, Ibn ‘Arabi advises that,

“Giving oneself a program of regular prayers (*awrad*), promising God to set oneself certain tasks, hold to certain resolutions and so forth, are things I condemn...Regular prayers are actions that tend to perpetuate themselves through force of habit...when one does not set oneself fixed prayers but invokes God whenever one can and regardless of the time, so that one invokes Him with presence and application, then one perceives the effect of this invocation due to the concentration of spiritual energy.”

A strikingly similar situation is found in the use of sigils by the reclusive twentieth-century English painter and occultist Austin Osman Spare. In his youth, Spare was initiated into the sorcery of the Salem, Massachusetts witches by a witch named Patterson. This was a particularly potent form of magic involving the use of the sigil, the “lesser seal” according to Cornelius Agrippa in his classic *Three Books of Occult Philosophy*.

In one of Spare’s magical drawings, he sigilized the following: “I desire the strength of my tigers.” In his book

entitled *The Book Of Pleasure*, he explains that by writing all the letters in the sentence omitting repetitions, a single glyph is formed: IDESRTHNGOFMY.

In Spare’s system, the sigilized wish must be forgotten until the “magical time.” Until, “...belief becomes true and vital by striving against it in consciousness and by giving it (sigil) form. Not by the striving of faith. Belief exhausts itself by confession and non-resistance, i.e.; conscious-

ness. *Believe not to believe*, (my italics, J.E.) and in a degree you will obtain its existence. By virtue of the sigil you are able to send your desire into the subconsciousness (which contains all strength); that having happened, it is the desire’s realization by the manifestation of the knowledge or power necessary.”

All sigils are the essence of what they represent, a potentized form of a sound-concept originally

conceived in words, distilled into essential oil for the subconscious. For a sound-word-form to manifest what one desires, it is not necessary, *it is not even desirable*, for one to remember meaning, the essence behind the (word) manifestation is what we must aim for, and that goal is far beyond our “understanding”.

Again from Spare’s *The Book Of Pleasure*: “Directly we desire, we have lost all; we are what we desire, therefore we never obtain. Desire nothing, and there is nothing that you shall not realize. Believe nothing, and you will have reverted to a simplicity which childhood has not yet attained.”

This form of “forgetful remembering” conforms to what Ibn ‘Arabi proscribes in the observance of the zikr, and potentially catapults one back to one’s origin before childhood (the beginning of the end) and/or long after (death, beyond). It is a means of realizing eternity in the midst of life by sidestepping conceptualization. In this way one can creatively observe the “process,” slow it down and even stop it, reverse it or propel it forward at will. Ideas of “time” and “reality” clearly become plastic concepts to be manipulated accordingly.

***According to the Guhya-
asamaja Tantra,
“No one succeeds in attaining
perfection by employing diffi-
cult and vexing operations;
but perfection can be gained
by satisfying all of one’s de-
sires.”***

In some forms of tantric yoga, sex is seen as a vehicle for liberation, "one must rise by which one falls." Sex becomes a most potent path of return to the oneness of union with God. Jesus said when two or more of you come together in my name, I am there also. According to the Guhyasamaja Tantra, "No one succeeds in attaining perfection by employing difficult and vexing operations; but perfection can be gained by satisfying all of one's desires."

Austin Osman Spare's "magical time" involves the concentration of the human organism at the time or point of orgasm. The sigilized wish/desire is then hermetically sealed and buried at midnight, left for a period of time, unearthed and poured, according to his *Grimoire*, "As a libation into the earth with suitable incantation." In Spare's system, any word or formula may be converted into a sigil with potent -and potentially dangerous- results: such is the power of intent. "There is nothing simpler than speaking to your inmost self," says Spare, "and nothing more difficult...The Soul responds to *the* basic language only."

The word-form as symbol representing sound as outer garment for breath, making the invisible manifest, is the basic language the Soul understands because it generates the process and reintegrates the results, making the manifest invisible again. When you are wholly absorbed in prayer, you are simply talking to yourself (Self)!

The modern concept of hypnosis has several definitions, among them that of R.E. Shor in his essay, "Hypnosis and the Concept of the Generalized Reality Orientation," "Hypnosis is a complex of two fundamental processes. The first is the construction of a special, temporary orientation to a small range of preoccupations and the second is the relative fading of the generalized reality-orientation into nonfunc-

tional awareness." It should be no mystery which of these two fundamental processes relates directly to our discussion.

Marcuse in his book, *Hypnosis: Fact and Fiction*, defines his subject thus, "Hypnosis is an altered state of the organism originally and usually produced by a repetition of stimuli in which suggestion (no matter how defined) is more effective than usual." This could be a working definition of zikr, mantra, hesychast prayer, inspired chanting, music, or an otherwise ritually induced hypnogogic state.

Ronald Shone's book, *Advanced Auto-Hypnosis* points out that in hypnosis it is important to, "...suspend reality testing

and reduce the sensory input in order to activate the parasympathetic nervous system...the special orientation required for hypnosis is one where the self is submerged and the person behaves as-if. By submerging the self the reality-orientation is relinquished. When this is done, no testing against preconceived notions is undertaken. If this is successful then the only reality is that being presented to the senses." In a letter to Michel Foucault Rene Magritte

states how, "Only thought resembles. It resembles by being what it sees, hears, or knows; it becomes what the world offers it." This statement by the famous surrealist (the term means to supersede or supplant the "real") artist is very close to the Vedic "thou art that," in which whatever one perceives through the senses one then becomes.

This is a "clean-slate," the "simplicity which childhood has not yet attained" according to Spare, and in which childhood represents either an unfolding or a retrograde perspective depending upon your own perception of time (i.e.; cyclic, linear, etc.). This state in which the only reality is "that being presented to the senses," uncluttered by, or unencumbered of, the barrage of information overloading our attempts to "understand"

"There is nothing simpler than speaking to your inmost self," says Spare, "and nothing more difficult...The Soul responds to the basic language only."

The rusty mirror of our divine reflection occasionally allows just enough light through to give ourselves the illusion that we "have it all figured out." Conclusions of this type inevitably lead to either more questions, or, if we can somehow resist "pulling the wool over our own eyes," the kind of futility which leads to the very core of union, the "longing you feel is the answer you seek."

anything, is the pure state, or more specifically, station, of the adept. Information that our organism constantly processes is always full of gaps and holes; imagination often makes a snake out of a rope.

"The mind can travel a million miles in the blink of an eye."

-The Buddha

When confronted with a stable object, for example, the retinal images react by shifting twenty times a second, yet our perception of the object remains static. When we bypass the inner circuitry that informs consensual reality, we are left with utter simplicity. In this simple, quiet place, miracles constantly occur, and we are free to accept or reassess the "impossible."

John Berger says that, "The relation between what we see and what we know is never settled." If we agree that what we see is organized according to the limitation of the senses and what we therefore think we "know" depends upon this partial map of reality, then the information gathered externally presents a rather shaky foundation for gnosis. Paradoxically speaking only for the sake of, perhaps, demonstrating the limitations of language, while at the same time providing a space to "jump off:" the only road to knowing is through unknowing.

From the position of one-pointed meditation on an unknowable, inconceivable, and comfortingly mysterious origin-purpose-destination, being a convenient model which runs the risk of also being completely arbitrary, abstract, and ultimately meaningless, this type of "knowing," or gnostification may result in arrogance and/or spiritual materialism. And

Use the Dry Way, or the Wet Way, but ultimately it will turn out to be Your Way alone that leads to the philosopher's stone.

yet, if this, or any other "knowledge" appears as the result of experience, practice, or intuition, one must recognize the illusion first, and then enter wholeheartedly into *lila* (play) with the illusion as if one's life were dependant upon it. Once such gnostic realization occurs the next impulse is to attempt to unravel and become a participant in the mystery through original or traditional methods all the while considering such attempts to be unresolvable.

"There is no higher or more lasting longing than that which can never be satisfied..."

-Dr. Ernst, M.D. Baron Feuchtersleben (1806-1848)

Zur Diätetik der Seele

AN EMPTY CUP

One night a man was repeating his zikr
and as his heart expanded with love,
a doubtful voice said:

"You are calling and calling,
but have you ever received a reply?"

The man fell into forgetfulness
and a troubled slumber.

In a dream, he saw al-Khadr,
the green man, the guide of all souls
who said to him,

"Why did you abandon your zikr?"
"Because God doesn't answer back"

replied the man.

"This longing you feel is
the answer you seek" said al-Khadr.

Your sadness is an empty cup
drawing you to union.

Hear the dog cry for its master.

The crying is the connection.

There are love-dogs no one has names for,
give yourself up to become one of them.

-Jalalu'ddin Rumi (trans. by Coleman Barks,
this version by J.E.)

The rusty mirror of our divine reflection occasionally allows just enough light through to give ourselves the illusion that we "have it all figured out." Conclusions of this type inevitably lead to either more questions, or, if we can somehow resist "pulling the wool over our own eyes," the kind of futility which leads to

the very core of union, the "longing you feel is the answer you seek." Sojourners on a spiritual path most often go one way or the other: toward their own "conclusions;" or in some kind of alignment with a tradition which seems most compatible with their "conclusions." Of course, most traditions we know of began with an individual's "conclusions" which somehow crystallized into dogma, (usually) after their death and certainly not what they originally had in mind! This is the danger of attempting to articulate the "unspeakable visions" of the individual. There is something intrinsic in human nature that makes us evangelical about our own "enlightenment" experiences, our own unique witness, when it arrives. It is natural to want to share good news. But if it were possible to ade-

quately convey meaning through words, or even actions, how can we be confident that what we have experienced, this grace from God which is perfectly placed in space and time for us after a period of life-time made up of our own unique trials and errors and breakthroughs and successes and failures, is applicable to the unique sum of the experiences which makes up the world of people around us? Do you, or does anyone possess a formula which works every time, for everyone?

While working with a group can be a powerful and positive experience, it is best to remember that each member of the group has their own unique relationship with God. We each possess our own male-female polarity which mirrors the androgynous nature of the Divine. Expressing your ideas and/or ritualizing your own breakthrough experiences can allow everyone involved to experiment and apply your methods to their own situation. This has its drawbacks, some of which have already been discussed, and we should also try to keep in mind factors such as those group members who will say or do anything "just to please." But let's be honest, we all seek some level of approval from others. It may even be the need for approval which motivates the individual to share their breakthrough experience. However, the positive potential for individual growth within a group is also present, in certain "variations on a theme," for example, and should not be discounted. Even when we account for individual interpretation of events in this context, anyone who has participated in a successful group ritual can attest to the potential power of this experience. Life is a multileveled synthesis of the myriad choices that we are ever presently faced with, including how we react to other's opinions and advice.

It would seem that if a creative God is indeed infinite, then all the infinite creation possibilities will be explored. All expressions, experiences, forms, and combinations must be made manifest, and logically this is a process which will never stop, world without end. The circumstances of

your life, of any life, of all life, including the interaction of all of the elements, are vital connecting points, links, puzzle pieces, overlapping, inter-sequential, multileveled manifestations of pure God-consciousness expressing and manifesting itself. This is no super-imposed moral code, only the curious need for self-expression.

Philip K. Dick spent the last eight years of his life attempting to understand and express in words through his "exegetis" an initiatory experience he underwent in 1974. This process came to a head when he was confronted by the infinity of possibilities "behind" his life-changing ordeal. In a memorable entry from Dick's journal, God speaks:

"So do not try to know; you cannot know...Each theory gives rise to a subsequent theory, inevitably. Let me ask you; I revealed myself to you and you saw that I am the infinite void. I am not in the world, as you thought; I am transcendent, the deity of the Jews and Christians. What you see of me in the world that you took to ratify pantheism—that is my being filtered through, broken up, fragmented and vitiated by the multiplicity of the flux world; it is my essence, yes, but only a bit of it...Do you accept that where the infinite is, I am; and where I am, there is the infinite?" I (Philip K. Dick) said, "Yes."

As long as you trace your path to the utter simplicity of what underlies our vision of reality, it doesn't seem to matter much how you travel. You're there already! It's simply a matter of remembering that the center is infinitely everywhere, in everything. The getting there (remembering your Self) and not the going is what seems to matter.

There are as many paths to (and from) God as there are hypothetical subatomic particles, or salt attracting energizing niter, in the universe. Matter is constantly being recycled. However you dress or undress your own creative ritual presence/witness, somehow it all comes from and goes back to the invisible expression, the breath of the Merciful. It is up to each creature to express a unique pathway into the Whole. As long as you trace your path to the utter simplicity of what underlies our vision of reality, it doesn't seem to matter much how you travel. You're there already! It's simply a matter of remembering that the center is infinitely everywhere, in everything. The getting there (remembering your Self) and not the going is what

seems to matter. Use the Dry Way, or the Wet Way, but ultimately it will turn out to be Your Way alone that leads to the philosopher's stone. Like the fairy-tale child who drops bread crumbs behind him so he won't lose his way as he walks into the forest, we all wish for a safe and reasonable way home. Watch out! There's a bird eating up your crumbs!

BIBLIOGRAPHY

Addas, Claude. Quest For The Red Sulphur: The Life Of Ibn 'Arabi. Cambridge, Islamic Texts Society, 1993.

Agrippa, Henry Cornelius. Three Books Of Occult Philosophy. Donald Tyson, ed. St. Paul, Llewellyn Publications, 1995.

Berger, John. Ways Of Seeing. Harmondsworth, Penguin Books Limited, 1972.

Boehme, Jacob. The Aurora, That Is, The Day-Spring. John Sparrow, trans. Edmonds, Sure Fire Press, 1992.

Dass, Ram. Miracle Of Love: Stories About Neem Karoli Baba. New York, E.P. Dutton, 1979.

Dick, Philip K. In Pursuit Of Valis: Selections From The Exegesis. Lawrence Sutin, ed. Novato, Underwood-Miller, 1991.

Eberly, John. al-Kimia: The Mystical Islamic Essence Of The Sacred Art Of Alchemy. Hutchinson, Anamnesis, 1995.

Foucault, Michel. This Is Not A Pipe. Berkeley, University of California Press, 1982.

Grant, Kenneth. Images & Oracles Of Austin Osman Spare. New York, Samuel Weiser Inc., 1975.

Guthrie, Kenneth Sylvan. The Pythagorean Sourcebook And Library. Grand Rapids, Phanes, 1987.

Hess, Linda. The Bijak Of Kabir. San Francisco, North Point Press, 1983.

Jaynes, Julian. The Origin Of Consciousness In The Breakdown Of The Bicameral Mind. Boston, Houghton Mifflin Company, 1982.

Mookerjee, Ajit. The Tantric Way: Art, Science, Ritual. New York, Thames & Hudson, Inc., 1989.

Nurbakhsh, Javad. Sufi Symbolism, Vol. VIII. London, Khaniqahi Nimatullahi, 1994.

Pourjavady, Nasrollah, and Wilson, Peter Lamborn. The Kings Of Love: The Poetry And History Of The Nimatullahi Sufi Order. Tehran, Imperial Iranian Academy of Philosophy, 1978.

Rumi, Jalalu'ddin. The Mathnawi Of Jalalu'ddin Rumi, Vols. 1-6. Reynold A. Nicholson, trans. E.J.W. Gibb Memorial Series. Warminster, Aris & Phillips, Ltd, 1926.

Shone, Ronald. Advanced Auto-Hypnosis. Wellingborough, Thorsons Publishing Group, 1985.

Alchemical Gardening

By Rick Grimes
Part Three



In the last issue garden building and maintenance occupied our interest. For those of you who have been consuming your home garden products I hope you've had a good harvest. The STONE has received several responses to our Alchemical Garden articles which we will include in this issue. It is said that the "oldest" profession is prostitution, yet it is arguable that man's oldest occupation has been food procurement. Gardening, it follows, is the logical progression of this most probable occupation and therefore may possess man's most vast experience, and knowledge, much of which has been cyclically discarded as man's ingenuity lead him ever onward.

From our readers:

Joe Caezza writes:

"Congratulations on yet another fine issue of The STONE. You might be interested to know that I have 6 tomato plants. Each is surrounded by between 8 to 12 specimens of sweet basil ...understood as a rich source of vegetable mercury in INDIA... while the tomato who's yellow flower and red fruit bear the solar (solenacea) signature of ALCHEMICAL SULFUR."

From Steve Kalec: (This letter was an e-mail letter addressed to Russ House in response to Russ' posting of the following paragraph on the Alchemical Forum:

"Melissa typically flowers from May until August. In Joseph E. Meyer's 'The Herbalist' it is recommended to harvest before the plant flowers for medicinal use. I think that you should be able to harvest from the plants 2 or even 3 times in a season. There are some other considerations in harvest. If you are making an elixir and want to "load" it with the fire element, flowers and seeds should make up some significant proportion of the herb. For loading with other elements, try Air (Leaves), Water (stems and stalks), Earth (roots)"

- Russ House

“Hello Russ: -- Thank you very much for your kind response. This is exactly the kind of information I was looking for. This helps me allot.

“I imagine that working with freshly picked plants is more desirable than working with dry plants. I do understand that the secret of alchemy in spagyrics involves the interaction of ones inner consciousness through correspondences with what is happening to the plant through the steps of the various stages and processes. My alchemy practice up till now has been strictly of the inner practice however I have stumbled on to the secrets contained in practical laboratory work.

My Melissa plants are becoming very beautiful, they are thick and very green and healthy looking. Since I am very new to the art of spagyrics and some of the greater principles I will not be able to apply till winter because I do not want to skip and rush through the lessons I have had the fortune of receiving. If I harvest some of my Melissa now and from its fresh state, separate the three essentials and hermetically preserve them for my winter experiments, would this be all right ?

“I know that there are certain formulas to the processes such as for the example in calcining it takes time and involvement to achieve the red stage. But if I calcine the salt to its blackness and conserve it along with the mercury and sulfur for later continuity in the work, would I be diminishing [extracting quality? - ed.] from the correspondence and the inner sympathetic resonances? What I am really looking for is confirmation that this is all right and also information on what do other alchemist do concerning working with optimum Essence quality for winter seasons.

“I hope that my question has been presented in an understandable manner. In some respects this might sound like an ignorant question but like I said I am very new to spagyrics and I value very much the opinions, hints, and tips of those who know and have experience.

----- Best Regards, Steve Kalec”

RG: This Alchemical Gardening section is an interactive forum in The STONE, so if anyone would like to respond to Steve's, or anyone's questions, or if you have questions of your own, please refer to issue number and date, page numbe. -- Thank you.

The following article submitted by Jack Glass will interest those of you who have used or have an interest in using *Radionics* to enhance your garden's production.

A note about Radionics: For those unfamiliar with the term, Radionics is basically predicated upon the assumption that all energy is one energy having infinite expressions. From the most rarified to the most dense examples, energy manifests in cycles, or pulses, or . . . “words.” In DNA the personal coding of an individual speaks to its whole body in binary “word” complexes. This is also the stuff of mind of which we, our real Self, is composed.

Radionics – a branch of Radiesthesia –utilizes electronic apparatus in conjunction with highly sensitive human mental and kinesthetic skills to attune to the life frequencies and thus effect healing, or in the case of a garden, good soil and plant health. Radionics is about manipulating etheric energy between a sending “witness” (sample) and a separate focal point or receiving “witness”. I.e.; a bit of medicine as a sending “witness” on one contact plate and the receiver, such as a drop of blood containing the patient's essence and total DNA imprint on the other contact plate.

With skillful manipulation of the radionics machine's dials the medicine is tuned to the blood, which in turn is attuned to the patient, who will then benefit as the essence of the medicine is blended with all the blood of the patient. This same principle will work with plants. A photograph of a garden plot can be a recipient witness for fertilizer, insect repellent, or water, as it holds the specific light emissions from the soil and each plant in the picture and will sympathetically link them together -- RG.

Radionics In The Garden

Written by Jack Glass:

Alchemy in the garden, as used in daily living, whether it be for leisure or for the one rushed for time, cuts down on weeding and watering since not a lot is required. The following garden plot applies basic alchemical and radionics principles.

Prepare a square garden plot. Optimum size ranges from 6' by 6' to 15' by 15'. Using outdoor timber, such as railroad ties, tie them together with wood or metal plates. Fill the center with good soil. Cover with black plastic,

4ml thick. Fasten the plastic to the top of the ties with staples or nail a thin narrow strip over to hold down the plastic sheeting on top of your ties. Staple a continuous copper wire around the circumference with no breaks. Plant marigolds in each corner. Put up as many fences as required for climbing plants. The wire mesh used to reinforce concrete works well. Hold in place with 1/2" electrical conduit.

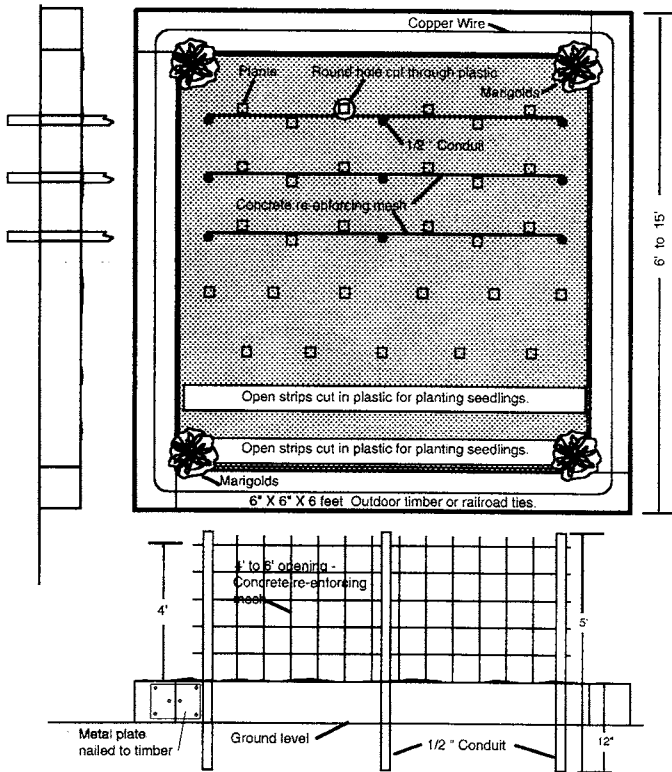

Explanation:

1. The railroad ties hold the soil and allow good drainage.
2. The black plastic holds moisture and heat while stopping weeds.
3. The fencing supports climbing plants and keeps fruit off the ground.
4. The marigolds drive bugs away.
5. The continuous copper wire builds an energy force which stimulates growth.
6. Radionics is also an asset to your garden.

Once you have finished planting, set up a step ladder and take a Spectra® Polaroid picture of the garden from the ladder. You will then have a positive as well as a negative of the garden. Using both positive and negative, you will treat the whole. You may put this picture on your machine.

Dial in the vibration you wish to impart to the plants, whether it be horse or cow manure, rainwater, etc. This will stimulate growth and make your next gardening experience successful.

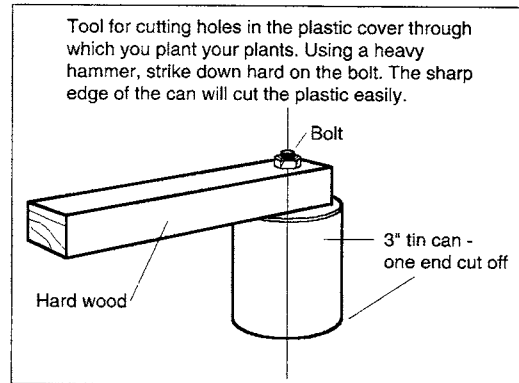

HOLE CUTTER

RG. If you have questions for Jack's Radionic alchemical garden address them to me here at The STONE and I'll refer them to Jack for answers.

Cross Pollination:

Another PON member has expressed concern about the cross pollination that could occur from the plants of a neighbor. In the case of tomatoes for example, could the pollen from different tomato strains in one's neighborhood cancel out the beneficial effects of the alchemical practice of gardening by diminishing pure strain quality, and causing stunted or deformed growth? This is a good question, especially for those living in a densely populated area.

Although I haven't looked into this extensively, I have found a few answers. A densely populated area will provide more of a disease threat than a threat through cross pollination. Also understand that even a tomato plant that is pollinated by another tomato plant, though not of its strain, will most likely produce fruit - either better, worse, or the same quality. Assuming the plant is healthy you would still follow the axiom; *select the best for seed and eat the rest* -- and you still have an evolving garden..

If you are really into this to such a degree that you want a pure strain even though you live in densely populated suburban areas, you can *tent* your plants when they pollinate. Thin clear plastic sheeting is placed over a frame that will temporarily cover your plants yet allow

sunlight in during their pollination cycle. This is more than most people would want to do, however it will nearly eliminate cross pollination problems.

Thank you for the contributions submitted and let's keep the questions, answers, and comments coming.

Bon veggies!

BIBLIOGRAPHY

1. CHAKRAS- RAYS AND RADIONICS, by David V. Tansley D.C. 1984 ISBN 0 85207 161 2
2. DEMENSIONS OF RADIONICS - New techniques of instrumented distant-healing, by David V. Tansley D.C.1985 ISBN 0 85032156 5
3. THE COMPLETE BOOK OF PLANT PROPAGATION - Graham Clark & Alan Toogood ISBN O-7063-7079-1



Announcements



 **Remember to
Renew
Your
Membership
to
P.O.N.**

RESOURCES:

References for laboratory equipment, supplies, and materials to support the efforts of researchers. Please inform us of new suppliers, and let us know if supplier addresses and phone numbers change. We do not list suppliers of medicines for internal use, for practical reasons.

Alchemical Resources
Al-Kemi - Alchemical & Spagyric Products 3107 W. Colorado Ave. #277 Colorado Springs, CO 80904 Tel: 1(719) 685-5476 Fx: (719) 685-5451 (Noon -- 10 PM MST) E-Mail: alchemi@pcisys.net <i>Glassware for alchemical work.</i>
American Science and Surplus 3605 W. Howard St., Skokie, IL 60077 USA Tel; 1 (847) 982-0874 Fax: 1 (800) 934.0722 http://www.sciplus.com/ <i>Request catalog (available in USA and territories only). Science & hobby kits, motors, electrical components, educational and office supplies, novelties and toys.</i>
Bryant Laboratory, Inc. 1101 Fifth St., Berkeley, CA 94710 USA Tel: 1(510) 526-3141 or 1(800) 367-3141 Fax: 1(510)528-2948 <i>Mail-order labware and chemicals.</i>
Centaur Forge, Ltd. 117 North Spring St., PO Box 340, Burlington, WI 53105-0340 USA Tel: 1 (414) 763-9175. Fax: 1(414) 763-8350 <i>Temperature crayons, forges, blacksmiths' supplies, such as tongs, aprons, etc.</i>
David Shannon 6649 E. Rustic Drive, Mesa, AZ 85215 USA Tel/Fax: 1 (602) 985-0557 <i>Minerals by the specimen or in bulk.</i>
Dr. Michael's Herbs 5109 N. Western Ave., Chicago, IL 60625 USA Tel: 1 (773) 271-7738
<i>Herbs.</i>
Hagenow Laboratories 1302 Washington St., Manitowoc, WI 54220 USA Tel: 1 (414) 683-3339 <i>Bargain priced labware and supplies by mail-order.</i>
TRIAD 125 West Front Street, Suite 275, Wheaton, IL 60187 USA Email: majrcana@aol.com <i>Request price listing.</i>

Stibnite, Alchemical books, Marseilles Tarot Deck, high purity essential oils, hard-to-find items.

Books

Banton Press

Mark Gordon Brown

Dippin Cottage

Isle of Arran, KA27 8SB, UK

Handmade, perfect bound paperbacks of facsimile reprints; 20 alchemical titles, plus other topics.

Chthonios Books

7 Tamarisk Steps

Hastings, TN34 3DN, England

Tel/fax 01424 433302

(+44 1424 433302 internationally)

Scholarly titles from publishers worldwide which deal with Esoteric Studies, and second-hand books.

J.D. Holmes

PO Box 623

Edmonds, WA 98020 USA

Fax/Phone 1.206.771.2701

Series of inexpensive reprints of alchemical works.

Kessinger Publishing

P.O. Box 160, Kila, MT 59920 USA

Tel: 1 (406) 756-0167

Fax: 1 (406) 257-5051

Email: books@kessingerpub.com

<http://www.kessingerpub.com>

Over 1000 titles on Hermetic and Masonic topics

Phanes Press

P.O. Box 6114

Grand Rapids, MI 49516 USA

<http://www.phanes.com>

Publishes & distributes books which relate to the spiritual and philosophical traditions of the West.

R.A.M.S.

Hans Nintzel

733 Melrose Drive,

Richardson, TX 75080 USA

Photocopies of translations of alchemical texts.

Todd Pratum Book Company

P.O. Box 985

Healdsburg, CA 95448 USA

Tel: 1 (707) 431-2634 Fax: 1 (707) 431-0575

Specialist in Philosophy, History of Religions, Mythology, and Metaphysics. Old, New & Rare.

Entrainment Technologies

Tools for Exploration

47 Paul Drive, San Rafael, CA 94903-2118 USA

<http://www.tools4explore.com>

Light/sound machines and consciousness tools

Newsletters

Caduceus: The Hermetic Quarterly

Cinnabar,

P.O. Box 95674, Seattle, WA 98145 USA.

A quarterly journal of the Hermetic tradition. Subscription prices are \$18 US per year within North America and \$25 US per year overseas; checks should be made payable to Cinnabar.

Cauda Pavonis: Studies in Hermeticism

Stanton J. Linden, Editor,

Cauda Pavonis, Dept. of English,

Washington State University,

Pullman, Washington 99164-5020 USA.

Published twice each year, in the spring and fall. Now in its fifteenth year, it publishes scholarly material on all aspects of alchemy and Hermeticism and their influence on literature, philosophy, art, religion, and the history of science and medicine. Annual subscription cost is \$10.00 for individuals, \$12.00 for libraries and foreign subscribers. Checks should be made payable to Cauda Pavonis; foreign subscribers should pay by checks drawn on banks with American branches.

Ambix, The Journal of the Society for the History of Alchemy and Chemistry

Scholarly articles and reviews of books on all aspects of the history of alchemy and chemistry, published in March, July and November. The annual subscription to the Society costs £20.00 (\$32). This should be sent to Dr. N.G. Coley, 24 Kayemoor Road, Sutton, Surrey, SM2 5HT, UK. Members receive the current volume (3 parts) without further payment. Most back issues are available at £15.00. For non-members, libraries and institutions, the annual subscription to Ambix is £38, and most back issues are available at £24. Orders for non-members should be sent to Black Bear Press Ltd., King's Hedges Road, Cambridge CB4 2PQ, UK.

Internet

The Philosophers of Nature

<http://www.mcs.net/~alchemy>

We maintain an **updated resource list** on our site.

The Alchemy Virtual Library

<http://www.levity.com/alchemy/>

Over 28 megabytes of information on alchemy in all its facets organized by Adam McLean.

THE STONE

THE JOURNAL OF THE PHILOSOPHERS OF NATURE

© 1997, THE PHILOSOPHERS OF NATURE. ALL RIGHTS RESERVED.

ISSUE NUMBER 23

NOVEMBER-DECEMBER 1997

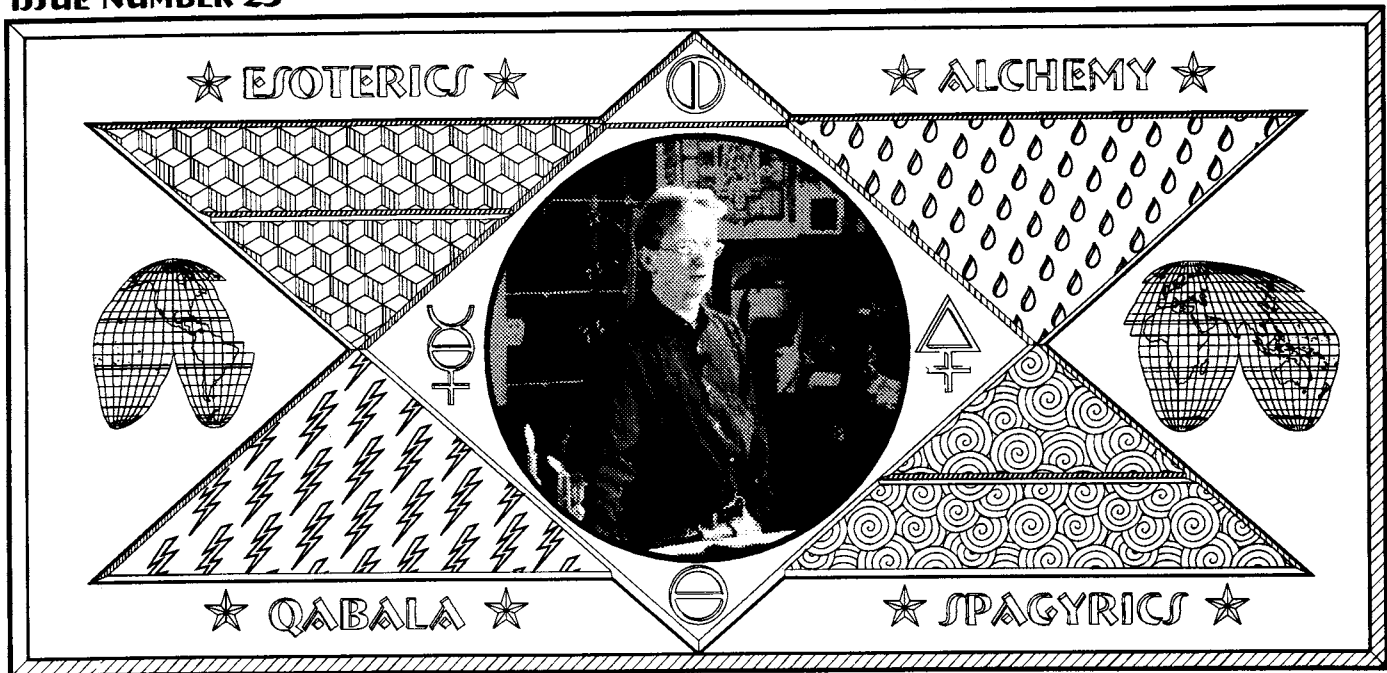

IN THIS ISSUE

Article or Feature	Author	Page
♀ A Message from the President	Russell House	2
♀ The Saint Scientist: George Washington Carver	Russell House	3
♀ Video Tape - Update	Rick Grimes	8
♀ Yantras and Alchemy (Part Four)	Joseph Caezza	9
♀ ORA ET LABORA (Report on Prague, and The ACETATES Seminar)	Joseph Caezza	12
♀ <i>Special Announcement</i> : PON Lessons in Book Form	P.O.N.	15
♀ Follow Up to the Lucid Dreaming Project (ORA project - issue #21)	Mark Stavish, M.A.	15
♀ PORTÆ LUCIS Method of Jean Dubuis	Mark Stavish, M.A.	22
♀ RESOURCES	The STONE	26
Cover Photo: Russell House - "The Way of the Acetates" Seminar	Seminar Photo	Cover

Editor-in-Chief: Rick Grimes; Production: Le Philosophe Inconnu

Published six times per year by The Philosophers of Nature

Price: \$5.00 US

THE PHILOSOPHERS OF NATURE

125 West Front Street, Suite 263, Wheaton, IL 60187 USA

Tel: 630.682.3938 Fax: 630.665.2364

Email: alchemy@mcs.com Internet: <http://www.mcs.net/~alchemy/>

A Message from the President

by Russ House



I have reflected on my past 12 months in office. I think that it is appropriate to share some of the personal aspects of this time, as well as to speak about what is on the horizon.

Presently, I am working in a room piled high with boxes that I have been sorting through for the past few weeks. After a number of years of study and observation, I came to view the birth date of a person (or thing) as the starting point of an annual cycle. The most useful text that I have found in that study has been "Self Mastery and Fate, and the Cycles of Life", by H. Spencer Lewis.

While each period in the year has specific characteristics, the period just before the birthday is a cycle of 'deconstruction', and the period beginning at the anniversary of the birthday is a cycle of 'renewal'. I spent the day before my birthday and the day of my birthday making changes to the PON office. Sue and I have shared an office for several years, and it had become overcrowded in the past year. I removed my desk, computer equipment, and personal files from the PON office, and after 'deconstructing' yet another bedroom I have set up a new office. My new office occupies the 'library' that formerly did double duty as a guest bedroom. Consequently, I have a few weeks of 'renewal' ahead of me before the job is complete. I foresee the new office allowing me to work more readily on research projects, without interfering with the normal day-to-day business of the PON.

Sue has rearranged the PON office and now has an efficient arrangement that will allow her to work more easily. We are now looking at ways to redesign some of our business processes to make them more timely and effective for our members. We have had a lapse in service over the past few months that was complicated by the office arrangements, but most of it was related to Sue's job. Her work in home nursing had grown into a 7-day-per-week job, with unpredictable hours. The travel and continual stress of the work had left her fatigued, and forced her to tackle the PON work after midnight.

It seemed that something would always arise to hold up completion of the orders. Often it was that a certain handout for a video would be out of stock and the master not easily found, or a critical office supply would be out of stock with no way to replenish it at 2:00 AM.

SPECIAL **ANNOUNCEMENT!**

PON Lessons
now available
as booklets!

***All of our lessons are now
produced on 20 lb. paper,
and tape bound with covers.
We think that the new format
will please our members.***

And...

***The price reduction will remain
in effect until July 1998.***

***Improved quality...
... at a more affordable price.***

Sue has changed jobs, and now can more easily manage her multiple roles as PON office administrator, nurse, student, housekeeper and grandmother. We have also decided to 'farm out' certain jobs, including printing and mailing of the newsletters, and the printing and binding of lessons. At present, we sell bound copies of all English-language lessons.

My ongoing challenge has been to find a way to allow others to focus on the day to day administrative work. This has been positive, though not without some challenges. An example would be the several hundred emails that still await adequate answers, whether for technical assistance, courses, or other information. These are now being filtered and passed to the persons who should respond to them. We are considering other changes to correct this and similar problems. These are symptoms of growth, and they require us to address them creatively.

These growing pains have often distracted me from focusing on the long-term future of the association. Fortunately, the Board of Directors as a whole remains focused on the big picture. Through continuous email and our periodic meetings, we carry on challenging discussions about the real values and objectives of the association. One outcome of these email dialogues was the recent practical workshop on metallic acetates in September. Joseph Caezza has written a fine article about that event, which appears in this issue. The Board will call for an increase in practical events, since these provide lasting benefits to our members.

In addition, I am continuing to focus on international expansion. I have drafted an agreement that outlines the expectations and obligations for associations in other countries. I recently provided this to parties in two European countries, and I am awaiting the responses to see what will be possible in the future.

It appears that the time we spent in preparing for the filming for the "Ancient Mysteries" television program has been a good investment. It appears that portions of those interviews that were not previously aired have surfaced in a program on the History Channel. This segment on the history of Alchemy (which we have not seen) has attracted prospective members to us.

I hope that the next 12 months will be even more beneficial to our members, as more of the seeds that we are planting come to fruition.

Ora et Labora!

⊕

The Saint Scientist: George Washington Carver

By Russell House

As a young boy growing up in Kentucky, I wanted to be a scientist. The space exploration era had just begun, with the launch of the Sputnik. I had chemistry sets, microscopes and a telescope, as well as access to good libraries, and the encouragement of my family. At the same time, I was grappling for the means to integrate religious and humanitarian values with my scientific interest. Before age 10, I had come to admire several historical figures for the clues that their lives might offer in this search. Among these were Isaac Newton, Albert Schweitzer, and George Washington Carver. This search has profoundly shaped my life; it is this which lead me to investigate Alchemy and the Hermetic traditions.

In middle age, as in youth, I continue my search to integrate those aspects of self that express themselves as religious and scientific thought. Again, I find myself drawn to the lessons that can be learned from the example of George Washington Carver, the "Saint Scientist".

Born into slavery, orphaned, and bought for the price of a horse, Carver struggled to overcome the handicaps of poor health and poverty. His perseverance saw him through college and graduate studies to become an world-renown scientist. A man of great faith, Carver was known as "the Saint Scientist" or "The Poor People's Scientist." He attributed to divine revelation his discovery of the hundreds of uses of the peanut and everything else he had learned through nature. He asked nothing for himself, but gave his discoveries to humankind. Refusing to apply for patents for his work, he said, "The Lord charges me nothing for knowledge, and I will charge you the same." This great soul had a profound passion for nature, understood the importance of service to human welfare, disre-

garded conventional pleasures, and exhibited no interest in financial reward.

George Washington Carver was born into slavery. Slaves were not allowed to have last names, so George took the last name of his former owners, Moses and Susan Carver, when slavery was abolished. The Carvers were successful and well-respected farmers, whose farm was located outside Diamond, Missouri. The date of his birth is uncertain, as birth records were not kept on slaves. While it has been reported as early as 1860, Carver believed it to be around the spring of 1864.

George lived on the Carver farm with his mother, Mary, and his brother, James. While the identity of George's father was unknown, Carver believed him to be a slave on a neighboring farm. Weeks after his birth, George and his mother were caught up in the devastation of the Civil War. Kidnapped by a Confederate raiding party, they were taken to Arkansas, where George was given away. His mother was sold farther south, never to be heard from again.

Moses Carver contacted a neighbor, John Bentley, and asked him to track down the kidnappers. He offered Mr. Bentley his fastest horse, Pacer. Bentley returned a very sick baby George to the Carvers. Moses and Susan Carver raised Mary's two sons as their own. Carver often recalled in later years the love and guidance they showed him. Still, he missed his mother and was often found standing beside his mother's spinning wheel.

George had contracted whooping cough during the kidnapping, and was close to death. The Carvers cared for the baby and nursed him back to health, but George remained small and weak for much of his childhood, handicapped by a stutter. He recalled his early years as "a constant battle between life and death."

His illness left him unable to perform the usual farm chores, so he was taught to cook and tend to the garden. He spent "day after day ... in the woods alone in order to collect my floral beauties and put them in my little garden I had hidden in brush." The flowers thrived under his care, and the neighbors began to ask George's advice about their plants. This earned him the nickname "the Plant Doctor". When a homemaker brought an ailing houseplant and asked for the boy's help to make it bloom, George would take them to a secret greenhouse he had made from

discards. Here, he made blends of soil for them, covered them tenderly at night, and took them out to play in the sun. Often, he sang to his plants. Asked about his miraculous results, he replied, "All flowers talk to me and so do hundreds of little living things in the woods. I learn what I know by watching and loving everything."

George would leave the farm in search of an education, but he took with him the perceptions of a naturalist and the inquiring spirit of a scientist: "My work, my life, must be in the spirit of a little child seeking only to know the truth and follow it."

The Carvers tried to enroll George in the local church school in Diamond Grove, but black children were not admitted. In 1877, George traveled to nearby Neosho, Missouri, to attend a school for black children. Andrew and Mariah Watkins, a black couple, took him in, and allowed him to pay for his room and board by doing chores. After a year, George moved on. Carver played music, sang, began painting, and took solitary walks to explore the countryside. By 1885, he had saved enough money to apply to Highland College in Kansas. Accepted by the college, he arrived only to be turned away because of his color.

Between 1888 and 1890, Carver traveled to the little town of Winterset, Iowa. He set up a laundry business, went to church, and got to know the townspeople. He was encouraged to apply to Simpson College at Indianola, Iowa. At age 30, Carver was accepted as a freshman, the first black student to attend the college. Here, he studied art and piano. Art teacher Etta Budd noticed that the promising artist always drew plants, and she encouraged him to study botany. In 1891, at her prompting, he transferred to Iowa State College of Agriculture at Ames, a leading agriculture research school. He earned his Bachelor's degree in 1894 and a Master's in bacterial botany and agriculture in 1897.

At Iowa State, George took the six-year old grandson of a favorite instructor on long walks in the woods, to talk with the plants and the fairies. This young boy later served as the U.S. Secretary of Agriculture, and, later, Vice President. Carver became the first black member of the faculty, teaching classes about soil conservation and synthesis of products from agricultural produce. Although Carver was happy at Iowa State, he felt that God's plan called for him to help his people.

In 1896, he accepted an offer from Booker T. Washington to work at the Tuskegee Institute of Technology in Alabama. Washington, the founder of the school, thought that the best way for black Americans to overcome racial prejudice was to learn the practical skills that would enable them to become productive members of society. For the first time, Carver would be living around other black people. Carver served as the director of agriculture for the school, remaining on the faculty until his death in 1943.

Carver shunned job offers from industry, which would have made him wealthy. He refused Thomas Edison's offer of \$50,000 a year for five years, (an offer worth several million in today's money), instead starting his laboratory with bottles, fruit jars and other discards from the trash pile at the Tuskegee Institute. Carver never allowed a book to be brought into the laboratory, which he christened "God's Little Workshop". Here, he communed with plants for hours at a time. By habit, he arose at four o'clock each morning to walk in the woods before starting his working day. Carver said, "Nature is the greatest teacher and I learn from her best when others are asleep. In the still, dark hours before sunrise, God tells me of the plans I am to fulfill."

Here at Tuskegee, Carver embarked on his life's mission. This simple man, who viewed himself as "God's servant", devoted his efforts to helping an impoverished people. The result was a revolution in agriculture.

The American economy was highly dependent on agriculture. Years of Civil War had devastated the South. The practices of growing only cotton and tobacco season after season had depleted the soil of the region. In addition, the abolition of slavery had served a blow to the once vital plantations. Each year the yield of cotton was less.

George believed that everything in the natural world was part of a great whole, that human beings must work in partnership with nature. He also believed that "man is simply nature's agent or employee to assist her in her work." Carver told his students, "Young people, I want to beg of you always keep your eyes open to what Mother Nature has to teach you. By so doing you will learn many valuable things every day of your life."

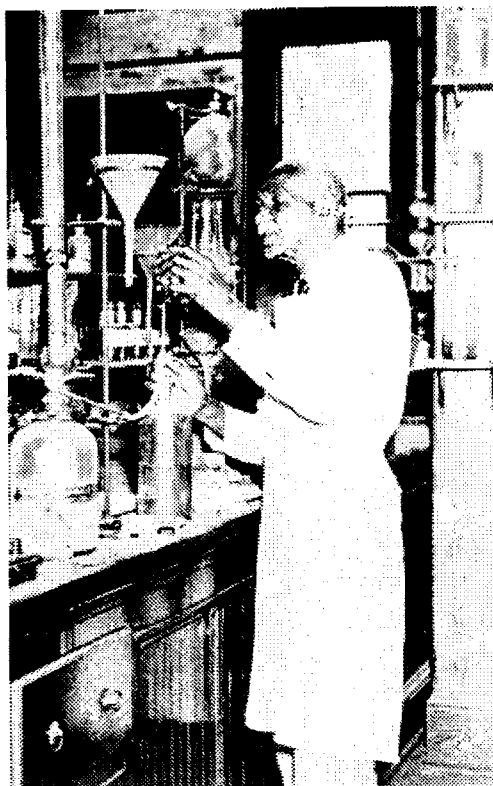

George Washington Carver

Carver resolved to revitalize the soil, the economy and the people. He began to experiment with three ways to improve the exhausted soil: using organic fertilizers to enrich the soil, planting crops that return nutrients to the soil, and rotating crops to prevent the soil from becoming worn out. Together, these methods would revolutionize southern agriculture. Carver taught farmers to revitalize the soil through two methods of fertilizing: one was growing velvet beans, cowpeas and grass to be plowed under in the fall as a green fertilizer; in the spring farmers grew and plowed under wheat, oat, and rye. Soil depleting cotton crops were alternated with soil enriching crops, such as peanuts, peas, soy beans, sweet potato and pecans. Soon farmers had an abundance of peanuts and cotton, as well as much-needed money.

The farmers soon ran into another problem. There was not enough demand on the market for the peanuts and sweet potatoes that enriched the soil. From "God's Little Workshop", the solutions came forth. While many may know that Carver invented peanut butter, few know that in all, he invented 325 products from peanuts, 108 applications for sweet potatoes, and 75 products derived from pecans. During World War II he worked to replace the textile dyes formerly imported from Europe, and in all he produced dyes of 500 different shades, from 28 different plants.

George Washington Carver transformed the South from a slave to "King Cotton" to a rich and varied farmland, while giving the farmers hundreds of profitable uses for their new crops. The peanut, once considered an insignifi-

cant crop, was transformed into a multi-billion dollar industry. Beverages, pickles, sauces, meal, bleach, wood filler, washing powder, metal polish, paper, ink, plastics, shaving cream, rubbing oil, linoleum, shampoo, axle grease and synthetic rubber were all derived from the legume once disparagingly called "monkey food". By 1930, the peanut was creating \$250,000,000 in wealth each year. Peanut oil alone was a \$60,000,000 business.

From soybeans, Carver developed flour, meal, coffee, breakfast food, oil, and milk. In 1927 Carver patented three processes for producing paints and stains from soybeans. These were the only patents ever issued to Carver. Carver then directed his attention to various waste materials, and developed paints and stains from clay and used oil. He created valuable products such as marble, wallboards, and road cover from the millions of tons of cellulose and lignin that were discarded annually. He preached, "Find new uses for this waste and thus enlarge the usefulness of the product for mankind."

Synthetic products developed by Dr. Carver included adhesives, axle grease, bleach, buttermilk, cheese, chili sauce, cream, creosote, dyes, flour, fuel briquettes, ink, instant coffee, insulating board, linoleum, mayonnaise, meal, meat tenderizer, metal polish, milk flakes, mucilage, paper, rubbing oils, salve, shoe polish, soil conditioner, shampoo, shaving cream, sugar, synthetic marble, synthetic rubber, talcum powder, vanishing cream, wood stains, wood filler, and Worcestershire sauce.

Amidst war and poverty, he found people in need of many things without the means of acquiring them. He stated: "At no period in our history is it more important that every acre, yea, every foot of land be made to produce its highest possible yield. It is equally important that everything possible be saved for our consumption. The shortage of tin cans, glass containers, the high price of sugar as well as the containers, make it emphatic that we have some other method within the reach of the humblest citizen."

For his tremendous contributions to humanity, Carver won the friendship of Presidents Theodore Roosevelt, William McKinley, and Calvin Coolidge, and of industrialists like Henry Ford. Ford considered Carver "the greatest scientist living". Nevertheless, George Washington Carver was always a simple man who always had time for any dirt farmer who knocked on his door for help.

A brilliant and inventive scientist, George became very famous and was asked to speak all over the United States. During the depression, he was invited to his nation's capitol to speak in behalf of a tariff for the peanut industry. Arriving at Union Station dressed in his well-worn two-dollar black suit and homemade neck tie, he asked a porter to help him with his bags and to direct him to Congress. The porter exclaimed, "Sorry, Pop, I ain't got time for you now, I'm expecting an important colored scientist coming from Alabama". Carver carried his own bags to a taxi, and went to Capitol Hill. During his testimony, Carver persuaded Congress to approve the tariff, pulling product after product from his bags. His appearance drew the attention of the world.

Carver was elected to the Agricultural Hall of Fame, and was the second African American enshrined in the Hall of Fame for Great Americans. Other awards and recognition included:

- 1916: became the only African-American member of Great Britain's prestigious scientific society, the Royal Society for the Arts;
- 1916: asked to join the advisory board of the National Agricultural Society;
- 1918: appointed as a consultant to the U.S. Department of Agriculture;
- 1920's: began to work closely with the Commission for Interracial Cooperation and the Young Men's Christian Association (YMCA);
- 1923: awarded the Spingarn Medal by the National Association for the Advancement of Colored People, for Distinguished Service to Science for his achievements in agriculture;
- 1928: bestowed an honorary doctorate from Simpson College;
- 1939: awarded the Roosevelt medal for restoring southern agriculture;
- 1943: U.S. President Franklin Deleno Roosevelt set aside \$30,000 for a national monument to be dedicated to Carver's accomplishments. Carver's childhood home near Diamond Grove, Missouri has been preserved as a park, the first national monument to an African American in the United States.

Though he had become famous, George Washington Carver remained a simple man, devoted to his religion. According to Richard Pilant, writing in George Washington Carver, The Poor People's Scientist, "Unlike the stereotype of the scientist, Carver began each day early

with prayer, praying that new ways might be revealed to him that day by which he could put more food in the bellies of the hungry, more clothing on the backs of the naked, and better shelter over the heads of the homeless. He started each day at four, almost as we might expect a member of a monastic order..."

Mr. Pilant explained, "Dr. Carver was rather widely criticized for saying that answers to scientific problems were revealed to him. But, that criticism largely evaporated when he explained what he meant. Everyone who discovers new truth, be it idea, invention, or material knows that something in the nature of a miracle takes place. The searcher labors without surcease or success till suddenly the moment of illumination comes. Some call this success fate, luck, destiny, intuition, intelligence. Carver chose to call it a revelation from the Creator who is the source of all knowing and knowledge. For the moment of truth there may be many names, but who is to say that Carver's name for it is not as exact as any other, if not more so."

George Washington Carver spent his life in a selfless search for the secrets of God's growing things. He asked nothing for himself, preferring to give his discoveries to humanity. Carver refused to apply for patents for his work. He said "The Lord charges me nothing for knowledge, and I will charge you the same" and, "If I know the answer, you can have it for the price of a postage stamp." Incidentally, a starch created by Carver, is a component in the glue of the billions of U.S. postage stamps.

Carver did not see the color of his skin as a barrier in the segregated South, but assisted people of all colors because he believed that "to bring happiness of others brings happiness to oneself." Carver once spoke on soil improvement to a group of poor white farmers near Montgomery, Alabama. Pilant wrote, "When Carver saw the unpainted churches, he asked the reason why. They told him paint cost money, something they did not have. But the teacher said you can make paint out of clay in the churchyard at no cost. Then Carver made the paint right then and there while they looked on. And then he slapped it on the church." The paint was blue, the color of the heavens. Carver had, during his career, created hundreds of pigments from the clays and earths of Alabama, including a rare, deep blue pigment in which the Egyptologists saw the rich and permanent blue found in the tomb of Tutankhamen.

Carver never allowed anyone to give him money, insisting on earning his own way. Never married, the "Saint Scientist" was a small man, often appearing in a disheveled suit. Carver had no interest in money. Carver never cashed many of the checks he received. In 1940 Carver donated his entire life savings to establish the Carver Research Foundation at Tuskegee. The \$30,000 saved from his modest salary of \$125 a month was set aside to carry on his work. Carver wrote, "It is not the style of clothes one wears, neither the kind of automobile one drives, nor the amount of money one has in the bank, that counts. These mean nothing. It is simply service that measures success."

Not long before Carver's death, a visitor to his laboratory saw him reach out his long sensitive fingers to a little flower on his workbench. "When I touch that flower," he said rapturously, "I am touching infinity. It existed long before there were human beings on this earth and will continue to exist for millions of years to come. Through the flower, I talk to the Infinite, which is only a silent force. This is not a physical contact. It is not in the earthquake, wind or fire. It is in the invisible world. It is that still small voice that calls up the fairies."¹

He suddenly stopped and after a moment of reflection smiled at his visitor. "Many people know this instinctively", he said, "and none better than Tennyson when he wrote:

"Flower in the crannied wall,
I pluck you out of the crannies,
I hold you here, root and all, in my hand,
Little flower – but *if* I could understand
What you are, root and all, and all in all,
I should know what God and man is."²

Carver died of anemia at the Tuskegee Institute on January 5, 1943, and was buried near Booker T. Washington. The epitaph on his headstone is a fitting summary of the man and his life's work: "He could have added fortune to fame but caring for neither, he found happiness and honor in being helpful to the world."

In Diamond Grove, Missouri, at the George Washington Carver National Monument one can see his artwork, his mother's spinning wheel, samples of his lacework, paints he made from clay, and a few of the products he had made from the sweet potato and the peanut.

Bibliography:

1, 2. The Secret Life of Plants, by Peter Tompkins and Christopher Bird. Harpers and Rowe, New York, NY. 1973. Chapter 9, "Wizard of Tuskegee", Pages 135-142. I consider this book essential reading for those who are embarking on the path of research in practical alchemy, as it reveals various models for the interaction of man with the subtle life of the plant kingdom. Tompkins and Bird have also written Secrets of the Soil, of similar interest.

- <http://www.coax.net/people/LWF/carver.htm>
- <http://www.coolpeople.com/legends/carver.asp>
- <http://www.nvpdc.state.va.us/arner/ra-gwcar.htm>
- <http://www.coe.usu.edu/eb/resources/characterbuilder/gwcarver.html>
- <http://www.tristero.com/carver/gwcarver.html>
- <http://library.advanced.org/10320/Carver.htm>
- <http://inventors.miningco.com/library/weekly/aa041897.htm>
- <http://www.erols.com/rpdigest/02049.htm>
- <http://www.lib.lsu.edu/lib/chem/display/carver.html>
- <http://www.nvpdc.state.va.us/arner/ra-gwca2.htm>



ATTENTION!! *Readers and Writers*

According to Webster's International Dictionary the words **cabala**, **cabbala**, **cabbalah**, **kabala**, **kabbala**, **kabbalah**, **qabbala**, or **qabbalah** all refer to a system of occult theosophy or mystical interpretation of the Scriptures.

PON accepts all of these spellings as correct, however, to avoid offending our reader's or contributing writer's personal choice of spelling, the PON editors will only use the generic spelling, '**Qabala**', in all articles and other written applications appearing in *The STONE*.

An *exception* will be made when referring to book titles that include a version of the word *Qabala*. To those submitting articles; please underline all titles referenced in your submission. It will be assumed that your written titles are correct and therefore, they will be printed as received.

Also: Please use a single space between sentences.

Thank you.
Rick Grimes - Editor-in-Chief

UPDATE:**P.O.N. SEMINAR VIDEOTAPES**

The production and sale of the Colorado Seminar videotapes was planned to begin in October, however, we are still unsatisfied with the various proposals we have received. Most of our problems have to do with price per tape and tape length. As I explained in the last issue, the masters have to be made from the originals, then those must be sent to a commercial copying firm. I can't make the originals until we know whether they must be 2 hour masters or 6 hour masters. We continue our search, so please bear with us. As I stated in the last issue of *The STONE*, the original videotapes from Colorado '97 are excellent both in picture quality and sound. We will announce the status of the video tape production in the next STONE.

I know many of you are eager to order videotapes; I would like to get them to you, too. I appreciate your continued patience - I believe it will be well worth it. Thank you.

Rick Grimes - Director, Video Production
The Philosophers of Nature



YANTRAS AND ALCHEMY

by Joseph Caezza
PART FOUR

The *Saundarya Lahari*, literally “the Ocean of Beauty”, remains to be among the foremost classic Hindu devotional hymns. This litany of 103 verses in praise of the Great Goddess is sung daily in tem-

ples and households throughout India often in the presence of the Sri Yantra or its three dimensional meru form. Yet each verse of the *Saundarya Lahari* has its own particular yantra and can be used separately to achieve various occult goals when incorporated into certain rituals.

Verse 32 is prescribed categorically for all those aspirants seeking successful accomplishment in the royal art of alchemy. The specific yantra (figure 1) must be inscribed on a gold plate and worshiped by reciting the verse 1000 times a day for 45 days continuously while each day offering curd rice and black gram cake (1).

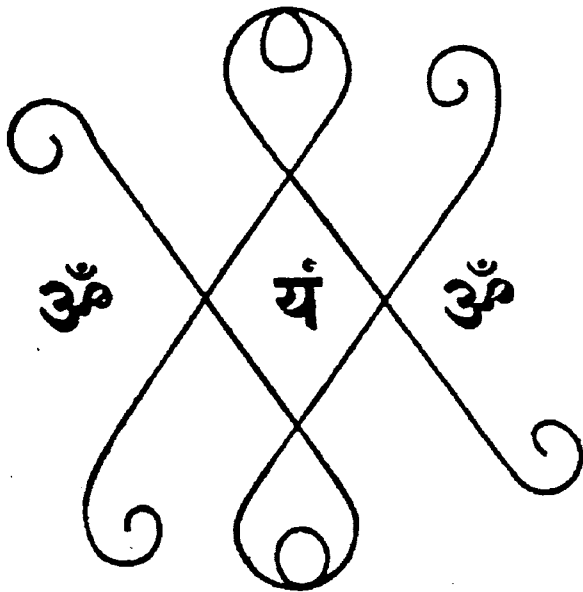

Figure 1

The esoteric import of this verse reveals an even more intriguing phenomenology. The verse translates literally as: “O Mother! Siva, Shakti, Kama and Ksiti and then, Ravi, Sitakirana, Smara, Hamsa and Sakra and thereafter,

Para, Mara and Hari; these (three sets of) syllables, when conjoined severally at their ends with the three Hrilekhas become the component of thy name.”(2). Hidden somewhat explicitly in this verse is a reference to the Panchadasaksari Mantra, literally, the fifteen syllabled mantra. Known also as the Sri Vidya mantra, literally “the mantra of auspicious wisdom”, it undoubtedly constitutes one of the most powerful incantations in all of Tantric lore. Here is the core mantra of Sri Yantra worship. The conventional names of divinities mentioned in this verse indicate specific syllables of the mantra. Siva is “ka”; Sakti represents “e”; Kama, “i”; Ksiti, “la”; this is the first segment of the three-part mantra. Each segment is capped by Hrilekha, “Hreem”. The second segment derives from Ravi as “ha”; Sita-Kirana, “sa”; Smara, “ka” Hamsa, “ha”; and Sakra, “la”. The third segment derives from Para as “sa; Mara, “ka” and Hari, “la”. This untangled Hermetic cipher reveals the auspicious fifteen syllabled mantra.” *Ka E I La Hreem, Ha Sa Ka Ha La Hreem, Sa Ka La Hreem*” (3)(4)(5).

The contemporary Tamil scholar, Layne Little, recently posted a translation of the first 95 verses of *Bhogar’s 7000*, the magnum opus of one of Tamil alchemy’s greatest adepts on Adam McLean’s web site (6). The centerpiece of this collection of hermetic verses, verse 64, reveals the very same fifteen-syllabled mantra indicated in verse 32 of the *Saundarya Lahari*. *Bhogar* admonishes all sincere aspirants to apply this mantra to awaken the fire of kundalini.

Another sage, Thirumoolar, explicitly refers to the fifteen-syllabled mantra in verse 1307 of his 6th century tantric classic, *The Tirumandiram* (7). Thirumoolar takes his place as the father of the Tamil Siddhar tradition, the foremost fraternity of Yogi-Alchemists in South India. (See: *The Stone*, Number 15, for an exploration of this tradition.)

Yet another Tantric litany, the *Lalita Trisati*, a recitation of the 300 names of the Goddess, contains a sublime reference to the fifteen syllabled mantra of auspicious wisdom (8). The first 20 names of the Goddess begin with the syllable “Ka”, the first syllable of the fifteen-syllabled mantra. The second 20 names of the Goddess begin with the syllable “E”, the second syllable of this mantra. The third 20 names of the Goddess begin with the syllable “I”, the third syllable of this mantra and so on (15 x 20 = 300). One finds this mantra buried in the text of this

litany in a manner reminiscent of western notarikon code.

There occur yet other examples of this mantra encrypted into prayers, hymns and scriptures. Its glory can not be overemphasized. Figure 2, taken from a contemporary ritual manual illustrates the manner in which the interior of the central point or bindu (seed) of the Sri Yantra is to be visualized (9). The three segments of the fifteen-syllabled mantra define the generative organ of the Great Goddess. One perceives here the sustaining Genesis of the cosmos. Vision of such continuous creation comprises the moment of Divine Being understood as *Prima Materia*.

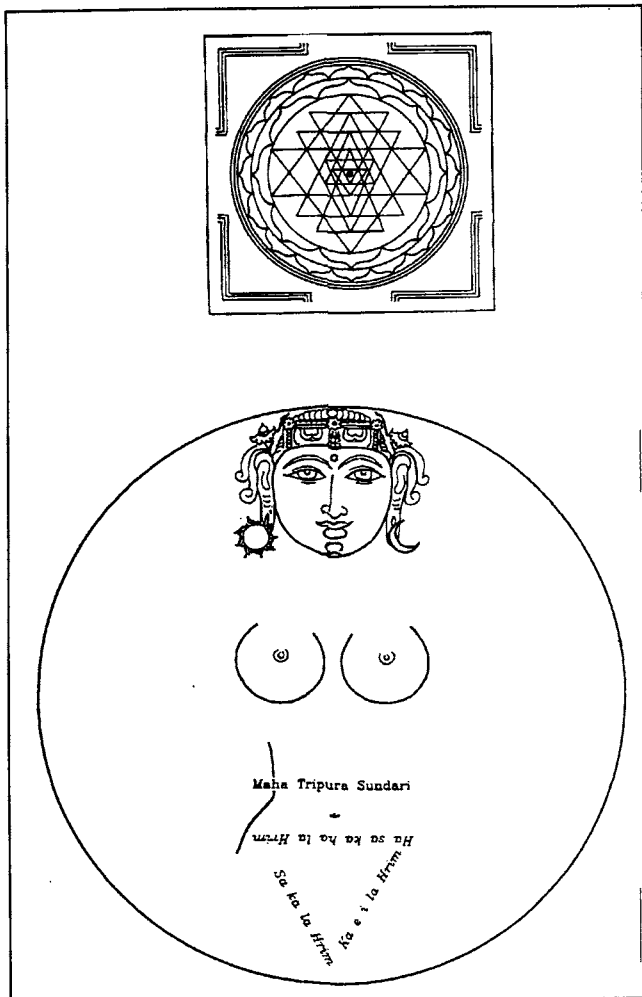

.. Blessed is the fruit of thy womb. . .
Figure 2

The numerical symbolism of these fifteen syllables echoes that of the 15 phases of the moon deified as the Nitya Kalas. These fifteen Goddesses and their corresponding

yantras occupy locations on the central triangle of the Sri Yantra. (See: The Stone, Number 22 for an exploration of their significance.) The pure number 'fifteen' embodies the naked quality of manifested nature. Here is a raw symbol stripped bare of mythic cosmetics. The unmanifested divinely creative Pythagorean Tetractys ("ten") becomes manifested in Nature as the Pentactys, the fifteen unit form, by natural extension.(10)

Intrinsic to the idea of "fifteen" as manifested nature is the addition of the unutterable source unit that identifies the center of the triangle. Here is the transcendental point of unconditioned Being, the Hidden God of the Jews. Esoteric expression of this concept appears in the tradition of the sixteen-syllabled version of the Sri Vidya mantra. The syllable "Sreem" is added to the end of the mantra to identify the "unlimited" absolute seed center. It complements the 3 syllables of "Hreem" at the end of each segment of the mantra. "Hreem" identifies Maya, the "limited" form of the Divine (11).

The waxing and waning phases of the moon corresponding to the fifteen Nitya Kala Deities and the fifteen-syllabled mantra represent the mythic cycle of the hero's journey. Birth, growth, death and resurrection form the archetypal pattern of perfection hidden in the play of parts emanating from and returning back into cosmic wholeness. The same hero cycle plays out in the alchemist's hermetically sealed vessel. The woodblock illustrations that accompany the classic hermetic text, The Rosary of the Philosophers, document this process.

Certainly, the same ideal lies behind the fifteen mediational mysteries of the Roman Catholic Rosary. Practice of this most excellent contemplative discipline requires that the devotee recite prayers honoring the mother of Jesus while meditating on fifteen specific episodes from the mythic hero cycle of Jesus and his mother. In consecutive order these mysteries are: The Annunciation, The Visitation, The Nativity, The Presentation, Finding lost Jesus in the Temple, His agony in the Garden of Getsemeny, The Scourging, The Crowning with Thorns, Bearing the Cross, Death by Crucifixion, Resurrection, His Ascension, The Descent of the Holy Spirit, Bodily Assumption of the Blessed Virgin into Heaven and finally The Crowning of the Blessed Virgin as Queen of Heaven. The cross of the crucifix at the end of a string of rosary beads contains at its heart a point of intersection of perpendicular lines. In the same manner as the bindu center of



The Blessed Virgin Mary associates most strongly with lunar symbolism in her icon as the Madonna of the Crescent Moon.



“And a great sign appeared in Heaven: a woman clothed with the sun, and the moon was under her feet . . .” Apocalypse 12:1

Figure 3

the Sri Yantra, this point evokes the absolute neutral source behind all of phenomenal existence.

The Blessed Virgin Mary associates most strongly with lunar symbolism in her icon as the Madonna of the Crescent Moon. Historical instances of this image trace back to medieval Europe where she served as patron to Knights Templar and Masonic traditions. The best known example of this fabulous hermetic emblem appeared miraculously in 1531 as Our Lady of Guadalupe on the cloak of the Mexican Indian, Juan Diego. Although made from coarse cactus fiber which should have naturally decayed in less than 20 years this cloth remains perfectly preserved 466 years later (12).

Mary, the mother of Jesus appears on the cover of the December '96 issue of LIFE magazine and more recently, the August 25th, '97 issue of Newsweek. A growing ecumenical movement seeks the proclamation of a new papal dogma elevating Her to the status of Co-Redeemer. The September '97 issue of Fortean Times documented a plethora of recent spontaneously appearing acheropites or miraculous images of Our Lady of Guadalupe appearing on the back of traffic signs in Washington State. She also made a recent appearance in the bark of an OAK tree in California, on a bedroom wall in Colorado and in a stain left in a dried-up puddle in Higelgo subway station, Mexico City where she was titled “The Subway Virgin”. Lady Alchemy, the Prima Materia, waits for us everywhere. Today more than ever she asserts herself in a bid to awaken us from our dark slumber.

REFERENCES

- (1) Sankara, SAUNDARYA LAHARI, (1965) The Theosophical Publishing House, Madras, p 268
- (2) *ibid.* p. 123
- (3) *ibid.* p. 123-133
- (4) Sankara, SAUNDARYA LAHARI, (1987) Ramakrishna Math, Madras, p. 83-85
- (5) Brooks, Douglas Renfrew, AUSPICIOUS WISDOM. The Texts and Traditions of Srividya Sakta Tantrism in South India, (1992) State University of New York
- (6) <http://www.levity.com/alchemy/bhogar1.html>
- (7) Brooks, Douglas Renfrew, THE SECRET OF THE THREE CITIES: An Introduction to Hindu Sakta Tantrism, University of Chicago, p. 47
- (8) Satyananda, trans., SHREE MAA: THE GURU AND THE GODDESS (1995) Motilal Banarsidass, p. 189
- (9) Haran, Wijay, aka, Caitanyananda; aka Aiyeea; SRI VIDYA: Sri Cakra Puja Vidhih, (1995) Madras p 390 (Haran is available

at 33 Park Circle, Rochester, N.Y. 14623, 716-272-8081)
 (10) Schwaller de Lubicz, R.A., THE EGYPTIAN MIRACLE
 (1985) Inner Traditions p 86
 (11) Ibid, 5 p. 107
 (12) <http://ng.netgate.net/~norberto/materdei.html>

INTERNET RESOURCES

<http://www.hubcom.com/tantric/ind.htm> (Authoritative Tantra)
<http://www.armory.com/~nojive/> (Methods of Yantra Construction *Astute Discussions)
<http://srividya.org> (Home page of the RAJARAJASWARI PEETAM)
<http://www.shreema.org>. (Authentic Tantra wholly devoid of the bogus hypersexuality usually associated with this tradition)



IMPORTANT Announcement!



*Remember to
Renew
Your
Membership
to*

P.O.N.

*by December 31, 1997
to insure uninterrupted
receipt of*

THE STONE

ORA ET LABORA

By Joseph Caezza

1997 will be remembered as one of the most fruitful years of my life. Several months of study were spent preparing for the conference on **ALCHEMY AND THE HERMETIC TRADITION** held in the Czech Republic. I arrived in Prague, "the Golden City", a few days early and was greeted unexpectedly by Dr. Blahoslav Janes, the co-founder of the prominent Hermetic organization, Universalia. Dr. Janes guided me on an excursion to the sites of Northern Bohemia that included an ancient Templar fortress which once housed an alchemical laboratory, the initiation vault of a functional Masonic lodge and the mountain top ruins of the thousand year old Hassenbach Castle. Dr. Lubos Antonin, the vice-president of Universalia, escorted me through the mineralogical exhibit just above his office at the National Museum and later to the hilltop fortress of Vysrad where the sixth century Premyslid princess prophetess Libuse received her alchemical vision of Pragues glorious future.

The conference featured a stellar cast of scholars that included Joscelyn Godwin, Adam McLean, Chris Bamford, Chris Mcintosh, Robert Bly, Nicholas Goodrich-Clark, Stanislaus Klossowski de Rola as well as a host of leading Czech Hermeticists. Members of The Philosophers of Nature in attendance included Art Kompolt, Paul Whittemore, Dan Noreen and Dr. Marta Illeuca. After the conference, we journeyed eastward to the medieval silver mining town of Kutna Hora and to Chesky Krumlov in Southern Bohemia. Both towns enjoy a rich alchemical heritage.

What experience could possibly compare to such an adventure? The unprecedented spiritual high of this pilgrimage ended all too abruptly. I returned to the States in a fog of excruciating frustration. Desperately sought relief from this 'dark night of the soul' came only two weeks later at the Winfield, Illinois home of our president, Russ House. The occasion concerned a three-day workshop on mineral alchemy, *The Way of the Acetates*. Russ, a former instructor at AMORC's Rose-Croix University shared more than fifteen years of experience in hands-on laboratory operations. The procedures entailed destructive distillation of metallic acetates that featured prominently in the work of such classical authors as Paracelsus, Lully, Ripley, Weidenfeld, Hollandus and Edward Kelly.

The Passion of Christ indicates the essentials of this process. Jesus, the vital principle is nailed to the Tau cross, an ancient symbol for lead. He thirsts and is given vinegar to drink.

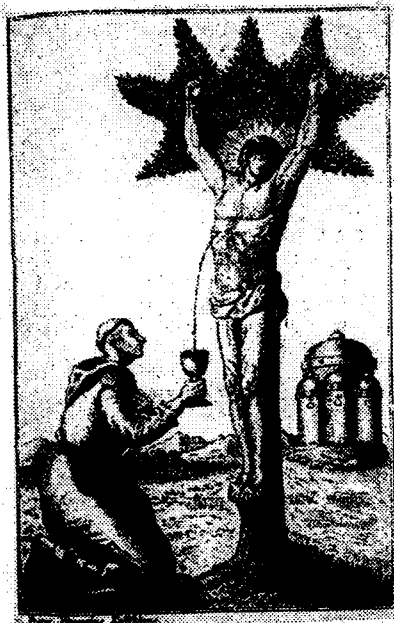

Lead acetate, a prima materia mineral chaos is formed and subjected to destructive distillation. Jesus dies on the cross "giving up his ghost". The lance pierces his side. Water and blood pour fourth. Distillation yields a white water, *mercury*, and a red oil, *sulfur*. Salt derives from the caput mortuum remaining in the

reaction flask. These materials are purified, recombined and sealed in a hermetic vase. Jesus is laid in the tomb only to resurrect himself as the Philosopher's Stone.

Upon assembling in Russ's lab on Friday evening, we began the work by separating choice ores of cerussite and galena from coarse matrix. Mechanical pulverization yielded fine dust of usable consistency. We retired to the living room where Russ and I engaged in an igneous conversation of volcanic intensity. Just when it seemed it couldn't get any better... it got better! The doorbell rang. In walked the living adept, Jean Dubuis and two of his colleagues, Patrice Malézé and Etienne Cornaille just off a plane from their native France. An eruption of joy exploded through the house as greetings were exchanged with our surprise guest of honor. Celebration ensued. Each of us imbibed impromptu Holy Communion in the form of a



Friday evening

port wine tinted with potable gold. The fixating fatigue I had borne after an eleven-hour drive miraculously evaporated. Jean, the founder of the now disbanded French organization, Les Philosophes de la Nature and its presently thriving American offspring, has been the recent victim of unjust harassment and slander. He counseled us on our grave responsibility to preserve the highest ideals of practical European esotericism. Jean also explicated upcoming astrological alignments ideal for the Great Work.



Saturday morning class consisted of an intensive review of theory with emphasis on the preparation of vinegar from red wine. Jean described a method of potentising such vinegar by adding acorns and oak shavings to the mother solution. The apparent necessity of working with native ores and personally prepared acetic acid derived from red wine was presented in a manner that challenged us to transcend traditional authority.



After a thorough discussion of apparatus, we moved into the technical details of actual practice. Charlotte Smith reminded us to always add acid to water. Russ demonstrated a precautionary strategy of lining a heating mantle with kaolin. He stressed the

Charlotte Smith demonstrates proper lab safety equipment.



importance of blocking the back-flow of air into the reaction chamber at the end of the distillation. He displayed a partially melted flask imprinted with the fabric mesh from a destroyed heating mantle. It testified to the potential casualties of not strictly observing this rule. Ray Cullen showed us an elegant method of breaking a flask in order to remove its contents. We heard a grace-

ful snap as soon as he touched a cool damp cloth to its heated score mark.

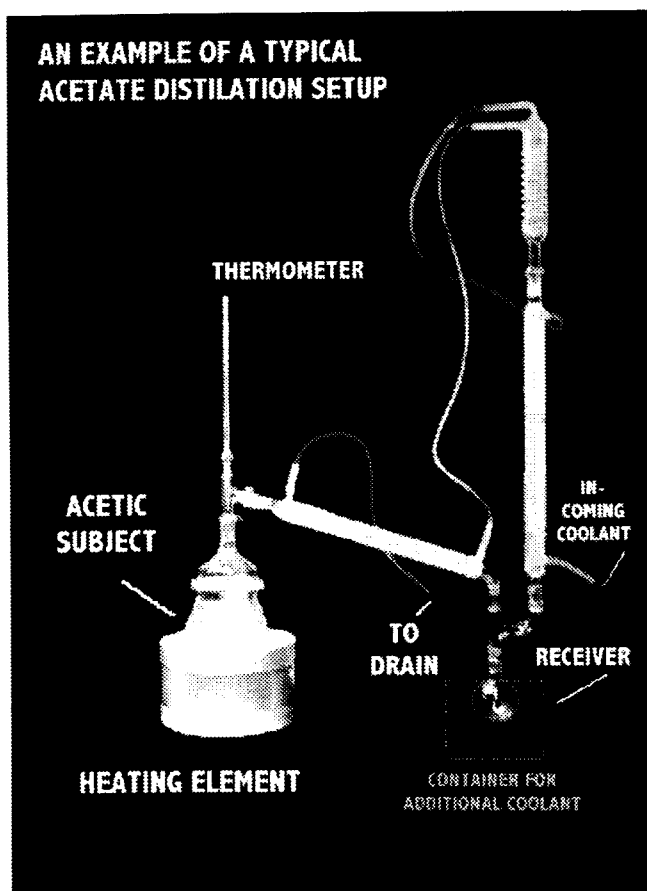

Two distillation trains for lead acetate and one for philosophical wine occupied our attention for the bulk of Saturday. We marveled as solid lead acetate dissolved into liquid, boiled for a time and then re-coagulated into a snow-white vitreous mountain within the reaction flask. A

vigil into the early hours of Sunday morning completed our efforts to obtain philosophical wine.

The exercise of distillation embodies the naked essence of alchemy. The central injunction from the Emerald Tablet prescribes: *"Separate the fire from the earth, the subtle from the gross, gently and with great skill, ascend from earth to heaven and descend again to earth. Unite the powers of higher things with lower things and you will receive the glory of the whole world and darkness will fly far away from you"*. Intense identification with distilling materials may initiate ascending movement of the spiritual fire within the operator. Laboratory manipulations thus constitute sacred technology beyond the pantomime of mere ritual.

Correctly executed hermetic work is neither a team effort nor a spectator sport. It proceeds with the sacred intimacy of matrimonial consummation. This attitude seemed to pervade the small group assembled here.

A great joy during this event emerged from conversations with long time devotees of the royal art. Rick Grimes endorsed my suspicions that prolonged metal fusion temperatures are unnecessary. He further provided delightful alchemical interpretations of Cinderella, Old King Cole, and Snow White.

A feeling precipitated among those present that this happening constituted the single most significant event in the history of The Philosophers of Nature. An intense personal experience occurred when Jean kissed my forehead, blew gently and tapped the crown of my head. This gesture known in the East as "Shakti Pat", the transmission of grace, effected a spiritual jump start reminiscent of Roman Catholic sacramental Holy Communion. Yet, he conveyed it with the casual ease of a handshake. There dawned a glory of momentary breathless exaltation as the ascending fire exploded in my cranial retort.

Sunday afternoon entailed discussions of various paths toward recombining the separated materials. Jean described this as a limited but useful path to self-initiation. "No Guru, No Master, No Priest", His



Jean and Kathy - lite

final words to me crystallized the ultimate import of this meeting. Each of us holds the power and bears the responsibility to perform our art and perfect our lives.



ABOUT THE STONE

The STONE provides a forum for articles (5000 word maximum), conference announcements, research summaries, and other items of interest to PON members and our subscribers. Authors should, if possible, submit manuscripts as an email attachment to:

turpen@starnetinc.com

Use a plain text (ASCII format) or mail them on disk along with unmarked, printed copies to:

Rick Grimes - Editor
The STONE

800 N. Clark Street #317
Chicago, IL 60610 USA
Phone: (312) 654-1766
Fax: (312) 225-1371

Publication decisions are normally made within four to six weeks. Selected articles from *The STONE* will be republished on the PON Internet site at the discretion of the editors.

The STONE is published every two months, and is normally mailed on the 2nd Monday of the odd-numbered months.

Subscriptions to *The STONE* are \$30.00 US per year for non-members, and are free to active members. Membership dues are \$30.00 US per year. Subscriptions are for January through December - all back issues for current year are sent to new subscribers. Add \$10.00 for foreign postage. Make payment by credit card or by check drawn on a bank with a US branch.

Send all inquiries about subscriptions or membership to:

The Philosophers of Nature
125 West Front Street, Suite 263, Wheaton, IL 60187
USA
Email: alchemy@mcs.com

Follow Up to the Lucid Dreaming Project

by Mark Stavish, M.A.

*Director of the Occult Research
and Applications (ORA) Project*
of

The Philosophers of Nature
Copyright 1997
Mark Stavish, M.A.
mrkstavish@aol.com

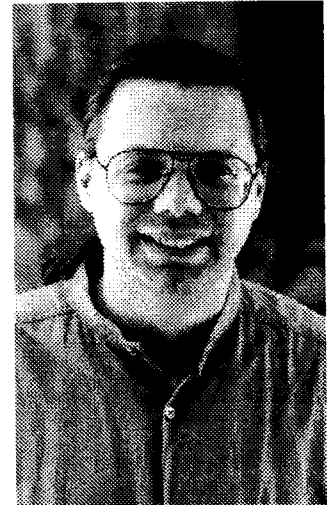

Introduction

Since publication of the ORA Project's Lucid Dreaming exercise in *The Stone* and *Caduceus: The Hermetic Quarterly* earlier this year, many people have written to tell of their experiences and the wonderful results they have obtained from regular practice of the technique. As a result, we are publishing this follow-up to the exercise so those who have been practicing for almost a year now may take their technique to the next level, and those readers who have been putting off incorporating the lucid dreaming material might be encouraged to begin.

This additional material is designed to show practitioners how they might achieve the following:

1. Increase dream content via the Hebrew Letters.
2. Create the "Magical Voice" or "Verbum" (Power of the Word)

Dreaming in Hebrew

A notebook is required for successful understanding of the Qabalistic or Alchemical Paths, as it reflects our personal experiences and makes concrete the volatile information we begin to receive from our inner self during receptive moments from our practices. This information is accumulated over time and must be made into a synthetic idea by each of us. If you are not keeping a notebook, begin so immediately! Just as an exoteric teacher will discontinue instruction if their lessons go unheeded, so does our interior one. If you are serious about your inner growth, then keep a record of your interior contacts. This record will later develop into a series of inner teachings.

The Power of the Word

"In principa erat Verbum...." In the Beginning was the Word

John 1:

Positive thinking in the single most important key to success on the esoteric path. In fact, we could almost call it, the "magic of Tiphareth", in that thinking is by itself a magical (i.e. imaginative and magnetic) act. By focusing on the positive aspects of a given situation, no matter how despairing or hopeless it might appear, we can find a resolution that is in harmony with our inner growth.

This focusing on the positive doesn't ignore the reality of negativity and evil in the world, but simply accepts it, and realizes that all things have a function, even if we are not conscious of them, and that by addressing the positive we can progress through along our life path.

By extending this inner attitude into the outer world, we begin to share it with others and mold a new life for our self. This is principally done through the speech, or the power of the spoken word.

Speech is our principle form of creative energy in day to day life, sexual energy being our most fundamental form of creative impulse. These two expressions of energy are deeply connected to each other.

Through harmonic resonance, or sound, we can create conditions that are favorable or unfavorable to us. This can be on either an exoteric or esoteric level. By finding those sounds, or vibrations that we resonate to most harmoniously, we can create conditions favorable to us. Thus, our speech becomes a tool, albeit an expression, of our inner state.

Positive thinking in the single most important key to success on the esoteric path. In fact, we could almost call it, the "magic of Tiphareth", in that thinking is by itself a magical (i.e. imaginative and magnetic) act.

Speech is our principle form of creative energy in day to day life, sexual energy being our most fundamental form of creative impulse. These two expressions of energy are deeply connected to each other.

The Name

We are encouraged to find a list of Hebrew names¹, such as in *The Occult Philosophy* by Agrippa, a list of Hebrew surnames, the Apostles,² etc., and to discover which one, or ones, resonate with us on an interior level. After having cleansed and re-balanced the energies of our environment, either through the Pentagram ritual or other means, and with the list before us, we are told the following:

"Recite in a low voice the Hebrew names that you chose, one at a time, and meditate a minute or two after each name. Several things can occur. We are only interested in two of them. One of the names provokes a heart resonance: it is your spiritual mystical name; one of them provokes a cerebral resonance: it is your material occult name.

Note the name, the date, the time, and the place of the revelation.

In either case, it is a rebirth and your astrological chart becomes the one of the moment of revelation. You and nobody else should interpret it. Look into the *Sepher Yetzirah* - and there only - for its real meaning....

repercussions."³

However, many members have found it difficult to discover their inner name. We hope that the following information makes this discovery easier.

You can incorporate these names into your mystical work of the descent of *Mezla*, either for the occult, spiritual or practical work without any negative Karmic

¹ PON *Qabala Lessons 8 & 9.*

² PON *Qabala Lesson 13.*

³ PON *Qabala Lesson 9, p.5.*

The Inner Name

Prepare yourself as usual for sleep, or even meditation.

As you imagine the indigo sphere at the level of your throat, large and luminous, vibrate one of the names on your list. Pause for two or three minutes and await a response. If none comes, move on to the next name. It will help if you can visualize the Hebrew letters of the name moving forth from within, to the farthest reaches of the universe, pausing for a moment, and then returning to you as a creative vibration or force of some kind. If you are doing this prior to sleep, you may choose to do only one name a night for a period of twelve nights.

It will help as well, if you add an affirmation to your visualization. One that expresses your inner desire and intent of the experiment, that is, to realize your inner name of power. For example: "I call upon my Inner Name to reveal itself to me!" More will be said on the power of affirmations later in this article.

As for the "Inner Name" each possesses, bear in mind the following:

"Each being on Earth has an esoteric name, which starts at the time of entry into duality for the involutory-evolutionary journey. Man receives a name which is in fact an image of the Eternal Vibration - his being. All men do not receive the same name but all names are equivalent, as a very function of the principles of Universal Justice...for each level or plane man will receive a new name. Knowing one or several of these names is an important part step for the student because the accurate vibration will create a profound resonance in him between the physical level and the inner level. The name vibrated corresponds to the inner level.

"Each being on Earth has an esoteric name, which starts at the time of entry into duality for the involutory-evolutionary journey. Man receives a name which is in fact an image of the Eternal Vibration - his being."

Warning: in no event whatsoever should you communicate your name(s) to anyone, should you discover them. ... To communicate one's esoteric name to someone else is a betrayal of the Inner Being and can stop the evolution for the duration of an incarnation. ...

Warning: in no event whatsoever should you communicate your name(s) to anyone, should you discover them. ... To communicate one's esoteric name to someone else is a

betrayal of the Inner Being and can stop the evolution for the duration of an incarnation. ... each one of us has an esoteric name for each level of Creation. Pronouncing one of these words provokes a kind of invocation in our Inner Self at the level corresponding to the name. ... If someone

cannot find your inner names on his own, he doesn't possess the wisdom to use them."¹

These names can be found by vibrating the Divine Names of each sepherothic level in a particular sequence. However, it is stated that this should only be done after the

meditations on the polygons and/or planetary symbols. We state this again in reference to the Lucid Dreaming technique. You should only use it to search for your Inner Name, or to develop

the Magical Voice, after you have performed it regularly for several months using the Elemental and Planetary symbols.

If your name is revealed to you in Hebrew, remember: *Hebrew is read from right to left*, and may need to be transliterated into Latin characters.

"...the vocalization of divine names is one of the most important elements of ritual magic... The result of the vibratory vocalization of the divine name is to achieve in the higher levels of Astral Light, to the limits of the world of Briah, a harmonic response of the first invoked then secondly evoked intelligence."²

After having worked through the basic symbols of the Lucid Dreaming exercise, you can substitute Hebrew

¹ PON *Fundamentals of Esoteric Knowledge Lesson 5*, p. 5-6.

² PON *Qabala Lesson 61*, p. 4-5.

letters for the planetary signs. This will create a deeper resonance within you for not only the letters themselves, but also when they are combined into Divine Names.

Aleph - Or What Is A Glottal Stop Anyway?

When visualizing the letters, start simple: imagine them as blazing white against the ultra-violet, or indigo, background. Later on, imagine them in the King's Color scale, or the colors used in the creation of the Hermetic Rosy+Cross. Over a period of two or three months, you can also begin to add the "Elemental" qualities of Fire (hot and dry/expansive-electric), Water (cold and wet/contracting-magnetic), Air (warm and moist), and Earth (cold and hard) associated with each letter.

By working with each letter this way, we can avoid the costly task of attempting to memorize all of the symbols at once. Instead, we slowly layer them over a period of several weeks or months, absorbing and synthesizing them in small doses. Thus, through personal experience we come to have an understanding of each letter and its associations, instead of through an exhaustive and at times confusing intellectual exercise.

Once again, your notebook will serve as your best friend and teacher in this world of inner exploration. Through it, you will chart your progress, and begin to see how the patterns of inner teaching develop and progress.

Later on, you may eventually add the a vibration or the each letter, either silent or spoken, so that you might discover for yourself the best resonance for when you intone divine names, combinations of letters, and other forms of sacred speech.

If you chose to vibrate each letter, remember that the sounds created should be deep, resonant, and cause a subtle, if not exhausting, vibration throughout your entire body. They should be imagined as being 'inhaled' and then spoken (or shouted) to the ends of the universe and

returning again to you. This can also be done slowly and progressively, adding color and quality to each letter over time.

"The Word is the vehicle of the will and of thought. That is why magicians can utter words that may seem devoid of meaning. However, we can say that these words are energized by them because they know what to expect from their vocalizations. In addition, these words, through repetition, acquire a charge which still increase their power of action."²

... With regular practice we can rather quickly feel at will an intense tremor in the entire body under the impact of the vocalization of a single word. Also, practice will allow the student to contain at will the vibratory effects to a specific part of his body. "¹

And:

"In addition, the magical theory considers that the vibrations triggered by human voice has the power not only to fashion the plastic substance of the Astral Light into various forms according to frequency, amplitude, intensity

and the resonance of the emission of the sound, but also to attract to our world the attention of various metaphysical entities.

... With regular practice we can rather quickly feel at will an intense tremor in the entire body under the impact of the vocalization of a single word. Also, practice will allow the student to contain at will the vibratory effects to a specific part of his body."³

Power of the Voice

The throat is directly connected to our power of speech, and creation. Through it we communicate to others, be they human, animal, or Divine. It is the quickest way to turn something into a reality in the material world, for sound itself is both transient and permanent. Once a word is spoke it is gone, yet its meaning, and effects remain forever. A word spoken can not be taken back.

Words 'crystallize' or make tangible our inner most thoughts. The more complex the thought, the more complex the word to describe it. These complexities act as 'verbal DNA' or programming, creating a series of visible

¹ Ibid, p. 3.

² PON *Qabala Lesson 61*, p. 1

³ Ibid, p. 3.

and invisible conditions that become our life.

How often haven't we said something in haste, jest, lust, or anger only wishing later that we could undo what was done? If mortal speech is so powerful, then how much more potent is our speech when magically directed?

"Initiated man is a transformer of energy. A layman who pronounces a word disturbs the air of the physical world but his word has little resonance in the higher frequencies. On the other hand, the initiate has reestablished the links between the different levels of his consciousness. That is, he reestablished contact with the various vibratory levels of the universe, and the more he advances on the initiatory path, the better the contacts between his various planes.

"Therefore, contrary to the layman, when the initiate talks, he disturbs the higher vibratory levels and if his word conforms to the original language he will then create the very thing designated by the word, through harmony, will radiate the vibrations which are the thing itself. Thus, it is easier to understand in Genesis of the Bible, the part where man named the animals; this means that he created them by pronouncing their true names. Moses, in the desert, pronounced the true name of water which gushed forth from the sands."¹

Silence

"If speech is silvery, then silence is golden" is an old proverb that is more true than many realize. By practicing silence we learn to conserve our energies and to direct them to other creative enterprises. How often have you had a great idea and spent so much time talking about it to others that by the time you got around to do it your enthusiasm was gone? The once buoyant energy you felt had

escaped through your lips and you were left literally feeling empty? This was compounded later by questions from friends and enemies alike who heard of your project and asked you about it. Sheepishly you changed the subject or went out of your way to avoid further discussion of it. The seed energy, the initial passion, was wasted, (the verbal equivalent of masturbation) and nothing was born of it. This failure to produce then creates interior feelings of loss and embarrassment that must be removed before future developments can be made. This is the reason why so many creators, artists, writers, designers, and engineers hide their work from prying eyes. Reveal it for criticism and renovation only after it has successfully germinated into a viable product, plan, or design.²

*"Initiated man is a transformer of energy.
A layman who pronounces a word disturbs
the air of the physical world but his word
has little resonance
in the higher frequencies.*

*. . . Therefore, contrary to the layman,
when the initiate talks, he disturbs the
higher vibratory levels and if his word con-
forms to the original language he will then
create the very thing designated by the
word, and through harmony, will radiate
the vibrations which are the thing itself.*

Just as speaking of positive things often weakens their energy or power to materialize by directing our energy away from the 'doing' of the project (as well as opening ourselves up to the energy of those who might oppose us even unconsciously); constant talking of our problems only reinforces them and makes them stronger, more concrete.

It seems that those who succeed in an undertaking keep silent about it until it is manifest. Those who fail seemingly waste their energy in verbal outlets, or misery mongering.

With regards to karma, keep in mind the following:

"In order to neutralize and master "karma" - we could say our difficulties, our stumbling blocks - we should remember that Universal Justice is infallible. . . .

² On a personal note, this writer can take any amount of criticism and editing after the initial product is finished, but will not even acknowledge a work is in progress until then.

¹ Ibid. p. 11.

How can we participate in or be part of the solution? First of all, the most obvious thing is not to complicate our case and the first practice is silence. As a matter of fact, talking about our "problems" with the conscious or unconscious intention to complain about or justify our behavior certainly results in the prolongation of the situation even if the latter doesn't get worse. ... The less individuals know of your problem, the easier it is to resolve it, the easier it is to dissolve it. We should therefore avoid giving a fixed quality by crystallizing it."¹

The reverse of this is also true however. If voice can crystallize a condition, through judicious use of voice, we can realize conditions that are preferred by us. When combined with the above use of Hebrew letters and the powers they manifest, we can begin to direct our inner energies in any manner we see fit.

The power of affirmation, or auto-suggestion, can be united to this process of energizing the throat and medulla centers, to create a more potent technique. However, as with anything of an esoteric nature, the affirmations best used are ones created by each of us. Since each letter/planet symbol has several qualities, the energies we seek to strengthen may be slightly different for each of us. Thus, research and review the nature of each letter and develop your affirmation from there.

The general rules of creating affirmations are the following:

1. Keep it positive and active.
2. State it in the first person possessive.
3. Keep it short.
4. Energize it with emotion, as you do the letters themselves.

For example, if one needs to reinforce the qualities of the

¹ PON *Fundamentals of Esoteric Knowledge Lesson 10*, p. 3.

Moon, the following affirmations could be used in conjunction with the Hebrew letter *Beth*.

"I am Beth! Master of Wisdom and Ignorance! Here me oh Universe and reveal to me the House of the Lord!"

"I am Beth, the Moon in its Glory! The powers of expansion and decline are obedient unto me."

"The Moon in its fullness I am! Reveler of hidden Wisdom and the powers of right action."

As you can see, each of the above affirmations is similar to the other in that it places the "I" in the active and possessive part of the statement, but each expresses a slightly different quality of the Beth-Lunar energy. Using the above as a model, consult the *Sepher Yetzirah*,² and develop several affirmations for each of

the seven double letters.

Bal Shem

The *Bal Shem*, or Master of 'the Name' was one of the most remarkable aspect of Medieval and Renaissance Jewish qabala. For these Rabbis, nothing was impossible, and miracles are said to have been performed by them simply through the spoken expression of one or more of the Names of God. Their beliefs even continued, and were adopted by various folk traditions of Europe and North America.³

² PON *Qabala Course Lessons 9-11*. Please note, the various versions of the *Sepher Yetzirah* differ on the attributes. The *Gra* edition is the most common. See: *Sepher Yetzirah - The Book of Creation, In Theory and Practice* by Aryeh Kaplan for a comparison of the different editions. Also see Franz Bardón's *Key to the True Kabbalah* for additional attributes of the Hebrew Letters. Please note however, that they must be transliterated back from *phonetic German* into Hebrew to be of use.

³ For more information on the continuation of phonetic qabala in folk magical practices see: *Pow-Wow, Psalms, and German Magical Folklore* by Mark Stavish, M.A.

"When vibrating divine names, the operator must first reach the highest possible notion of the idea of the white Divine Radiance of Kether, while keeping in his mind at the level of the highest aspirations. If this is not achieved it is dangerous to only vibrate with the forces of the Astral world, because the vibration draws to the operator a certain force and the nature of this force depends very strongly on his state-of-mind."

However, the pronunciation of Divine Names, letters, or any words of power, come from several factors, including proper internalization of the sounds to be vibrated. The general method for their invocation is as follows:

“When vibrating divine names, the operator must first reach the highest possible notion of the idea of the white Divine Radiance of Kether, while keeping in his mind at the level of the highest aspirations. If this is not achieved it is dangerous to only vibrate with the forces of the Astral world, because the vibration draws to the operator a certain force and the nature of this force depends very strongly on his state-of-mind.

The usual way to proceed is as follows: breathe in deeply and profusely and focus your attention on your heart, which corresponds to Tiphareth. (Having first meditated on your Kether, you will attempt to lower the white radiance to the innermost part of your heart before fixing your attention there).

Then formulate the letters of the selected name in white letters in your heart, feel them as if they were carved. Make sure to formulate these letters in a white luminous radiance and not silver-white. Then, while breathing out, pronounce the letters softly so that the sound vibrates inside your and imagine that the breath while leaving your body swells to fill the entire space. Pronounce the name as if you were emitting it throughout the entire Universe and that the sound could not stop before it had reached its ultimate limits.

Any practical successful occult work exhausts the operator or takes away some of his magnetism that is why if you want to realize work of some magnitude you must possess a perfect magnetic balance. Otherwise you would do more harm than good.”²

¹ *PON Qabala Course Lesson 61*, p.7. And, *The Golden Dawn* by Isreal Regardie. Llewellyn Publications, St. Paul, MN. 1986. “*The Vibratory Mode of Pronouncing Divine Names*” P. 487

² *PON Qabala Course Lesson 61*, p.7. And, *The Golden Dawn* by Isreal Regardie. Llewellyn Publications, St. Paul, MN. 1986. “*The Vibratory Mode of Pronouncing Divine Names*” P. 487

Conclusion

We hope that the above has proven useful to you in your search for inner resonance and outer harmony. The tools have been given and are yours to use. Only by using them over a period of time do they become an interior part of us, and ourselves capable of mastering them. The techniques described are among the simplest and most effective

we know of for attaining inner resonance, and as stated several times, with little addition to your daily schedule as they are performed for a few minutes at night prior to sleep, and even if desired, for a minute or so in the morning upon awakening. Their purpose is to attune each of us to the specific qualities of the day - either through astrological symbols or Hebrew letters -

or other archetypal qualities as expressed through the twelve simply and three mother letters of Hebrew.

As these forces become known to us on a simply and ‘one-to-one’ level, they will eventually combine into more complex ideas, and forces for the realization of those ideas. This will hopefully reveal to us the nature of the seven dual principles, the stages of energy density, and our interior name(s) so that we can better direct these forces within us.

All you need to do is close your eyes and dream. What can be more simple than that?



Portæ Lucis Method of Jean Dubuis

as presented
at the 6th Annual Philosophers of Nature Conference,
Colorado Springs, Co. 20 July 1997

Summary by Mark Stavish, M.A.,
Director of Research, ORA Project
for *The Stone*

Introduction

Over the past several years, Jean Dubuis, founder of LPN and author of its lessons, has been developing a new technique of initiation. Since this method, known as *Portæ Lucis* (Portal of Light), has been a powerful, yet evolving process, some of PON's members are unclear about the particulars of how to prepare themselves for accessing those interior states that *Portæ Lucis* promises.

The purpose of this article is to clear-up some of the confusion some members have regarding *Portæ Lucis*, as well as present the most recent version of the technique in clear and precise terms.

Theoretical Overview

The description of *Portæ Lucis* involves three key components: astrological timing, passivity on the part of the aspirant, and the use of psychically loaded, or charged, talismans to assist in filling our energetic requirements for the experiment.

The fourth, or final component, is one which we can have no control over - Divine Grace, or a Cosmic response to our inner desire, preparations, and readiness to experience a "Contact with Eternity".

This "Contact with Eternity" takes place on the level of Saturn, and makes us aware of our place in creation, and relationship to all things. It is a difficult state to bear, and as Saturn is the planet of melancholy and despair, it can bring a profound state of sadness, depression, and even suicidal tendencies for those who make the contact.

However, along with it, will come an influx of energy that awakens our Heart Center, or gives us an initiation at Tiphareth. Here, our relationship to our Inner Master is realized, or what is often called, "Conversation with our

Holy Guardian Angel". After a period of time, this develops into a relationship by which we can dialogue with our Inner Master, but only after a long probation of silence and listening to what it has to say to us for our evolution.

Thirdly, our mental faculties of the brain and nervous system, via Yesod, are charged, and we can bring this Experience of Eternity, and Knowledge of the Interior Master, to the material realm, or Malkooth.

Physical Preparations

To assist in increasing our chances of success in "Contacting Eternity", we need to increase our energy levels and reserves, as such high contacts can be physically and psychically draining. For this, we need to acquire several sets of 'products' or objects to be loaded (i.e. charged) with the appropriate psychic influence for each of the three levels - Saturn, Sun, and Luna.

Each level has four products, one for each of the four Elements of Earth, Water, Air, and Fire, for that particular level. Thus, we have a container that holds a charge for each specific quality of energy presented, and they are progressively charged and released for the execution of the experiment.

Once the products are used in the experiment, their energy is discharged and they need to be recharged before being used again. Since there are several periods of optimum opportunity for a successful contact, it is suggested that we have *three sets* of charged products *for each level*.

Additional Effects of the Technique

In addition to the awakening of the three central *sepheroth* (or psychic centers) of the Tree of Life, the side 'spheres', or levels as Jean calls them, are also effected to some degree. These awakenings take place according to the planetary order of the week: Mars on Tuesday, Mercury on Wednesday, Jupiter on Thursday, and Venus on Friday, just as the previous levels were awakened in descending order starting on Saturday, then Sunday, and completing the initiations on Monday.

Here again, energy, knowledge, and love can be contacted on a higher level, via the new awakenings.

The Technique of Portæ Lucis

The technique described by Jean involves a fairly advanced level of astrology and its relationship to magic and alchemy. However, for the sake of simplicity and easier availability, the use of planetary genius' can be substituted. However, information on both methods of timing will be explained, allowing members to chose the methods best for themselves.

In addition to astrology and/or planetary genius', the technique involves the use of A) classical Renaissance talismanic magic; B) a modified version of the Tree of Life C) a passive approach on the part of the experimenter, as opposed to a more active and involved system of mechanics. It is this extreme passivity that appears to be a problem for many who have been exposed to the *Portæ Lucis* technique for the first time.

Unlike qabalistic or Enochian magic, where energies are imagined and directed, here, the products to be charged are simply exposed to the planetary power during an astrologically favorable time, or simply unwrapped during the correct planetary hour, and allowed to absorb the energies in a gentle and natural fashion. It is no more complicated than dropping a sponge in a basin of water and allowing it to slowly absorb the water to its fullest capacity on its own. The same products are then exposed several times to insure maximum harmonious charging, and are stored in silk, plastic, or other non-conductive materials so that they maintain their psychic charge.

Once charged, they can be seen and touched only by their owner or they will lose some or all of their energy. The only exception to this is married heterosexual couples working together on the technique. In this instance, both partners must be present for the charging of the products a majority of the time.

The modified version of the Tree of Life being used for this method involves the positioning of Saturn where Daath is located on the Tree, and placing Hockmah and

Kether directly above it. These latter spheres are seen as aspects of Eternity, or Unity, however, for it to be digestible to our human minds, we perceive Unity has having three aspects: Eternity or Timelessness (Binah/Saturn), Spacelessness (Hockmah/Zodiac), and The Black Point of pure being (Kether). Some people will experience the Black Point phase before they experience Eternity.

Creation of Matter and Consciousness

According to qabalistic and alchemical theory, matter is created by the increasing density of human consciousness during the so-called "fall" so that we can obtain experiences of individuality. This individuality allows us to obtain experiences and knowledge. It is this knowledge that allows our human seed in potential to grow and return to Unity as a human in fullness of wisdom, knowledge, and love. We go from conscious being in potential to conscious being in manifestation.

The "Fall" is our conscious descent from Unity into the Creation of Duality and matter. The "Return" is our conscious re-ascent through matter and expansion of consciousness, as an act of free will on our part.

The higher realms are cut-off from us, and we can then only contact them through dreams, initiation, or the creation of archetypes.

The first matter that we create is the Mineral realm, or our Mineral Tree as it is called in *Portæ Lucis*. Here our consciousness descends and increases in density, thus limiting is expression, through the mineral world. Once it reaches maximum density, it returns up the mineral tree, increasing in consciousness and decreasing in density of matter. This same process is repeated for each of the three additional Trees - Water, Air, and Fire.

It is at the Fire Tree that human consciousness is attained, as we know it, and the beginning of the Path of Return begins. Thus, only Fire Element can allow us to expand in consciousness as human beings.

The "Fall" is our conscious descent from Unity into the Creation of Duality and matter. The "Return" is our conscious re-ascent through matter and expansion of consciousness, as an act of free will on our part.

However, the three other Elements are used, so that we may correct any energetic corruption's that might exist in those Trees within us. To take maximum advantage of our Fire Tree, our Earth, Water, and Air Trees must be in order.

To maintain or achieve these energetic conditions, we use a talisman for each of the four Trees on each of the three levels.

These talismans consist of the following elements:

Saturn:

Mineral - Diamond or graphite
Water - dry herb/tea or tincture of horsetail
Air - Sea Salt
Fire - Rain Water

Sun:

Mineral - Native gold or sulfur
Water - tincture or dry herb/tea of Eyebright or Celandine (the Lesser)
Air - Sea Salt
Fire - Rain Water

Luna/Moon:

Mineral - Native Silver
Water - tincture or dry herb/tea of Veronica
Air - Sea Salt
Fire - Rain Water

The rainwater can be collected in a glass or plastic container and filtered prior to use. It should however, never come in contact with any metal or it will lose its charge. The native metals are metals that have not be processed or come in contact with other mineral compounds or agents during their extraction. The sea salt must also be natural sea salt, unprocessed, usually gray in color, and highly hygroscopic. When exposed to the air it should become hard and solid as it absorbs moisture from the surrounding environment. A health food or natural food store should be

able to order it for you if unavailable.

If the salt is white or granular, it has been processed and will not be as useful for the experiment. This is based on the basic alchemical principle that when a crystal is dissolved, its energetic qualities are lost. If it is properly charged, sea salt will have strong purification qualities.

Natural products are what are used in this initiatic Path, as they offer the greatest potential of energy storage and release.

Unlike qabalistic or Enochian magic, where energies are imagined and directed, here, the products to be charged are simply exposed to the planetary power during an astrologically favorable time, or simply unwrapped during the correct planetary hour, and allowed to absorb the energies in a gentle and natural fashion. It is no more complicated than dropping a sponge in a basin of water and allowing it to slowly absorb the water to its fullest capacity on its own.

Since sea salt and rainwater are used on each of the levels, three separate containers of each will be needed. If three sets of products are used for each level, then additional containers will be needed.

Charging the Products

The simplest and easiest manner to charge the products is using the planetary hours and their genius'. This manner takes several repetitions to insure maximum charging, however, it avoids the problem of astrological

timing during the year.

If you are unsure what a planetary hour or genius is refer to the *Fundamentals of Esoteric Knowledge* course material and look it up. In general however, each day is ruled by a planetary energy as previously described. It is in its purest power for a period of time immediately following sunrise. This period of time is known as an 'hour' however it represents a cyclic pulse of energy, and not a sixty minute hour. Depending on the time of year, the 'hour' could be as much as an hour and forty-five minutes or as little as forty minutes in terrestrial time.

Consult the course material for information on how to calculate the length of these 'hours', or *The Philosophers of Nature* website for a program download that will do it for you.

First Method: Using Planetary Genius'

On the first planetary hour of Saturn (immediately following sunrise) on the day of Saturn (Saturday) place your objects before you in your oratory. Your oratory should be illuminated by a single candle, and no electric lighting. The windows should be covered as well to prevent any light from entering.

For the first quarter of the planetary hour, or between ten and fifteen minutes have your mineral product in front of you. Seek to obtain an empty and receptive state of being. Attune yourself to the energy present, but do not invoke it or attempt to direct it in any manner. Seek only to experience it as it courses through your sanctum, charging the object in front of you.

Then, when sufficient time has passed, place the mineral product in a plastic bag, or wrap it in silk, and place the Water product in front of you. Repeat the process or receptivity. Continue with each of the following Air and Fire products for ten to fifteen minutes each. When all four products have been separately charged, they can be wrapped in the same silk or plastic bag, and stored away.

Once charged they should never be exposed to sun, moon, or electric light, and only handled by the persons or couple charging them. The process is then repeated on Sunday for the solar products, and Monday for the Lunar product.

It will take two to three months for a sufficient charge to build in each of the products. If you are charging three sets for each level, then they can be charged simultaneously. Once a product is used, it must not come in contact with charged products or it will draw off their energy.

Second Method: Zodiacal Configurations

Following the same method of passive charging, the products can also be loaded during astrologically favorable times of the year. This method has the advantage that it charges more quickly, but the disadvantage that it takes an entire year to do it, and if a cycle is missed, so is the opportunity for charging for that year.

Saturn products are charged after the winter solstice, around January 10th.

Solar products are charged thirty minutes after sunrise, with the moon under the horizon, forty days before or after the Winter Solstice. Solar products should not be loaded during the above mentioned time frame as the Air and Fire Elements are weak.

Elements are weak.

Lunar products are charged when the moon is above the horizon and within three day before or after the day between the head and the tail of the dragon. The sun must be under the horizon however.

Times to Avoid

The period of two weeks prior to and following the Winter Solstice is to be avoided for all Alchemical, Qabalistic work, or the charging of these products. Thus, we stock energies via astrology or planetary genius' when the energies are strong and easily available.

The Technique of Experiencing Eternity

The period of two prior to and following the Summer Solstice is the best time to attempt a "Contact with Eternity". Thus, as stated, several attempts can be made, so long as several sets of charged products have been prepared. The attempted contact can be made without such preparations, however, its effects may be more strongly felt, and period of weakness experienced for several weeks if the contact is successful and the supporting materials are not used.

On Friday Night, prior to the chosen Saturday, at midnight, light a candle in your oratory and contemplate your desire for a "Contact with Eternity".

On Saturday at sunrise, unwrap your Saturn products and place them in front of you. You may ingest the tincture is your desire, or dissolve a bit of the herb in water and drink it. Put a bit of the sea salt on your tongue and rinse it down with the filtered rainwater. You may even place a little of the salt in the water and put a drop or two on your forehead, as this is aimed at stimulating the true inner baptism. Be passive and receptive to the energies of the moment. If

Consult the course material for information on how to calculate the length of these 'hours', or The Philosophers of Nature website for a program download that will do it for you.

a strong shock or sudden uneasiness should overcome you, then wrap your products and end the session.

The feeling of uneasiness may come within a few days after the attempted contact, or a strong depression may be felt. If so, then the contact was established.

If several sets are being used, be sure to keep the discharged products away from the unused ones.

On Sunday about a half-hour after sunrise, with the sun above the horizon, light your candle and repeat the process with the Solar products. A cardiac response may be felt, along with a terrific love, even unto weeping, for humanity.

On Monday, the same pattern is repeated using the Lunar products. A strong intuition, memory, or knowledge may occur.

On the week following the contact, if it is successful, each of the days following offers unique opportunities: Mars gives strength to replace what was lost; Wednesday occult knowledge, of a more technical nature; Thursday gives wisdom of occult and religious organizations and philosophies; Friday assists in transferring the love of the heart to the world, and knowledge of the Seven Secondary Principles.

The contact can be attempted one week before and after the Summer Solstice, for a total of three contact periods offering maximum opportunity for success.

However, this is just a guideline, some have experienced the "Contact with Eternity" spontaneously as directed by their Inner Master. All we do is prepare ourselves, and present ourselves for initiation when the energies are most favorable. Several attempts may be needed for the contact to be successful, but once it has been, we can as Sendovious' the Pole wrote, "Burn all your books, including this one!"



RESOURCES:

References for laboratory equipment, supplies, and materials to support the efforts of researchers. Please inform us of new suppliers, and let us know if supplier addresses and phone numbers change. We do not list suppliers of medicines for internal use, for practical reasons.

Alchemical Resources

Al-Kemi - Alchemical & Spagyric Products

3107 W. Colorado Ave. #277

Colorado Springs, CO 80904

Tel: 1 (719) 685-5476 Fax: 1 (719) 685-5451

(Noon -- 10 PM MST) E-Mail: alchemi@pcisys.net

Glassware for alchemical work.

American Science and Surplus

3605 W. Howard St., Skokie, IL 60077 USA

Tel: 1 (847) 982-0874 Fax: 1 (800) 934.0722

<http://www.sciplus.com/>

Request catalog (available in USA and territories only).

Science & hobby kits, motors, electrical components, educational and office supplies, novelties and toys.

Bryant Laboratory, Inc.

1101 Fifth St., Berkeley, CA 94710 USA

Tel: 1 (510) 526-3141 or 1(800) 367-3141

Fax: 1 (510) 528-2948

Mail-order labware and chemicals.

Centaur Forge, Ltd.

117 North Spring St.,

PO Box 340, Burlington, WI 53105-0340 USA

Tel: 1 (414) 763-9175. Fax: 1 (414) 763-8350

Temperature crayons, forges, blacksmiths' supplies, such as tongs, aprons, etc.

David Shannon

6649 E. Rustic Drive, Mesa, AZ 85215 USA

Tel/Fax: 1 (602) 985-0557

Minerals by the specimen or in bulk.

Hagenow Laboratories

1302 Washington St., Manitowoc, WI 54220 USA

Tel: 1 (414) 683-3339

Bargain priced labware and supplies by mail-order.

Herbs

Dr. Michael's Herbs

5109 N. Western Ave., Chicago, IL 60625 USA

Tel: 1 (773) 271-7738

Books**Banton Press**

Mark Gordon Brown
Dippin Cottage
Isle of Arran, KA27 8SB, UK
*Handmade, perfect bound paperbacks of facsimile reprints;
20 alchemical titles, plus other topics.*

Chthonios Books

7 Tamarisk Steps
Hastings, TN34 3DN, England
Tel/fax 01424 433302
(+44 1424 433302 internationally)
*Scholarly titles from publishers worldwide which deal with
Esoteric Studies, and second-hand books.*

J.D. Holmes

PO Box 623
Edmonds, WA 98020 USA
Fax/Phone 1.206.771.2701
Series of inexpensive reprints of alchemical works.

Kessinger Publishing

P.O. Box 160, Kila, MT 59920 USA
Tel: 1 (406) 756-0167
Fax: 1 (406) 257-5051
Email: books@kessingerpub.com
<http://www.kessingerpub.com>
Over 1000 titles on Hermetic and Masonic topics

Phanes Press

P.O. Box 6114
Grand Rapids, MI 49516 USA
<http://www.phanes.com>
*Publishes & distributes books which relate to the spiritual
and philosophical traditions of the West.*

R.A.M.S.

Hans Nintzel
733 Melrose Drive,
Richardson, TX 75080 USA
Photocopies of translations of alchemical texts.

Todd Pratum Book Company

P.O. Box 985
Healdsburg, CA 95448 USA
Tel: 1 (707) 431-2634 Fax: 1 (707) 431-0575
*Specialist in Philosophy, History of Religions, Mythology,
and Metaphysics. Old, New & Rare.*

Newsletters**Caduceus: The Hermetic Quarterly**

Cinnabar, P.O. Box 95674, Seattle, WA 98145 USA.
*A quarterly journal of the Hermetic tradition. Subscription
prices are \$18 US per year within North America and \$25
US per year overseas; checks should be made payable to
Cinnabar.*

Cauda Pavonis: Studies in Hermeticism

Stanton J. Linden, Editor,
Cauda Pavonis, Dept. of English,
Washington State University,
Pullman, Washington 99164-5020 USA.
*Published twice each year, in the spring and fall. Now in
its fifteenth year, it publishes scholarly material on all
aspects of alchemy and Hermeticism and their influence on
literature, philosophy, art, religion, and the history of
science and medicine. Annual subscription cost is \$10.00
for individuals, \$12.00 for libraries and foreign subscri-
bers. Checks should be made payable to Cauda Pavonis;
foreign subscribers should pay by checks drawn on banks
with American branches.*

**Ambix, The Journal of the Society for the History of
Alchemy and Chemistry**

*Scholarly articles and reviews of books on all aspects of
the history of alchemy and chemistry, published in March,
July and November. The annual subscription to the Society
costs £20.00 (\$32). This should be sent to Dr. N.G. Coley,
24 Kayemoor Road, Sutton, Surrey, SM2 5HT, UK. Mem-
bers receive the current volume (3 parts) without further
payment. Most back issues are available at £15.00. For
non-members, libraries and institutions, the annual sub-
scription to Ambix is £38, and most back issues are avail-
able at £24. Orders for non-members should be sent to
Black Bear Press Ltd., King's Hedges Road, Cambridge
CB4 2PQ, UK.*

Internet**The Philosophers of Nature**

<http://www.mcs.net/~alchemy>
We maintain an updated resource list on our site.

The Alchemy Virtual Library

<http://www.levity.com/alchemy/>
Over 28 megabytes of information on alchemy in all its
facets organized by Adam McLean.

Dear Friend,

It is time again to remind you that memberships and subscriptions expire each year on December 31st. Unless you have already paid your membership fees or subscription for 1998, your services will expire at the end of next month. We know that some of you forgot to renew last year, and after missing one or two issues of *The Stone*, you remembered what happened.

We hope that you will take the time today to renew your membership or subscription services for 1998. We think that membership offers a lot in the coming year:

- While many organizations have increased their annual membership fees, often with a reduction in services, The Philosophers of Nature is pleased to announce that membership prices will remain the same for 1998.
- **The Stone**, our newsletter, will continue to have six issues in 1998. You can continue to receive the latest in news, articles and seminar announcements.
- The sale prices that we introduced for our courses earlier this year help make our unique teachings more affordable. For that reason, we are going to keep these reduced prices in effect until July, 1998. After that time we will know how well you like the new booklet format of the lessons, and we can review our lesson offerings.
- We will organize at least one major seminar in 1998. Look for the announcement in our March issue. Additional practical laboratory workshops will be organized and announced in our newsletter.
- Last week I received the first few pages of Jean's new course. We will keep you updated on the progress on this long-awaited work, and when it is complete, we will announce its availability. Look for it in *The Stone*.

There is more to come, and we hope that you will be a part of things, whether as a member or subscriber.

Please take the time to register now and you won't miss any exciting news.

With warm regards for you as you journey on the Path of Return,

ORA ET LABORAM!



Russ House

IMPORTANT Announcement!



Remember to
Renew
Your
Membership
to

P.O.N.

by December 31, 1997
to insure uninterrupted
receipt of

THE STONE