

Sacred Geometry and Numerology Tutorial

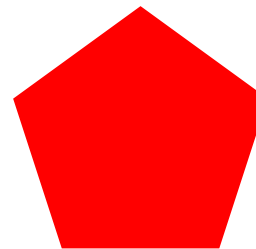
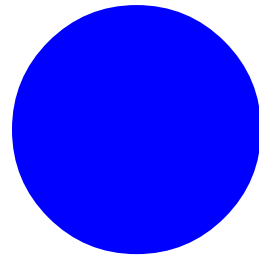

Moustafa Gadalla

Sacred Geometry and Numerology Tutorial

This is an introductory course to learn the fundamentals of sacred geometry and numerology, in its true and complete form, as practiced in the Egyptian traditions.

Moustafa Gadalla, P.E., P.L.S.

Registered professional engineer and land surveyor in the states of North Carolina, Pennsylvania, and Colorado, U.S.A.
Independent Egyptologist with 10 published books.

Table of Contents

1. Introduction	3	3. The Two Primary Numbers	7
<i>What is Sacred Geometry</i>		<i>Duality and Trinity</i>	
<i>The Tool</i>		<i>The Significance of Number 5</i>	
<i>General Layout of Sample Geometric Shapes</i>			
2. The Circle and the Square	5	4. The Summation Series and the Golden Proportion	9
<i>The Expanding Sacred Circle</i>		<i>Progression of Growth and Proportion</i>	
<i>The Ennead, The Nine Circles</i>		<i>Proportioning a Line According to the Golden Proportion</i>	
<i>Squaring the Circle</i>		<i>The Cosmic Proportion of the Human Figure</i>	
		5. The Generative Root Rectangles	13
		(so-called "Irrational Numbers")	
		<i>The Root Rectangles</i>	
		<i>The Cosmic Solids</i>	
		<i>The Root Five Rectangle and the Golden Proportion</i>	
		6. The Pentagon	17
		7. The (Whirling Squares) Spirals	20
		8. Examples of Sacred Geometry in Artwork	22
		9. The Harmonic Design Elements	24
		<i>General</i>	
		1. <i>The Active Axes</i>	
		2. <i>Significant Points</i>	
		3. <i>The Telescopic Triangles</i>	
		4. <i>The Rectangular Perimeters</i>	
		5. <i>The Vertical Plane</i>	
		Further Reading	27

1

Introduction

What is Sacred Geometry

Herodotus, the father of history and a native Greek, stated in 500 BCE:

Now, let me talk more of Egypt for it has a lot of admirable things and what one sees there is superior to any other country.

The Ancient Egyptian works, large or small, are admired by all, because they are proportionally harmonious and as such appeal to our inner as well as outer feelings. This harmonic design concept is popularly known as *sacred geometry*—where all figures can be drawn or created using a straight line (not even necessarily a ruler) and compass, i.e. without measurement (dependent on proportion only).

The principles of sacred geometry are of Ancient Egyptian origin, where the basis of harmonic proportions are evident in their temples, buildings, theology, ...etc. The Ancient Egyptian design followed these principles in well-detailed canons. Plato himself attested to the longevity of the Egyptian harmonic canon of harmonic proportion (sacred geometry), when he stated,

That the pictures and statues made ten thousand years ago, are in no one particular better or worse than what they now

make.

The harmony inherent in geometry was recognized in Ancient Egypt as the most cogent expression of a divine plan that underlies the world—a metaphysical plan that determines the physical. Geometry exists everywhere in nature: its order underlies the structure of all things, from molecules to galaxies. The nature of the geometric form allows its functioning. The design using the principles of sacred geometry must achieve the same goal, i.e. form to serve/represent a function.

Sacred geometry deals not only of the proportions of the geometrical figures, but of the harmonic relations of the parts to the whole, such as the parts of the human being with one another; the structure of plants and animals; the forms of crystals and natural objects, all of which are manifestations of the universal continuum.

The Tool

Since sacred geometry is based on harmonic proportion, the unit distance (length) can theoretically be any unit. The only needed tool is a cord consisting of 12 equally spaced distances. The unit distance can be small or large, so as to fit the required design of artwork on a canvas, statues, or laying out of buildings.



Temples and other buildings in Ancient Egypt were laid out in a religious ceremony. This laying out was performed by very knowledgeable people who are known by the Greek name, *harpedonaptae*.

The harpedonaptae are the people who strictly adhered to

the principles of sacred geometry (using only a straight line and a compass). Their cord was (and still is, in parts of present-day Egypt) a very special cord that consists of a 13-knotted rope with 12 equally-spaced distances of one Egyptian cubit (1.72' or 0.5236m).

Any equally-spaced 13-knotted cord is the basic tool used to establish various geometric shapes.

General Layout of Geometric Shapes

Triangles are the building blocks of any design.

The simplest formation is the equilateral triangle, which can be set out with the Egyptian rope knotted at twelve equal intervals and wound around three pegs, so that it formed three sides, each measuring four units.

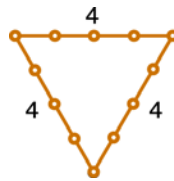

The line joining from any corner to the middle of the opposite side is its perpendicular.

However, the origin of the historic building layout was the setting out of the 3:4:5 triangle with the Egyptian rope, wound around three pegs so that it formed three sides measuring three, four, and five units, which provides a 90° angle between its 3 and 4 sides.

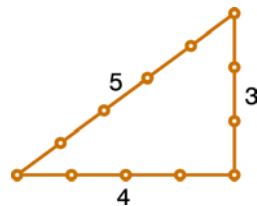

It was a relatively simple task to lay out rectangles and other more complex geometrical figures after establishing the 3:4:5 right-angle triangle.

A square **EBCF**, for example, can be established as shown herein:

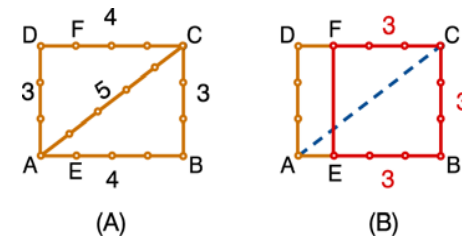

- (A) Construct two 3:4:5 triangles with a common diagonal **AC**.
- (B) Connect **FE** where **FC = EB = 3** units.

The Egyptian cord can be used as a compass to draw circular curves, as shown in the right diagram below.



Other shapes such as the 8:5 **Neb** (Golden) triangle or rectangle, as shown below, can also be established with the Egyptian cord.

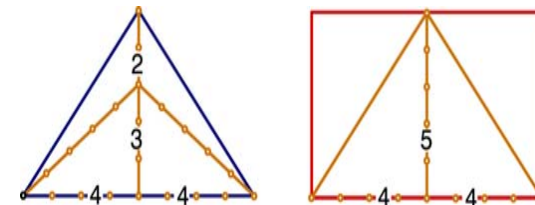

2

The Circle and The Square

The Expanding Sacred Circle

In Ancient Egypt, the cosmic creative force, **Ra** (Re), is written as a circle with a dot or point in the center. It is a circle moving in a circle—one and solitary. The circle symbolically represents the Absolute, or undifferentiated Unity.

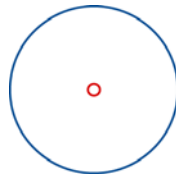

The sacred circle of **Ra** must expand from the center outwards, in order to create the space that results from the Big Bang. The expansion (and later contraction) of the universe is regulated by the Circle Index, i.e. the relationship between the diameter and the circumference of the circle.

The Circle Index is the functional representation of the circle. It is the ratio between the circumference of the circle to its diameter. It is popularized by Western academia with the Greek letter π (π) and given a value of 3.1415927.

The Circle Index and the **Neb** (Golden) Proportion were seen by the Ancient Egyptians not in numerical terms but as emblematic of the creative or generative function. One cannot just reduce a process/function to a meaningless, unmeasurable “value”, and then call it an “irrational number”. The Ancient Egyptians were not interested in abstract “number gymnastics”.

The Egyptians built their capitals with nine elements and occasionally with seven, in addition to 6, 8, 11, and 13-sided polygons, because they knew the properties of the circle and its relationship to perpendicular coordinates and other geometric figures.

The Ennead, The Nine Circles

In the Ancient Egyptian texts, the initial act of creation produced the Ennead (group of nine). The nine aspects of the Grand Ennead emanate from, and are circumscribed about, the Absolute. They are not a sequence, but a unity—interpenetrating, interacting, interlocked. They are the generator of all creation, as symbolized in **Heru** (Horus), who according to the *Leiden Papyrus*, Stanza No. 50, is:

the offspring of the nine-times-unity of neteru (gods, goddesses)

Heru (Horus) is also associated with the number five [as will be explained later]. Five is the number of the cosmic solids (polyhedrons): tetrahedron, cube, octahedron, dodecahedron, and icosahedron. These five solids are formed from within nine concentric circles, with each solid touching the sphere which circumscribes the next solid within it. These nine circles represent the nine—unity of the Ennead, the generator of all creation.

Squaring the Circle

In all Ancient Egyptian mathematical papyri, the area of a circle was obtained by squaring the circle. The diameter was

always represented as 9 cubits. The Ancient Egyptian papyri equate the 9 cubit diameter circle to a square with the sides of 8 cubits.

The mystical squaring of the circle represents the relationship between **Ra** (Re) and **Tehuti** (Thoth, Hermes).

The number 9, as the diameter, represents the Ennead, the group of 9 **neteru** (gods) who produced the ingredients of creation. The 9 are all aspects of **Ra**, the primeval cosmic creative force, whose symbol is/was the circle.

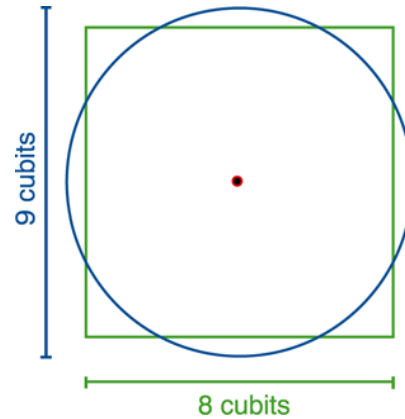

Eight is the number of **Tehuti**, and at **Khmunu** (Hermopolis), **Tehuti** (*Hermes* to the Greeks, *Mercury* to the Romans) is called the *Master of the City of Eight*. **Tehuti** gives man access to the mysteries of the manifested world, which were symbolized by the number 8. The manifestation of creation in 8 terms are present in all four Ancient Egyptian cosmological centers.

The underlying metaphysical patterns of the manifested universe are represented in the relationship of squaring the circle (**Ra** and **Tehuti** —conceived and manifested).

Tehuti transformed the creation concept (symbolized in a circle) into a physical and metaphysical reality. Such transformation is reflected in the Ancient Egyptian process of “squaring the circle”.

The area of a circle with 9 cubits as its diameter = 63.61725

The area of the squared circle with 8 cubits as its side = 64

The difference = 64 - 63.61725 = 0.38

Such a difference = 0.6%, which reflects the Ancient Egyptian consideration of a slight deviation in the manifested world from perfection.

A good example of this slight imperfection is the orbit of the earth around the sun, which follows an elliptical shape and not a perfect circle.

Musically, the ratio 8:9 is the Perfect Tone.

The ratio $8:9 = 2^3 : 3^2$. This is the perfect relationship between the reciprocals of 2 and 3 to their reciprocal powers of 3 and 2. The numbers 2 and 3 are the two primary cosmic numbers, as will be discussed next.

3

The Two Primary Numbers

Duality and Trinity

The two primary numbers in the universe are 2 and 3. All phenomena without exception are polar in nature, treble in principle. As such, the numbers 2 and 3 are the only primary numbers, from which other numbers are derived.

Two symbolizes the power of multiplicity—the female, mutable receptacle, while Three symbolizes the male. This was the *music of the spheres*—the universal harmonies played out between these two primal male and female universal symbols of **Ausar** (Osiris) and **Auset** (Isis), whose heavenly marriage produced the child, **Heru** (Horus). Plutarch confirmed this Egyptian wisdom in *Moralia Vol V*:

Three (Osiris) is the first perfect odd number: four is a square whose side is the even number two (Isis); but five (Horus) is in some ways like to its father, and in some ways like to its mother, being made up of three and two. And panta (all) is a derivative of pente (five), and they speak of counting as “numbering by fives”.

The significance of the two primary numbers 2 and 3 (as represented by **Auset** (Isis) and **Ausar** (Osiris)) was made very clear by Diodorus of Sicily [*Book I*, 11. 5],

These two neteru (gods), they hold, regulate the entire universe, giving both nourishment and increase to all things...

The numbers 2 and 3 are related to the natural breathing rhythm. When a person is in a quiet sleep, the time between expiration and inhalation is twice as long as that between inhalation and exhalation. It is the idea behind all musical forms. The in-and-out, the alternation of tension and relaxation, governs all further manifestations.

The multiplication of 2 (**Auset**) and of 3 (**Ausar**) gives us all the numbers for the tuning system by successive multiplication by fifths (2:3)—**Heru**. Also, practically all rhythmic organization is based on one of two general schemes: the *binary*—strong alternating with a weak beat, or *ternary*—strong followed by two weak beats. One or the other of these types underlies the rhythmic framework of every composition. The underlying binary or ternary rhythm is known as the *fundamental rhythm*. Subdivisions of these beats that appear within the general framework are called the *subsidiary rhythm*. [See *Egyptian Rhythm: The Heavenly Melodies*, by same author, for detailed information.]

Other applications of the two primary numbers will be shown throughout this text.

The Significance of Number 5

All phenomena without exception are polar in nature, and treble in principle. Therefore, five is the key to understanding the manifested universe, which Plutarch explained in the Egyptian context,

...And panta (all) is a derivative of pente (five)...

The significance and function of number five, in Ancient Egypt, is indicated by the manner in which it was written. The number five in Ancient Egypt was written as two **II** above three **III**, (or sometimes as a five-pointed star). In other words, number five (the son-**Heru**) is the result of the relationship between number two (the mother-**Auset**) and number three (the father-**Ausar**).



The Egyptian five-pointed star forms the corners of the pentagon, which is harmoniously inscribed in the Sacred Circle of **Ra**. The Star was the Egyptian symbol for both destiny and the number five.

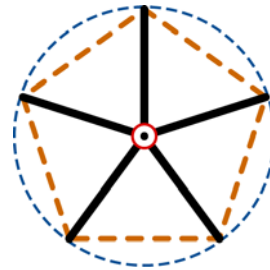

The Egyptian 5-pointed stars are found all over Ancient Egyptian tombs and temples, throughout its history.

[See the process of drawing the Ancient Egyptian five-pointed star (and consequently the pentagon) in chapter 6.]

4

The Summation Series and the Golden Proportion

Progression of Growth and Proportion

The key to divine harmonic proportion (sacred geometry) is the relationship between progression of growth and proportion. Harmonic proportion and progression are the essence of the created universe. Nature around us follows this harmonious relationship. The natural progression follows a series that is popularized in the West as the “*Fibonacci Series*”.

Since this series was in existence before Fibonacci (born in 1179 CE), it should not bear his name. Fibonacci himself and his Western commentators did not even claim that it was his “creation”. Let us call it as it is—a *Summation Series*. It is a progressive series, where you start with the two primary numbers in the Ancient Egyptian system, i.e. **2** and **3**. Then you add their total to the preceding number, and on and on—any figure is the sum of the two preceding ones. The series would therefore be:

2
3
5 (3 + 2)
8 (5 + 3)

13 (8 + 5)
21 (13 + 8)
34 (21 + 13)
55 (34 + 21)
89, 144, 233, 377, 610, . . .

The Summation Series is reflected throughout nature. The number of seeds in a sunflower, the petals of any flower, the arrangement of pine cones, the growth of a nautilus shell, etc—all follow the same pattern of these series. As will be shown later, even the construction of a spiral is nothing more than a simple adding process.

The Summation Series conforms perfectly with (and can be regarded as an expression of) Egyptian mathematics, which has been defined by everyone as an essentially additive procedure. This additive process is obvious in their reduction of multiplication and division to the same process: by breaking up higher multiples into a sum of consecutive duplications. It involves a process of doubling and adding. This progressive doubling lends itself to speedy calculation. It is significant that the methods used in modern calculators and computers are closely related to the Egyptian method.

Ancient Egyptian plans of temples and tombs, throughout the history of Ancient Egypt, show along their longitudinal axis (and transversely) dimensions in cubits (one cubit = 1.72' (0.523 m), giving in clear and consecutive terms the Summation Series 2, 3, 5, 8, 13, 21, 34, 55, 89, 144, 233, 377, 610, . . . This practice went as far back (at least) as the Pyramid (erroneously known as *mortuary*) Temple of **Khafra** (Chephren) at Giza, built in 2500 BCE (about 3,700 years before Fibonacci), which shows that the essential points of the temple comply with the Summation Series. [See analysis of this temple in *Pyramid Handbook* or *Egyptian Harmony: The Visual Music*, by same author.]

The Summation Series conforms with the Ancient Egyptian 13-knotted rope, which also reflects the pattern of the white and black keys on the keyboard. There are 8 white keys and 5 black keys. These black keys are in groups of 2's and 3's. As shown below from both figures, they both conform to the series 2:3:5:8:13, which is the beginning of the Summation Series.

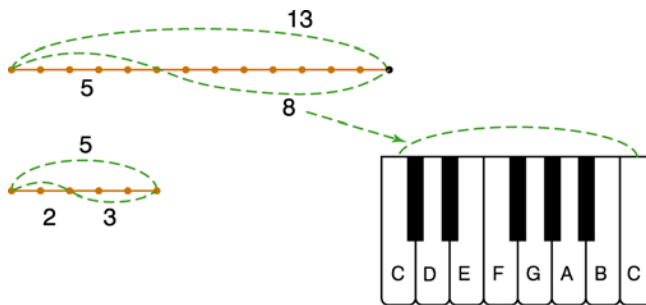

Summation Series on the Keyboard

This series was the origin of Ancient Egyptian harmonic design. It offers the true pulsation of natural growth. The ratio between each group of two consecutive numbers follows the pulsation:

$$\begin{aligned}
 3:2 &= 1.5 \\
 5:3 &= 1.667 \\
 8:5 &= 1.60 \\
 13:8 &= 1.625 \\
 21:13 &= 1.615 \\
 34:21 &= 1.619 \\
 55:34 &= 1.618 \\
 89:55 &= 1.618 \\
 144:89 &= 1.618 , \dots
 \end{aligned}$$

So, as the series progresses, the ratio between successive numbers tends towards the **Neb** (Golden) Proportion (which numerically = 1.618), to which Western academia has recently assigned an arbitrary symbol—the Greek alphabet letter ϕ (phi), even though it was known and used long before the Greeks. This proportion is also known in Western texts as *Golden* and *Divine*.

Western academia has even misrepresented the **Neb** (Golden) Proportion by calling it the *Golden Number*. A proportion is not a number, it is a relationship. Number implies the capacity to enumerate.

The term *Golden Section* did not come into use in Western texts until the 19th century. In most Western mathematical books and journals, the common symbol for the **Neb** (Golden) Proportion is *tau* (τ) instead of *phi* (ϕ)—presumably because *tau* is the initial letter of the Greek word for *section*.

The **Neb** (Golden) Proportion controls the proportions of innumerable living organisms, which are manifested in the logarithmic/equal angle spirals. More about spirals later.

• • •

The Egyptians knew and used the Summation Series at least 4,500 years ago—as well as its derivative, the **Neb** (Golden) Proportion. This knowledge was also reflected in the proportion of human figuration, as incorporated into their artwork. Ancient Egyptians followed a precise canon of proportion, which Plato attested to its remoteness of age:

That the pictures and statues made ten thousand years ago, are in no one particular better or worse than what they now make.

Proportioning a Line According to the Golden Proportion

To proportion a line (say **AB**) according to the **Neb** (Golden) Proportion, establish **BC** = 1/2 of **AB** and perpendicular to it.

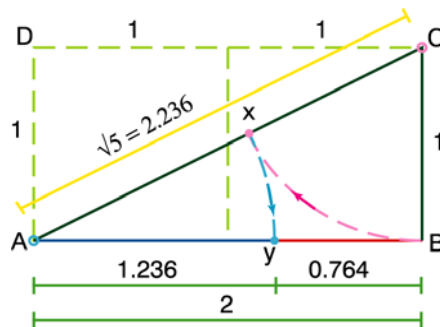

- Draw diagonal **AC**, which is equal to the square root of the sum of the square of the distance **BC** and **AB**:

$$\sqrt{[(BC)^2 + (AB)^2]} = \sqrt{(1+4)} = \sqrt{5}$$

- Set on corner **C** with an arc = **CB**, find the point **x**
The line **Cx** = 1
Therefore **Ax** = (2.236 - 1) = 1.236
- Set on **A** as a center, with a radius **Ax**, draw an arc to **y**.

$$Ay = Ax = 1.236$$

$$yB = (AB - Ay) = (2 - 1.236) = 0.764$$

The ratio $1.236 / 0.764 = 1.618 =$ The **Neb** (Golden) Section/Proportion (**N**)

This proportioning explains the uniquely reciprocal relationship between two unequal parts of a whole, in which the small part stands in the same proportion to the large part as the

large part stands to the whole—such is the formula for the **Neb** (Golden) Section/Proportion.

The two parts of the Golden Section are often referred to as a minor and a major.

The Cosmic Proportion of the Human Figure

The Ancient Egyptian canon for the harmonic proportion of human figures differed only between children and adults. The differences were reflective of the actual physical differences at these two stages. At birth, it is the *navel* that divides the height of child into two halves. Upon maturation (reaching puberty), the junction of both legs (reproductive organs) is at mid-height of the adult figure. The position of the navel now divides the height into unequal parts that make the parts and the whole in compliance with the **Neb** (Golden) Proportion.

The oldest discovered records from the 5th Dynasty show that the highest defined point along the vertical axis is the hair-line of the person's head, when presented in the earthly realm.

Egyptian figurations carefully mark—with a headband, crown, diadem, or joint—a dividing line for the top of the skull of the earthly man, thus separating the crown of the skull. The height of the body was measured exclusive of the crown.

The representation of the *neteru* (gods/goddesses) and/or human beings *in the afterlife* are shown on an 18-square grid, for the full height to the top of the head (i.e. including the crown of the head).

The difference in the height between the two realms reflects the Ancient Egyptian deep understanding of the physiology and role of humans on earth.

The removal of this part of the human brain (the crown of the head) leaves man alive, but without discernment, hence with no *personal* judgement. The person is in a vegetative state, i.e. living and acting only as the executant of an impulse that he receives, without actual choice. It is like a person in a coma.

The navel is located about 11.1 grid squares from the bottom of the heel on the 18-square grid system (or the same equivalent ratio 0.618 for grid or non-grid systems). Such division follows the laws of harmony between the two parts themselves, and the parts to the whole, as per the following two relationships:

1. The ratio between the Two (top and lower) Parts of the divine height (18 grid squares) are harmonic.

Top	:	Lower	is	0.618
Lower	:	Top	is	1.618

2. Between the Two Parts to the whole Unity (divine height)—taking the full height (to the hairline of the earthly man's head) as 1—the body from the feet to the navel, in the Egyptian canon—is equal to the reciprocal of the **Neb** (Golden) Proportion ($1/N$), i.e. 0.618. The portion from the navel to the hairline of the head equals the power 2 of the reciprocal of the **Neb** (Golden) Proportion ($1/N^2$), i.e. 0.382.

$$\frac{1}{N} + \frac{1}{N^2} = 1$$

$$0.618 + 0.382 = 1$$

where N = the **Neb** (Golden) Proportion (1.618)

Because of the intimate relationship between the Summation Series and the **Neb** (Golden) proportion, we find that the different parts of the figure also follows the Summation Series [as shown above].

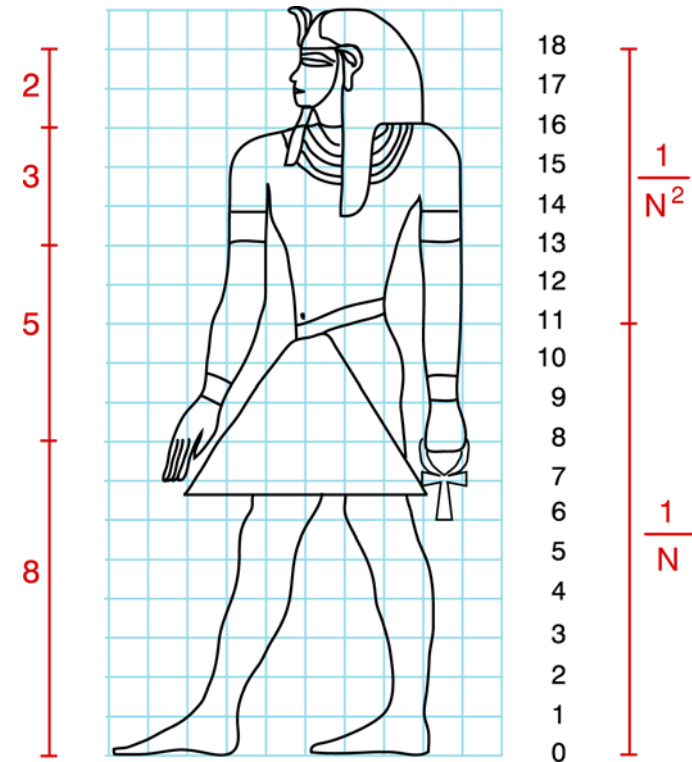

Human Figuration On an Original Ancient Egyptian Grid from KV22 of Amen-hotep III



The Generative Root Rectangles (so-called "Irrational Numbers")

The Root Rectangles

The role of a root in a plant is the same exact role/function as that of the root in geometry. The root of a plant assimilates, generates, and transforms energies to the rest of the plant.

Likewise, the geometric root is an archetypal expression of the assimilative, generating, transformative function and process, whereas fixed whole numbers are the structures that emerge to build upon these principles of process.

As stated earlier, the concept of creation was manifested in the act of squaring the sacred circle of Ra.

The square is the basic geometric shape from which all root rectangles can be generated.

The diagonals serve as the generators of root rectangles. When we start with a square whose side is one, the diagonal is $\sqrt{2}$. From the square root of two, other root rectangles are produced directly by simply drawing with compasses, i.e. applying

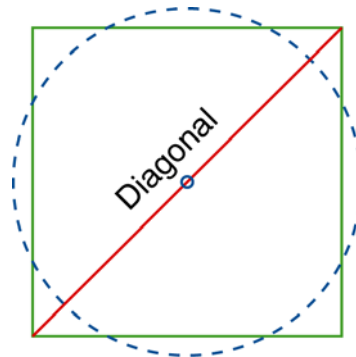

sacred geometry—producing without measurement—by using squares and rectangles and their diagonals.

The Ancient Egyptians were able to obtain root rectangles without measurements through various ways such as:

- Start with a square whose side is unity.
- The $\sqrt{2}$ rectangle is produced from the square by setting the compass at the length of the diagonal and producing the base line to meet it. This makes the length of the long side equal to the square root of 2, taking the short side as unity.

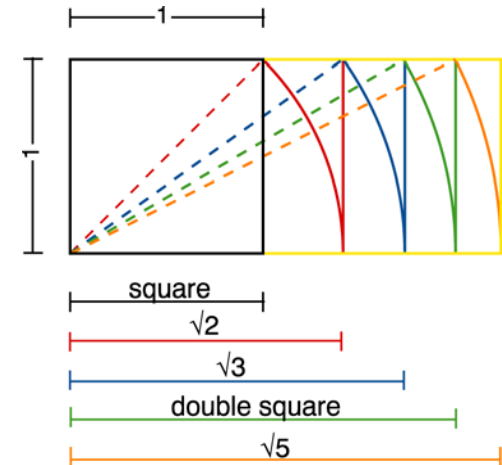

- The $\sqrt{3}$ rectangle is produced from the diagonal of the $\sqrt{2}$ rectangle.
- The $\sqrt{4}$ rectangle (double square) is produced from the diagonal of the $\sqrt{3}$ rectangle.
- The $\sqrt{5}$ rectangle is produced from the double square rectangle.



From a double square, all three sacred square roots can also be obtained, as shown herein:

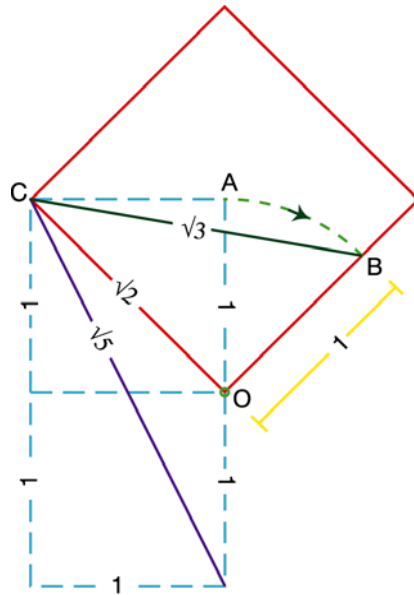

$\sqrt{2}$ is the diagonal of a square.

$\sqrt{3}$ is obtained from the $\sqrt{2}$ square by setting on point O and drawing an arc with a radius = the side of the original square (OA), at point A, to meet the side of the $\sqrt{2}$ square at B.

In the right angle triangle COB, the hypotenuse CB = the square root of $[(\sqrt{2})^2 + (1)^2] = [\sqrt{(2+1)}] = \sqrt{3}$

$\sqrt{5}$ is the diagonal of a double square.

• • •

- A double square [1 : 2 rectangle] could be obtained from two intersecting circles, each's circumference passes through the center of the other circle.
- The three sacred square roots are shown herein:

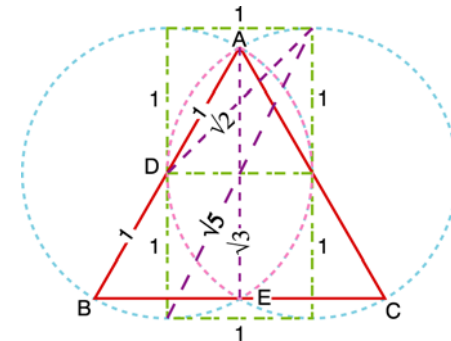

In the red equilateral triangle ABC, the perpendicular line $AE = \sqrt{3}$, since the base = 1 and the hypotenuse = 2. As such, a hexagon could be drawn by utilizing AD and DE as two sides of the hexagon that can be drawn on the right circle on the right side. Two of the remaining four sides can be drawn from A and E with an arc = $AD = ED$, to points C and F.

From point F as a center, draw an arc with the same length of the hexagon side, to intersect the circle at point G—the sixth point on the hexagon.

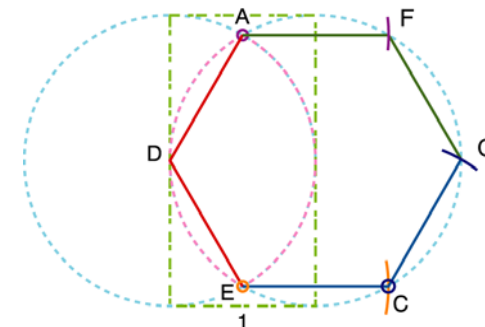

- Within a square on the wall or on the ground, the Ancient Egyptians were able to obtain root rectangles. In the square shown below, a diagonal is drawn from **O** to **C**. From corner **O**, an arc is drawn between **A** and **B**.

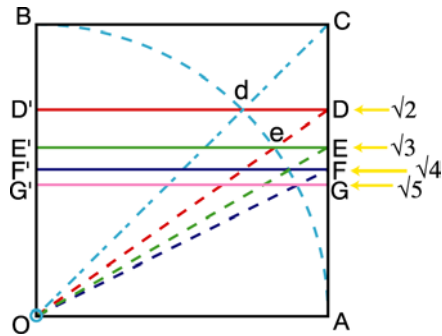

- **Arc AB** and **diagonal OC** intersect at point **d**. The horizontal line **dD** determines the $\sqrt{2}$ line. Thus, **D'DAO** is the $\sqrt{2}$ rectangle.
- A line from **O** is **extended to D**. The intersection (**e**) of this new **diagonal OD** with the **AB arc** determines the location for $\sqrt{3}$, by the horizontal line **eE**. Thus, **E'EAO** is the $\sqrt{3}$ rectangle.
- From the intersection of **OE** with the **arc AB** at point **e**, we can determine the $\sqrt{4}$ line, i.e. the double-square **F'FAO**.
- By following the same procedures, we can obtain $\sqrt{5}$. Thus, **G'GAO** is the $\sqrt{5}$ rectangle.

• • •

Design that is based on root rectangles is called generative dynamic design, which only the Egyptians practiced. Egyptian sacred objects and buildings have geometries based

upon the division of space attained by the root rectangles and their derivatives, such as the **Neb** (Golden) Proportion, as will be shown throughout this book.

The Cosmic Solids

From the roots of Two, Three, and Five, all harmonic proportions and relationships can be derived. The interplay of these proportions and relations commands the forms of all matter—organic and inorganic—and all processes and sequences of growth.

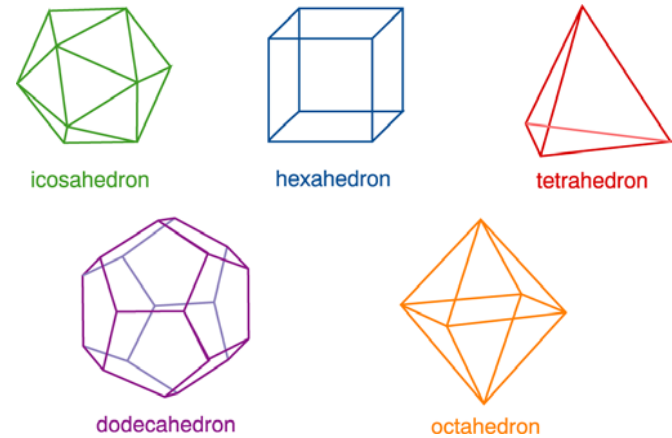

The three sacred roots are all that are necessary for the formation of the five cosmic solids [shown above], which are the basis for all volumetric forms (where all edges and all interior angles are equal). The manifestation of these five volumes are generated from the Egyptian Ennead.

The Root Five Rectangle and the Golden Proportion

The $\sqrt{5}$ rectangle is obtained from the double square. The diagonal of the 1:2 rectangle is $\sqrt{5}$.

To find the relationship between the root five rectangle and the Golden Proportion (N), begin from a basic square (the manifested universe), such as DAIJ.

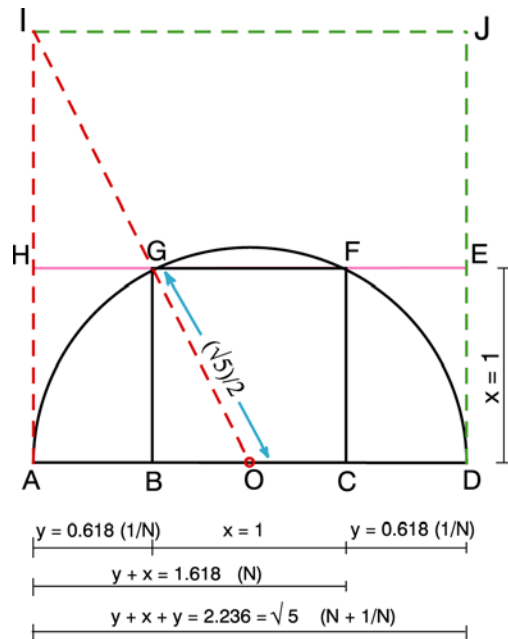

- Find the midpoint (O) between edges A and D.
- Draw a semi-circle from center O with a radius OA.
- From the intersecting point G, establish the square GBCF.
- Extend GF to H and E. The rectangle ADEH is a root five rectangle that contains two combinations:

1. Two reciprocal **Neb** (Golden) rectangles: **ACFH** (1 x 1.618) and **CDEF** (1 x 0.618).
2. A square (**BCFG**) plus two lateral **Neb** (Golden) rectangles. **ABGH** and **CDEF**—each is proportioned 1:0.618 (which is equal to 1.618—the Golden Proportion).

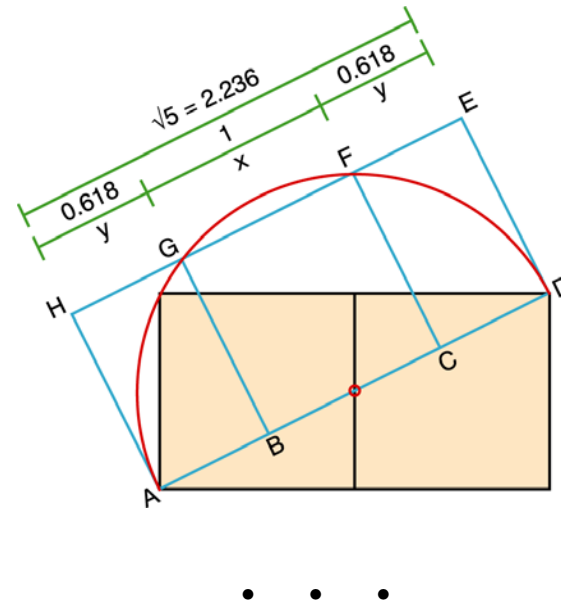

The inscribed square in the upper half of the circle represents the physical manifestation of the world. The resultant proportions were essential parts of the Ancient Egyptian design, as will be shown throughout this text.

Regarding the relationship between the square root of 5 and the five-sided pentagon, see next chapter.

6

The Pentagon

The significance of the number 5 has been addressed in previous chapters.

To demonstrate the relationship between $\sqrt{5}$ and both the number 5 (as the square of $\sqrt{5}$) and with the fivefold symmetry of the pentagon, complete the geometric diagrams below.

- The square is the manifested universe. Begin with a **square** where the length of its side is equal to 2 units.
- Since the vertices of the pentagon are inscribed within a circle, inscribe a **circle** within the framework of the **square**.
- Divide the **square** into two halves and draw the **diagonal** from **point A to corner F**, so that it passes through the line between the two squares, at point **x**.
- With center **x** and radius **xA** $[(\sqrt{5})/2]$ swing an **arc** to **y**.
- With center **A** and radius **Ay** swing an **arc** to cut the circle at **B** and **E**.
- With centers **B** and **E**, and compass unchanged, swing two more arcs cutting the circle at **C** and **D**.
- Draw pentagon **ABCDE**.

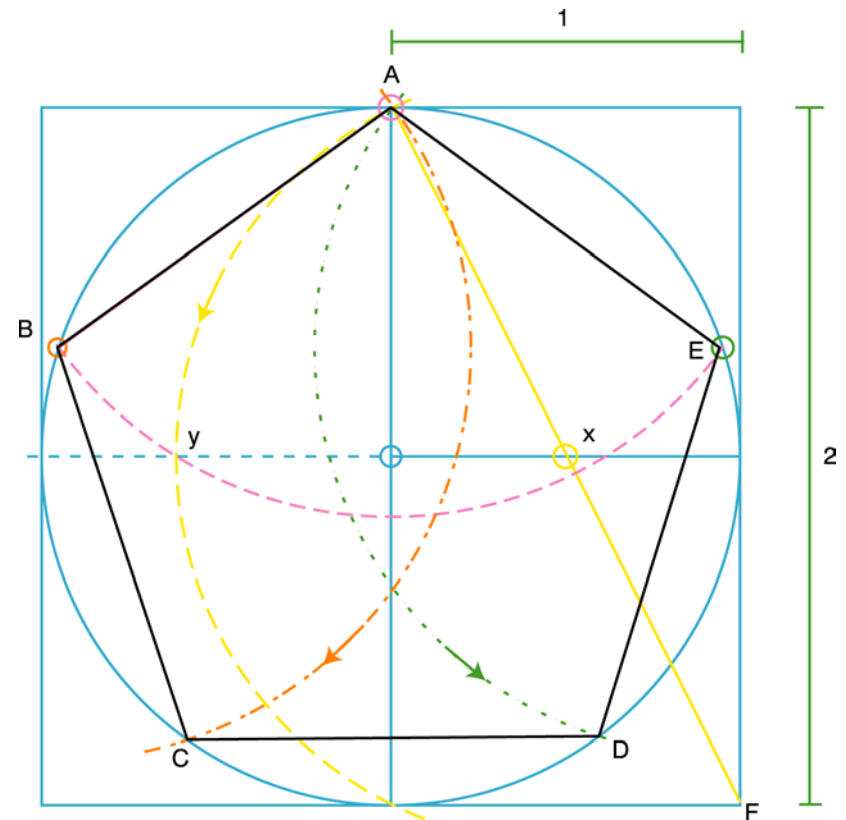

The Relationship of Phi (ϕ) to $\sqrt{5}$ and the Pentagon

- Establish a square within a semicircle [see page 17].
- Set on **C** and swing an arc with a radius = **CB**. Set on **D** with the same arc radius, swing an arc. The two arcs from **C** and **D** will meet at **K**—another point on the pentagon.

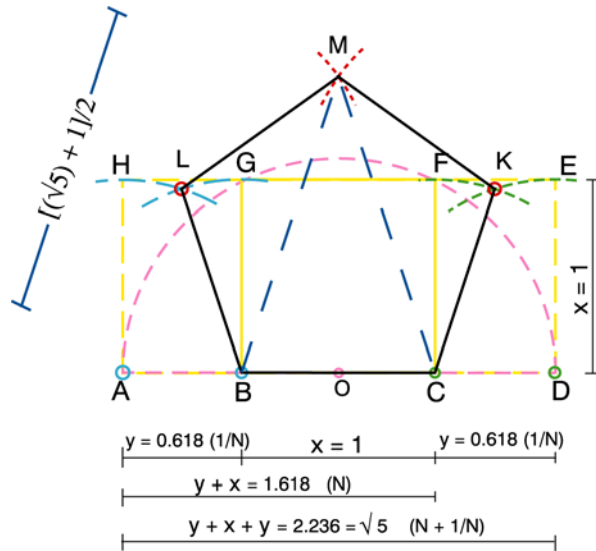

- Repeat the same process above at points **A** and **B**, to find **L**—another point on the pentagon.
- To find the last point on the pentagon (**M**), set on **L** with a radius = **LB** and draw an arc. Repeat the same process from **K**. The two arcs from **L** and **K** will meet at **M**.

It should be noted that the side of a pentagon is in relation to its diagonal as $1 : [(\sqrt{5}) + 1] / 2$ or $1 : N$, the Golden Section.

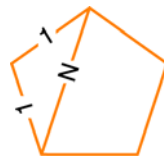

It should also be noted that this figure coincides with **Ptah**. Such symbols (the square and half circle) are two of the hieroglyphic symbols in **Ptah's** name.

The three symbols of **Ptah's** name in hieroglyphs consists of: the square **P**, the half circle **T**, and a three-looped/knotted/united rope **H**. The symbols are shown below, separately and together (superimposed) as one unit.



The superimposition of all three symbols shows the outline of the 5-pointed Egyptian star, and henceforth the pentagon, which brings to mind Plutarch's explanation of the Egyptian context:

...And panta (all) is a derivative of pente (five)...

In Ancient Egypt, **Ptah** is/was the Cosmic Architect, the cosmic shaping force, the giver of form (smith). He is/was the patron of crafts, trades, and the arts. He is/was the coagulating, creative fire. His job is to give form to the words of **Ra** as spoken by **Tehuti** (Thoth), according to the Laws of balance and equilibrium (**Ma-at**). Therefore, **Ptah** sits enthroned or stands upon a pedestal that is in the form of the glyph for **Ma-at** (cosmic law, harmony, equilibrium).

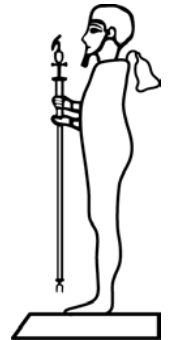

7

The (Whirling Squares) Spirals

The spiral in nature is the result of continued proportional growth. This type of spiral is known mathematically as the *constant angle* or *logarithmic spiral*. Logarithmic expansion is the basis for the geometry of spirals. The fetus of man and animals, which are the manifestation of the generation laws, are shaped like the logarithmic spiral. Manifestations of spirals are evident in vegetable and shell growth, spider webs, the horn of the dall sheep, the trajectory of many subatomic particles, the nuclear force of atoms, the double helix of DNA, and most of all, in many of the galaxies. Patterns in the mental realm, as well, are also generated in spiraling motions.



The logarithmic spiral is the product of the combined effect of addition and multiplication, which is a progressive addition, just like the Summation (Fibonacci) Series (2, 3, 5, 8, 13, 21, 34...). As will be shown below, the progression of the spiral curve maintains the same ratio/proportion rhythm of the **Neb** (Golden) Proportion. The sides of each golden rectangle maintain the ratio between the sides of each added rectangle to the constant ratio of the **Neb** (Golden) Proportion (the more things change, the more they stay the same).

Logarithmic spirals are characterized by the golden section properties. A logarithmic spiral is formed by progressive addi-

tion, by means of “whirling squares”, consisting of squares and **Neb** (Golden) rectangles growing in harmonic progression from center **A** outward. Each consecutive stage of growth is encompassed by a **Neb** (Golden) rectangle that is by a square larger than the previous one. In other words, the progression of the **Neb** (Golden) Proportion yields the whirling squares.

You start with a square $ABCD$. Then you add the **Neb** (Golden) rectangle $EFBA$, as shown below.

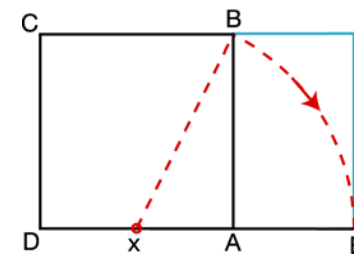

- Find the mid-point in DA (i.e. point x).
- Set on point x and draw an **arc** with a radius of xB , to point E .
- The **Neb** (Golden) rectangle $EFBA$ is formed.

It should be noted how the two diagonals (DF and BE) are always perpendicular between the smaller and larger **Neb** (Golden) rectangles. It is therefore that the spiral is called a *right angle spiral*. It should be noted that the ratio between the two sides (here EF and DE) corresponds with the Golden Proportion (1.618).

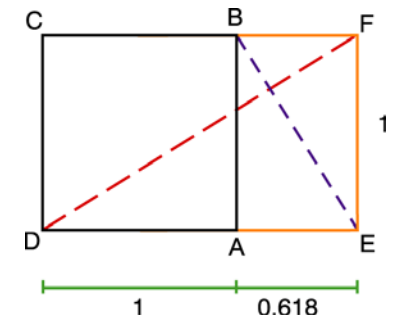

Continue the same process, as indicated below.

squares	+ Neb (Golden) rectangles	= Neb (Golden) rectangles
A B C D	+ E F B A	= E F C D
H E D G	+ E F C D	= H F C G
I J F H	+ H F C G	= I J C G
J K L C	+ I J C G	= I K L G etc.

Logarithmic spirals can also be built by whirling triangles that make use of an isosceles triangle that has a top angle of 36°, i.e. by dividing the circle into 10 divisions.

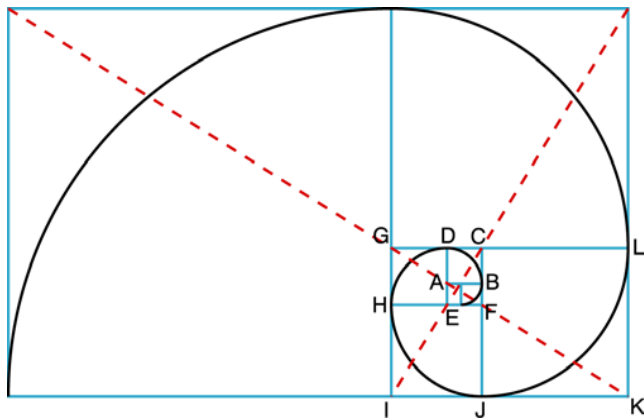

**A logarithmic spiral indicated by
“whirling squares”**

Since logarithmic spirals follow the same process as the Summation Series, they are subsequently characterized by the **Neb** (Golden) Proportion. The two dashed diagonals (like all diagonals of the compounded **Neb** rectangle) are in **Neb** (Golden) ratio to each other (1.618).



8

Examples of Sacred Geometry in Artwork

The Ancient Egyptian framework was usually a square, representing the manifested world (squaring of the circle). Additionally, the square grid itself had the symbolic meaning of the manifested world, which also made it easy to construct the root rectangles of 2, 3, and 5, on/by the square(s) background.

The corners of squares and root rectangles were defined by notches along the perimeter, or carefully defined by incised lines.

Following are a few examples of the generative dynamic design layout:

1. A simple theme in the square root of two ($\sqrt{2}$) is exhibited in the figure below of the *netert* (goddess) **Nut**, the personification of the sky as matrix of all.

The spaces between the bars on either side of the figure were filled with hieroglyphic writing [removed here in order to show the geometric outlines].

- ABCD is a square.
- The diagonal $BD = \sqrt{2}$
- Point E was determined so that $BE = BD = \sqrt{2}$

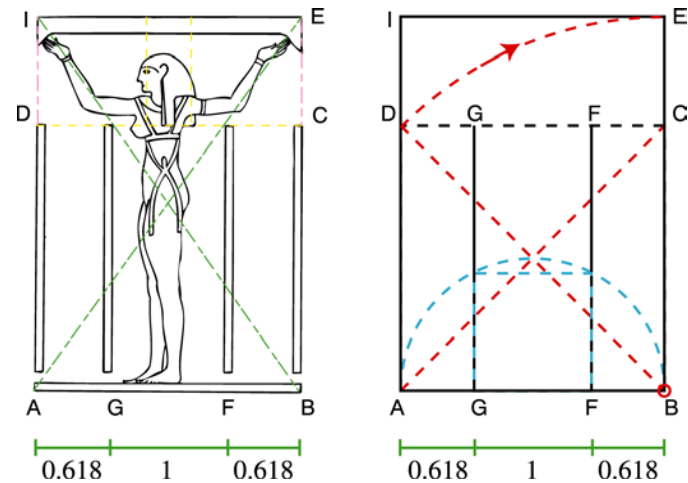

- Lines GG and FF were located based on the principle of inscribing a square into a half circle. [See similar diagram, next page.]
- The center of action is the **hip joint** of Nut.

2. Here we have a square that is defined by bars cut into the stone at the top and bottom of the composition. The area is dynamically divided for a pictorial composition. The plan of this arrangement is depicted below.

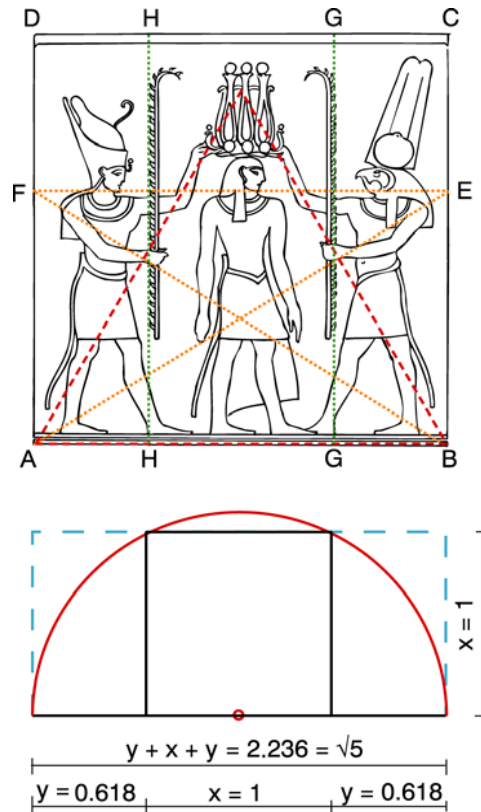

- ABCD is a square.
- A root-five rectangle was used in the center of a square, to determine the vertical lines GG and HH.
- The horizontal line EF forms a Neb (Golden) rectangle ABEF.

3. The Egyptian bas-relief composition [shown below] is similar to the previous example. The outlines of the major square are carefully incised into the stone by four bars, two of which have slight pointed projections on either end.

The following are just a few highlights of the design layout:

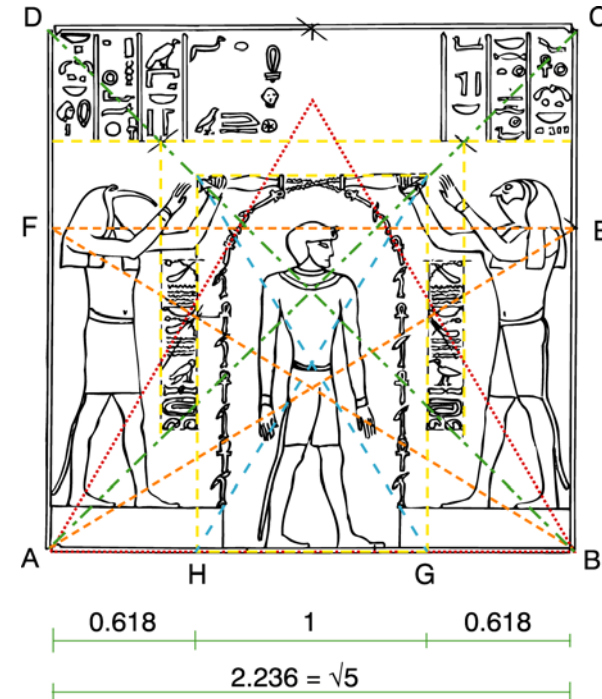

- Its designer proportioned the picture, as well as the groups of hieroglyphs, by the application of whirling square rectangles to a square.
- A root-five rectangle was used in the center of a square, to determine the vertical lines at points G and H.
- The horizontal line EF forms a Neb (Golden) rectangle ABEF.

9

The Harmonic Design Elements

General

Proportion is the commensuration of the various constituent parts with the whole. The human body is a prime example of such harmonic proportion, where the human frame has been formed with such propriety that the several members are commensurate with the whole. [See page 13.]

Harmonic design in Ancient Egyptian architecture was achieved through a unification of two systems:

- arithmetic (significant numbers).
- graphic (square, rectangles, and a few triangles).

The union of the two systems reflects the relationship of the parts to the whole, which is the essence of harmonic design.

This union of arithmetic and graphic design follows the five elements described below.

1. The Active Axes

An axis is an imaginary and ideal line about which a moving body revolves. In geometry, an axis is equally imaginary—a line without thickness.

The Egyptian temple was regarded as an organic, living unity. It is in constant motion; its intricate alignments, and its multiple asymmetries, make it oscillate about its axes.

Ancient Egyptian architectural design is conspicuous for its strong apparent symmetry around a longitudinal axis (just like the human body). This is the result of the Ancient Egyptian knowledge of cosmic laws. The Egyptian designer reflected this slight cosmic asymmetry, by ensuring that elements on either side of the axis are not exactly identical to one another. While most of them are balanced, elements are not symmetrical.

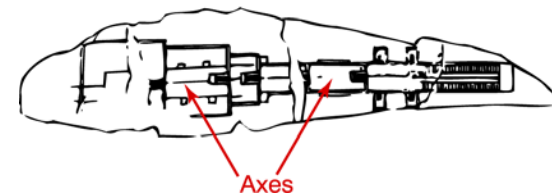
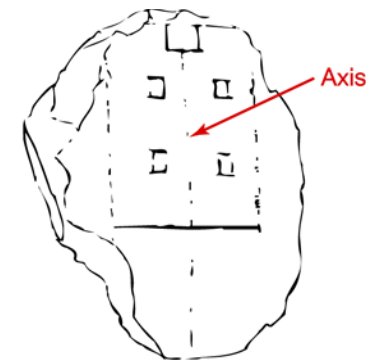

Two examples of axes defined on Ancient Egyptian drawings

The axis line can be found in a few recovered architectural drawings or sketches on papyri and tablets from various periods.

In the buildings themselves, the axis is marked by an engraved line on the stones of the upper course of a foundation slab, such as the case at Luxor Temple.

2. Significant Points (Along the Axis)

Significant points were determined along the design axis. These points mark the intersection with transverse axes, the alignment of a central doorway, the position of an altar, the center of the sanctuary, etc. These significant points follow a precise arithmetic progression. In many of the best plans, these significant points are at harmonic distances from one another, and their distances from one end to the other express the figures of the Summation (so-called *Fibonacci*) Series, 3, 5, 8, 13, 21, 34, 55, 89, 144, 233, 377, 610, . . . The harmonic analysis shows a series of significant points readable from both ends, i.e. if inverted, a system of significant points would also correspond to the Series with the reference point starting at the opposite end of the plan.

High numbers of the Summation Series were crystallized in the Egyptian monuments ever since the Old Kingdom. For example, the design of the pyramid temple of *Khafra* (Chephren) reaches the figure of 233 cubits in its total length, as measured from the pyramid, which comprises a series of TEN significant points.

The Karnak Temple [see opposite page for partial layout] follows the Summation Series' figures up to 610 cubits, i.e. TWELVE significant points.

3. The Telescopic Triangles

The typical Egyptian temple plan increases in width and height from the sanctuary towards the front. This overall delimitation was based upon a "telescopic system" of design that was used since at least the Old Kingdom. The increase in width was accomplished by the use of consecutive 1:2, 1:4, and 1:8 triangles from one or more significant point(s).

[See diagram of Karnak Temple (partial) on the opposite page.]

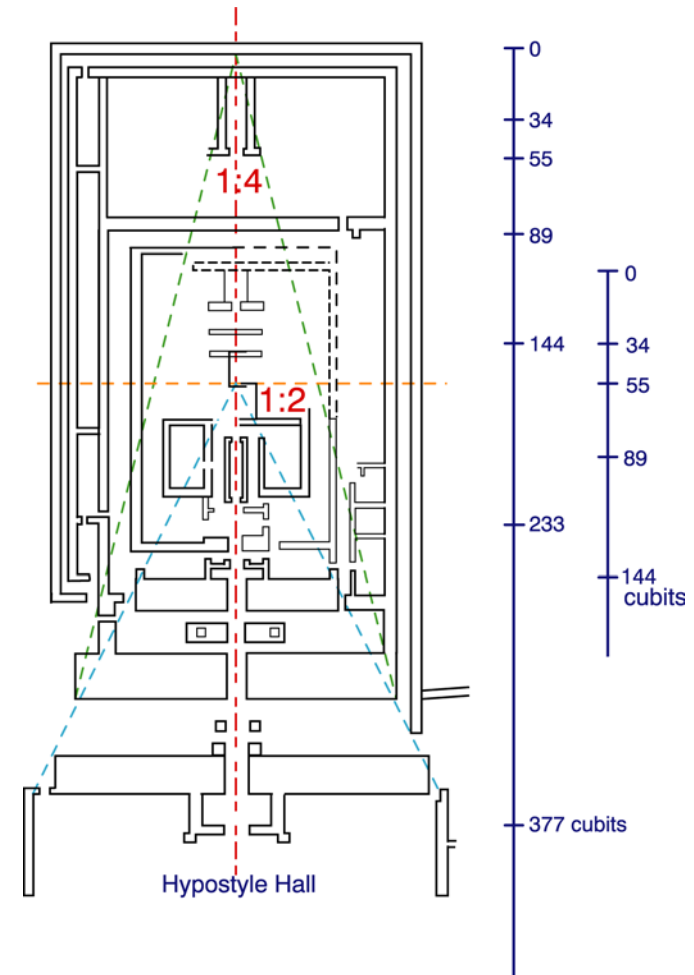

Typical Telescopic Triangles in Ancient Egyptian Design at the Karnak Temples

4. The Rectangular Perimeters

The general horizontal and vertical outlines are basically rectangular in shape, for the overall plan as well as its constituent parts. Different configurations were used, such as:

- A simple square.
- A double square or 1:2 rectangle.
- The **Neb** (Golden) Rectangle.
- Root Rectangles.

5. The Vertical Plane

Harmonic proportion was applied by the Ancient Egyptians in all three dimensions, such as:

- The pyramids (square bases and triangle volume).
- The striking case of the King's Room in **Khufu** (Cheops) Pyramid, which affords exact relations for the great diagonal in space with respect to the dimension of the side.
- Pylons, doorways/portals/gates.
- Vertical heights, which followed the same proportional increase as horizontal widths, as additions were made to the fronts of monuments. This aspect is characteristic of the Egyptian temples.

An example of design in the vertical plane is the typical Ancient Egyptian doorway layout, which incorporated both sacred ratios—the circle index (π) and the **Neb** (Golden) Proportion (ϕ)—in its harmonic design.

Points of interesting harmonic proportions include:

- The overall outline in the vertical plane is the double-square, 1:2 ratio. [$H = 2B$]

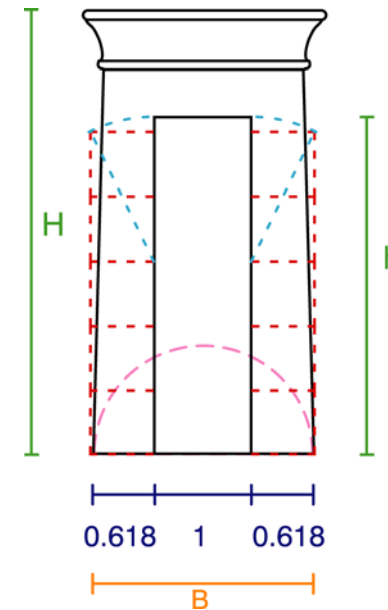

- The opening width is based on a square inscribed within a semi-circle, the typical Ancient Egyptian way of proportioning a root-five rectangle. Thus, the thickness of the doorjamb is 0.618 the width of the opening.
- The height of the aperture (h) = $1.2(1.618)^2 = 3.1415$, i.e. the circle index (π).

Further Reading

Egyptian Harmony: The Visual Music

ISBN: 0-9652509-8-9 (pbk.), 192 pages, US\$11.95

eBook: 1-931446-08-3, 192 pages, US\$7.95

This book reveals the Ancient Egyptian knowledge of harmonic proportion, sacred geometry, and number mysticism, as manifested in their texts, temples, tombs, art, hieroglyphs, etc, throughout their known history. It shows how the Egyptians designed their buildings to generate cosmic energy, and the mystical application of numbers in Egyptian works. The book explains in detail the harmonic proportion of about 20 Ancient Egyptian buildings throughout its recorded history.

Pyramid Handbook - Second Edition

ISBN: 0-9652509-4-6 (pbk.), 192 pages, US\$11.95

eBook: 1-931446-11-3, 192 pages, US\$7.95

A complete handbook about the pyramids of Ancient Egypt during the Pyramid Age; the sacred geometry that was incorporated into the design of the pyramids; the locations and dimensions of interiors and exteriors of the pyramids; the history and builders of the pyramids; theories of construction; theories on their purpose and function; and much, much more.

Egypt: A Practical Guide

ISBN: 0-9652509-3-0 (pbk.), 256 pages, US\$8.50

eBook: 1-931446-13-X, 256 pages, US\$5.95

Quick, easy, and comprehensive reference to sites of antiquities. Detailed plans and descriptions of all major temples and tombs in Ancient Egypt. Find your way with numerous maps and illustrations.

OTHER BOOKS BY THE AUTHOR

Egyptian Mystics: Seekers of the Way

Egyptian Cosmology: The Animated Universe - 2nd ed.

Egyptian Divinities: The All Who Are THE ONE

Historical Deception: The Untold Story of Ancient Egypt - 2nd ed.

Egyptian Rhythm: The Heavenly Melodies

Exiled Egyptians: The Heart of Africa

Tut-Ankh-Amen: The Living Image of the Lord