

Centro de Estudios
de la
Regla Conga

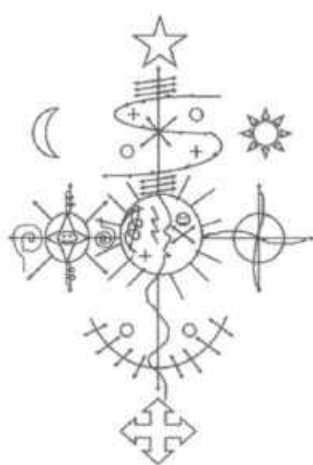

Libreta de Aso
de
Patipembas

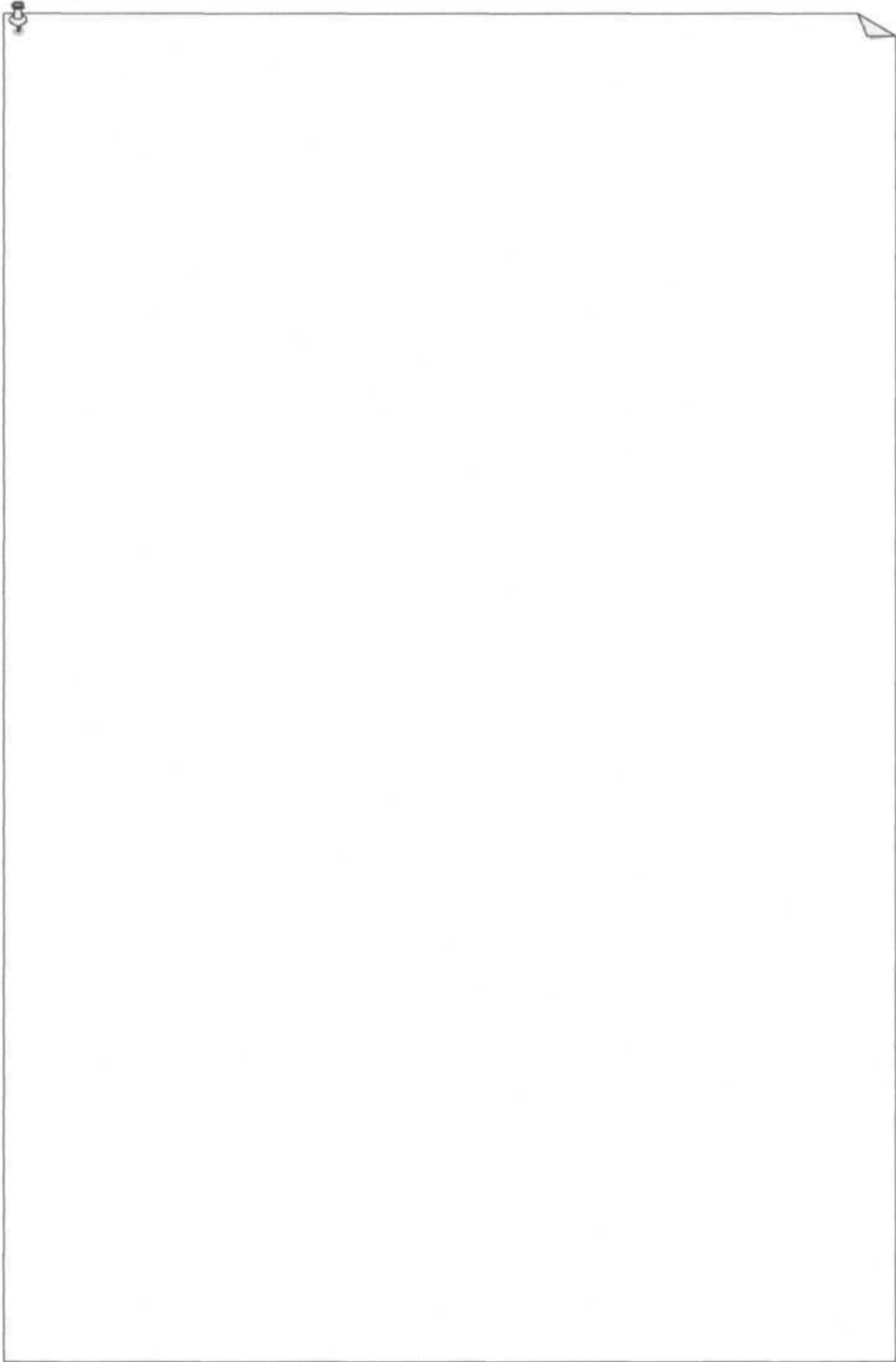

Introducción

Sala Malekum

Con Licencia

Esta recopilación de patipembas que hay es esta pequeña libreta esta pensada en el trabajo en el Munanso, para el trabajo diario dentro de el.

De tal manera que de una manera sencilla del operante mayombero pueda localizar la firma para un trabajo determinado de una manera rápida y sencilla.

Todas las patipembas están ordenadas alfabéticamente de tal manera que su localización es facilísima.

La libreta esta preparada en forma de tabla, para poder anotar las notas que creamos convenientes en cada firma.

Es mi deseo que estas 421 Patipembas sean de gran utilidad y para poderlas ver con mas detalle están preparadas en grupos de 100 en tipo diapositiva. Pida información.

Que Nzambi nos akutare a todos.

Malekum Sala



Tata Nkisi Malongo ...
Narciso Pell Alimany

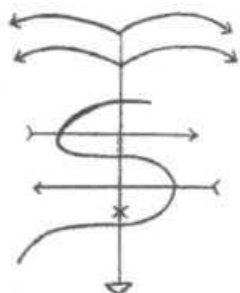

Ahijado Nfui para dar de comer a la Nganga

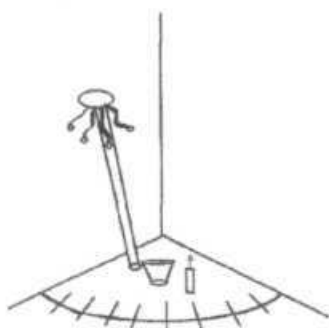

Altar de Muerto: Esta no es una firma, pero se ha puesto pues es como si lo fuera por lo trazos al suelo.

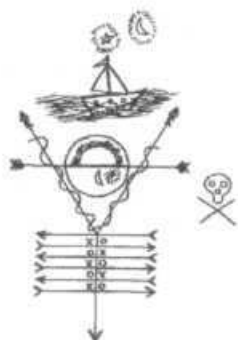

Baluande

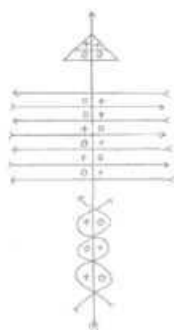

Baluande Siete Mares en tormenta

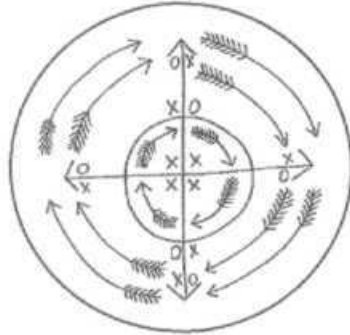

Brazo Fuerte

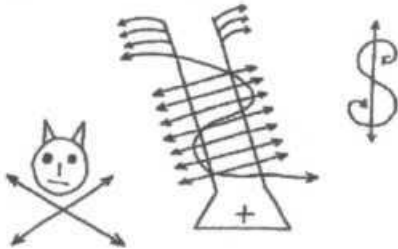

Brazo Fuerte

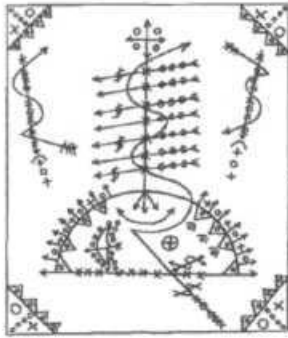

Brazo Fuerte



Briyumba Congo

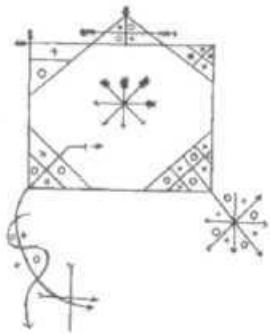

Cabildo de Tata Nsasi y de sus gajos de fundamento

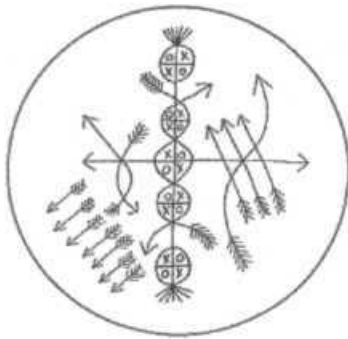

Cabo Ronda

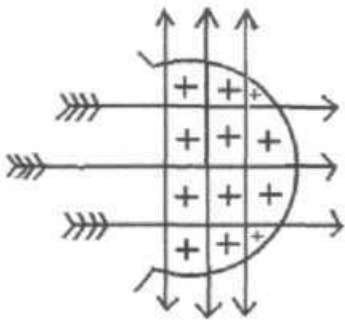

Cabo Ronda

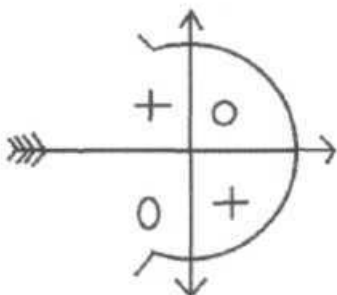

Cabo Ronda



Campo Finda

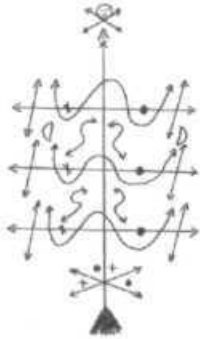

Campo Finda Cheche Molongo

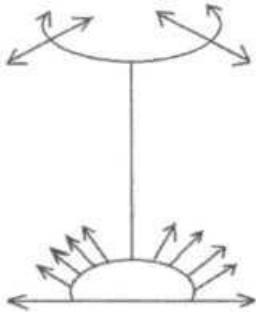

Carian Bemba



Ceiba, Patipemba de la

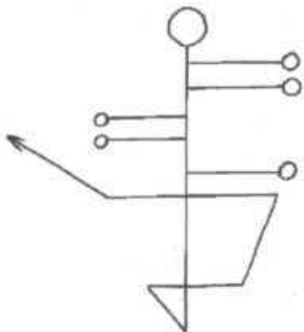



Centella

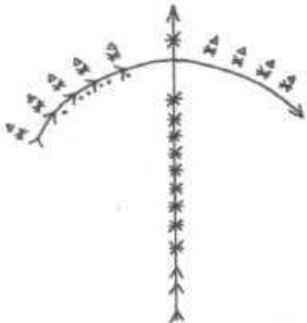

Centella

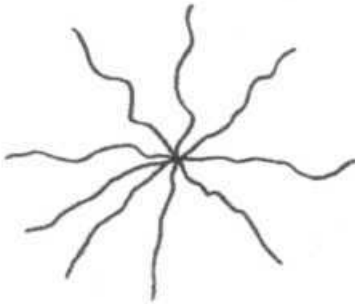

Centella en la Madrugada

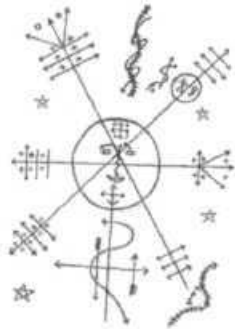

Centella Malongo





Centella Ndoki

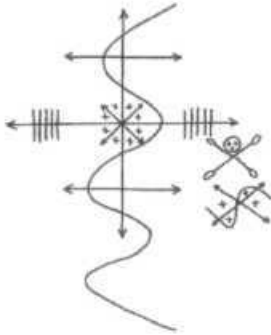

Centella Ndoki

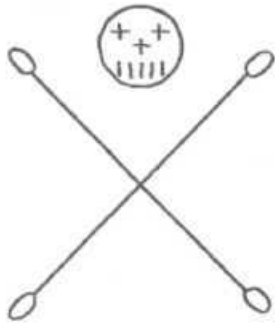

Centella Ndoki

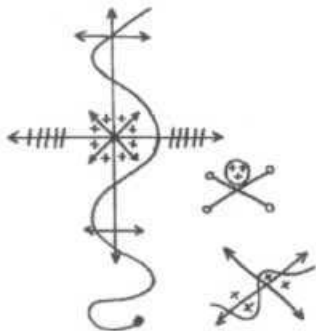

Centella Ndoki



Centella Ndoki

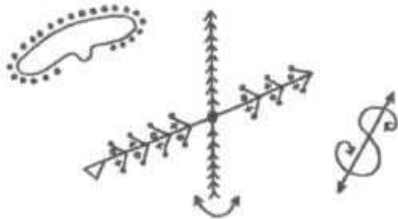

Centella Ndoki

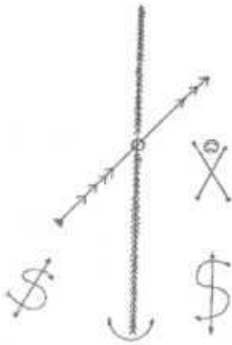

Centella Sacara Mpeño

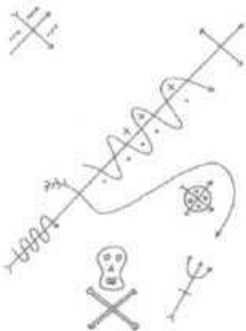

Centella Vira Mundo

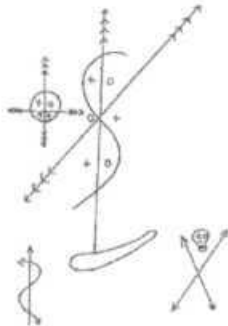



Centella Vira Tormenta

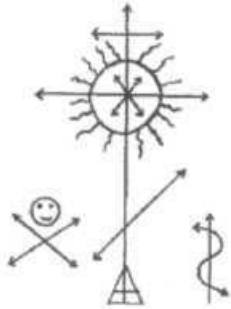

Centella, Patipemba de la



Chichereki

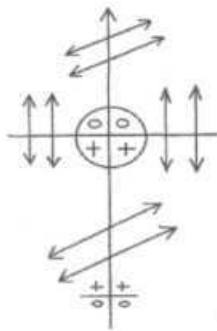

Coballende





Coballende

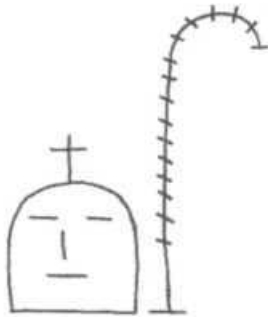

Coballende

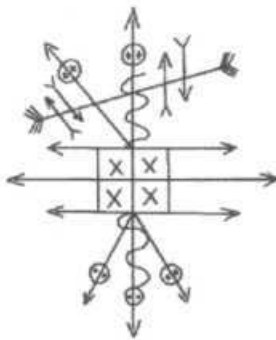

Coballende

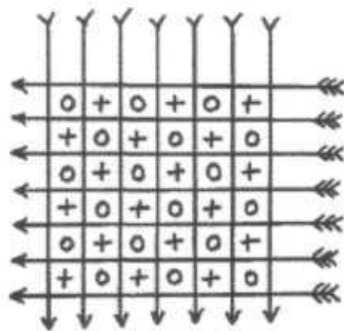

Coballende



Coballende

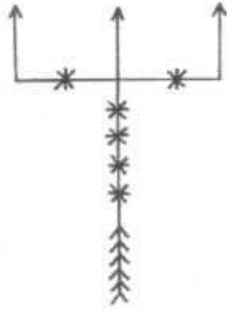

Coballende - Chapkuana

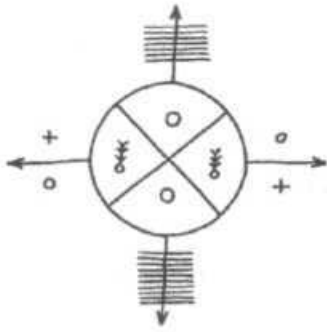

Coballende - Pata Llaga

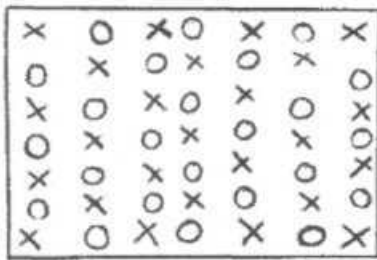

Coballende - Pata Llaga

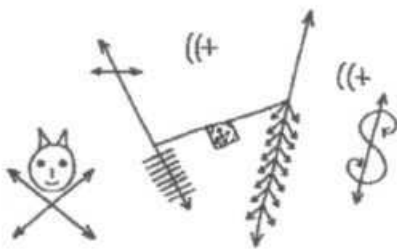

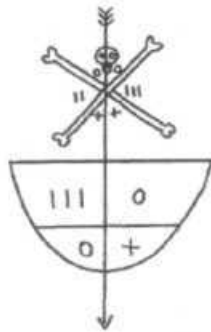

Coballende para arrear y quitar muerto



Coballende para arrear y quitar muerto



Coballende para arrear y quitar muerto

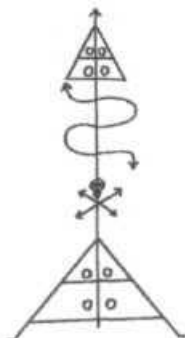

Coballende para arrear y quitar muerto



Coballende para arrear y quitar muerto

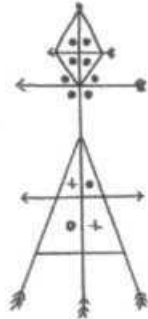

Coballende Vira Ntu

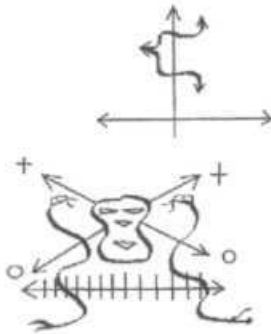

Cuatro Pemo Lucero Mundo Saca Mpeño

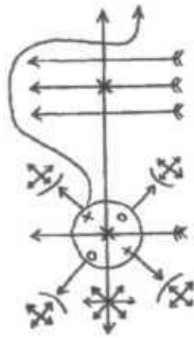

Cuatro Vientos con Siete Rayos

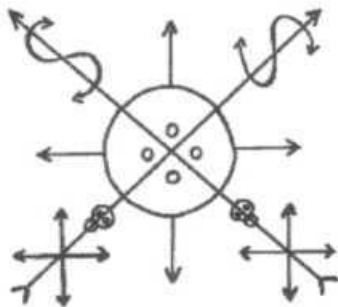



CB

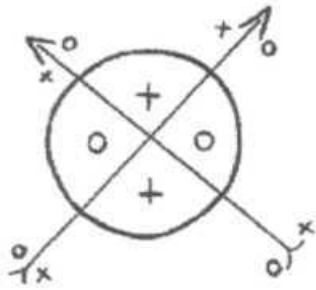

Cuatro Vientos Mundo Nuevo

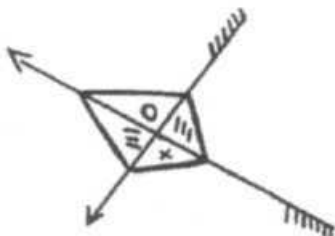

Cuatro Vientos para robar las esquinas al enemigo

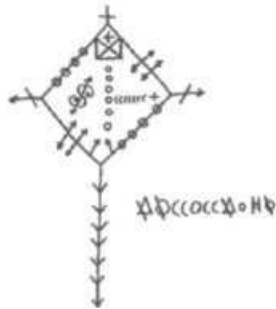

Cumanceto

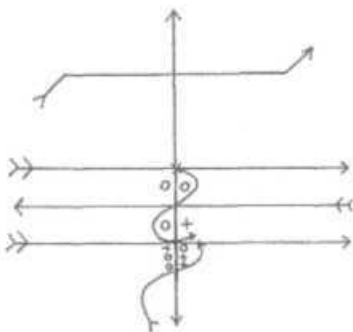

Cuye Lubamba



Desbarata Compone

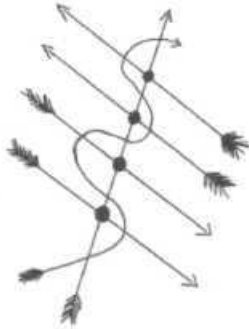

E Babi Dia Nvita

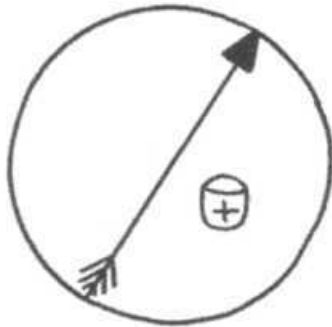

Grado Munbansa

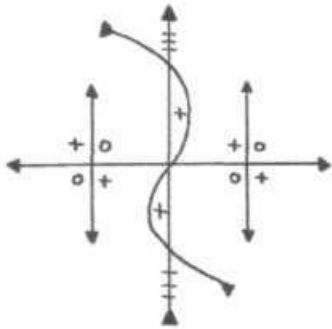

Grado Munfinda

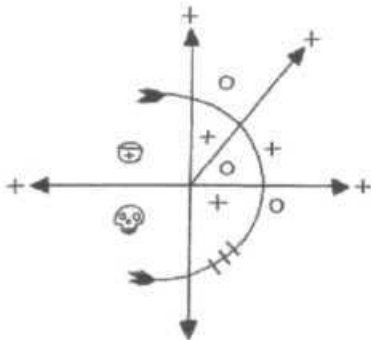

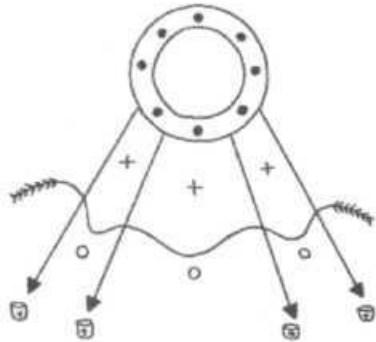

Grado Munkuendi

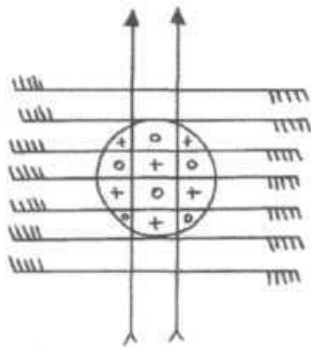

Grado Munsongo



Grado Munzila

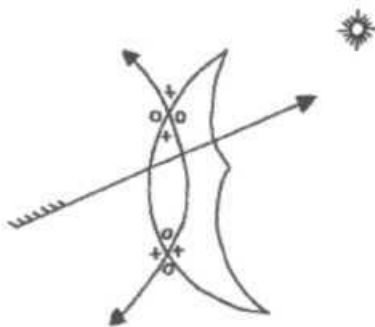

Grado Nfua Nkisi



Gran patipemba

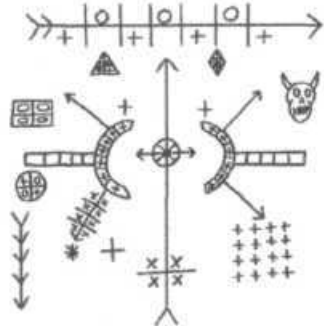

Gran patipemba

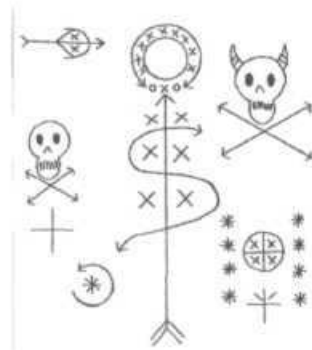

Guardiero



Guardiero, patipemba del

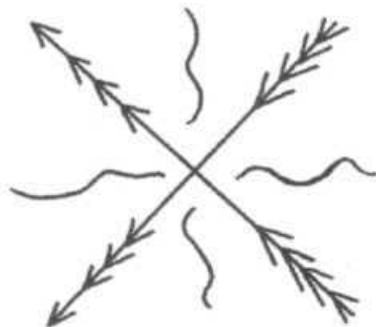



Guía de Lucero

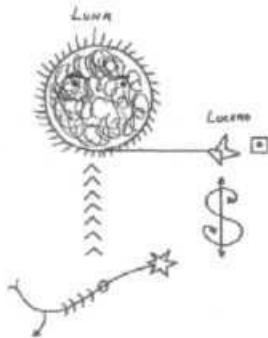

Ifá, Patipemba del espíritu de

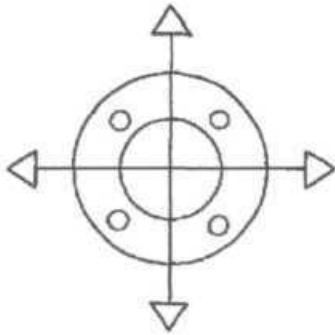

Infierno Mundo

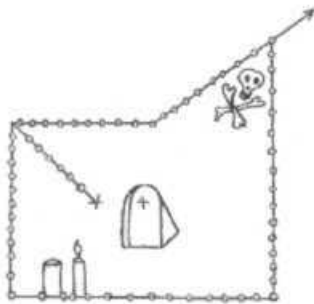

Juerema Vence Batalla

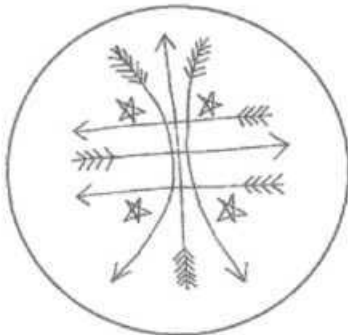

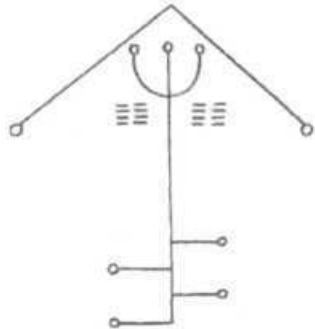

Kadiampemba - Abbita (el Diablo)

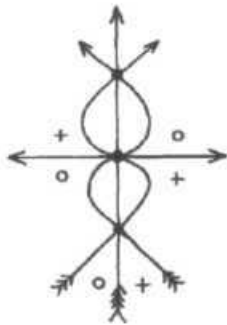

Kadiampemba - Abbita (el Diablo),
patipemba para trabajar



Kalunga

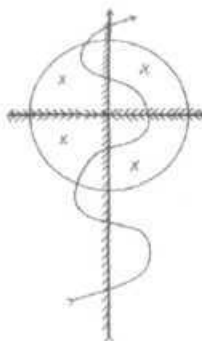

Kalunga



Kalunga Munan Nsambi

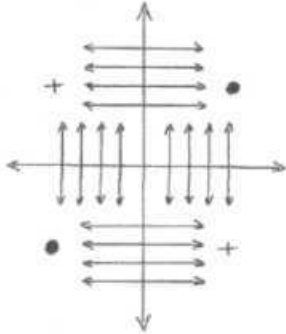

Kambonfinda - Nfumbe en Campo Finda

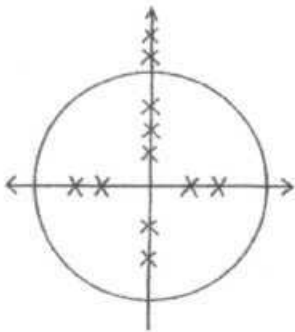

Kengue

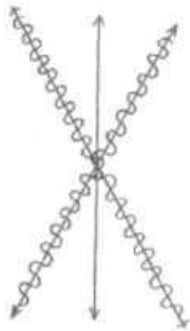

Kunanquisa - Tierra Tierra - Mama Kengue

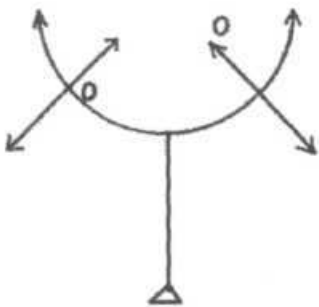



Lima Quiribomba

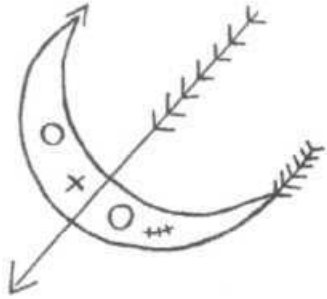

Luango Nsasi

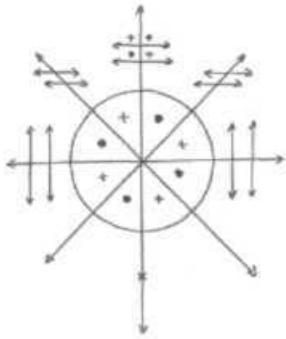

Lubambe Kambonfinda

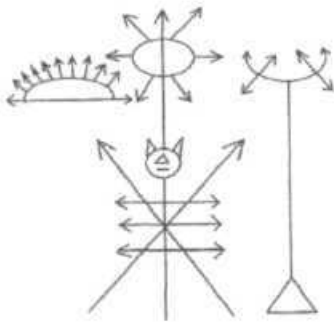

Lucero

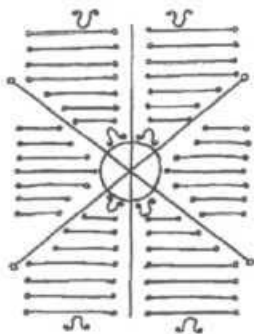



Lucero

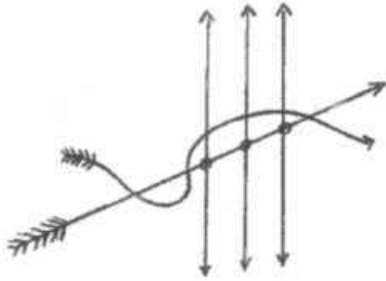

Lucero

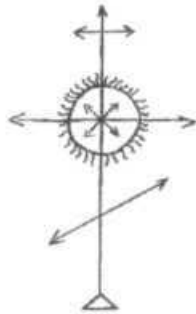

Lucero

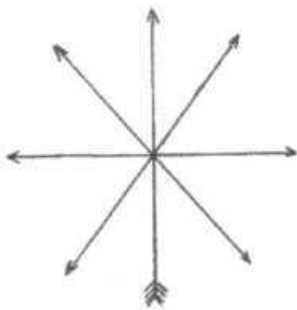

Lucero

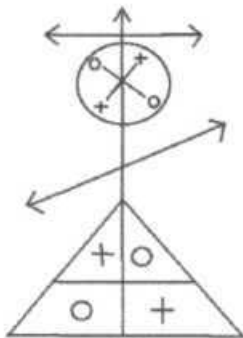

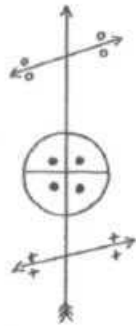

Lucero



Lucero

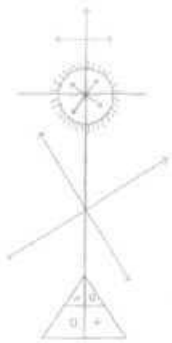

Lucero



Lucero Brillumbe

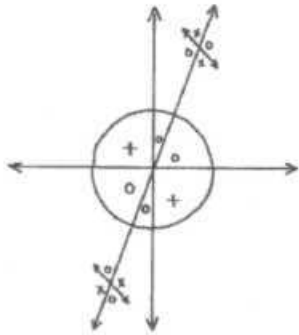

Lucero Cuatro Empalmes

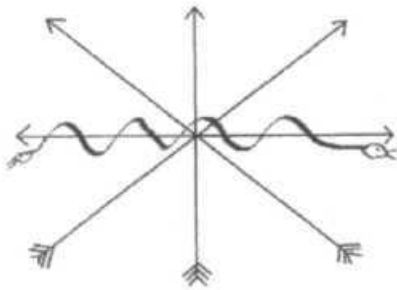

Lucero Cuatro Vientos

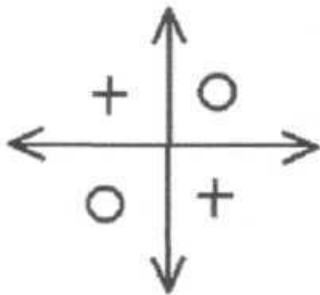

Lucero Cuatro Vientos

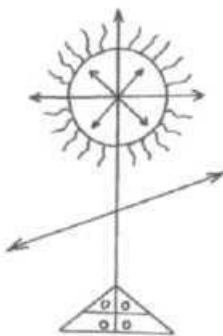

Lucero Cuatro Vientos



Lucero Cuatro Vientos

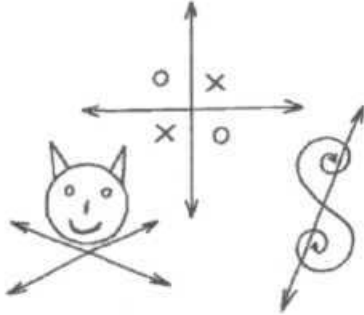

Lucero Cuatro Vientos Malongo

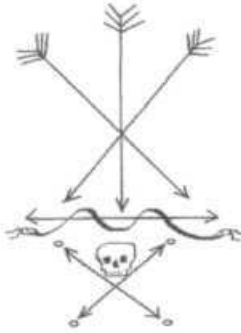

Lucero de Cabo Ronda y Juerema
Vence Batalla



Lucero del Campo Finda





Lucero Guarda Raya

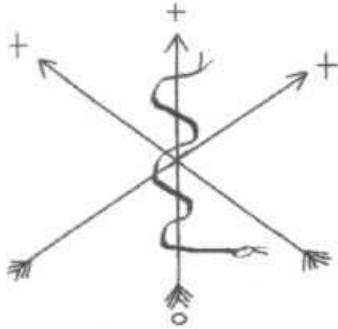

Lucero Kalunga

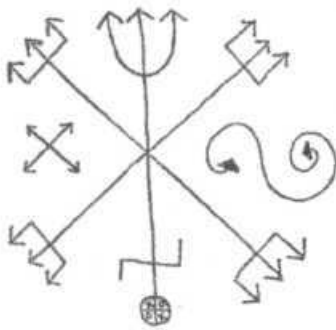

Lucero Malongo

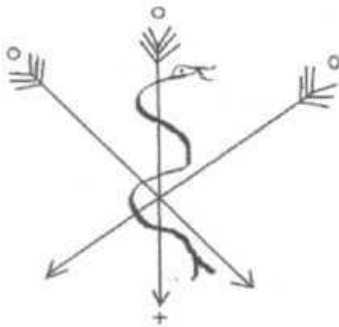

Lucero Media Noche

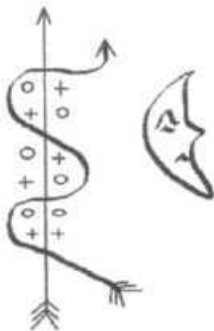



Lucero Mpaka Mensa

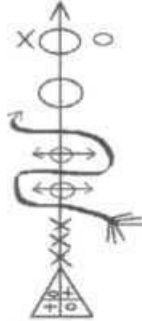

Lucero Mulembe Guerra

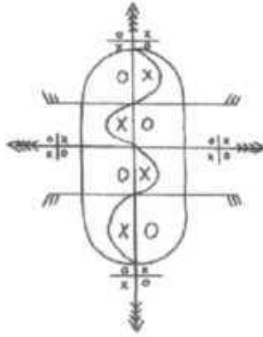

Lucero Mundo

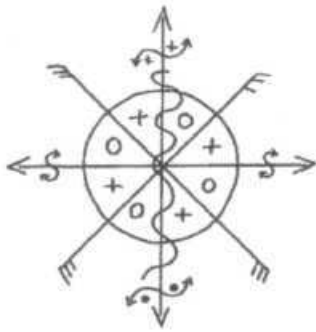

Lucero Mundo Batalla

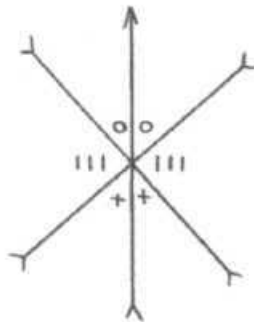



Lucero Mundo Guerra



Lucero Mundo, Patipemba para abrir camino a un negocio

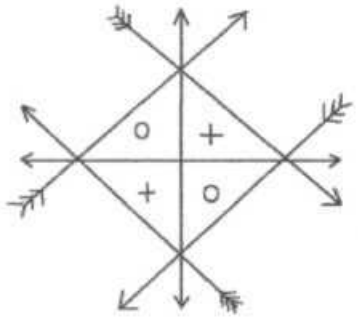

Lucero Ndoki

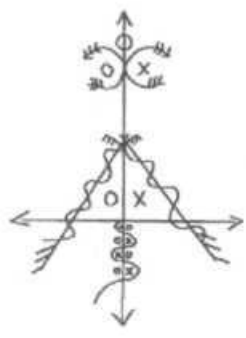

Lucero Nkangue

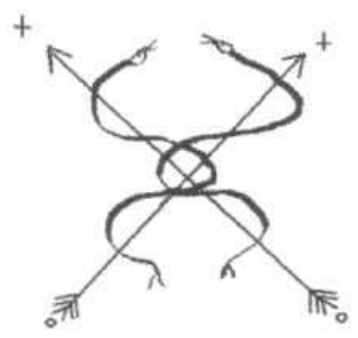

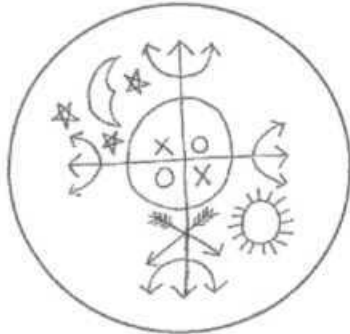

Lucero para el Caldeiro Espiritual



Lucero para el espíritu Brazo Fuerte

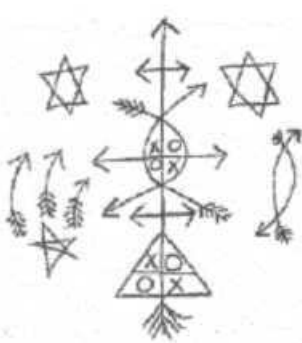

Lucero para el espíritu Coballende

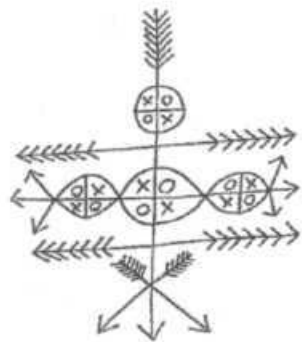

Lucero para el espíritu de 7 Rayos



Lucero para el espíritu de Centella Ndoki

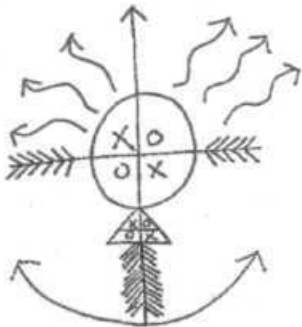

Lucero para el espíritu de Madre de Agua



Lucero para el espíritu de Mama Shola

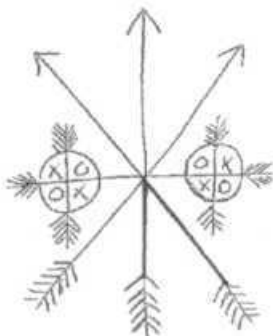

Lucero para el espíritu de Nsamba Ntala

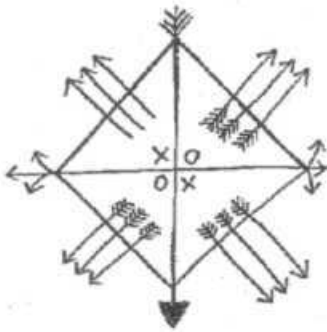

Lucero para el espíritu de Zarabanda

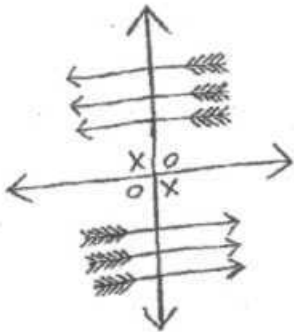

Lucero para el Espíritu Tempo

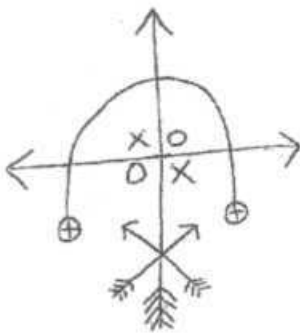

Lucero para el espíritu Tiembla Tierra

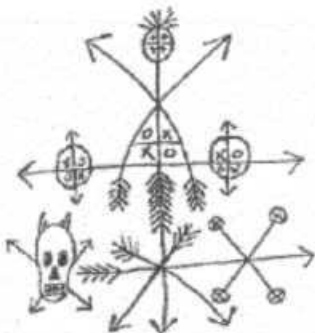

Lucero para Prenda Judía

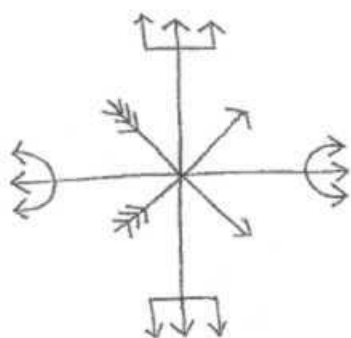

Lucero Rey del Congo

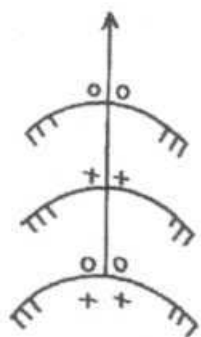

Lucero Saca Empeño

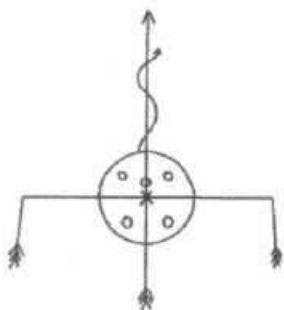

Lucero Saca Empeño

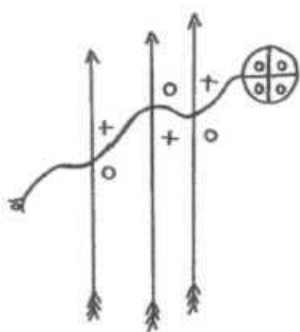

Lucero Saca Empeño

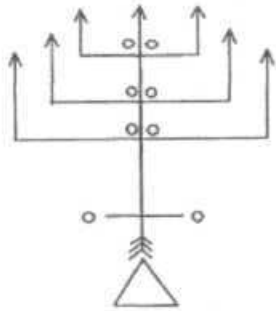

Lucero Siete Rayos

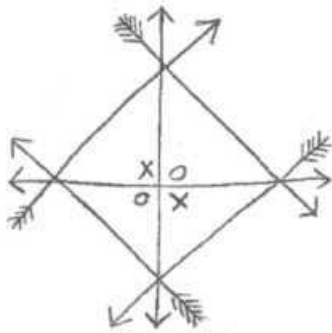

Lucero Vence Batalla

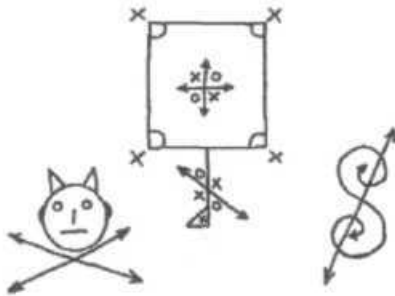

Lucero Viejo

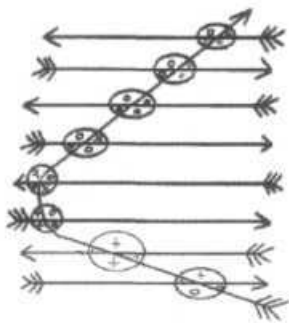

Lucero Vira Mundo

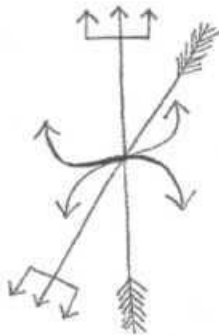

Lucero Vira Mundo



Lucero Vira Mundo

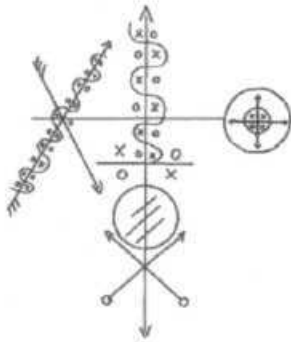

Lukembe



Madre de Agua



Madre de Agua

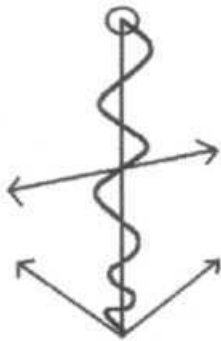

Madre de Agua



Madre de Agua

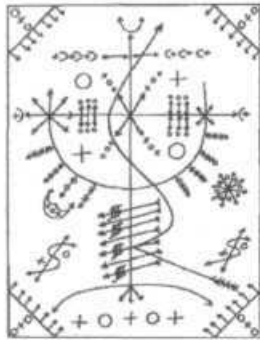

Madre de Agua

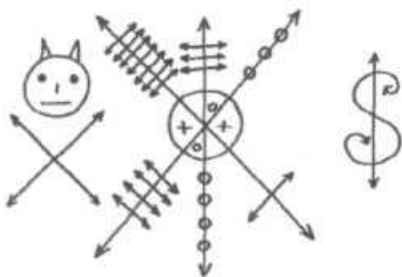



Madre de Agua Cazuela Mpemba

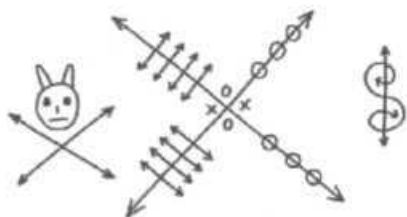

Mama Kengue

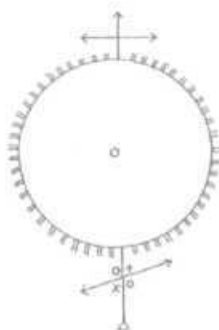

Mama Kengue Nyoca Mbatalla

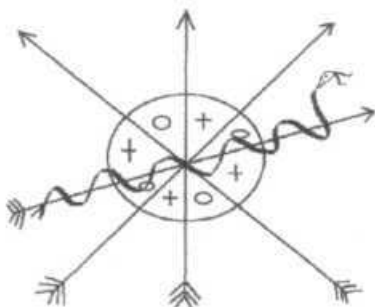

Mama Shola

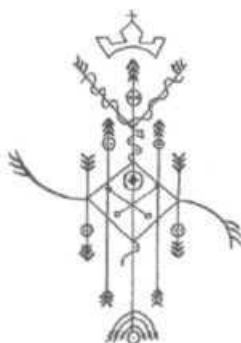

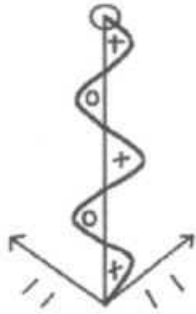

Mama Shola

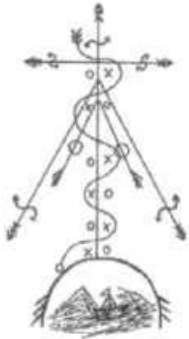

Mama Shola

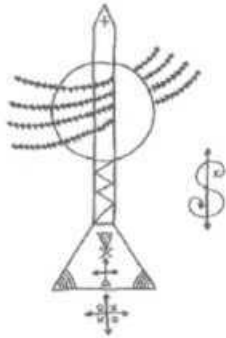

Mama Shola



Mama Shola Guenque del Río Seco



Mama Shola Nwenguere

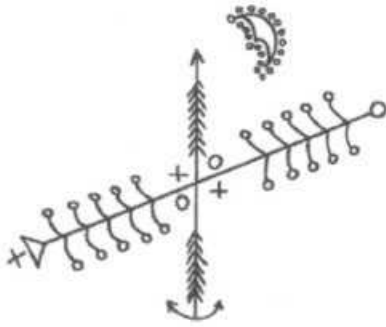

Mama Shola Nwenguere

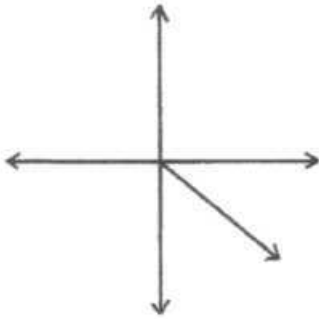

Mama Shola Río Seco

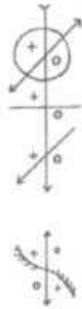

Mama Shola Wengue

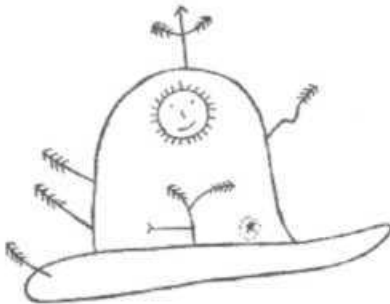



Mama Shola Wengue

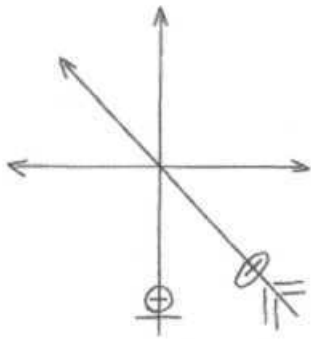

Mama Shola Wengue Patipemba muy buena para temas de amor

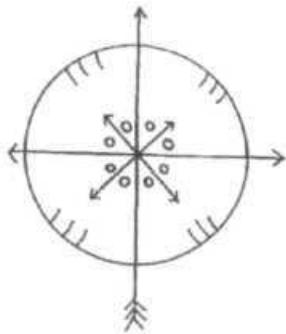

Marieta del Siglo XIX en Perico – Matanzas

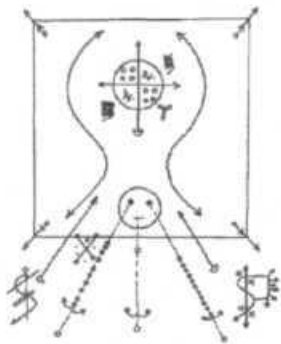

Mariwanga para curar y para joder



Mbuta a Makesa

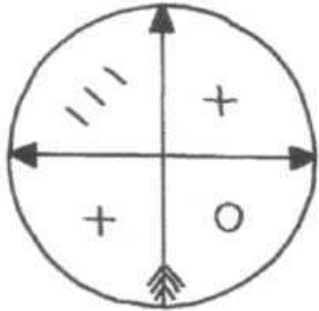

Monte Oscuro Ndoky

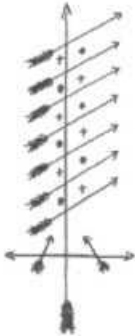

Mpaka

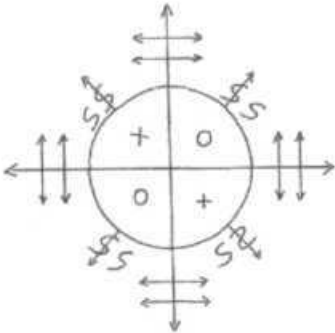

Mundo Vititi

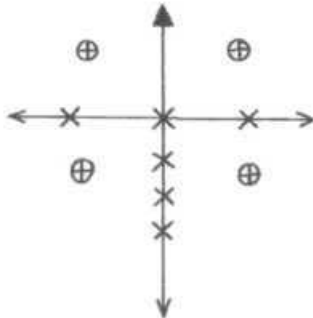

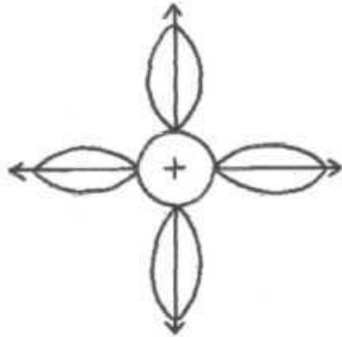

Mundo, patipemba del Que representa el mundo

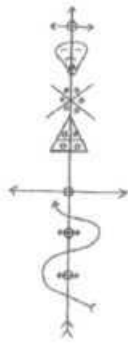

Nfuri

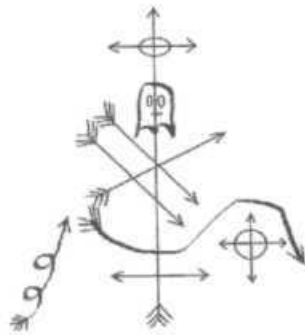

Nfuri va cuenda munanso

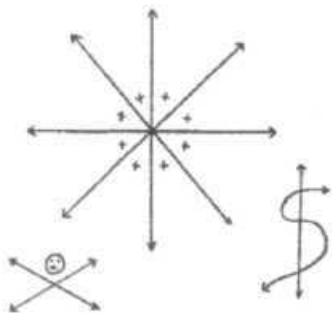

Nfumbe del Bien y del Mal



Nfumbe Gioso

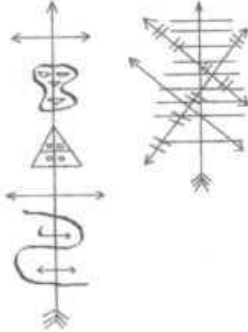

Nfumbe Malongo

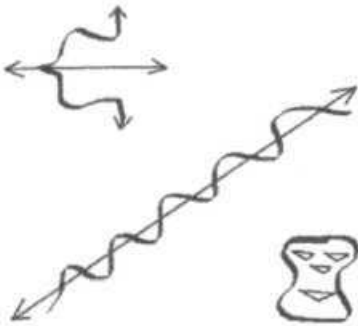

Ngandulero

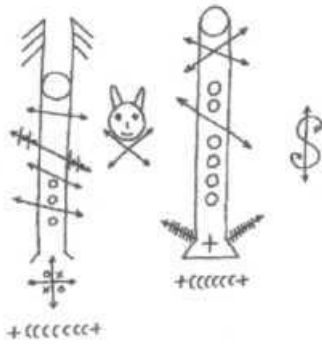

Ngombele Siete Rayos

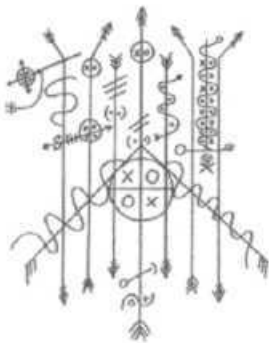



Nguluvu

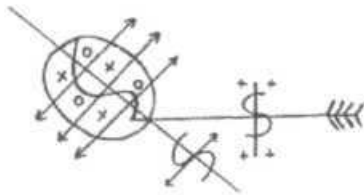

Ngurunfinda

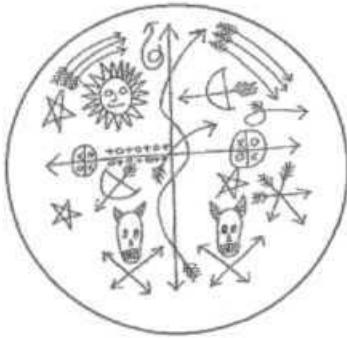

Ngurunfinda

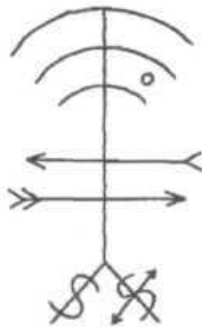

Ngurunfinda o la Nganga, patipemba para atraer, romper, defender y guerrear con



Ngurunfinda, patipemba del Güiro

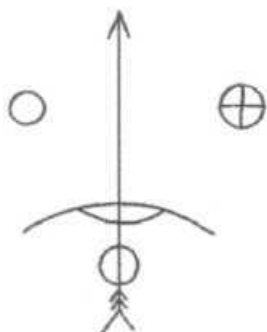

Ngurunfinda, patipemba del Majá (serpiente), para darle serpiente

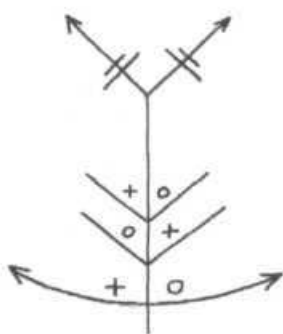

Ngurunfinda, patipemba del Ozun de

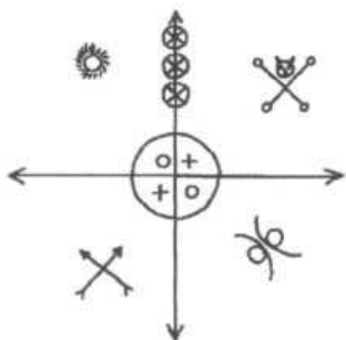

Ngurunfinda, patipemba guia de Ngurunfinga para Okuni (hombre)

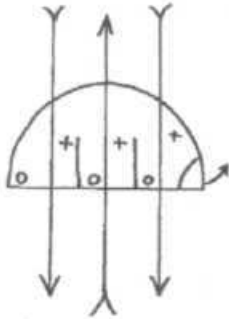

Ngurunfinda, patipemba para amarrar las cuatro esquinas con

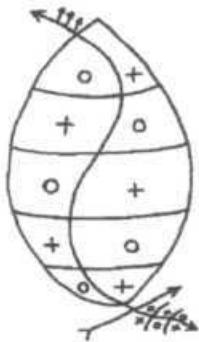

Ngurunfinda, patipemba para arrear el fundamento de

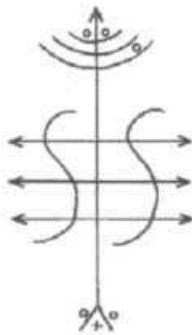

Ngurunfinda, patipemba para dar Addié Chachara a

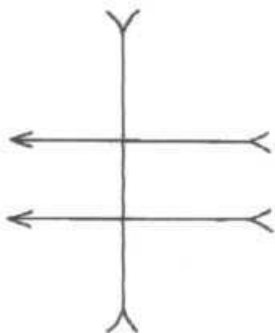

Ngurunfinda, patipemba para darle Akuko (Gallo grifo)

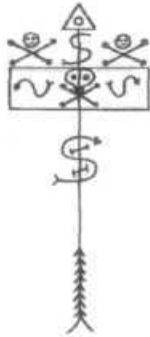

Ngurunfinda, patipemba para darle Ayá (perro)

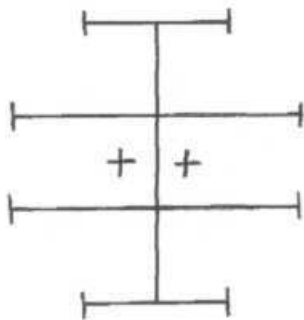

Ngurunfinda, Patipemba para darle Nsusu (Akukó) (Gallo)

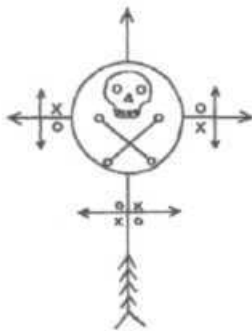

Ngurunfinda, patipemba para darle Ologbo (gato)

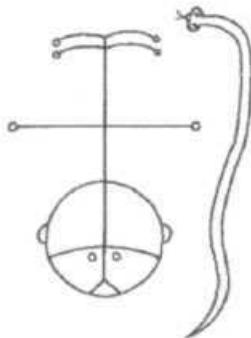

Ngurunfinda, patipemba para darle paloma rabiché

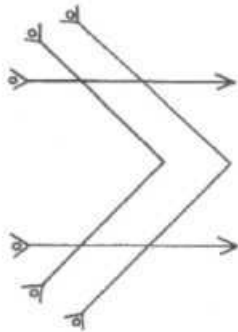

Ngurunfinda, patipemba para darle pescado fresco

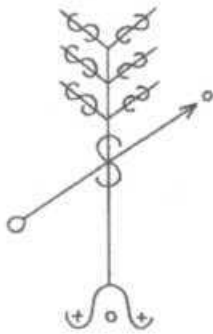

Ngurunfinda, patipemba para darle tiñosa

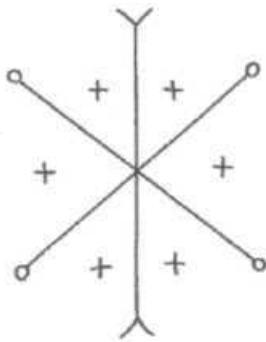

Ngurunfinda, patipemba para darle Venado

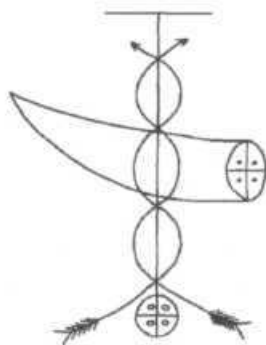

Ngurunfinda, patipemba para hacer Inché ni (resguardo de ...)

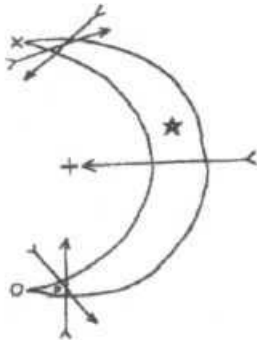

Ngurunfinda, patipemba para hacer lyé en el tablero (polvos malos)

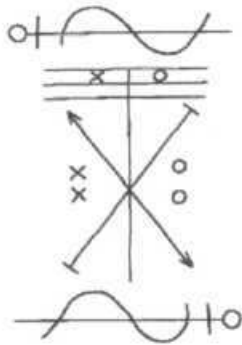

Ngurunfinda, patipemba para hacer paraldo

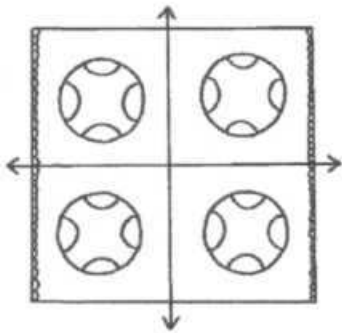

Ngurunfinda, patipemba para hacer recogimiento

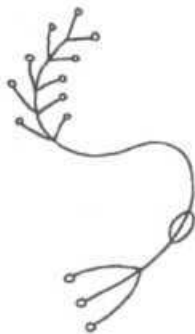

Ngurunfinda, patipemba para jurar Mpaka de

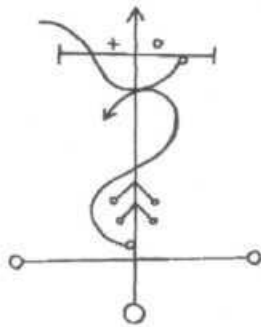

Ngurunfinda, patipemba para la guía de Ngurunfinda para Obbini

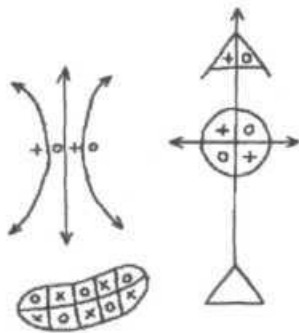

Ngurunfinda, patipemba para pedir dinero con lámpara o para preparar Afoché para el dinero

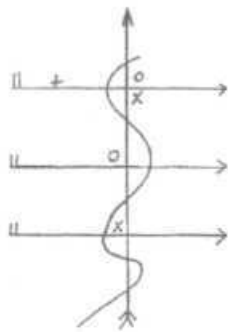

Nkuyo

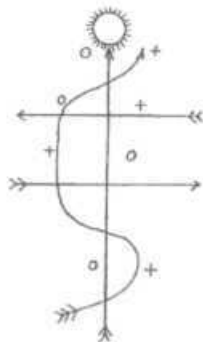

Nkuyo - Lucero

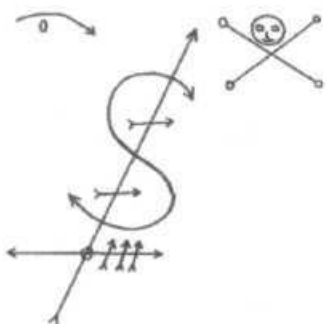

Nkuyo Kuenda

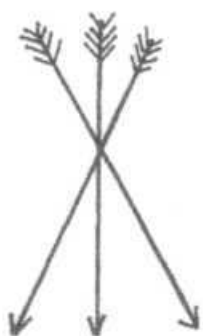

Nkuyo Lucero

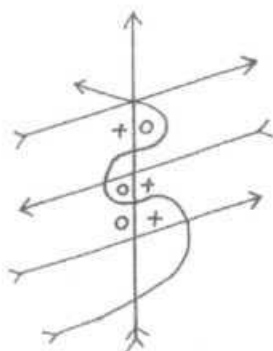

Nkuyo Lucero Mundo

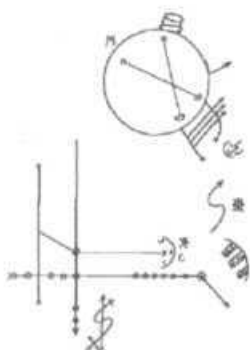

Nkuyo para guerrear

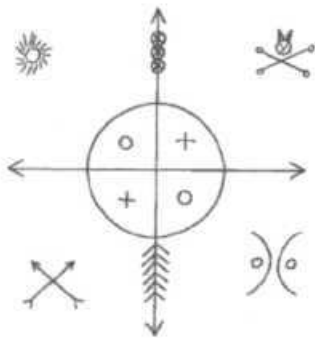

Nkuyo y Pandilanga para curar

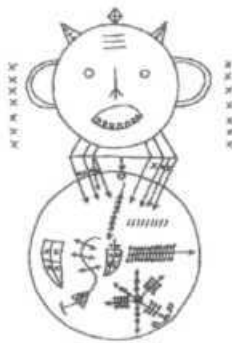

Nkuyo, patipemba para guerrear



Nsamba Ntala



Nsambi



Nsambi

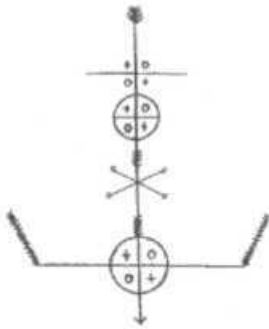

Nsambi

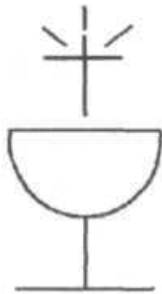

Nsambi Mpungo

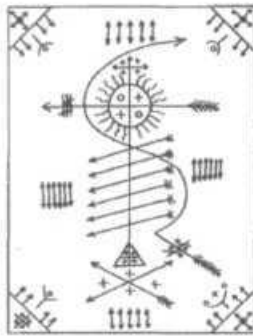

Nsambi Mpungo

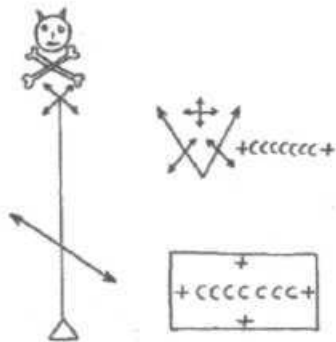



Nsambi Nfumbe Malongo

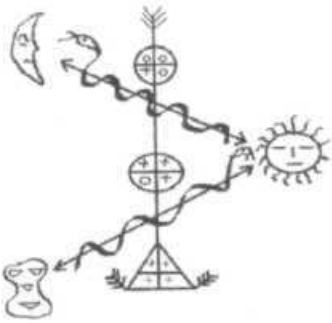

Nsambi Niri

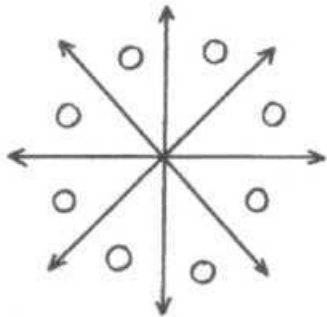

Nsambi Niri

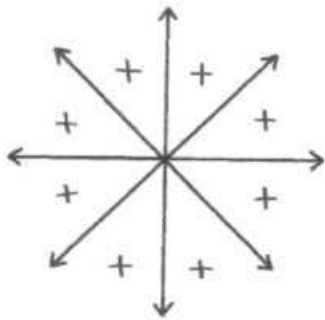

Nsasi

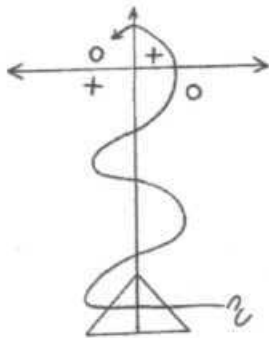



Ca

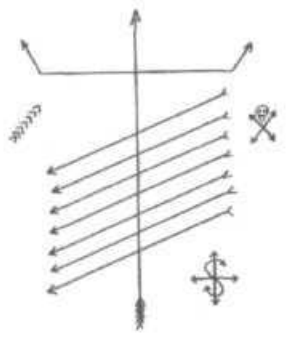

Nsasi & Zarabanda

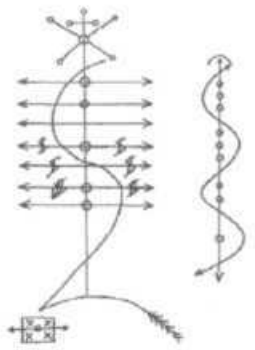

Nsasi con Mriwanga pa Guerrear

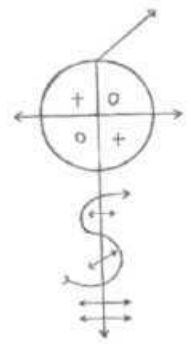

Nsasi lukansa Batalla Malongo

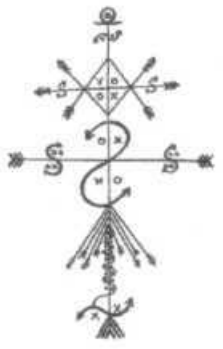

Nsasi Siete Rayo



Ntoto ya Banganga Nkisi - Tierra (o Mundo) de Paleros

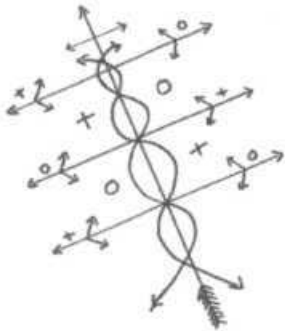

Olgun Cobu Cubu

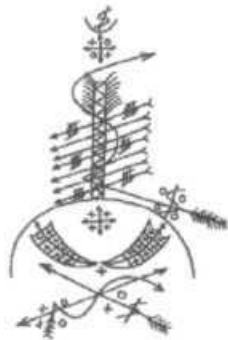

Patibemba conjunta Braza Fuerte, Tiembla Tierra y Siete Rayos

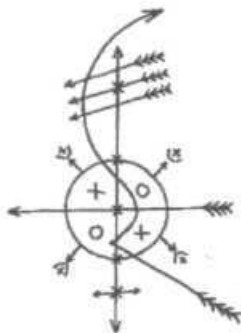

Patibemba Conjunta Madre Agua, Shola Wenguere, Baluande, Buey Suelto y Lucero Cuatro Vientos

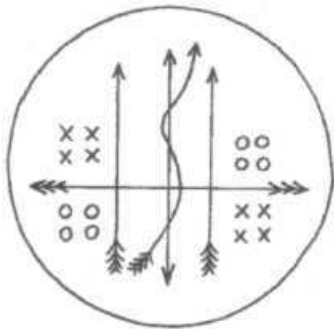

Patibemba de Nfumbe - Fundamento Tronco Firme

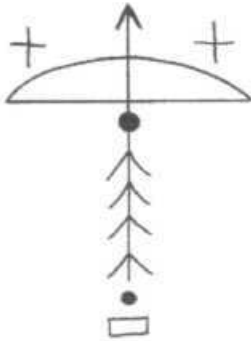

Patibemba propiciatoria del bien y la de Nkuyo Bueno



Patibemba tipo madera para curar mal de ojo

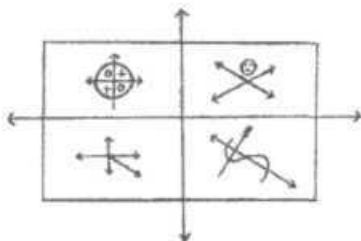

Patipemba "El signo del fuego y los rayos"

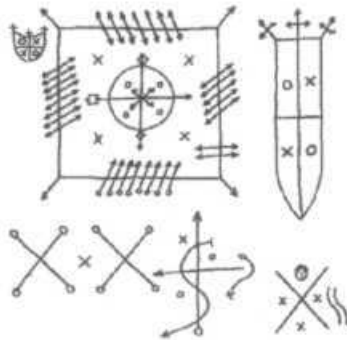

Patipemba de Fundamento para currar y para joder

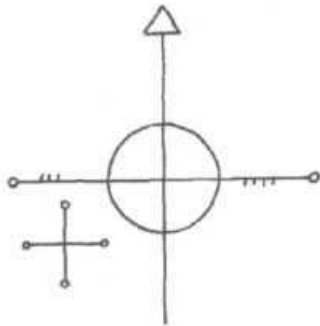

Patipemba de la estabilidad de la casa o de una situación



Patipemba de la Rama Briyumba

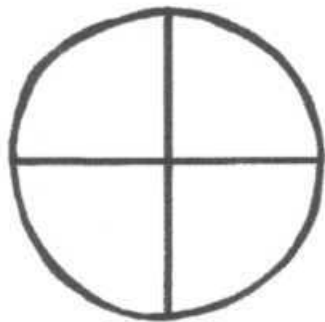

Patipemba de Malongo

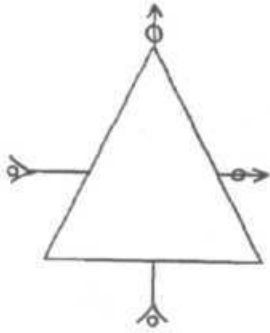

Patipemba de Malú (buey), para darlo



Patipemba de Palero



Patipemba de Palero

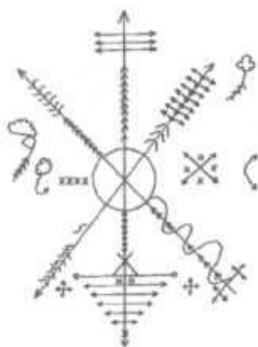

Patipemba de tratado para Guerrear