

The Hermetic Order Of The
GOLDEN DAWN^{Intl.}

THEORICUS INITIATION OF
THE HERMETIC ORDER OF
THE GOLDEN DAWN

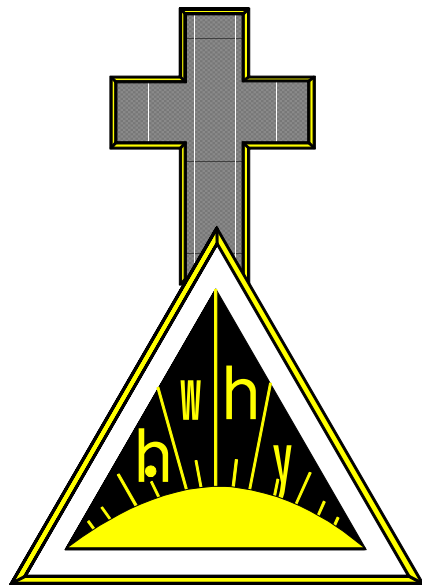

(Hierophant knocks once.)

KERUX: "Hekas! Hekas! Este be belo!"

HIEROPHANT: "Fraters and Sorors of the Hermetic Order of the Golden Dawn in the Outer, assist me to open the Temple in the grade of Theoricus. **Kerux**, see to it that the Temple is properly guarded."

KERUX: (Done.) "Very Honored **Hierophant**, the Temple is properly guarded."

HIEROPHANT: "Honored **Hiereus**, see that none below the grade of Theoricus are present."

HIEREUS: "Fraters and Sorors, give the Sign of Theoricus. (Done.) Very Honored **Hierophant**, all present have obtained the grade of Theoricus."
(Salutes with 2=9 sign.)

HIEROPHANT: "Honored **Hegemon**, to what particular element is this grade attributed?"

HEGEMON: "To the element of Air."

HIEROPHANT: "Honored **Hiereus**, to what planet does this grade refer?"

HIEREUS: "To the Moon."

HIEROPHANT: "Honored **Hegemon**, what path is attributed to this grade?"

HEGEMON: "The thirty-second path of Tav."

HIEROPHANT: "Honored **Hiereus**, to what does it allude?"

HIEREUS: "To the Universe as composed of the four elements, to the Kerubim, to the Qlipoth, the astral plane and the reflection of the sphere of Saturn."
(Hierophant knocks once.)

(All rise and face east.)

HIEROPHANT: "Let us adore the Lord and King of Air. (Makes circle with scepter in the east.) Shaddai El Chai, Almighty and Everlasting be Thy name, ever-magnified in the life of all. Amen." (All give 2=9 grade sign.)

(**Hierophant** remains facing east. **Hiereus** advances to the east and stands behind the **Hierophant**. **Hegemon** and **Kerux** advance to the east, **Hegemon** to the right and **Kerux** to the left just behind the **Hierophant** and **Hiereus**)

HIEROPHANT: (Making Invoking Pentagrams of Spirit and Air with his scepter in the air in front of the Air tablet.) "And the Elohim said, 'Let us make Adam in our image, after our likeness, and let them have dominion over the fowl of the air.' In the name YHVH and in the name of Shaddai El Chai, spirits of Air, adore your Creator. (Taking pantacle from before the tablet and making the sign of Aquarius in the air before it.)

In the name of the great Archangel of the Air, Raphael, and in the sign of the head of the man, spirits of Air, adore your Creator.

(Make sign of cross with pantacle.)

In the names and letters of the Great Eastern Quadrangle revealed unto Enoch by the Angel Ave, spirits of Air, adore your Creator.

(Hold pantacle high above head.)

In the three great secret names of God borne upon the Banner of the East, ORO IBAH AOZPI, spirits of Air, adore your Creator." In the name of BATAIVAH, Great king of the East, spirits of Air, adore your creator."

(Replace pantacle.)

(All give the 2=9 grade sign.)

(All return to place.)

HIEROPHANT: "In the name of Shaddai El Chai, I declare this Temple opened in the 2=9 grade of Theoricus, Worker of Air, in the Hermetic Order of the Golden Dawn."

HIEROPHANT knocks: ||| ||| |||

HIEREUS knocks: ||| ||| |||

HEGEMON knocks: ||| ||| |||

HIEROPHANT: "Fraters and Sorors, our Frater/Soror _____ having made such progress in the paths of occult science, as has enabled him/her to pass the examination and the requisite knowledge, is now eligible for advancement to the grade of Theoricus, and I have duly received a dispensation from the Greatly Honored Chiefs of the Second Order to advance him/her in due form. Honored **Hegemon**, prepare the Zelator and give the customary alarm upon your return."

(Hegemon salutes and quits Temple.)

(**Kerux** places fan by the **Hierophant**, lamp by the **Hegemon**, cup by the **Hiereus**, salt by the **Kerux**.)

HEGEMON: (Prepares Zelator with hoodwink and solid Cubical Greek Cross. She knocks nine times on the door.) "Quit the material and seek the spiritual."

(**Kerux** opens the door.)

HIEROPHANT: "Conduct the Zelator to the east."

(**Hegemon** is places zelator before the pillars. **Kerux** at the Zelator's left hand. **Hegemon** at his right. **Kerux** takes Cubical Cross from Zelator.)

HIEROPHANT: "Give me the Sign of the Zelator. (Done.) Give me the Mystical Number and the letters of the Zelator. (55, Nun Heh.) Give me the Divine name of the Zelator grade. (Adonai ha-Aretz.) Give me the Mystical Title which you received in that grade. (Pereclinus de Faustis.) Frater/Soror, do you solemnly pledge yourself to maintain the same strict secrecy regarding the Mysteries of the thirty-second path and the grade of Theoricus which you have already sworn to maintain respecting those of the preceding grades?"

ZELATOR: "I do."

(**Kerux** hands Cubical Cross to candidate.)

HIEROPHANT: "Then stretch out your right hand, holding the Cubical Cross toward the heavens, and say, 'I swear by the firmament of heaven and by my mighty and secret soul.' (Done.) Let the hoodwink be removed."

(**Hegemon** removes hoodwink and returns to place in the south, leaving **Kerux** in charge of Zelator.)

HIEROPHANT: "Stretch forth your right hand, holding the Cubical Cross toward the east in the position of the Zelator sign saying, 'Let the powers of Air witness my pledge.'

(Done.)

Facing you are the portals of the thirty-first, thirty-second, and twenty-ninth paths, leading from the grade of Zelator to the three other grades which are beyond. The only path open to you, however, is the thirty-second which leads to the grade of Theoricus, which you must traverse before arriving at that degree. Take in your right hand the Cubical Cross, and in your left hand the Banner of Light.

(**Hierophant** gives him Banner of the East.)

Follow your guide Anubis the Guardian who leads you from the material to the spiritual."

KERUX: "Anubis the Guardian said unto the aspirant, 'Let us enter the presence of the Lords of Truth. Come and follow me.'"

(**Kerux** leads **Zelator** between the columns, turns to the right, and circumambulates the Hall once.)

HIEREUS: (As they go around the first time.) "The Sphinx of Egypt spoke and said, 'I am the synthesis of the elemental forces, I am also the symbol of man, I am life and I am death. I am the Child of the Night of Time.'"

(As the **Kerux** and **Zelator** approach the east, the **Hierophant** steps from between the pillars and bars their passage. **Hierophant** holds Banner of West in left hand and fan in right.)

HIEROPHANT: "The priest with the Mask of Osiris spoke and said, 'Thou cannot pass the gate of the eastern heaven, unless thou can tell me my name.'"

KERUX: "Thou art Nu, the Goddess of the firmament of Air, thou art Hormakhu, Lord of the eastern sun."

HIEROPHANT: "In what signs and symbols do you come?"

KERUX: "In the letter Aleph and the Banner of Light, and the symbol of equated forces."

HIEROPHANT: (Draws Aquarius Kerub with fan before the **Zelator**. Falls back.) "In the Sign of the man, Child of Air, thou art purified, pass thou on."

(**Hierophant** gives Banner of West to **Kerux**, who hands it to the **Hegemon** as he passes her.)

(**Kerux** and **Zelator** circumambulate the Temple a second time, following the course of the Sun.)

HIEREUS: (As they are going around a second time.) "I am Osiris, the soul in twin aspect, united to the higher by purification, perfected in suffering, glorified through trial. I have come where the great gods are through the power of the Mighty Name."

HEGEMON: (Barring the way in the south with the red lamp in right hand and Banner of the West in the left hand.) "The priest with the mask of the lion spoke and said, 'Thou cannot pass the gate of the southern heaven unless thou can tell me my name.'"

KERUX: "Mau, the lion very powerful, Lord of Fire is thy name, thou art Ra, the Sun in his strength."

HEGEMON: "In what signs and symbols do you come?"

KERUX: "In the letter Shin and the Banner of the East and the symbol of the Cubical Cross."

HEGEMON: (Drawing the Leo Kerub with the lamp and falling back) "In the sign of the Lion, Child of Fire, thou art purified, pass thou on."

(**Hegemon** replaces lamp and takes the place of the **Kerux**, who returns to north, and the **Hegemon** leads Zelator round the Temple a third time, giving the Banner of the West to the **Hiereus**.)

HIEREUS: (As they are going around the third time.) "I have passed through the gates of the firmament. Give me your hands for I am made as ye. Hail unto ye, ye Lords of Truth, for ye are the formers of the Soul.

(Barring the way in the west with Cup of water in right hand and Banner of West in left.)

The priest with the mask of the Eagle spake and said, 'Thou cannot pass the gate of the western heaven, unless thou can tell me my name.'

HEGEMON: "Heka, Mistress of Hesar, Ruler of Water is thy name; Thou art Toum, the setting Sun."

HIEREUS: "In what signs and symbols do you come?"

HEGEMON: "In the letter Mem, in the Banner of Light, and the symbol of the twenty - two letters."

HIEREUS: (Falling back and signing the Eagle Kerub before the **Zelator** with the cup.) "In the sign of the Eagle, Child of Water, thou art purified, pass thou on."

(**Hiereus** gives Banner of West to **Hegemon** who leaves it with the **Kerux** as she passes him. **Hegemon** leads candidate round the Temple for fourth time.)

HIEREUS: (As they go around.) "Oh Lord of the Universe, Thou art above all things and Thy name is in all things; and before Thee the shadows of night roll back and the Darkness hasteneth away."

KERUX: (Barring the way in the north with plate of salt in right hand and Banner of West in left hand.) "The priest with the mask of the Ox spake and said, 'Thou cannot pass the gate of the northern heaven, unless thou can tell me my name.'"

HEGEMON: "Satem in the abode of Shu, the Bull of Earth is thy name; thou art Kephera, the Sun at night."

KERUX: "In what signs and symbols do ye come?"

HEGEMON: "In the letters Aleph, Mem and Shin; and in the symbols of the Banner and Cross."

KERUX: (Falling back and signing the Taurus Kerub before the **Zelator** with the plate of salt.) "In the sign of the head of the Ox, child of the elements, thou art purified, pass thou on."

(**Hegemon** and **Kerux** conduct candidate to the foot of the pillars. **Hierophant** takes banners and places them in their bases. **Hegemon** hands Cubical Cross to the Hierophant. **Hegemon** and **Kerux** return to their respective places. Fan, lamp, cup and salt are replaced by **Kerux** on the altar.)

Double Cubical Cross

HIEROPHANT: (Holding the Cubical Cross) "The Cubical Cross is a fitting emblem of the equilibrated and balanced forces of the elements. It is composed of twenty-two squares externally, thus referring to the twenty-two Hebrew letters which are placed thereon. Twenty-two are the letters of the Eternal Voice, in the Vault of Heaven; in the depths of the Earth; in the abyss of Water; in the all presence of Fire. Heaven cannot speak their fullness, Earth cannot utter it. Yet hath the Creator bound them in all things. He hath mingled them in Water. He hath whirled them aloft in Fire. He hath sealed them in the Air of heaven. He hath distributed them through the planets; he hath assigned unto them the twelve constellations of the zodiac.

(Places Cubical Cross aside.)

The thirty-second path of the *Sepher Yetzirah* which answereth unto the letter Tav is called the administrative intelligence and it is so called because it directeth and associateth in all their operations, the seven planets, even all of them in their own due courses. To it, therefore, is attributed the due knowledge of the seven abodes of Assiah, the material world, which are symbolized in the Apocalypse by the seven churches. It refers to the Universe as composed of the four elements; to the Kerubim; to the Qlipoth; and to the astral plane. It is the reflection of the sphere of Saturn. It represents the connecting and binding link between the material and formative world, Assiah and Yetzirah, and necessarily passes through the astral plane, the abode of the elementals and the shells of the dead. It is the rending of the veil of the Tabernacle whereon the Kerubim and the palm trees are depicted. It is the passing of the gate of Eden."

(Leads **Zelator** to the West of the altar.)

Universe Card

"These ideas are symbolically resumed in the representation of the twenty-first Key of the Tarot before you. Within the oval formed of the seventy-two circles is a female figure, nude save for a scarf which floats around her. She is crowned with the lunar crescent of Isis, and holds in each hand a wand. Her legs form a cross. She is the bride of the Apocalypse, the Qabalistic Queen of the Canticles, the Egyptian Isis of nature now shown partly unveiled, the great feminine Kerubic angel Sandalphon on the left hand of the Mercy Seat of the Ark. The two wands are the directing forces of the positive and negative currents. The seven pointed star or heptagram alludes to the seven palaces of Assiah; the crossed legs to the symbol of the four letters of the name. The surmounting crescent receives alike the influences alike of Geburah and Gedulah. She is the synthesis of the thirty-second path uniting Malkuth with Yesod. The oval of seventy-two small circles is the Schemhamporesch, or the seventy-two fold name of Deity. The twelve larger circles form the zodiac. At the angles are the four Kerubim which are the vivified powers of the letters of the Tetragrammaton operating in the elements, through which you have just symbolically passed in the preceding ceremony.

The fan, lamp, cup and salt represent the four elements themselves, whose inhabitants are the Sylphs, Salamanders, Undines and Gnomes. Be thou therefore prompt and active as the Sylphs, but avoid frivolity and caprice. Be energetic and strong like the Salamanders but avoid irritability and ferocity. Be flexible and attentive to images like the Undines, but avoid idleness and changeability. Be laborious and patient like the Gnomes but avoid grossness and avarice. So shalt thou gradually develop the powers of thy soul, and fit thyself to command the spirits of the elements.

The altar, as in the preceding degrees, represents the material universe, and on its right is the Garden of Eden, symbolized by the station of the **Hegemon**, and on its left is Gehenna, the abode of the shells, symbolized by the station of the **Kerux**."

HIEROPHANT: "I have much pleasure in conferring upon you the title of Lord/Lady of the Thirty-second Path. You will now quit the Temple for a short time, and on your return the ceremony of your reception to the grade of Theoricus will proceed."

(Kerux leads Zelator out of the Temple.)

Second Entrance

HIEROPHANT: Frater **Kerux**, you have my command to instruct the Zelator in the proper alarm. Honored **Hegemon**, guard the portal and admit them upon giving the proper alarm."

(**Kerux** presents candidate with necessary admission badge, Caduceus of Hermes, and instructs them to give the alarm of ||| ||| ||| knocks.)

(**Hegemon** admits them upon the alarm.)

HIEROPHANT: "Frater/Soror Perclinus de Faustis, in the Zelator grade you were given the symbolic representations of the Tree of the Knowledge Good and Evil, of the Gate of Eden and of the Holy Place. So, in the grade of Theoricus, the Sanctum Sanctorum with the Ark and Kerubim is shown, as well as the Garden of Eden with which it coincides; while in the thirty-second path leading here unto, through which you have just symbolically passed, the Kerubic guardians are represented and the palm trees or trees of progression in the Garden of Eden. Honored **Hegemon**, conduct the Zelator to the west, and place him thus before the portal of the thirty-second path by which he has symbolically entered.

(Zelator facing west.)

HIEREUS: "By what symbol does thou enter herein?"

HEGEMON: "By the particular emblem of the **Kerux**, which is the Caduceus of Hermes."

Caduceus of Hermes

(**Hiereus** takes emblem, shows it to Zelator.)

HIEREUS: "The Tree of Life and the three Mother letters are the keys to unlock the meaning of the Caduceus of Hermes. The upper point of the wand rests on Kether and the wings stretch out to Chokmah and Binah, the three Supernal sephiroth. The lower seven are embraced by the serpents, whose heads fall upon Chesed and Geburah. They are the twin serpents of Egypt, the currents of astral light. Furthermore, the wings and the top of the wand form the letter Shin, the symbol of Fire. The heads and upper halves of the serpents form Aleph, the symbol of Air, while their tails enclose Mem, the symbol of Water. The Fire of Life above, the Waters of Creation below, and the Air symbol vibrating between them."

(**Hierophant** goes to the east of the altar. **Hegemon** conducts candidate to the west of the altar to face the **Hierophant**, and then returns to her place in the south.)

Tree of Life

HIEROPHANT: "The symbols before you represent alike the Garden of Eden and the Holy of Holies. Before you stands the Tree of Life formed of the sephiroth and their connecting paths. Into its complete symbolism, it is impossible to enter here, for it is the key of all things when rightly understood. Upon each sephira are written in Hebrew letters its name, the Divine names ruling it, and those of the Angels and Archangels attributed to it. The connecting paths are twenty-two in number and they are distinguished by the twenty-two letters of the Hebrew alphabet, making with the ten

sephiroth themselves the Thirty-two Paths of Wisdom of the *Sepher Yetzirah*. The course of the Hebrew letters as placed on the paths forms, as you see, the symbol of the Serpent of Wisdom; while the natural succession of the sephiroth forms the path of the Flaming Sword, and the course of the lightning flash, as shown in the drawing.

Cross and Triangle and Pillars

The cross within the triangle, apex downwards, placed on the altar at the base of the Tree of Life refers to the four rivers of Paradise, while the angles of the triangle refer to the three sephiroth of Netzach, Hod, and Yesod. The two pillars right and left of the Tree are symbols of active and passive, masculine and feminine, Adam and Eve. They also allude to the pillars of Fire and Cloud which guided the Israelites in the wilderness, and the hot and moist natures are further marked by the Red Lamp and the cup of water. The pillars further represent the two Kerubim of the Ark; the right, Metatron, male; the left, Sandalphon, female. Above them ever burn the lamps of their spiritual essence, the higher life of which they are partakers in the eternal uncreated One.

(**Hierophant** gives Sign of Theoricus.)

HIEROPHANT: "Glory be unto thee, Lord of the land of life, for Thy splendor fills the Universe."

Grade Sign

The grade of Theoricus is referred to Yesod, as the grade of Zelator is to Malkuth. The path between them is assigned the letter Tav, whose portal you now see in the west, and through which you have just symbolically passed. To this grade certain secret signs and tokens are attributed. They consist of a sign, Grand Word, Mystic Number, and Password formed therefrom. The sign is thus given. Raise the arms level with the shoulders, bend the elbows, arms upwards, and hands bent outward, as if supporting a weight. It represents you in the path of Yesod, supporting the pillars of Mercy and Severity. It is the sign of the classical Greek god Atlas, supporting the Universe upon his shoulders, whom Hercules had to emulate. It is the Isis of Nature supporting the heavens. The Grand Word is a name of seven letters which means fast and mighty one, Shaddai El Chai. The Mystic Number is forty-five and from it is formed the Password which is Mem Heh, or Mah the secret name of the world of Formation. It should be lettered separately when given. Unto this grade and unto the sephira Yesod, the ninth path of the *Sepher Yetzirah* is referred. It is called the pure or clear intelligence, and it is so called because it purifieth and maketh clear the sephiroth, proveth and amendeth the forming of their representation, and disposeth their duties or harmonies, wherein they combine, without mutilation or division. The distinguishing badge of this grade, which you are now entitled to wear is the sash of the Zelator, with the addition of a violet colored cross above the triangle and the numbers two and nine

in a circle and a square respectively to the left and right of its summit. Beneath the triangle is the number thirty-two between two paralleled white lines."

(Hierophant proceeds to east. **Hegemon** comes forward and guides candidate before him.)

Watchtower of the East

HIEROPHANT: "The three portals facing you are the gates of the paths leading from this grade. That on the right connects with the grade of Philosophus, that on the left with the grade of Practicus, while the central one leads to the portal. This grade is especially referred to the element of Air, and therefore the great Watchtower or Terrestrial Tablet of the East forms one of its principal emblems. It is known as the first or great Eastern Quadrangle or Tablet of Air, and it is one of the four great Tablets delivered unto Enoch by the great Angel Ave. From it are drawn the three holy secret names of God ORO IBAH AOZPI which are borne upon the Banners of the East; and numberless Divine and Angelic names which appertain unto the element of Air.

Kamea of the Moon

To the Moon also is this grade related. Its Kamea or mystical square is formed of eighty-one squares containing the numbers from one to eighty-one arranged so as to show the same sum each way. Its ruling numbers are nine, eighty-one, three hundred sixty-nine, and three thousand three hundred twenty-one. This tablet (indicating it) shows the mystical seals and names drawn from the Kamea of the Moon. The seals are formed from lines drawn to and from certain numbers in the square. The name answering to nine is Hod, meaning glory; that answering to eighty-one is Elim, the plural of the Divine name El; that answering to three hundred sixty-nine is Chasmodai, the Spirit of the Moon. The other names are those of the intelligences and spirits of the Moon. On this tablet are shown the meanings of the lunar symbol when inscribed upon the Tree of Life. Thus, its crescent in increase represents the side of Mercy; and its crescent in decrease the side of Severity; while at full it reflects the Sun of Tiphareth."

(Hierophant goes back to position. **Hegemon** conducts candidate to the west with the **Hiereus**.)

Alchemical Sephiroth

HIEREUS: "The tablet before you shows the duplicated form of the alchemic sephiroth. In the first, the metallic root is in Kether, lead in Chokmah, tin in Binah, silver in Chesed, gold in Geburah, iron in Tiphareth. Netzach and Hod are the places of hermaphroditical brass. Yesod is mercury and Malkuth is the medicine of metals. In the second form the

mercury, sulfur and salt are referred to the three Supernal sephiroth, and the metals to the seven lower but in a rather different order. For in all things as Supernal so Terrestrial, is the Tree of Life to be found, whether it be in animal, vegetable or mineral natures."

(**Hegemon** leads candidate to his own tablet in south.)

Geometrical Figures to the Planets

HEGEMON: "This tablet shows you the Geometrical lineal figures attributed to the Planets. They are thus referred: The number three and the triangle to Saturn. The number four and the square to Jupiter. The number five and the pentagram to Mars. The number six and the hexagram to the Sun. The number seven and the heptagram to Venus. The number eight and the octagram to Mercury. The number nine and the enneagram to the Moon. Of these the heptagram and the octagram can be traced in two modes and the enneagram in three. The first in each case being most consistent to the nature of the planet."

(**Hegemon** resumes her position. **Kerux** comes forward and conducts the candidate to his tablet in the north.)

Sixteen Geomantic Figures

KERUX: "Before you are represented the sixteen figures of geomancy, which are formed from all the combinations which can possibly occur of single and double points in four lines. Two are attributed to each of the seven planets, and the remaining two to Caput and Cauda Draconis. Some of them are also attributed to Fire, others to Air, others to Earth and Water. They are also classified under the signs of the zodiac."

(**Kerux** conducts the candidate to the **Hierophant**.)

HIEROPHANT: "I now congratulate you upon having attained the grade of Theoricus, and in recognition thereof I confer upon you the Mystic Title of Poraios de Rejectis which means, "Brought from among the Rejected", and I give you the symbol of Ruach, which is the Hebrew name for Air. (Hierophant presents grade patches and stripes.) **Kerux**, you have my command to declare that the Zelator has been duly advanced to the grade of Theoricus."

KERUX: "In the name of Shaddai El Chai and by command of the Very Honored **Hierophant**, hear ye all that I proclaim that our Frater/Soror _____, having made sufficient progress in the study of occult sciences, has been duly advanced to the grade of Theoricus, Lord/Lady of the Thirty-second Path, and that he/she has received the

Mystic Title of Poraïos de Rejectis and the symbol of Ruach. Take your position in the Southwest."

HIEROPHANT: "Frater/Soror _____ before you are eligible for advancement to the next grade, you must be perfect in certain subjects, presented in a standard knowledge lecture. When you are perfect you must signify the same by letter or other acceptable means to the Scribe as in the preceding grades."

Closing

HIEROPHANT: (Knocks) "Fraters and Sorors, assist me to close the Temple in the grade of Theoricus. **Kerux**, see to it that the Temple is properly guarded." (Done.)

KERUX: "Very Honored **Hierophant**, the Temple is properly guarded." (Done.)

HIEROPHANT: "Let us adore the Lord and King of Air."

(**Hiereus**, **Hegemon** and **Kerux** move to position behind Hierophant.)
(All face east.)

Adoration

HIEROPHANT: "Shaddai El Chai, almighty and ever living, blessed be thy name unto the countless ages. Amen.

All give the 2=9 Grade Sign. (Done.)

Let us join together in the prayer of the Sylphs or Air spirits.

Spirit of Life, spirit of wisdom whose breath giveth forth and withdraweth the form of all living things; Thou, before whom the life of beings is but a shadow which changeth, and a vapor which passeth; Thou who mountest upon the clouds, and who walketh upon the wings of the wind, Thou who breathes forth Thy breath, and endless space is peopled; Thou who drawest in Thy breath and all that cometh from Thee returneth unto Thee; ceaseless movement in eternal stability. Be Thou eternally blessed.

We praise Thee and we bless Thee in the changless empire of created light, of shades, of reflections, and of images, and we aspire without cessation unto Thy immutable and imperishable brilliance. Let the ray of Thine intelligence and the warmth of Thy love penetrate even unto us, then that which is volatile shall be fixed, the shadow shall be a body, the spirit of Air shall be a soul, the dream shall be a thought. And no longer shall we be swept away by the tempest, but we shall hold the bridles of the winged steeds of dawn, and we shall direct the course of the evening breeze to fly before Thee. O Spirit of spirits! O eternal Soul of souls! O imperishable breath of life, O creative sigh! O mouth which breathes forth and withdraws the life of all beings, in the

The Hermetic Order Of The
GOLDEN DAWN^{Intl.}

TEMPLE SYMBOLISM

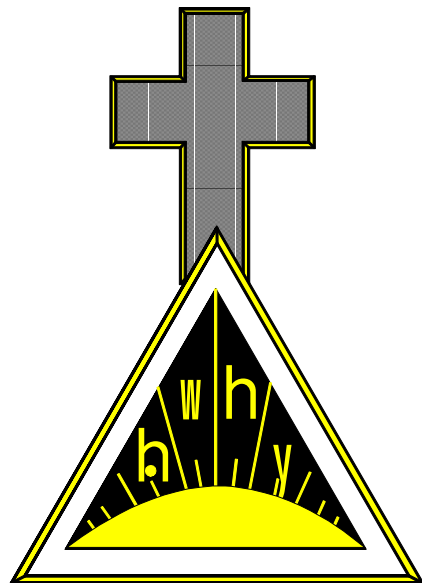

THEORICUS 2=9

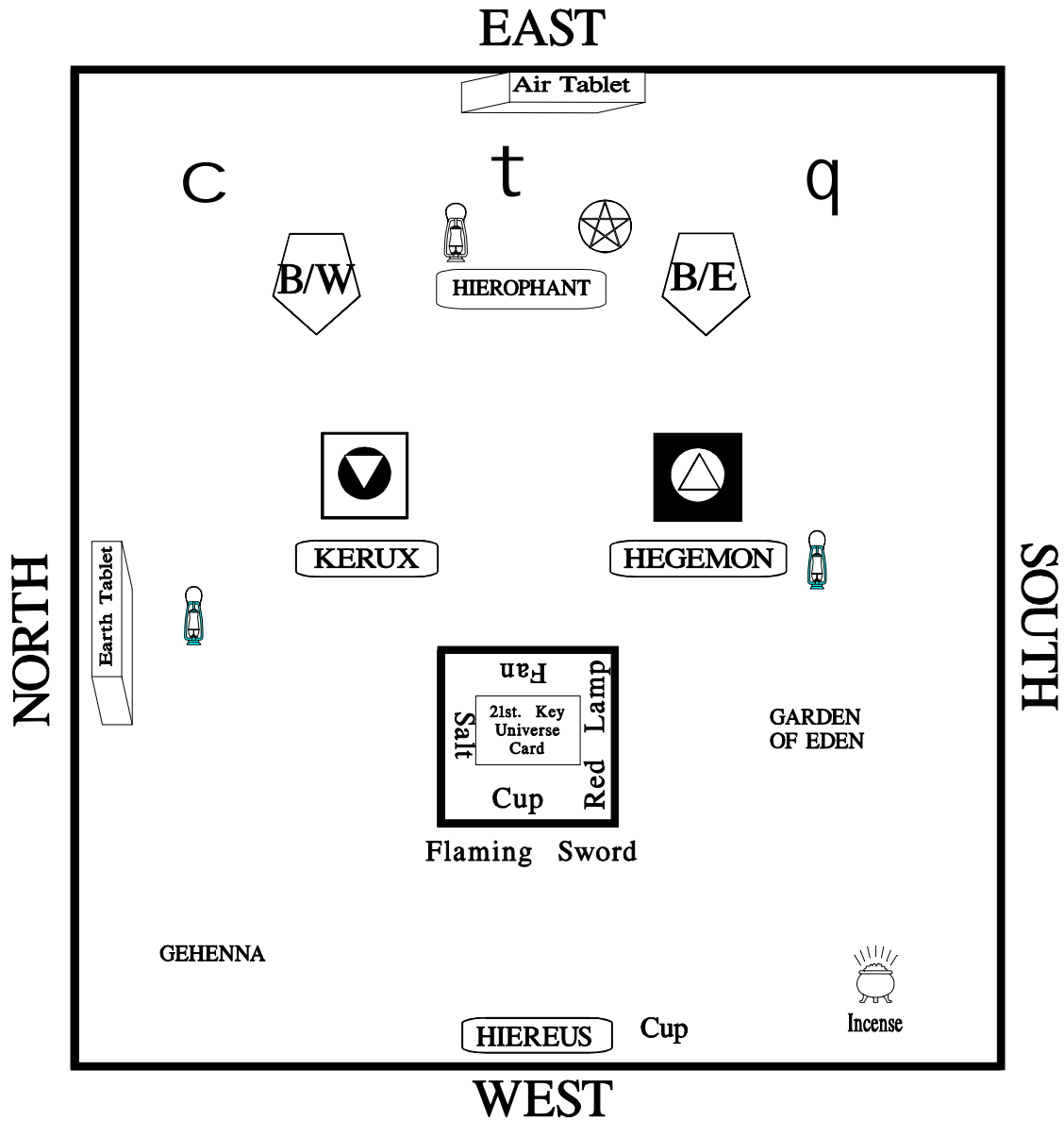

Entrance into t

This is the Temple setup for the Theoricus Initiation and the entrance into the path of t. Notice how the pillars are moved back and the Hebrew letters change after the candidate quits the Temple and returns to enter dwsy.

The entrance badge for the path of t is the Greek Cubical Cross.

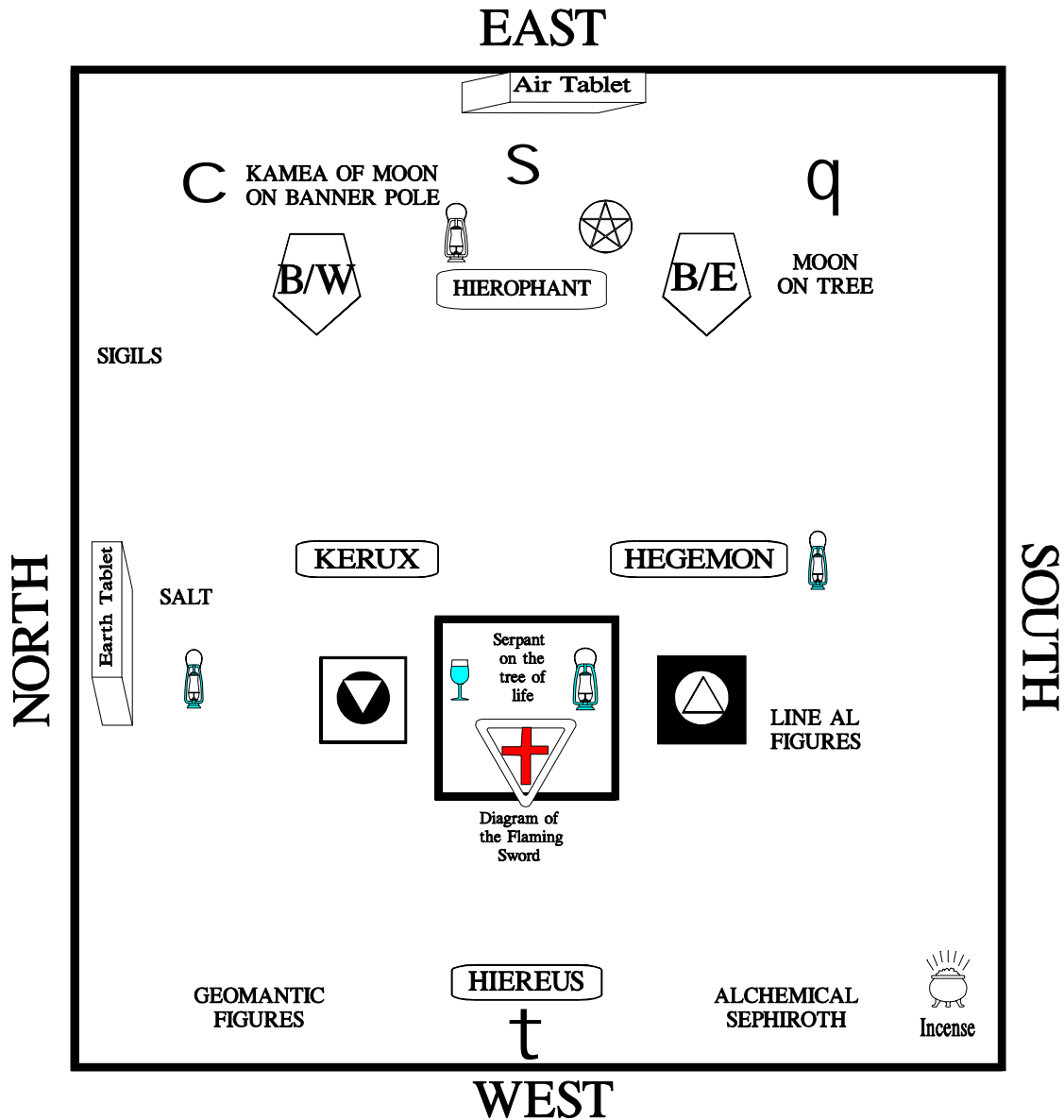

Entrance into dwsy

The cross within the triangle with the apex pointing downward placed upon the altar, based on the Tree of Life, refers to the four rivers of Paradise. The angles of the triangle represent the three sephiroth of $j\ x\ n$, $d\ w\ h$ and $d\ w\ s\ y$. The two pillars on the right and left of the Tree are symbols of the active and passive, male and female, Adam and Eve. They also refer to the Pillars of Fire and Cloud which guided the Israelites in the wilderness. The hot and moist natures are further marked by the Red Lamp and the cup of water. The pillars further represent the two Kerubim of the Ark, the right being

Metatron, male, and the left is Sandalphon, which is female. (*The Theoricus Ritual of the Golden Dawn*, Lewellyn publications, Volume II, book II). The above is from the initiation of the Theoricus. It gives you a basic idea of the Temple layout in this ceremony. If you are a correspondence member, the Temple is laid out for you in this fashion and the ritual is performed astrally. If you are a Temple member at one of the Golden Dawn Temples, then you have the benefit of going through the initiation physically.

The Theoricus grade is attributed to the sephira $\text{d}\text{w}\text{s}\text{y}$, just as the Zelator grade is associated with the sephira $\text{t}\text{w}\text{k}\text{l}\text{m}$. All of the center sephiroth of the Qabalistic Tree of Life are of the element of Air, except $\text{t}\text{w}\text{k}\text{l}\text{m}$, and thus the element of this grade is Air. It is also the grade of the Moon, for the Moon is attributed to $\text{d}\text{w}\text{s}\text{y}$. We know that Air deals with thought and it is here in the Theoricus grade that the initiate must gain control over his thoughts and his fears. This is not always an easy task because the planet of this grade is the Moon, and the Moon is the planet of fluctuation. This grade is also attributed to the four Kerubim, which are associated with the Divine name of YHVH. We know that the Kerubic forces come together in the path of t and thus the candidate must traverse the path of t , the thirty-second path of the Qabalistic Tree of Life, in his journey into $\text{d}\text{w}\text{s}\text{y}$.

There are four officers in the Theoricus grade. All of the officers must be of 2=9 or higher. In the Hermetic Order of the Golden Dawn, the office position of Dadouchos and Stolistes may be held by a Zelator, or someone holding the grade of 1=10. Therefore, these officers are not employed in the Theoricus grade ceremony. In this grade you will notice that the Hierophant, Hegemon, Hieres, and the Kerux are positioned in four equal parts around the Temple. The Hierophant is in the east between the Banner of the East and Banner of the West, the Hegemon in the south, the Hieres in the west and the Kerux in the north. This is a position of balance as required when traversing the path of t . The pillars in this grade are positioned in the east. There is one other interesting piece of symbolism in this particular grade. That is that there are four officers, the four always alluding to the sephira of dsj . dsj is the first sephira of manifestation below the great Abyss of the Qabalistic Tree of Life, thus giving creation a foundation. $\text{d}\text{w}\text{s}\text{y}$ is the sephira of foundation prior to manifestation into the Kingdom.

The candidate in this initiation will quit the Temple one time during the ceremony. First the candidate will traverse the thirty-second path. After traversing the thirty-second path on the Qabalistic Tree of Life, the candidate will quit the Temple and the Temple will be rearranged. Then the candidate will be brought back into the Temple for the ceremony of his/her advancement into the grade of Theoricus.

The Hermetic Order Of The
GOLDEN DAWN^{Intl.}

**TEMPLE SYMBOLISM OF
THE THEORICUS GRADE**

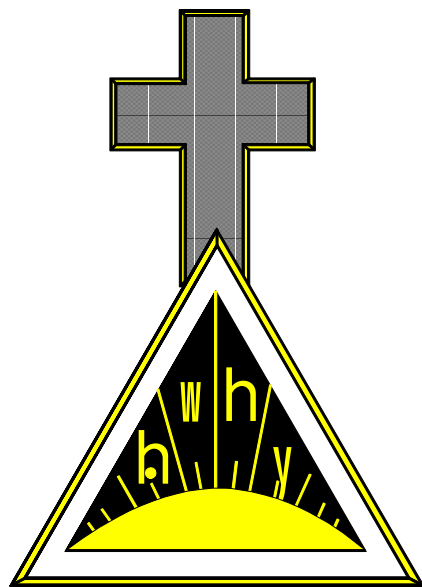

THEORICUS 2=9

The Theoricus grade is attributed to the sephira dwsy , just as the Zelator grade is associated with the sephira twklm . All of the center sephiroth of the Qabalistic Tree of Life are of the element of Air, except twklm , and thus the element of this grade is the grade of Air. It is also the grade of the Moon, for the Moon is attributed to dwsy . We know that Air deals with thought and it is here in the Theoricus grade that the initiate must gain control over his thoughts and his fears. This is not always an easy task because the planet of this grade is the Moon, and the Moon is the planet of fluctuation. This grade is also attributed to the four Kerubim, which are associated with the Divine name of YHWH. We know that the Kerubic forces come together in the path of t and thus the candidate must traverse the path of t , the thirty-second path of the Qabalistic Tree of Life, in his journey into dwsy .

There are four officers in the Theoricus grade. All of the officers must be of 2=9 or higher. In the Hermetic Order of the Golden Dawn, the office position of Dadouchos and Stolistes may be held by a Zelator, or someone holding the grade of 1=10. Therefore, these officers are not employed in the Theoricus grade ceremony. In this grade you will notice that the Hierophant, Hegemon, Hieres, and the Kerux are positioned in four equal parts around the Temple. The Hierophant is in the east between the Banner of the East and Banner of the West, the Hegemon in the south, the Hieres in the west and the Kerux in the north. This is a position of balance as required through traversing the path of t . The pillars in this grade are positioned in the east. There is one other interesting piece of symbolism in this particular grade. That is that there are four officers, the four always alluding to the sephira of dsj . dsj is the first sephira of manifestation below the great Abyss of the Qabalistic Tree of Life, thus giving creation a foundation. dwsy is the sephira of Foundation prior to manifestation into the Kingdom.

The candidate in this initiation will quit the Temple one time during the ceremony. First the candidate will traverse the thirty-second path. After traversing the thirty-second path on the Qabalistic Tree of Life, the candidate will quit the Temple and the Temple will be re-arranged. Then the candidate will be brought back into the Temple for the ceremony of the advancement of Theoricus.



The Cross within the triangle, with the apex pointing downwards and placed upon the altar is based on the Tree of Life. It refers to the four rivers of Paradise. The angles represent, jxn , dwh , and dwsy .

The Hermetic Order Of The
GOLDEN DAWN^{Intl.}

**SYMBOLISM OF THE
THEORICUS GRADE**

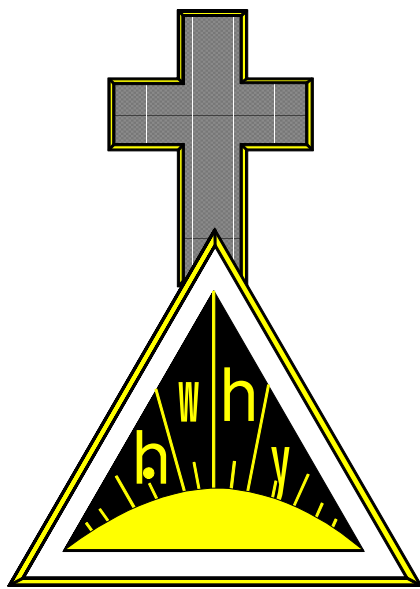

THEORICUS 2=9

The grade of Theoricus is attributed to the element of Air. This is exclaimed during the Theoricus grade ritual by the Hegemon. The planet that this grade refers to is the Moon, and it is the Hieres who exclaims this during the grade ritual. The Hieres states that it is the thirty-second path of t , the Universe, as composed of the four elements as well as the Kerubim, the Qlipoth, the astral plane and the reflection of the sphere of Saturn. The invocation of Air is important in the preparation of this ceremony, and as such the Hierophant of the Temple invokes Shaddai El Chai. In the ceremony, the Archangel of Air is also called upon, Raphael. Lastly, the energies of the Divine names that rule over the Watchtower of the East, ORO IBAH AOZPI, as well as the great King of the East, Bataivah are invoked. All of this is done under the auspices of Shaddai El Chai.

The Theoricus will remember that in the Zelator grade, the Grand Word or Divine name is Adonai Ha Aretz. The mystic title is "Periclinus de Faustis." The mystical number of Zelator is fifty-five. The mystic password is hm. It is here in the grade of Theoricus that the Grand Word changes to Shaddai El Chai, which means Almighty and Ever Living One. The mystic number is forty-five which is formed from the password hm, which is the secret name of the world of Formation. This overall correspondence of the grade of Theoricus falls under the sephira of dwsy . It is called "The Pure and Clear Intelligence", and so called because it purifies and makes clear the sephiroth. It also harmonizes all the sephiroth while removing division. In this grade the Theoricus now adds to his/her Zelator sash the symbol of Theoricus. This is the violet cross with the $2=9$ symbol in a circle and a square. In addition the Theoricus adds to his or her sash a colored strip of ribbon indication that he or she is Lord or Lady of the Thirty-second Path of t .

The entrance badge for the path of t in the grade of Theoricus is the Greek Cubical Cross. The Zelator, upon entering the Temple, is instructed by the Hierophant to take the Cubical Cross in his left hand and the Banner of Light, the Banner of the East, in his right hand while following his guide Anubis, who will lead him from the material into the spiritual.

The elements are now portrayed and infused in a balanced manner much in the same way that they are portrayed in the path of t . You must remember that in your studies of the path of t , that t is the only path that is self balancing. So, the ritual naturally takes a direction that portrays this naturally balancing path. The Zelator, as he goes through the Theoricus ritual, is faced with these elements. First is the Hieres who says that he is the synthesis of the elemental forces. Also, that he is a symbol of man and a symbol of life and death. This should be equated with the esoteric title of the path of t which is, "The Great One of the Night of Time." But here the Hieres states that he is the "Child of the Night of Time", meaning that he is the offspring of "The Great One of the Night of Time."

So, the aspirant on his journey throughout the Temple first meets Osiris, who bars him from passing through the gate of the eastern heavens unless he can exclaim the secret name. This is said by the Kerux who says, "Thou art Nu, Goddess of the Firmament of Air, thou art Hormaku, Lord of the eastern Sun." The Hierophant then responds, "In what signs and symbols do you come?" The Kerux answers for the aspirant saying, "In the letter a, in the Banner of Light, in the symbol of equated forces."

It is very important to understand that each element is penetrated in the Theoricus grade through the equated forces of balance as exemplified through the Cubical Cross. Here the aspirant is holding fast to the Banner of Light, the banner of his higher aspirations, the synthesis of balance, if you will, and the symbol of his Higher Genius. At the same time, he is holding on to the Cubical Cross, which is also the synthesis of elemental balance. He is then saying that I can enter this way because I can balance myself and therefore I deserve to have the availability to enter this path and this element of Air.

On the elemental journey, the aspirant runs into Fire, which is the priest with the mask of the Lion. Again, the Kerux exclaims the name of the lion, Mau, Lord of Fire, Ra, the Sun in his strength. Afterward, the Kerux exclaims for the candidate that he comes in the letter c, the Banner of the East, and the symbol of the Cubical Cross. Again, the penetration of Fire takes place, but through a balanced vehicle. This vehicle is the higher aspiration of the candidate and the symbol of the Cubical Cross.

Now the candidate faces the priest with the mask of the eagle. This time the Hegemon responds for the candidate and says that he is, "Heka, mistress of Hesur, ruler of Water is thy name, thou art Toum, the setting Sun." Here the Hegemon states for the candidate that he comes in the letter m, the banner of Light as well as the symbol of the twenty-two letters which are portrayed on the Cubical Cross. It is at this point that the candidate enters the element of Water through the balanced forces of all the elements.

Finally, the candidate faces the priest with the mask of the Ox. This is the Kerubic emblem of Earth. "Thou cannot pass the gate of the northern heaven unless thou can tell me my name," is proclaimed aloud as the aspirant arrives at the north. The Hegemon responds for the candidate, "Satem, in the abode of Shu, the Bull of Earth is thy name, thou art Kephra, the Sun at night." The Hegemon goes on to say that he comes in the letters a, m and c and in the symbol of the Banner and the Cross. So now at this point, all three of the Mother letters have been invoked into the candidate. The candidate has been passed through with the keys to understanding this grade. So, it is through these energies that the final element of Earth is portrayed, or as could be exemplified through final h of the Tetragrammaton. This is actually a portrayal of the letter t, the four elements in balance.

The Cubical Cross is a wonderful emblem to exemplify these balanced forces coming together in the letter and the path of t, which is also the Universe card of the Tarot. It is composed of twenty-two squares externally.

This refers to the twenty-two letters that are placed on it. Here we see in the ceremony that the Hierophant says, "Twenty-two are the letters of the Eternal Voice, in the Vault of Heaven, in the depths of Earth, in the abyss of Water, in the all presence of Fire. Heaven cannot speak their fullness and Earth cannot utter it." The path of t is called the "Administrative Intelligence" because it directs and associates all the operations of the seven planets in their due course. Thusly to it is attributed the knowledge of the seven abodes of Assiah, the material world, which can also be symbolized in the Apocalypse by the seven churches. In addition, the thirty-second path can also refer to the Universe as composed of four elements, to the Kerubim or the kerubic energies, to the Qlipoth, and to the astral plane as well. It is a reflection of

the sphere of Saturn and the heaven of Assiah attributed to the path of t is Saturn. It is a linked path and the way it works is that it connects the material world in the formative world of Assiah with Yetzirah. In so doing, what passes through the astral plane is the abodes of the elementals as well as the shells of the dead. In other words, it can be stated that it is the passing through the gate of Eden.

The next point of consideration is the actual depiction of the Tarot card of the Universe. Some of the highlights of this path are: The seventy-two small circles referring to the Schemhamporesch or the seventy-two fold name of God. These are depicted on the card many times as little dots or stars in an oval form. The twelve large circles form the zodiac. At the four angles of the card are the Kerubim, which verifies the power of the Tetragrammaton operating through the elements on this path. This is a path of all the elements in perfect balance and harmony. They are the Sylphs, Undines, Salamanders and Gnomes.

The final exhortation from the Hierophant to the candidate is for him to be prompt and active as the Sylphs but avoid frivolity and caprice. This is very important, for as we learn the element of Air, we must also learn to manage the Air. Consequently, we must learn to act swiftly and without hesitation. However, we must also learn to manage in our lives the unnecessary frivolity and caprice so that we can squeeze out the most of our potential.

Be energetic and strong like the Salamanders, but again, Salamanders are represented by Fire and we must avoid irritability and ferocity. Next, we must be flexible and attentive to images like the Undines but avoid idleness and changeability. The final word of caution is to be laborious and patient like the Gnomes but avoid grossness and avarice.

It is at this point that the Hierophant confers the title of Lord or Lady of the Thirty-second Path upon the recipient. The Temple is rearranged and the candidate quits the Temple for a short period of time only to be brought back to the Temple for the second half of the initiation. Upon his return, the Zelator carries with him a different admission badge. He is asked upon entering, "By what symbol do ye enter?" The Hegemon responds for him: "By this symbol of the Caduceus of Hermes." This is the entrance badge into dmsy. It is important to understand that the Tree of Life in combination with the three Mother letters are really the key to understanding and unlocking the secrets of the Caduceus of Hermes. The upper point of the Caduceus Wand rests upon rtk, the wings stretch out to hmkj and hnyb, which combine the three Supernals. The lower seven sephiroth are embraced by the serpents whose heads fall directly upon hrwbg and dsj. They are called the Twin Serpents of Egypt. They are the currents of astral light. Many mystical groups spend most of their time in idol worship of these serpents or astral light, but it is really the wings on the Caduceus that we must aspire to, for they govern the serpents. In other words, the Higher Nature must govern the lower nature. We are not Christianizing or preaching any form of morals by any means; let us make this clear. What we are saying is that we must always act with our Higher Nature and our True Will in our most profound interest. For unless we do so, we fall prey to the serpents who would swallow and devour us and consequently never attain the true freedom that the wings of the Caduceus can bring us through the light of the Supernals. In addition, the wings at the top of the Caduceus form the letter c, which is the symbol

of Fire. The heads in the upper halves of the serpents form the letter a, which is the symbol of Air. The tail which intertwines, forms the letter m, which is the symbol of Water. Thus we have the Fire of life above, the Water of creation below, and the Air symbol vibrating between them.

Next we are introduced directly to the Tree of Life which is formed of the sephiroth and the connecting paths in a complete symbolism. This includes the Hebrew symbols, Divine names, the names of the Archangels and Angels. In the study of the Hebrew letters as they are placed on the paths, we see that they form the symbol of the Serpent of Wisdom. While on the other hand the natural succession of the sephiroth form the Flaming Sword of Creation, the course of the lightening flash. In addition, there is depicted the two pillars on the right and left side of the Tree symbolizing the active and passive energies, the Yin and Yang, the Male and Female. They allude to the pillars of Fire and Cloud, which is stated in the initiation itself that the pillars guided the Israelites into the wilderness. The pillars further represent the two Kerubim of the Ark of the Covenant. The one to the right is Metatron, male, and the one to the left is Sandalphon, female.

The next important symbolism given is the Theoricus Grade Sign. There is a separate lesson regarding the concepts of this, so time will not be spent on it in this lesson other than to say that it represents the path of dmsy supporting the pillars of Severity and Mercy. It is the sign made by the Greek god Atlas. It is also portrayed as the Isis of Nature supporting the heavens. In addition, in the Theoricus grade we introduce the new Theoricus to the three secret names of God borne upon the Banners of the East, which are ORO IBAH AYZPI. Also introduced is the Kamea of the Moon and its mystical square. It is interesting to note that when the Moon is increasing, it is on the side of Mercy, while in its decrease it is on the side of Severity. When the Moon is full it reflects the Sun of trapt. This should be kept in mind for later serious magical workings.

The Theoricus is given the mystical title Poraio de Rejectis, which means brought from among the rejected.

The final adoration is very succinct and should be repeated from time to time, at least on a weekly basis by the Theoricus, as he passes through the element of Air.

It is as follows:

"Spirit of Life, spirit of Wisdom whose breath giveth forth and withdraweth the form of all things. Thou before whom the life of beings is but a shadow which changeth and a vapor which passeth. Thou who mountest upon the clouds and who walkest upon the wings of the wind. Thou who breathes forth thy breath and endless space is peopled. Thou who draws in thy breath and all that cometh from thee returneth unto thee. Ceaseless motion in eternal stability, be Thou eternally blessed. We praise Thee and we bless Thee in the changeless empire of created light, of shades and reflections, and of images. We aspire without cessation unto Thy immutable and imperishable brilliance. Let the ray of Thine intelligence and warmth of Thy love penetrate even unto us. Then that which is volatile shall be fixed, the shadow shall be a body, the spirit of Air shall be a soul, the dream shall be a thought, and no more shall we be swept away by

the tempest, but we shall hold the bridles of the winged steeds of dawn. We shall direct the course of the evening breeze to fly before Thee. O Spirit of spirits. O eternal Soul of souls. O imperishable Breath of Life. O Creative Sigh. O mouth which breathes forth and withdraws the life of all beings in the flux and reflux of Thine eternal word, which is the Divine ocean of movement and of truth. Amen."

The above is the Golden Dawn's prayer of the Sylphs, the Air spirits.

The Hermetic Order Of The
GOLDEN DAWN^{Intl.}

**THE CADUCEUS OF
HERMES**

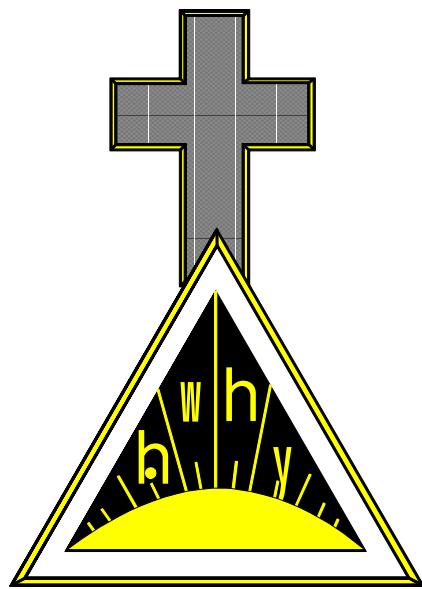

THEORICUS 2=9

Entrance Badge into dny of the Theoricus Initiation



"The upper point of the wand rests on rtk and the wings stretch out to hmkj and hnyb, the three Supernal sephiroth. The lower seven are embraced by the serpents whose heads rest on dsj and hrwbq. They are the Twin Serpents of Egypt, the currents of astral light. Furthermore, the wings and the top of the wand form the letter c, the symbol of Fire. The head and the upper halves of the serpents form a, the symbol of Air. Their tails enclose m, the symbol of Water. All together it forms the Fire of Life above, the Water of Creation below, and the Air symbol vibrating between them." (Theoricus Ritual, the *Golden Dawn*, Lewellyn publications, Volume II, book II). It is interesting to note that this is one of the most beautiful symbols that can be analyzed and studied. We see that the Caduceus represents both the Fire of Life and the Waters of Creation, with the reconciler between these two, the symbol of Air. It is Air that acts as a reconciling agent between Fire and Water. Remember, in all things there are always two opposing forces and a third force that reconciles them. We see that the three elements of the Mother letters are reconciled by the Caduceus. We also see that the reconciliation and unification of the Supernals is represented by the top of the Caduceus and by its wings. Again, this is a symbol that can be meditated on on a regular basis in the Theoricus grade.

The badge can be painted primarily yellow with violet as a secondary color. The scales should be green. The sephiroth should be in the Queen scale of colors that were memorized in the Neophyte grade.

The Hermetic Order Of The
GOLDEN DAWN Intl.

**THE GREEK CUBICAL
CROSS**

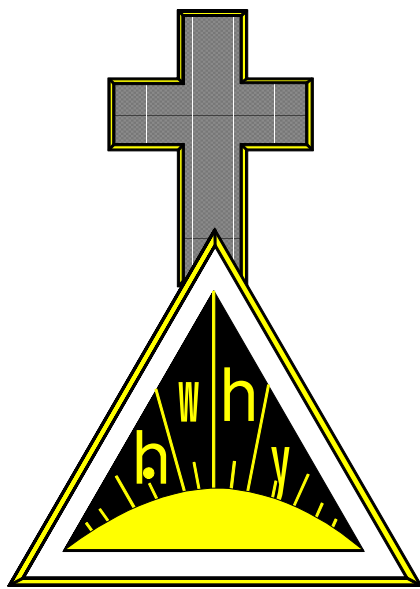

THEORICUS 2=9

Entrance Badge of the Path of t of the Theoricus Initiation

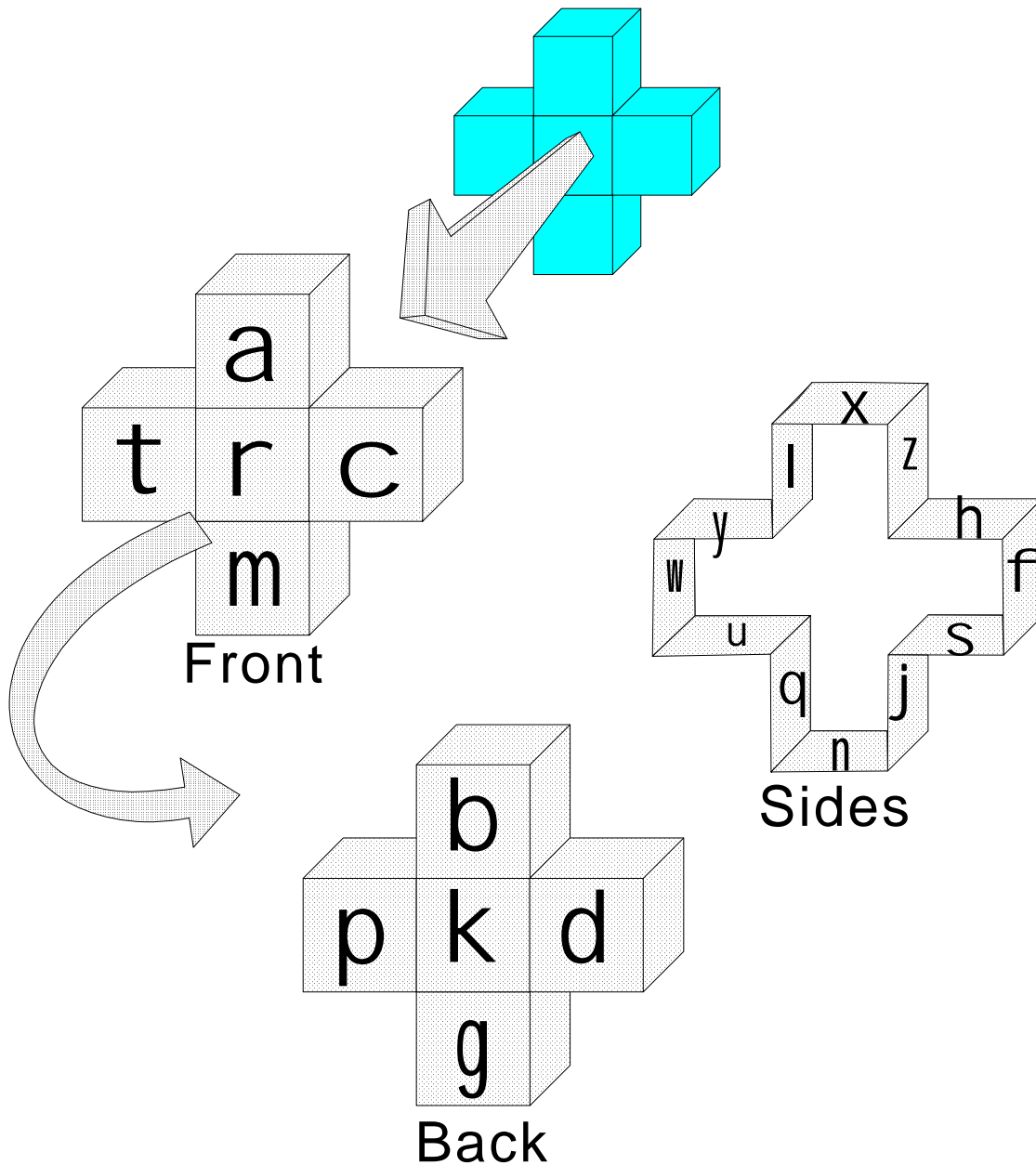

"The Cubical Cross is a fitting emblem of the equilibrated and balanced forces of the elements. It is composed of twenty-two squares externally and thus refers to the twenty-two letters placed thereon. Twenty-two are the letters of the Eternal Voice in the Vault of Heaven and in the depths of Earth, in the Abyss of the water and in the all presence of Fire. Heaven cannot speak their fullness, Earth cannot utter it. It hath the

Creator in all things. He has mingled them in Water, He has whirled them aloft in Fire, He has sealed them in the Air of Heaven, He has distributed them through the planets. He has assigned unto them the twelve constellations of the Universe." (From the Theoricus Ritual of the Golden Dawn). This is an excellent symbol for the Theoricus to both meditate on and to contemplate. It is the entrance badge into the path of t.

The drawing has been made large enough to be colored and it should be mediated on daily.

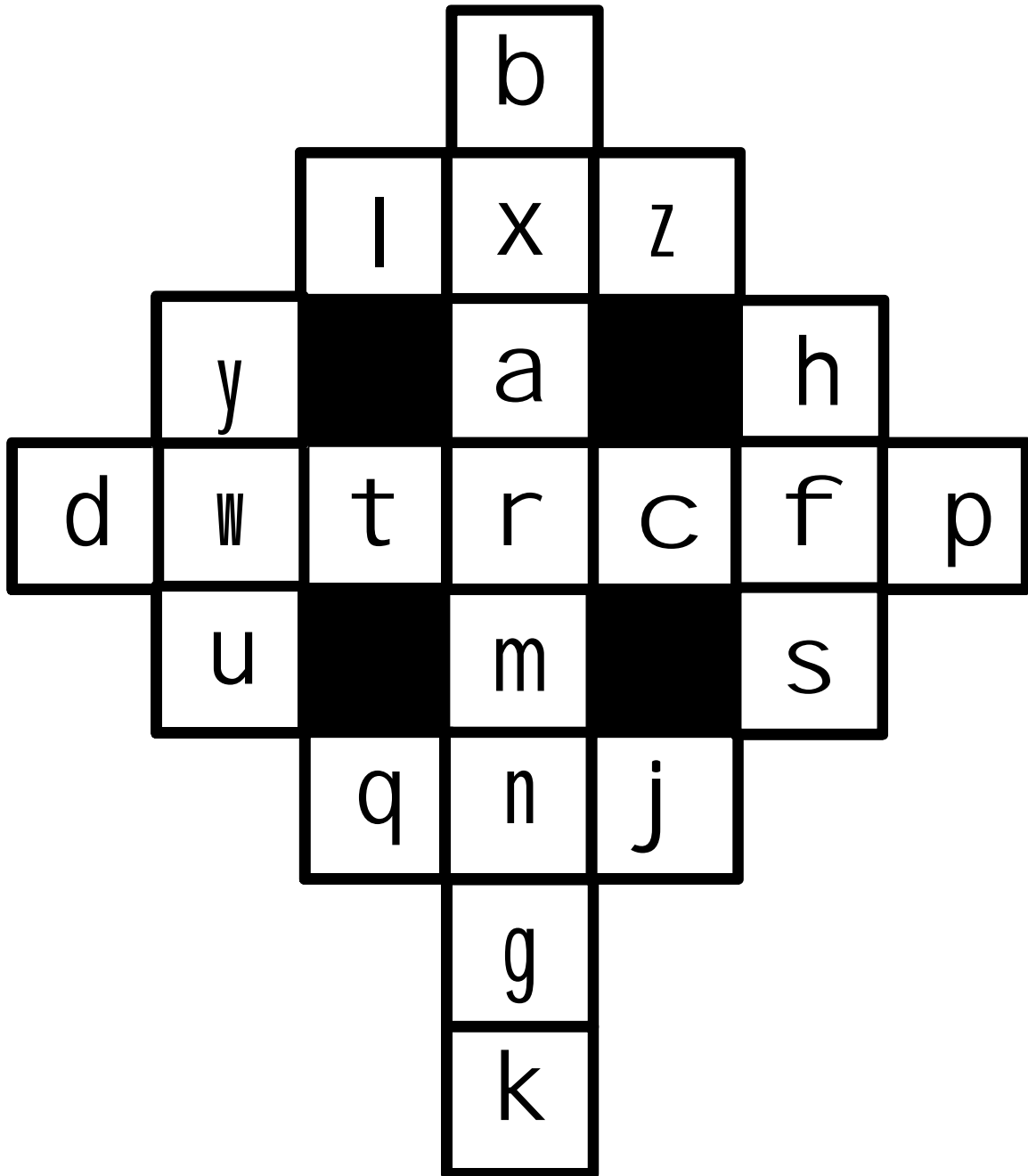

The Hermetic Order of the
Morning Star

**GARDEN OF EDEN AND THE
HOLY CITY OF THE
APOCALYPSE**

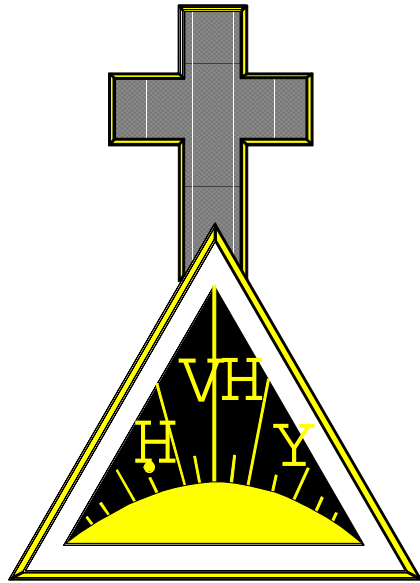

THEORICUS 2=9

FFFTThis drawing shows in part the occult symbolism of the Garden of Eden and the Holy City of the Apocalypse. The outer circle is the enclosing Paradisiacal Wall guarded by the Kerubim, the Flame, and the seven squares which are the seven mansions thereof, or the seven spheres, wherein Tetragrammaton Elohim planted every tree that is pleasant and good for food, symbolized by the palm trees wrought on the veil of the Tabernacle and the door of the Holy of Holies in the Temple. But in the midst is the Tree of Life, the Throne of God, and the Lamb. Twelve are the foundations and twelve are the gates, shown as the twelve entrances in the drawing. The four streams rising from one central fountain are the rivers of Eden, referring to the four elements proceeding from the Omnipresent Spirit.

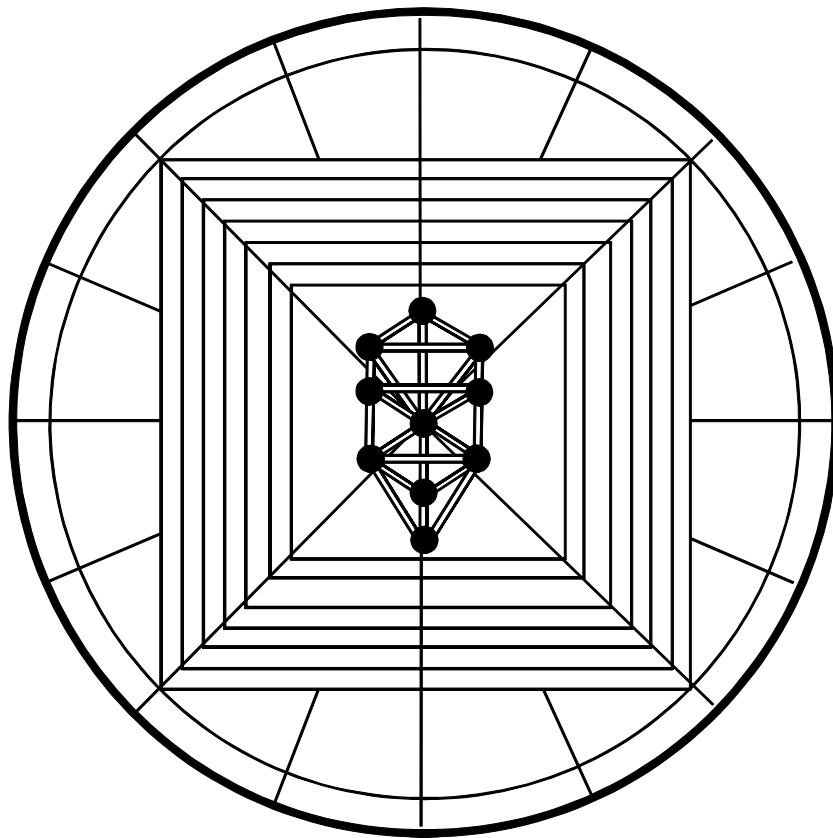

The Garden of Eden

The Hermetic Order Of The
GOLDEN DAWN^{Intl.}

INFERNAL HABITATIONS

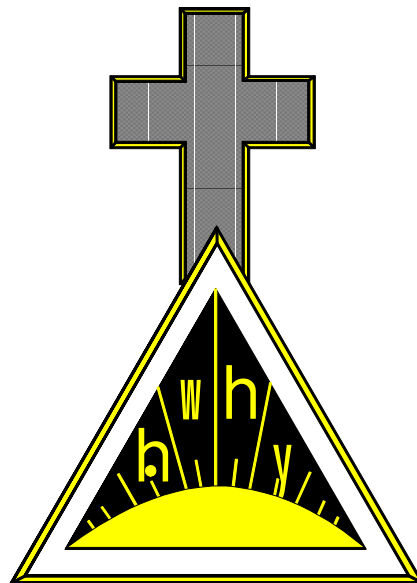

THEORICUS 2=9

This drawing represents the seven Infernal Mansions and the four Seas. The first circle represents the Waters of Tears; the second, the Waters of Creation; the third the Waters of Ocean; the fourth, the False Sea. In the inner circles are, on the right hand, the seven earths, which are: 1) Aretz; 2) Adamah; 3) Gia; 4) Neschiah; 5) Tziah; 6) Arega; and 7) Thebel or Cheled. On the left hand are the seven Infernal habitations, which are: 1) Sheol; 2) Abaddon; 3) Titahion; 4) Bar Schauheth; 5) Tzelmoth; 6) Shaari Moth; and 7) Gehinnon.

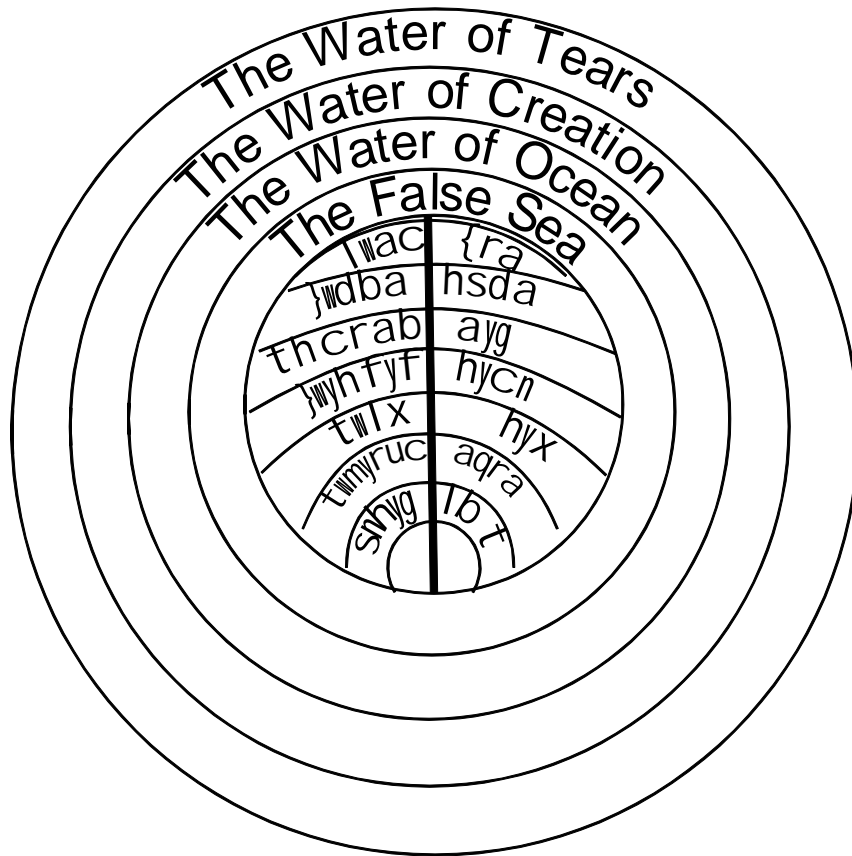

Infernal Habitations

The Hermetic Order Of The
GOLDEN DAWN^{Intl.}

THEORICUS GRADE SIGN

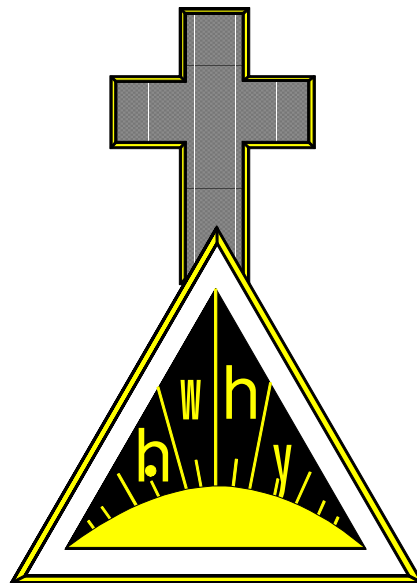

THEORICUS 2=9

As of now you have surpassed the trials and tribulations of building the grounds of your foundation in the 1=10 grade of Zelator, Worker of the Realm. In all construction workings, everything must be built from the ground up. Moving from a more solid and stable stage, you now venture forth into the grade of Theoricus 2=9, Worker of the Air.

The grade allotted to this sign is Theoricus, thus corresponding to the sephira of dwsy . This marks the third step in your advancement in the Hermetic Order of the Golden Dawn and the Tree of Life, the first two being that of Neophyte and Zelator.

Some objectives that will be learned are those dealing with the qualities of Air. Briefly, they refer to those of thoughts, communication, and mental powers, as well as all dealings of fluidity of thought. Some of the energies that will be dealt with in this elemental grade revolve mostly around the Divine names, the Archangel, Angels, spirits and energies of the element. All these are titled under the auspices of the Divine name inscribed upon the great Watchtower of the East.

The Grade Sign is formed by raising both arms up until they are level with your shoulders. Then bend both elbows upwards and extend your hands back as if holding an object on them. This sign is symbolic of being a traveler on the thirty-second path of t leading from twklm and the 1=10 grade of Zelator into the sephira of dwsy , the 2=9 grade of Theoricus. This sign also alludes to the mighty Atlas who held up the heavens upon his shoulders.



Considering that the thirty-second path is a balancing path, you as a traveler become balanced yourself. The symbol that represents the forces of balance is the scales. Some forces that the scales balance are referring to karma and the pillars of balance, primarily speaking of the pillar of Severity and the pillar of Mercy.

Like all other Grade Signs, the Theoricus Grade Sign is one that is especially attributed to its own particular element. The Grade Sign is attributed to Air. In displaying the sign you not only display its gesture, but you are also representing the powers and mysteries that the element of Air holds.

The Grade Sign itself has quite a few uses, both practically and ceremonially. One use for the sign is for all specific workings that are done with the Tattwas. Communications done in the Tattwas by means of Grade Signs, especially as referred to the one of Vayu, help to identify the plane that you are working with. Moreover, you may find a guide to help in leading you through the plane safely.

Another use concerning magical workings deals within the system of Enochian, referring to the Enochian Watchtowers, particularly the eastern quadrant. In the grade of 2=9, one particular energy that the Theoricus is almost drawn to immediately is that which is known as the great Archangel Raphael, for he is the guide and refuge of the Worker of the Air. One lesson in this grade refers to communing with the Archangel by means of the L.I.R.P.. When conversing with him through this method, it is customary to give the Theoricus Grade Sign for identification and bonding with each other.

A very good way for developing a better effect with the grade sign is to apply it to your daily life. Some suggested uses are as follows.

Mornings

As you rise out of bed, perform your Grade Sign and say:

"May the flow of air fill my mind with light through the name of Shaddai El Chai."

Bathing

Before or during a shower, or when you take a bath, say:

"Let the Air that courses through the Water purge my soul in the name of Shaddai El Chai."

When Retiring

As you prepare to go to sleep, make the Grade Sign and say:

"May the power of Shaddai El Chai rest upon me and keep me safe in my dreams."

Daily use of the Grade Sign and constant affirmations throughout the day allow the subconscious mind to absorb the mystical meaning behind the gesture. Although the gesture is very simple, it is not to be taken lightly. Signs and symbols alike are types of language to the mind. So, in considering this, one goal that the student tries to strive for is the engraining of the symbols into his own mind. This is to say that it isn't just a part of the memory, but it grows as a part of your entire being.

The Hermetic Order Of The
GOLDEN DAWN^{Intl.}

THEORICUS GRADE SASH

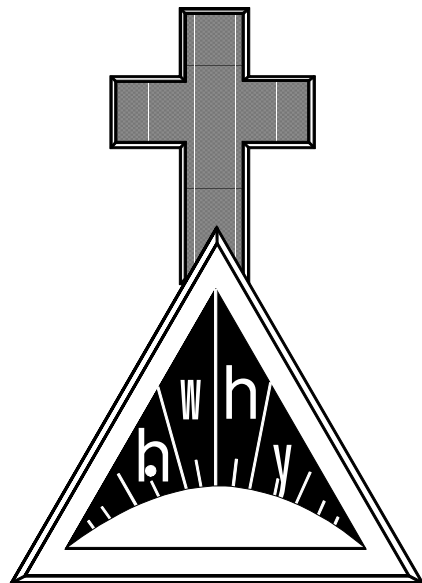

THEORICUS 2=9

To make your Theoricus advancement complete, the distinguishing badge of the grade must be added to your Zelator sash. In addition to the badge, one violet stripe is added. This signifies your title as Lord or Lady of the Thirty-second Path.

The badge is represented by a two, a nine and a cross. As the Zelator sash, the two is placed inside a circle, and the nine inside of a square. All of these are in the color of violet in accordance to the sephira attributed to your grade.

The entire sash as a whole indicates your advancement into another grade, as well as your ascension unto the Higher.

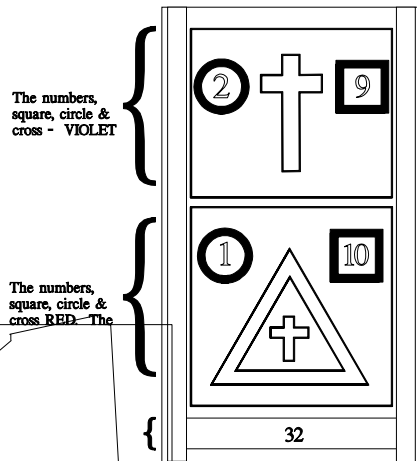

The Hermetic Order Of The
GOLDEN DAWN^{Intl.}

THE WATCHTOWER OF THE
EAST

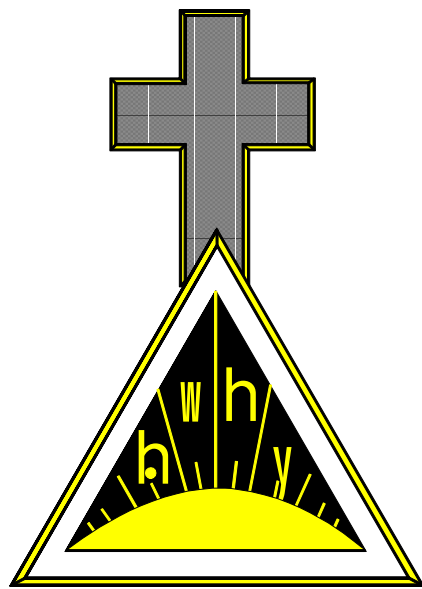

THEORICUS 2=9

This grade is referred directly to the element of Air, and, therefore, it is here that we encounter the Great Watchtower of the East given unto Enoch by the Great Angel Ave. It is known as the Great Eastern Quadrangle or Tablet of Air. Derived from this tablet are the three secret names of God, Oro Ibah Aozpi, which are borne upon the Banner of the East. There are numberless Divine and Angelic names which can be obtained from the Tablet of Air which refer to the element of Air.

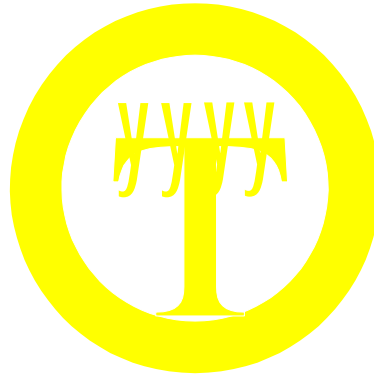

r	Z	i	l	a	f	A	y	t	l	p	a
a	r	d	Z	a	i	d	p	a	L	a	m
c	z	o	n	S	a	r	o	Y	a	v	b
T	o	i	T	t	z	o	P	a	c	o	C
S	i	g	a	s	o	m	r	b	z	n	h
f	m	o	n	d	a	T	d	i	a	r	i
o	r	o	i	b	A	h	a	o	z	p	i
t	N	a	b	r	V	i	x	g	a	s	d
O	i	i	i	t	T	p	a	l	O	a	i
A	b	a	m	o	o	o	a	C	v	c	a
N	a	o	c	O	T	t	n	p	r	n	T
o	c	a	n	m	a	g	o	t	r	o	i
S	h	i	a	l	r	a	p	m	z	o	x

The Hermetic Order Of The
GOLDEN DAWN^{Intl.}

**MOON ON THE TREE OF
LIFE**

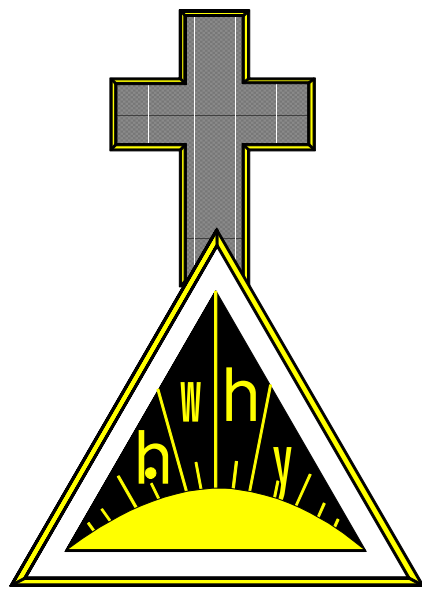

THEORICUS 2=9

On this tablet are shown the meanings of the Lunar symbol when inscribed upon the Tree of Life. Thus its crescent in increase represents the side of Mercy and its crescent in decrease represents the side of Severity. When it is full, it reflects the Sun of trapt.

Moon on the Tree of Life

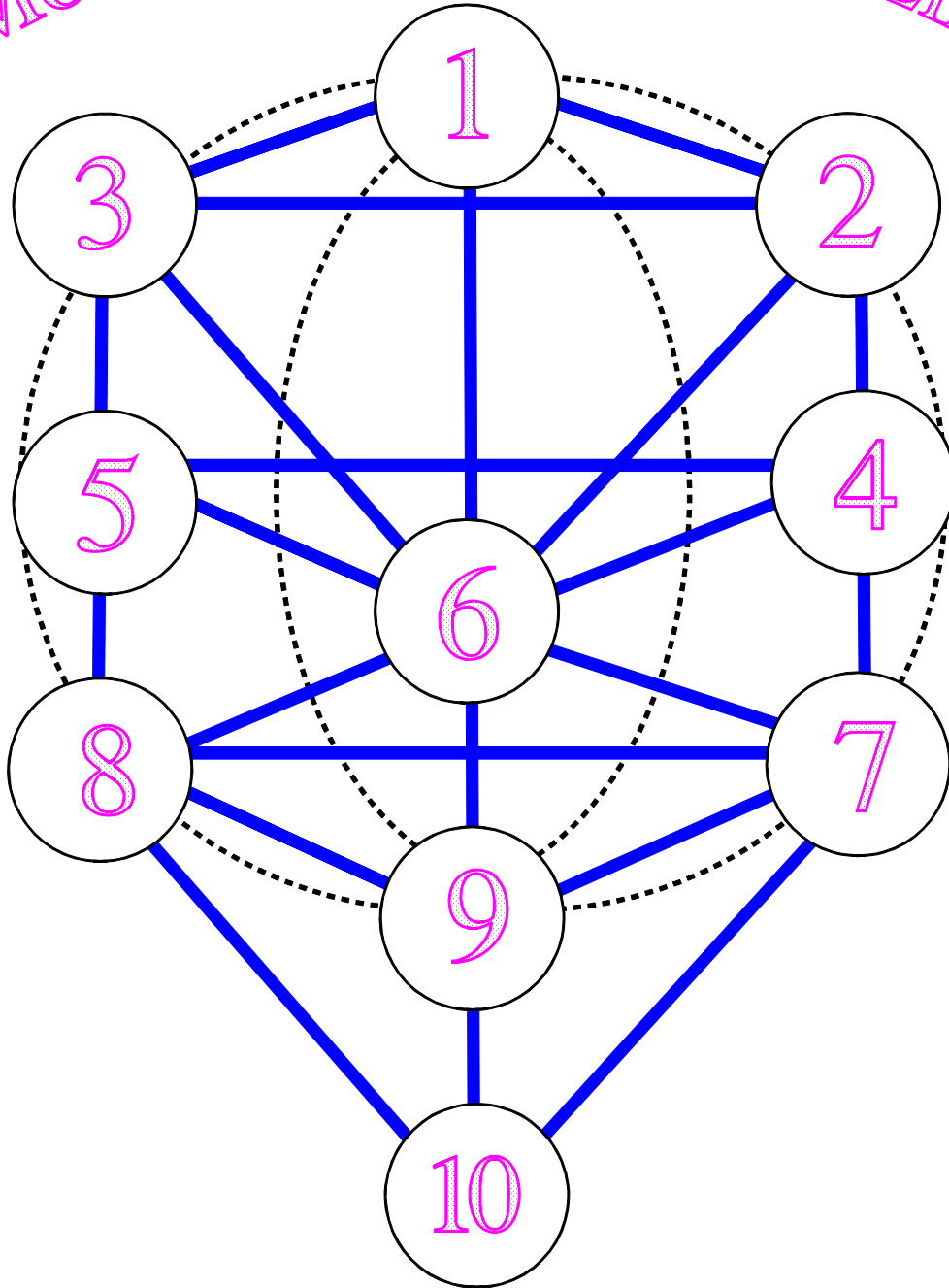

The Hermetic Order Of The
GOLDEN DAWN^{Intl.}

THE KAMEA OF THE MOON

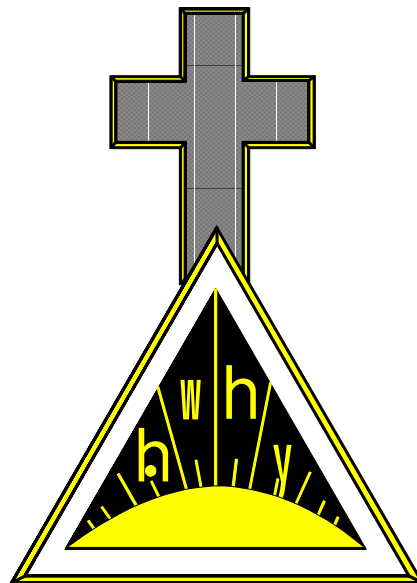

THEORICUS 2=9

Kamea of Luna

zl	ju	fk	u	ak	bs	gy	dn	h
w	jl	fu	l	au	bk	gs	dy	wm
zm	z	fl	p	al	bu	gk	hn	hy
wy	jm	j	m	ap	bl	ds	dk	wn
zn	zy	fm	f	am	gu	gl	hs	hk
wk	jn	jy	n	a	bm	du	dl	ws
zs	zk	fn	y	an	b	gm	hu	hl
wl	js	fy	s	ay	bn	g	dm	wu
zu	jk	fs	k	as	by	gn	d	hm

Seal of Planet

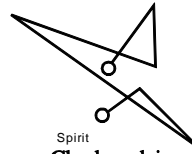
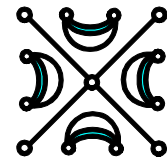

Spirit
Chashmodai

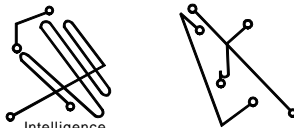

Intelligence
Malkah be-Tarshisim ve-ad
Ruachoth Shechalim

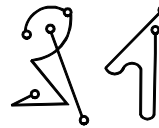

Spirit of Spirits
Shad Barschemoth
ha-Shartathan

To the Moon is this grade especially referred to. Its Kamea or magical square is shown in the east with the seal's name appropriate thereto. It is also shown and inscribed upon the Tree of Life: Its increase in its crescent represents the side of Mercy, whereas the Moon in its decrease represents the side of Severity. In its full it represents the Sun of trapt. (The Theoricus Ritual of the Golden Dawn, Volume II, book II). It is here that you will notice the picture and the Kamea of the Moon. Notice that the numbers all add up to 3321 no matter which direction this is drawn. This becomes an appropriate sigil that is very powerful for later workings in the Inner Order for when you will be invoking the energies of Luna. It should be studied in this grade. Drawing of this diagram from memory will not be necessary. However, an understanding of this is imperative in the Theoricus grade, for this grade relates to the sephira of dwsy and the planet of the Moon.

The Hermetic Order Of The
GOLDEN DAWN^{Intl.}

ALCHEMICAL SEPHIROTH

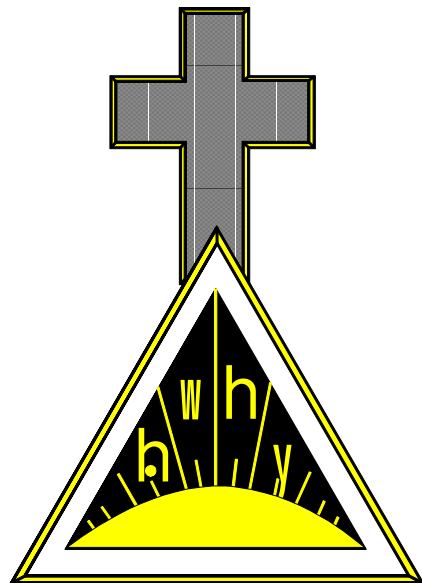

THEORICUS 2=9

The tablet before you shows the duplicated form of the alchemical sephiroth. In the first, the metallic root is in rtk, lead in hmkj , tin in hnyb, silver in dsj , gold in hrwbg, iron in trapt, j xn and dwh are in the places of hermaphroditical brass, dwsy is mercury and twklm is the medicine of metals. In the second form, the Mercury, Sulfur and Salt are referred to the three Supernal sephiroth, and the metals to the seven lower, but in a rather different order. For in all things, as Supernal so Terrestrial, is the Tree of Life to be found, whether it be in animal, vegetable or mineral natures.

Tablet One

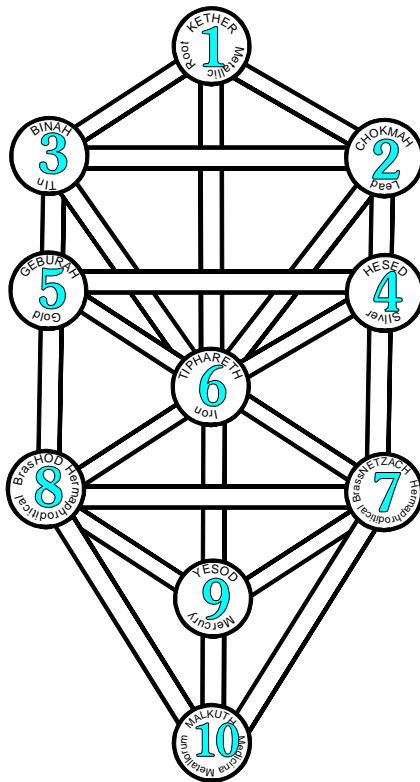

Tablet Two

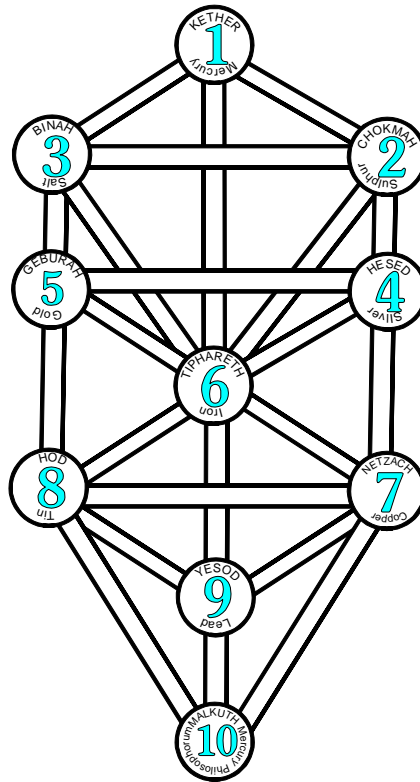

Alchemical Metals

The Hermetic Order Of The
GOLDEN DAWN^{Intl.}

**HIGHLIGHTS OF THE THIRD
KNOWLEDGE LECTURE**

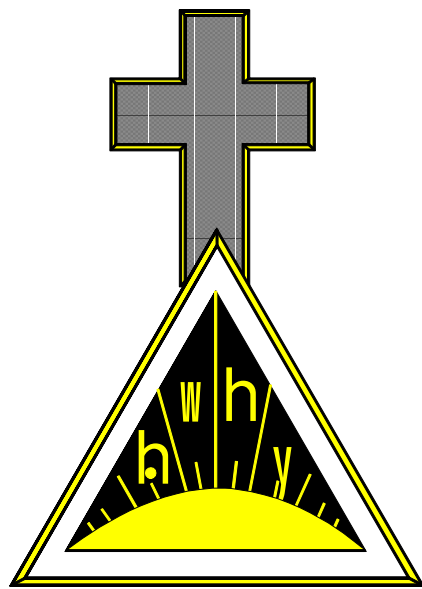

THEORICUS 2=9

The soul is divided by the Qabalists into three principal parts:

1. **Neschamah:** The highest part, answering to the three Supernals.
2. **Ruach:** The middle part, answering to the six sephiroth from dsj to dwsy, inclusive.
3. **Nephesch:** Answering to dwsy.

Neschamah answers to the higher aspirations of the Soul. Nephesch answers to the animal instincts. Chiah answers to hmkj, Yechidah to rtk, while the Lesser Neschamah itself is referred to hnyb.

The *Sepher Yetzirah* divides the Hebrew letters into three classes of three, seven, and twelve:

Three Mother letters: a, m, c.

Seven double letters: b, g, d, k, p, r, t.

Twelve single letters: h, w, z, j, f, y, l, n, s, u, x, q.

The Seven Branched Candlestick, the double letters.

The Holy Place embraces the symbolism of the twenty-two letters.

The Tablet of Shewbread, the single letters.

The Altar of Incense the three Mother letters.

Astral spirits are those belonging to the astral plane. Such are false and illusionary forms, shells of the dead, and ghosts and phantoms.

Elemental spirits are those belonging to the nature of the elements; some are good and some are evil.

An Angel is a pure and high spirit of unmixed good in office and operation.

In the Tarot, the ten small cards of each suit refer to the sephiroth. The four suits refer to the letters of the Tetragrammation thus:

Scepters or Wands	y
Cups	h
Swords	w
Pentacles	h Final

The four suits also refer to the four worlds of the Qabalists thus:

Scepters or Wands	Atziluth
Cups	Briah
Swords	Yetzirah
Pentacles	Assiah

The Honours of the Tarot pack are, as it were, the Vice-gerants of the Great Name, in the Qabalistic World to which each suit is referred. They also symbolize Father, Mother, Son, Daughter; Birth, Life, Death, and Resurrection.

The Fylfot Cross

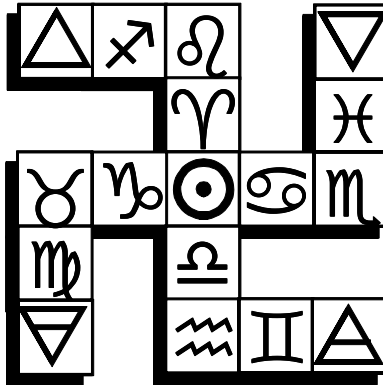

The seventeen squares out of a square of lesser squares, refer to the Sun in the twelve signs of the zodiac and the four elements.

Caduceus of Hermes



This form of the Caduceus of Hermes is that of the three Mother letters placed on one another.



The Caduceus has another meaning on the Tree of Life. The upper part of the wings touch hmkj and hnyb, these are the Supernals. The seven lower sephiroth are embraced by the Twin Serpents whose heads rest upon dsj and hrwbg.

MOON ON TREE OF LIFE

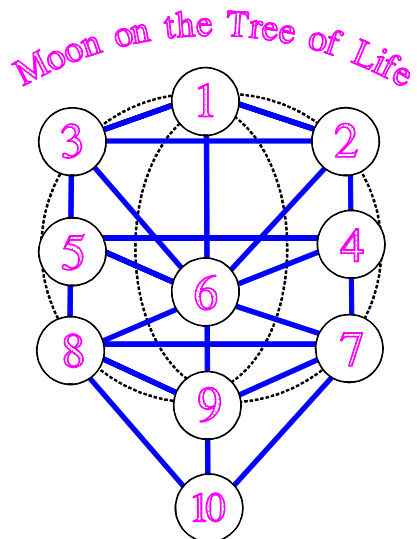

The meaning of Luna on the Tree of Life is thus:

In its increase it embraces the side of Mercy; in its decrease the side of Severity, and at the full, it reflects the Sun of trapt.

The Hermetic Order Of The
GOLDEN DAWN^{Intl.}

**SERPENT ON THE TREE OF
LIFE**

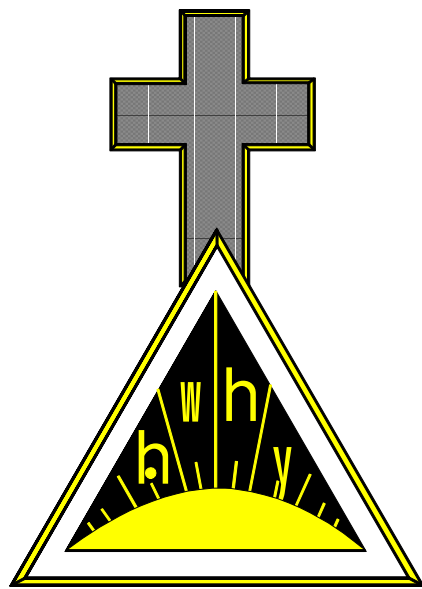

THEORICUS 2=9

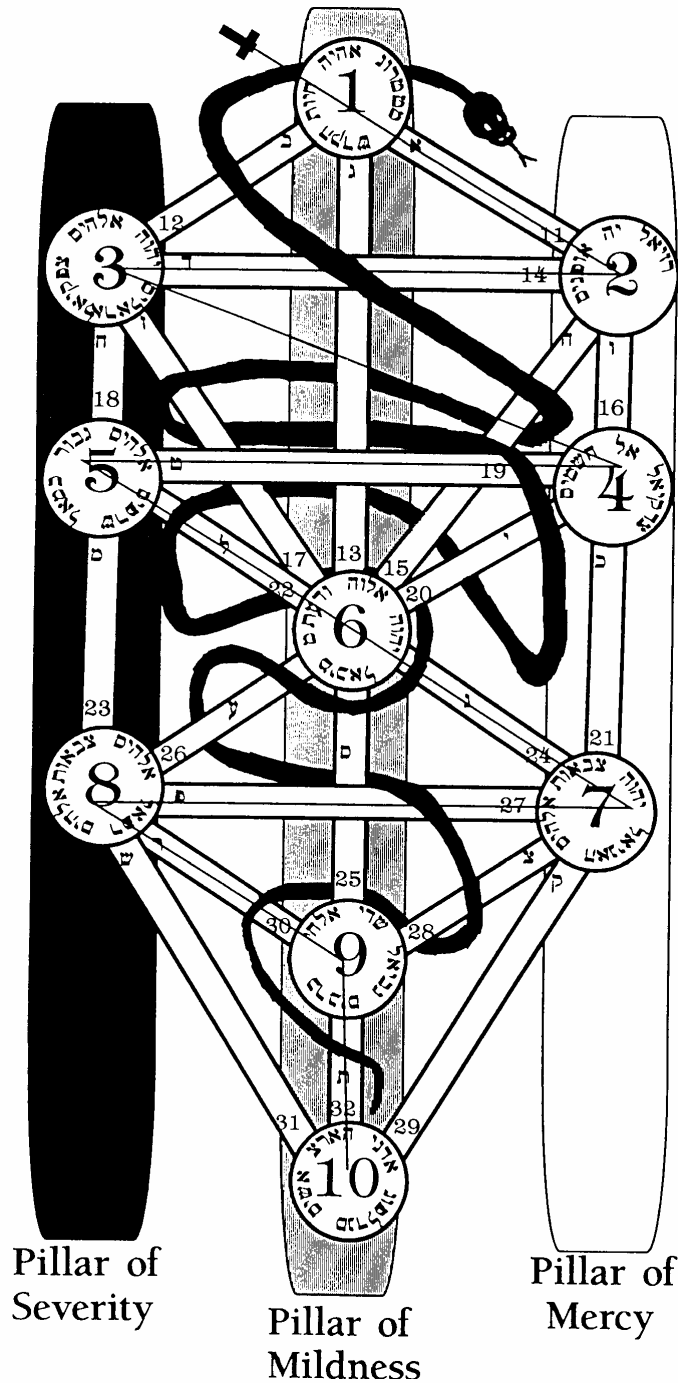

"Before you stands the Tree of Life formed from the sephiroth and their connecting paths into its complete symbolism. It is impossible to enter here for it is the key of all things when rightly understood. Upon each sephira are written in Hebrew letters its name, its corresponding Divine name, Archangelic name and Angelic name. The connecting paths are twenty-two in number and are distinguished by the twenty-two letters of the Hebrew alphabet. Complementing them are the ten sephiroth along with

the Thirty-two Paths of Wisdom of the *Sepher Yetzirah*." (The Theoricus initiation of *The Golden Dawn*, Lewellyn Publications, Volume II, book II.) We must understand that the direction or course of the Hebrew letters as placed on the paths form a symbol, the symbol of the Serpent of Wisdom. It is here in the Theoricus grade that we begin to understand this Serpent of Wisdom as we enter the astral plane in dmsy. Aside from this we have the natural succession of the sephiroth that form the Flaming Sword. So, the paths equal the Serpent of Wisdom where the sephiroth equal the Flaming Sword.

Again, this symbol should be meditated on on a regular basis and contemplation should be directed to it while in the grade of Theoricus. More esoteric study of this symbol will be directed in the higher grades to come.

The Hermetic Order Of The
GOLDEN DAWN^{Intl.}

HEBREW AND TAROT

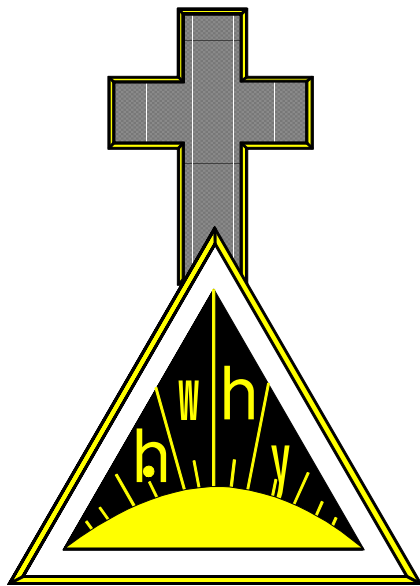

THEORICUS 2=9

Hebrew and Tarot

Value	Hebrew Letter	Path	Tarot Key	Tarot Card
1	a	11	0	The Fool
2	b	12	1	The Magician
3	g	13	2	The High Priestess
4	d	14	3	The Empress
5	h	15	4	The Emperor
6	w	16	5	The Hierophant
7	z	17	6	The Lovers
8	j	18	7	The Chariot
9	f	19	8	Strength
10	y	20	9	The Hermit
20	k	21	10	Wheel of Fortune
30	l	22	11	Justice
40	m	23	12	The Hanged Man
50	n	24	13	Death
60	s	25	14	Temperance
70	u	26	15	The Devil
80	p	27	16	The Tower
90	x	28	17	The Star
100	q	29	18	The Moon
200	r	30	19	The Sun
300	c	31	20	Judgement
400	t	32	21	The Universe

The Hermetic Order Of The
GOLDEN DAWN Intl.

**HEAVENS OF ASSIAH,
TAROT AND TOOLS**

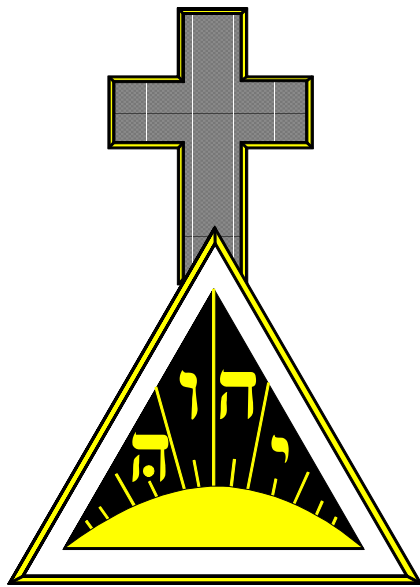

THEORICUS 2=9

Path	Hebrew Letter	Tarot Card	Heavens of Assiah	Tool of the Path
11	א	The Fool	Air	Dagger, Fan
12	ב	The Magician	Mercury	Wand or Caduceus
13	ג	The High Priestess	Luna	Bow and Arrow
14	ד	The Empress	Venus	Girdle
15	ה	The Emperor	Aries	Horns, Burin
16	ו	The Hierophant	Taurus	Preparations
17	ז	The Lovers	Gemini	Tripod
18	ח	The Chariot	Cancer	Furnace
19	ט	Strength	Leo	Disciplines
20	י	The Hermit	Virgo	Lamp and Wand, Bread
21	יא	Wheel of Fortune	Jupiter	Scepter
22	יב	Justice	Libra	Cross of Equilibrium
23	יג	The Hanged Man	Water	Cup and Cross, Wine
24	יד	Death	Scorpio	Obligation, Pain
25	טו	Temperance	Sagittarius	Arrow
26	טז	The Devil	Capricorn	The Secret Force, The Lamp
27	יז	The Tower	Mars	The Sword
28	יח	The Star	Aquarius	Censer, Aspergillum
29	יט	The Moon	Pisces	Magic Mirror
30	כ	The Sun	Sun	Bow and Arrow
31	כא	Judgement	Fire	Wand or Lamp
32	כב	The Universe	Saturn	Sickle

The Theoricus should have memorized the path number, Hebrew letter, Tarot card, Heavens of Assiah (fourth world of the Qabalah) and the tool that applies to each path.

The Hermetic Order Of The
GOLDEN DAWN^{Intl.}

**HIGHLIGHTS OF
INTRODUCTION TO THE
QABALAH UNVEILED**

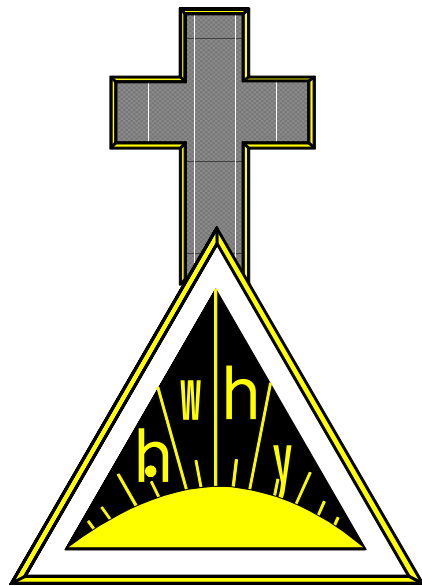

THEORICUS 2=9

According to Mathers, the Qabalah is defined as "Esoteric Jewish Doctrine." It is called Qabalah and originally spelled QBLH, which is derived from the root word QBL pronounced as Qibel, meaning to receive. This basically means that the information or esoteric tradition was handed down by word of mouth. In Chaldee, Greek, and Hebrew, there are no separate numerical symbols. Thus every word is a number and every number is a word. Mathers selected the Roman letter "Q" to represent the Hebrew letter q. The precedent for this particular spelling is Max Mueller's "Sacred Book of the East." Mathers reminds us that Hebrew is almost an entirely consonantal alphabet. The vowels are primarily supplied by small points and lines below the letters.

The Qabalah has its origins in Judaism, but is not strictly Jewish by any means. The Qabalah has captured many great minds of Christianity as well as those of the Neo-pagan movement. Some people that have been captured by the study of the Qabalah were Ramon Lully, a celebrated scholastic metaphysician and chemist who died in 1315; John Reuchlin, a renowned scholar and reviver of oriental literature in Europe who died in 1522; John Picus De Mirandola, a famous philosopher and scholar who died in 1494. Then of course we have the famous Cornelius Agrippa, the distinguished philosopher and divine physician who died in 1535, and John the Baptist Von Helmont, a remarkable chemist and physician who died in 1644. Robert Fludd, the famous physician and philosopher who died in 1637 was also responsible for the invention of the Ouija board. Then there is Doctor Henry Moor who died in 1687. Not to mention Nostradamus, Michelangelo and countless other men and women who have achieved great stature in their personal as well as spiritual lives. Other more recent people would include S.L. MacGregor Mathers, Aleister Crowley, W. B. Yeats, Dion Fortune, and Paul Foster Case. Most of these men and women received their Qabalistic studies from the Golden Dawn system of Theosophy.

Legend has it that the Qabalah was taught by God to a select company of Angels. These Angels then formed a theosophical school in Paradise. It was after the fall that the Angels most graciously communicated this heavy doctrine to the disobedient children of Earth, to furnish them with the information and knowledge so that they could return to their pristine nobility. So in other words, the first Qabalist was Adam, following him was Abraham. When Abraham moved into Egypt, the Egyptians picked up the Qabalistic doctrine as well. One thing that we must remember about the Egyptians is that they were an evolving esoteric society that constantly was changing. Their deities were evolving as their knowledge was being evolved. So in a lot of Egyptian mysticism, we do see the influences of Qabalistic doctrine. Moses himself was initiated into the doctrine of the Qabalah in his birth land of Egypt. However, he actually received his knowledge of the Qabalah from Angels.

A lot of this is a mythological way of expressing how the oral tradition was passed down from one generation to the other. Perhaps we would be best to say that our first early Qabalists were David and Solomon. They in fact were initiated into the Qabalah. No one ever dared to write down the Qabalah, at that time, until Schimeon Ben Jochai. This information then was passed on to his son Rabbi Eleazar and his secretary Rabbi Abba as well as their disciples. All of these teachings composed the celebrated work called *Zohar* (Zhr), which means "The Book of Splendor." This is probably the largest storehouse of Qabalistic doctrine and material.

The Qabalah is classified under four headings:

1. The Practical Qabalah
2. The Literal Qabalah
3. The Unwritten Qabalah
4. The Dogmatic Qabalah

The Practical Qabalah deals with talismanic and ceremonial magic. The whole of the Golden Dawn system is in fact an elucidation of this topic. Next, we have the literal Qabalah and it refers primarily to the study of GMTRIA, in English gematria, and the study of notarikon (NVTRIQVN), and lastly THMVRH which is pronounced Temurah. Gematria works on the numerical value of words. Words of similar numerical value are considered to be explanatory of each other. This theory is extended to phrases as well. Thus the letter c is equal to 300 and may be likened to the word Ruach Elohim (RVCH ALHIM), which means the Spirit of the Elohim. So consequently these two words have the same numerical value of 300. Therefore they are likened to be similar to each other. The numerical value is R=200, V=6, CH=8, A=1, L=30, H=5, I=10, M=40 which then gives the total of 300. Another example of this is the word Metatron (MTTRVN), and the name of deity Shaddai (SHDI). Each equals the number 314, so that one is really being taken symbolically of the other.

Notarikon is derived from the Latin word "Notarius," meaning a shorthand writer. There are two forms of Notarikon. In the first method every letter or word is taken for the initial or the abbreviation of another word. An example is AGLA which is used in the L.B.R.P.. It is a notarikon which stands for "Atah Gibor Liholam Adonai." Translated, this means, "Thou art Great Forever my Lord." The second form of Notarikon is the exact opposite. In this method, the last letter is used to form a word.

Temurah is permutation, where a letter is substituted for another letter. Thus from one word a totally different word may be formed. The alphabet is bent exactly in half. One half is put over the other, and by changing alternately the first or first two letters at the beginning of the second line, twenty-two commutations are produced. These are simply called the Table of Combinations.

11	10	9	8	7	6	5	4	3	2	1
K	I	T	Ch	Z	V	H	D	G	B	A
M	N	S	O	P	Tz	Q	R	Sh	Th	L

This first method is called Albath (Albth) and it is the most common and prevalent method of Temurah. There are twenty-one other methods of Temurah. For the serious student who would apply some time and effort into this, some time should be spent in reading various selected Qabalistic writings on this, even MacGregor Mathers "Intro to the Qabalah" would suffice. It is not the intention of this lesson to go into in-depth study of these twenty-one various methods. In addition it is not necessary at this time to expose the extended version of this lesson. There is however one important method called, "The Qabalah of Nine Chambers", or Aiq Bekar (AIQ BKR).

300	30	3	200	20	2	100	10	1
SH	L	G	R	K	B	Q	I	A
600	60	6	500	50	5	400	40	4
M (f)	S	V	K (f)	N	H	Th	M	D
900	90	9	800	80	8	700	70	7
Tz (f)	Tz	T	P (f)	P	Ch	N (f)	O	Z

You will notice the affinity between the letters in each chamber. According to Mathers: "Sometimes this is used as a cipher by taking the portions of the figure to show the letters they contain, putting one point for the first letter and two for the second etc.. Thus the right angle containing AIQ, will answer to the letter Q if it has three points within it. Again a square will answer for H, N, or K (final), according to whether it has 1, 2 or 3 points consecutively within it. So also with regards to the other letters, but there are other ways of employing the Qabalah with the Nine Chambers." Mathers then points out an example of Temurah called ATHBASH (ATHBSH). It is found in Jerimiah XXV. 26. The word Sh, Shk, Sheshakh, symbolizes , Babel (BBL).

It is not critical or important for testing for you to have mastered the Qabalah of the Nine Chambers or ATHBSH or any other methods, however this is a study that you may wish to pursue on your own. You should be able to find several Qabalistic doctrines such as the *Zohar*, *Sepher Yetzirah* and the *Bahir* and traditional kosher books on the Qabalah that will give you some concept of how to work with the subject of Temurah. Again, for testing it is merely important that you understand that it is part of the Literal Qabalah.

The next type of Qabalah is the Unwritten Qabalah. This is the Qabalah that is never entrusted to writing but is communicated orally. This Qabalah is not allowed to be written down though most of it has been in recent years. Part of the unwritten Qabalah in addition is really an elucidation of what we now call the "Internal Qabalah." The theory holding here is that approximately seventy percent of the Qabalah must be learned internally, not externally through the use of books.

The final type of the Qabalah is the Dogmatic Qabalah. Within this doctrine is contained the doctrinal portion of the Qabalah. The basic four are the *Sepher Yetzirah*, the *Zohar*, the *Sepher Sephira*, and the *Asch Metzareph*. The *Sepher Yetzirah* is known as the Book of Formation and is ascribed to the patriarch Abraham. It is basically a commentary on the ten numbers and the twenty-two letters of the Hebrew alphabet, otherwise called the thirty-two paths. The *Zohar* or Splendor is another large voluminous book with a tremendous amount of information within it. It is probably the most quoted of Qabalistic books. The *Asch Metzareph* or Purifying Fire is the Hermetic and Alchemical Fire.

The Qabalah is designed to solve the following questions:

The Supreme Being, his nature and attributes.

Cosmogony.

The creation of Angels and man.

The destiny of man and Angels.
The nature of the soul.
The nature of Angels, demons and elementals.
The import of revealed law.
The transcendental symbolism of numerals.
The peculiar mysteries contained within the Hebrew letters.
The equilibrium of commentaries.

There is a significant amount of other information covered in MacGregor Mathers *The Qabalah Unveiled*. We also highly suggest you purchase this book as additional reading. As one of the co-founders of the Golden Dawn, his writings at times reach deeper and explain more than most other commentators. However, at times it can be a little dry. Nonetheless it is still worth the time it takes to read the information. We will not cover the other information given in the "*Introduction to the Qabalah Unveiled*" because it is covered in other lessons. As a matter of fact, much of the information that was touched on in this lesson will be covered in more indepth study in future lessons.

The Hermetic Order Of The
GOLDEN DAWN^{Intl.}

**THE THREE VEILS OF
NEGATIVE EXISTENCE AND
TZIM TZUM**

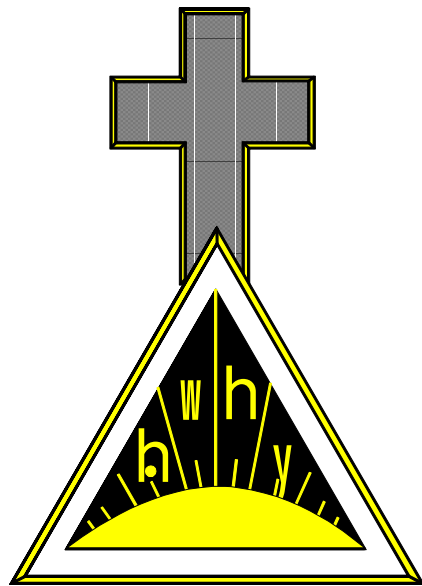

THEORICUS 2=9

This is without a doubt one of the most difficult lessons to write and express, because, when we talk about the Tree of Life, we are talking about creation and existence. When we talk about the sephiroth and the paths, we are talking about energy planes or states of consciousness. Now we are going to try to talk about what is beyond the Tree of Life. If you look at most glyphs of the Tree of Life, you will notice that there are three rings above rtk. These three rings are known as the three veils of negative existence. These veils are known as Ain, Ain Soph, and Ain Soph Aur, consecutively.

We are going to set a premise of understanding before we delve further into this lesson. The premise being stressed is that all the names of God, from whatever culture they may come, Hebrew, Arabic, Egyptian or Christian, all tend to deal with God in manifestation. They deal with the Creator after he has manifested. In many cases, they deal with the Creator in the state of polarity and duality as found in the sephiroth. There is no name for God beyond creation. God is without name. The best way to state this concept is that we can never know the true name of God as long as we are an aspect of creation. It is only through the elevation of our consciousness beyond our own limits that we can come to know the unspeakable name of God. It is probably the most significant reason why we find that in Hebrew, God's name is unspeakable. Speech, words and letters are aspects of creation, and thus they are aspects of consciousness. The three veils of negative existence, however, particularly Ain and Ain Soph, are beyond consciousness, beyond words and symbols, and beyond creation.

Some might bring up the creation according to Genesis in the Bible and say that the name of Elohim is used thirty-two times in the opening of Genesis. However, it must be kept in mind and emphasized that none of the names of God refer to the Creator himself. The Creator himself is referred to one of the veils of negative existence, particularly Ain Soph. This basically means "Infinite Being" or "The Infinite." The names used in the scriptures refer to various ways in which God manifested himself in creation. Thus, the name Elohim that is found in Genesis, refers to the manifestation of delineation and definition and not to the Infinite Being.

The Universe is nothing more than thought projected from the mind of Deity. Thought does have form, however, for it can be measured and is considered to have substance. Consequently, we can also consider thought as a basis of creation. Again, we are not absolutely accurate because we are at a place that doesn't exceed the limits of the veils of negative existence, which are essentially even beyond thought. Let us consider for a moment that the Universe is the consciousness by-product of the mental activity of the Infinite Unknowable Deity. If this be the case, then the Tree of Life is the symbolic representation of the raw material of the Divine Consciousness. It is also indicating the process whereby the Universe came into full manifestation and being. As stated earlier in this lesson, the three veils of negative existence really stretch and cross some imaginary line beyond thought and beyond consciousness in the sense of how we understand the term. Even thought itself and consciousness can be said to be manifestation in some form or another, aside from that of the three veils of negative existence which are beyond the World of Manifestation.

The Qabalist draws a veil at the point of manifestation between rtk and the three veils of negative existence. We draw this veil not because there is nothing there, but simply because the mind as such must stop there. It cannot comprehend beyond

that point. It is interesting to note that no matter how far we take our minds back to the origins of existence, we find that there is always a preceding existence. The mind can only go back so far. It only has the ability to reach back into history, time or space, or to a finite point if you will. We find that on the other hand, the three veils are infinite and, thus, the mind cannot comprehend them.

We, as Qabalists, attempt to allow our minds to go back as far as the highest point, the farthest backpoint that we can manage. This is rtk and it is equated with the most transcendent form of God that we can conceive with a physical mind. The God name of rtk is "Eheieh." This translated is "I Am", or more understandably, "The Self Existing One" or "Pure Being."

This, in its totality, does not mean very much to us unless we have a deeper understanding of its concept. Consequently, we need hmkj (Wisdom) and hnyb (Understanding) to have a better comprehension of rtk . The sephiroth become better known to us as we relate them to the other sephiroth on the Tree of Life. Moreover, we do not have this option when we reach this veil of negative existence simply because the veils have nothing to compare themselves to. All forms of science, philosophy and religion reach this point, the veil of negative existence. Scientists even go back to the Big Bang theory. However, due to this veil, it limits such passage to moving any further. The same is true with many religions. They find themselves picturing deity as a man with a white beard on a throne, certainly this is not accurate. It is only the occultist that attempts to go beyond the veils of negative existence. This may sound impossible, yet we are able to penetrate deeper into the creation of existence, of all that is and all that is not, because we use symbols and deep meditative methods for understanding the creation of the Universe.

S.L. MacGregor Mathers says that rtk is the $\text{t\textbackslash klm}$ of the unmanifest. "The Limitless Ocean of Negative Light does not proceed from a center, for it is centerless yet it concentrates a center which is the number one of the manifested sephira of rtk ." Thus, we see that the limitless gives rise and manifestation to the infinite center and oneness which becomes the crown, rtk .

We, as occultists and Qabalists, recognize four planes of manifestation and three planes of unmanifestation or negative existence. These are called Ain, meaning negativity or no-thing; Ain Soph, meaning without limit; and Ain Soph Aur, meaning limitless Light. It is out of Ain Soph Aur that we have the Primordial One manifested as depicted in rtk . (For those of you who have forgotten the four planes of manifestation, they are as follows in order: Atziluth, Briah, Yetzirah and Assiah.)

In regard to negative existence, if we think in terms of anything that we already know or could possibly know, we shall be in error. For whatever else there may be, negative existence simply cannot be and, moreover, it is unmanifested.

The three veils of negative existence suggest certain concepts or ideas to our minds. Keep in mind now that everything in this lesson may not be purely accurate. In regards to Ain (again, meaning no-thing, and it is spelled rightly so), this particular veil is not the same as the concept of nothingness, but rather it is negativity. In addition, this is not to be related to the negativity of Darkness. Our minds cannot conceive of such a thing that is and is not. We cannot conceive of the concept of existence and non-existence as being one and the same.

Negative existence is really outside the realization of our ability to understand it. However, this does not mean to say that we are outside of the range of its influence on us. On the physical plane we have no direct access to the Being of negative existence, yet all that we know as existing has its roots and origins in this negative existence. What we are trying to say here basically is that although we don't truly know of negative existence, we certainly know of its effects on our own existence and lives. The Mystics throughout history who have ventured as far back as one can safely go on this physical existence have referred to negative existence as Light or Ain Soph Aur, the "The Boundless and Limitless Light." They have spoken of the first manifestation as sound; "In the Beginning was the Word."

Thus, in conclusion, we wish to emphasize that behind the most exalted aspects of our Universe lies the Unmanifest, which is the "Ultimate Source of All", "The Great Unknowable One" which cannot be known to us. The unmanifest is symbolized by the words negative limitless Light, or in Hebrew, Ain Soph Aur. On the glyph of the Tree of Life, you will notice that there are three curves of radiating Light. The outer curve is Ain (No-thing), the middle or center is Ain Soph, and the innermost is Ain Soph Aur. These are basically understood to be the veils that separate the outpouring of our Universe from that which it emerged. Behind these mystical veils energy flows constantly to us from rtk, moving down the Tree through hmkj, hmyb etc., following the path of the Flaming Sword until it reaches its base in twklm. Most of our study in the area of esoteric thinking and magical workings deals with the manifested Universe through the Tree of Life and the paths that connect them. Very little is done with the concept of negative existence because of the fact that it is beyond comprehension. Let us re-emphasize that negative existence does have an effect on our lives as it is the source of all that is and all that is not.

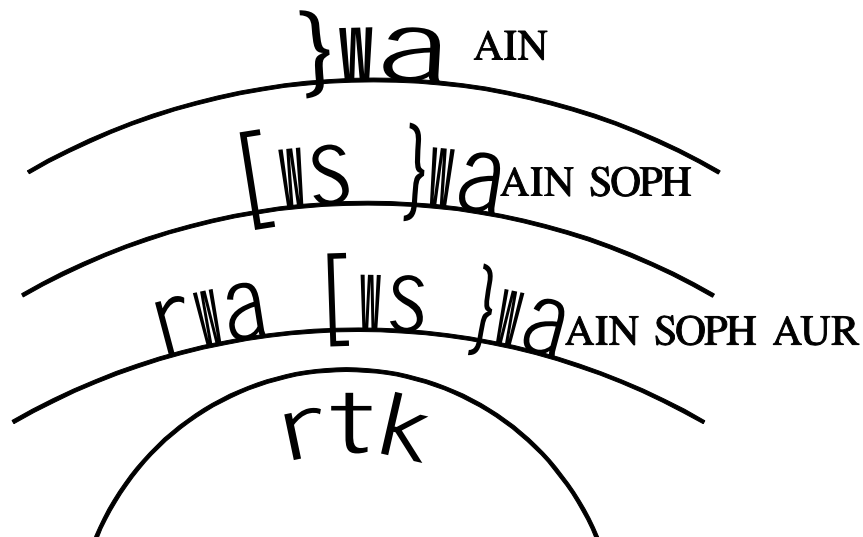

Tzim Tzum

One of the important concepts of the Qabalah is that of Tzim Tzum, or self constriction of God's Light. The process of Tzim Tzum is confusing to Qabalistic as well as Theosophic scholars. So, consequently, it is not important that you totally understand it, but it is essential that you do have some basic knowledge of it.

It was Rabbi Issac Luria, 1534 - 1572, the head of one of the finest Qabalistic schools, who probably gave us our clearest statement on the subject of Tzim Tzum. Here is what he had to say:

"Before all things were created... The Supernal Light was simple, and it filled all existence. There was no empty space... when His simple will was to create all universes... He constricted the Light to the sides... leaving a vacated space... This space was perfectly round...

After this constriction took place... There was a place where all things could be created... He then drew a single straight thread from the Infinite Light... and brought it into the vacated space... It was through that line that the Infinite Light was brought down below..."

So, we see the process of Tzim Tzum as being rather straightforward. God first withdrew His Light, forming a vacated space in which all creation would take place. In order for His infinite creative power to be in that space, He projected into that space a thread of His Light. Essentially, it was through this thread of Light that all creation took place.

Let us emphasize here that Tzim Tzum is not to be taken literally since it is impossible as human beings to apply any spatial concept to God. We are speaking of Tzim Tzum in a conceptual sense. If God filled every space of perfection, then man would have no reason to exist. In other words, God constricted Himself (His infinite perfection), allowing a place for man's free will and accomplishment to exist.

Let us also emphasize that Tzim Tzum did not take place in God's essence, but rather in His Light. It was this Light that was the first thing that was brought into being, representing God's power of creation. This itself, the Light, had been brought into existence for the purpose of creating the Universe.

We find that one of the first teachings of the concept of Tzim Tzum was really made available to us from the Zohar. A passage may be referred to as thus, "At the head of the king's authority, He carved out the Supernal Luminescence, a Lamp of Darkness. There emerged out of the hidden of hidden, the mystery of the infinite, an unformed line, embedded in a ring... measured with a thread... " Without a doubt, this is a direct reference to the process of Tzim Tzum.

If we examine the reasons behind Tzim Tzum, they stem from a basic philosophical paradox. God must be in the world, therefore, all things must be God and of God. Yet, if He does not restrict Himself from it, all creation would be overwhelmed by His essence, since His essence is infinite. This also creates another difficult paradox involving Tzim Tzum.

Since God removed His Light from the vacated space, it must be empty of his essence. Still, all in all, God must also fill this space since "There is no place empty of

Him." This is the most profound and basic paradox, and it closely relates to God's transcendence and eminence.

This paradox brings out a very strong point that we must realize, and that is, this space is only Dark and vacated with respect to us as human beings. This "Lamp of Darkness" mentioned in the Zohar is "Darkness" to us. In relation to the Great Unknowable Lord of the Universe, it too is a "Lamp." In other words, with respect to God, it is actually Light. For God it is as if Tzim Tzum never took place. The process of Tzim Tzum was not for God, but rather it was required for us.

It is through the study of the Qabalah that in the Mysteries we try to understand and solve the paradox of how an absolutely transcending God could interact with his creation. It is the understanding of the sephiroth and similar concepts that helps us to bridge between the Great Unknowable One and the Universe, as well as ourselves. Perhaps they are one and the same, yet certainly the Great Unknowable King of the Universe is more than His own creation. Let us also remember that the Darkness or vacated space created by Tzim Tzum is actually Light with respect to God. The creation of the vacated space through the process of Tzim Tzum as well as to all the worlds known and unknown, does in no way change or diminish God's Infinite Light of Ain Soph Aur. In simplistic terms, we have the concept of no-thing, otherwise known as "Ain" or negative existence. This then became the boundless, the feminine aspect, the Infinite known as "Ain Soph." Together they create "Ain Soph Aur," the Infinite Light. The Light then restricted itself through the process of Tzim Tzum, yet it was only restricted as far as our perceptions are concerned. This in itself gives rise to rtk. Through rtk we have the path of manifestation following the path of the Flaming Sword down to tklm. This is an essentially simplistic overview of the processes of negative existence and its influence on the Tree of Life and on us.

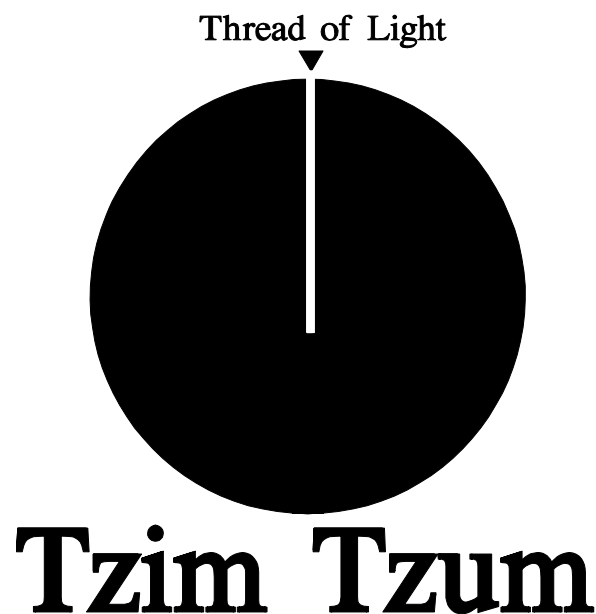

The Hermetic Order Of The
GOLDEN DAWN^{Intl.}

**POLYGONS AND
POLYGRAMS**

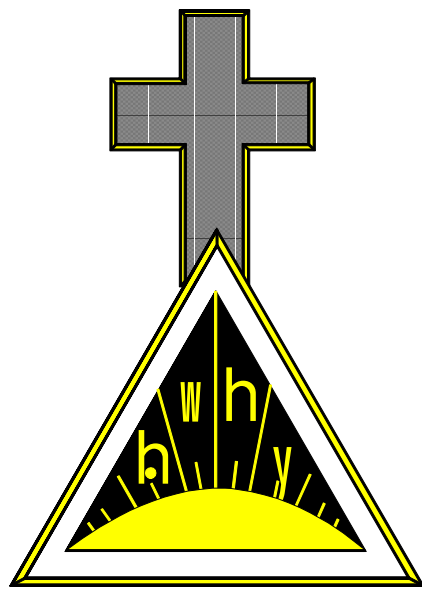

THEORICUS 2=9

A basic understanding of polygons and polygrams is essential for the magical work of the Theoricus. In higher grades, you may or may not decide to work with these figures, but if you work at all in the area of talismanic work, you will be using polygons and polygrams.

The point within the circle, the Primordial Point, is a representation of rtk . Really not much can be said about this Primordial Point, for in it is the potential of all things and of no thing. All things emanate from the Primordial Point. All things end at the Primordial Point.

The cross within the circle is attributed to hmkj . Here we have the Root of Wisdom according to the *Sepher Yetzirah*. So the cross within the circle is a representation of all things and no thing in perfect harmony and balance as well as unity.

hnyb is represented by the triangle inside the circle. The triangle is the only lineal figure in which all the surfaces can be reduced. What we are saying here is that every polygon can be divided into triangles by simply drawing lines from its angles to its center. The triangle is the simplest of all lineal figures, therefore it is the first of all lineal figures. In the Neophyte Initiation of the Hermetic Order of the Golden Dawn, we state that in all things there are two opposing forces and a third force uniting them. This would refer to the triad which operates in all things, especially the Supernals. It would also refer to hnyb , the third sephira. We see clearly that hnyb is an amalgamation of the top three Supernals. This is emphasized in the lesson, "Understanding of the Human Personality in the World of the Qabalah."

The top three sephiroth are referred to as the Greater Neschamah, whereas hnyb is referred to as the Lesser Neschamah. The triangle would also refer to the planet of Saturn and to the element of Fire. The color of Saturn is black and that of Fire is red. Therefore, the black triangle would represent Saturn and a red triangle would represent the element of Fire. Note also that a White Triangle represents the Supernals. We also have another triad, the three principles of nature: Salt, Mercury, and Sulfur. All of these symbols can be exemplified in the triangle which would give reference to hnyb .

The square is another lineal figure that is generally understood to represent equation and stability. Within the symbol of the square is included the idea of surface and superficial measurement. The square refers to the quaternary of all things and to the tetrad of the holy name YHVH which operates through the four elements. The square is attributed to dsj , the fourth sephira. It would equally correspond to the planet Jupiter. It is also a fitting representative of the four elements that will eventually take on manifestation.

The next figure is the pentangle. This refers to the sephira of hrwbg and the planet Mars. The pentangle can be traced in two different ways. When it is reflected from every second point it is called the pentagon, which is referred to hrwbg and Mars. The same figure, when reflected from every third point, is called the pentagram.

The pentagon is a fitting symbol that naturally represents the power and essence of the pentad. This operates through nature by the dispersal of the spirit and the four elements through it.

The pentagram is called the Signet Star of the Microcosm. It is a good and holy symbol, it is a positive symbol that represents man with his arms and legs extended,

adoring the Lord of the Universe. It also represents the domination of the Higher Will of the Spirit ruling over the elements. Another way of putting this is mind over matter.

When the pentagram has a single point pointing downward it is then known to be a negative or evil symbol. It becomes representative of a goat's head or a demon's head. This is a representation of the abasement of reason, the lack of reason, and the loss of reason beneath the blind force of matter. Notice that we didn't say beneath the blind force of Spirit. It is beneath the blind force of gross matter. The inverted pentagram is also a representation of the elevation or adoration of anarchy above order. It is also the elevation of conflicting forces driven simply by chance or haphazardness above the elevation of the Divine Unknowable One.

The upright pentagram represents the force of spirit and the four elements governed by the five letters of the name of the Restorer of all things. The element of spirit the letter *c* is fused between the masculine and the feminine, forming the Pentagrammaton out of the Tetragrammaton. With a circle drawn around the pentagram it represents the Kerubim and the Wheel of Spirit. One final point of symbolism of the pentagram is that it becomes a tremendous force for the letter *h*, the feminine aspect, the letter of the great Supernal mother, Aima Elohim.

If we reflect from every second point of the symbol of the hexangle, it would then be titled a hexagon. When it is reflected from every third point, it then takes on the form of the hexagram. This symbol, the hexagram, directly refers to the sephira *trapt*. The hexangle is a fitting representative for the powers of the hexad which operates through Nature. The hexad does this by the dispersal of rays of the various planets and the zodiacal emanations penetrating through the Sun. Those who wish to pursue will understand that a sextile is both powerful and good. If we take the number of degrees of the great circle and cut it off at sixty degree angles, we form this astrological sextile aspect. It is not quite as related to the Sun nature as is the hexagram. It should be remembered that the suffix "-gon" really relates to the dispersion of energy, the distribution of energy, and a radiation of force. When a hexagram is used as the diagram it represents concentrated force. Both are applicable, the hexagon would be for spreading of energies and the hexagram would be for specific or concentration of energies, as well as the sealing of energies. You should remember that at times in magical workings both of them may be employed, but the hexagon always initiates the whirl.

We call the hexagram the Signet Star of the Macrocosm. It is the sign of the Macrocosm, the greater or outer world. The six angles easily represent the six-day period of creation as depicted in Genesis, while its synthesis can be akin to the seventh day, a period of rest. This is summed up by its hexagonal center.

Let us divert a moment to the subject of the Unicursal Hexagram. For years it was thought and propoorted by followers of Aleister Crowley that he had invented this particular hexagram. After studies of early Order Documents, it was determined that the Unicursal Hexagram was used by S.L. MacGregor Mathers and was invented by the mathematician Pascal. For specific Enochian workings, a hexagram that could be drawn in one single line was needed. There are some specific workings where John Dee and Kelly were commanded by angelic forces to use a hexagram that was not drawn in two strokes of the pen or wand, but by a single stroke. This, however, was not widely employed by our founders, but used for those specific Enochian workings.

The Unicursal Hexagram employs or denotes the rulership of presidency of the Sun and Moon over the four elements. All of these are united in spirit as they come together. There is some information about the Unicursal Hexagram in various books which will be covered in higher grades for those of you who would wish to pursue this hexagram and its workings.

In regards to the traditional hexagram, often times called the Hebrew or Jewish star, it represents the force of the planets acting through the various signs of the zodiac. This is very powerful and effective in sealing the astral image of Nature under the presidency of the sephiroth, as well as the seven palaces. The hexagram is especially attributed to the Sun. This symbol is one of great power, a symbol of great strength. In it are both the combination of the pentagram and the cross, thus forming a very potent and positive triad which are in harmony with each other.

The heptangle refers to the seventh sephira of $j \text{ xii}$. As we disperse the power of the seven planets through the week and the year, we have the creation of the heptagon. It also alludes to the seven colors of the rainbow. The heptagram is the star of Venus and is applicable to her nature. The lineal figure of the seven planets is the heptagram representative of Venus' gates or entrances. It is also a fitting symbol of the Isis of Nature, as well as the seven lower sephiroth of the Bride. This is a powerful symbol when Venus or $j \text{ xii}$ energy needs to be employed. It is extremely effective in the use of talismans for those who are overly intellectual in their thinking. It becomes a fitting symbol for concentration and meditation for those who are overly influenced by Mercury.

The eighth sephira of $d \text{ iiii}$ is represented by the octangle. The power of the ogdoad and the octagon are naturally represented in the octangle. It is this symbol that naturally shows the dispersal of the rays of the elements in their dual aspects. Remember that there is a dual aspect to everything under the leadership and presidency of the eight letters of the name. The octagram, when it is reflected from each third point, yields eight triangles. These eight triangles become representative of the triad operating within each element in its dual form. Thus, we have the positive and the negative under the power of the third aspect of the triad which becomes YHVH Adonai, but is written as if it is bound together as IAHDONHI. If we take the Octagram and reflect it from every fourth point, we have the star of Mercury, and this certainly is akin to the nature of Mercury. It is a further potent symbol representing the binding together of concentrated positive and negative forces of nature and of the elements, under the name of IAHDONHI (Remember that it is a combination of the Tetragrammaton and Adonai together). We must always remember that Adonai is the key of YHVH.

The Enneangle is referred to the ninth sephira of $d \text{ iiii sy}$. It is representative of the power of the ennead and the enneagon. It also shows the operating power of nature by the dispersal of the rays of the seven planets and of the Head and Tail of the Dragon of the Moon, otherwise known as Cauda and Caput Draconis.

When we reflect on the enneagram from every third point, we find that we arrive at the triple ternary operating both in the seven planets with the Cauda and Caput Draconis of the Moon and also with the alchemical principles counterchanged and interwoven. It is not akin much to the nature of Luna as it is to the sphere of $d \text{ iiii sy}$. It is only when the enneagram is reflected from every fifth point that it becomes consonant

with the nature of Luna. The Enneagram is the star of the Moon, the star of Luna. It is a fitting representation of the Moon's administration to the Earth through the virtues of the solar system under the presidency of the sephiroth. When the enneagram is reflected from every fourth point, it is composed of the three triangles united with a circle which alludes to the triple ternary of the three alchemical principles, sulfur, mercury and salt. When reflected from every fourth point, it is not so much in harmony with the nature of Luna as when the enneagram is reflected from the fifth point.

The dekangle represents the power of the dekad and the dekadon. The dekadon shows the power of the dekad operating in nature by the dispersal of the rays of the ten sephiroth. The number of degrees of the great circle cut off between its angles is thirty-six.

The dekagram reflected from every third point is especially in harmony with t\`wklm . This shows the triad operating through the angle of two pentagons with a circle. It also alludes to the three alchemical principles, plus spirit, plus the four elements in their positive and negative form all under the presidency of the ten sephiroth. The dekagram, reflected from the fifth point, is composed of two pentagrams within a circle. It alludes to the operation of the duplicated h of the Tetragrammaton, as you know there is a first and final h. It also refers to the concentration of positive and negative forces of Spirit and of the four elements under the presidency of hnyb , the convolution and revolution of forces under Aimah.

As a general rule, the endekagram refers to the Qlippoth. When it is reflected from every fourth point, it represents their restriction. However, from other reflections, it indicates the Qlippoth's operation through nature. Thus, we can say that the endekangle naturally represents the evil and imperfect nature of the endekad and the endekagon. This is highlighted by the dispersal of the eleven curses of Mount Ebal through the Universe.

The dodekangle refers to the aspect that we call the zodiac. It represents the power of the dodekad. The dodekagon represents the influences of the zodiac through Nature. However, the dodekagram represents its constriction. The number of degrees of the great circle cut off between its angles is thirty. This forms a weak astrological semi-sextile.

One final note is that when using these lineal figures later in the forming of talismans under the directions of the sephiroth, we must remember that all of the sephiroth below the point of hmkj should have a double, triple, or quadruple form of their lineal figures bound together in their talismans. For example, let's take the heptangle of j x\`n , the heptagon and the two forms of the heptagram. They should all be united in the same talisman with the extremities of the angles coinciding.

Later, in the higher grades and in talismanic work, you will be utilizing these figures for potent and powerful planetary, zodiacal, and sephirotic work. It is not necessary in this grade to have every aspect of every figure memorized, but you should have a working knowledge of each figure and how it applies to every sephiroth and every planet. This will give you a basic understanding and allow the information to seep into your mind and thus be easily utilized later for potent, powerful workings.

The Point within a circle

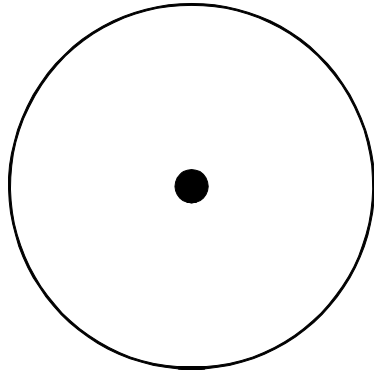

rtk

The Cross

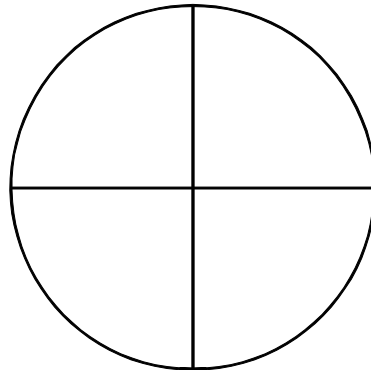

hmkj

The Triangle

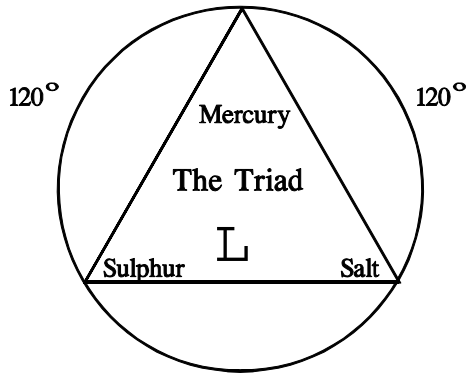

hnyb

The Square

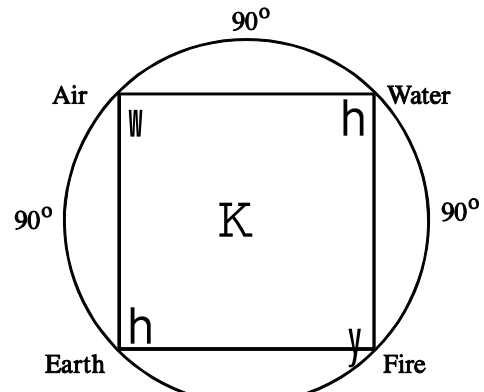

dsj

The Pentagon

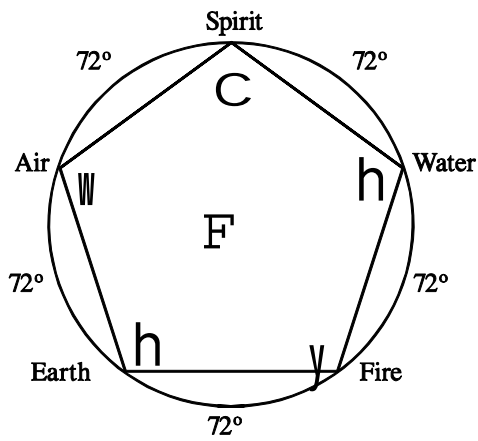

hrwbg

The Pentagram

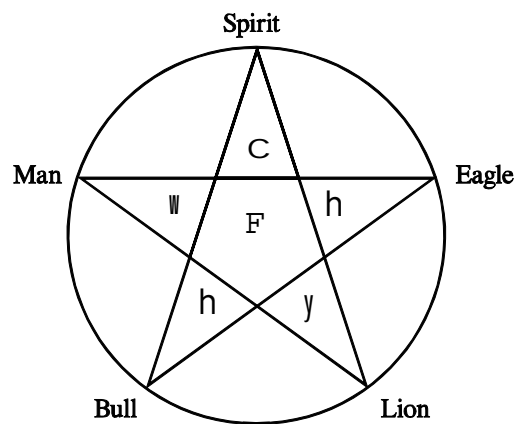

The Hexagon

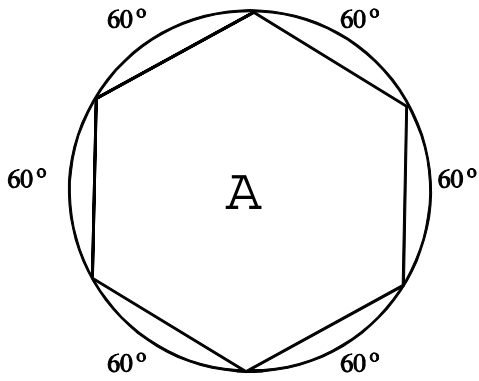

trapt

The Hexagram

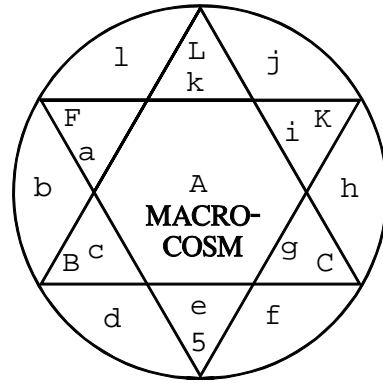

The Heptagon

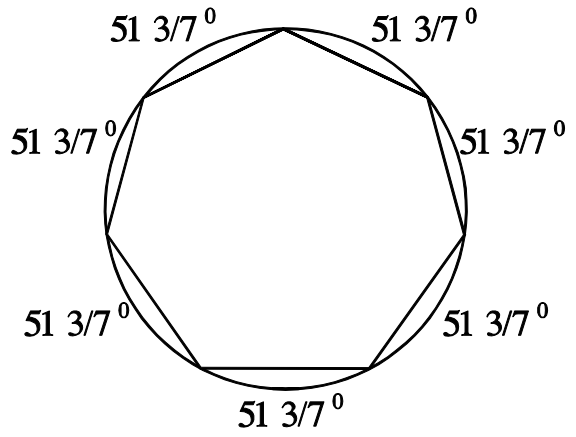

j xn

Unicursal Hexagram

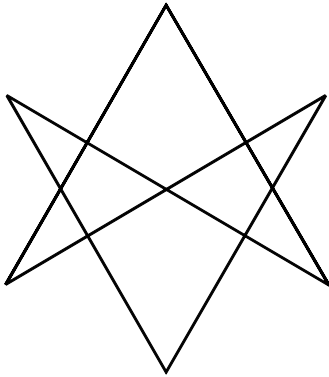

The Heptagram

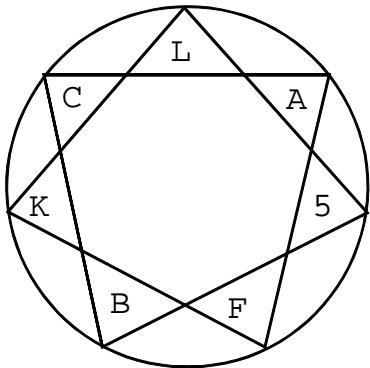

The Heptangle

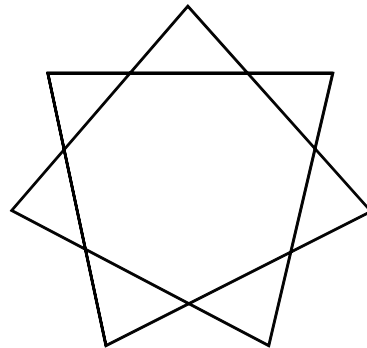

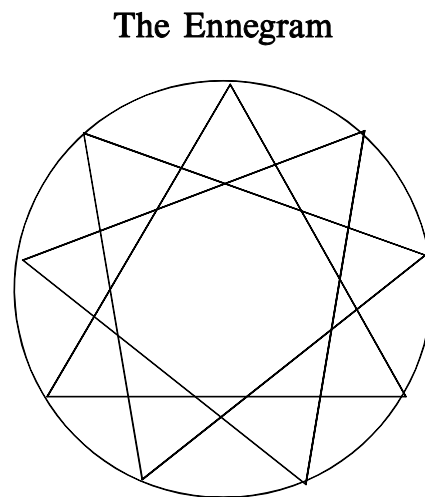
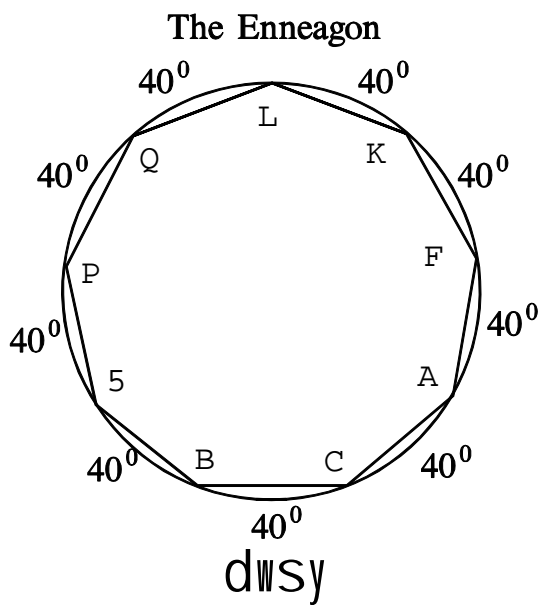
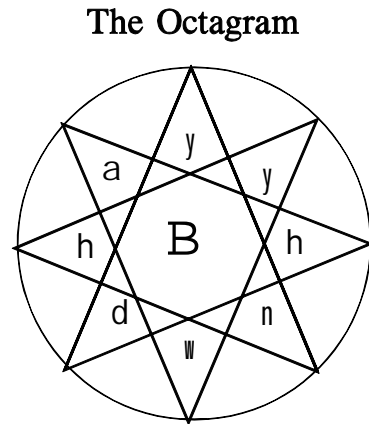
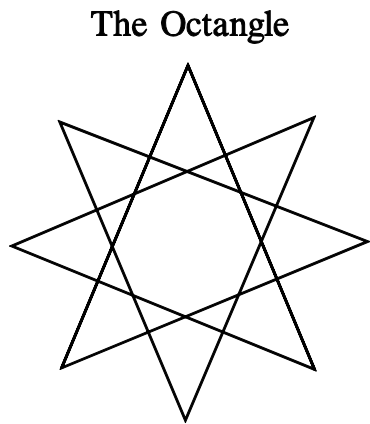
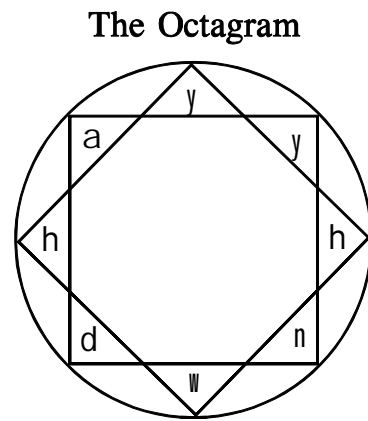
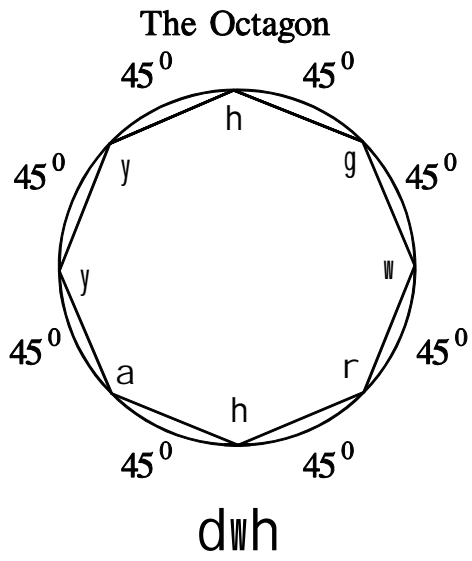

The Enneagram

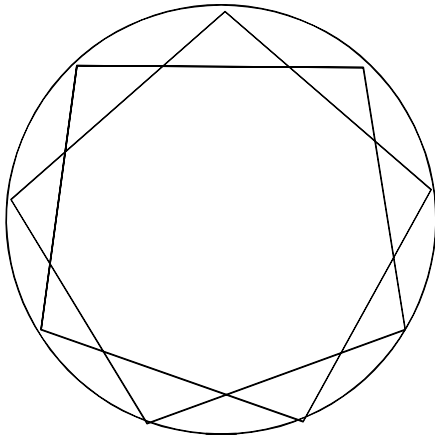

The Enangle

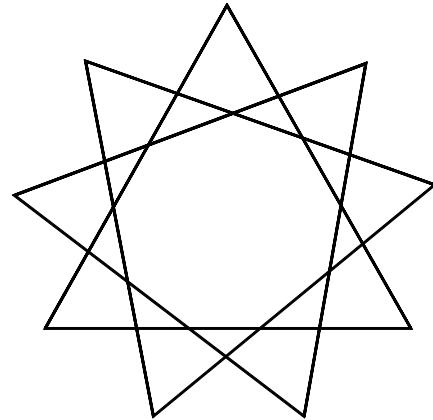

The Dekagon

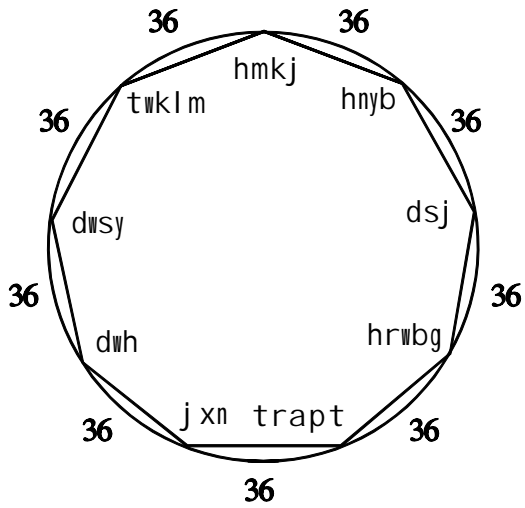

The Dekagram

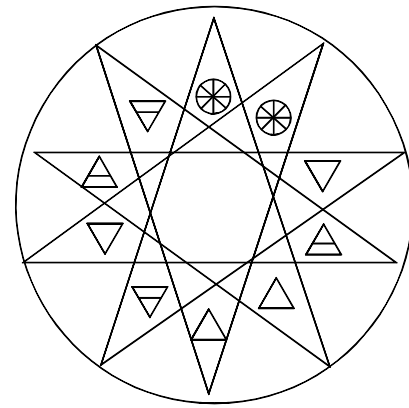

The Dekagon

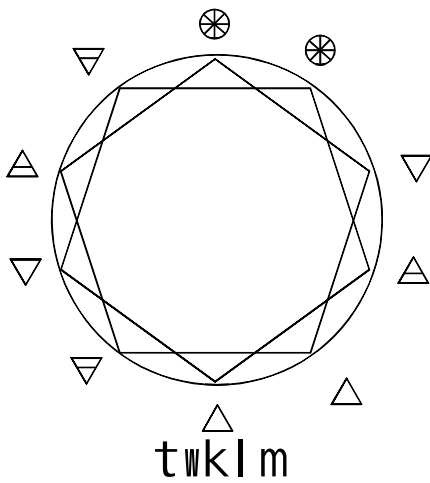

The Dekangle

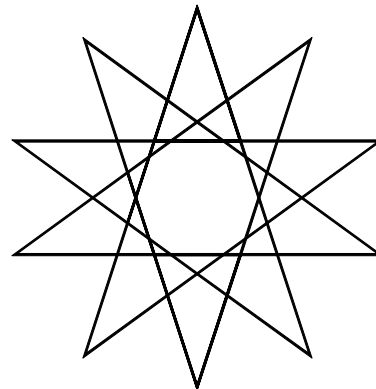

The Endekagram

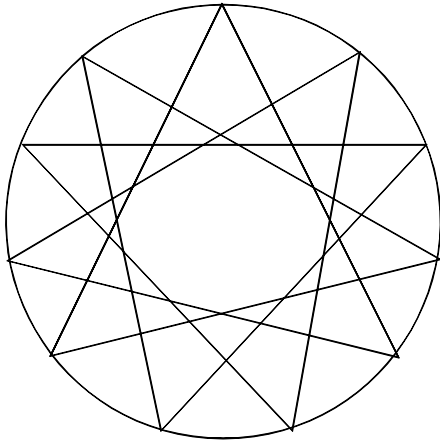

The Endekagon

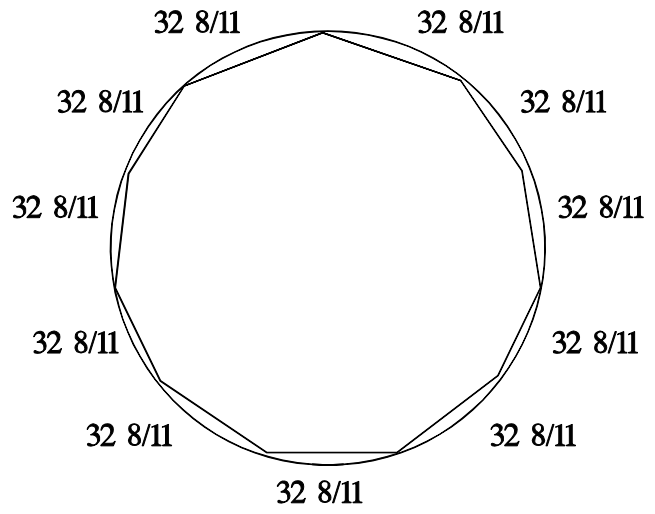

The Dodekagram

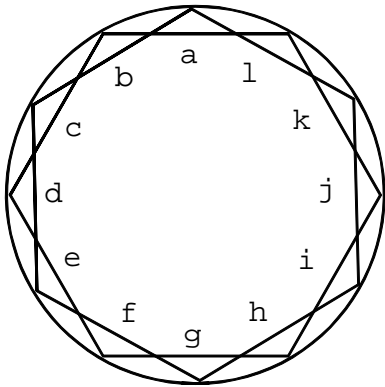

The Dodekagon

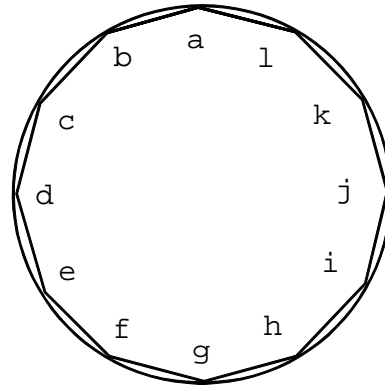

The Dodekangle

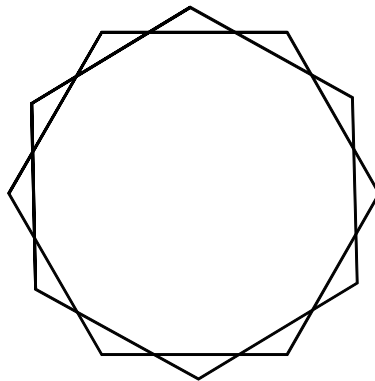

The Hermetic Order Of The
GOLDEN DAWN^{Intl.}

THE PLANETARY ASPECTS

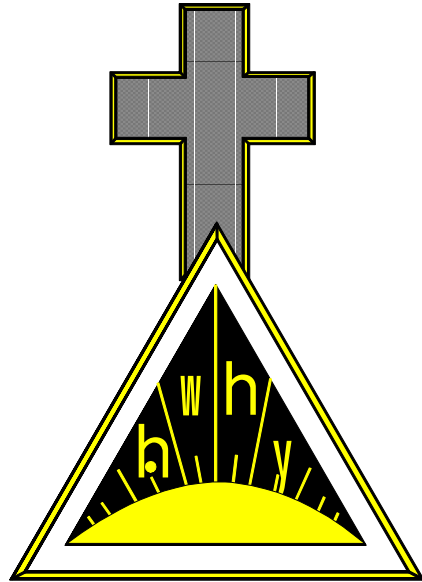

THEORICUS 2=9

Basic Understanding of Planetary Aspects and Influences

In this lesson we will begin to understand the planetary aspects and how they relate to ourselves as individuals and to our personal lives. Also, we will see how they relate from a magical standpoint which will later be used in the rite of invocation. This is vital information for anyone who wishes to do evocative magic. In addition, the understanding of astrology and other important aspects of the Golden Dawn system are equally important to the understanding of such aspects.

In the Zelator grade, some time was spent in the study of the names of the planets in Hebrew as well as their ruling angel, spirit and intelligence. One point that needs to be emphasized in this lesson is that the planets are not the sephiroth. The sephiroth are much larger in scope and dimension whereas the planets are considered the "Heavens of Assiah." If you recall, in the lesson of the Four Worlds, we have the Divine name of God in Atziluth, the Archangelic name in Briah, the Choir of Angels in Yetzirah and in Assiah we have the planets, the "Heavens of Assiah."

ARATHOR	BETHOR	PHALEGH	OCH	HAGITH	OPHIEL	PHUL

Warning!

Notice: Planetary and Olympic Spirits should never be used without caution and then only under the direction of the planetary intelligence. Actual safe methods are taught only in the Second Order. Memorization is all that is required in this grade.

L

Symbols and Implements	Scythe, Keys, Hour Glass, Drawing Compasses, Cauldron
*Qabalistic Number	3
Colors: Atziluth *Briah Yetzirah Assiah	Dove Gray Indigo Soft Red Brown Light Soft Gray
World of Trees	Yew, Elm, Cypress, Mountain Pine, Ebony, Pomegranate
Herbs	Violet, Trillium, White Lilies of all kinds, Opium or Poppy, Night Shade, Horsetail, Mullein
Gemstones	Jet Black Onyx, Diamonds (sometimes)
*Metals or Minerals	Lead, Glass, Smoke or Clear Pumice, Geodes, Slate, Basalt
Deities	Nephthys, Ptah, Harpocrates "The Child Horus", Isis, Ea, Ishtar, Sheva, Brahma, Saturnis, Hera, Chronos
*Governs	Skin, Bones, Teeth, Structure and the Cartilage, Spleen, Glands, Skeleton (Knees in particular)
*Hebrew Name	Shabbathai
Greek Name	Chronos
Olympic Spirit	Arathor
Animals	Goat, Ass, Antelope, Goose, Peacock, Dove, Bat, Spider
Incense and Scents	Myrrh, Cassia, Patchouli
Sephira	hnyb

* Needs to be memorized.

In the English and Roman cultures, Saturn is referred to as the god that gives birth to her children and then consumes them afterwards. In Greek, Saturn is referred to as "Chronos", otherwise known as "Father Time." In Hebrew we refer to Saturn as the Sphere of Shabbathai. The Olympic Planetary Spirit is Arathor.

The basic description of Saturn is that of loftiness, sometimes considered as mourning or brooding, the force of constriction and crystallization. Saturn has a strong affinity with the land of the depths of the Earth, the advancing of age, and with the long passage of time. It also has an affect on our artistic creativity and the bringing of ideas into material form. Saturn can be a very positive or negative planet depending on how it is used. It deals magically with invisibility. It also deals with karma. Saturn is attributed to the sphere of hnyb. Saturn is often times referred to as, "The Parent of Faith," because from it, in its essential nature, faith does proceed. It has an elemental affinity with Earth. The planetary figure is the triangle.

Saturn affects the physiological functions in the following ways. It governs the skin, all bones, teeth, the structure and the cartilages. It also governs the spleen, the glands, and the knees in particular. Skin afflictions such as leprosy, eczema and scurvy

can be the negative result of Saturn. Restricted afflictions such as impeded circulation and rheumatism, as well as atrophies and maladies can come under Saturn's influence.

One of the deities attributed to Saturn is Nephthys, the sister of Isis, "The Mysterious One, Self Born", "The Self Existent One", "The Everlasting Goddess and Concealed One", "The Mistress of the Spindle and the Loom", "Lady of Heaven and of the West", "Lady of Sais." Her magical image or god form is the one who wears the red crown. She may also be adorned with the old kingdom headdress surmounted by the symbol of the shuttle. She carries with her the two crossed arrows and the bow. She also bears with her the Ankh accompanied sometimes with the Papyrus or the Ouas, "The Scepter of Peaceful Authority".

One other Egyptian god form associated with Saturn is Ptah. He is "The Celestial Artificer", "The First Father", "The Primal Power of the Beginnings", "The Fashioner of the Firmament and Pattern of the Sun and Moon", "The Architect of all that is." Ptah's image is seated upon his throne, but at times he may be standing. He is the god that wears the ceremonial beard which is usually very long and pointed. He normally wears a circling band around his bald head. His body is tightly wrapped, signifying his character as a spirit who moves within "The Wrappings of Form of Creations." Creation comes from the sphere of hnyb. Saturn is in fact part and parcel in hnyb. Ptah bears the Ankh accompanied with the Tut symbol. He is known as "The Lord of Stability."

Another Egyptian god form referred to Saturn is that of Harpocrates, the child Horus. This aspect is included in later workings dealing with Invisibility. This particular god form is the "Sign of Silence." Saturn is enshrouded in mystery, Darkness, and silence.

Also ascribed to Saturn is the goddess Isis, known as "The Mourning One", "The Maternal Mother who gives birth to the world and all creation through restriction." She fits better with the sphere of hnyb than that of Saturn, although she at times has been attributed to the Saturn/hnyb combination.

From an astrological point of view, the aspects of Saturn, as well as the house it rules, indicates how a person expresses the capacity for self discipline and where and how they build structure in their life. Without a well-developed influence of Saturn, an individual cannot go far in life because the discipline and experiences that are necessary to acquire are lacking in an afflicted Saturn. Saturn is also a very karmic planet. Its aspects in regards to other planets show how a person is to fulfill himself or to correct mistakes of the past, thus acquiring valuable experience in doing so and redeeming the deficiencies of one's nature.

A person with a heavily afflicted Saturn can be selfish and rigid in their attitudes. Also, it can cause problems in social interactions which can lead to a lot of misfortunes and personal limitations. People who have a strong influence of Saturn in their natal chart are ambitious in nature. The Great Work becomes very important to this person.

One final note on the planet of Saturn. According to the Hermetic Order of the Golden Dawn system of magic, it is used for all general magical workings. The reason for this is that the planet Saturn is known as a general working planet. Being in hnyb contributes to the fact that it is a general working planet in the pursuit of developing better relationships and understanding between the person and the planet. It is always

important to consider working with the specific planetary influence as opposed to simply using a general energy in many cases.

K

Symbols and Implements	Oak Leaf Crown, Jupitarian Cup, Trident, Royal Scepter, Shepherd Staff, Thunder Bolt
*Qabalistic Number	4
Colors: Atziluth *Briah Yetzirah Assiah	Lilac Blue Light Royal Blue Green Blue To A Shell Pink
World of Trees	True Oaks, Cedar, Pine, Olive, Juniper, Hickory, Sassafras, Maple, Chestnut, Lime, Sycamore
Herbs	Flax, Borax, Ash, Liverwurst, Green Tea, Purple Betony, Sages
Gemstones	Sapphire, Lapis, Luzuli, Amethyst, Turquoise, Aquamarine
*Metals or Minerals	Tin, Zinc, Porphyry, Tektite
Deities	Hapi the Vast One, Hapi of the South, Maat, Amun Ra, Zeus, Athena in the Greek, Jupiter, Poseidon, Adad, Sarasviti, Indra
*Governs	Maintenance of cellular development and integration, Preservation of soft tissues of the body, The intestines in particular with the liver and the digestive processes, Hips, Thighs
*Hebrew Name	Tzedek
Greek Name	Zeus
Olympic Spirit	Bethor
Animals	Eagle, Swan, Owls, Whale, White Bowl, Centaur, Unicorn
Incense and Scents	Nutmeg, Cedar, Pine Gum, Clove, Hyssop, Sarsaparilla
Sephira	dsj

Jupiter's title is derived from the Romans. In Greek it is referred to as Zeus. In Hebrew it is Tzedek. The basic profile of the planet is of being very expansive and optimistic, of granting bestowal. It is majestic and organizing. It has an affinity with the sea or water and the blue sky. It gives a sense of responsible concern and love. It affects religious leadership. It is conducive to prosperity, abundance, and health as well as advancement. It is benevolent energy. The sephira that Jupiter is ascribed to is Gedulah or dsj, meaning love. The elemental affinity of the planet is water.

Some of the negative aspects of Jupiter that affect the body are afflictions of the heart and liver, varicose veins, stroke, excess weight, fatty degeneration, diabetes, and disorders of the teeth in general.

The Olympic Planetary Spirit is Bethor. A drawing of the sigil Bethor is included at the end of this lesson. The Divine names as ascribed to the sephira of dsj are El in Atziluth, Tzadqiel in Briah, Chasmalim in Yetzirah, and finally Tzedek as the Heavens of Assiah. The planetary angel is Sachiel.

One of the deities in the Egyptian Pantheon is Hapi of the North, "The Vast One", "The Unsearchable Lord of the Celestial Rivers", "Father of the Gods", "He Who Makes to Live", "Sustainer of Life", "Creator of Blessings", "Nourisher", "Giver of Peace", "The Father of Increase and of Abundance", "The Lord of the Papyrus", "The Lord of the Lotus", "The Fountain of Divine Power." His image includes a headdress that he wears which compliments a collar and a girdle. His form is male with pendant breasts. In his hand he bears the lotus and the papyrus as "Lord of the Two Niles", and may appear in double images.

Moving on toward the other direction, Hapi of the South is adorned in white and is crowned with the lotus. As Hapi of the North, his adornments are red and he is crowned with papyrus.

The next Egyptian god ascribed to Jupiter is Maat, "That which is true", "The Perfect Measure", "Maat the Beautiful, of Law, Justice and Truth", "The Good Gift", "Sustainer of the Sun, Tracer of the Course of the Sun", "The Changeless and Consort", "Queen of the Earth", "Directress of the Underworld", "The Right Order." Her image portrays her as dignified and stately. The goddess at times may appear to be winged. She bears the Ankh and Papyrus Scepter and upon her old kingdom headdress is bound a single feather of truth that is used to judge those that are brought to her by the god Anubis. This feather is used in the judgement of the heart where it is weighed against an individual's heart. Overseeing the entire tribunal is the god Thoth. Maat is also ascribed to the office of the Hegemon in the Hermetic Order of the Golden Dawn ceremonies.

One final deity that can be ascribed to Jupiter is Amun Ra, known as "The Only One", "The First Peerless", "The Sacred God", "King of the Gods", "He who lives by Right and by Truth", "The Creator of all that is", "Lord of Infinite Space", "King of Kings", "Primal Might", "Light of the World", "Governor of the World", "Lord of Time", "Master of Eternity", "Mighty Bowl of the Mother", "The Ram", "The Great Crackler", "Lord of the Double Plumes." His image is of the god who appears wearing a kilt, a corset, and a collar. He wears a beard and his flat topped helmet is surmounted by double plumes, each plume having double sections divided vertically, or by that of the solar disk and the plumes. In his right hand he bears the Ankh and in his left he holds the "Scepter of Peaceful Authority." He is benevolent. He may have a ram's head bearing the Ankh and Owas while wearing the old kingdom headdress surmounted by the disk and plumes. Sometimes he may appear in full form as the ram with curling horns.

From a personal horoscope and natal chart standpoint, there are many factors to consider in determining the framework of the process of self actualization, including the aspects of Jupiter on a house or position where it rules.

Jupiter, which is an expanding and benevolent planet, takes place by means of the collective principle. We gain cooperation of others through the use of Jupiter. Such cooperation is based on shared social and religious attitudes with the purpose of providing for the collective needs of the community. Also, we see that Jupiter deals

with the moral and philosophic nature of an individual and determines the channels through which it will function.

Jupiter is the planet of individual growth and self actualization. The Jupiterian principles are two-way processes. The individual cannot expect to receive from society without contributing in equal measure. Call it the law of karma if you will. A community, by combining resources and ability, can accomplish greater tasks and finer intricacies than the individual alone is capable of achieving. Jupiter indicates how we can serve this general welfare. Not only of ourselves but of course toward society and the greater work as a whole. If we have an afflicted Jupiter, we find difficulty in cooperating with others in commonly accepted modes of social behavior. We become hypocritical in our behavior. We see how Jupiter works with other planets to indicate how we cooperate with a large purpose in the social structure to which we belong.

In conclusion, Jupiter can be used for talismanic and evocational work. The energies of Jupiter are very positive and affirming and are many times used for prosperity and increase. Increase is really the key word, not only in the material, but in the spiritual as well.

F

Symbols and Implements	Lance, Shields, Scourge, Helmet, Sword
*Qabalistic Number	5
Colors: Atziluth *Briah Yetzirah Assiah	Amber Red Fiery Red Mingled Pale Yellow With Creases Of Blue And Green Tinge
World of Trees	Ash, Mountain Ash, Holly, Pepper Tree, White Fig, Mountain Mahogany
Herbs	Thistle, Cacti, Dandelions, Snapdragons, Stinging Nettles, Arrow Root, High John the Conqueror, Blood Root, Wild Ginger, Bamboo
Gemstones	Ruby, Garnet, Red Agate, Bloodstone
*Metals or Minerals	Iron, All Steels, Nickel, Red Jasper, Lode Stone, Flint
Deities	Heru, Behutet "Horus of Edfu", Sekhmet, Ares, Mars or Volcanoes, Ninurta, Nusku, Agni, Durga
*Governs	Development and well being of the limbs, External organs, Nose, Ears, Etc., Sexual organs, Excretory system, Gall bladder, Red corpusals of the blood, Motor nerves, Region of the face, regulation of the metallic trace elements in the system
*Hebrew Name	Madim
Greek Name	Ares
Olympic Spirit	Phalegh
Animals	Ram, Wolf, Woodpecker, Vulture, Scorpion, Serpent, Wasp, Hells Angel, Basilisk, Salamander, Werewolf
Incense and Scents	Opoponax, Dragon's Blood, Nicotinia, Peppermint, Mustard, Cumin, Sweet Woodruff
Sephira	hrwbg

The next planet is Mars. In Greek it is called Ares. In Hebrew it is called Madim. Mars is a dynamic energy. Enthusiasm and resolution are found in the power of Mars. The flame and the heat of fire are its elemental expression. Courage and strength of the body and acuity of mind all typify the character of Mars. It is power. Mars is strength behind these primal connotations. This is the sphere of fraternal comradeship, as of brothers in arms who have faired many perils and dangers. This is the sphere of engineering, of all who work with iron and steel, and of the voice of the people.

The day of Mars was accidentally the day of public assemblies in Roman times. Mars can also be destruction. It is through destruction that we make way for new

growth. The blasted Tower in the Tarot is attributed to Mars. Mars has an elemental affinity with Fire.

The planetary figure is the pentagon. There's an interesting connotation when you think that the pentagon in America is associated with war and the military. This can be attributed perfectly to Mars.

An afflicted Mars can lead to inflammation, accidental injuries, hemorrhages, small pox, general eruptive maladies, infectious and contagious sicknesses, and those particularly associated with high and acute fevers, neuralgia, hyperactivity and hypertension.

The sephiroth is hrwbg. The Divine name is Elohim Gibor. The Archangel is Kamael. The Choir of Angels is the Seraphim. The planetary angel is Zamael.

The Egyptian deities that would be attributed to Mars are Heru, and Behutet, otherwise known as Horus of Edfu. He is "The Great One", "The Son of the Sun", "The Mighty Guardian", "The Remover of the Head of Sutekah", "He Who Enchains the Forces of Darkness", "The Master Iron Worker", "The Patron of All Iron Workers", "The Lord of the Forge", "He Who Splendor Consumes", "He Whose Light Purifies", "The Winged Disk Whose Flame Sends Forth Terror", "Furious in Combat", "The Victorious One", "Thrice-Crowned Lion." His image is of a hawk-headed human. The god wears the Skhemti, the conjoined crown of upper and lower Egypt, upon his old kingdom headdress. He is garmented in kilt, battle corset, and collar. He bears the iron mace, the seerer, and the bow.

Another Egyptian deity is the goddess Sekhmet, "The Great Goddess", "The Sacred One", "The Powerful One", "She Who is Red Garmented", "She Who Dominates the Mighty Flame", "Flame of Protection", "Flame of Retribution", "The Eye of Ra", "The Great Beloved One", "Strength Mighty in Heaven", "Mighty Among the Gods", "The Preminent", "She Who Purifies" and "Guardian of the Soul." Her image is that of a lioness-headed female of immense dignity. The goddess bears the papyrus scepter and the Ankh. Her old kingdom headdress is surmounted by the solar disk and encircling the Uraeus, or by the disk and horns of Hathor superimposed upon two multi-sectioned plumes, or the Uraeus alone upreared and empowered. The goddess may appear standing or she may be enthroned.

On a personal level, in regards to personal horoscope, we see that the aspect of Mars indicates the ability for expression through dynamic and powerful action. Sometimes the action is constructive, other times the action is destructive. If Mars has stress aspects, we tend to act rashly, not considering the consequences of our actions. Our behavior becomes that of a raging fire. Afflicted Mars signifies an ill temper and possible outbursts of anger and violence. Mars energy needs to be constructively and purposely channeled. It must never be left free and unattended. Favorable aspects from Mercury, Jupiter and Saturn will help in this regard. Mercury gives mental insight, Jupiter gives altruistic motivation, and Saturn gives discipline. As an interesting side-note here, in a woman's horoscope Mars indicates the type of man she wishes to attract. In a man's horoscope, it represents the way he expresses his masculinity in attracting a woman. Mars has much to do with desire. There is an invisible link between Mars and Venus. Both are fiery planets. Most people are motivated by what they want to have. Only in the highly developed individual is mentally-based will power the prime determinant.

As a final note, for protection, destruction, and tearing down of the old so that the new may be built, there is no stronger planet than Mars. When used properly with the guidance of will and intelligence, Mars can become an insurmountable force which can accomplish many things, especially when blended with other planets. It takes the aspect of any planet and adds energy and fire to it. Therefore, consequently Mars is a very important planet.

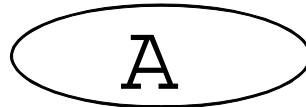

Symbols and Implements	Solar Diadem, Breast plate, Tripod of Prophecy, Sunburst, Solar Sacramental Cup (symbol of the Ruach as recipient of Supernal Drought of Inspiration), Topaz Roman, Holy Oil, Alchemical Crucible, Rose Cross
*Qabalistic Number	6
Colors: Atziluth *Briah Yetzirah Assiah	Pale Greenish Yellow Yellow Pale Gold Yellow Intense Yellow White Flecked With Scarlet
World of Trees	Pine, Walnut, Date Palm, Oaks in general, Acacia
Herbs	Sunflower, Chamolly, Yellow Rose, Chrysanthemum, Marigold, Eye Bright, Lark Spur, Pineapple, Mistletoe, St. John's Wort, Loreal
Gemstones	Tiger's Eye, Topaz, Goldstone, Zircon
*Metals or Minerals	Gold, All yellow and lustrous alloys, Yellow Jasper, Phosphorus
Deities	Ra, Apollo, Dionysus, Helios, Sol, Shemesh, Vishnu
*Governs	Heart and eyes as regards to their health and safety, Upper region of the back, Circulation of the blood, Distribution of all vital fluids, Generation and maintenance of life energy, Growth of children, Vitality in general
*Hebrew Name	Shemesh
Greek Name	Helios
Olympic Spirit	Och
Animals	Lion, Tiger, Panther, Leopard, Bull, Hawk, Bird of Paradise, Bantam, Salmon, Golden Carp, Bee (in particular the honey bee), Griffin, Sphinx, Phoenix, Winged Horse, Winged Serpent
Incense and Scents	Cinnamon, Frankincense, Saffron, Vanilla, Heliotrope, Cashew Nut, Corpal
Sephira	trapt

The next planet is the Sun or Sol. In English, we call it the Sun. In Greek, it is called Helios. In Hebrew, it is called Shemesh. The Sun is authoritative, creative, courage, leadership, balance, health, vigor, aggressiveness, and it is attuned with abundance and spiritual illumination. The life-giving warmth of the light of the day of expression is part of the Sun. It is the visible dispenser of light to the Earth. We can not look at the Light of rtk, but we can feel and see the light of the Sun. Direction and distribution of energies and materials and the giving of wise council, even prophecy and equilibrium, are all aspects of the Sun. The Sun is attributed to the sephira trapt on the Tree of Life. The Sun has an elemental affinity with Air because it is in the sephira of trapt, and all of the sephiroth of the middle pillar are of the element Air, except twklm.

The planetary figure is the hexagon. The olympic spirit of Sol is Och. A drawing of this sigil is included at the end of this lesson.

The Sun is responsible for governance of the heart and eyes in regards to their health and safety, traditionally the right eye in males and the left eye in females. Well-aspected effects governed by the Sun are the upper region of the back, circulation of the blood, distribution of all vital fluids, generation and maintenance of life energy, growth of children and vitality in general. Some of the negative effects of an ill-aspected Sun are disorders of the heart, palpitations, angina, spinal afflictions, afflictions affecting the spleen, ills affecting the eyes, and fevers producing delirium.

In regard to the Sun, the primary deity is Ra, "The Great One", "Self Generator", "The Old One", "Creator of the Breath of Life", "The Exalted Power", "Father of the Gods", "Lord of the Light", "Divine Love", "Radiant of Face", "Wings of Splendor", "The Disk", "He Who Advances", "The Strong Youth", "Lord of Bright Beings", "The Enthroned One", "The King of Heaven", "Governor of the World", "Visible Dispenser of Light to the Earth", "Lord of the City of the Sun", "Indweller of the Lofty Shrine of Truth", "The Beautiful God", "He Whose Heart Has Rejoiced at the Winds", "Golden Glory of the Day." Ra comes in a variety of forms depending on the position of the Sun in the sky. His image in general is the hawk-headed one, wearing the solar disk and the Uraeus upon his headdress of the old kingdom. In his right hand he holds the Ankh and in his left hand he grasps his "Scepter of Peaceful Authority."

In regards to the personal natal horoscope, all aspects of the Sun affect our basic selfhood and self identity in nature and use of our will power. The Sun represents the principle of potential and unfolding power. It does not make any difference how well our horoscope may be aspected; if the Sun is weak, it is likely that we will not go far in life. There would be a lack of basic energy, a lack of courage, and a lack of opportunity available in one's life. The Sun offers vitality. It offers strength. It offers balance because the Sun balances the energies of Jupiter and the energies of Mars. It is the visible dispenser of light to the earth.

In conclusion, let us remember that the Sun is almost always invoked for health and healing purposes. It is invoked when one is suffering from depression and of course the invocation of the Sun is used as a balancing tool many times when other aspects are out of balance. It is also the most spiritual of all the major planets because it is the physical reflection of the rtk sphere. So consequently, the grade of Adeptus Minor is associated with the sephira of trapt and that of the Sun. It is also the sephira

associated with the savior gods. With the Sun we see the eminence of the Lord and Savior Jesus Christ, as well as Osiris, the Risen One.

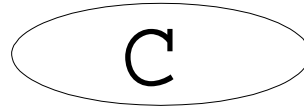

Symbols and Implements	Flaming torch, the System, Garland, Mirror, Necklace, Girdle, Seashells
*Qabalistic Number	7
Colors: Atziluth *Briah Yetzirah Assiah	Greenish Blue Green Light Turquoise Luminous Greenish White
World of Trees	Apple, Pear, Lemon, Lime, Orange, Cherry, Cinchona, Beech, Elder, Fig
Herbs	Red Rose, Hawthorn, Vervain, Myrtle, Colubine, Strawberry, Periwinkle, Hyacinth, Fox Glove, Tulip, Hibiscus
Gemstones	Emerald, Malachite, Jade, Rose Quartz
*Metals or Minerals	Copper, All Bronzes, Coral, Amber, Pearlshell, Sandstone, Sea Salt
Deities	Hathor, Bast, Aphrodite, Venus, Ishtar, Ushas
*Governs	Internal sexual organs, Kidneys, Mouth, Throat, Neck, Lower region of the back, Lymphatic system, Skin in regards to its function in breathing, Absorption and exudation, Nerves, Muscles in regards to tone and relaxation
*Hebrew Name	Nogah
Greek Name	Paphie
Olympic Spirits	Hagith
Animals	Lynx, Cat, Rabbit, Seal, Dolphin, Porpoise, Tortoise, Flamingo, Dove, Bee, Mermaids, Sirens
Incense and Scents	Siamese Benzoin, Red Storax, Red Sandalwood, Valerian, Licorice, Tonka Bean, Spearmint, Lemon Verbena
Sephira	j xii

The planetary name in English is Venus, in Greek it is Paphie, and in Hebrew it is Nogah. Venus is joyous. It is benign. Good luck with love or money comes from Venus. Kindliness and caring are part of Venus. All that makes for concord are attributes of Venus. The beauty and vitality of the natural world and all artistic and congenial surroundings express the influence of the sphere of Venus. This is the planet of desire. Venus is the planet of morning light. Venus is the planet of love. Venus is

attributed to j xii on the Tree of Life. Its elemental affinity is Fire. The figure is the heptagon. The Olympic Planetary Spirit of Venus is Hagith. You will note her sigil at the end of this lesson.

Venus governs the internal sexual organs, kidneys, mouth, throat, neck, lower region of the back, lymphatic system, the skin in regards to its function in breathing, absorption and exudation, the nerves, and muscles in regards to tone and relaxation. Venus helps with the health and well being of the scalp and the hair. An ill-dignified Venus can lead to tonsillitis, goiter, ailments to the throat, maladies affecting the kidneys, the lymphatic system, lumbago, cramps, and venereal ailments.

Venus is attributed to j xii. The Divine name is YHVH Tzabaoth. The Archangel is Haniel. The Choir of Angels is the Elohim. The planetary angel is Anael.

One of the deities attributed to the planet of Venus is Hathor, "House of Heaven", "Mother of Light", "Mother of Life", "Mother of all the Gods", "She Who is Adorned With the Stars", "The Golden Goddess", "Throne of Peace", "Bearer of the System", "Bearer of Joy", "Mistress of Gladness", "Inspiration of the Delight", "Graceful Power", "Milk of Life", "Face of Beauty", "Maker of the Festival", "Bringer of Prosperity", "Lady of the Tomb", "Lady of the Sycamore", "The South." Her image is a human form of superb beauty. The goddess may be enthroned or standing. At times she wears the festal color and the menat, representing the joy of union. She wears the old kingdom headdress which is surmounted by the horn and disk. Upon her brow is the Uraeus or she may be adorned by the vulture headdress surmounted by the Uraeus and the lotus blossoms. Sometimes her human face has the ear of the cow and is framed by very long hair. She bears the Ankh of the Papyrus Scepter. The system is especially sacred to her. It is her herald and her secret voice.

Another deity often attributed to Venus is Bast, "The Blessed One", "Lady of the East", "Eye of Ra", "Flame of the Sun", "Protector of the Kings", "Life of the Heart of the Kings", "Powerful Mother", "Kindler of New Life", "Lady of Springtime", "The Cat Goddess", "Beloved Lady of Bubastis", "She Who Rejoices in People", "Dweller in the High Temple." Her image appears in human form with the head of a cat. The goddess bears the system and the shield of protection. Upon the shield is often the head of a lioness. Sometimes she also bears the corbis, the woven basket of hidden and holy things. On appearing in the fullness of her tutelary power, with the head of a lioness, the goddess wears the old kingdom headdress which is surmounted by the Uraeus and bears the Ankh and Papyrus Wand. Her ancient form is entirely that of a cat. Upon her breast is the eye of Tahuti which symbolizes her power during the night hours.

Some of the astrological aspects of Venus when appearing in the horoscope indicate the areas of life most strongly influenced by the desire for companionship. Venus tells us how love is expressed on a one to one basis and the artistically creative tendencies that we all have. Venus indicates the area in which there is either ability or difficulty in closely relating with others, how and what area the social, romantic and sexual urges are expressed, in where we give love, how we give love, and how we receive joy and harmony. The strength of Venus in a horoscope indicates the capacity to create beauty, harmony, and material prosperity as well. It also explains how we have the ability to attract people and things which we love and desire. When Venus is afflicted there are problems to be worked out, many times in social behavior as well as intimate behavior. It also explains our emphatic desire for certain gratifications. Venus

in a male horoscope indicates the kind of woman he wants to attract. In a female horoscope, it signifies what a woman will do for a man.

From a magical point of view, Venus is a very powerful planet to invoke and the energies are sometimes very overwhelming. The occultist has to use caution when dealing with the planet of Venus because it can create tremendously powerful desires. Strong banishings are always recommended after invoking Venus. It is the planet of desire, the planet of love, the planet of lust, and therein lies some of the danger. It is a very powerful planet and can be used very effectively with corresponding magical workings.

B

Symbols and Implements	Winged Staff, Caduceus of Raphael, Hermetic Scroll, Stylus, Hood, Sacred Tomb, Sandals, Lustrial Vessel, Bell
*Qabalistic Number	8
Colors: Atziluth *Briah Yetzirah Assiah	Yellow Ochre Orange Light Apricot Yellowish White Merging With Greenish White
World of Trees	Birch, Aspen, Almond, Merberry, Pistachio, Magnolia
Herbs	Marjoram, Lavender, Ferns in general, Any kind of medicinal herbs, Castor or Palm, Angelica, Mandrake, Parsley
Gemstones	Fire Opal
*Metals or Minerals	Quicksilver, aluminum and any kind of aircraft or space alloy
Deities	Tahuti, Thoth, Hermes, Mercurous, Naboo, Ganesha
*Governs	Cerebral spinal nervous system and to some extent the sympathetic system, Organs of respiration and of speech, Ears in regards to hearing, Nervous and muscular coordination, Hands, Arms, Tactile senses, Gestures as in communication, Thyroid gland, Region of the waist, Functioning of the brain, Mind faculties as in memory association, Deduction, Reasoning
*Hebrew Name	Kokab
Greek Name	Hermes
Olympic Spirits	Ophiel
Animals	Fox, Giraffe, Zebra, Cheetah, Gazelle, Baboon, Weasel, Jackal, Mule, Ostrich, Carrier Pigeon, Magpie, Butterfly, Greek Sphinx
Incense and Scents	Mace, Star Anise, Mastic, Gum Arabic, Yellow Sandalwood, Orange, Storax or liquid Storax, Lemon Grass, Walnut, Fennel oil, Lavender oil, Clove oil
Sephira	dwh

The next planet is Mercury. In Greek it is Hermes. In Hebrew it is called Kokab. Mercury is a planet of intelligence. It is communicative, diverse, unresting. It has dual and even multiple aspects, but is expressive of truth. Through Mercury we have travel, mathematics, language, calculations, analysis, learning, teaching, and expressions of the higher intellectual mind. The visible and changeable forces of wind are apt to be the symbol of Mercury. Gifts of Mercury are often times freakish or chance type happenings. Mercury is attributed to the sephira of dwh. It has an elemental affinity to water just as its co-partner dsj and Jupiter also have an affinity with water. The

planetary figure is the octagon. The olympic spirit of Mercury is Ophiel. Once again, you will notice a drawing of the sigil at the end of the lesson.

Some maladies associated with an ill-affected Mercury can be amnesia, asthma, speech disorders, bronchitis, abnormal conditions of the thyroids, shingles, any accident or condition affecting the hands or arms, the waist, or any kind of a nervous tick.

The Egyptian deity for Mercury is Tahuti, otherwise known as Thoth, "The One", "Maker of Himself", "Twice Greatest", "Thrice Greatest", "The Divine Scribe", "He Who Knows the Boundaries of the World", "Master of Knowledge", "Mighty in Magic", "He Whose Word Lives", "Witness of Equilibrium", "Arbitrator of Night and Day", "Glowing Heart of Ra", "Ibis of Power", "The Divine Peace Maker", "The Persuasive One", "Bestower of Eternity."

The god form of Thoth is the Ibis-headed one. He wears a kilt and a headdress of the old kingdom and the collar and transverse sash. Characteristically he bears the tablet and the stylus. In other aspects, his headdress is adorned with the lunar disk and the crescent. His face is emerald green, his skin is a burnt orange.

Aspects of Mercury in a house position or in a horoscope involve the way we think and help determine the kind of mind we have. The predominant manner of thinking in the primary area of mental interest is indicated by the dominant aspects made to Mercury. This planet is neutral as far as mental communication, perception, memory and reasoning are concerned. It therefore takes on the coloring of the planet which closely aspects it in the sign and the house in which it is placed. One can achieve a high position without having a reasonably developed Mercury, for a mind is a coordinating factor or lens through which all other abilities must be focused and filtered.

From a magical aspect Mercury can be used for increased knowledge and increased ability to be able to use your magic and thoughts for helping people with mental problems. Mercury is a very powerful planet for education, work and school. Again, Mercury is a very powerful planet to invoke.

5

Symbols and Implements	Silver Sickle, Bridle, Bow, Silver Veil, Mask, Transparent Robe, Crystal Ball, Magic Mirror
*Qabalistic Number	9
Colors: Atziluth *Briah Yetzirah Assiah	Red Purple Violet Lavender Pale Lemon Yellow Flecked White
World of Trees	Willows, Coconut Palm, Bayleaf, Hazel, Papaya, Kerob, Laburnum
Herbs	All white or purple lilly-flowered plants including Hyacinth, Narcissus, All Gourds, Squash, Cucumbers, Melons, Peas, Beans, Lentils, Turnips, Yams
Gemstones	Moonstone and Beryl
*Metals or Minerals	Silver and platinum, Rock Crystal, Mirror Glass
Deities	Khonsu, Ta-ert, Artemis, Selene, Hecate, Diana, Cyn, Sheva, Uma
*Governs	Secretion and utilization of fluids, Tears, Saliva, Digestive fluids, Sexual secretions, Impregnation and the process of birth, All of our life with rhythms, Substance of the brain, Sympathetic nervous system, Uterus, Stomach, Lungs, All mucous-type surfaces including the inside of the nose, mouth, eyeballs
*Hebrew Name	Levanah
Greek Name	Meme
Olympic Spirit	Phul
Animals	Bear, Horse, Elephant, Cat, Hare, Deer, Camel, Dog, Bull, Cow, Owl, Raven, Vulture, Minotaur, Winged Bull, Ram-headed serpent, Harpie
Incense and Scents	Camphor, Orris Root, Gallbanium, Artemisia, Winter Green, Eucalyptus Oil, Jasmine Oil, Aromatic seeds in general
Sephira	dwisy

The next planet is Luna. In English it is called the Moon. In Greek it is Meme. In Hebrew it is called Levanah. The Moon is intense, passionate, and yet sometimes intrinsically cold and changeful. The Moon provides us with in fluctuation, glamour and dreaming. Sudden adventure, spontaneity, child-like wonder and delight are all responsible of the sphere of Luna. The sphere has an affinity with the fluctuating tides of the ocean which the Moon governs into the ever veering waves of our lives. The impulses of the Moon in the work of Caprice, the transient pleasure, are typical

manifestations of Moon force. Also, the Moon is responsible for fertility, but there is also a strong cleansing and purification of the Moon.

The Moon is a very important planet in the sense that it is the reflection of the Sun, and the Sun is the reflection of the light of rtk. So even in the dark of night, the light still shines through the Moon. Further, the dreams of the Moon are the sphere of potential realities of the Earth. Fertility, crops, and birth are all affected by the Moon, as well as many times our moods.

The sephira for the Moon on the Tree of Life is dwsy. The Moon has an elemental affinity with Air. The planetary figure is the Nonagon. The olympic spirit of the Moon is Phul. A drawing is provided at the end of this lesson.

Some of the negative effects of the Moon are maladies relating to accumulations of body fluids, abscesses, tumors, female disorders, afflictions of the stomach, chest colds, coughs, pneumonia, allergies, epilepsy, and recurring ailments in general.

The sphere of Luna is under the auspices of dwsy. The Divine name is Shaddai El Chai, the Archangel is Gabriel, the Choir of Angels is Ashim, and the Heavens of Assiah is Levanah.

One of the Egyptian deities is Khonsu, "The Swift Mover", "The Beautiful in its Fullness", "He Who Stirs the Womb", "Fountain of Fertility", "Dweller of Peace", "Establisher of Time", "Lord of the Vital Fruitation", "Speller of Evil", "The Great Exorcist", "The Great Healer", "The Wonder Worker", "The Countenance of Light Royal Child", "The Veral Bull", "The Ancient Prince of Gladness", "The Very Mighty", "The Restorer of Truth." His image is of a god enthroned like Ptah. He is enswathed. Characteristically, he wears a skull cap adorned with the Uraeus and a single hair piece of a prince of Egypt. He has an ankh in his hand and in addition he has an Owas. He bears the crook and flail. As a standing figure, he appears wearing the kilt and headdress of the old kingdom. The headdress is surmounted by the lunar disk and the crescent.

Another Egyptian god associated with the Moon is the goddess Ta-ert. "The Great One", "Mother of the Sun", "Mistress of the Gods", "She Who Moves Destiny", "Guardian of Woman", "Powerful Helper in Childbirth", "She Who Absorbs the Powers of Darkness", "Bringer of Magical Protection", "Generous, Bringer of Good Fortune", "Powerful Guardian of the Land", "Banisher of Robbers", "Slayer of the Crocodile", "Kindly Guardian of the Souls." In her image, the goddess manifests in the form of a hippopotamus which is standing upright and exposing hanging breasts. Her hand is placed upon the Sa symbol, a folded and bound papyrus denoting a magical protection. In her hand, she may also bear the Ankh which must rest upon the Sa. Her right hand may also rest upon the Sa symbol and may be extended holding an unopened bud of papyrus. Her old kingdom headdress, the back of which is an ornamental continuum reaching to the ground, is surmounted by a horn and disk or plumes.

The Nodes of the Moon

In the Golden Dawn tradition the planets of Neptune and Pluto are not widely used. However, the North and South Nodes of the Moon, Caput Draconis and Cauda

Draconis, were used to give more specific details in natal chart work. We still feel that these nodes should be used because they do give an indepth look at the natal chart. We consider, in the Hermetic Order of the Golden Dawn, Pluto and Neptune more generational and Aeon-type planets than we do specific planets.

Aspects of the North Node determine relationships to prevailing social trends and attitudes in their use of opportunities afforded by history in the making. The North Node brings occasions for increase as a Jupiterian connotation. Aspects of the South Node indicate what habit tendencies rising out of our past experience influence our present attitudes and behavior. Also, the South Nodes show the karmic influence of our past conduct. The South Node has a Saturn type influence and connotation.

Since the beginning of time, occultists have been using the Moon for various magical workings. Invocations are done in the proper planetary hour and time in accordance with the Moon. Also, you will notice that most invocations are done on a waxing Moon, banishings are done on a waning Moon, and of course the dark Moon or no Moon at all is usually a time of inner growth, pathworking, and inner travel. The Moon again is a very powerful planet, particularly when it comes to sexual desire and urges as well as fertility in one's life.

Final Notes

This lesson is very important for planetary workings later on in your study. Understanding the aspects of the planets and learning as much as you can about the planets and how they not only affect our lives but how they can be used for magical invocation is very important.

Often times, and with quiet humor, the Adepts of the Hermetic Order of the Golden Dawn find that Outer Order members will say, "All I need to do is invoke a certain kind of energy..." We find that they do not know the proper steps for invoking specific energies. The first step, beyond all others, is to know all the qualities, the colors, and attributes of a particular planet. Otherwise, any other steps that you take in an invocation or evocation for magical use of that planet will be in vain.

Planetary Aspects

Planet Symbol	Planet in Hebrew	Metal	Angel	Sphere of Intelligence	Spirit
♄	Shabbathai	Lead	Cassiel	Agiel	Zazel
♃	Tzedek	Tin	Sachiel	Iophiel	Hismael
♂	Madim	Iron	Zamael	Graphiel	Bartzabel
☉	Shemesh	Gold	Michael	Nakhiel	Sorath
♀	Nogah	Copper or Brass	Hanael	Hagiel	Kedemel
♁	Kokab	Quick Silver	Raphael	Tiriel	Taphthartharath
☾	Levanah	Silver	Gabriel	Malkah be Tarshi-sim vead Ruachoth Schechalim	Schad Barsche- moth ha-Sharta- than

Olympic Sigils of the Planets

♄	♃	♂	☉	♀	♁	☾
ARATHOR	BETHOR	PHALEGH	OCH	HAGITH	OPHIEL	PHUL

The Hermetic Order of the
Morning Star

ZODIACAL ASPECTS

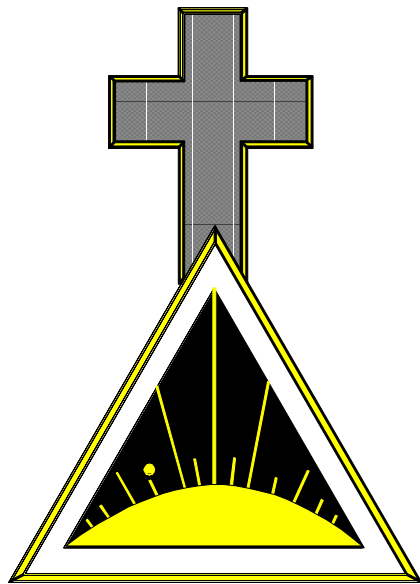

THEORICUS 2=9

In the Theoricus grade the goal is not to make you an Astrologer or to give you the skills necessary to cast daily forecasts. This is better left to specific courses that are available on the market today. There are several fine books and many astrological courses that the student can purchase or subscribe to if an indepth interest in casting horoscopes is wished to be pursued. The Hermetic Order of the Golden Dawn believes that there is a certain influence of the planets and the zodiacal signs that have an effect on our lives on a karmic level. Therefore, you will receive enough information in this grade to help in understanding each zodiacal sign.

The understanding of these signs is critical for later ceremonial workings and in magical application. In reality, the occultist has to have a well built armament available to him to be able to decide how to handle any particular life-given situation. So, in essence, each zodiacal sign is a storehouse of a particular type of energy or mode of operation. Thus, should the occultist later decide to invoke that particular energy for personal use, it is imperative that he has a good basis of understanding of the energy. This applies not only to zodiacal energies, however, it is important to build a solid foundation of knowledge before beginning any particular task of invocation with any form of energy.

The following is a chart that the students may consult from time to time. Memorization of the content is not required in the Theoricus grade. However, it will prove to be handy to the Theoricus who does plan on pursuing the grade of Adeptus Minor.

Sign	Stone	Ruler	Metal	Color
Aries	Diamond, Amethyst	Mars	Iron	Red
Taurus	Moss Agate, Emerald	Venus	Copper	Red Orange
Gemini	Crystal, Aquamarine	Mercury	Quicksilver	Orange
Cancer	Emerald, Black Onyx	Moon	Silver	Amber
Leo	Ruby, Diamond	Sol	Gold	Yellow
Virgo	Pink Jasper, Hyacinth	Mercury	Quicksilver	Yellow Green
Libra	Diamond, Opal	Venus	Copper	Emerald
Scorpio	Topaz, Malachite	Mars	Iron	Blue Green
Sagittarius	Turquoise, Carbuncle	Jupiter	Tin	Blue
Capricorn	White Onyx, Moonstone	Saturn	Lead	Indigo
Aquarius	Sapphire, Opal	Saturn	Lead	Violet
Pisces	Moonstone, Crystallite	Jupiter	Tin	Crimson

These twelve zodiacal signs are divided according to their affect on humanity into Cardinal, Fixed and Common Signs. The triplicities can be dvided into three seperate catagories, aside from their classification as a triplicity.

The Cardinal signs are: Aries, Cancer, Libra and Capricorn.

These signs are called Cardinal because when the Sun is in these signs, it is in one of the four corners of the heavens at a turning point where it is forced to take another direction. In Aries, the Sun is in the far east. Cancer is in the topical point of the north where the Sun emanates the perpendicular rays of the Summer Solstice and consequently the greatest heat. Libra is the extreme western point of the Sun's path where the Sun turns away from the northern hemisphere. Finally, in the midwinter, the Sun is in Capricorn which is located at the farthest point south, where the horizontal rays leave the people of the north icy, cold.

Zodiac literally means circle of animals. The symbols of the three signs are animalistic. Aries is the ram, Cancer the crab, and Capricorn the goat. The fourth is Libra, the scales, that represents the ideal toward which this class must strive. This is a brief synopsis of the Cardinal signs.

The Fixed signs are: Taurus, Leo, Scorpio and Aquarius.

When the Fixed signs are on the angles of the first, fourth, seventh and tenth houses, they exert an irresistible force compelling the individual along certain lines. The setbacks which would take or steal the courage from a person with a Cardinal sign do not seem to dominate a person with a Fixed sign on the angles. They seem to know no defeat and therefore they usually seem to achieve their goal in the end. This is done by their concentration upon one point that gives them persistence in the following of their chosen path. Likewise, those people with a Fixed sign many times are very conservative. Overall, people with a Fixed sign are known to be the most reliable people in the world either for good or for bad. Be it one way or the other, they can be considered reliable.

The third type of signs are known as the Common signs.

The Common signs are: Gemini, Sagittarius, Virgo, and Pisces.

One expression that is used today in place of the term Common is the word "Mutable." The reason that the words Common or Mutable are used is that these signs are very flexible. The powers of the common signs deal more in mental and spiritual areas. They seem to give purpose to an action as well as an incentive to the nobility of life.

Generally these Common or Mutable signs are non-violent in nature. They can be intensely moral, intensely intellectual and intensely spiritual in nature. One of their weaknesses and strengths is the fact that they are swayed to and fro. Nothing appeals to a Mutable sign permanently. They desire nothing as much as change. They seem to live by the maxim: "A rolling stone gathers no moss." For example, if someone who is a Mutable sign were to receive a job offer in one city, and at the same time is given another job offer from across the world for the same amount of money, chances are they would take the offer from across the world. Comparing this to the person that is a Cardinal sign, the Cardinal sign would take the offer that is closest to home; whereas the person who is a Fixed sign would probably not even change his job unless it is definitely a part of his goal structure.

As mentioned earlier in this lesson, there are many books and courses available for one who wishes to go in depth. We will not do that here. However, we want to give you an introduction to the different types of signs. This will give you a good basis in your study if you should ever cross any of the terms mentioned above in any book. In the information already mentioned, we are dealing with the aspects of the sign that affect the human personality through the zodiacal influence. Let us now move on to the zodiacal aspects themselves. This information is important, since the understanding of it will allow one to practice it in the works of certain magical operations such as self-improvement, overcoming of obstacles in your life, achieving financial security, success, happiness, joy, love and health.

a Aries m

March 21 - April 19

Cardinal fire

Ruler: Mars

Keywords: Initiative, activity, enterprise.

Key Phrase: I am

Aries is the first sign of the zodiac and deals with new beginnings. Its key phrase is "I am." Aries is full of creative energy, fire, and enthusiasm because it is ruled by the planet of Mars. Arians like to initiate new activities which keep them very occupied until the novelty wears off.

Aries is mythologically represented by a ram and the symbol describes most accurately those born under its influence. A pointed and sharp protruding sheep-like nose, a wide forehead, pointed chin, and a triangular face are usually noted in people that are of an Arian nature.

A light brown or reddish tint to the hair is a pronounced characteristic of the Arian. Generally, the body is slender and well formed. Arian people are generally bold and impulsive, leaders rather than followers. They are also initiators and self confident, but many times they lack persistence to carry a project to its conclusion.

Here is a list of both positive natural traits of the Aries as well as some of the negative traits.

Positive

Courageous, bold, inspirational to others, intuitive, perceptive, tends to take the initiative, direct and decisive, likes to lead others out of darkness.

Negative

Foolhearty, zealot, egotistical, oblivious to all thoughts but their own, acts without forethought, lacks all subtlety, very opinionated, uses others exclusively for their self interest.

Plants

Radish, rhubarb, pepper, hemp, garlic, poppies, holly, thistle, nettles, onions, dock fern and mustard.

As mentioned earlier, Aries keyword is "I am." It is new beginnings and as such can be used magically for all kinds of new beginnings, particularly where the element of Fire is needed.

b Taurus n

April 20 - May 20

Fixed Earth

Ruler: Venus

Key words: Possessions, determination, practicality

Key Phrase: I have

Taurus is the sign of determination and of power. It is an Earth sign. Taureans are born to achieve mastery over physical matters. The Earth element teaches and guides them to become efficient in all practical matters of life. They strive for their spiritual truths while working within the framework of practical aspects of their life. The key phrase is "I have." Taureans love satisfaction, comfort, and pleasure. This is a very strong characteristic for those people born under this sign. Taureans are very sensual as well.

Taurus is represented by a bull in the zodiac. Their bodies are generally short and stalky. They have very strong necks and have strong ear lobes, a full face, and heavy jaws. The nose is generally short and stubby. Dark eyes and wavy hair give the Taurean considerable beauty. You can usually tell a Taurean by the way he walks, for they usually plant their heels first and heaviest into the ground. In love, in hate, in work, and play, they are very persistent and steadfast in any given direction. Venus is the ruler of Taurus which makes them fond of beauty and strength. The ruler also gives them artistic ability as well as musical inspiration.

Some of the characteristics of Taurus are listed below.

Positive

Steadfast, loyal, intensely sensitive, understanding, composed and calm, affectionate and generous, practical, firm, productive and fertile.

Negative

Stubborn without just reason, overly emotional, aloof, dry and hard, over-indulging in sensual appetite, stingy and rigid, seeks only material rewards for all efforts.

Plants

Moss, lily, spinach, daisies, dandelion, beets and myrtle.

From a magical aspect invoking Earth, or in this case Taurus, is especially important for financial aspects, steadfastness, strength, persistence and durability.



May 21 - June 21

Mutable Air

Ruler: Mercury

Keywords: Mentality, versatility, nonconformist.

Key Phrase: I think

People born under the intellectual Air sign of Gemini are ruled by Mercury and they think and act swiftly. The key phrase for Gemini is "I think." Geminis seem to identify and classify every thought and every thing. Speech is especially important to the Gemini. It seems to serve as a frame work for all of their activities. Words are anchoring or safety devices as the mind jumps from one thought to another. Perhaps one of the negative characteristics of the Gemini is the fact that many of them are chatterboxes. Geminis use their entire body for communication, as communication is their strong suit. They are thirsty for knowledge and eager to study. Generally, they have a highly developed learning capability.

The symbol for Gemini is the twins. When Gemini is the rising sign, the body is generally tall and slender, the arms and legs are particularly long, the fingers are slender, the hair is dark, and the eyes are dark or hazel. You can always spot a Gemini's eyes, because his eyes are full of expression and restlessness.

Some of the characteristics of Gemini are listed below.

Positive

Lighthearted, cheerful, extremely intelligent, versatile and adaptable, sensitive to others, clear and objective in thinking and precise.

Negative

Silly, super-intellectual in all words, they dissipate through lack of a unifying purpose, nervous and excitable, cold, aloof, unemotional, indiscriminate.

Plants

Yarrow, woodbine, vervain, tansy, dog grass, madder.

Gemini can be invoked whenever an Air sign or Mercurial energies are required and whenever swiftness of thought is necessary. Gemini can be used to help someone who is suffering from mental problems. It also has the potential to be used for harm mentally.



June 22 - July 22

Cardinal Water

Ruler: Moon

Keywords: Sensitivity and tenacity.

Key Phrase: I feel

The key phrase is "I feel." Cancers are emotionally sensitive. This is the strongest of the Water signs, favoring women more than men. Cancer of all the signs of the zodiac is most strongly linked to homemaking and domestic activities.

Cancers possess very highly developed protective and defensive instincts. These instincts are aimed at material and domestic security. They are very sensitive and fearful of ridicule. Thus we have the crab shell. Cancer, of course, is symbolized by the crab and it represents a kind of crust or armor which they hide behind. What they are really hiding is their sensitivity and their shyness, as well as their physical and psychological vulnerability. Cancers often times will protect themselves from emotional hurt by withdrawing and finding security in solitude.

The chief peculiarities of the crab are being clumsy, having slender limbs, and powerful claws. People born with Cancer rising express them all. They have large upper bodies, augmented in later years by a prominence of an abdomen acquired by

overeating. They have powerful lower jaws hinged to their cranium and therefore their face is generally widest between their ears. Their mouth is generally large, similar to that of a crab. Their face is full, hair brown, eyes blue, complexion pale, many times sickly. The Cancer sign has the least vitality of any sign.

Some of the characteristics of Cancer are listed below.

Positive

Sensitive to all feelings, cares for others needs and wants, psychic and impressionable, good at holding the family together.

Negative

Can become hysterical, extremely selfish, unfounded fears, can be too clannish and snobby, and can be oblivious to all desires but their own.

Plants

Cucumbers, squash, melons. All plants that grow in the water such as water lilies and russets.

Cancer can be invoked magically for a number of areas that require the use of water, of settling, of calming for domestic reasons, and so forth. Many times, invoking Cancer into a household where there is a lot of fighting and anger will cause that household to become very calm and resilient. Often times those people will be able to put their relationships back together.



July 23 - August 22

Fixed Fire

Ruler: Sun

Keywords: Vitality, authority and power.

Key Phrase: I will

Leo is the sign of the lion. Those born under the sign of Leo are filled with generosity, nobility, and feeling. The sign Leo represents man's attempt at self expression. That is important because Leos need to express themselves. Leos are filled with eternal power. Leo is a Fire sign ruled by the Sun. Leo rules the heart and therefore these people give of themselves generously through their time, their money,

their power, and their knowledge. Leos are strongly attracted to the opposite sex. They are strong in general. They love nature.

Often times, Leos dislike repetition and can become impatient and often obstinate. Those who disagree with a Leo's opinion should be tactful, for he will surrender so long as his dignity is recognized. The key phrase for Leo is, "I will." It is through the power of the Sun that a Leo draws its vitality, strength, energy, and will.

The lion is the king of beasts and even in captivity is the embodiment of pride, power, authority and stateliness. Leos generally have massive shoulders, strong arms, large heads, long, curly, and wavy hair, and blue or green eyes.

Leos are strong and have great endurance and recuperative powers. People who are born under the sign of Leo always want to be noted. They are aggressive and want to attract attention everywhere they go. They aim to be leaders and never followers.

Some of the characteristics of Leo are listed below.

Positive

They are self-assured, warm and sincere, affectionate and loving, protective, cultivating, artistic, expressive, inspired by universal love.

Negative

Vain and self seeking, falsely modest, lustful, dictatorial, extravagant, braggart and egotistical.

Plants

Anise, camellia, daffodil, eyed bright, fennel, lavender, yellow lily, poppy, marigold, mistletoe, parsley and cattail.

Leo is one of the Kerubic signs utilized for the element of Fire. As such, Leo can be invoked at anytime that the element of Fire is required for magical purposes. Leo as a zodiacal sign is invoked for healing and to rejuvenate. Leo can also be invoked to help crops grow and to help the body heal after a serious illness or accident.



August 23 - September 22

Mutable Earth

Ruler: Mercury

Keywords: Discrimination and service.

Key Phrase: I analyze

There is nothing more important to the Virgo or Virgo nature than work. Virgos are on a constant quest for knowledge because they are ruled by the planet Mercury. They are constantly trying to bring matter under control through the use of their minds. The nature of Virgo is such that they must learn that although the body must serve the mind, ultimately the mind must serve the spirit.

The symbol or sign of the Virgo is that of a virgin with sheaves of grain in her hands. The sheaves of grain represent wisdom that is harvested in the fields through hard work and through experience.

The nature of Virgo is that of being meticulous in their work and their study, and in paying a great deal of attention to details, by doing things carefully and efficiently. They like to bring order out of confusion. Virgos have great minds and many times are able to become great scholars and thinkers. The key phrase for Virgo is, "I analyze."

Generally, people that are born under the sign of Virgo are of middle stature and the upper part of the head is more developed than the lower part of the head. They generally have a weak chin which shows a lack of will. The large brain indicates greatness of intellect. The face has a sallow complexion. The hair is normally of a brown or darker color. There is usually a thinking appearance to the eyes. The feet are small and the toes are turned inwards. It gives the Virgo a peculiar, labored kind of walk. In other words, they walk as if they are very old.

Some of the characteristics of Virgo are listed below.

Positive

Helpful, unassuming, clear and sharp eyed, dependable and unselfish, precise and meticulous. They are born researchers and scientists, calm and self-reliant. Virgos are generally attracted to the Occult sciences as well.

Negative

Manipulating and underhanded, fault finding, indecisive, a hoarder, forgetful of where things are, superficial and secretive, nervous and utterly dependent, and very critical.

Plants

Endive, Millet, Corn, Wheat, Barley, Oat, Rye, Valerian, Skullcap and Woodbine.

Virgo itself can be invoked whenever Mercurial energies are needed to help in scientific endeavors, in analyzing, in putting puzzle pieces together in one's life, in business or in any particular specialized endeavor. Virgo can be utilized where a combination of Water and Earth are required. Since it is Mutable Earth you will achieve a softer type of Earth, a more flowing, resilient type of Earth than that of Cardinal Earth.

g Libra s

September 23 - October 22

Cardinal Air

Ruler: Venus

Keyword: Harmony, companionship and balance.

Key Phrase: We balance

Venus rules the sign of Libra which gives these people charm, grace, and expression combined with the desire for popularity and the approval of others. Libra is a Cardinal sign. Libras are concerned with presence and will initiate activity. They usually seek the cooperation of others rather than continue on a project alone. They are good organizers and generally are very popular people. Libras have a special need for companionship. At the same time that they need companionship and a lot of people around them, they still have the need to be an individual and to be able to spend time alone. The higher evolved Libra will never compromise his need for popularity with his personal integrity.

One simple word that best symbolizes Libra, the scales, is elegance. The body is slender and graceful. It will become more plump as life goes on, but also pleasing and always in proportion. The complexion is generally smooth and clear. The eyes are soft and blue with a kind expression. The mouth is usually well formed and the teeth are usually fine and even. The keyword for Libra is, "We balance," and that in itself is interesting. Libras are very balanced human beings. So more than any other sign, the male Libra has a lot of feminine qualities in him, while the female Libra tends to have many masculine qualities.

Some of the characteristics of Libra are listed below.

Positive

Completely partial and a balanced mind, refined artistic nature, perfect in marriage and partnership, sociable and gregarious, graceful and charming, and tends to inspire the best in other people.

Negative

Incapable of making decisions, pleasure seeking, manipulates and dominates others, completely dependent on others, superficial and deceitful, seeks relationship for personal gain.

Plants

Watercress, strawberry, many types of vines, balm, lemon, thyme, violet, pansy, white rose and primrose.

Libra can be invoked whenever beauty is desired, whenever the aspect of Venus is required, and whenever balance and justice are required.



October 23 - November 21

Fixed Water

Ruler: Mars

Keywords: Regeneration, resourcefulness, secrecy.

Key Phrase: I create

Some believe that Scorpios are the most powerful sign in the zodiac because the sign is ruled directly by Mars. Scorpio deals with transformation on all levels. The Death card of the Tarot is directly related to Scorpio and we know that death is transformation. Scorpios possess power, will, and intense emotional desires. Generally, they are experiencing a constant struggle between their desires, which tend to be very strong, and their will.

Scorpios directly relate to the sex drive. No sign can be so potent for good or for evil as Scorpio. Since Scorpios generally act with all their power, it is very important that they get a good start from the beginning. Scorpios are very strong defenders of justice, even in the face of death. Unlike Aries, which is also ruled by Mars, Scorpios have great staying power due to their sign being fixed.

The key phrase for Scorpio is, "I create." Scorpio is a Kerubic sign and is often represented in the Golden Dawn system by the eagle. The nose is the most prominent feature of the Scorpio. It is large, heavy and hooked, resembling the bill of an eagle. The brows are generally bushy, the eyes are sharp and piercing, the jaws very heavy. The glint of the eye and the setting of the jaw indicates great determination which is the most prominent characteristic of almost all Scorpios. The face of the Scorpio is angular. The complexion is somewhat murky and the hair is dark with ruddy highlights. The teeth are large and are subject many times to early decay. The body is short, generally with a thick neck.

Some of the characteristics of Scorpio are listed below.

Positive

Creative through rebuilding, healing, strong and loyal, giver of strength, inspiring, seeks mержence with the spirit.

Negative

Destructive, seducer, uses friends for personal gain, psychic vampirism, egotism, wants others to merge with him or herself.

Plants

Heather, ramble, char lock, horehound, house leek, wormwood, bean and black horn.

There is no doubt that a Scorpio's power is indeed tremendous. It is ruled by Mars, and is of a watery nature. The sign of Scorpio itself is attributed to the element of Water, which is symbolized as the letter "m" with a tail. In the Hermetic Order of the Golden Dawn, we prefer the Eagle as the symbol to represent Water. Scorpio is a powerful Water sign and is so whether it be through the positive or negative attributes of this sign. In ceremonial rites, where aspects of Water are needed, Scorpio is invoked.

♐ Sagittarius ♐

November 22 to December 21

Mutable Fire

Ruler: Jupiter

Keywords: Aspiration, love of freedom and exploration.

Key Phrase: I perceive

Sagittarians are usually very straightforward and honest. They fly, much like the arrow that represents the sign, towards one goal. Sagittarians deeply love freedom and liberty. They are energetic, naturally outgoing, and very positive in their thinking. They are ruled under the auspices of Jupiter and this gives the characteristic of bestowal to the Sagittarian, even if it is at the twelfth hour. Sagittarians are very serious thinkers in relation to the well being of themselves, society, and life in general. They are very good with abstract ideas and principles, as well as beliefs. Sagittarians are honest, just, and generous. The key phrase for Sagittarius is, "I perceive." Many times this sight gives them access to the areas that deal with prophesy. They are especially aware of people and their thoughts, as well as their motivations.

People that are Sagittarians are generally a little taller than average. They particularly have large hands and feet. They may tend to be either on the thin or bony side. Later in life, their back may stoop over due to its considerable length. The face is long and well formed. The nose is well proportioned. They have dark and kind eyes and they generally have chestnut hair. Their body tends to be on the active side, but it

does seem to require an extended amount of rest. Their recuperative powers tend to be lower than the average.

Some characteristics of the Sagittarian are listed below.

Positive

Has a vast and inspirational mind, sees the larger issue on hand, generous, teachers and judges, straightforward and bold.

Negative

Inability to regulate mind with matter, exaggerates, gluttonous, never satisfied, and at times can be a loud mouth.

Plants

Anise, copal, deerstongue, ginger, clove, nutmeg, juniper and star anise.

Sagittarius can be invoked magically for use any time that hot fiery Jovian energies are required. Sagittarian energies can be invoked when one is trying to open themselves up and increase their ability to perceive, to understand, and to see things clearly, (not necessarily those of the physical world but more likely of the spiritual or astral world.)



December 22 - January 19

Cardinal Earth

Ruler: Saturn

Keywords: Conscientiousness, organization, ambition and conservative

Key Phrase: I use

Capricorns are Earth signs. They are never content to keep their lives together. They always have a feeling that they must develop into something better than what they are. They must have some accomplishment to look up to, some property to look after, and some kind of obligation to fulfill. If they have these things, they seem to be happier and tend to function much better. Capricorns have excellent intuition, and they tend to use this in their struggle to achieve personal independence, as well as economic security, which is very important to the Capricorn. Their symbol is the mountain goat.

Thus they are steady and sure footed. They love law and order and many times they will tend to be dogmatic in their viewpoints. The key phrase for the Capricorn is, "I use."

Capricorns are usually short and slender, although they can be overweight at times. They have thick necks and usually dark hair. They tend to have a pale or pink appearance to their complexions. They have small and weak eyes. Many times their chins are pointed upwards. The nose is usually pointed downward. Often times, since they are mountain goats, they tend to have an awkward walk. Their vitality is very low, although they have true ambition and tend to be very strong in their goals for the sake of their own security.

Some of the characteristics of Capricorn are listed below.

Positive

Prudence, self-sacrificing, trustworthy, loyal, organizers, executive, deep spiritual understanding, very aware of people's needs.

Negative

Miserable and demanding, unsympathetic, secretive, dictatorial, overly ambitious.

Plants

Hemlock, henbane, nightshade, honeysuckle, patchouli, cypress and magnolia.

Capricorn can always be invoked when strong Earth energy is necessary and where one is strictly trying to provide for material gains, security, and organization in one's life. In that sense, Capricorn is a beautiful zodiacal to invoke. As many of you already know, Capricorn is directly related to the Hebrew letter **ק** which is the Devil card. So Capricorn is both the savior as well as the adversary. It is the savior in the sense that we must overcome our physical desires and seek the spiritual. In overcoming it, we then save ourselves, which opens the channel to our Higher Self. So Capricorn in this sense has a dual nature of being both mundane and spiritual.

k Aquarius w

January 20 - February 18

Fixed Air

Ruler: Saturn

Keywords: Humanitarian, independent, originality

Key Phrase: I know

Individuals born under this sign are born under the sign of fraternity and brotherhood. The sign holds the symbol of the water bearer who seems to spill out the life force and spiritual energy to mankind. Friendship and companionship are extremely important to the Aquarian. Those who befriend an Aquarian generally earn unswerving loyalty. This is a Fixed Air sign and an Aquarius tends to have an eccentric temperament and at times can be both determined and stubborn. There are many times that Aquarians may feel the emotion of loneliness. They feel that those who are listening to them are not receptive and are also incapable of comprehending their ideas and concepts. They tend to become annoyed when people fail to understand them. The key phrase for Aquarius is, "I know."

Aquarians are filled with pride and stateliness, not the stateliness of a Leo, which is more bestial in nature, but the pride and stateliness of one who walks upright or that of a man. Aquarians generally have fearless eyes that are kindly and drooping. Their eyelashes are peculiar to this sign. The forehead is square and well developed, especially in their poise. Their personality tells of intellect. They have a large domed head which shows the spiritual side of the nature. The chin is sufficiently developed to give a purpose to all actions. The typical Aquarian is the highest grade of humanity although the true Aquarian in reality is exceedingly rare.

Some of the characteristics of Aquarius are listed below.

Positive

Gregarious and social, loyal to a cause or idea, strives for brotherhood, intuitive and alert, can love all equally.

Negative

Overly talkative, fanatical, tend to impose their ideas on others and put them under will, have zany schemes and impractical thoughts, cold and aloof, limited human sympathy.

Plants

Frankincense and myrrh.

Aquarius is the Kerubic sign of Air and as such can and should be invoked for all Air workings. However, Aquarius specifically can be invoked when humanity, hope, and some of the higher qualities of human aspirations are needed for a particular purpose.

1 Pisces x

February 19 - March 20

Mutable Water

Ruler: Jupiter

Keywords: Compassion, universality and renunciation.

Key Phrase: I believe

Those born under this sign are extremely responsive and tend to be sensitive to the thoughts and feelings of others. They unconsciously absorb the mental outlook of those around them. Since they are Mutable Water, they oftentimes look toward the right direction, but as a rule they don't tend to have strong will power and therefore can be influenced by external factors. The Piscean symbol is of two attached fish, one swimming up stream, and the other swimming down stream. This implies a drastic duality of emotions of the person born under this sign. Jupiter is one of the ruling planets of Pisces. Since this planet acts as a preserver, it gives the Piscean the faith necessary to maintain vitality in the sense of personal significance. Pisceans tend to have a tremendous amount of humor, charm, and sympathy which many times will open up opportunities for them. The Piscean temperament varies from being very strong and optimistic to acutely pessimistic.

The typical Piscean is short, flabby, and fleshy. Unlike those born under the sign of Cancer, many times they have a stouter body. Their feet are often turned inward much greater than those that are born under the sign of Virgo. The body is weak and deficient in recuperative forces. The complexion is medium, the eyes blue, watery and expressionless. The nose is large and flat. There is a strong tendency for mediumship and direction to the occult world to those who are under the sign of Pisces. The key phrase for Pisces is, "I believe."

Some of the characteristics of Pisces are listed below.

Positive

Unselfish in all matters, vast imagination, creative and innovative, universal scope of expression, and strong spiritual aspirations.

Negative

Seeks to control through giving, hallucinatory and paranoid, locks potential inside self, poor sense of individuality, and a sensualist in all things.

Plant

Seaweed, ferns, mosses, water lilies, and all other plants that grow in the water.

Pisces is considered very magical and is classified as a Water sign under the auspices of Jupiter. More specifically, it is a deep Water sign. A lot of care should be utilized in invoking Pisces. Pisces can be invoked where great intuition and understanding is required in a particular matter. Invoking Pisces will allow the energies to work through you, putting you into a deep meditative state. You will gain great intuition in the understanding of spiritual matters.

It is not critical for the Theoricus to memorize the plants that have been given in this lesson or the attributes of each and every sign as they apply to the physical characteristics of a person born with that sign. The intent of this lesson is to give the Theoricus an overview of the twelve zodiacal signs as they apply to magical purposes, as well as in the application to individuals. This will allow the Theoricus to have a greater understanding of the zodiacal sign and its nature in the hopes that this knowledge will be used in later magical and esoteric workings.

The key phrases for the zodiacal signs should be memorized along with the animal. We feel that with these basics, the Theoricus will have a solid foundation for the future grades.

The Hermetic Order Of The
GOLDEN DAWN Intl.

**THE ASTROLOGICAL
HOUSES**

**THEIR MEANING AND
UNDERSTANDING**

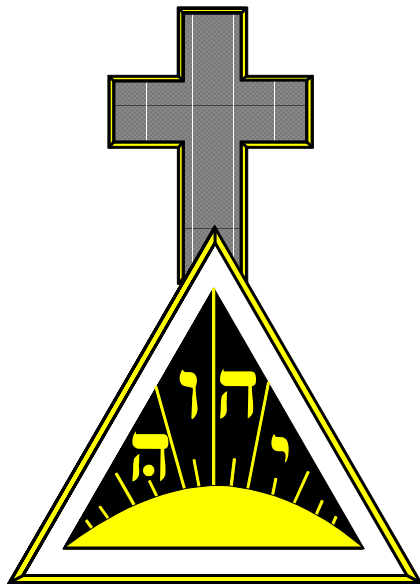

THEORICUS 2=9

Just like the signs of the zodiac, the houses, referred to as Mundane houses, divide the horoscope into twelve segments. Basically, each and every house is related to one sign of the zodiac. The houses, on a physical notation, are defined by the Earth's twenty-four hour rotation on its axis whereas the signs of the zodiac are defined by the Earth's yearly revolution around the sun.

The houses are called Mundane houses to more easily differentiate them from the Celestial houses. The Celestial houses are known as the twelve signs of the zodiac. We will refer to the Mundane houses as houses only. It is the angle of the stella ray which helps determine its effect on our lives. For example, we understand that planets which are in the east generally affect our physical constitution, whereas planets which are located in the south near the Zenith are factors for good or ill, affecting our social position. If a planet is setting in the west during the time of one's birth, its stella rays strike us in such a manner as to draw us to a certain marriage partner. The planets that are under the Earth have more of an affect on our condition during the latter stages of our lives.

Let's take an issue concerning someone born at sunrise on the day when the sun and Jupiter are in conjunction. We can say then that the stella rays strike him from an eastern angle and thus give him a lot of vitality and enthusiasm. Another person may be born on the same day at approximately noon, when Jupiter and the Sun are at the Zenith's position, this person may have a poor and weak body. The second person would be more inclined to a social sphere and would find himself in public favor and honor. A third illustration concerning another child born during Jupiter and the Sun's setting in the west is that this child may be an outcast on condition that the planets in the east and south so decree. The third child will find that he will have successful partnerships and that he will find himself truly loved by his mate.

The houses are grouped according to the basic influence that they tend to exert in our lives. The houses are defined as angular, cadent, and succedent. We also have personal, spiritual, material, and mystical houses. Essentially, the intention here is to divide the houses into their kinds; like attractions and like influences so to speak, much in the same way that we do with the zodiac when divided by their triplicities.

Of the angles, we know that the first house governs the self. If we look at its opposite, the seventh house, we see that it rules the one nearest and dearest to us, mainly our spouse or a loved one of some sort.

The fourth house determines the condition within our homes. Again, if we look at the angle of the tenth house, which is the opposite, it shows our social standing in the community that we live. Thus we can see that the angles show collectively the sphere of activities in our own personal lives.

The second house, a succedant house, shows our financial status or prosperity in regards to how we acquire it through our own efforts and work. The opposite succedent house, the eighth house, shows whatever we may receive from others. This can also be indicated through a legacy or inheritance. The other succedent houses, the fifth and the eleventh, show how our income may be spent. The fifth house indicates the children of our own blood who have claim to some share of our income. The eleventh house shows the children of our brains which are mainly our hopes, our wishes and our aspirations, which also have a tendency to withdraw from our resources as well through emotional, mental and in many cases financial means.

Of the two cadent houses, the sixth house is a house of voluntary services which we perform as our share of the world's work in exchange for an equal portion of the world's wealth. By the same token, we have the opposite house, the twelfth house, which shows how we may be compelled into labor without remuneration under, say for example, prison restraint of some sort. This in itself may not just be limited to a physical prison. The sixth house shows the state of our health. In the twelfth house we can find out if treatments are necessary.

We have another pair of cadent houses, the third and the ninth houses, showing how our lives and our work will confine us to one place or if it will require us to travel and change residences from time to time. There are some people who will establish a home and spend the rest of their lives there whereas others tend to move from time to time over short periods. This is all revealed through the sixth house.

In this respect, the third house shows short journeys and the ninth house shows long travels.

The personal houses comprise the first, fifth, and ninth houses. The first house basically rules your constitution and the physical body. Planets and signs in that house tend to put their imprint on it, to mar it according to the nature of its self generated destiny. Our fifth house shows the love nature of our soul, in the line of its personal expression. The ninth house shows as much spirit that we can comprehend at our present limited state.

Next, we move on to the category called the "Trinity houses." This is one that will concern many, consisting of the second, sixth and the tenth houses. This shows our worldly possessions with our means of obtaining them, and the enjoyment that they will bring to us. On the other hand, wealth or poverty is shown in the second house. Health, without which there can be no joy in any worldly possession, is shown in the sixth house. Public prestige, which is shown in our ego gratification, is shown in the tenth house. The social houses are the third, seventh and eleventh houses. They define and show our various relationships with those we meet in our life long journey. Brothers and sisters related by blood are shown in the third house. Our heart mate or soul mate, with whom our blood will blend with in a different way, is shown in the seventh house. Our friends are shown in the eleventh house.

Next, we come to the last trinity of houses composing the fourth, eighth and the twelfth houses. In these houses we could say that the hidden mysteries of life and the spirit and of post modern experiences immediately following the "Terminus Vitale" are found. On the Material plane, we have the fourth house which signifies the condition of our lives in the latter stages. The twelfth house shows sorrow which impresses us with the hopelessness of material things and, in that sense, the twelfth house is a very important one. The eighth house indicates the nature of our exit from the world's stage. In other words, it will explain to us more clearly how we will transpose ourselves from the physical plane into the next stage of existence.

The houses are essentially important in the Golden Dawn System simply because they are used in advanced Tarot work and geomancy, as well as in the understanding of the creation of natal charts and astrological work. The Order does not proport to spend an indepth length of time in the study of Astrology, however, it still ties in very closely with the Qabalah and its correspondences. From that standpoint, a basic understanding of the houses is essential to the Theoricus.

We have to understand that in the journey from the cradle to the grave we carry around these twelve houses. They are imprinted in the auric sphere surrounding us. As the air envelops the Earth, the houses envelope us. Each house, in effect, will mirror part of our existence. Each house holds some specific karmic lesson that is important to our understanding. Each represents how we have worked before in a given department of our life's task, particularly if referring to past incarnations. At an appropriate time in our life, in accordance with the houses, we reap what we sow in a past life. That is, unless we can forestall the harvest through the use of spiritual development and growth through the mystical systems.

Right now only brief surface coverage of this topic has been given. Let us examine our own personal lives and find if there is something being repeated over and over again. For example, the subject of friends. Is our seventh house afflicted? Is it negatively aspected? Do friends betray and forsake us and leave us heartsick? We need to examine our natal horoscope. It reveals what is hidden in our auric atmosphere.

Once the weakness or the affliction is understood, we then can take magical, personal, psychological, and spiritual steps to overcome this affliction. Thus, we have literally changed our houses and their influences, and their predetermined influences.

This lesson may have covered more than is needed for this particular grade in the study of the houses, but keep in mind that the coverage is intended to convey a general understanding. A list of the twelve houses is being presented. It illustrates their government and force of influence. This is important to memorize, for its use will be practically applied in Geomantic work as well as with the Tarot.

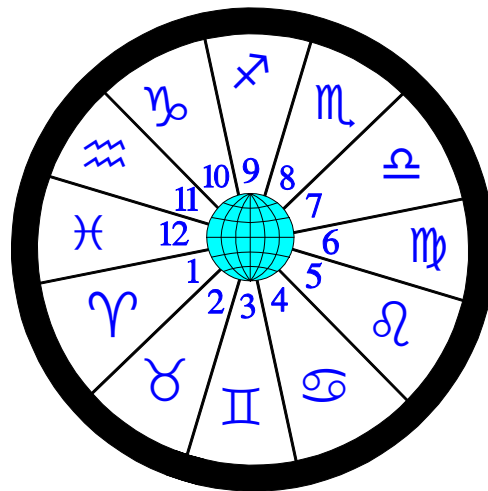

House	Influence
First	Physical body, constitution and appearance, self and personality
Second	Money, financial fortunes and its uses, self worth and resources
Third	Instinctual mind, relatives, short journeys, communication, speculation, logic and mental power
Fourth	Conditions of one's life in the latter stages, houses, land, everything pertaining to the Earth, old age
Fifth	Courtship, love, legitimate and illegitimate attraction involving intercourse, children, educational institutions, sports and stock
Sixth	Health, Employment and Service
Seventh	General public, opponents, litigation and rivals
Eighth	Death, legacies, financial involving marriage, occult faculties merely ready for manifestation, and legalities
Ninth	Religion, spiritual conditions, dreams, visions, long travel, higher education and social institution
Tenth	Prominence, career, honors, social standing and the influential parent
Eleventh	Influence of friends, companions, hopes, fears, wishes, aspirations generally of a material nature, love received and humanitarian endeavors
Twelfth	Confinement in hospitals or prisons, secret enemies, sorrow, occult, self-undoing, psychological health and mystical inspirations

The Theoricus should strive to memorize the influences of the houses and in doing so, one will be preparing him or herself for future work in many other types of operations where the knowledge of the houses is essential for success.

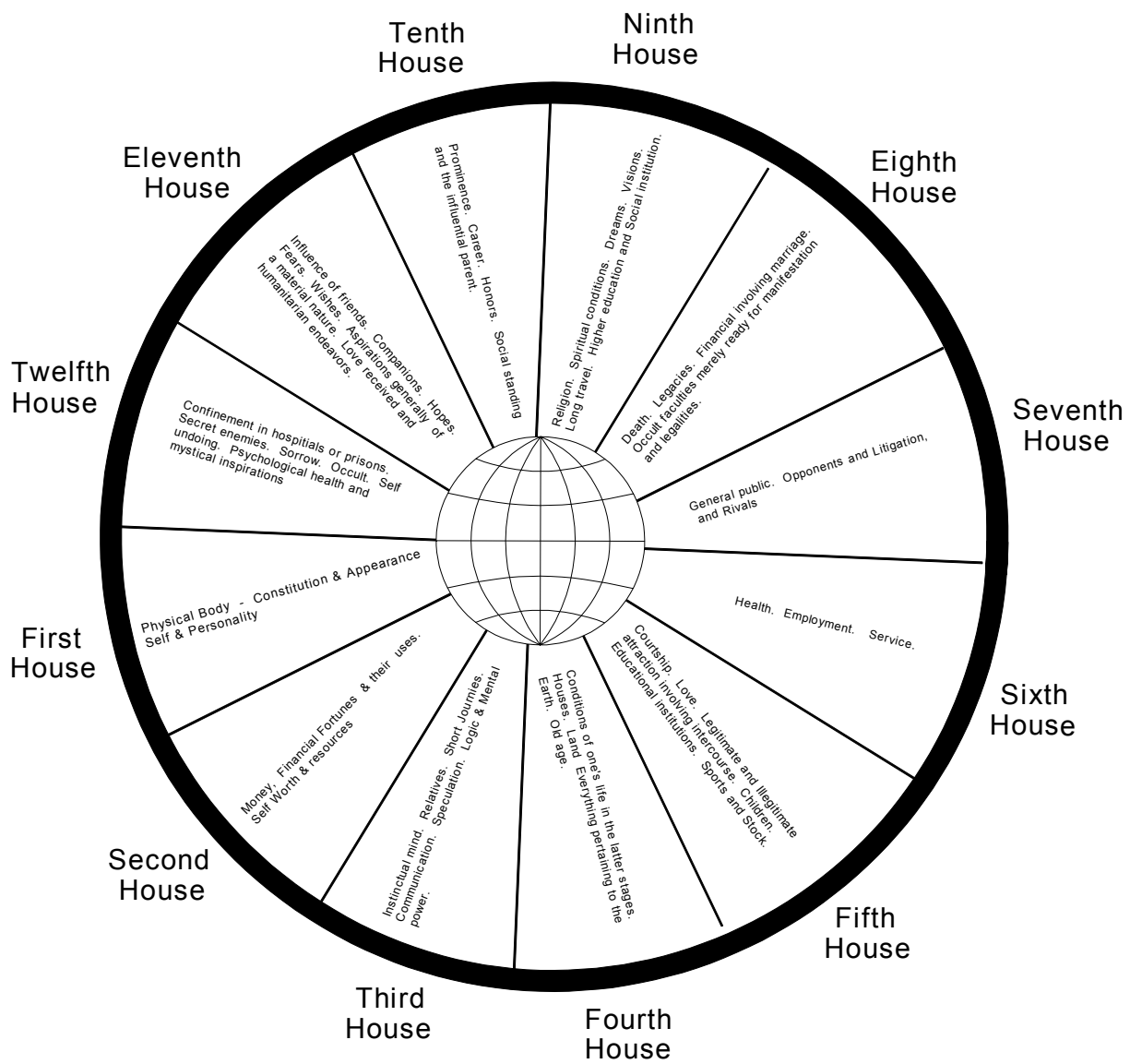

The Astrological Houses

The Hermetic Order Of The
GOLDEN DAWN Intl.

MAJOR ARCANA SERIES

UNIVERSE / PATH OF t

**The Guide for Understanding
The Major Arcana**

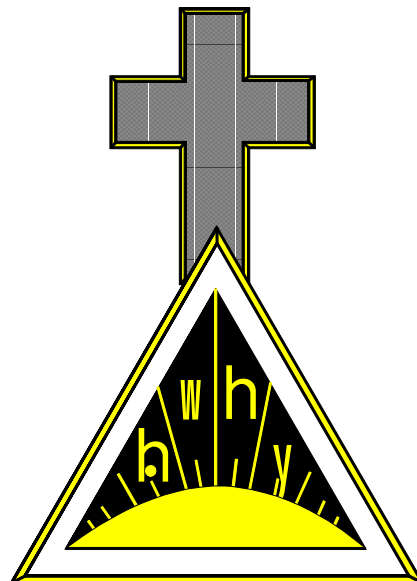

THEORICUS 2=9

(The following description of the Universe Card is taken from the Theoricus Initiation.)

The Thirty-second path of the *Sepher Yetzirah*, which answereth unto the letter t, is called the Administrative Intelligence, and it is so-called because it directeth and associateth in all their operations, the seven planets, even all of them in their own due courses. To it, therefore, is attributed the due knowledge of the Seven Abodes of Assiah, the Material World, which are symbolized in the Apocalypse by the seven churches.

It refers to the Universe as composed of the four elements, to the Kerubim, to the Qlippoth, and to the astral plane. It is the reflection of the sphere of Saturn. It represents the connecting and binding link between the Material and Formative Worlds, Assiah and Yetzirah, and necessarily passes through the astral plane, the abode of the elementals and the shells of the dead. It is the Rending of the Veil of the Tabernacle, whereon the Kerubim and the palm trees are depicted. It is the Passing of the Gate of Eden.

These ideas are symbolically resumed in the representation of the twenty-first Key of the Tarot. Within the oval formed of the seventy-two circles, is a female form, nude save for a scarf that floats round her. She is crowned with the Lunar Crescent of Isis, and holds in her hands, two wands. Her legs form a cross. She is the Bride of the Apocalypse, the Qabalistic Queen of the Canticles, the Egyptian Isis, or Great Feminine Kerubic Angel Sandalphon on the left hand of the Mercy Seat of the Ark.

The Wands are the directing forces of the positive and negative currents. The seven-pointed heptagram or star alludes to the Seven Palaces of Assiah; the crossed legs to the symbol of the four letters of the Tetragrammaton.

The surmounting crescent receives alike the influences of hrwbg and Gedulah. She is the synthesis of the thirty-second path, uniting twklm to dwsy.

The oval of the seventy-two smaller circles refers to the Schemhamporesch, or Seventy-two fold name of Deity. The twelve larger circles form the zodiac. At the angles are the four Kerubim which are the vivified powers of the letters of the name YHVH operating in the elements, through which you have just symbolically passed in the preceding ceremony.

The fan, lamp, cup and salt represent the four elements themselves whose inhabitants are the Sylphs, Salamanders, Undines and Gnomes.

Be thou, therefore, prompt and active as the Sylphs, but avoid frivolity and caprice. Be energetic and strong as the salamanders, but avoid irritability and ferocity. Be flexible and attentive to images, like the Undines, but avoid idleness and changeability; be laborious and patient like the Gnomes, but avoid grossness and avarice.

So shalt thou gradually develop the powers of thy soul, and fit thyself to command the spirits of the elements.

Esoteric Information

The Universe card is the first card we meet on the Tree of Life. It is path thirty-two. We are on the physical plane ascending back to the higher spiritual plane. The

doorway for our ascension into the spiritual plane is the Universe card or t, path thirty-two. This path leads from t~~u~~klm, known as the Kingdom or the Earth, to d~~u~~sy, referred to as the Foundation.

The path color is indigo. The meaning of t is cross or equal-armed cross. It is a double letter which means power and servitude. The esoteric title of the Universe or the World card is the "Great One of the Night of Time". The planet of this path is Saturn, but do not let this mislead you. Actually, this path balances all energies and planets at one time. With that in mind, Saturn becomes a focal point of general meaning and workings. The Thirty-two Paths of Wisdom refer to path thirty-two as administrative intelligence. It is through this administrative intelligence that it directs the overall operation of all of the seven ancient planets. Symbolically, this path connects the Earth with the balanced power of the Microprosopus, represented by the hexagram.

The first letter of the Hebrew alphabet is a. t is the last letter. Between a and t rests the entire Universe. This is referred to in Christian and Greek terms as the Alpha and Omega, or the beginning and the end. The *Sepher Yetzirah* refers to t as the Palace of Holiness, sustaining all things. It is both power and servitude.

The center of the cube of space, as referred to in the *Sepher Yetzirah*, is the letter t, the cross. It connects a, m, and c, the three mother letters. This is the symbolic form of energy from which manifestation was created. The path of the Universe or the World is in fact the secret to all of this, because it falls at a point where a, m, and c all cross. This crossing point is where these primary energies are balanced. The key word for this path is balance. It is the Sanctum Sanctorum of the devotional Mysteries.

One symbol that we apply to both the Fool and Universe cards, a and t, the beginning and the end, is the Swastika. In rtk, it must be realized that its arms spin so rapidly that they merge and are in fact perceived as a unified point, or the primordial point. On the path of the Universe, the Swastika has slowed its spinning, so that each of the arms is perceptible and are seen to be perfectly balanced around a central point. This is the complete expression of the "One" in matter.

Keep in mind that when contemplating the Universe card we are really contemplating the world of matter. The Universe is a total balance and integration. Most of us think of ourselves as body and mind. Yet the Western Mysteries, and the Eastern Mysteries for that matter, have stated since almost the beginning of time that the Cosmos or the Universe is in fact an illusion, or basically all in the mind. With this thought in mind, we realize that the distinction between body and mind is one of perception, not of reality. In fact, in our path working experience, when we close our eyes and see visualization or pictures, what we are actually doing is witnessing the most refined forms of matter.

Behind the exterior of the Universe card, we must also realize that most of the physical world is actually unseen. To experience the path of the Universe is to be taken to the gateway of the Seven Palaces of Assiah. This is represented by the seven-pointed star.

As you enter the Holy of Holies, the Universe, you may experience forces in such a unique way that you are in them but not yet of them. Also, keep in mind that, opposed to other paths, the energies that you will experience in the Universe card, particularly in pathworking, are also in full expression and self-balanced. This perhaps is one reason why the equal-armed cross is considered one of the tools of the path of t.

To successfully travel this path, one must have some self-understanding and balance to begin with. This is very important. This path should not be traveled when one is out of balance, for your lack of balance on a balanced path that opens the doorway to higher realms of consciousness will do nothing but cause serious problems in the personality.

A word of caution, test all symbols with reason and understanding. This is the doorway to the Astral, into higher paths and planes of consciousness. Let us make sure we are not merely entertaining ourselves with extended fantasy. By doing this, we only deceive ourselves, and self-deception hinders our growth. The Universe, because it contains all things, is a path of discrimination. As you work this path, remember to be discriminating in the direction you choose to go on the path and the energies you choose to invoke within your consciousness. It is critically important that beginners on this path establish a sense of balance with the Lesser Banishing Ritual of the Pentagram. Those of us who at one time or another felt that the Archangels were merely fantasies have had our mind changed by invoking them through the L.B.R.P. on the path of t. Their extreme amount of brilliance and power is exemplified through the balance of this particular path.

Most Tarot cards have a wheel or oval-shaped wheel, a woman within the wheel, and the four Kerubim depicted on the Universe or World card. The symbolism behind this is that only through discrimination can we place ourselves in the administrative. Balance is symbolized by the dancing woman draped with a k shaped scarf (the letter attributed to the Wheel of Fortune) and surrounded by the animal symbols of the four elements.

The symbology here is quite Qabalistic in that it represents the four elements united by the fifth element of Spirit. It is the fifth element of Spirit that balances the four elements.

One of the primary principles of this path is to learn the edict, "As above, so below". In hnyb, hnyb of course attributed to the Great Mother and symbolized also by Saturn, we have the exalted supernal realm. We, also have what we call, "The Will to Form" or "The Will to Express". This is later expressed by the Universe card on path

thirty-two as actual expression, or final expression, or fullest expression of the Great Mother. This Great Mother can be represented by the Empress or Isis or Aimah Elohim. She is hnyb; she is Saturn; she is all the principles behind what we perceive as matter; she is the Cosmic Dancer as depicted on the Universe card who administers and balances the four elements. Most of the Tarot decks, as pointed out earlier, agree that the female figure should be surrounded by an oval shape of some sort. In the Golden Dawn Tarot, the oval shape is surrounded by seventy-two little dots or stars. These seventy-two little dots or stars represent the Schemhamporesch, or the seventy-two fold name of God. The oval shape gives reference to the womb. It is through the womb of the human female that we pass from gestation unto birth. It is through the Great Womb that we pass from life into death. It is also through this womb that we pass from the physical plane of tWkl m into the astral plane of Foundation, otherwise known as dWsy.

The woman in the Tarot card of the Universe, as pointed out earlier, is dancing. She is in movement, swirling and revolving, rather than as a more settled form of energy, as depicted in the Empress card where she is placed solidly on the Supernal Throne. This energy, or spiral force of Nature, is directed by the wands which she carries. The wands represent both active and passive energy, each one having two poles. In many cards, one wand is black and the other wand is white.

Some might consider the path of the Universe a dark cave filled with treachery, danger and tunnels. But remember that through this Darkness and through this treachery, we are led to the pathway of light which leads inevitably through dWsy into trapt. Let us also remember that it is through this pathway that we end up in the realm of the Qlippoth. Therefore, our own personal balance is heavily stressed. One must be in the right frame of mind and balanced by the Lesser Banishing Ritual of the Pentagram to begin their higher realm workings.

The Hermetic Order Of The
GOLDEN DAWN^{Intl.}

GEOMANCY

PART ONE

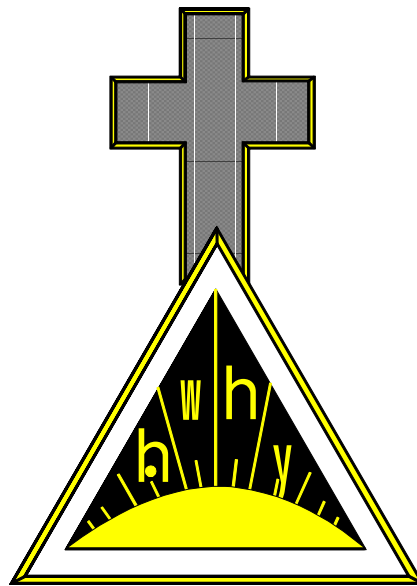

THEORICUS 2=9

Geomancy is probably the oldest form of divination known to man. Some historians believe that geomancy began in ancient China, or some place in the Far East. Others seem to think that it may have originated in Africa or in some areas of the Middle East. It really doesn't matter where geomancy began. The fact of the matter is, however, that it is an extremely accurate way for divining any particular answer.

One of the problems that we often run into is the fact that those who are studying the esoteric traditions and Mysteries often skip over or underestimate the use of geomancy. This is a tragedy simply because geomancy is such a precise form of divination. Overall, geomancy, as far as a divinatory process, far outweighs most other methods.

In the Theoricus grade, we will introduce you to geomancy with this lesson. However, the method of its use will be omitted until the next grade. It is very important that the houses and their meanings be memorized for effective use of the operation. Such a procedure calls for thorough knowledge of what each house signifies. Doing this will establish a clearer view of geomancy and its method, simply because geomancy and the houses are closely related. Furthermore, in this grade you'll need to memorize the rulers of the planets. These rulers will be used in accordance with the actual method of divination. So, all in all, the necessary materials to be familiar with include the memorization of the geomantic figures, their meanings, their attributed zodiacal sign, the element of the figure, and the ruler of the planet. These are the main correspondences that must be committed to memory for an effective geomantic divination.

Geomancy is basically the various groupings of odd and even points that come together in four lines. Of these there can only be obtained sixteen possible combinations. Therefore, we take these combinations of odd and even points and arrange them on four lines, which then relate to the sixteen figures of geomancy. As for the memorization requirements of this grade, you will use the knowledge of the points already stated above.

Two figures are attributed to each of the seven ancient planets. The remaining figures are attributed to Cauda and Caput Draconis, the tail and head of the Dragon respectively. These are otherwise known as the North and South Nodes of the Moon. In addition to each particular planet and sign, certain ruling genii are also attributed. We can equate the genii to each particular sign and planet.

In this lesson we are going to give you the particular geomantic figure as it pertains to falling in a particular house. In the Practicus grade you will learn how to determine which house or sign a geomantic figure would fall under. It is not necessary to memorize all of the explanations that fall under each of the houses, however, it is important that you familiarize yourself with some of the main headings. In any case, the elaborate information is here for any future reference.

Here is the table of the geomantic figures as they pertain to the twelve houses. Under the heading of each figure is stated the general effect of the figure regardless of the house.

ACQUISITO

Generally good for profit or gain.

1. Happiness and success in all things.
2. Very prosperous.
3. Favor and riches.
4. Good fortune and success.
5. Good success.
6. Good, especially if agreeing with the Fifth house.
7. Reasonably good.
8. Rather good, but not very. The sick shall die.
9. Good in all.
10. Good in suits, very prosperous.
11. Good in all.
12. Evil, pain and loss.

AMISSIO

Good for loss of substance and sometimes for love, but very bad for gain.

1. Ill in all but for prisoners.
2. Very ill for money, good for love.
3. Ill end, excepting quarrels.
4. Ill in all.
5. Evil except for agriculture.
6. Rather evil for love.
7. Very good for love, otherwise evil.
8. Excellent in all questions.
9. Evil in all.
10. Evil except for women's favors.
11. Good for love, otherwise bad.
12. Evil in all.

FORTUNA MAJOR

Good for gain in things where a person has hopes to win.

1. Good, save for secrecy.
2. Good, save for sad things.
3. Good.
4. Good in all, but melancholy.
5. Very good in all.
6. Very good, except for debauchery.
7. Good in all.
8. Moderately good.
9. Very good.
10. Exceedingly good, contact superiors.
11. Very good.
12. Good in all.

FORTUNA MINOR

Good in any matter in which a person wishes to proceed quickly.

1. Speed in victory and in love, but choleric.
2. Very good.
3. Good, but wrathful.
4. Haste, rather evil except for peace.
5. Good in all things.
6. Medium in all.
7. Evil, except for war or love.
8. Evil generally.
9. Good, but choleric.
10. Good, except for peace.
11. Good, especially for love.
12. Good, except for alteration, or for suing another.

LAETITIA

Good for joy in the present or yet to come.

1. Good, except in war.
2. Sickly.
3. Ill.
4. Mostly good.
5. Excellently good.

6. Evil generally.
7. Indifferent.
8. Evil.
9. Very good.
10. Good rather in war than in peace.
11. Good in all things.
12. Evil in general.

RUBEUS

Evil in all that is good and good in all that is evil.

1. Destroy the figure if it falls here.
2. Evil in all demands.
3. Evil, except to let blood.
4. Evil, except in war and fire.
5. Evil save for love, and sowing seed.
6. Evil, except for blood letting.
7. Evil, except for war and fire.
8. Evil.
9. Very evil.
10. Dissolute. Love, fire.
11. Evil, except to let blood.
12. Evil in all things.

TRISTITIA

Evil in almost all things.

1. Medium, but good for treasures and fortifying.
2. Medium, but good to fortify.
3. Evil in all.
4. Evil in all.
5. Very evil.
6. Evil, except for debauchery.
7. Good except for inheritance and magic.
8. Evil, but in secrecy good.
9. Evil, except for magic.
10. Evil, except for fortifications.
11. Evil in all.

12. Evil, except for magic and treasure.

PUELLA

Good in all demands, especially relating to women.

1. Good, except in war.
2. Very good.
3. Good.
4. Indifferent.
5. Very good, but notice the aspects.
6. Good, but especially so for debauchery.
7. Good, except for war.
8. Good.
9. Good for music, otherwise medium.
10. Good for peace.
11. Good, and love of ladies.
12. Good for all.

PUER

Evil in most demands, except those relating to war and love.

1. Indifferent. Best in war.
2. Good, but with trouble.
3. Good fortune.
4. Evil, except in war and love.
5. Medium good.
6. Medium.
7. Evil, but in war.
8. Good, but in love.
9. Evil, except for war.
10. Evil, except for love and war. Most other things medium.
11. Medium, good favor.
12. Very good in all.

ALBUS

Good for profit and entering into a place, or undertaking.

1. Good for marriage. Mercurial. Peace.
2. Good in all.
3. Very good.
4. Very good, except in war.
5. Good.
6. Good in all.
7. Good, except for war.
8. Good.
9. A messenger brings letters.
10. Excellent in all.
11. Very good.
12. Excellent, wonderful, good.

CONJUNCTIO

Good with good and evil with evil. Recovery of things lost.

1. Good with good, evil with evil.
2. Commonly good.
3. Good fortune.
4. Good, save for health. See the 8th.
5. Medium.
6. Good for immorality only.
7. Rather good.
8. Evil, death.
9. Medium good.
10. For love, good. For sickness, evil.
11. Good in all.
12. Medium. Bad for prisoners.

CARCER

Generally evil. Delay, binding, bar, restriction.

1. Evil, except to fortify a place.
2. Good in Saturnine questions, else evil.
3. Evil.
4. Good only for melancholy.
5. Receive a letter within three days. Evil.
6. Very evil.
7. Evil.
8. Very evil.
9. Evil in all.
10. Evil, save for hidden treasure.
11. Much anxiety.
12. Rather good.



Injurious to the goodness of other figures generally, but good for journeys and voyages.

1. Evil, except for prison.
2. Indifferent.
3. Very good in all.
4. Good in all, save love.
5. Voyages good.
6. Evil.
7. Rather good, especially for voyages.
8. Evil.
9. Indifferent. Good for journeys.
10. Good.
11. Very good.
12. Excellent.



Good with evil and evil in good. Good for loss and for passing out of an affair.

1. Destroy the figure, makes judgement worthless.
2. Very evil.
3. Evil in all.
4. Good, especially for conclusion of the matter.
5. Very evil.
6. Rather good.

7. Evil, war, and fire.
8. No good, except for magic.
9. Good for science only. Bad for journeys. Robbery.
10. Evil, save for works in fire.
11. Evil, save for favors.
12. Rather good.

CAPUT DRACONIS

Good with good; evil with evil. Gives a good issue for gain.



1. Good in all things.
2. Good.
3. Very good.
4. Good, save in war.
5. Very good.
6. Good for immorality only.
7. Good, especially for peace.
8. Good.
9. Very good.
10. Good in all.
11. Good for the church and ecclesiastical gain.
12. Not very good.

POPULUS

Sometimes good and sometimes bad; good with good, and evil with evil.

1. Good for marriage.
2. Medium good.
3. Rather good than bad.
4. Good in all but love.
5. Good in most things.
6. Good.
7. In war good, else medium.
8. Evil.
9. Look for letters.
10. Good.
11. Good in all.
12. Very evil.

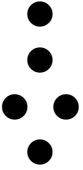
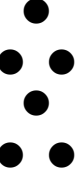
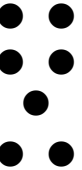
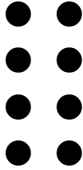
This concludes the basic outline of the geomantic figures as they pertain to the houses. It is essential that you memorize your house attributes, as highlighted in the astrological houses Theoricus lesson. Also, you will notice at the end of this lesson diagrams and all the necessary information that is vital for the knowledge used in the Practicus grade.

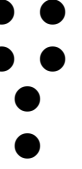
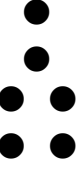
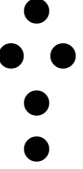
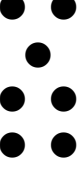
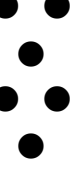
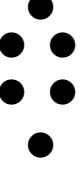
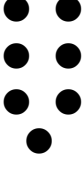
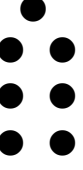
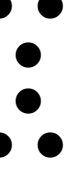
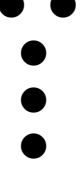
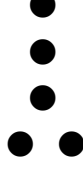
<p>PUER</p> 	<p>AMISSIO</p> 	<p>ALBUS</p> 	<p>POPULUS</p> 
<p>VIA</p> 	<p>FORT. MAJ.</p> 	<p>FORT. MIN.</p> 	<p>PUELLA</p> 
<p>RUBEUS</p> 	<p>ACQUISITO</p> 	<p>CARCER</p> 	<p>TRIST.</p> 
<p>LAETITIA</p> 	<p>CONJUNCTIO</p> 	<p>CAPUT DRAC.</p> 	<p>CAUDA DRAC.</p> 

Geomantic Figures

Name	Meaning	Sign	Element	Ruler	Planet
Puer	Boy, Yellow, beardless, rash & inconsiderate is rather good than bad.	♈	△	Bartzabel	F
Amissio	Loss, comprehended without, that which is taken away, a bad figure.	♏	▽	Kedemel	C
Albus	White, fair, wisdom, sagacity, clear thought, is a good figure.	♊	△	Taphthar-tharath	B
Populus	People, congregation, an indifferent figure.	♎	▽	Chashmodai	Y
Fortuna Major	Greater fortune, greater aid, safeguard entering, success, interior aid and protection, a very good sign.	♍	△	Sorath	A
Conjunctio	Conjunction, assembling, union or coming together, rather good than bad.	♎	▽	Taphthar-tharath	B
Puella	A girl, beautiful, pretty face, pleasant, but not very fortunate.	♏	△	Kedemel	C
Rubeus	Red, reddish, redhead, passion, vice, fiery temper, a bad figure.	♌	▽	Bartzabel	F
Acquisitio	Obtaining, comprehending without success, absorbing, receiving, a good sign.	♈	△	Hismael	K
Carcer	A prison, bound, is good or bad according to the nature of the question.	♎	▽	Zazel	L
Tristitia	Sadness, damned, cross, sorrow, grief, perversion, condemnation, is a bad figure.	♏	△	Zazel	L
Laetitia	Joy, laughing, healthy, bearded, is a good figure.	♈	▽	Hismael	K
Cauda Draconis	The threshold lower, or going out, dragon's tail, exit, lower kingdom, is a bad figure.	Q	△	Zazel & Bartzabel	L F
Caput Draconis	The head, the threshold entering, the upper threshold, dragon's head, entrance, upper kingdom, is a good figure.	P	▽	Hismael & Kedemel	K C
Fortuna Minor	Lesser fortune, lesser aid, safeguard going out, external aid and protection, is not a very good figure.	♍	△	Sorath	A
Via	Way, street, journey, neither good nor bad sign.	♎	▽	Chashmodai	Y

The Hermetic Order Of The
GOLDEN DAWN^{Intl.}

**INTRODUCTION TO THE
TATTWAS**

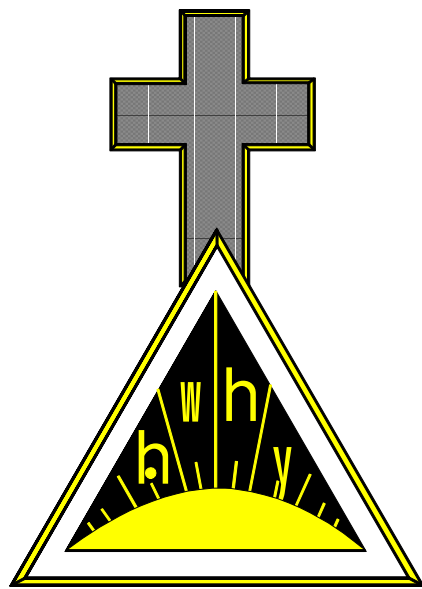

THEORICUS 2=9

Show me an occultist who has mastery over the elements and I'll show you a occultist who can literally change the world with his thoughts. Mastery over the elements and understanding the nature of the elements, especially the elements within one's psyche, is absolutely critical and vital to the student who wants to proceed to Adepthood. You cannot hope to invoke the elements and focus them in a particular direction through the use of will unless you have complete mastery over them.

So in this lesson, we introduce you to the Primal Elements within the psyche of all of us. These are the Tattwas of the Eastern school of magic. In many ways, they are different from so many other symbols that we use in the Hermetic Order of the Golden Dawn in that they are primal and simple. Unlike the Tarot, wherein many versions are complex and full of minute details, the Tattwas are exceedingly simple. In this, however, lies danger. Oftentimes, the Theoricus will say, "This is too simple for me," "I want something more complex," "why am I given this easy of a task?" The reason is really quite elementary once the concept of the Tattwas is understood. The Tattwas allow you to be in touch with the basic, primal and primitive elements that exist on a Microcosmic level and which connect into a Macrocosmic level. Therefore, the student that learns to master and understand more of himself through the use of the Tattwas will also have the ability to master and understand the elements as a whole. This can range to developing powers such as healing, increase prosperity, and yes, even the controlling of the weather, as well as a myriad of other benefits. This can only be achieved by working the Tattwas on a continual basis.

Most weaknesses found in Adepts are those concerning the elements that tend to be imbalanced within them. Oftentimes, as people move through the grades, eventually reaching Adeptus Minor, they tend to spend more time with the Enochian system, advanced Qabalah, Egyptian rites, and Goetic work. This is not to say that spiritual time is not being pursued. At this point, most of today's Adepts have forgotten the use of the Tattwas. The Tattwas must become our basic foundation for increased awareness and balance within ourselves and of the elements. It is only this system of balancing that allows progression on the Qabalistic Tree of Life. Balance, and the ability to balance the elements, is absolutely crucial. If you remember in the study of pathworking it is said that only the path of t is self-balanced. The other paths must be balanced by the practitioner who is working them. So consequently, you must have the skills and ability to balance those paths immediately and effectively, otherwise you may be thrown into endless day-dreaming and mind trickery that will accomplish nothing.

The five basic Tattwa symbols are a combination of the four magical elements intermingled with the fifth element of Spirit. The first is Prithivi; it is a yellow square that represents the Primal Element of Earth. (If you are confused as to the color symbology of the Tattwas, just keep in mind that they are derived from the Eastern school of magic). The Second is Apas; it is a silver crescent moon, representing the Primal Element of Water. The third is Vayu; a blue circle representing the Primal Element of Air. The fourth is Tejas; a red triangle that represents the Primal Element of Fire. Lastly, we have Akasha; a black ovoid that represents the Primal Element of Spirit.

So all together, we have the five elements composed of the four magical elements adjoined with the fifth element of Spirit. In addition to these, each element can be subdivided into a total of twenty-five sub-elements. For example, Vayu Prithivi would be the Air aspect of Earth. This would be portrayed as a small blue circle on a

large yellow square. For the Theoricus grade, it is only required to make a set of the first five, which are the one's stated above. However, if you wish to construct the sub-elements, that is fine, so long as the magical work be consistent and regulated.

One of the advantages of building the sub-elemental cards is that it aides, particularly in the area of magical workings, in understanding the various aspects of one elemental association with another. It also allows one to be more precise with one's working, especially in the area of directing one's ritual work involving invoking a combination of various elements. At this point, you should have already committed to memory the basic attributes of the various elements.

Tips For Building Tattwas Cards

Your Tattwa symbols should be about 2"-2 1/2" in height. This is not the size of the card itself. A good 5x7 card is recommended or a large size filing card that is pure white and blank. We recommend that colored paper be used for the actual creation of the symbol rather than water colors. This is because the color of the symbol should have a brilliance and a deep tone to it. Lacquer paints or testor paints are also acceptable. However, it would be best that two coats be used for a deeper effect. If you are going to use paints, it is recommended that the the symbol be traced using the suggested measurements. Then paint it and be sure to place a second coat on top of that when it has dried. At this point, you should be able to obtain a rich, deep color. The next step is to take the symbol, cut it out, and then paste the symbol onto another blank white card. The reason behind not suggesting to paint directly onto only one card is that using one card will give only a one dimensional look to it. While on the other hand, by using the paint and paste method, you receive a two dimensional perspective. The next step is to place several coats of a good lacquer or varathane on both sides of the card. There are a large number of brands of liquid plastics available on the market. A good glossy finish will help protect the card for a vivid and bright look as well as ensuring years of use. If you are going to use the colored paper method as taught originally by the Order, then we would suggest that after the colored symbol has been cut out, directly transport it onto the blank white card, following the last step of adding a final coat of varathane.

Working The Tattwas

The things that you will need in order to begin your Tattwa vision and workings are as follows.

1. The selected Tattwa card. Our recommendation is that you start off with Prithivi as this is the most dense of the five. A side note: the student should work on this card a minimum of five times before moving to the other cards.
2. Blank white screen, wall, or some sort of background.

3. A notebook or your magical diary to record the experiences.
4. A room that you may use without any outside disturbances for a certain amount of time.
5. Any item that will give you comfort during your working, such as a pillow or a soft cushion. It is advisable that the latter should not be too accommodating for it may cause one to fall asleep and therefore lose the entire magical time to slumber.

Begin by clearing your space with the L.B.R.P. and the B.R.H.. You then face the direction of the elemental quarter that you are working. Take the card and place it upon the screen or wall, usually at the height of eye level. If you don't have a white wall available, you may choose to go out and buy a large piece of artist construction paper or maybe even perhaps going to a butcher shop where you can obtain a sheet of the paper that they use for wrapping meat. The reason for the use of the white paper is so that no distractions may interfere with your mind when concentrating upon the symbol of the element. You may also want to remove any hanging pictures or any furniture that is too close to the working area. Another useful tip is to place your card on the ceiling and lay on the floor. This is a very good method although not the easiest for some since many people don't have the option of using a white, smooth ceiling. You may sit or lie down during the operation, although lying down may cause drowsiness. Face the symbol, relaxed and alert, gaze upon it for approximately twenty seconds to one minute or as long as you can, but do not gaze to the point of strain. Do not allow your attention to wander. This is also an excellent time for using the Four Fold Breath while gazing at the symbol. The next step is to smoothly switch your gaze onto the plain white surface behind the symbol before continuing any further. You may at this point wish to remove the Tattwa card from the white background. You will notice the transference of the symbol into a complimentary color of the Tattwa that has just been removed. If you were using Tejas, the complimentary color you will see is apple green, etc..

We recommend that the student practice the exercise a minimum three to four times until a strong development of transferring the Tattwa card visually onto the white background is obtained. Upon achieving success with the method thus far, let the student continue, holding the complimentary image of the Tattwa firmly in his mind, or visually upon the white background. After doing this, if you have visualized the image with your eyes opened, you may close them and visualize the image becoming enlarged to the size of a door. Visualize yourself now and portray all the details of yourself and the doorway. Pass on through the door leaving your body laying, seated or standing behind. Most Adepts have preferences of working Tattwas while standing up, which isn't simple. Using the Sign of the Enterer, also a symbol of one groping for the Light, you enter that realm of existence and seal yourself there for a period of time using the Sign of Horus or the Sign of Silence. You may then want to look around the plane, noting in detail all of the scenes being observed. You may notice that things appear unanimated. The easiest and best way to animate things and to bring them to a

vivid color and movement is in the use of the appropriate Divine names and angelic names for each primary element.

Element	God Name	Archangel	Angel
Earth	Adonai Ha Aretz	Auriel	Phorlakh
Air	Shaddai El Chai	Raphael	Chassan
Fire	YHVH Tzabaoth	Michael	Aral
Water	Elohim Tzabaoth	Gabriel	Taliahad
Spirit	Eheieh	Metatron	Chaioth ha-Qadesh

In addition, it is also helpful to vibrate the elemental name, or what is also called the Cardinal point, in Hebrew.

Element	Cardinal Point
Earth	Tzaphon
Air	Mizrach
Fire	Darom
Water	Maarab

Upon entering the actual Tattwa plane and vibrating the appropriate Divine name and Angelic names, you may notice a guide appearing in your experience. It is recommended and advisable that you not venture far away from the doorway without the help of a guide for Tattwa work. Upon meeting the guide, he should be tested by every means disposable to the student. As in the case of using the pentagram, it may not be appropriate when working Prithivi. Some tools that may be included for testing are the Banner of the West or the vibration of the Divine names (which prove to be quickest and the most effective). Be sure not to omit asking the entity its purpose in its assisting you. Let it be emphasized that the Banishing Earth Pentagram is acceptable, except while working Prithivi. Using it may cause the banishing of positive earth elements. Moreover, positive spirits can be banished using the banishing pentagram for each particular element. So make sure you are familiar with the banishing elemental pentagrams.

Assuming now that you have a positive spirit that is willing to help you and act as a guide, the next step is to give the grade sign for the particular element. So in working Earth, you would give the Grade Sign of the Zelator. For working Air, you give the Theoricus Grade Sign, etc.. However, there may be a problem. This lesson is only applicable to the Theoricus grade. So for those of you who may become proficient at

the Tattwas, you would not have access to the powers of the higher grade signs. As a general rule, you can always give the Neophyte Grade Sign including the Sign of Silence. Even the Adepts of the Order prefer to use the Sign of the Neophyte most of the time when working with spirits on another plane. The spirit or helper should be expected to return the same grade sign to you. This is very important to assure yourself that the requirements of your test have been met. Should a spirit neglect to return a similar grade sign, then chances are that you are confronting a spirit that isn't appropriate for your working. Thus, the only action necessary at that point is to banish the entity using the corresponding elemental pentagram.

In working the sub-elements such as Fire of Earth, it is possible that you will be working with more than one guide, being transferred from one element to the next. At no time should you allow a lapse in your testing of any entities. Be specific, direct, and efficient. The Divine names should be employed at all times, as they will almost always bring harmony and organization to a plane of existence which for one reason or another has become chaotic with your presence. If you are working a secondary Tattwa such as Fire of Earth, when you enter initially you will be first entering the element of Earth and then the sub-plane of Fire. Again, upon entering that sub-plane, the Divine names should be vibrated. For most of you in the Theoricus grade, you will not be working the sub-planes for any particular length of time to come, but it is important that you know this information. It's important also to know exactly where your point of existence is located. In working a sub-plane, obviously something dressed in bright colors with very hot jewels and very bright piercing eyes is probably not of the element of Earth. It may be most likely attributed to the element of Fire. Thus you will want to vibrate the appropriate Divine names.

Most of the time our guides on these elemental planes will be elementals, but they should still be treated with the utmost respect and courtesy according to their rank. However, never allow them to get out of will. Elements are very pure and simple beings, but they must be treated with firmness, precise decision, and respect. Often times, they can be mischievous and irresponsible, even though they are not of a malicious nature. Another suggestion is to always project yourself as larger or taller than the being who is confronting you. In all cases, always maintain composure and self-control.

At first, you may only want to glance at the scenery, but later, through continued practice, you will be able to help people by the use of elemental work on the Tattwa plane by working closely with the elemental beings of that plane.

The method of leaving the Tattwa plane and returning to normal consciousness is the precise reversal of the initial process. The first thing to do is thank the guide (if you have one, but in most cases you will) and bid him farewell. Then you will retrace your footsteps back to your symbolic door which will appear again in the opposite color of the Tattwa card you were using. There should never be a sudden departure from the plane of existence. This includes opening your eyes and feeling that everything is normal. This is misleading and it will result in causing havoc in your daily life. This will not only occur within the next few days, but in weeks and years to come. So after finding the elemental door, you will pass through, again using the Sign of the Enterer followed by the Sign of Horus (using the left finger, not the right to press against the

lips). Remember that the Sign of the Enterer is always answered by the Sign of Silence.

Upon completing your journey, slowly open your eyes and perform the L.B.R.P., followed by the B.R.H.. As an added precaution, it is always good upon completing the B.R.H. to give the final release. Simply hold the right hand up facing east or the direction of the element that was worked and say, "I now release any spirits that may have been imprisoned by this ceremony and working, return to thy own abodes and habitations with the blessings of the Divine One. I now declare this working and rite duly ended."

It is wise to do Tattwa working no more than three times weekly when first starting out. Only after practicing over an extended period of time will the inner clairvoyance develop in the student. Only with perseverance will the visions grow from vague, slightly indistinguishable pictures, to a vivid, powerful, magical experience.

However, even when these experiences begin to become vivid and powerful, you should always maintain your testing of all things on these planes. For remember, the astral plane seeks to deceive. In addition, with considerable practice, the actual Tattwa cards will be discarded. The seer will become so proficient in using the Tattwa cards and performing the visions that the actual card will not be necessary. You will merely visualize the card, project it onto its alternate color, and then project into it.

It is wise not to work Akasha until one has achieved the Portal grade and higher. Work the elementals, and even the sub-elements, if you choose to make them, on a regular basis prior to working the element of Spirit. As a safeguard, there are some other Divine names and Angelic names that are used for Akasha that are not put in this lesson that are required for satisfactory working for that particular element.

The Theoricus grade is not requiring that you become a master at Tattwa working, but you should have begun to practice its work on a regular basis. This is hard, strenuous work, so don't kid yourself, because it isn't easy. In some cases it takes months and sometimes years to become proficient. But with persistence, all of the above benefits are possible and can be achieved.

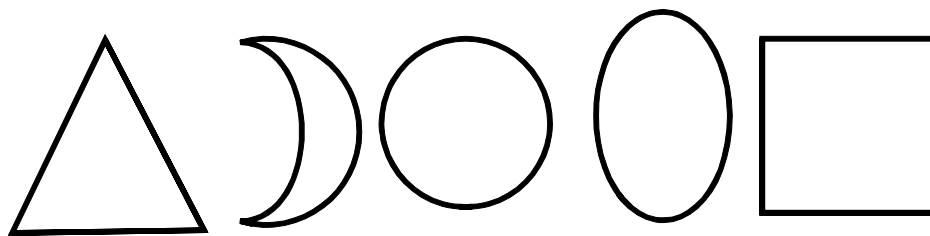

The Hermetic Order Of The
GOLDEN DAWN^{Intl.}

THE AIR DAGGER

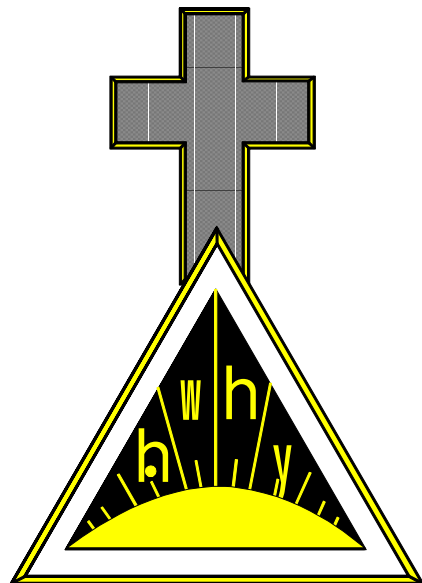

THEORICUS 2=9

The Air Dagger is the tool or symbol that represents the element of Air. This is the tool of the Theoricus and it is the representation of his power. There have been many contradictions about the tool that ought to be used to represent this element. The traditional Golden Dawn elemental tool for Air is the dagger. Perhaps a little background on its history might be helpful.

It was popular in the early years of paganism for the practitioners to ascribe the magical wand to the element of Air. Others, in their own magical experience, ascribed the sword to air. So the question to ask is, "Why is it significant that the dagger be used to symbolize the element of Air?" Well, the best way to answer this would be to recognize a well known author by the name of Gerald B. Gardner. He is one of several people responsible for reviving witchcraft, or at least a reconstruction of it. In his methods and theories, he was able to simplify some seemingly complex magical techniques and philosophies (some were even borrowed by Aleister Crowley). Teaming up with another knowledgeable person, Doreen Valiente, he was able to create the book entitled *Modern Witchcraft*. One of his works dealt with equating the dagger with the sword. This should be obvious, for the sword would appear to be nothing more than a large dagger. It was believed that the sword would be a suitable tool to represent Air because a sword is swung in the air. The dagger was used as a later version of this concept. This is so because a dagger was very similar to the tip of a spear which would hurl through the air when thrown. If you recall, in the Lesser Banishing Ritual of the Pentagram, the Archangel Michael holds a sword and he among all the Archangels is ascribed to Fire. According to ancient Greek tradition, it is stated, "The sword is a gift from the gods." You can say that the gods are Spirit and Spirit broken down by definition means "breath" or "Air." These are only theories of how the dagger came about. Even though we can't say these are the most accurate answers concerning the tool of Air, they are a basis for your understanding.

The Air Dagger is perhaps one of the easiest tools to create. Merely purchase a dagger and paint it. The traditional Air Dagger is a simple double-edged blade with a "T" shaped handle as shown below.

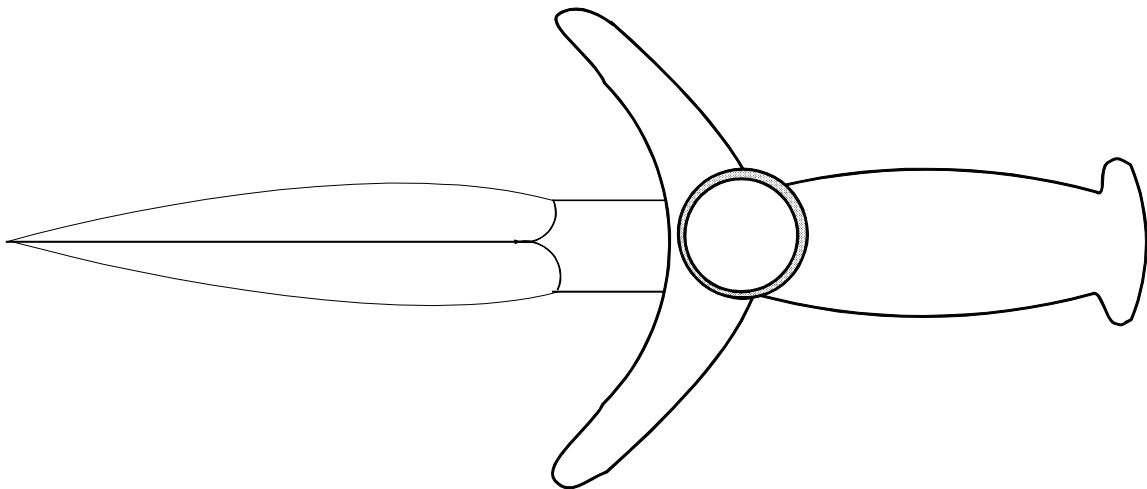

The Air Dagger should be fairly new and should have never been used previously to cut living things, not even meat. As an Adept, this tool is used in all magical workings of Air, such as Qabalistic workings to Enochian magical rituals. Let there be no confusion between the Air Dagger and the L.B.R.P. dagger or sword. The L.B.R.P. dagger or sword is under the auspices of hr̄wbg and it symbolizes strength and defense. The Air Dagger represents Air, ׀ of YHVH, and the Archangel Raphael. There are no specific requirements to the type of dagger you purchase. It may be made of wood, steel, pewter, or anything else. Just keep in mind that the Air Dagger is your tool. It should have the appearance you feel is best suited to your liking and it should be durable for years of use.

There are a variety of cutlery shops that supply double edged "T" handled daggers. Occult supply houses also have no problem furnishing a person with this kind of dagger at the right price. On the other hand, if you do have any problems finding a double edged "T" handled dagger, there is a solution, but it will take a little more effort. It isn't so much the double edged blade that is a problem as compared to finding one that has a "T" shape large enough to look traditional. One suggestion that would be useful is to use modeling clay. Simply purchase a fairly small amount of clay that doesn't chip or crack at a hardware store and get to work. On the traditional dagger, the part of the dagger that goes horizontal, crossing the blade, is slightly curving toward the point. It isn't exactly perpendicular to the blade. Using clay, you'll be able to mold and shape the desired figure. After the clay has dried, sand the handle until all lumps and rough edges are smooth.

If the handle of the dagger is wooden, be sure that it has been sanded smooth prior to painting. Cover it with a couple of coats of wood sealer. Make sure that the wood sealer has completely dried before painting for a smoother, solid appearance in the color. If a metal dagger is used, be sure to heed the instructions of the paint regarding painting over metals.

In painting the dagger, the handle is painted yellow, whereas the sigils painted upon it are purple. Both of these colors should be brilliant and long lasting. If no other paint is available to you other than water colors, then they, too, may be used so long as several coats of varathane are sprayed on top of it as a finishing touch, to prevent peeling. The sigils that are placed on the handle of the dagger are the names of the energies in Hebrew that rule over and are associated with the element of Air.

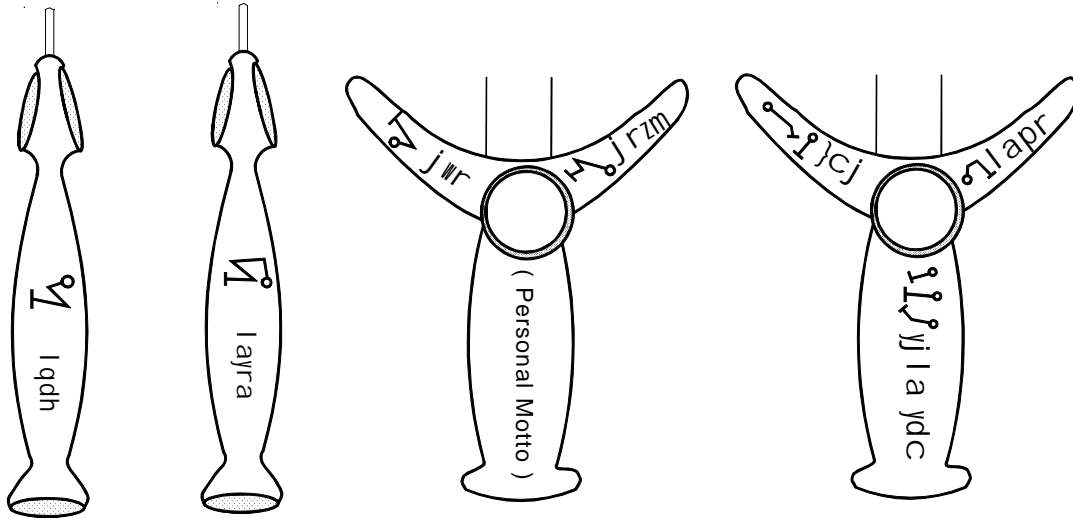

Divine Name:	yj I a ydc	Shaddai El Chai or YHVH
Archangel:	I apr	Raphael
Angel:	ץcj	Chassan
Ruler:	I ayra	Ariel
River of Paradise:	I qdh	Hiddikel
Cardinal Point	j rzm	Mizrach (East)
Element:	j wr	Ruach (Air)
Motto		Your chosen phrase or word

Note: The Divine name attributed to the Air Dagger can be either YHVH or Shaddai El Chai for the sephira of disy, the Realm of Air.

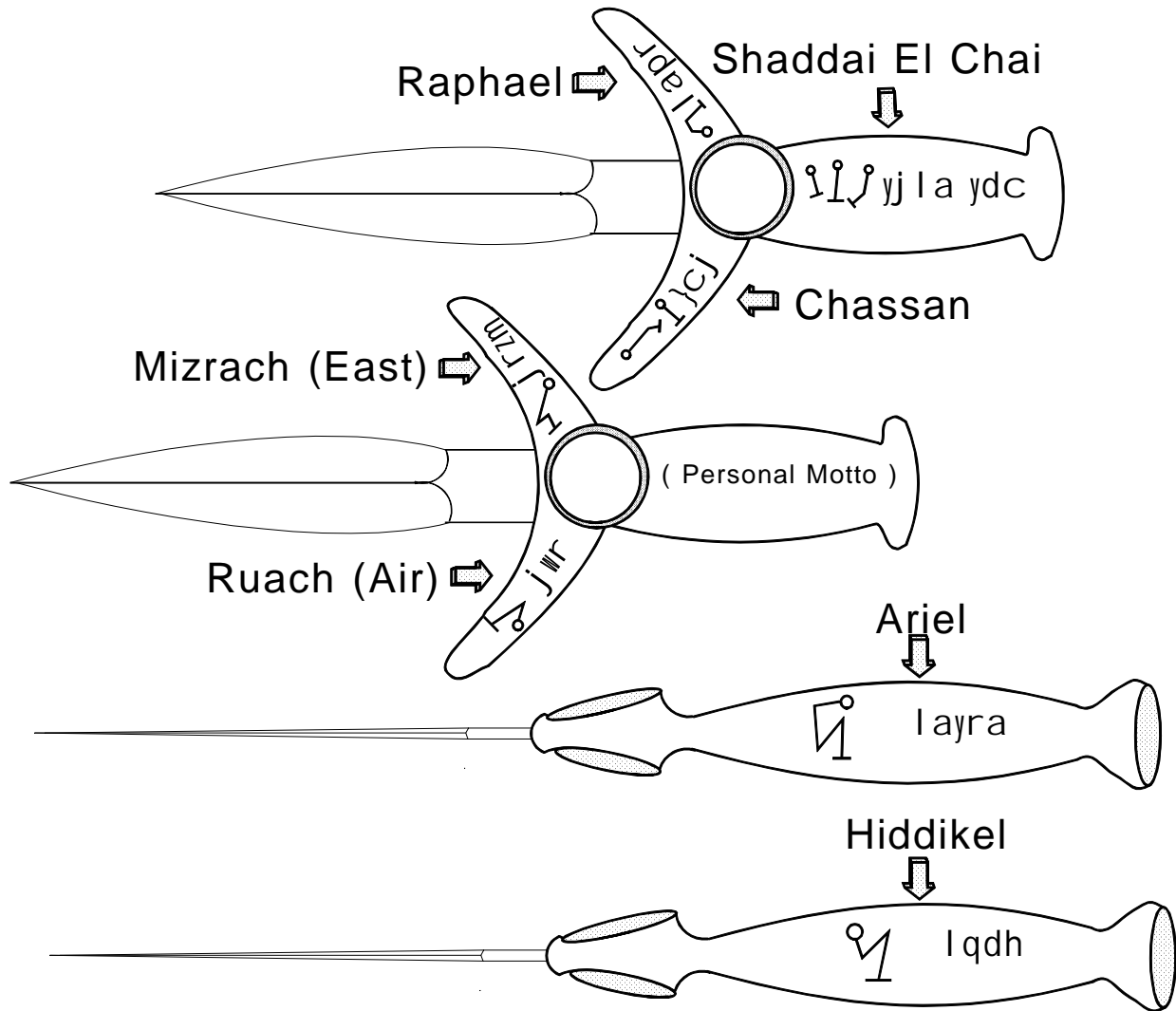

All of the sigils should be painted in the best brilliance of purple. The motto is a short phrase or abbreviation that represents your goal or power. You should have the same motto on all your tools. You should have previously chosen a motto to place on your Earth Pantacle. This same motto can be painted on your Air Dagger. If the motto is still uncertain, an inspiration can probably be obtained from these examples: "May my light shine", "LVX", "770", or "To be one with Light." You can even use your own power name for a motto, for even your own power or magical name shows some significance in achieving a specific goal in your quest toward Divine Light. When all the paint has dried, place a couple of coats of varathane for a clean and long lasting finish.

Although the Order has the student constructing one tool per grade, it would be best not to place only two tools on your altar (referring to the Earth Pantacle as well). What is meant by this is that either all of the tools of the four elements are present or none of them. Having any of the elemental tools absent would cause an imbalance of a particular element within your magical working area. Wrap the tool in a white silk cloth or its own color and store it away where no one may touch or find it. A minimum

of use will be required for these elemental tools until the Portal grade to Adeptus Minor. The tools may also be used when communing with the Archangel of the grade, in this case Raphael.

Please do not take making these tools lightly, thinking that it will be a long while until you can use them properly. Make it a habit to use each tool as a representation of the grade you are at, as well as a symbol that represents your power to wield that particular element and control it. So, if you have built yourself an altar and have used alternate tools in place of the standard ones, you may now place the Air Dagger and the Earth Pantacle with those tools that represent the elements of Water and Fire. Just keep in mind that it is necessary to have an object representing each of the elements on the altar or none at all. A balance must be maintained at all times.

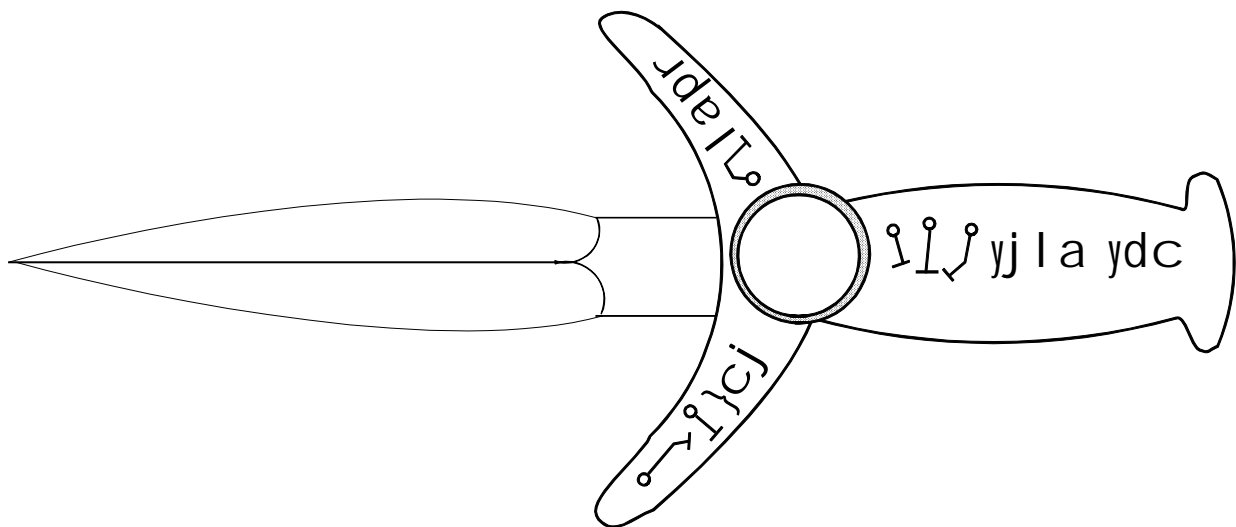

The Hermetic Order Of The
GOLDEN DAWN Intl.

**LESSER INVOKING RITUAL
OF THE PENTAGRAM**

**MEDITATION WITH
RAPHAEL**

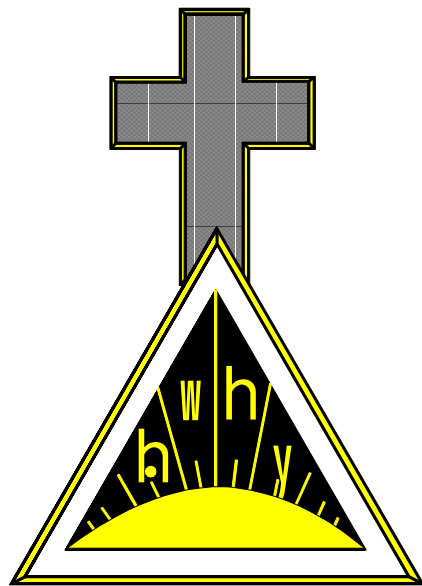

THEORICUS 2=9

In the grade of 2=9 Theoricus, the student centers his attention on the element of Air. As we all know, Air relates to the mind and the process of fluidity of thought. By using the L.I.R.P. and communing with the Archangel Raphael, you may turn to him and ask him to help you clear your mind of unclear thinking or even perhaps bad or ill feelings and thoughts that you may have toward a particular situation. Moreover, he is there to help you solve a problem that you may be having trouble with or having difficulty figuring out. Raphael can send forth a simple solution through the rushing Air, while at the same time helping you become more attuned to the element of Air.

When performing the L.I.R.P., you are invoking as opposed to banishing as in the L.B.R.P. Therefore, the pentagram drawn will be the Invoking Air Pentagram.

Another difference will be that the Archangels will be facing toward you, instead of away from you.

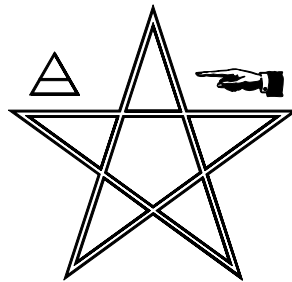

Step 1

Perform the Relaxation Ritual. A ritual cleansing bath is recommended, however, it is optional.

Step 2

Perform the L.B.R.P.. (Optional.)

Step 3

Perform the L.I.R.P.. Follow the same steps as the L.B.R.P., except substitute the Invoking Air Pentagram for the Banishing Earth Pentagram, and use the same Divine names. When invoking the Archangels, remember to visualize them facing you and feel their energies pouring intensely into you, feeling every part of your body completely. Most importantly, remember to, "Enflame thyself in prayer."

Meditation with Raphael

Step 1

After you have performed the L.I.R.P., turn toward each direction, beginning in the south, and bow to each of the Archangels, first to Michael, then Gabriel, then Auriel, and ending with Raphael.

Step 2

Stand facing east with your eyes closed and visualize a purple triangle on a yellow background. Now vibrate the Divine name Shaddai El Chai. No sooner will you say this and the great Archangel Raphael will appear before you. As you see him approaching you, give him the Theoricus grade sign. He will respond by returning the sign to you.

Step 3

As you are seeing him with your astral vision, try and see every little detail. His beautifully colored robes, tools that he may be carrying, and the background that he may be approaching from. See him with your mind's eye, but most importantly, know with all your heart and feelings that you are in his presence.

Step 4

When the visualization is as vivid as possible, let yourself go. Let go of your ego and your thoughts of whether or not you are doing it correctly, simply feel, open yourself up to him. While in this state, be aware of any thoughts or feelings that may come to you, absorb any message that he may be communicating to you.

Step 5

Once you are ready to end the operation, be sure to thank Raphael for answering your questions. Be sure to end the communion by giving him the Theoricus Grade Sign. He will respond accordingly.

Step 6

Finish the ritual with the Qabalistic Cross.

Step 7

Be sure to perform the L.B.R.P..

The Hermetic Order Of The
GOLDEN DAWN^{Intl.}

THE MOON BREATH

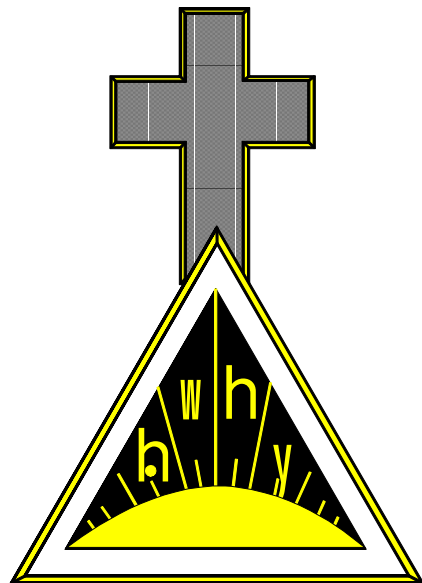

THEORICUS 2=9

In order to have any knowledge of the Moon Breath, its benefits and performance and practice, we must have a little knowledge of the Eastern school. The Eastern mystical school purports that there are ten principle nerves. These are tubes in the body. These ten nerves, or tubes as they are called, are responsible for the life force or the soul which is called Swara, the great controller of all who creates, preserves, and destroys and causes whatsoever in the world. Eastern tradition has it that there is no knowledge more precious than the knowledge of the Swara. In the Eastern tradition it is said that the Swara can destroy enemies and create power, wealth, and pleasures. All of these and more can be commanded by Swara.

The Swara also exists in the body. In the Eastern school there are ten manifestations of Swara in the body. As stated, there are ten principle nerves or tubes in the body and it is through these that the Swara moves throughout the body. The ten manifestations of the Swara are called Vayus. Basically, what we are saying at this point in the Eastern system is that these ten forces will perform ten different functions in your physical body. For the student of the Qabalah, the Swara can be likened to the Ruach or the Ruach Elohim, Prana, or Kundalini. The Moon Breath deals with one of these ten nerve centers. It is called Ida, which deals with the left bronchus. The Moon Breath deals with the energy and the Vayus in regards to Ida. Keep in mind that these ten Vayus, or forces as we will call them, have their part in the ten principle nerves, not one in each. That is very important. Through the ten principle nerves the ten Vayus have a role to play, not one in each separate nerve.

These Vayus are the regulators of the physical body. They affect the astral and etheric body as well. If they are working in perfect harmony and function, then we can say the human being will be in perfect health. However, if they are not, then disease will spring up and we will have ill health.

The key to understanding and making perfect integration possible of all these nerves lies in the working of Prana Vayu, or the vital principle of drawing the air through the Ida. Remember, Ida is the left bronchus. The Pingala is the right bronchus and the Sushumna is the middle bronchus or a combination of both. When air is drawn through the Ida, it is felt physically and visualized mentally as coming in the left nostril and also going out the left nostril.

The Ida is also referred to as the Chandia Nadi or Moon nerve. The Pingala is referred to as the Sun nerve.

When breathing through the Ida, the left nostril, the Moon nerve will give coolness and calmness to the body. When breathing through the Pingala, the Sun nerve, it will give heat to the body. The Ancients believed that the place of the Moon was in the Ida.

Let us keep in mind what happens when molecules are cooled. When molecules are cooled, they slow their movement and they become more and more still. When the human body is cooled, the heart rate drops significantly. The breathing and respiration slow down. The adrenal glands slow down. The brain becomes more calm and still. These are all positive effects of the Moon breath. In other words, the Moon Breath will aid the Theoricus of The Hermetic Order of the Golden Dawn in learning to focus his mind and calm his physical body and the sensations thereof and thus allow him to reach deeper states of consciousness and relaxation that will be important and vital in

future workings, particularly in astral projection and the workings of skrying and traveling in the Spirit Vision, and of course in Adeptus Minor workings later.

It is very important to practice the Moon Breath on a regular basis. Do not practice this breath sporadically, for by practicing it sporadically you will obtain little or no benefit. It must be practiced on a daily basis. One does not need to wipe out one's entire afternoon in the practice of the Moon Breath, but one does need to allocate at least three to five minutes a day in the beginning to get some kind of salutary effect from the practice of the Moon Breath. Therefore, it should be included along with other daily rituals. Preferably the Moon Breath should be performed before other rituals except for the L.B.R.P.. This will make your additional ritual and practice work much more effective than without the use of the Moon Breath. As the Theoricus of the Hermetic Order of The Golden Dawn practices the Moon Breath and builds up the required state, he should keep notes in his ritual diary as to the state he is achieving. Also, he should increase his time from three to five minutes a day to seven to ten minutes a day, and then from seven to ten minutes to twenty. Again, this should be done on a regular basis and should be done sitting up and with a good posture.

The Theoricus should practice the Moon Breath while saying mentally the word Aum. Remember, the Moon Breath is through the left nostril only. The Theoricus should then meditate while mentally saying the word Aum and doing the Moon Breath during the waxing and waning crescents, while visualizing a full moon upon an indigo background. So your eyes should be completely shut while visualizing the silver crescent waxing and waning with your breath as you visualize it and mentally say the word Aum. After several minutes of this particular exercise the Theoricus should call before him the signs of the Air Triplicity: Gemini, Libra, Aquarius. After some moments of meditating on the Air Triplicities, he may also wish to meditate on the pentagram, the pentangle, or the hexagram. With continual practice of the Moon Breath and visualization of the airy triplicities, as well as the waxing and waning moon, you will begin to feel very light, very cool, and very still. Let the Theoricus then rise in imagination above the physical world, the world of mineral, into the world of trees, into the world of flowers, into the world of Air, and identify himself with universal and unconditional love for all creation. You should try to achieve sympathy with the elements behind these. Here the Theoricus will begin to unfold and realize the mental world, where mind now rules over matter. Let him have his mind perfectly clean and clear, allowing no thoughts other than the word Aum and the visualization to be in his mind. Through continual practice, the Theoricus will begin to learn to identify with appearance and reality, rather than prejudice and perceptions.

In order for grade advancement, the Theoricus must not only demonstrate knowledge of the Moon Breath and how it is performed, but must achieve the sublime and subtle state required and necessary for advanced workings. This can only be accomplished by continual practice and daily ritual work of the Moon Breath.

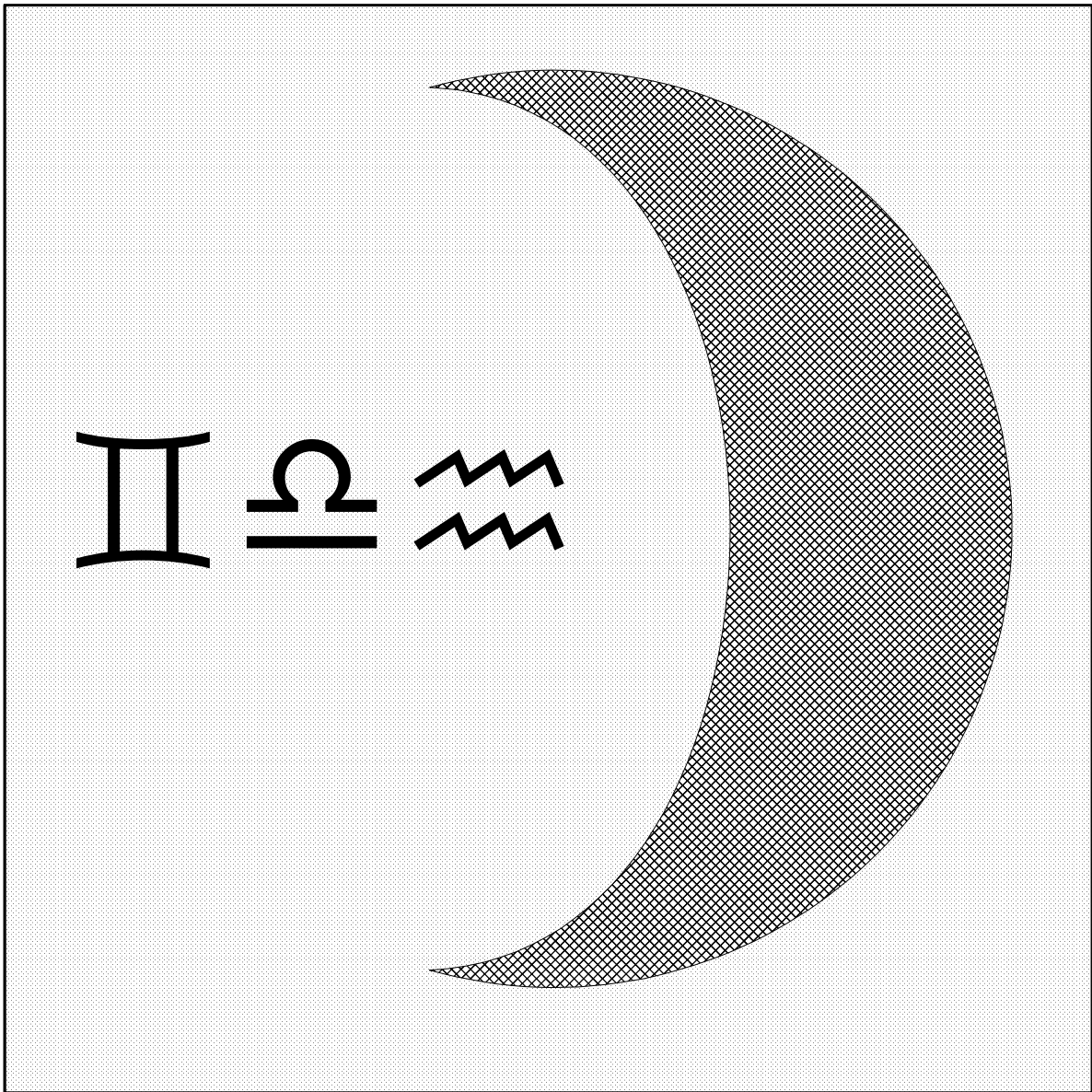
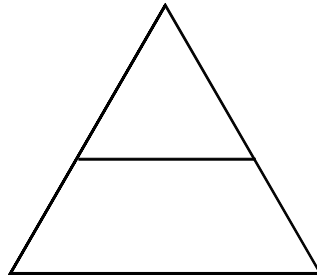

The Hermetic Order Of The
GOLDEN DAWN^{Intl.}

AROUERIS GOD FORM

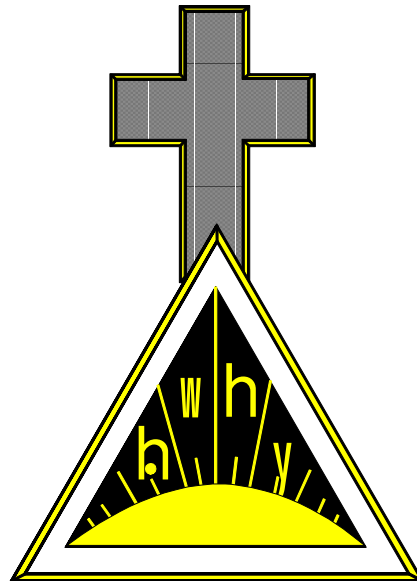

THEORICUS 2=9

If you have forgotten how to create your god form, re-read the lesson in the 1=10 grade book of Zelator. These god forms are designed to put you in touch with various energies and to help you understand the energies that take place in the Temple, especially in the 0=0 Initiation.

In the higher grades of 5=6 and above, much advanced work is given to astral working in god forms and creating advanced god forms for various magical application.

Again, like the other god forms, you should color in Aroueris in the following description. Aroueris is created by the past Hierophant as it is called "Horus the Elder." It is Osiris in motion or the Hierophant when leaving the throne or Dais.

Description

Looks like pure flame. Wears the double crown of Egypt. The cone shaped crown in bright red inside the white crown of the north. A bright purple plume comes out the front.

Nemyss is purple with gold bands and edges. Face and body are translucent scarlet. Eyes are green. Wears a purple beard of authority.

Yellow tunic with waist cloth of yellow striped with purple from which hangs a lion's tail.

White linen kilt showing like an apron under colored waist cloth. Armlets and anklets are vivid gold. He carries in his right hand a blue Ankh and in the left hand, a blue phoenix wand.

Stands on pavement of purple and gold.

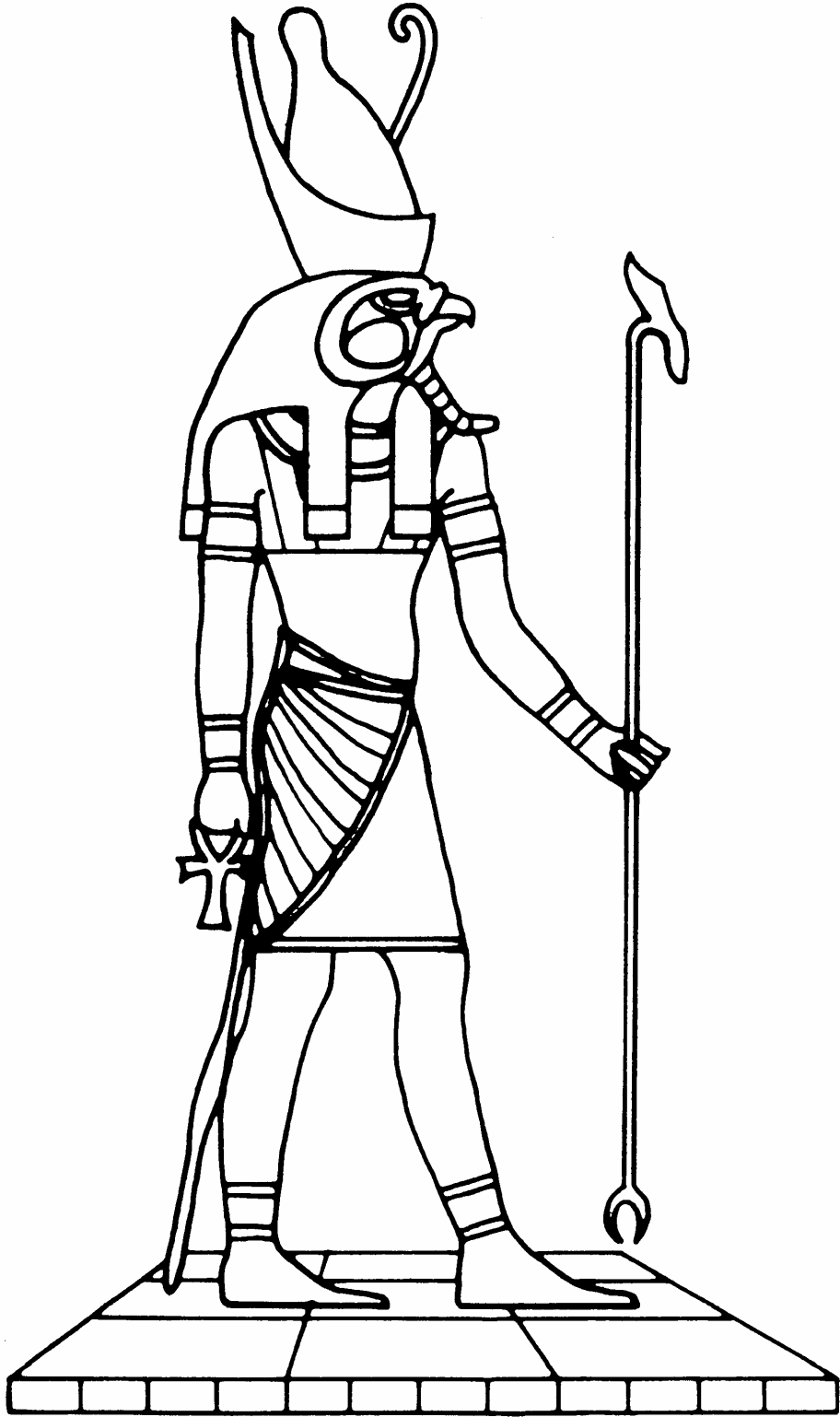

Aroueris

The Hermetic Order Of The
GOLDEN DAWN^{Intl.}

ESTABLISHING A TEMPLE
IN dwsy

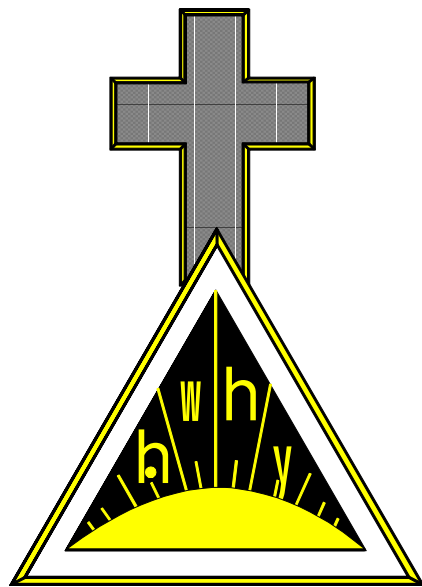

THEORICUS 2=9

דַּוְּסָי literally means foundation. It deals with the astral light. It is the store-house of images. It is the cyclic energies underlying matter. We have the beams of energy of דַּסְי and הַרְוֵבֵג both meeting in דַּוְּסָי. Of course, the Queen scale of color for דַּסְי is blue and for הַרְוֵבֵג it is scarlet. Thus, we have a deep violet purple or puce in דַּוְּסָי. Also, the sphere of operation is that of Levanah, the Lunar beam. With the Lunar beam comes flux and reflux, change, increase and decrease. In דַּוְּסָי, the Divine name is Shaddai El Chai, the Archangel is Gabriel, the Prince of Change and Alterations, and the Choir of Angels is the Ashim, the Fiery Ones. This relates to the fact that we find דַּוְּסָי to be the area related to the Nephesh and the Ruach Elohim.

We find very specialized energies in דַּוְּסָי, directly underlying the material world. These energies can be manipulated in various forms and in many ways, through meditation and other practices in what we call magic. As the Emerald Tablets states, "The things that are above are a reflection of the things that are below." So, as we create in the astral of דַּוְּסָי we manifest in the physical of תְּוֹכְלָמ.

We refer to these currents of energy as astral light or Akashic fluid. Because דַּוְּסָי is so close to the physical presence of תְּוֹכְלָמ, all of us on this Earth from time to time feel the presence of astral light, though many of us dismiss it. This astral light may be felt as an overall tingling sensation, or as a pervasive warmth that seems to cover the entire body. Many times this results from heavy, prolonged prayer, or even from sexual stimulation. Mystics, of course, know that this feeling or this astral light can be intensified and actually moved to various parts of the body at will.

This force oftentimes as stated is very sexual. If we look at where דַּוְּסָי fits on the physical body, it fits over the reproductive organs of the body. Mystics have often said, in general terms, that God is sex. The records of the static union with God by various mystics at different times in history point to this revelation. When this astral light of דַּוְּסָי, the sexual forces, are directly and consciously circulated throughout the body as in the Qabalistic ritual of the Middle Pillar, we find that the effects can many times be dizzying and overwhelming. It is not uncommon for beginners to literally pass out from this energy.

Each of us has an astral body, or etheric body, which leaves the physical body generally during sleep or long unconscious periods. This can consciously be projected very specifically and at will by the Adept. This body is formed of astral light. The energy of this astral light in the East is called Kundalini, often referred to as the serpent. It is called by Qabalists the coiled serpent in דַּוְּסָי. One particular and perhaps interesting aspect of the simple symbolism of the serpent is that it moves by undulation. This is very similar to the astral light that seems to move and weave itself back and forth. Of course, this pulsation or expansion of astral light and then decrease of astral light as through undulation can be directly attributed to the Moon's influence over it. That is why the planet of the Moon is attributed to the sephira of דַּוְּסָי. The ancients determined that the Moon is in fact a planet and as it waxes and wanes it controls the motion of the tides and, of course, from the term Luna we have the word lunatic, which seems to be connected to strange behavior on a full Moon. So, on one hand we often conceptualize the Moon as belonging to that of the insane, but, on the other hand, the Moon belonging to lovers, with midnight walks on a dark beach, under a starry night and

a full Moon. The Moon is both the Wiccan goddess Hecate in her Darkness, and Diana the Moon goddess in her brightness.

Both *hnyb* and *dwsy* suggest some kind of control over waters. However, all the sephiroth of the Middle Pillar are the element of Air. It is Air that moves the Water. *hnyb* is the Great Sea and Isis Mighty Mother. So *hnyb* is the universal unconsciousness and it is from *hnyb* that all forms ultimately develop. We could say that *hnyb* is the will to form. However, *dwsy* is more of a storehouse of formal images, images that have been formed and lie directly behind our conscious experience.

So, at the lowest level, *dwsy* is the astral world and the realm of images. It contains kind of an astral record which is both a combination of the history of the races and a kind of individual mental thought of each man.

The images then that we find in *dwsy* are exciting, beautiful and fabulous. They are extremely seductive. However, they can also be hideous and frightening. In essence they are the dreams, longings and fears of humanity. They have existed since the beginning of time. *dwsy* is a great, huge body of water on which every little thought that has existed in mankind floats. *dwsy* is elusive and the astral plane has a warning to all who seek to improve their astral ability; *it seeks to deceive*. Let us remember that the Moon itself has no light of its own. It is a mere reflection of the Sun. *dwsy* can only reflect the light of Christ, Osiris, Buddha, center of *trapt*, the Logos, the Light of the world. This reflection of light found in *dwsy* is of great importance, especially for the developing magician in the Hermetic Order of the Golden Dawn, for at this stage of development we cannot look directly into the Sun.

The lower astral plane is also called Maya, or illusion. The powers that exist in the astral plane many times are excited to create false images for us and let us believe whatever amuses us. Through this giant storehouse of thought and images they will provide visions of the most absurd notions, while at the same time they will be inflating our egos. This is very dangerous and it is a common result of working in the astral plane on this level.

A good and formal understanding of this cosmic tide, so to speak, under the influences of Levanah can confer power. You see, the true Adept really understands the motions of this astral light and how it fluxes and also how it deceives. They see behind the flux within their own life. They see behind the deception of their own thoughts. They move beyond the deception, beyond the fluctuation, and eventually find themselves standing in the pure glowing light of *trapt*.

The symbols of *dwsy* are the sandals and perfumes, both relating to practical magic. Thus, we have the consecrated sandals worn by the one who stands within the mystic circle. It is in this mystic circle that we have a neutral ground, and if you will, holy ground or sacred ground. Thus, we need consecrated sandals to walk on it, and that is the energy of the Earth below and the Sun above. *dwsy* then is the intermediary between *t\klm* below and *trapt* above, kind of a two-sided mirror. Perfumes would suggest that it has etheric qualities. We know that incense floats through the air of the Holy Temple and subtly affects the minds of all who participate, for by images are all powers awakened and reawakened. The perfumes, incenses and scents are fleeting and illusionary which is, in fact, the nature of *dwsy*. The nines of the Tarot cards are

attributed to d̄isy and should be looked at by the Theoricus at least briefly. Of course, more information will be given on that in a future grade.

Some additional correspondences for the sephira of d̄isy. The translation as stated earlier is foundation, the queen scale of color is violet, the Archangel is Gabriel. It deals directly with the Nephesch, which is the producer of the Ruach Elohim. Nephesch translates into lower self. One of the scents that might be burnt or utilized while you are meditating and working on establishing contact in d̄isy is the scent of jasmine. The chakra is the root chakra which is actually the base of the spine. The body part is the genitals. The metal is silver. The stone is quartz. So, in pathworking d̄isy we will probably want a lot of quartz-types of images, perhaps an altar of quartz or even a temple of quartz. The creature is the elephant. It is interesting to note that in my personal temple there are two elephants that stand on either side of the temple to the entrance, that the pillars on the side of the altar are erected from elephants, and that any exploring I do is with a guide, that has been well tested, usually on the back of an elephant. It is also interesting to note that these symbols were utilized by me in my own pathworking of d̄isy long before I knew that the elephant was the animal. The tools as mentioned earlier are perfumes or scent, and sandals. The plant is comfrey.

I will strictly warn you utilizing whatever fear tactics are necessary, that d̄isy is the sephira of the astral light as pointed out earlier, kind of a collective storehouse of images, and as such it seeks to deceive the aspirant as well as to help enlighten. I would seriously advise all students of the Hermetic Order of the Golden Dawn to exercise strong banishing after working any energy in d̄isy, and to keep a very close diary of all revelations and inspirations that come from d̄isy. Remember to test all things for Light using the Banner of the East, the Banner of the West, the pentagram, and of course the Divine name Shaddai El Chai. Do not immediately come out of d̄isy and embark on a whole new lifestyle after doing so. Any change within consciousness or lifestyle should be done only after an extended period of thought and extended trips into d̄isy. Everything should be tested thoroughly. One of the dangers is that people will work d̄isy once or twice and immediately change their name, their hair color, their identity, and everything else because they are working from some kind of astral inspiration. That is not necessary for your growth.

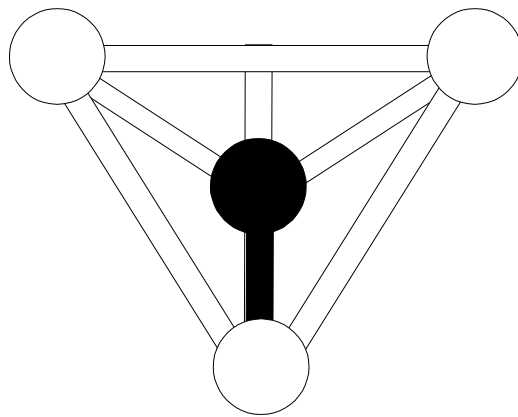

The Hermetic Order Of The
GOLDEN DAWN Intl.

**CREATION AND
DEVELOPMENT OF THE
BODY OF LIGHT**

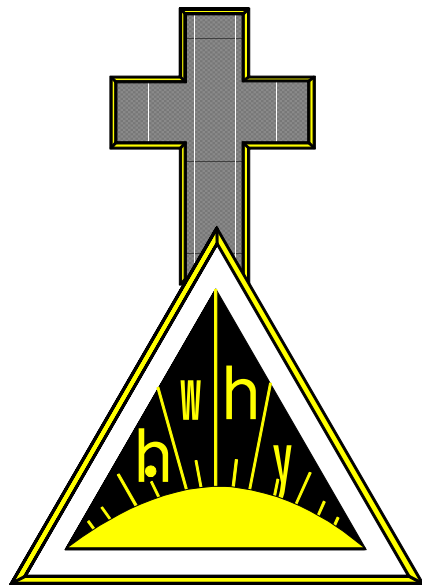

THEORICUS 2=9

Skrying and traveling in the Spirit Vision and astral projection are really the heart of the Hermetic Order of the Golden Dawn's magical system. It is very important that we not be misled nor deceived in our journey toward the Great Work.

The creation of the Body of Light, skrying, and astral travel require much skill, much discipline and much practice. It is for this reason that the magician always invokes the highest Divine names possible for the plane of existence he wishes to travel. Thus, he does so under the auspices of the Divine and not under the direction of his own ego.

It cannot be emphasized too strongly the need of the skill of the creation of the Body of Light. Even in Tarot divination it will be found that the use of clairvoyance in determining what a particular card represents is really done with the inner eye, the eyes of the Body of Light. This is different from the ego eyes or eyes of Assiah of the physical body. In addition to this, later in the Adeptus Minor grade, there are a series of workings dealing with the Enochian system. As prerequisites one must be competent with astral work and the Body of Light in order to gain anything out of that system worth relating.

One of the problems that may be confronted on a frequent basis are two misconceptions regarding clairvoyance, particularly referring to traveling in the Tattwas and skrying in the Spirit Vision. These two concepts that we confront can be both damaging and misleading to the novice. The first is the fear of clairvoyance, and this fear is based on an attitude that arises from a misunderstanding of its true nature. Many times it is said that the power of clairvoyance is obtained second hand from some source demonic or negative in nature. Many will claim also that the concept of using the techniques dealing with traveling and working with the Spirit Vision and the Body of Light will somehow come under evil influence. On the other hand, people imagine that somehow the power of clairvoyance is astronomical in that it will ease one's life and remove any trouble dealing with their lives, indicating there is an easier path accompanying the guidance that they desire. In fact, it may at times be considered that riches and prosperity may be obtained by will. This also is as far from the truth as can be imagined.

The properly trained and skilled Adept clairvoyant and master astral traveler has no fear that he will expose himself to negative powers. He is not deluded into accepting the fact that everything he does and sees in the Spirit Vision is of some great significance that will change his life. It is the untrained natural clairvoyant that is a danger, not only to his own self, but to those around him. These natural clairvoyants are considered dangerous inasmuch that they open portals to energies far beyond their limits of control. These energies may come in forms that may be seemingly positive changes in one's life or positive growth, where in fact it is nothing more than a stumbling block that will not only affect them in years to come, but also affect those surrounding them. It is only after being exposed to the proper methods that one can truly be initiated to the occult powers beyond the physical.

Let us realize that nobody has the inherent right to gain knowledge to which he has no claim. Let it be re-emphasized that the student of clairvoyance, astral travel and traveling in the Spirit Vision can only gain the skills necessary through hard work and discipline, as well as the power and skill to perform such tasks in security. Those attempting to gratify curiosity will be either very disappointed, distressed, finding

physical changes in their lives beyond their control or, simply and lastly, be mortified. Trained, humble, secure, honest and reverent astral workers and clairvoyants are a great gift. It is this same gift that is encouraged and developed that all have and possess, but only by skill, practice, and step-by-step training will one develop. The latter cannot be overemphasized as to its importance, for it is an issue within itself that many have paid the price in the attempt of such hit and miss occult science and haphazard book reading. There are many misconceptions dealing with the progress of such concepts. Many of which, in essence, never really reach their true goal but rather find that one is merely opening a portal to any general energy of any nature. It will be noted that this is not in accordance with the regulations of the Hermetic Order of the Golden Dawn mode of operation and it is advisable that one should not consider adopting such a method. Follow directions and the training, adhere to the lessons at the grade standing and in the end you will prosper as a master astral worker and clairvoyant.

Primarily, there are three general attributes and methods that fall under this lesson. However, we will be concentrating primarily on one of those developmental skills. They are:

- 1) Clairvoyance (Descrying in the Spirit Vision)
- 2) Astral Projection (Traveling in the Spirit Vision)
- 3) Rising in the Planes

This lesson will cover traveling in the Spirit Vision whereby it will affect clairvoyance and rising in the planes indirectly in conjunction with the development of the Body of Light.

Let it be emphasized that there is a significant difference between what is often called the "Inner guide method meditation" and "Traveling in the Spirit Vision." The Hermetic Order of the Golden Dawn system, in accordance with the traditions, holds that one should always invoke the highest Divine name with every working. Thus, the work to be employed will be under the auspices and direction of that particular energy. With this, let it be understood that it is quite different from merely looking within or opening one's own self. There are also methods that employ the use of the proper sigils (symbols) such as the Tattwas and the Tarot cards to travel in the Spirit Vision and for astral work into other planes of existence. However, in this lesson the method of the Body of Light shall be covered in a step by step fashion.

Exercises and Development

Let us now move on to a part of the exercise dealing with the creation and development of the Body of Light.

Begin gazing at one of your hands, noting all of its sides and all its details, the way it moves, the wrinkles around the knuckles, the hairs etc.. Then begin bending all the fingers separately beginning with the thumb, then the pointer, the middle, etc.. Attempt to feel the sensation you receive by bending them; notice and try to understand it. After doing this, do the reverse starting from the little finger, then the ring finger, the

middle, etc., keeping in mind to be aware of the sensation. The Theoricus should be performing this exercise each day. Move on now to the opposite hand and do the exact same procedure. After the exercise has been performed and an understanding of the sensations have been achieved do the same with the feet, then move on to the legs, noticing every detail to the best of your ability, and move throughout the trunk of the body. It would be advisable to be seated so that all the manipulative movements may be made. What this entire step is leading to is simply becoming aware of all body movements and sensory functions.

Lastly move on to any part not yet covered and do the same procedure. After an understanding of the movements and details has been achieved, return to the region of the head and invoke the Divine name Eheieh through the crown. (An optional procedure may be consulted, which is the use of a mirror to allow the awareness of the body to hold vividly within your mind as the Divine energies are being invoked, moving every inch of the head and feeling and observing the sensation of all parts of the head as the white brilliance moves within.) Move now toward the region of the neck invoking the Divine name YHVH Elohim while shifting the neck from side to side and in any and every movement possible. Still being aware simultaneously with the energy of Eheieh, attempt to notice the intermingling of the energies with YHVH Elohim and be aware of the sensations physically. This is to say then that jumping back and forth from one region and returning to the previous region is acceptable. Although the energy is a constant flow moving toward the feet, its primary purpose is to aid in the awareness of the physical body intermingled with Divine energy. Move onward to the region of the solar plexus doing the same, vibrating the Divine name while noticing the physical regions that the energy affects. For example, the solar plexus, the chest, the forearms, part of the upper arms, and the region slightly above the naval. Continue with the exercise moving towards the region of the groin, which affects the buttocks, the thighs and the pubic area; then to the feet affecting the lower and upper legs, the ham strings, etc., once again observing all of the parts that are affected by the Divine spheres in its own region. There can be noticed a sure difference between simply observing the body without the invocation and observing the body with the invocation. All in all, the first step involves merely observing the body in its functions, where the second step involves the same observation, but with the energies that govern the regions of the body. Both of these exercises are done fully aware with the eyes open or closed, preferably sitting, not laying down.

These next exercises are similar to the ones previously mentioned, however, these will be performed with your eyes closed. Begin again with one of the hands and eyes closed and, again, being observant. After doing this, attempt to observe the inner hand, the same hand, but of a lesser density (the astral Body of Light). Do the same to all the parts of the body much in the same order done previously, while still being aware of the energies invoked within your being, and keeping track not of the physical movements and functions, but instead keeping the body completely still while formulating a second or duplicate of each body part and observing its movements and functions.

The next set of exercises involves the use of the sephiroth. Beginning with the crown and working down to the feet, $\text{t\textbackslash k l m}$, using the vibrations and the Divine names in repetitions of twenty-five to thirty times in number, slowly and quietly observe your

Body of Light, doing nothing else but observing. This exercise should again be practiced over a period of time until such vision of the Body of Light can be seen and felt clearly without any trouble whatsoever.

The next set of exercises is a little more interesting to perform, however, the first set must not be underestimated as to skip their performance. In this step you will sit up in a chair or lay flat on the floor. Concentrate on beginning with one of the hands. As you would normally move the right hand upwards while bending the fingers and observing the astral or physical body, here, with eyes closed, you will have the astral hand come from the immobilized physical hand, merely having the Body of Light rise out of the physical body. It will seem and feel similar to the previous exercises, except the physical will remain stationary as the Body of Light is the vehicle being moved. Beginning with one hand, perform the previous exercise moving all the fingers from the thumb to the little finger and then from the little finger to the thumb. Perform the regular exercise moving from the legs in the usual fashion toward the head, keeping in mind that you are now dealing with the Body of Light, not the physical body. After accomplishing this, merely will the Body of Light to return to its physical counterpart and merge. Observe now the difference with the invoked energies in the body from the Body of Light looking upon the physical body. Remember that whenever the exercise is done physically in a certain manner, the sequence must also be replicated as closely as possible within the Body of Light.

In astral projection and the creation of the Body of Light, the astral worker emits from his ego a perceptible ray of identity and, by a trained eye, will send it to travel to the place desired. He then focuses it there, he concentrates, sees and knows that it is there not by mere reflection. Then, at the appropriate time, he re-enters his body. In traveling with the Spirit Vision, the process may be caused to start by using an appropriate symbol like the Tattwas, or it may be done on will alone. It is preferred for specified working that the Body of Light be created and focused through the Tattwa plane insofar that the travel will be focused and well defined when employing this agent.

In this grade, memorization of all of the Divine names should have already been established. As progression leads on to astral workings and traveling in the Spirit Vision through the creation of the Body of Light, it is critical that the Divine names be memorized prior to the workings. In addition, prior to working the Tattwas, the exercises in this lesson should be mastered. Let it be emphasized that without the proper skills and knowledge, one may be walking a very thin thread of danger psychically, physically and emotionally. This is why it is imperative to adhere closely to the organized fashion of the lessons, to aid in preparation and development. This may be considered one of the many reasons why it is discouraging to hear from one not initiated into the instructions of this lesson that a conversation with one's spirit guide has been obtained when, in fact, it is of a lower energy manifesting to disguise as a spirit contact. Keep in mind that everyone may have more than one spirit guide, but there can only be one Higher Nature. Moreover, it may be considered that the spirit guides are aspects of our Higher Genius. Remember, always test!

Up until this point we have consulted various exercises beginning with the understanding of the movement of the physical body to seeing the astral Body of Light around the physical, to working and separating portions of both the astral and the physical body. Now is the time to take the procedures a step further. At this point the

Theoricus should have taken a ritual bath. It is always advisable to purify the water and add a few drops of essential oil. He should be robed, in a ritual working area free of any disturbances. All the preliminary purifications and banishings should be employed in the working area, along with any incense or ritual items being used.

Continuing with the exercise, begin with the relaxation ritual and meditative breath. After so doing say this invocation:

" In the name of the Lord of the Universe who works in silence and whom not but silence can express, I adore Thee and I invoke Thee. Fill me now with your Divine essence of Light, guiding me in my occult work for the greater glory of Thy name not mine. In the name of Eheieh (visualize the rtk sphere). In the Divine name of YHVH Elohim (visualize the sphere around the neck). In the name of YHVH Eloah Vedaath (visualize the sphere around the solar plexus). In the name of Shaddai El Chai (visualize the sphere), and in the name of Adonai ha-Aretz (encompassing the feet). Help me now so that all that I do and all that I see and all that I am is in accordance with my True Will, my Higher Genius and the Great Work. As it is desired, so shall it be!"

Let the Theoricus now visualize his own figure in all its details. Let him see it clearly as if his eyes were open. It should be enveloping or standing near or in front of his physical body. Focus on all aspects of the astral body and then slowly transfer the seed of consciousness from the physical into the visualized figure. All aspects of consciousness should be transferred to the astral Body of Light. He should then concentrate on the sensations of this astral vehicle; hearing, seeing, smelling and even touching. Again, the exercises above should all be performed in the astral Light in the same form that it was performed in the physical. Seeing that all the consciousness and mind are now present within the astral, let it now rise high above. At a point where it is felt high enough, he should stop and look about him. He should only notice and observe and not participate. If at any time any problems should arise psychically or by any foreign energy he should form a pentagram before him and banish that energy with the Divine name, "YHVH, I banish thee. Be thou gone. As it is desired, so shall it be." It is not uncommon to see or feel energy sources approaching. He should be fully conscious of all the landscape and surroundings encompassing him. He may come into contact with figures that are approaching, being certain that he is armed with the authority to test using the appropriate Divine names, pentagrams and signs. If at times there may occur extreme difficulty, he should consult the use of the Banner of the West. A diagram is found in the lesson "Establishing a Temple in t̄wkl̄m." Let it be noted that all figures must be tested for Light, "Love, Truth and Knowledge," by use of the pentagram. You may use a few or all of these. Should the figure(s) withstand the power of the test, he can choose to travel with these figures if desired. Later, in advanced lessons, the Theoricus will learn to travel to specific planes particularly used in Tattwa vision. This information may now be incorporated into pathworking, beginning again with t̄wkl̄m. The Theoricus must also be aware of all the thousand subtle attacks and deceptions that he will experience. He must test the truth with all to whom he speaks and comes into contact. At this particular point in time, the Theoricus must be able to employ full consciousness with the Body of Light so that all aspects of his seed

of consciousness are fully inside his astral Body of Light. He must develop his astral double with integrity and practice the movement exercises before moving on. If for any reason it is felt that an energy is following you back to the physical body, you may consult the power of the L.B.R.P. and the B.R.H..

After the travel has been completed, allow the astral form to merge with the physical body. When the body has been completely reabsorbed, he should, with his astral eyes, be looking at the astral body. Once again, perform briefly the movement exercises. This time around be sure to observe the color of the astral body which may be white with highlights of off-blue. If there are any unusual differences in the astral body inside of the physical, he should now perform physically the L.B.R.P., B.R.H.. If there is a lack of strength or a feeling of weakness, a Middle Pillar will alleviate the problem. Let it be noted that in order for the latter descriptions of the astral to be successful, the exercises as so stated must be practiced daily, not forgetting to include always the standard banishings. While in the learning process, slowly but surely increase the time spent outside of the physical.

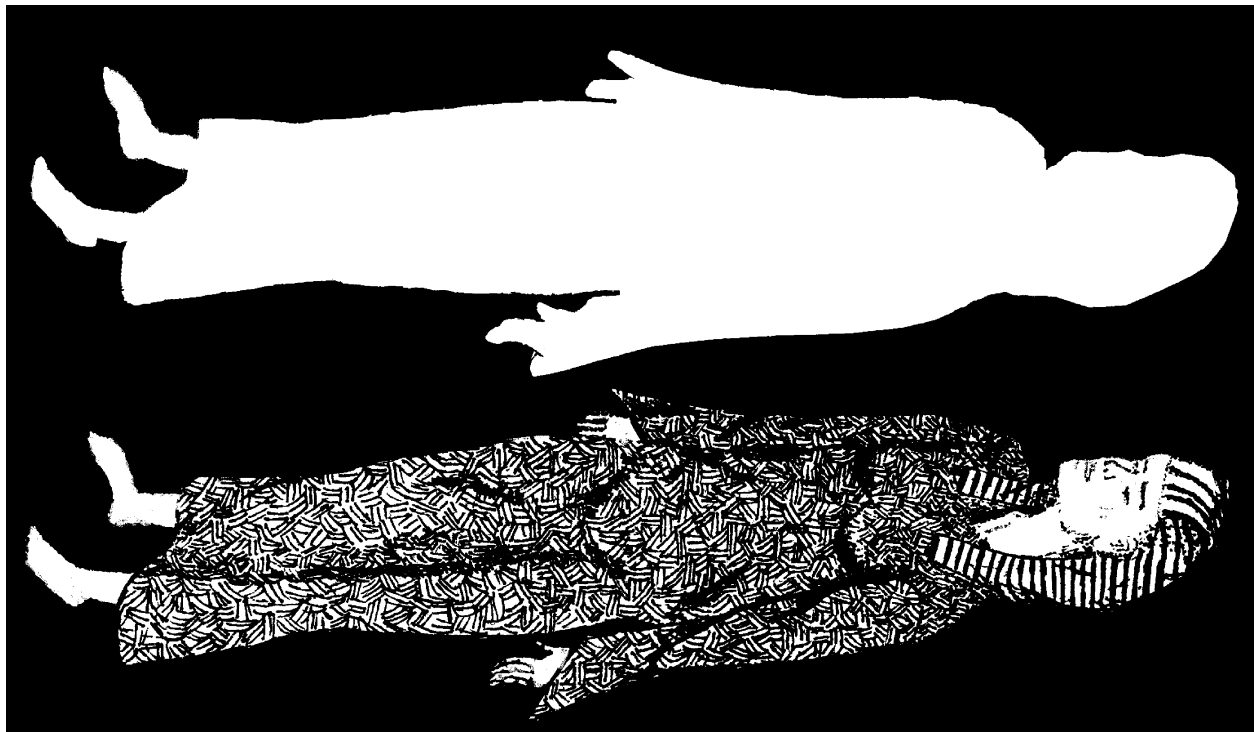

The Hermetic Order Of The
GOLDEN DAWN^{Intl.}

**THEORICUS ADVANCEMENT
TEST**

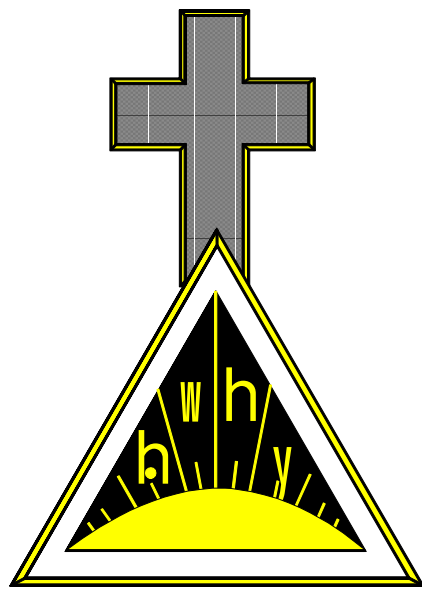

THEORICUS 2=9

Test for Advancement to Theoricus 2=9

1. Perform or describe the Theoricus Grade Sign.
2. What mythos does the Theoricus Grade Sign allude to?
3. Have you done regular meditations with Raphael?
4. What is the Grand Word or Divine name of the Theoricus grade?
5. What is the Mystic number?
6. What is the Password for the Theoricus grade?
7. What sephira does the Theoricus grade allude to?
8. What is the entrance badge of the Theoricus grade?
9. How many squares are on the Cubical Cross?
10. What do the squares allude to?
11. Explain in brief the Caduceus of Hermes.
12. What are the three secret Enochian names of God borne on the Banner of the East ?
13. What is the title given to you in this grade?
14. You were given a special Kamea in this grade. Which planet is it of?
15. Name the key phrase for the twelve zodiacal signs.
16. Describe the basic nature of each zodiacal sign, or the key words.
17. According to Mathers, what is Qabalah defined as?
18. The Qabalah is classified under four headings. What are they?
19. What is Temurah?
20. What is AiQ Bekar?
21. Name five of ten problems the Qabalah is designed to solve.
22. What are the Three Veils of Negative Existence?
23. What does each veil translate as?
24. Explain Tzim Tzum.
25. Have you made your Air Dagger?
26. What is the Divine name on your Air Dagger?
27. Who is the Archangel on the Air Dagger?
28. Have you practiced the Body of Light?
29. What is the Body of Light?
30. What are the dangers of the Body of Light?
31. Explain the Fylfot Cross.
32. Give the meanings of Luna on the Tree of Life.
33. Give the basic meaning of the twelve houses.
34. What is the planetary ruler of each sign? Example: Aries is Mars.
35. What is the color of each zodiacal sign?
36. What are the Fixed zodiacal signs?
37. What are the Common zodiacal signs?
38. What are the Cardinal zodiacal signs?
39. Give the basic meanings of the sixteen geomantic figures.
40. Identify the sixteen geomantic figures.
41. What is the element of each geomantic figure?
42. Who is the ruler of each geomantic figure?
43. What is the zodiacal sign for each geomantic figure?

44. What is the Tarot card that corresponds to each Hebrew letter?
45. What is the Heaven of Assiah for each Tarot card or Hebrew Letter?
46. Explain how to perform the Moon Breath.
47. What affects have you achieved with the Moon Breath?
48. Have you worked with the god form of Aroueris?
49. Give the Briatic colors of the seven ancients planets.
50. Name the five basic Tattwas and describe them.
51. Which Tattwas have you pathworked?
52. Are you pathworking daily?
53. Describe the path of t.
54. What are the dangers associated with dᵛsy.
55. What are the Olympic Planetary Spirits for the planets?
56. Have you established a temple in dᵛsy? Describe it.

The Hermetic Order Of The Eternal
GOLDEN DAWN Intl.

**INSTRUCTIONS FOR THE
THEORICUS BOOK**

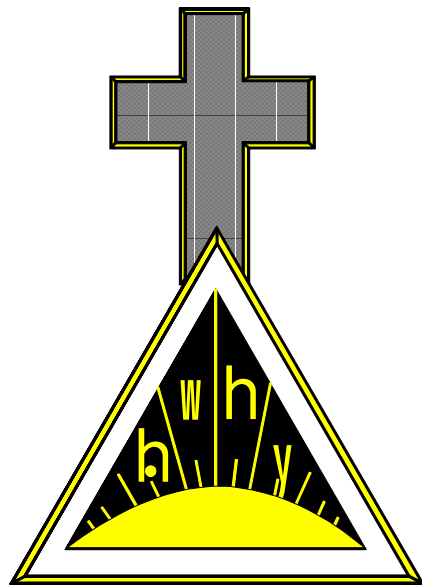

THEORICUS 2=9

Step 1

Read lesson on Theoricus Grade Sign and perform as stated in lesson.

Step 2

Purchase Air Dagger and begin construction. Symbology of the sigils and Hebrew will be understood as progress is made through the grade.

Step 3

Read Theoricus Initiation for further knowledge and understanding.

Step 4

In accordance with the Theoricus Initiation, this lesson, Symbology of the Theoricus Grade, will be required to memorize.

Step 5

Read lesson on Temple Symbolism and memorize accordingly.

Step 6

Greek Cubical Cross, the admission badge used to enter the path of Tav, for entering into Yesod. Learn and commit symbolism to memory.

Step 7

The lesson of "The Tree of Life and the Connecting Paths" helps with understanding the Tree and it's connecting paths.

Step 8

Read and memorize Caduceus of Hermes and how it relates to the Tree of Life.

Step 9

Read the lesson "Kamea of the Moon" for further understanding of the Moon.

Step 10

In the lesson "Highlights of Intro to the Qabalah", you have highlights of the introduction to S.L. MacGregor Mathers' book *The Qabalah Unveiled*. Study this lesson and know the basics.

Step 11

Perform the L.I.R.P. with the meditation with Raphael several times to understand the element of Air.

Step 12

Read the lesson "Creation and Development of the Body of Light." Begin the exercises according to the guidelines of the lesson.

Step 13

Read the lesson "Intro to Tattwas and Making Your Tattwa Cards." Begin skrying according to the guidelines of the lesson.

Step 14

Read the lesson titled "Sensitivity Training." Begin working with the exercises and experiments.

Step 15

Study the lesson on the Ritual of I.O.B.. Follow the steps in preparation for the ritual. Write the steps on 3x5 cards if you need to and perform the ritual as outlined in the lesson.

Step 16

Read the lesson titled "The Moon Breath." Begin practicing it on a regular basis.

Step 17

Color the God form of Aroueris. Add this God form to your regular God form work.

Step 18

Memorize the correspondence of the Tarot cards to the Hebrew letters.

Step 19

Read the lesson on the "The Planetary Aspects". Memorize the material in the graphs and have a basic understanding of the other material.

Step 20

Read the lesson on "The Astrological Houses, Their Meaning and Understanding." Memorize the material in the graphs and have a basic understanding of the other material.

Step 21

Memorize the correspondences of the "Heavens of Assiah Tarot, Tarot and Tools."

Step 22

Study the lesson "Zodiacal Aspects." Memorize some of the key information and have a good grasp on the rest of the material.

Step 23

In the Lesson "Geomancy Part One," memorize the Geomantic figures with their meanings and other correspondences.

Step 24

Read the lesson "The Three Veils of Negative Existence." Get a good comprehension of the material.

Step 25

Read over the Tarot lessons. Memorize the basic material such as color and esoteric title, and develop a general concept of the energies that card deals with.

Step 26

Establish your Temple in Hod, as outlined in the lesson of the same title.