

the Secret Temple

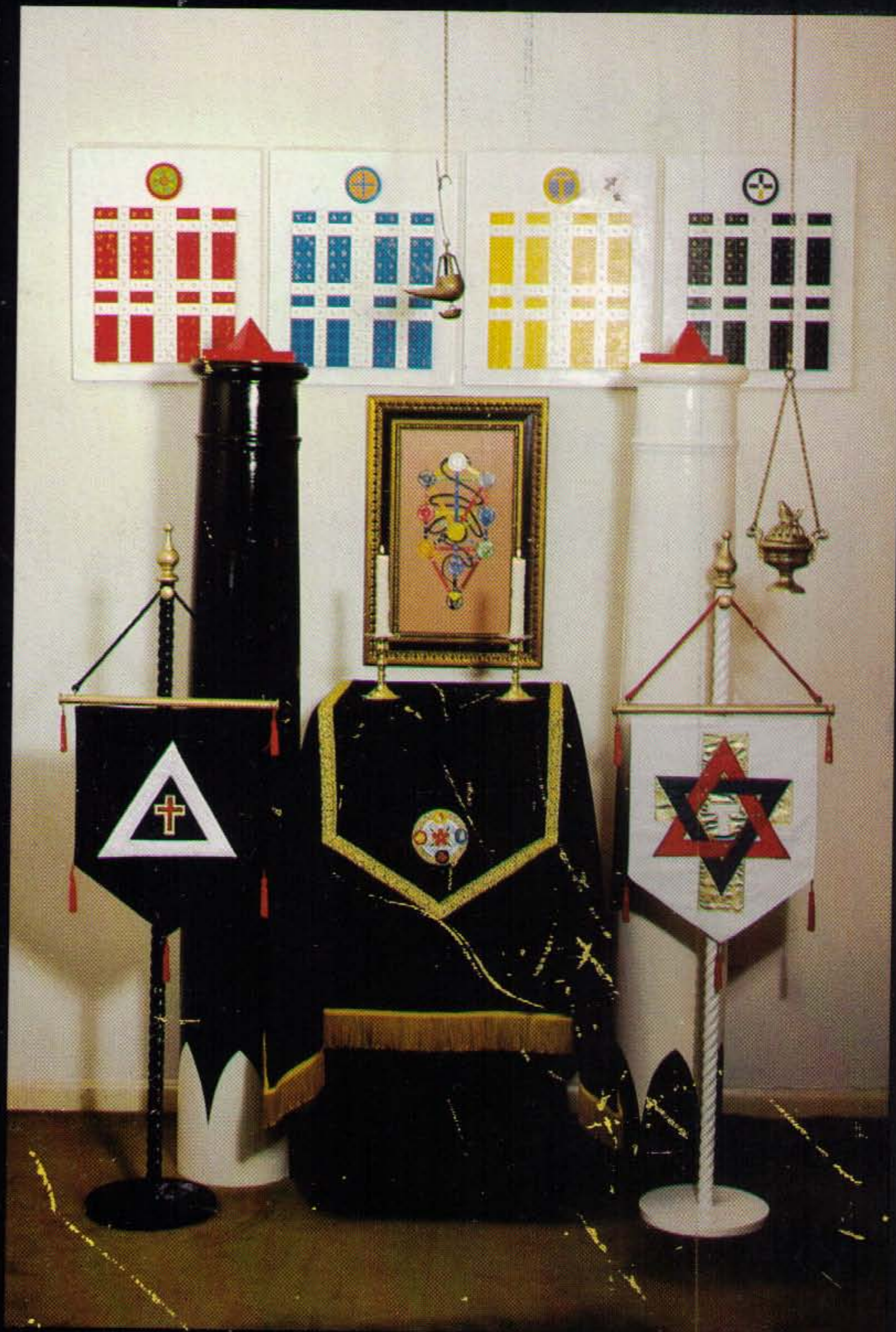

ROBERT WANG

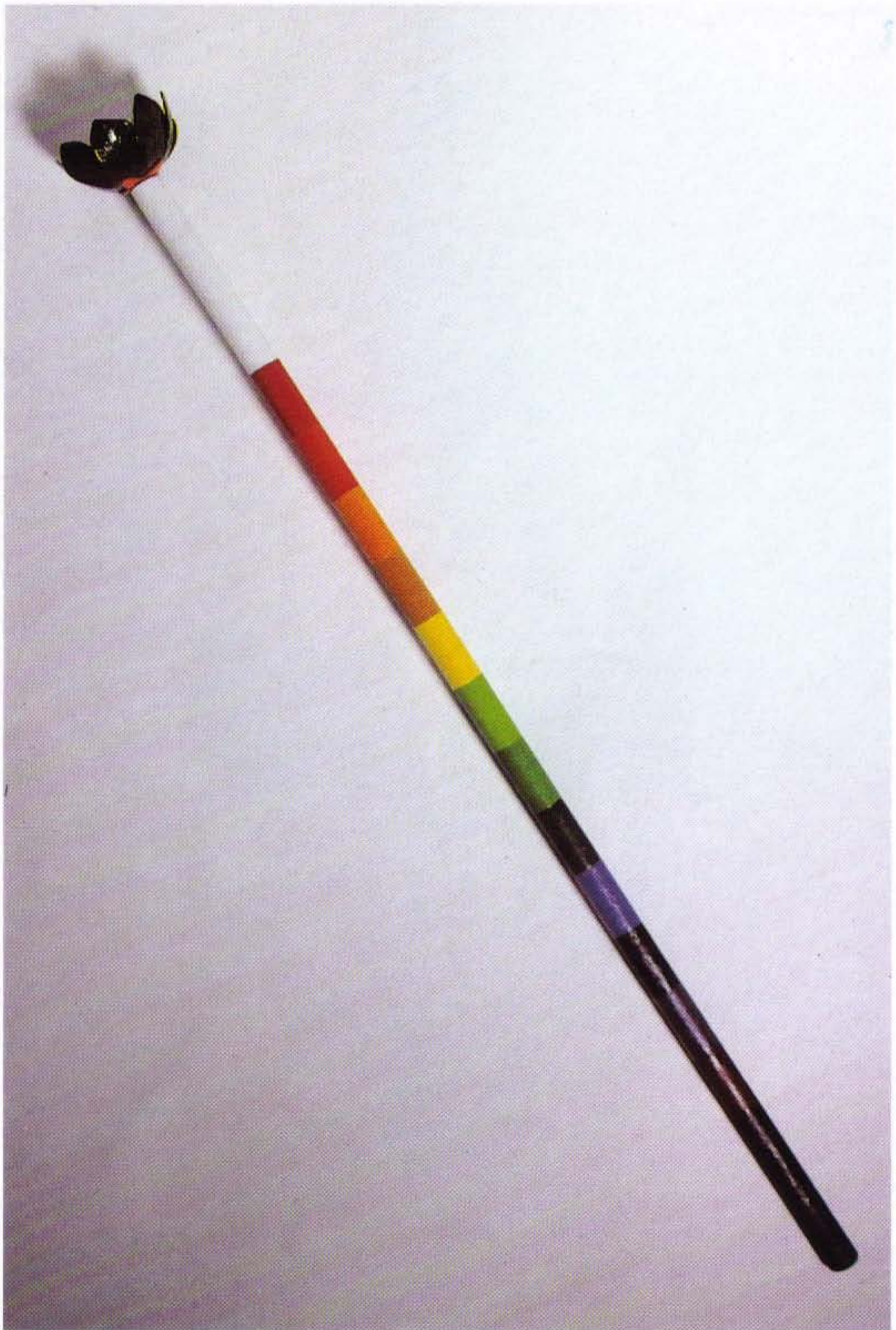

THE LOTUS WAND

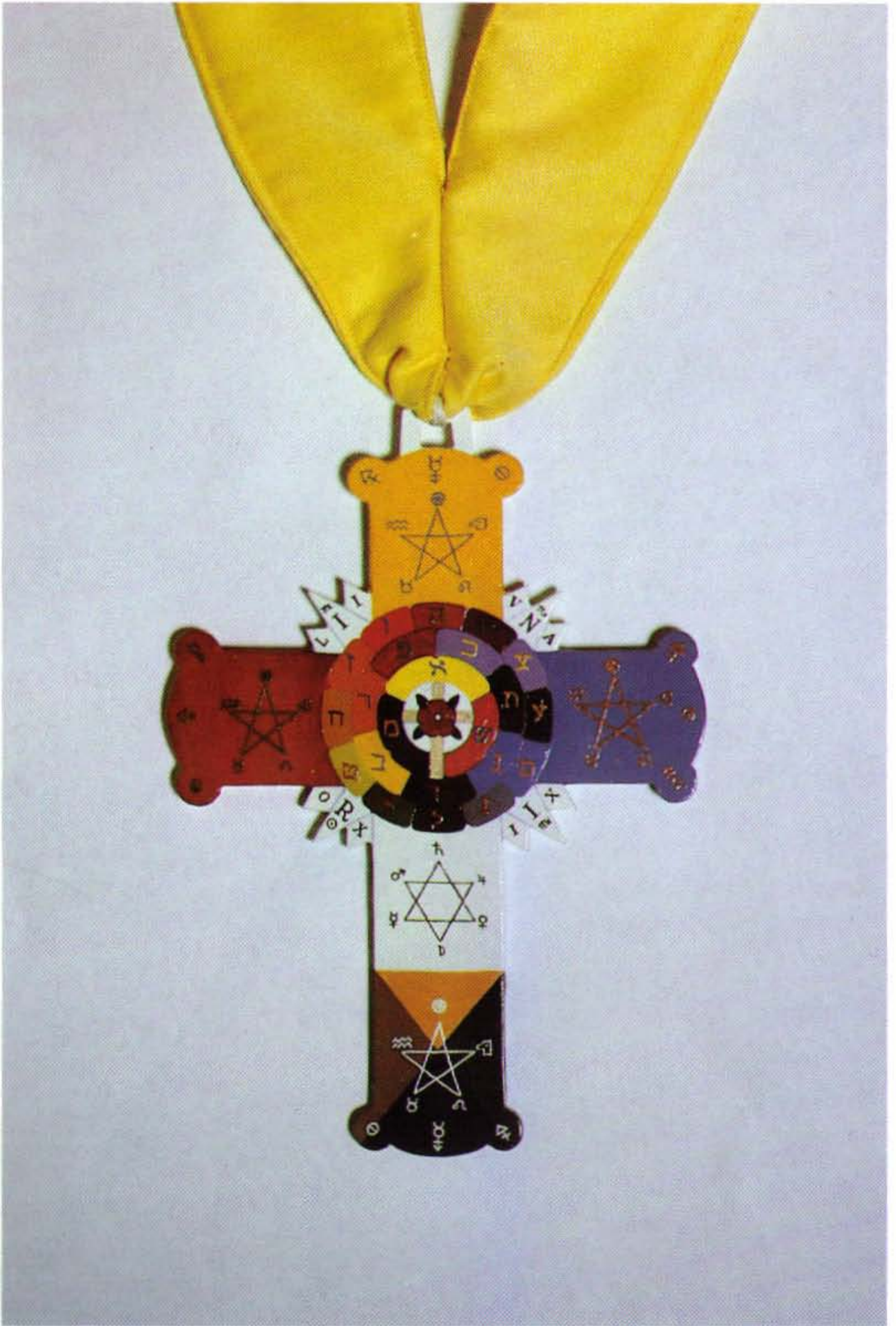

THE ROSE CROSS LAMEN

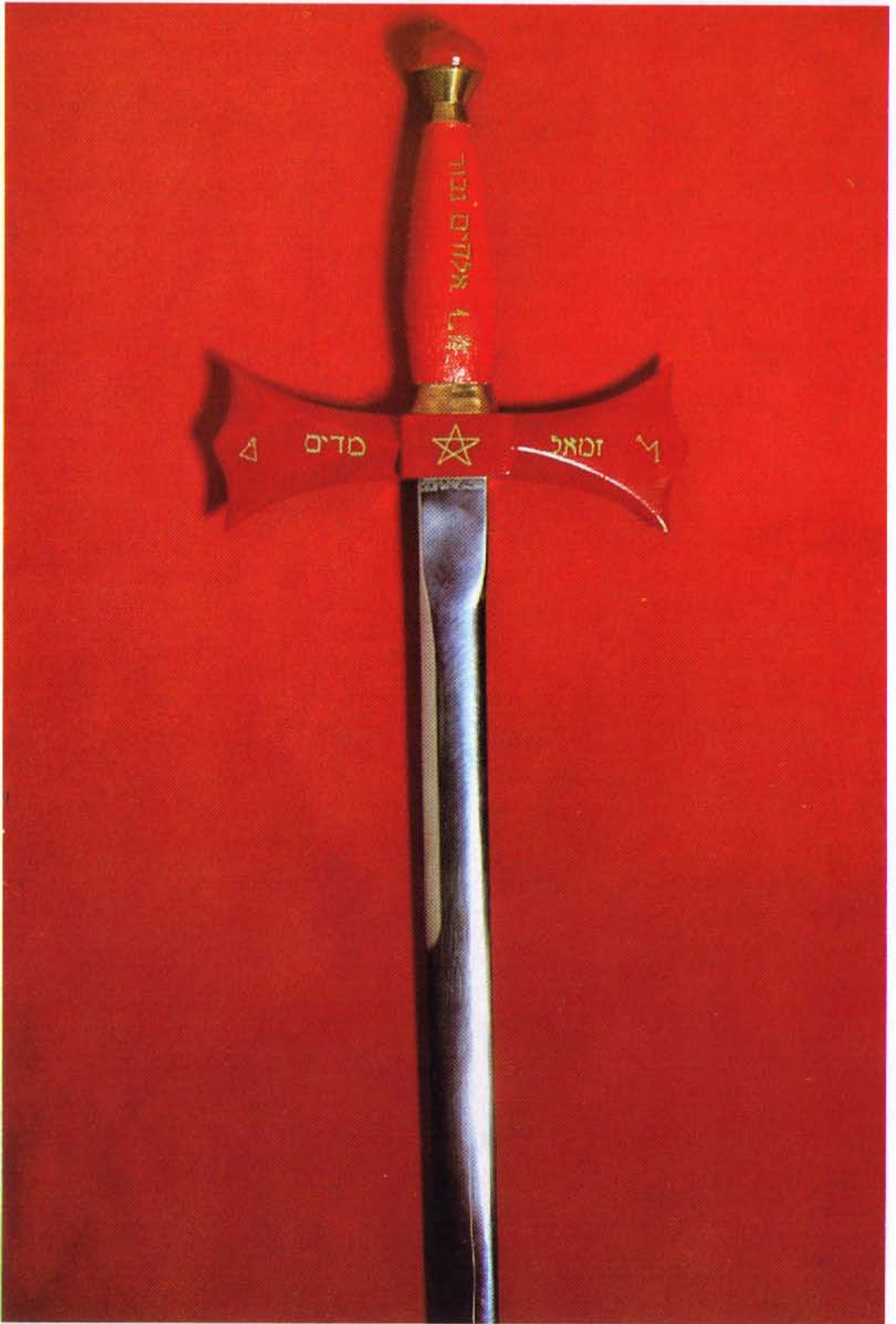

THE SWORD

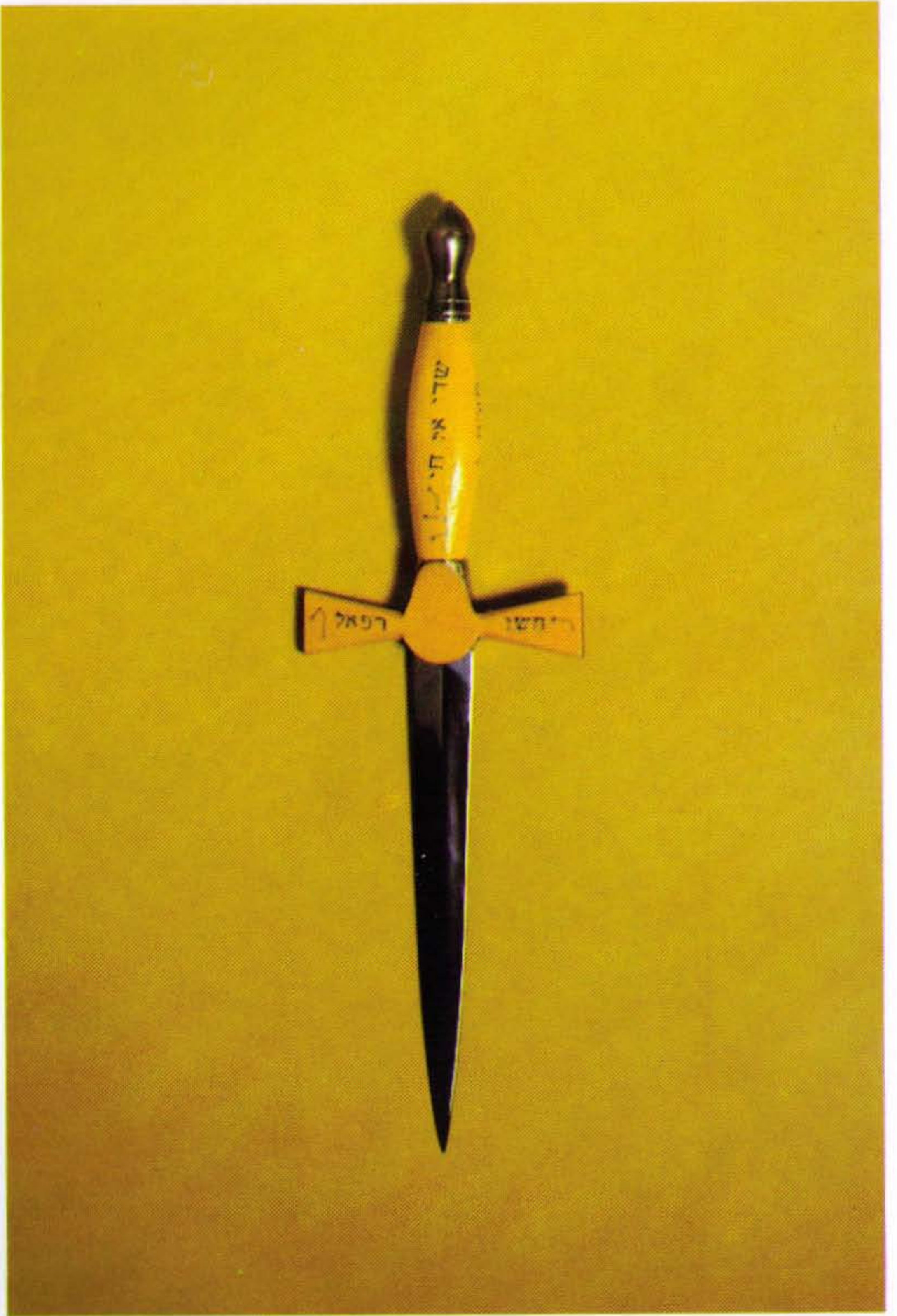

THE AIR DAGGER

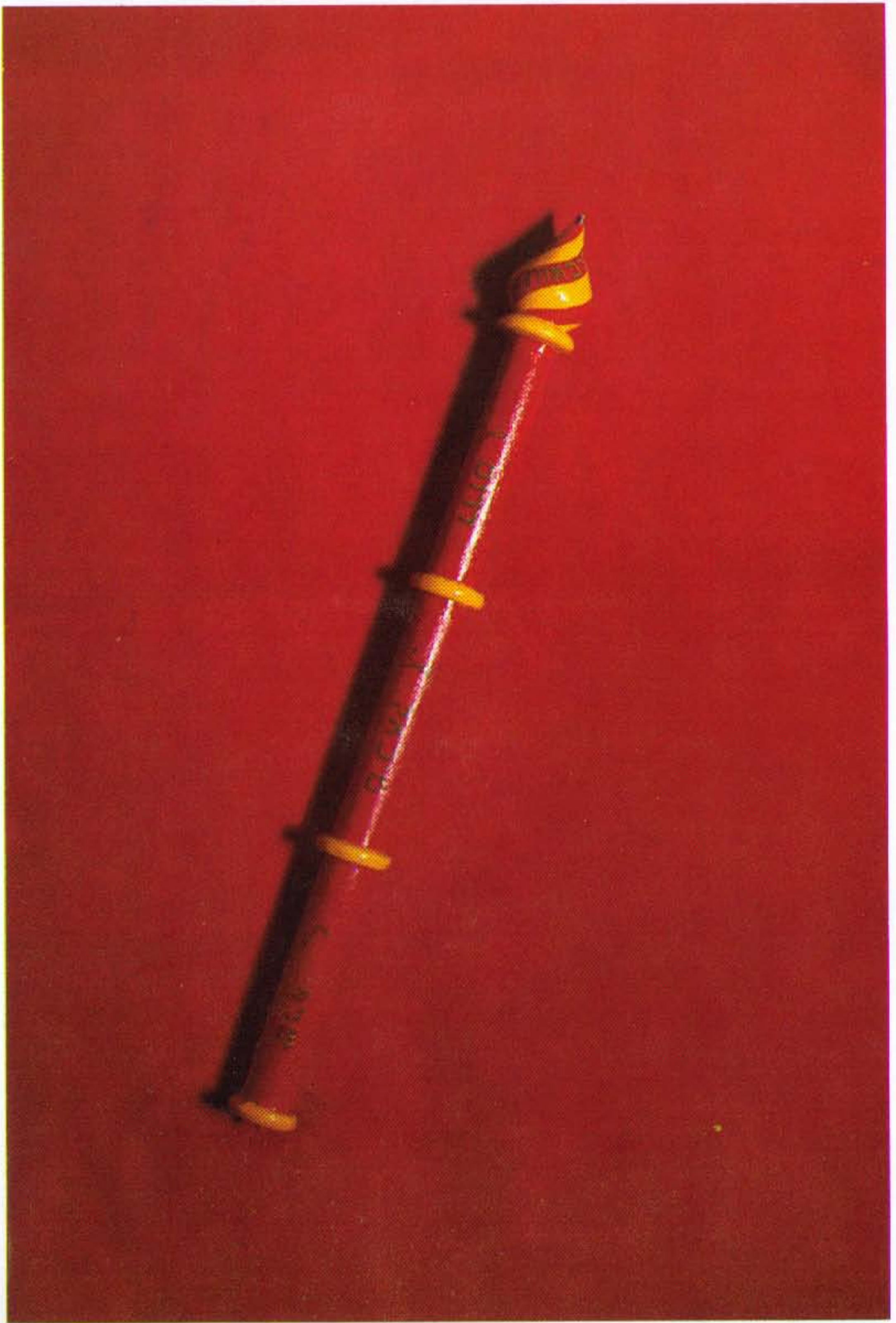

THE FIRE WAND

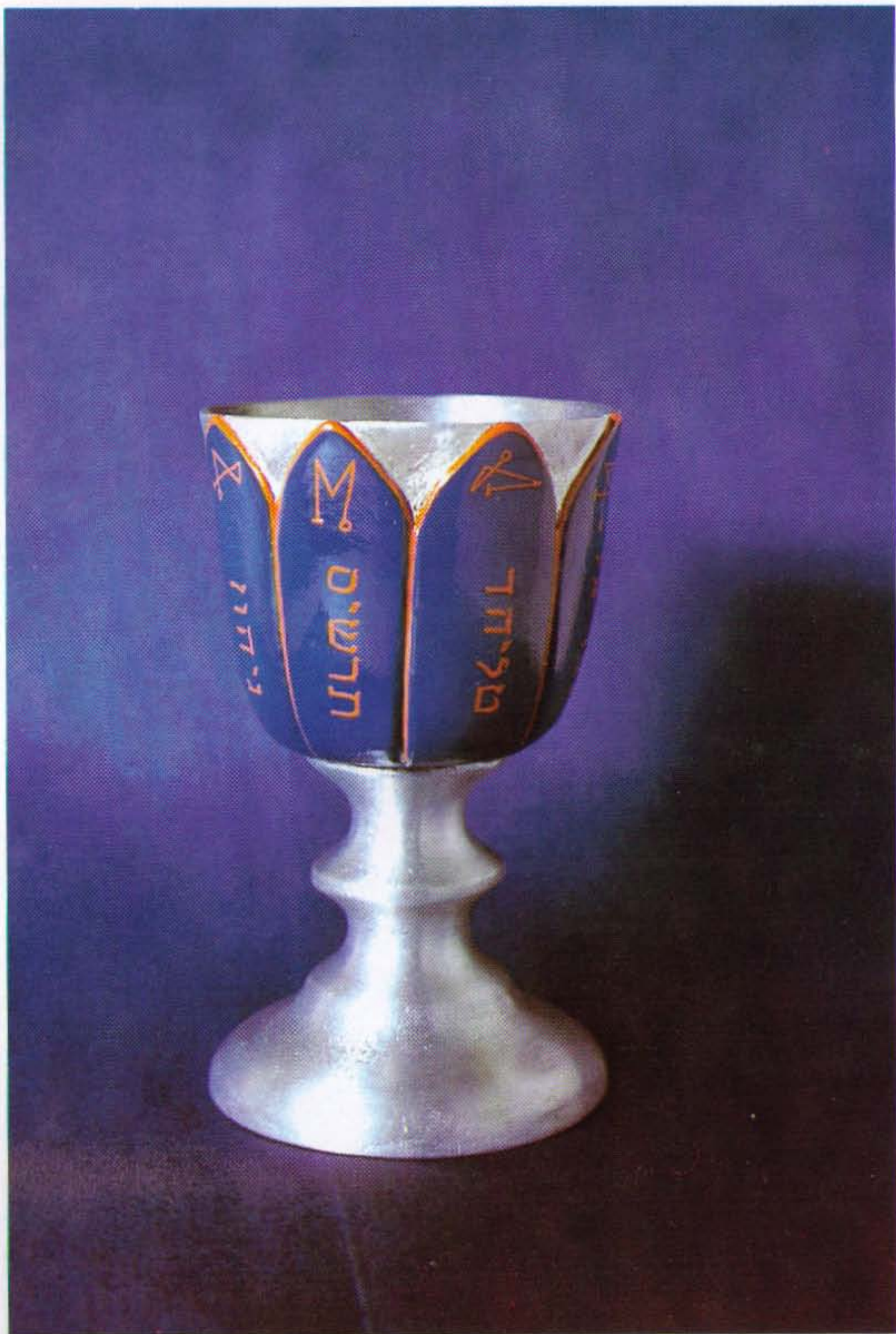

THE WATER CUP



THE EARTH PENTACLE



THE TEMPLE



THE ROBE

First published in 1980

Samuel Weiser, Inc.
740 Broadway
New York, N.Y. 10003

© Robert Wang 1980

ISBN 0-87728-490-3

Printed in the U.S.A. by
Noble Offset Printers, Inc.
New York, N.Y. 10003

CONTENTS

1. Preface, 1

PART I The Instruments

2. The Lotus Wand, 11
3. The Rose Cross Lamén, 19
4. The Sword, 29
5. The Fire Wand, 33
6. The Water Cup, 37
7. The Air Dagger, 41
8. The Earth Pentacle, 43

PART II The Temple

9. The Temple, 51
10. The Altar, 55
11. The Lamp, 58
12. The Censer, 59
13. The Cross and Triangle, 61
14. The Pillars, 63
15. The Temple Diagram, 73
16. The Banners of the East and West, 79
17. The Enochian Tablets, 83
18. Robes, 89

Notes on Consecration, 91

Recommended Reading, 91

Dedicated to Israel Regardie,
who has shed Light on the Path,
for all of us.

Acknowledgments

Thanks are due to Timothy Miles, whose advice has greatly influenced the form and content of this book. Moreover, a large measure of appreciation is owed to Donald Weiser and to my editor, Gale Courey, both of whose kind support, encouragement, and always wise criticism, makes authorship a pleasant task.

1 / Preface

This is a practical book. It is intended for those who feel a natural inclination toward ritual, and who are willing to expend the special effort required to produce a full set of magical instruments and a personal Temple. The very act of developing the Wands, Cup, Tablets, etc., is a devotional one which may lead the student to an inner mainstream. It is a form of sacrifice.

The instruments and Temple described herein are those specified by the Hermetic Order of the Golden Dawn. They are, however, based on principles which have not varied over the centuries. Particular to the Golden Dawn is its emphasis on the four Elements, symbolized by the Wand, Cup, Dagger and Pentacle. These instruments represent the component parts of the personality, as is also represented by the five-pointed star of *Pentagram*. In this figure the fifth point is that of Spirit.

Those who ascribe to the methods taught by Aleister Crowley will experience few difficulties in adapting the materials in this book to his ritual practices, all of which grew from the practices of the Order of the Golden Dawn. Crowley was not very explicit, in his writings, about these instruments. In his *Equinox*, *Magick in Theory and Practice* and *Magick Without Tears* he discussed the subject without mention of the inscriptions to be placed on the instruments. But for those who possess the practical keys of the Golden Dawn, Crowley's work provides a dimension of insight which is unique.

His most useful advice is given in a letter to a friend, published in *Magick Without Tears*:

Let us consider what one can do with an ordinary house. . .

First of all, it is of immense advantage to have a room specially consecrated to the Work, never used for any other purpose, and never entered by any person other than yourself, unless it were another Initiate, either for inspection or in case you were working together.

The aura accumulates with the regularity and frequency of Use.

The first point is the Banishing: Everything is to be removed from the room which is not absolutely necessary to the Work. . . The walls should be 'self-coloured,' a neutral tint-green, grey or blue grey? — and entirely bare, unless you put up in the proper quarters, the proper designs, such as the 'Watch Towers.' . . . Next, your Circle. The floor ought to be 'Earth' green; but white will serve, or black (A Masonic carpet is not at all bad.) . . . The Altar must fit exactly the square of Tiphareth; it is best made as a cupboard; of oak or acacia, by preference. It can then be used to hold reserves of incense and other requisites.

Note that the height of the Altar has to suit your convenience. It is consequently in direct relation with your own stature; in proportion it is a double cube. This then determines the size of your circle; in fact the entire apparatus and furniture is a geometrical function of yourself. . . . Next, the Lamp. This may be of silver, or silver-gilt (to represent the Path of Gimel) and is to be hung from the ceiling exactly above the centre of the Altar. There are plenty of old church lamps which serve very well. The light is to be from a wick in a floating cork in a glass of olive oil. . . . It is really desirable to make this as near the 'ever burning Lamp of the Rosicrucians' as possible; it is *not* a drawback that this implies frequent attention.

Now for the Weapons!

The Wand. Let this be simple, straight and slim! Have you an Almond or Witch Hazel in your garden . . .? If so, cut (with the magic knife. . .) a bough, as nearly straight as possible, about two feet long. Peel it, rub it constantly with Oil of Abramelin. . .and keep wrapped in scarlet silk. Constantly I wrote, and meant it; rub it, when saying your mantra, to the rhythm of that same.

. . .*The Cup.* There are plenty of chalices to be bought. It should be of silver. . .

The Sword. The ideal form is that shown in the Ace of Swords in the Tarot. At all events, let the blade be straight, and the hilt a simple cross.

. . .*The Disk.* This ought to be of pure gold, with your own Pantacle, designed by yourself after prolonged study, graved thereupon. While getting ready for this any plain circle of gold will serve your turn. Quite flat, of course. If you want a good simple design to go on *interim*, try the Rosy Cross or the Unicursal Hexagram.

So much for the Weapons! Now, as your personal accoutrements, Robe, Lamén, Sandals and the like, *The Book of the Law* has most thoughtfully simplified matters for us. 'I charge you earnestly to come before me in a simple robe, and covered with a rich head-dress.' (AL, I:61) The Robe may well be in the form of a Tau Cross . . . The best head-dress is the Nemyss . . . you can easily make one yourself out of silk; broad black and white stripes is a pleasing design. Avoid 'artistic' complexities.

I feel moved to add a line of caution and encouragement . . .

Just as soon as you start seriously to prepare a place for magical Work, the world goes more cockeyed than it is already. Don't be surprised if you find that six weeks intense shopping all over London fails to provide you with some simple requisite that normally you could buy in ten minutes. Perhaps your fires simply refuse to burn, even when liberally dosed with petrol and phosphorus, with a handful of Chlorate of Potash thrown in

just to show there is no ill feeling! When you have almost decided that you had better make up your mind to do without something that seems really quite unobtainable – say, a sixty caret diamond which *would* look so well on the head-dress – a perfect stranger comes along and makes you a present of one. Or, a long series of quite unreasonable obstacles or silly accidents interfere with your plans: or, the worst difficulty in your way is incomprehensibly removed by some extraordinary ‘freak of chance.’

In a word, you seem to have strolled into a world where, well, it might be going too far to say that the Law of Cause and Effect is suspended; but at least the Law of Probability seems to be playing practical jokes on you.

This means that your manoeuvres have somehow attracted the notice of the Astral Plane: your new neighbours (May I call them?) are taking an interest in the latest Tenderfoot, some to welcome, they do all they can to help you to settle down, others indignant or apprehensive at this disturbance of routine. This is where your Banishings and Invocations come to the rescue. Of course, I am not here referring to the approach to Sanctuaries which of necessity are closely guarded, but merely to the recognition of a new-comer to that part of the world in general.

Of course all these miracles are very naughty of you; they mean that your magical power has sprung a few small leaks; at least, the water is oozing between some planks not sealed as Hermetically as they should be. But oh – and this is naughtier still – it is blessed, blessed comfort that they happen, that chance, coincidence, and all the rest will simply *not* explain it all away, that your new vision of life is not a dream, but part and parcel of Experience for evermore, as real as any other manifestation of Reality through sense such as is common to all men.

Crowley did not deviate from the Golden Dawn methods (in which he was instructed by Alan Bennett) until he had

thoroughly mastered them. These methods are both safe and sound, when followed to the letter, and are ideal for personal development. The manufacture of these instruments and Temple is an exceptionally strong way to approach the western esoteric Path. The reason is that the Golden Dawn, as opposed to most other systems, offers a totally structured 'course of studies.' Yet this is a method from which one may branch out freely once its principles have been understood.

While it is generally agreed that the most efficacious tools for ritual are those created by the student himself, not everyone is an artist or craftsman. Few today could follow the strict early directions stating that one must forge his own sword from solid steel! The important principle is that we do as much as we can, because the instruments become *charged* as they are made. The more effort expended, the more energy is attached to each piece.

Many of these materials, such as the Sword, Dagger and Cup, can be purchased ready to paint. One assumes true ownership of an instrument by painting it with the appropriate God Names and Sigils, and by its consecration. Those who lack time or skill are advised to commission their instruments from professional craftsmen, and then paint each piece as specified herein. We are required only to do our best, and are assured that the Gods will meet us half way.

One important point to consider is the extent to which these instruments are a means to an end. It is all too easy to become absorbed in the beauty and minutiae of the tools, to the extent that they acquire false importance. A plow is of no intrinsic significance except as it facilitates the tilling of the soil from which new life will emerge. The Magical Instruments are important in that they, too, facilitate a process leading to new life. But they are not essential; they are helpful. As Crowley said: "All sense and faculties must share in the work, such at least is the dictum of Western Ceremonial Magic. And so we find the magician placing stone upon stone in the construction of his Temple. That is to say, placing pantacle upon pantacle, and safeguarding his one idea by means of swords, daggers, wands, rings, perfumes, suffumigations, robes, talismans, crowns, magic squares and astrological charts, and a thousand other symbols of things, ideas and states, all reflecting the one idea; so that he may build

up a mighty mound, and from it eventually leap over the great wall which stands before him as a partition between two worlds."

Unfortunately, some may believe that the construction of a Temple, and the traditional instruments of the magician will confer instant enlightenment and power of some sort. It may be supposed that this is a relatively painless way to effect entry into the Inner Worlds, which is not at all true. The *Magical Path* is as slow and arduous as the *Meditational Path*.

Western ritual is admittedly theatrical. There is, in fact, something very flamboyant about the creation and use of the magical instruments. But this is as it should be. Ritual and its accoutrements offer a special focus of attention, drawing us inward. An easterner may sit silently on the ground and invoke the forces of nature with enviable simplicity. We, on the other hand, must contend with an energetic environment working against inner tranquility. Ritual helps us to transcend the weighty dynamism of our culture. As one assumes the gold-edged white robe, feels the slight weight of the Rose-Cross Lamén around his neck, and begins to work with the tools of traditional esoteric science, there is a feeling that one stands between two worlds. It is as profound a feeling as that of a priest preparing for the Christian Eucharist. And, of course, that is the point: by preparing our instruments and Temple, we may, in a lesser way, ordain ourselves into the priesthood of the Great Work.

Ideally, one would belong to an Order, where the preparation of these materials is part of the initiation of Tiphareth. Yet far too many of today's so-called "Orders" (including some established by very great occultists of the past) are of suspect integrity. Suffice it to say that if one is intended to work with a truly enlightened group, it will find him. As the aphorism states: *When the student is ready, the master appears.*

Individual work is more difficult, but it is possible today thanks to publications of teachers in the Golden Dawn tradition such as Israel Regardie, Aleister Crowley, Dion Fortune, Paul Foster Case, Gareth Knight and W.E. Butler. Regardie's work, *The Golden Dawn*, is the primary source book for the system in which these instruments are used, and must be considered a life-

time study. Moreover, this present book may make little sense to those completely unfamiliar with Regardie's *Golden Dawn*.

Minimal Requirements

There are many people who can afford neither the time nor the money for instrument construction, but who wish to pursue magic in some way. For those a 'stripped-down' version is possible, requiring little effort and virtually no craft skills. Such instruments are unlikely to have the vitality of a more sophisticated set, but they will allow ritual work to be performed.

The basic instruments are: *The Wand of the Magician*, *The Fire Wand*, *The Water Cup*, *The Air Dagger* and *The Earth Pentacle*.

THE WAND OF THE MAGICIAN

This may be a piece of 3/4 inch dowel rod, approximately twelve inches long. It should be painted gold.

THE FIRE WAND

This may be a piece of 1/2 or 3/4 inch dowel rod, ten inches long, painted bright red.

THE WATER CUP

Any metal cup painted blue, or any blue glass cup would be appropriate.

THE AIR DAGGER

Any knife or letter opener can be used, although a cross piece at the hilt is desirable. The knife is painted bright yellow.

THE EARTH PENTACLE

This is a simple round wooden disc, approximately four inches in diameter, painted black. Hobby shops, hardware and lumber dealers often sell wooden circles of plywood.

The assembly and painting of these simple instruments requires about four hours, and little cost. The suggestion is made here to counter a common belief that magical tools are all but impossible to produce. In fact, one makes a commitment to

the system according to his own needs. One who is highly spiritually developed may not need to expend the effort to produce an elaborate set of instruments, although most people will find that pouring great energy into this work is invaluable in forming a link with the inner currents established by the Golden Dawn. There is, in this, something of being willing to sweep out the Temple before one is permitted to sacrifice at the altar.

A natural artist or craftsman may spend years producing a beautiful and highly sophisticated set of instruments which is personally appropriate. And again, these tools should be the best we can do. They become extensions of ourselves which are consecrated and, although they may be seen, must never be touched by another.

Part I / The Instruments

2 / The Lotus Wand

The wand is the primary tool of the magician in the Golden Dawn system, its consecration being a superb introduction to the rites of consecration in general. Some, however, express the opinion that the Lotus Wand is unnecessarily difficult to use. It is, admittedly, quite long, can never be inverted, and must be held by difficult sections according to the operation at hand. Despite such restrictions, many find it to be an exceptional instrument.

Since a wand symbolizes the *Will* it is a very personal tool, and ingenuity may be applied in its construction. Those who do find the Lotus Wand cumbersome may wish to prepare a second wand, of their own design, for more regular use.

A great deal has been written on the subject of wands, suggesting that to make one is a feat equaling the building of the pyramids. Contrary to *ex cathedra* pronouncements by certain occult writers, it is not necessary to cut a birch branch with a golden sickle, at two in the morning on the Sahara desert, when Pluto is conjunct Mercury. What is most important in the construction of any instrument is its consecration. And since the ability to consecrate is a measure of progress along the Path, a student spares no detail which may add to the energies contained in his instruments. It is for this reason that a simple set may be sufficient for the more spiritually advanced, who naturally confer power in consecration. Others must begin the process of consecration with the "sweat of their brows," building

energy into each piece as they work on it, and then intensifying and sealing that energy with a ritual of consecration.

One end of the Lotus Wand is white, symbolizing Pure Spirit, and the other end is black, symbolizing the Earth. They are the *Light* and *Darkness* between which are bands of color referring to the *Signs of the Zodiac*. The Planets are also implied here, since 'Planets live in Houses,' and one holds the band of the Zodiacal sign where a particular planet is resting, for an operation of that Planet.

Above all is a White Lotus flower. The Golden Dawn text states: "The 10 upper and inner Petals refer to the Purity of the Ten Sephiroth. The middle 8 refer to the counter-charged natural and spiritual forces of Air and Fire. The lowest and outer 8 refer to the powers of Earth and Water. The centre and amber portion refers to the Spiritual Sun, while the outer calyx of four orange sepals shows the action of the Sun upon the life of things by differentiation." It will be seen that there are twenty-six petals, which is the number of the Yod Heh Vau Heh. $Yod (10) + Heh (5) + Vau (6) + Heh (5) = 26$.

Construction

The shaft of the wand should be 3/4 inch dowel rod, varying in possible length from 24 to 40 inches. In practice, the shorter length is best, since it is more easily manipulated and stored (Note that the instruments are stored inside the Altar).

1) Sand the rod lightly, rounding the end to be painted black.

2) Coat the rod with gesso, and again sand lightly. Gesso, a white acrylic medium, seals the wood and forms a base for finished painting. It is available in any art supply store.

This medium, which is water-based and fast drying, should be applied in two thin coats. Brushes must be washed immediately in soap and water, as a very hard and waterproof coat forms when gesso is completely dry.

3) With a ruler and soft pencil, divide the rod into sections. The white end should be the longest, then the black, and finally twelve sections of equal size. Place small marks along the length of the rod. Then, with a rolled piece of heavy paper or cardboard acting as a circular straight-edge, inscribe lines around the rod:

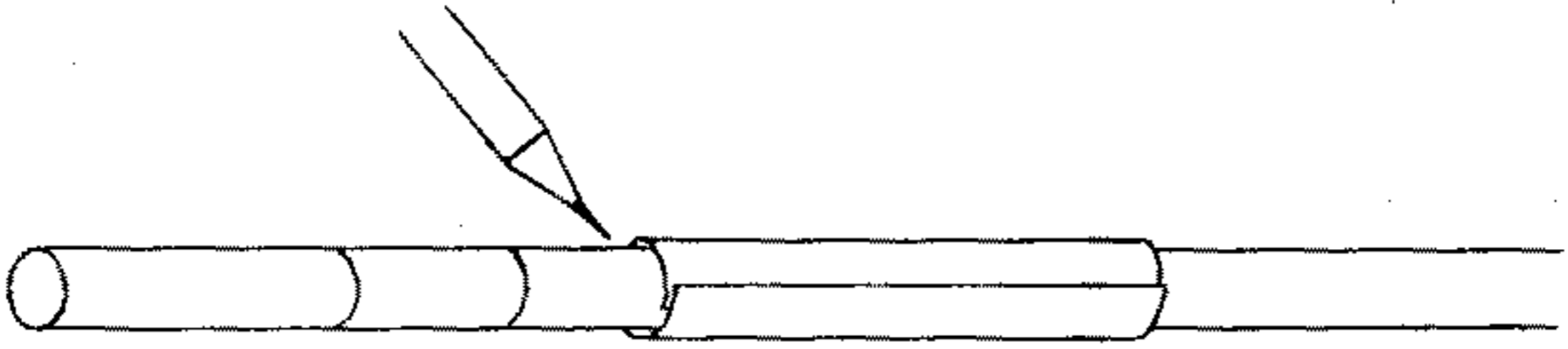

4) Using *artist's acrylic paint* (those sold in tubes, not in jars), carefully fill in the colored bands as indicated on page 16. Work about half-way down the wand, and allow the colors to dry. Then invert the wand and complete the bands at the opposite end. A tall jar will provide support during this process.

Artist's acrylics are ideal for painting on wood. They are the brightest colors available, and produce the extraordinary "flashing" effect described in occult documents. A basic set of colors can be purchased, and mixed as needed. Like gesso, these are water-soluble, but harden quickly, and should not be allowed to dry on brushes. Acrylic paints should be washed from brushes with soap and *warm* water (hot water is not good for brushes).

5) Allow the paint to cure for several days, then coat the wand with a clear acrylic varnish such as Grumbacher *Picture Varnish*, or Weber *Univar*. Ordinary wood varnish, shellac or lacquer should not be used.

6) Trace the four pieces of the Lotus flower onto sheet metal. A simple heavy-weight aluminum cookie sheet is adequate, and can be cut with metal shears. Those who find work with metal hopelessly difficult may cut the flower from heavy cardboard. On the other hand, those who wish to produce a very elaborate wand may cut the Lotus from wood or solid metal, cast it in metal, or even make it of clay (fired and glazed in the correct colors).

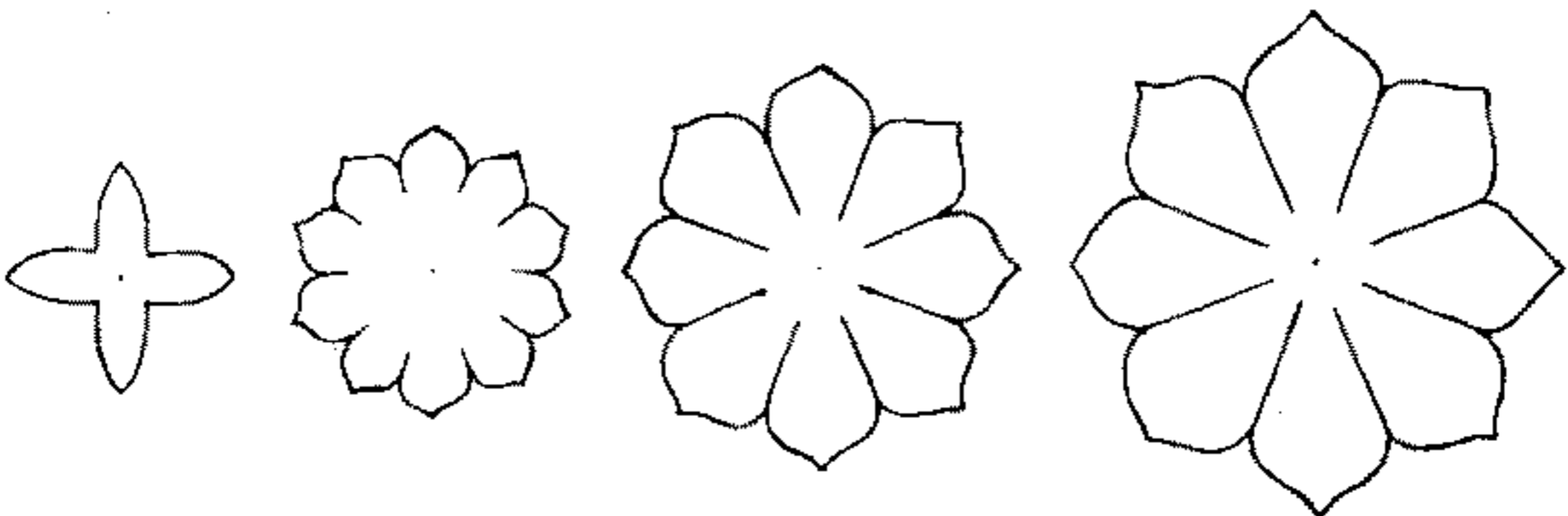

7) Cut around the outsides of the four designs, then smooth the edges with a file and emery cloth.

8) Drill a hole in the center of each of the pieces.

9) Using pliers, with cloth padding between them and the metal to avoid indenting the petals, bend the pieces so that they turn slightly inward as if in the process of opening.

10) With a spray metal undercoat paint, cover both sides of the pieces (light coats should be built up). The undercoat must then cure for about twenty-four hours, although it may be dry to the touch almost immediately.

11) Using enamel paints (acrylics will not hold to metal), color the pieces according to directions. If the Lotus is of cardboard, coat the petals with gesso, then finish with acrylics and varnish in a few days.

12) When the pieces are completely dry, attach them to the wand by inserting a small brass screw through the holes into the white end of the painted dowel rod.

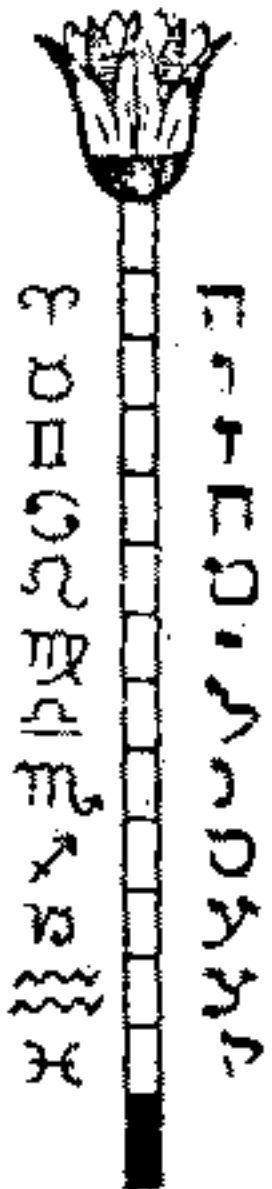

Lotus Wand

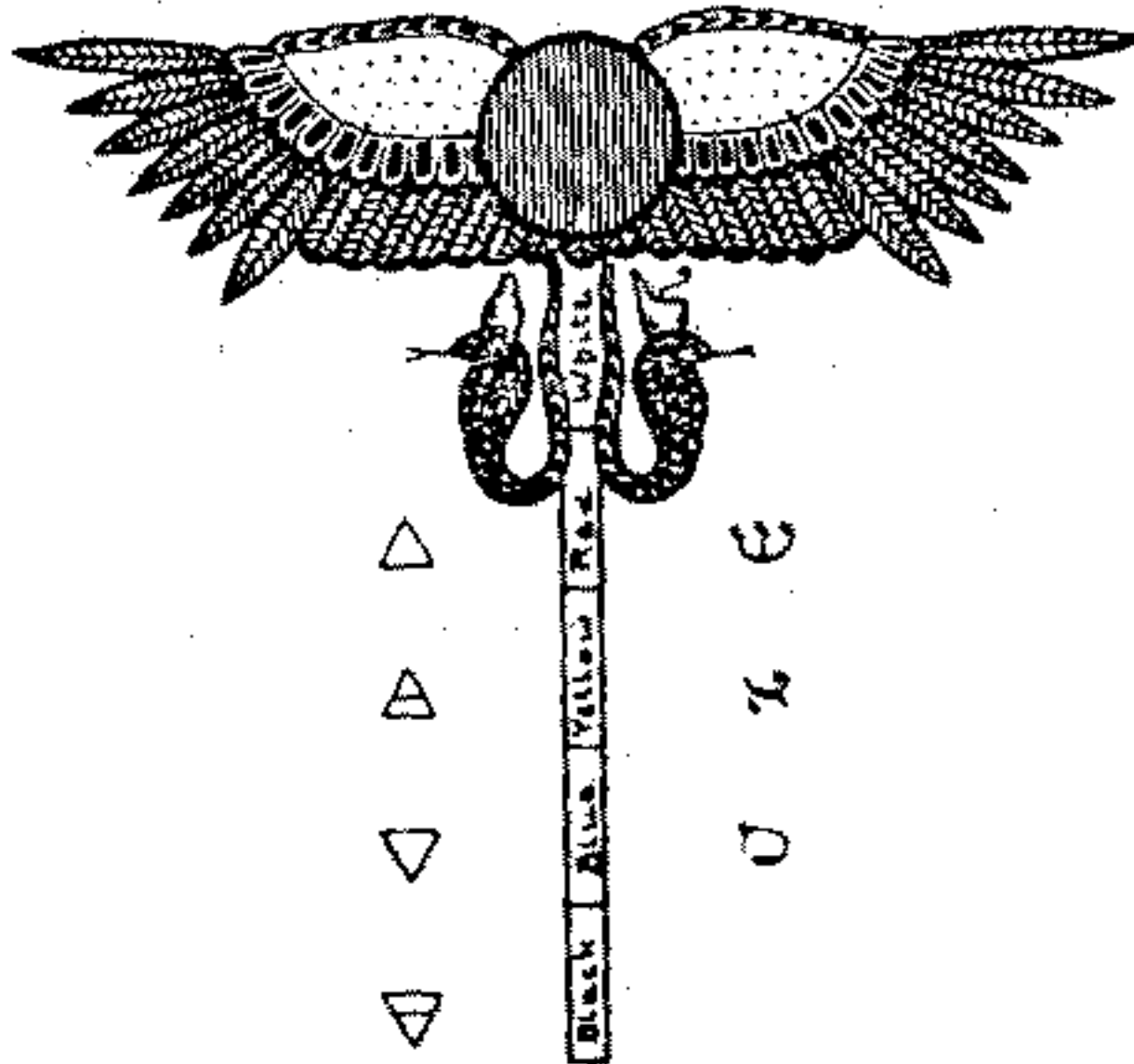

Chief Adept's Wand

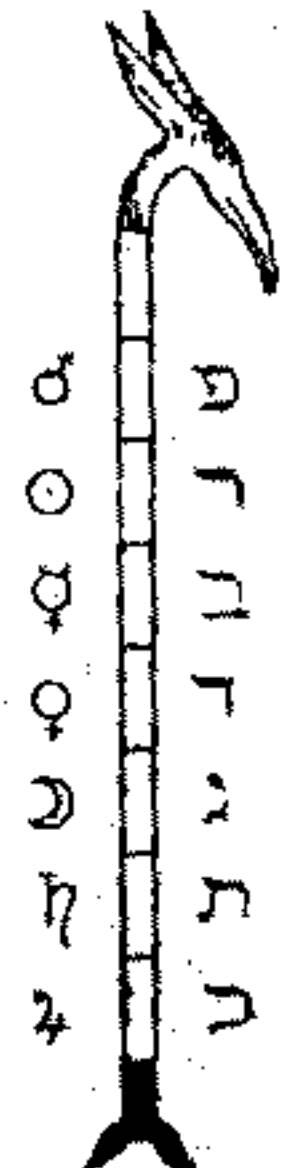

Phoenix Wand

Both inside and
outside of the petals
are white on
this piece

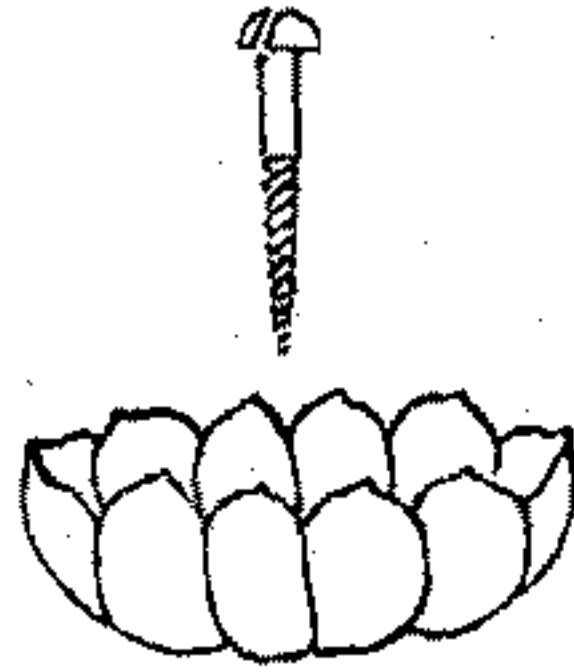

On these two pieces
the inside is
white and the outside is
olive green, with a
pattern of five veins
painted in darker
green (mix green
and black)
on the larger piece

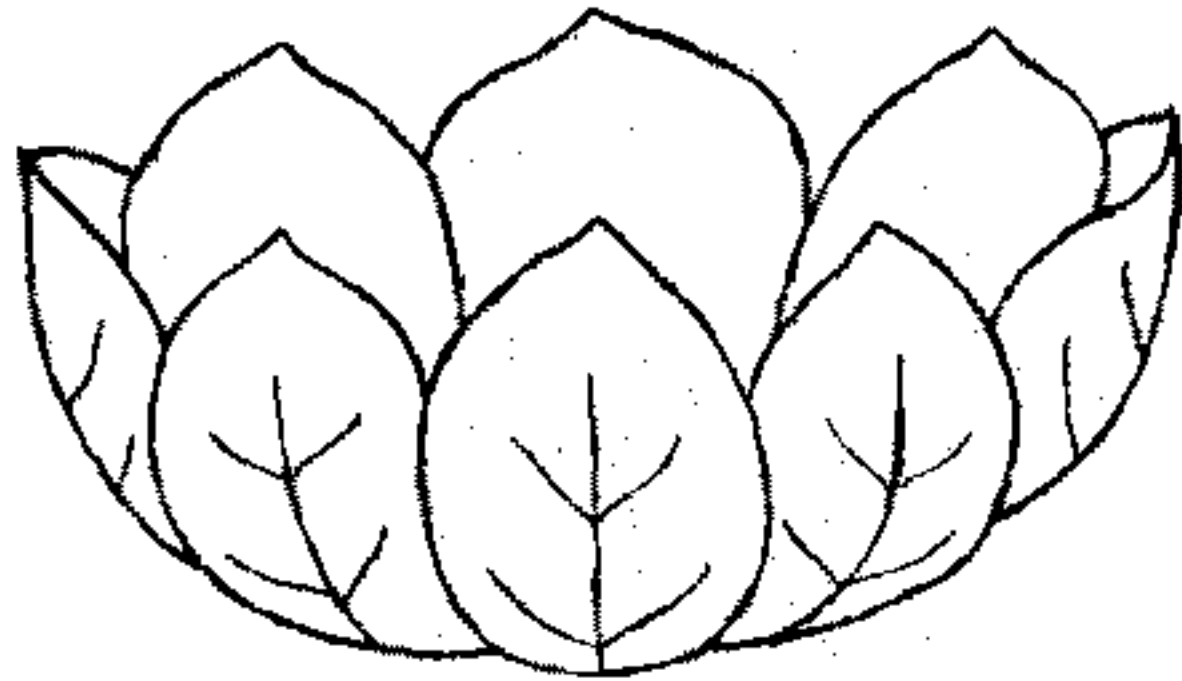
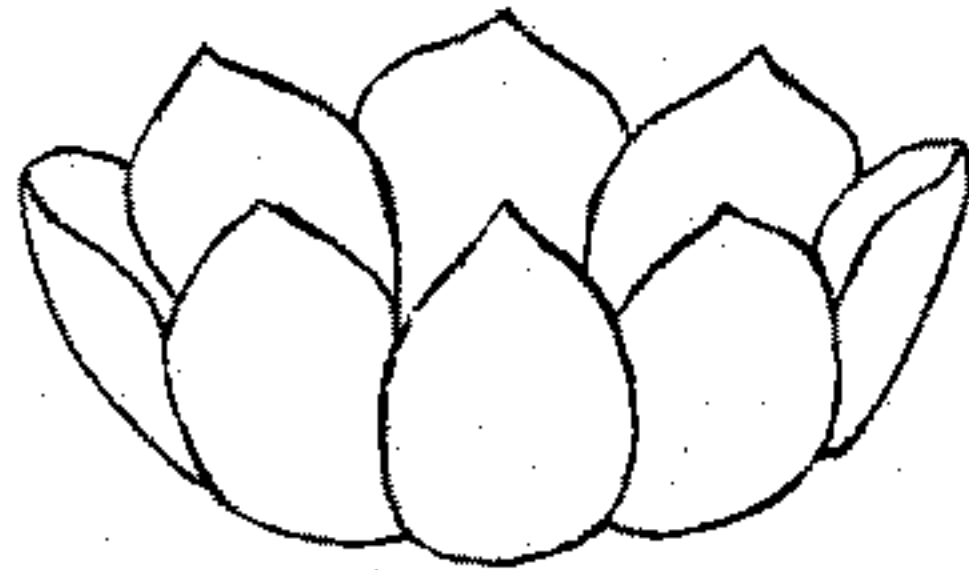

The calyx is orange
on both sides



THE LOTUS WAND

Symbolism from the Rose Cross:

<i>Path of the Tree of Life</i>		<i>Spirit</i>	
			White →
15	ה	Aries	Red →
16	ו	Taurus	Red-orange →
17	ז	Gemini	Orange →
18	ח	Cancer	Amber →
19	ט	Leo	Yellow →
20	י	Virgo	Yellow-green →
22	כ	Libra	Emerald →
24	ל	Scorpio	Green-blue →
25	מ	Sagittarius	Blue →
26	נ	Capricorn	Indigo →
28	ס	Aquarius	Violet →
29	ע	Pisces	Crimson →
		Earth	Black →

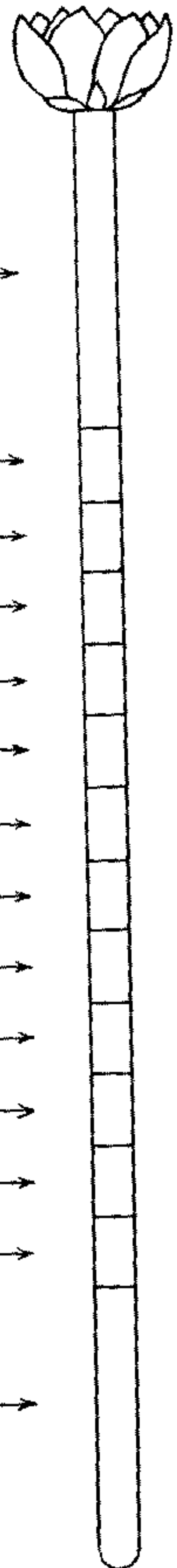

Alternative or Supplemental Wands

Once the underlying principles of the wand are grasped, it may be adapted to suit the temperament of the user. A number of variations on Golden Dawn designs may be considered.

A) Some may prefer to use the wand of the Hierophant. This is a simple shaft with four bands and a crown above. The shaft divisions refer to the five Sephiroth (including Daath) on the Middle Pillar of the Tree of Life.

A crown can be cut from soft wood or metal. Soft metals, such as brass, can be carved using a Dremel Moto Tool and metal files, which is not as difficult as some might believe.

B) An extremely simple variation of the Hierophant's wand can be painted. In this example a dowel is painted red, with five gold bands and a red crown above.

C) It is also possible to combine the qualities of the Hierophant's wand and the Lotus Wand into a very effective instrument. Here a shaft is carved of 3/4 inch dowel, representing the Serpent Kundalini on the Middle Pillar. The small Lotus is carved from a separate block of wood and painted in the standard green and white. Or it can be carved from brass and left unpainted. The base, symbolizing Malkuth, is quadripartite.

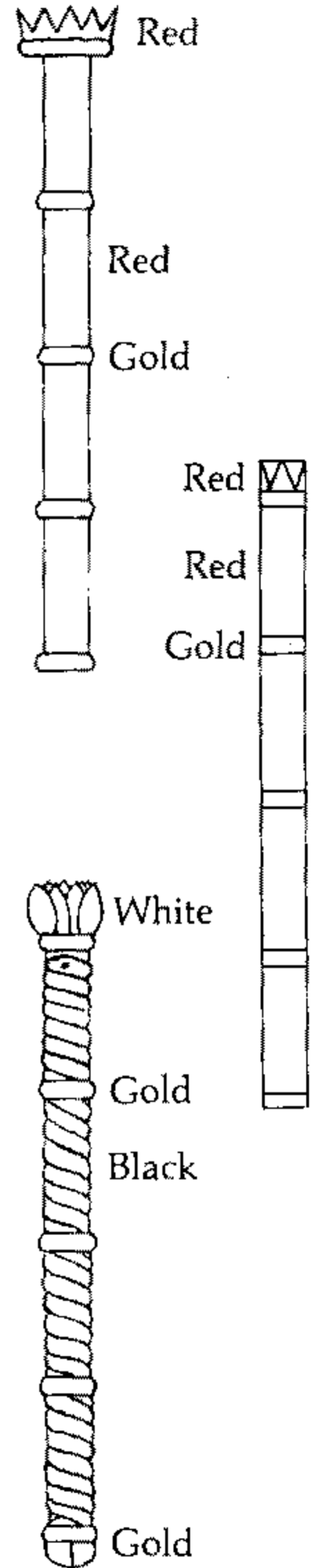

3 / The Rose Cross Lamén

This is the second of the instruments to be constructed, and from it are derived the *Sigils* painted on the other pieces. It is a symbol which synthesizes all of the concepts of Rosicrucian philosophy.

At the center is the Five-Petaled Rose on a golden cross. This represents the Qabalistic principle of the four Elements which are controlled, balanced and activated by a fifth: Fire (Yod), Water (Heh), Air (Vau) and Earth (Heh final) describe the constituent parts of the Personality, ruled by the Higher Self of Tiphareth to which the gold cross is ascribed.

The Rose also stands for the entire manifest Universe. At the highest level of the Tree of Life, Kether is the four Primordial Elements (unexpressed), set toward manifestation by the power of the Unmanifest above the Tree. This principle is explained fully in Regardie's *Golden Dawn* and in *The Qabalistic Tarot** by Robert Wang.

The twenty-two Hebrew letters around the cross are arranged according to the text of the Sepher Yetzirah: the three inner letters are the maternals, from which all the other letters (i.e., forces of the Universe) are derived. The middle circle contains the simple letters, related to the seven ancient planets. The outermost circle contains the double letters which are the signs of the Zodiac. In all, the letters are the twenty-two mystical Paths on the Tree of Life.

**Qabalistic Tarot*. Samuel Weiser, Inc. New York, 1980.

To form a sigil using the Rose, a continuous line is drawn from one Hebrew letter to the next. This is a method apparently developed by the Order of the Golden Dawn. Until the late nineteenth century, such Sigils were derived from traditional magic squares.

For example, let us take the name RAPHAEEL, the Archangel related to Air appearing on the Dagger. In Hebrew the name is spelled Resh, Pe, Aleph, Lamed (reading from right to left):

A sigil usually begins with a small circle, and ends with a short line, although this is not essential. All that is really necessary is to trace a line from one letter to the next. If there are two words in a God Name, such as ELOHIM GIBOR (for the Sword) or YHVH TZABAOTH (for the Fire Wand) two separate sigils are required.

Each of the arms of the Cross represents one of the Elements. Here it will be seen that the Hexagram (meaning six planets around the Sun) separates the Earth from direct contact with the Holy Center. This refers both to the Earth as the product of the *Fall*, and as the receptacle for all of the other Elements.

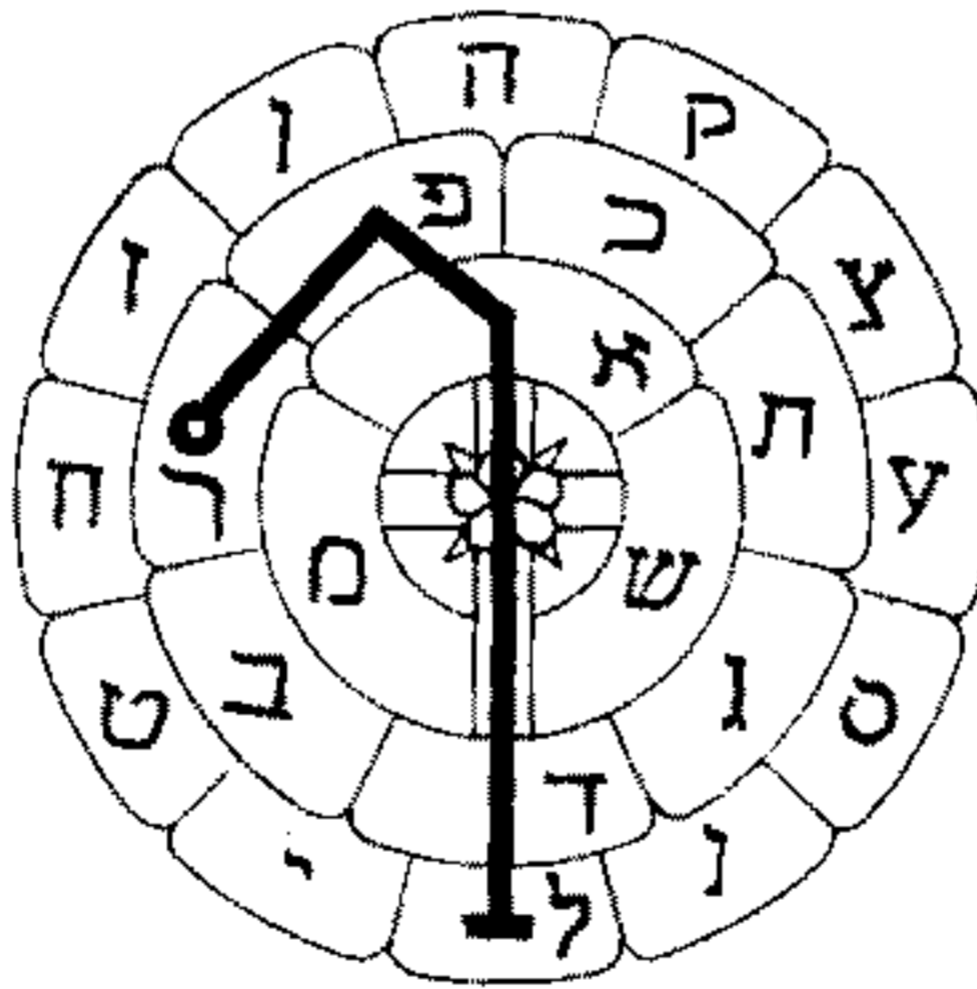

THE SIGIL FOR רפאל DERIVED FROM THE ROSE

*It should be noted that the "Ancient Cypher Manuscripts" of the Order used the traditional Elemental triangles ($\triangle \nabla \triangle \nabla$) around the Pentagrams of the Rose Cross. This older form of Elemental symbol is also shown on the Rose Cross Lamén published by Crowley in the *Equinox*. In the later period of the Order, the *Kerubic Signs*, shown in the color illustration, were adopted for use on the Lamén. It was believed that they were more effective than the triangles.

THE HEBREW ALPHABET

א		ALEPH	A
ב		BETH	B, V
ג		GIMEL	G, GH
ד		DALETH	D, DH
ה		HE	H
ו		VAU	O, U, V
ז		ZAYIN	O, U, V
ח		HETH	Ch
ט		TETH	T
י		YOD	I, Y
כ	(ך)	KAPH	K, Kh
ל		LAMED	L
מ	(ם)	MEM	M
נ	(ן)	NUN	N
ס		SAMEKH	S
ע		AYIN	Aa, Ngh
פ	(ף)	PE	P, Ph
צ	(ץ)	TZADDI	Tz
ק		QOPH	Q
ר		RESH	R
ש		SHIN	S, Sh
ת		TAV	T, Th

The letters Kaph, Mem, Nun, Pe and Tzaddi take a special form (in parentheses) used when they appear at the end of a word. No such distinction is made on the Rose Cross, and when a final letter appears, it is traced from the general point of the letter.

Cutting Out the Cross

While the Rose Cross Lamén can be cut from heavy cardboard, 1/8 inch plywood is preferable. This should be a hardwood, such as birch, which has a perfectly flat and smooth surface. Soft building plywood may form ridges when sanded, and should not be used.

1) Sand the board lightly, front and back, and coat with gesso. In all cases where wood is used, both sides should be sealed to avoid the possibility of warping.

2) When the gesso is dry, sand, apply a second coat and sand again. Sanding should always be done with a sanding block, or with sandpaper wrapped around a flat piece of wood.

3) Draw an outline of the Cross on the board.

4) With a coping saw, or an electric jig saw if one is available, cut around the outline of the Cross. A jig saw will keep the edges at a sharp right angle. But, if this is being cut by hand, care must be taken to maintain the straight cut of the blade. Accidental over-cutting is no disaster; errors are easily corrected.

5) After cutting there may be some small gaps in the sides of the plywood. These can be filled with one or more coats of gesso. Serious gaps or over-cuts must be filled with plastic wood.

6) Coat the sides with gesso. Because of the absorbency of the end grain, several coats may be required to completely seal the edges.

7) Sand the edges of the Cross.

Painting the Cross

As with the other wooden instruments, acrylic paints are recommended. A very effective metallic gold paint is also available in artist's acrylic.

There is one media problem, however, which should be considered: All paints tend to cure after a time, and new paint applied over very old paint may not adhere properly. Thus it is best that no more than a few days elapse between painting the undercolors and the symbols. If paint has been allowed to cure for some time, it should be sanded and repainted prior to adding the details.

The most exacting work can be done by those who are comfortable using a *ruling pen*. The Pentagrams and Hexagram can be drawn with great precision, using this tool and water thinned paint (thick paint will not flow from the pen), although two coats may be required for each line. The same technique can be applied to any straight line on the Cross, such as the divisions of the four Elemental colors on the lower arm.

Admittedly, the use of a ruling pen is difficult, but the more accurately the lines are drawn, the more impressive the overall effect. A pair of dividers is also useful for establishing spacing on the areas around the circle, and for precise divisions of the Pentagrams and Hexagram.

8) With compass and ruler, draw the major sections of the Cross. Eliminate the Pentagrams, Hebrew letters and other details which are to be overpainted on a color background.

9) Apply all of the background colors, including the petals of the Rose.

10) When the background colors are dry, add the details in colors which are as flashing as possible. Technically, this means using two colors which are exactly opposite each other. The opposite of red is green. The opposite of orange is blue, etc. Some experimentation with color mixing will be necessary before the best result is achieved. This is particularly the case with the Hebrew letters and their background colors.

11) Paint the back of the Cross with a white ground and black symbols. Here, for the first time, we encounter the *Motto* which is painted on each of the instruments. The principle is the same as that of an individual who enters a monastic order and takes a symbolic new name. The magical motto expresses an intention, and each student chooses one according to his or her temperament.

Following are some mottos of original members of the Golden Dawn, which should be considered as samples only. While most of these are in Latin, a motto can be in any language.

S'Rioghail Ma Dhream (Royal is My Tribe) S.L.
MacGregor Mathers
Vestigia Nulla Restrorsum (No Traces Behind) Mrs.
Mathers

Magna Est Veritat Et Praelavebit (Great is the Truth and
It shall Prevail) William Woodman

Sapere Aude (Dare to be Wise) Wynn Westcott

Demon Est Deus Inversus (The Devil is God Turned
About) W.B. Yeats

Iehi Aour (Let There Be Light) Alan Bennett

Perdurabo (I shall Endure) Aleister Crowley

Sacramentum Regis (The Sacrament to the King) A.E.
Waite

12) Once the front and back are completed, the sides of the Cross should be painted. The same acrylic gold used for the central cross is appropriate, since the Lamén relates to Tiphareth. As was undoubtedly discovered in painting the central cross, several coats of acrylic gold produce a very translucent and glowing effect.

The Colors

Extreme center of Rose = white

Rose = red

Leaves = green

Central cross = gold

Uppermost arm = yellow background, purple symbols

Left arm = red background, green symbols

Right arm = blue background, orange symbols

Bottom arm = top part: white, black symbols

bottom part: citrine (somewhat dark to accommodate the white pentagram) olive, russet, black. Symbols are white.

The colors on the Rose are those of the King Scale, and are those of the Paths attributed to the Hebrew letters in Atziluth, the World of Pure Spirit. These are found in the section of *The Golden Dawn* entitled "Concerning the Tree of Life," and in Crowley's 777.

κ	11	Bright pale yellow
Ϛ	12	Yellow
λ	13	Blue
γ	14	Emerald Green
η	15	Scarlet

א	16	Red-orange
ב	17	Orange
ג	18	Amber
ד	19	Greenish-yellow
ה	20	Yellowish-green
ו	21	Violet
ז	22	Emerald Green
ח	23	Deep Blue
ט	24	Green-Blue
י	25	Blue
יא	26	Indigo
יב	27	Scarlet
יג	28	Violet
יד	29	Crimson (ultra violet)
יז	30	Orange
יח	31	Glowing orange-scarlet
יט	32	Indigo

The opposites of all of these colors can be worked out using a color wheel.

Finish

After the paints are thoroughly cured, which should take several days, the Cross must be coated with a non-yellowing acrylic varnish such as that used on the Lotus Wand. A second coat of varnish is generally advisable.

Finally, the Cross is suspended from a yellow colarette. Silk is preferred, but a synthetic fabric is adequate. The colarette should be made of two pieces of fabric, interfaced with muslin to give it body.

The Cross is then attached, using either a heavyweight thread or a metal ring of some kind. Rug-button thread, embroidery floss or waxed jeweler's thread are all excellent for this purpose. A metal ring can be made from heavy wire, bent with pliers or a special bending jig. Metal rings are also available from jeweler's supply companies.

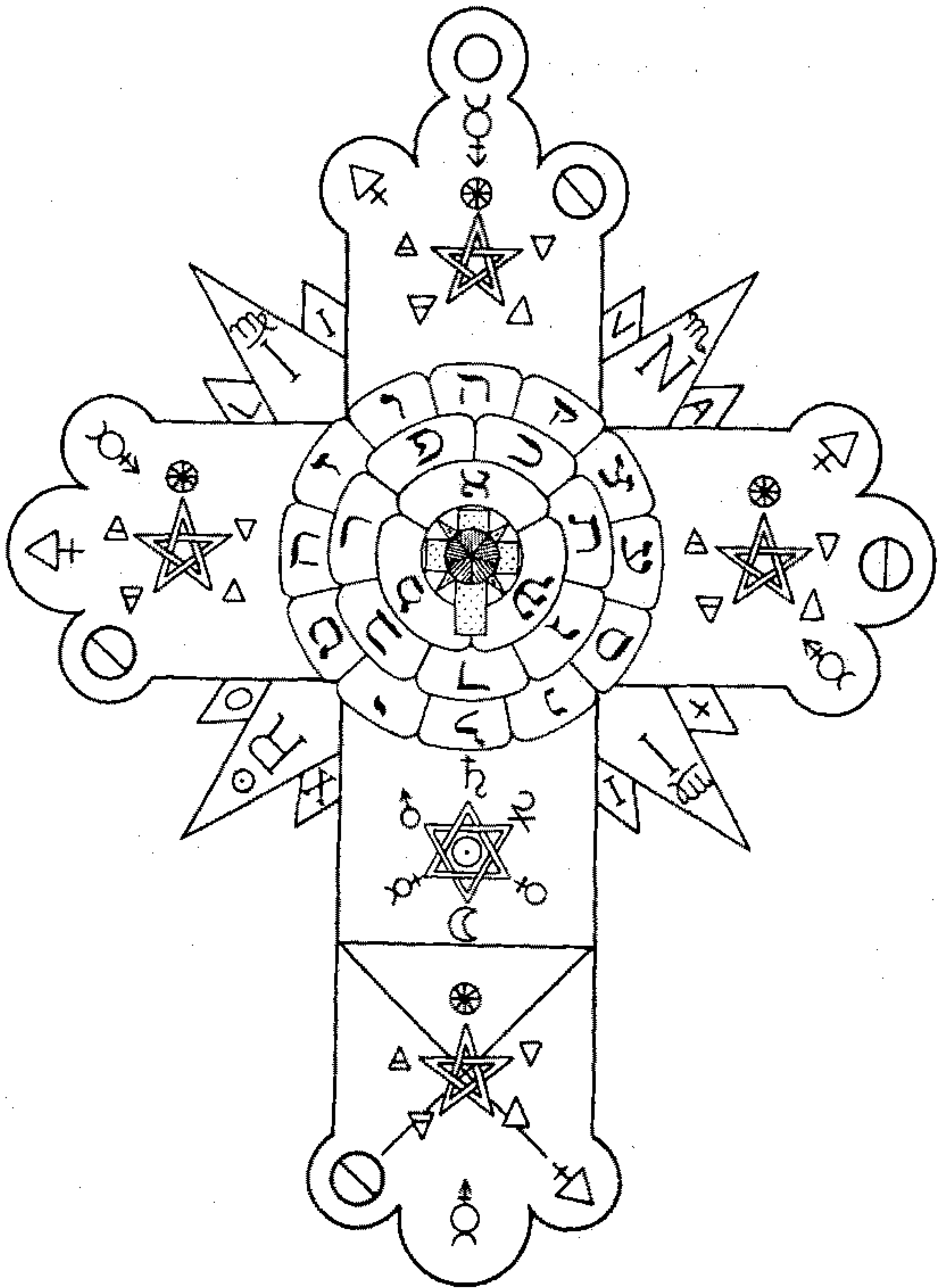

THE ROSE CROSS LAMEN

From Aleister Crowley, *The Equinox*, Vol. 1, No. 3. This is the older version of the Rose Cross, as described in the *Golden Dawn Cypher Manuscripts*, using triangular symbols of the Elements, rather than the four Kerubic Emblems.

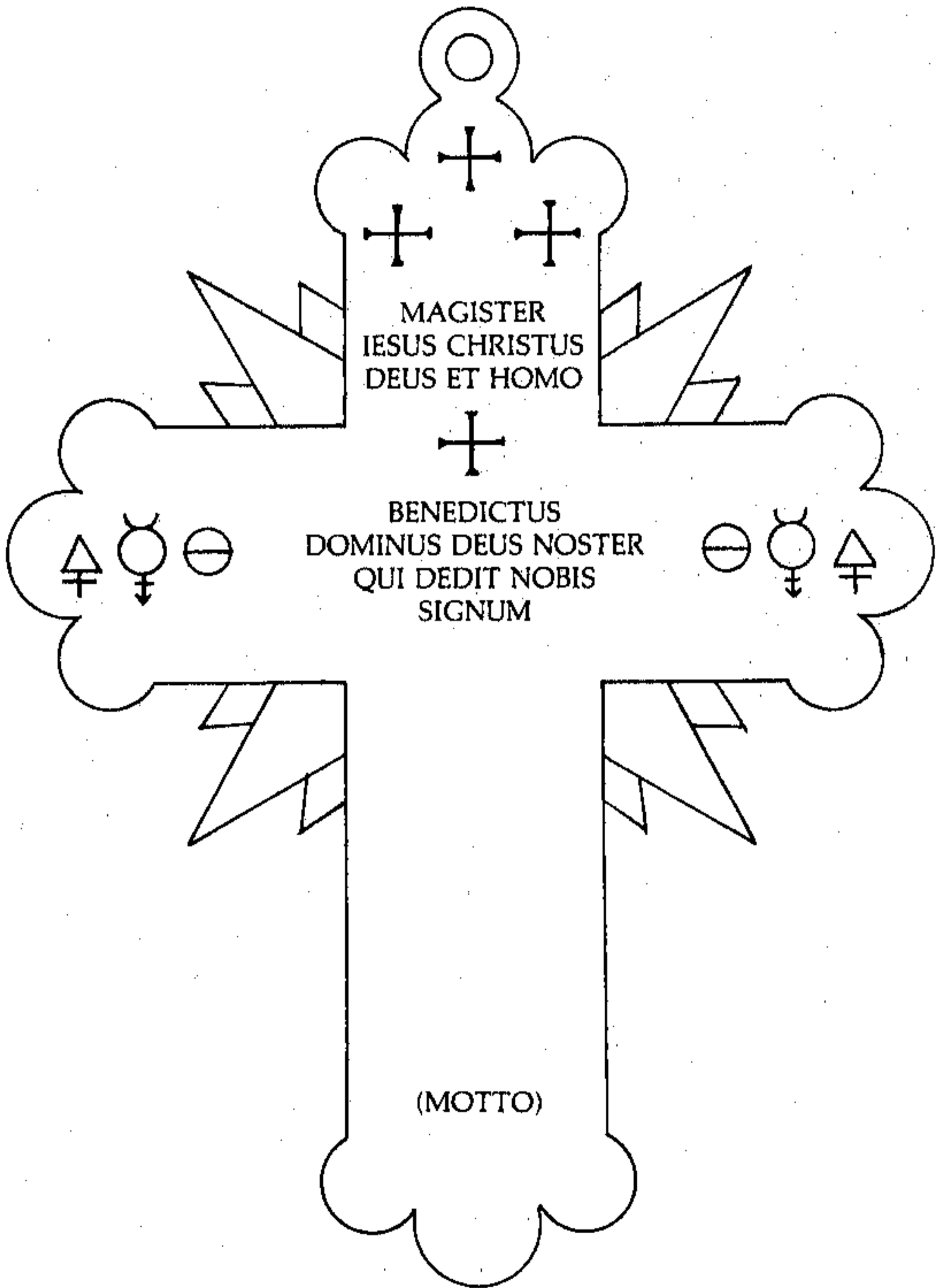

THE ROSE CROSS LAMÉN: REVERSE

4 / The Sword

The Magical Sword is used in all instances where great force in invocation, evocation or banishing is required. It is an instrument relating to the fifth Sephira, *Geburah* (Strength) on the Tree of Life. Thus, the *Pentagram*, or five pointed star is one of its key symbols.

The assumption will be made that very few readers of this book are blacksmiths, and that those who are will require no instruction on forging their own sword from solid metals. Most of us find it necessary to purchase a sword, and paint it according to the traditional directions.

The Golden Dawn text states that: "Any convenient sword will do." However, this suggestion was made at a time when swords actually were conveniently available, being often required for Victorian ceremonial use. Swords available today in antique shops, most of which are from the nineteenth century, tend to be overly ornate and of little use because they offer *no room for painted inscriptions*. Thus, the student is advised to purchase a modern sword designed specifically for ritual use from an occult or Masonic supply house. Such swords are usually far less expensive than antiques.

Choose a sword which is not too heavy, preferably one with a wooden handle and a simple cross bar of brass. The latter should be fairly wide, to allow for the painting of symbols, God Names and sigils.

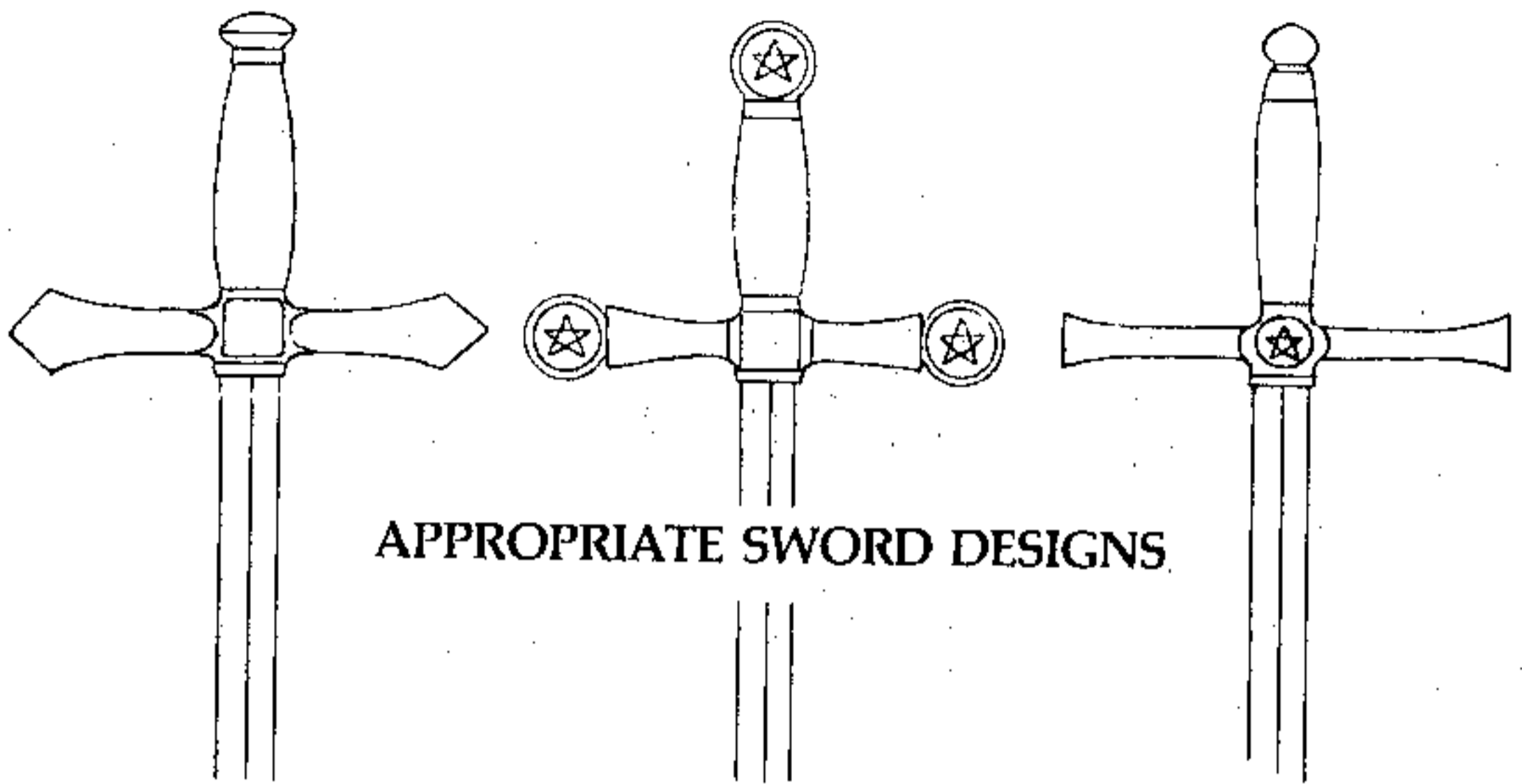

Painting the Sword

1) If the wooden handle has been coated with enamel or varnish, which is likely, remove the finish completely using a semi-paste paint remover. When down to bare wood, sand, coat with gesso and sand again lightly.

2) Rub the metal parts of the handle with medium emery cloth. This will give the metal 'tooth,' helping to hold the undercoat paint. The most serious risk in painting metals is that the paint will adhere improperly and flake off. Careful preparation of the surface, and undercoating, minimizes this possibility.

3) With masking tape and strips of newspaper, cover the blade and the gesso-coated wooden handle.

4) Spray the metal areas of the handle with undercoat. When this is dry to the touch, remove the masking and clean any areas where the paint has run or oversprayed. Then allow the Sword to dry overnight.

5) Color the handle bright red using acrylic paint. With enamel, also bright red, color the metal parts. Try to choose colors which are as similar as possible, so that the difference in media will not be obvious.

6) Paint all sigils, God Names and the Motto. These are to be a very bright green, so that they will flash on the red background. All Names are in Hebrew, and should be painted with care and respect. Each letter is, in itself, a magical symbol of great power.

After the Names and sigils have been completed, retouch as necessary, using the background reds. If a few hours elapse between painting the background and symbols, mistakes can easily be corrected. A false start can be lifted off with a cotton swab dipped in water if using acrylics, or turpentine for enamels. If this is done very carefully, the background paint will not be picked up.

There are nine sets of symbols to be applied to the Sword: seven God Names and their associated Sigils, the Motto, and Pentagrams to fit the design of the Sword:

- I) THE GOD NAME OF GEBURAH AND ITS SIGILS:
ELOHIM GIBOR
- II) THE ARCHANGEL OF GEBURAH AND ITS SIGIL:
KAMAEL
- III) THE CHOIR OF ANGELS OF GEBURAH AND ITS
SIGIL: SERAPHIM
- IV) THE HEBREW NAME OF THE PLANET MARS AND
ITS SIGIL: MADIM
- V) THE ANGEL OF THE PLANET MARS AND ITS
SIGIL: ZAMAEL
- VI) THE INTELLIGENCE OF THE PLANET MARS AND
ITS SIGIL: GRAPHIEL
- VII) THE SPIRIT OF THE PLANET MARS: BARTZABEL
- VIII) THE MOTTO
- IX) PENTAGRAMS BALANCED AROUND THE SWORD

COMPLETE INSCRIPTIONS ON THE MAGICAL SWORD

(Paint the Hebrew name followed by its sigil)



אלהים גבור
I. ELOHIM GIBOR



כמאל
II. KAMAEL



שרפים
III. SERAPHIM



מדים
IV. MADIM



זמאל
V. ZAMAEL



גראפאל
VI. GRAPHIEL

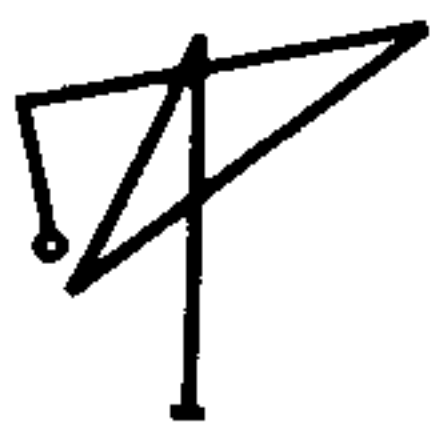

ברצבאל
VII. BARTZABEL



VIII. THE MOTTO

IX. PENTAGRAMS

5 / The Fire Wand

This is the first of the Elemental Weapons, symbolic of the Forces of the *יהוה*. The Wand, Cup, Dagger and Pentacle are also the four symbols of the Tarot.

The Fire Wand presents a special problem in that it must have a magnetic wire running through its center, from one end to the other. Here again, one may wish to simply purchase the wand ready-made, although its construction is not so difficult as it might appear.

Construction

Because the Fire Wand is approximately ten inches long, drilling from one end of a piece of dowel to the other would be a difficult task for the average craftsman. Consequently, it is expedient to saw a one inch dowel rod lengthwise, insert the wire, and glue the pieces back together.

Some writers (in discussing magician's wands) emphatically insist that to insert a wire in this way should never under any circumstances be done, because it destroys the integrity and purity of the rod. But that advice is anachronistic. The seventeenth, eighteenth and nineteenth centuries saw the publication of many books purporting to describe the tools of magical work. The supposed requirements were so stringent as to discourage those who lacked sufficient commitment to the real task of spiritual development. We may suppose that those who

refused to be discouraged, and who were intended to follow the ritual Path, found guidance in understanding what is and what is not actually important.

1) With a coping saw, cut a carefully-braced 1 inch by 10 inch dowel rod in half lengthwise. This is best done with a small vice, an inexpensive piece of equipment which is a *must* for constructing these instruments, at least for those who do not consider the sudden removal of a finger a significant part of their magical training.

2) Take a piece of steel wire 1/16 inch in diameter by 10-1/8" long, and repeatedly move a strong magnet across it in one direction, until it becomes sufficiently magnetic that it will pick up a pin. The end which *attracts* the pin will go at the conical end of the wand.

3) Cut a slight groove in both pieces of the rod, so that the wire will fit into it.

4) Insert the wire so that it extends 1/16 inch at each end.

5) Apply a very thick glue, such as Hideskin, to both pieces of the wand. This heavy glue will compensate for the wood lost in cutting the rod apart.

6) Push the two pieces together lightly, so that some glue is squeezed out, and the original cylindrical form of the rod is restored.

7) Allow the wand to dry overnight.

8) Fill gaps with plastic wood and/or gesso, allow to dry thoroughly and sand.

9) Measure the sections of the Wand, marking them with pencil. A rolled piece of cardboard will serve here, as it did on the Lotus Wand.

10) With a wood rasp, files, knives, etc., carve the conical end piece. Then cut away the three main sections, leaving four bands.

There are, obviously, a number of ways in which this wand could be made. It could be made in two main pieces: the conical end being carved separately and glued to a 3/4 inch shaft, with subsidiary bands of cardboard or other material glued around the outside. It could also be cut on a lathe.

11) Smooth the wand first with a heavy, then with a fine sandpaper.

12) Apply two coats of gesso, sanding lightly between each coat.

13) Color the red parts of the wand using artist's acrylic paint.

14) Color the yellow bands and the Yods on the endpiece (Do not paint the bits of steel which extend from either end). Acrylic yellow tends to be very transparent, and any streaks of red underneath will show through. If there are any smeared areas of red, coat these with white acrylic and then two coats of yellow.

15) Paint the God Names and Motto in a very bright flashing green.

16) When the paint has cured completely, apply acrylic varnish.

The symbols to be painted on the Fire wand are:

- I) THE GOD NAME: YHVH TZABAOth
- II) THE ARCHANGEL: MICHAEL
- III) THE ANGEL: ARAL
- IV) THE KING: SERAPH
- V) THE RIVER OF PARADISE RELATING TO FIRE:
PISON
- VI) THE CARDINAL POINT (SOUTH): DAROM
- VII) THE HEBREW NAME OF THE ELEMENT: AESCH
- VIII) THE MOTTO

COMPLETE INSCRIPTIONS ON THE FIRE WAND

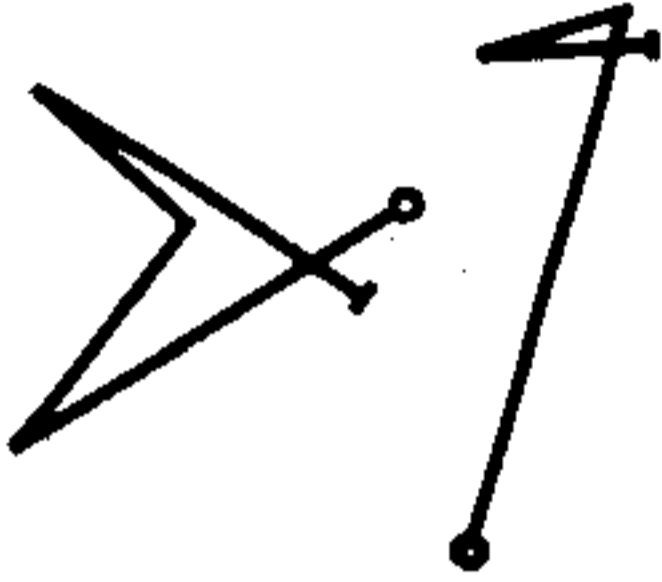

יהוה צבאות
I. YHVH TZABAOth

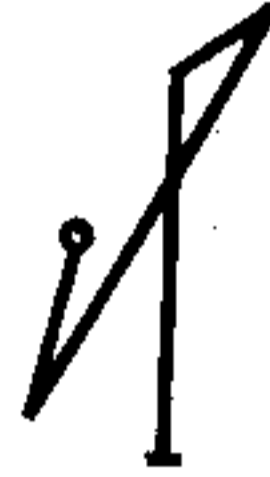

מִיכָאֵל
II. MICHAEL



אֵרָאֵל
III. ARAL

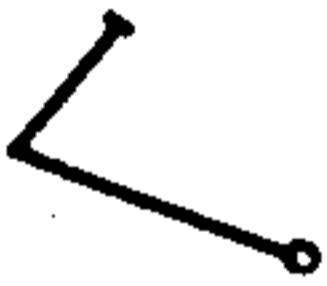

שֶׂרָפִי
IV. SERAPH



פִּישׁוֹן
V. PISON



דָּרוֹם
VI. DAROM



אַש
VII. AESCH

VIII. THE MOTTO

6 / The Water Cup

This instrument is one which may offer real challenge to those with artistic talent. The Golden Dawn instructions suggest that any glass cup (with a stem) may be used, and paper petals applied to its sides. This seems the most aesthetically unsatisfying of all possible solutions, although it appears to have been the most common method of producing the Cup.

If there were an absolute ideal, it would be a cup cast in silver and enameled. This however, for most, is as impractical an idea as cutting a sword from raw metal.

The Water Cup has eight petals which may be painted, but which are extremely beautiful if cast or carved. Carving is the most reasonable solution for those who desire the raised effect. The Cup shown in the color illustration was an inexpensive reproduction of an eighteenth century American pewter cup, cast in relatively soft metal. The petals were cut away using a *Dremel Moto Tool* and metal files, a slow and tedious process. The same result can be achieved using a wooden cup.

Another possibility is to build the cup from clay, and then fire it with the appropriate color glazes. To do this it is necessary to have some knowledge of glazes, which change colors in firing. However, many ceramic artists and art schools will offer advice, and will fire pieces for a minimal charge.

What will be described here is the process for adapting a Water Cup from some stock metal or wood cup. Those who do

not wish to carve the petals may begin with number 5 of these instructions.

This Cup should not, incidentally, be confused with the separate Cup required for the performance of a Eucharist. It is to be used specifically for operations involving the Elements, whereas a Cup (Chalice) for Eucharistic purposes is symbolic of the Christ-Buddha center of Tiphareth. By the same token, the Air Dagger is not to be used where the Golden Dawn documents call for a knife, in the Lesser Banishing Ritual of the Pentagram. Here too, a separate tool (of no special design) is required.

1) Prepare the surface of a metal or wooden cup. If a cast metal cup is used, smooth the surfaces with emery cloth and files, as necessary. If a wooden cup is used, it is likely to have been varnished. In that case the finish must be removed with a paste paint remover.

2) Measure eight equal petals around the outside of the Cup. Draw the outline of the petals using a soft pencil.

3) *On metal:* With the electric cutting tool and a fine bit, incise over the pencil lines: *On wood:* Incise over the pencil lines using an electric cutting tool, knives, or woodcut gouges.

4) *On metal:* Slowly cut away the areas around the petals, using a large, round bit. Be careful to avoid the incised lines. Then replace the large bit with a smaller one, and cut precisely to the edge of each petal. Metal files and emery cloth of different coarseness will be required for retouching and smoothing out the cuts. *On wood:* follow the same procedure if using an electric tool, or use different wood gouges as required. A wood rasp is a very useful tool for this job. Retouch the petals with files and rough sandpaper.

The cutting may be extremely simple, or it may involve considerable detail. It should be noted that petals on a wooden cup can also be built up with *Gesso Modeling Paste*. This is a medium of ground marble chips which dries very hard, but can be carved. It is often used to decorate frames. Care should be taken to build this material up in slow coats, as it tends to crack. Cracks are, however, easily filled with more of the paste, which sands to a beautiful and smooth finish.

5) Finish the surface of the Cup using fine emery cloth on metal, and fine sandpaper for wood.

6) *On metal:* With masking tape, cover all areas of the Cup except the petals. Spray the petals with a metal undercoat and allow the paint to dry overnight. *On wood:* coat the entire Cup, inside and out, with gesso. Sand lightly when dry and apply a second coat.

7) *On metal:* color the petals with a rich enamel blue. When this is dry, add the orange borders and the inscriptions. *On wood:* with artist's acrylics, paint the inside of the Cup and the area outside the petals either a metallic silver or a light blue. Then paint the petals a darker blue and the borders and inscriptions orange.

8) If using wood and acrylic colors, apply two finish coats of clear acrylic varnish when the paint has adequately cured.

The symbols to be painted on the Water Cup are as follows:

- I) GOD NAME: ELOHIM TZABAOOTH
- II) ARCHANGEL: GABRIEL
- III) ANGEL: TALIAHAD
- IV) RULER: THARSIS
- V) RIVER OF PARADISE RELATING TO WATER:
GIHON
- VI) CARDINAL POINT (WEST): MAARAB
- VII) HEBREW NAME OF THE ELEMENT: MAYIM
- VIII) THE MOTTO

COMPLETE INSCRIPTIONS ON THE WATER CUP

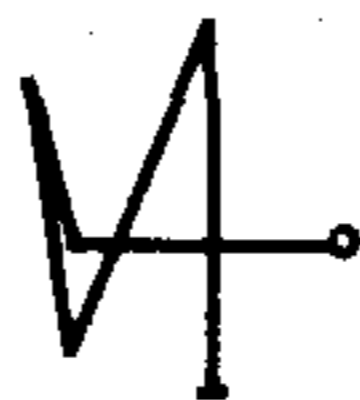
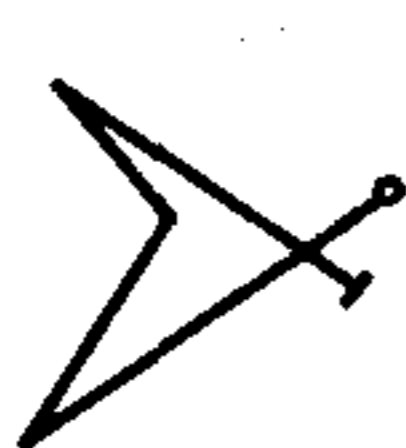

אלהים צבאות
I. ELOHIM TZABAOth

גבריאל
II. GABRIEL

טליהד
III. TALIAHAD

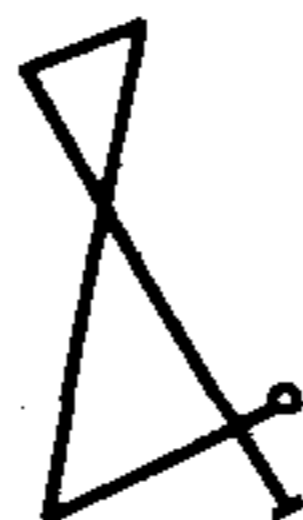
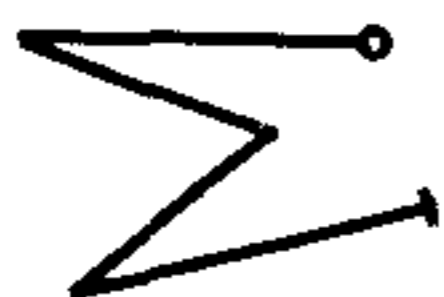

תרשים
IV. THARSIS

גיהון
V. GIHON

מערב
VI. MAARAB



מים
VII. MAYIM

VIII. THE MOTTO

7 / The Air Dagger

Like the Sword, the Dagger should be purchased in a 'raw' state, and painted according to the traditional instructions. Suggestions for painting the Dagger are precisely the same as for the Sword, including the use of acrylic for the wood handle, and enamel for the metal parts.

The background color is a bright yellow, while the color of the God Names and sigils is violet.

The Names to be painted on the Air Dagger are:

- I) GOD NAME: SHADDAI EL CHAI
- II) ARCHANGEL: RAPHAEL
- III) ANGEL: CHASSAN
- IV) RULER: ARIEL
- V) RIVER OF PARADISE RELATING TO AIR: HIDDIKEL
- VI) CARDINAL POINT (EAST): MIZRACH
- VII) HEBREW NAME OF THE ELEMENT: RUACH
- VIII) THE MOTTO

COMPLETE INSCRIPTIONS ON THE AIR DAGGER

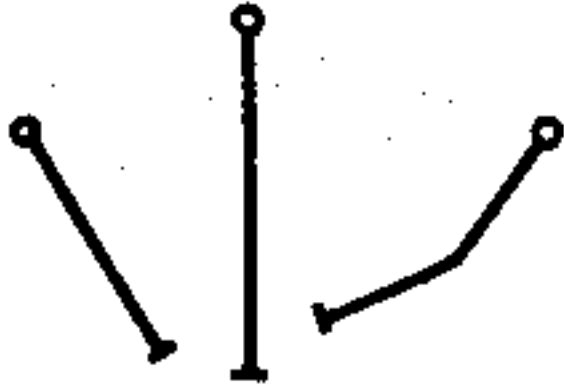

שדי אל חי

I. SHADDAI EL CHAI



רפאל

II. RAPHAEL

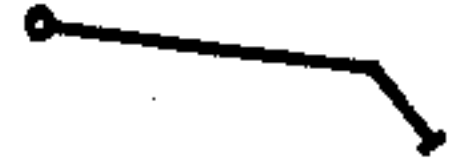

חשן

III. CHASSAN



אריאל

IV. ARIEL

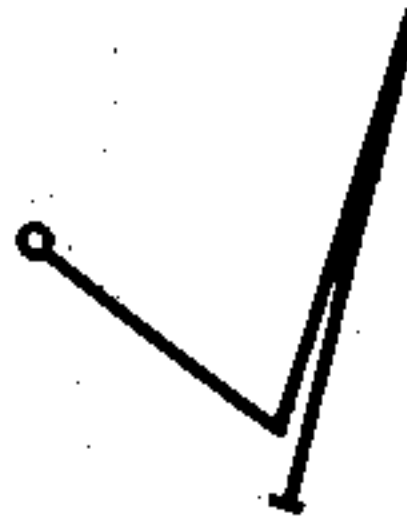

הדקל

V. HIDDIKEL



מזרח

VI. MIZRACH



רוח

VII. RUACH

VIII. THE MOTTO

8 / The Earth Pentacle

Of all the instruments, the Pentacle is the most easily constructed. It is nothing more than a painted disk of plywood, which can be purchased ready-cut from a hardware, hobby, or lumber dealer. If such a disk is not available, one can be cut with an electric circle-cutter attached to a drill, or by hand. If, however a circle cutter is used, it *must* be held in a drill press. Otherwise it is an extremely dangerous tool.

- 1) Using a compass, draw a circle 4-1/2 inches in diameter, on a piece of 1/2 inch thick birch or other hardwood plywood.

- 2) With a coping saw or electric jigsaw, cut around the outline of the circle.

- 3) Correct any imperfections in the circle with a wood rasp or file, making the edges slightly rounded if desired.

- 4) Fill any gaps or gouges with plastic wood, allow to dry, and sand very smooth.

- 5) Cover the front and back of the disk with two coats of gesso, sanding between coats.

- 6) Relocate the center hole made by the compass point, and scribe a circle around the Pentacle, with approximately the spacing shown in figure A. Then draw a † at the center of the circle. Finally, with dividers, separate the circle into six even parts, beginning at the intersection of the top of the circle and the verticle line of the cross.

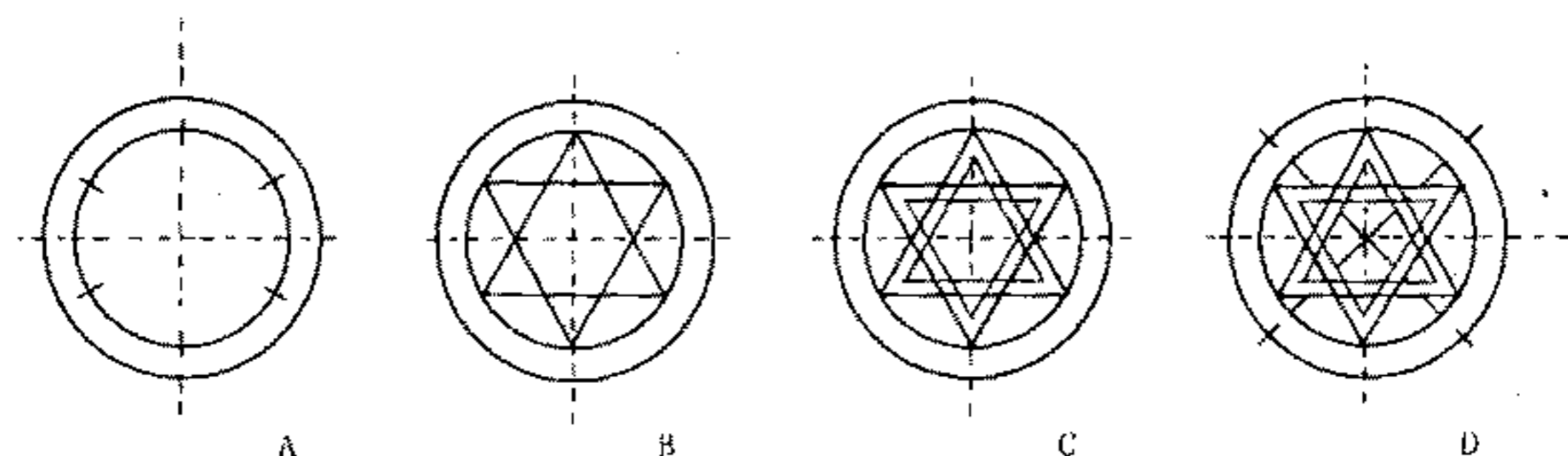

7) Draw lines connecting the six points, as shown in figure B.

8) Draw a second set of lines inside the first, as shown in figure C.

9) Divide the quarters created by the cross in half, then draw lines from these points, creating a second, diagonal cross to be painted in the four colors of Malkuth. This is shown in figure D.

10) Repeat the process on the opposite side of the disk. Here some trial and error with the compass may be required to locate the exact center of the disk, as is necessary to draw the outer circle.

On both sides the central compass hole should be well-defined, sufficiently so that gesso or other paint will not fill it in completely. This is important because circular guidelines for the God Names and sigils must be drawn on top of the white border.

11) Apply the various colors:

- EDGE = white
- BORDER = white
- HEXAGRAM = white
- TOP QUARTER = citrine
- LEFT QUARTER = russet
- RIGHT QUARTER = olive
- BASE QUARTER = black
- INSCRIPTIONS = black

This can be done entirely with a small brush, but a combination of brush and ruling pen will produce the cleanest lines.

Since the *citrine*, *olive* and *russet* must be mixed from other colors, it is recommended that this be done in small pieces

of aluminum foil. The foil can be curled up into a ball, which will keep the paint from drying for some time, and available for the inevitable retouching as paint is smeared on finished parts of the Pentacle.

12) When the quardripartite central area and the Hexagram have been painted, use the compass to draw two light guidelines on the white outer band. The inscriptions are then painted between these guidelines. When the inscriptions are dry, the guidelines are easily removed with a kneaded eraser, or touched-up with white paint.

13) After both sides of the Pentagram have been painted and allowed to cure thoroughly, apply two coats of clear acrylic varnish. This varnish is washable, which is especially important here, as the Pentacle may pick up finger smudges over a period of use.

The Names to be painted on the Earth Pentacle are:

- I) GOD NAME: ADONAI HA-ARETZ
- II) ARCHANGEL: AURIEL
- III) ANGEL: PHORLAKH
- IV) RULER: KERUB
- V) RIVER OF PARADISE RELATING TO EARTH:
PHRATH
- VI) CARDINAL POINT (NORTH): TZAPHON
- VII) HEBREW NAME OF THE ELEMENT: ARETZ
- VIII) THE MOTTO

COMPLETE INSCRIPTIONS ON THE EARTH PENTACLE

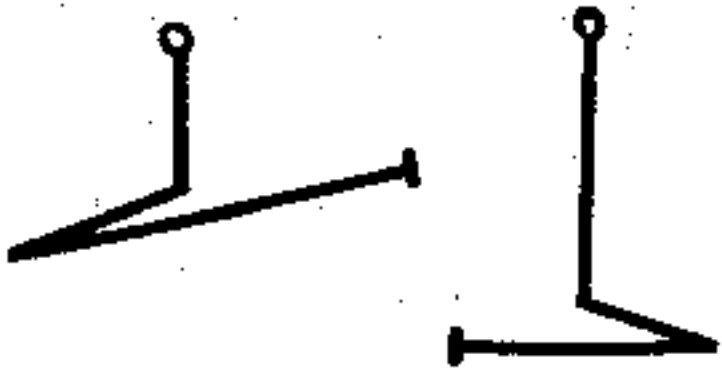

אדני הארץ
I. ADONAI HA-ARETZ



אוראל
II. AURIEL

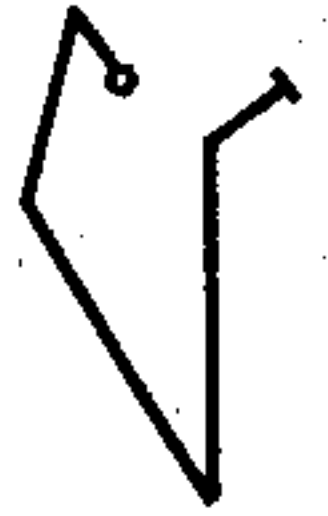

פורלאך
III. PHORLAKH

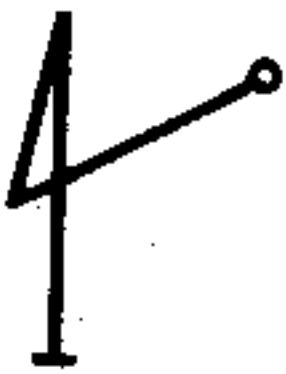

כרוב
IV. KERUB



פרת
V. PHRATH

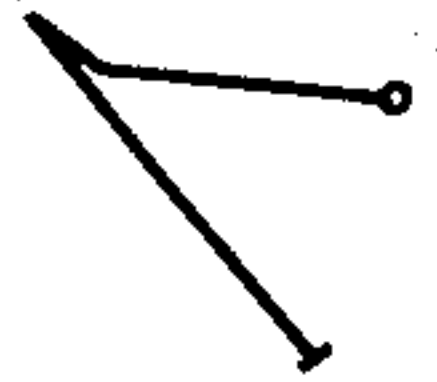

צפון
VI. TZAPHON



ארץ
VII. ARETZ

VIII. THE MOTTO

Wrapping the Instruments

As each instrument is completed it should be wrapped, although this must not be done until the paint and varnish have thoroughly dried. Appreciating that the instruments are charged in their manufacture, it is advisable that they be wrapped as soon as possible to contain whatever energies have been bestowed to the piece. Of course, *an instrument must be wrapped after it is has been ritually consecrated.*

Instruments are traditionally covered with an appropriate colored silk, i.e., red for the Sword and the Wand, blue for the Cup, yellow for the Dagger, black for the Pentacle, white or gold for the Lamen and white for the Magician's Wand. Silk has some unusual insulating qualities, which serve to contain the charge held by the instrument.

Unfortunately, silk has become very expensive and few fabric stores today carry it, even in white. This being the case, linen, a natural fabric which serves almost as well, is recommended. The most practical linen is off-white rough weave, which has the added advantage of being extremely easy to sew; large stitches are not obvious.

A separate bag or hemmed cloth must be made for each of the instruments. This may be designed so that it is tied with a cord, folds over at the top, or is sealed with a snap or zipper. If, however, a zipper is used, it should be inserted in such a way that it cannot possibly scratch the paint on the instrument. Bags may also be lined, in color if desired. Any fabric, such as an inexpensive acetate, is acceptable so long as the outer material is pure linen or silk.

Part II / The Temple

9 / The Temple

It might be safe to guess that in the Victorian era more of those pursuing esoteric ritual had their own private Temples than do today. Houses were large, and the late nineteenth century architectural aesthetic dictated that living space have a certain beehive quality. So to find an unused room and lay claim to it may not have been such a luxury.

Today apartment living and houses of two or three carefully-planned bedrooms is the norm. And to consecrate an entire room for ritual and meditative purposes may be all but impossible. Those who can prepare such an individual space can count themselves very fortunate. Those who cannot must exercise ingenuity: some may have an Altar which sits inconspicuously disguised in the corner of a livingroom. Others may choose to build an elaborate cabinet which closes off when not in use.

For the person living alone, or with a spouse who is either sympathetic or shares these convictions, finding space may be the primary difficulty. But for those with curious children or fundamentalist Christian relatives, the less that is obvious, the better.

There are four possibilities, here offered in order of their respective worth:

- 1) Set aside a separate room. Only the student should enter this room, or those who are sharing meditative and ritual

exercises. In this case a very complete Temple can be developed, with a central Altar, large columns and Enochian Tablets permanently affixed to the walls at the four Cardinal points. This is the ideal. There is really no substitute for a room which is duly consecrated and sanctified through frequent use. It becomes a silent and sacred place which effects a transformation on the person who enters it.

2) Design a large cabinet into which can be fit an Altar, columns, Banners, etc. It is best to purchase an old cabinet and adapt it as necessary. Such cabinets are readily available through antique dealers, and usually at good prices since they were made for the larger homes of the past and are now in small demand. A cabinet should be chosen which is built very low to the ground, or which can be adapted to move the Altar in and out of it easily. Many rituals require what is called *circumambulation* of the Altar, a complete circling of the Altar which invokes or banishes the Light, depending upon the direction of movement.

In the suggested design, the Pillars and Altar are on a moving platform which can be wheeled into the center of a room as necessary. The Banners of the East and West are stored beside the platform, rather than on it and are positioned according to the different rituals. The Pillars, also can be moved from the platform as required.

Normally, instruments are stored at the back of the Altar. However in this case, they are stored at the front to permit access when the Altar is in the cabinet.

3) An Altar may be constructed which houses all of the instruments, two miniature columns, the Banners and Tablets, and other miscellaneous equipment. Such an Altar may be wheeled in and out of a closet. Or it can be designed in such a way that it appears to be an ordinary chest, decorating a room.

4) The last suggestion is for those who have no way whatsoever to house an Altar.

It is important, at very least, that the instruments be stored in some way which is 'special.' They should not merely rest in a dresser drawer, but should be kept so that they are separated, conceptually, from daily life. It is possible to create a very effective Temple without a formal Altar, and using completely portable materials.

SUGGESTED DESIGN FOR A TEMPLE CABINET

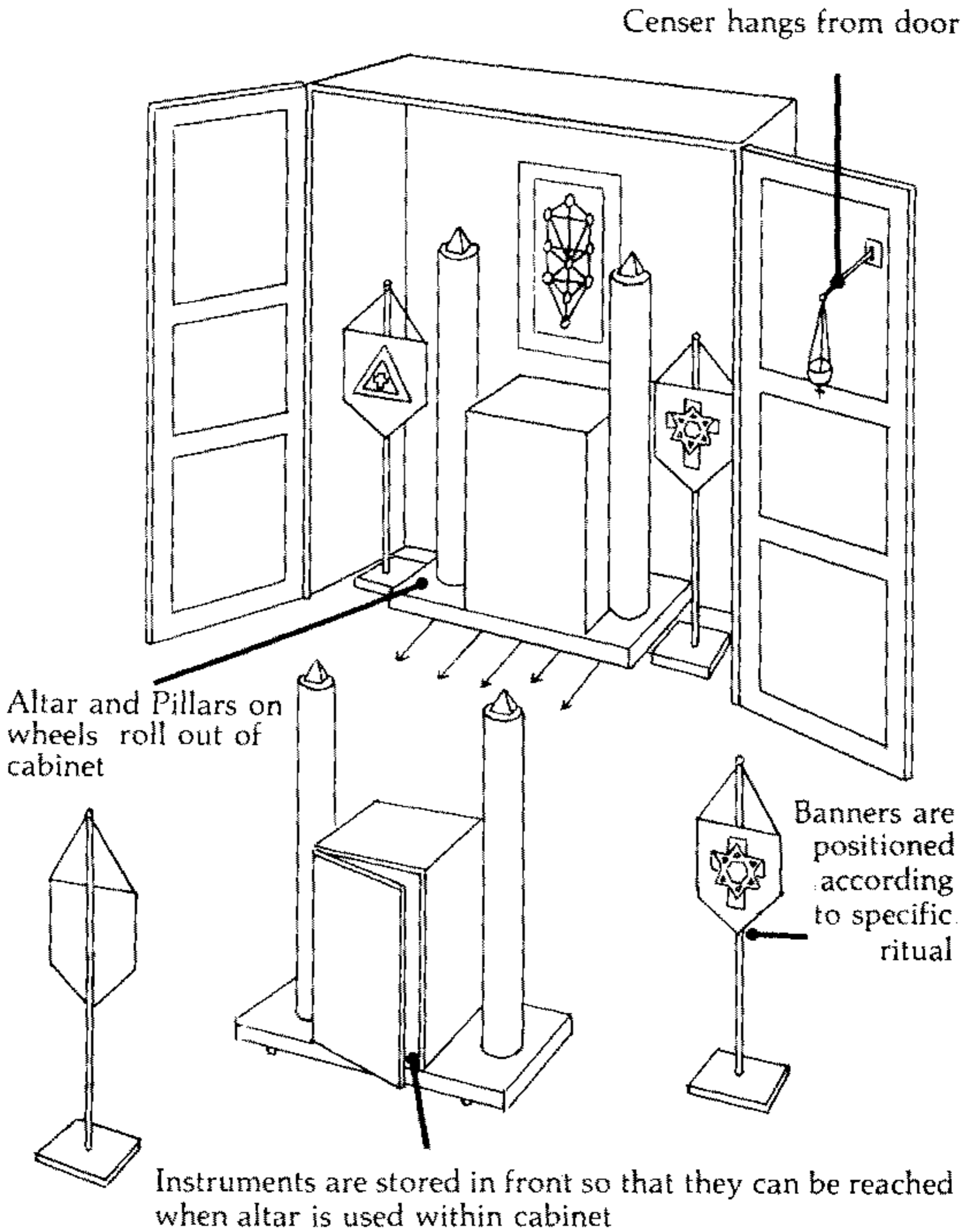

The description which follows here is of the construction of a complete private Temple according to the Golden Dawn Tradition. While the various elements may be simplified to the

extent that they will fit into a small trunk, they may also be expanded in detail and majesty such as to be the worthy Temple of an occult order.

10 / The Altar

The Altar of the Mysteries is a double cube, painted black. It refers to Malkuth, the base Sephira on the Tree of Life. Thus it is understood that while it appears black overall, the four sides are to be visualized as being Citrine, Olive, Russet and Black, respectively.

It is not necessary to actually construct two separate cubes, and link them together, as the "double cube" refers to dimensions. In fact, space must be left behind the Altar for storage of the Magical Instruments, as the Sword is so long that only the full length of the Altar would contain it.

1) Cut or purchase six pieces of 1/2 inch birch plywood in the following dimensions:

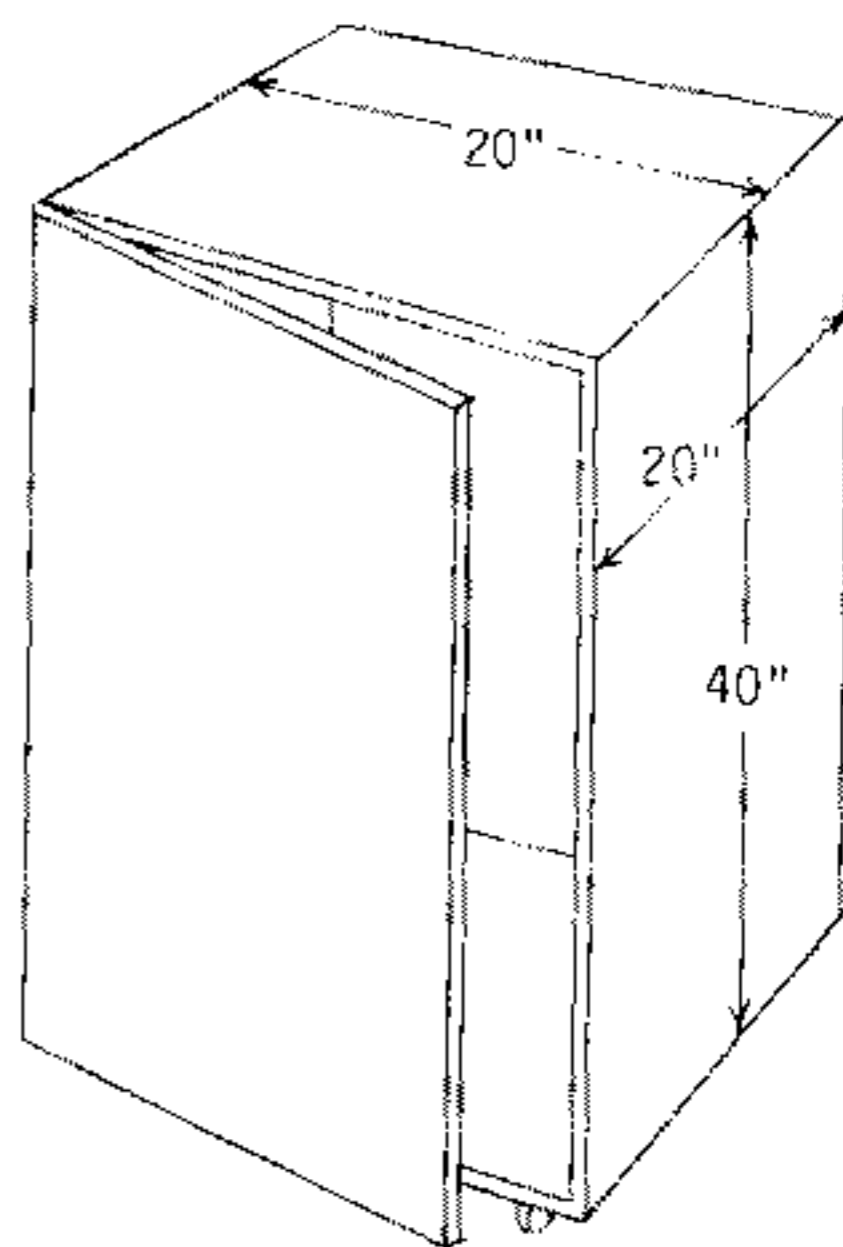

2) Drill screw holes, and gouge areas for counter-sinking (insetting of the screw head). Then assemble the pieces with screws and wood glue.

3) Attach the door with hinges and a small latch.

4) Attach wheels on flat plates to the bottom.

5) Fill the counter-sunk screw holes with plastic wood, patch as necessary and sand when dry.

6) Apply undercoat, then one or more coats of black enamel.

Altar Coverings

It is not necessary that the Altar be covered, but a cloth of some sort will make it significantly more attractive. Moreover, a student who has no Altar may find an Altar cloth, whether simple or elaborate, very useful.

The more the Temple, whether a permanent room or entirely portable, is set apart, the more effective it becomes. And the student who lavishes attention on the preparation of a cloth will find that it lights up the environment whenever it is unfolded and spread onto the simplest table. The cloth, in effect, becomes the Altar.

The Banners of the East and West, to be presently considered, are a difficult craft project, even for those with considerable sewing experience. Such is not the case with an Altar cloth, which can be nothing more than a large black square with hemmed edges. The most ornate borders of gold are available by the yard in fabric stores, and are quite inexpensive and easily applied by hand or by machine.

The Altar illustrated in color has two coverings, both of which are simple black material with stock border decorations applied. The Rose of Five Petals, surrounded by the emblems of the Four Kerubim, is hand-embroidered and represents one individual approach to the Altar covering. A black cloth with no decoration whatsoever is acceptable, but the more attention to detail, the more there is a psychological separation from daily life, and the more attention is directed to the inner realities which the Temple represents.

It must never be forgotten, however, that no matter how beautiful the instruments and the Temple we create, they are

merely a means to an end. We mold these things from dust, and, like us, they will return to the dust from which they were created. They served us for a split second in eternity.

11 / The Lamp

Traditionally, an oil lamp burns above the Altar as a sign of the Illuminating Divine presence. Such a lamp is an extremely basic device, consisting of nothing more than a shallow bowl filled with oil and a wick. A piece of heavy string will serve as a wick, and olive oil can be burned.

The lamp pictured in the color illustration is a Temple lamp, made in France. The small cup which hangs beneath it collects oil which drips slightly over the lip. Such lamps are still being manufactured.

12 / The Censer

Incense is extremely important to ritual, and two forms of incense holders are required. The first is a dish filled with sand, used to hold sticks of incense for rituals such as that of the *Rose Cross*. The second is the censor, a part of the Temple furniture which hangs in the West or north-west corner of the altar.

A piece of self-starting charcoal, sold in church supply stores, is placed in the censor, ignited, and incense such as frankincense dropped on top of it. It should be added that very little charcoal is required, particularly in a small space. Large charcoal blocks intended for church use should be broken into small pieces. Naturally, care should be taken in the use of charcoal since it releases dangerous carbon monoxide; adequate ventilation must always be provided.

It might be mentioned, parenthetically, that one authority believes some of Eliphas Levi's visions to have been the result of carbon monoxide poisoning, which is certainly possible. The least that can be stated with scientific certainty is that burning vast amounts of charcoal in a small, unventilated, space may lead the occult student to a longer out of the body experience than had been planned.

An elaborate censor can be purchased at a church supply store, although it is likely to be quite expensive. And the unfortunate fact is that most of the liturgical brass being produced today is of poor quality metal work, and execrable design. One

possible solution is that shown in the color illustration here: the censer was adapted from a modern chinese incense burner, intended to stand on a table. It was selected because of the fish on the cover, which is a Christ-Tiphareth symbol. Almost any small incense burner can be made into a censer by drilling holes in the sides, and suspending it from chains.

13 / The Cross and Triangle

Golden Dawn rituals which require the use of the Elemental Weapons also require a *Red Cross* and *White Triangle* at the center of the Altar. These can be cut from thin plywood and painted, or they can be made from cardboard. A more ambitious possibility is that they be sewed onto the center of a black altar cloth, using red and white fabrics, or embroidery.

The Cross and Triangle should be no larger than three or four inches high since, when all of the instruments are placed around them on the altar, there may be little space left.

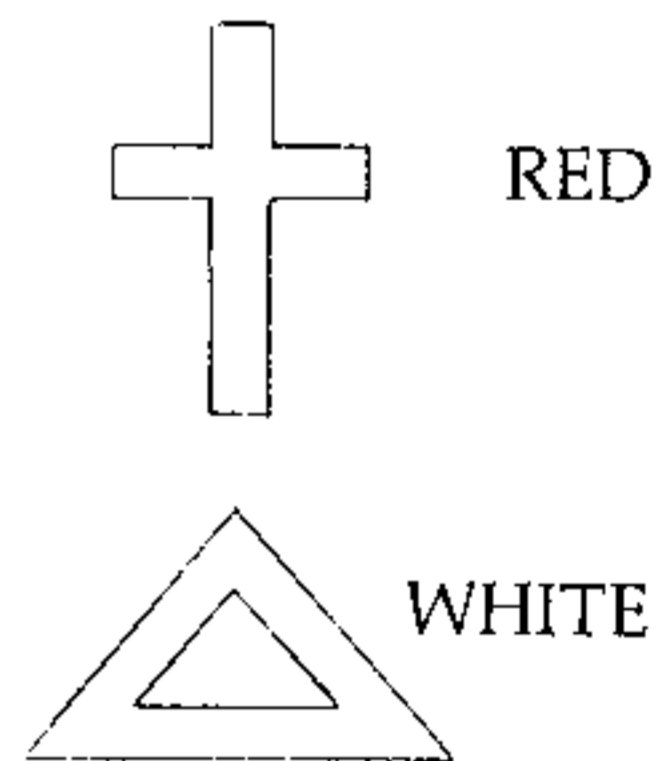

14 / The Pillars

Traditionally the Pillars stood at the doorway of the mysteries in the ancient Temple of Solomon. They represent the dualities of the earthly condition, brought into balance by the candidate who stands between them.

One is white and the other black. Both are crowned with a red triangle and pyramid having a light with a hidden source. The black Pillar is painted with white Egyptian figures, a black lotus and a black cube at its base. The white Pillar is painted with black Egyptian figures, a black lotus, and also rests on a black cube.

This describes the perfect Golden Dawn column. Those shown in the color illustration, however, are a simplified version having neither the base, inner light, nor hieroglyphic inscriptions. The Pillars may be either the most complex pieces of furniture in the Temple, or the most simple.

A Pillar may be nothing more than an upright piece of wood, round or square, on a flat base. It may be as small as two or three feet if space presents a problem.

The Complete Golden Dawn Pillars

From the standpoint of Temple construction, Americans have one special advantage, resulting from their countrymen's mania for destroying old buildings. In every major city nineteenth century row houses, with wood porches, are either being

systematically razed or renovated to exclude the porch. This means that piles of large wooden pillars are usually available in salvage yards, and at virtually give-away prices. The columns illustrated here began life on a Victorian porch in Baltimore.

Such pillars can be constructed, but that is a tedious and costly task. Of course, if a Temple is to be constructed for the use of an occult Order, cost may be less of a consideration, and designs should be turned over to a master cabinet-maker. A Temple for group work should come as close to the ideal as possible.

If old pillars are located, a number of potential problems exist. First, a great many such pillars have been stored in outside yards, and are badly rotted. These should be avoided. It will also be discovered that most of these pillars are made of hardwood strips, grooved together, and nailed to a porch base. Not only are they extremely heavy, but there is a likelihood that there will be a number of dangerously protruding, or slightly hidden, rusty nails. Carry a pair of pliers into a scrap yard, and expect to have to pull out some nails before transporting the old pillars.

The greatest difficulty is that old pillars generally have many decades of paint on them, invariably chipping off. Cleaning this paint to bare wood requires a large amount of heavy duty paint remover, and many hours. Moreover, the solvents required to handle such caked paint are extremely toxic and volatile, so work should be done out of doors if at all possible.

The most practical solution is to take the pillars to a company which specializes in removing paint from old furniture where they can be dipped or sprayed with solvent.

Beginning with clean columns, whether renovated, or built new:

1) With 3/4 or 1" birch plywood, construct two cubes (leave the bottoms open) and attach the columns securely. If using new columns, work with several very long screws and an industrial-weight epoxy cement. Older columns may be more difficult to attach, because of the unevenness of the bases, and because deterioration of the wood may have occurred. Some ingenuity will certainly be required.

2) Once the Pillars have been securely attached to the bases, fill any gaps with plastic wood. If the holes are par-

ticularly large, build up the filler, allowing several days of drying between each coat. Plastic wood may appear to be completely dry but, if applied in thick coats, may shrink disastrously over a period of weeks.

3) Sand the Pillars, first with a rough, and then with a smooth paper.

4) Build the triangular capitals with their tetrahedral tops. The triangles should be cut from one inch pine, while the tetrahedrons can be constructed from thin plywood or very heavy cardboard and paper tape. If plywood is used, the sharp edges should be filled with plastic wood or gesso modeling paste, and smoothed with files and sandpaper when thoroughly dry. The process may have to be repeated several times to produce a perfect tetrahedral form.

If desired, a small lightbulb can be incorporated into the capital, but care must be taken that there is no great build up of heat, which could present a fire hazard.

5) Coat the Pillars with a white priming paint.

6) Carefully measure, and draw the Lotuses at the bottom of each Pillar.

7) With enamel, paint one column black, and the other white.

8) Paint the Lotus flowers in the opposite color. Small brushes will be required for accurate outlines.

9) Paint the bases black, and the capitals red.

10) Paint the hieroglyphic designs as given in the following pages, black on the white Pillar and white on the black Pillar.

These are vignettes from the seventeenth chapter of the *Book of The Dead*, illustrations intended to accompany the "Hymn to the Rising Sun," slightly modified by the Order for use on the columns. The illustrations here are traced exactly from a paper written by Brodie Innes, entitled *0°-0° Grade of Neophyte Side Lecture No. 2A, Appendix to the Lecture on the Pillars* (Carr P. Collins, Jr. Collection, the Bridwell Library, S.M.U., Dallas, Texas). The lecture mentioned was a brief one by Mathers who, with Brodie Innes, founded the *A-0* after the collapse of the Golden Dawn *Isis-Urania* Temple in 1900.

These vignettes are very complicated, and few may choose to make the effort of painting them on the Temple Pil-

lars. They are included for the benefit of individuals or groups who are following the Golden Dawn methods down to the most careful detail.

BLACK PILLAR

WHITE PILLAR

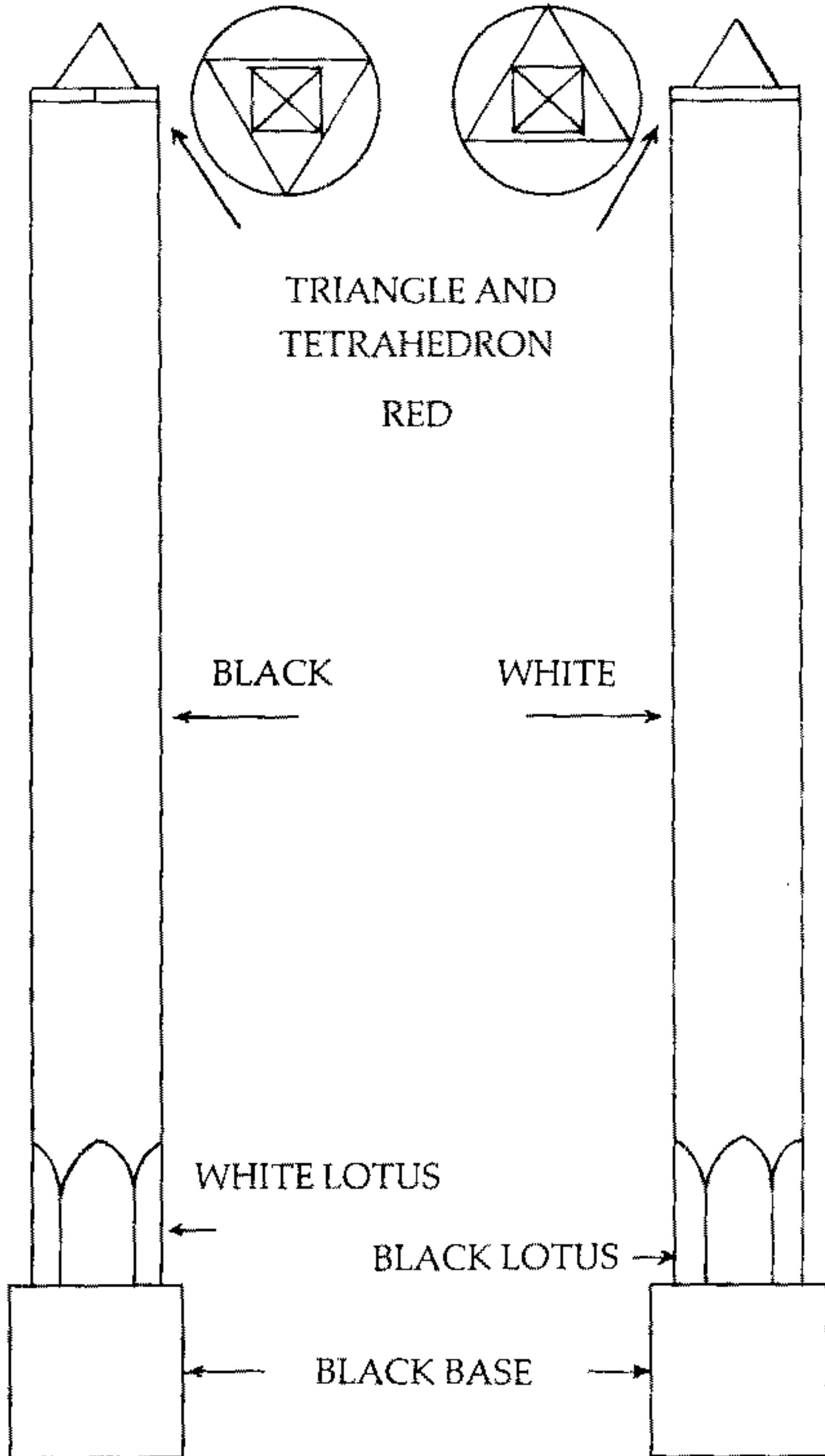

WHITE COLUMN: UPPER SECTION OF EGYPTIAN SYMBOLS

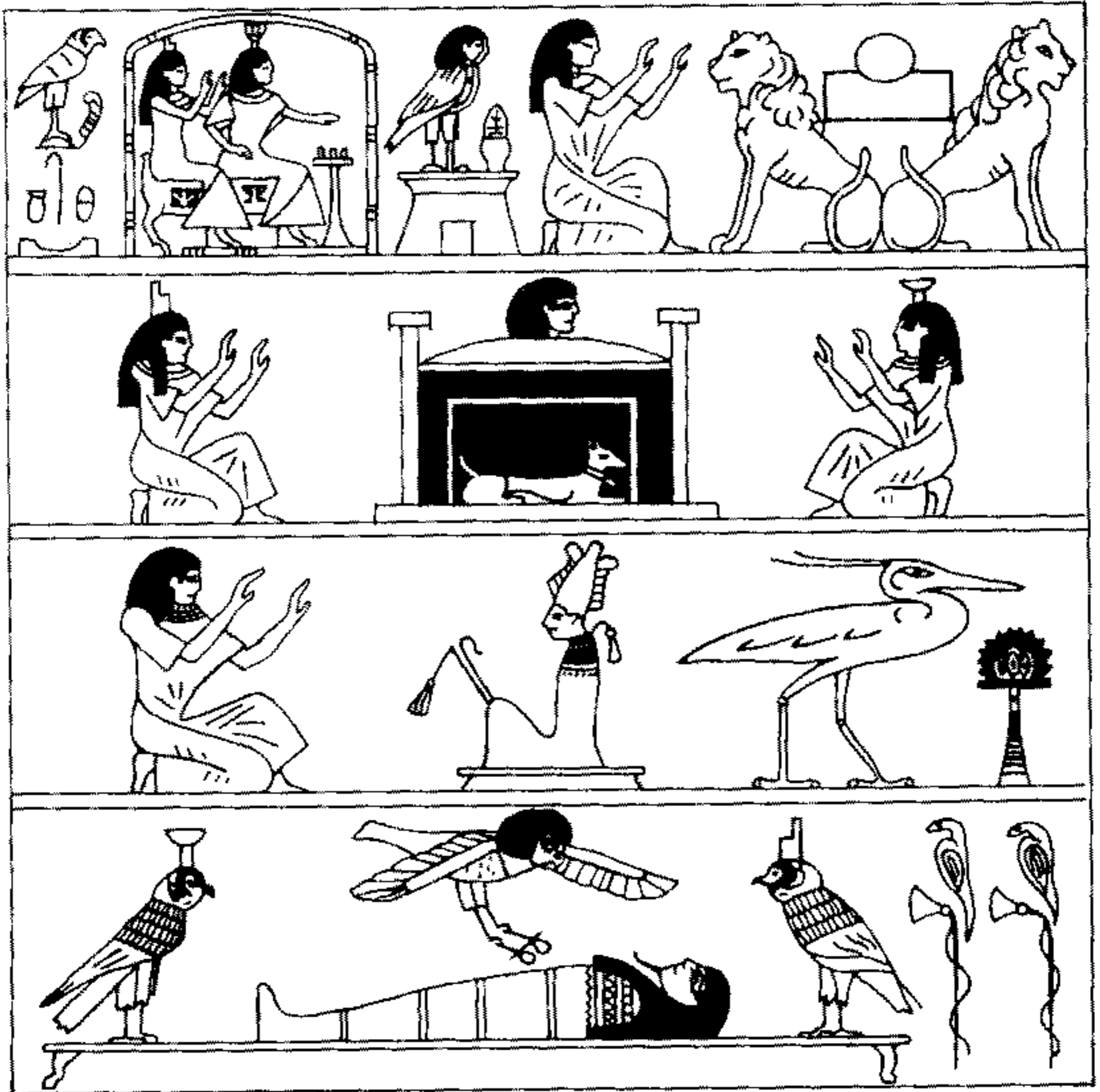

WHITE COLUMN: CENTRAL SECTION OF EGYPTIAN SYMBOLS

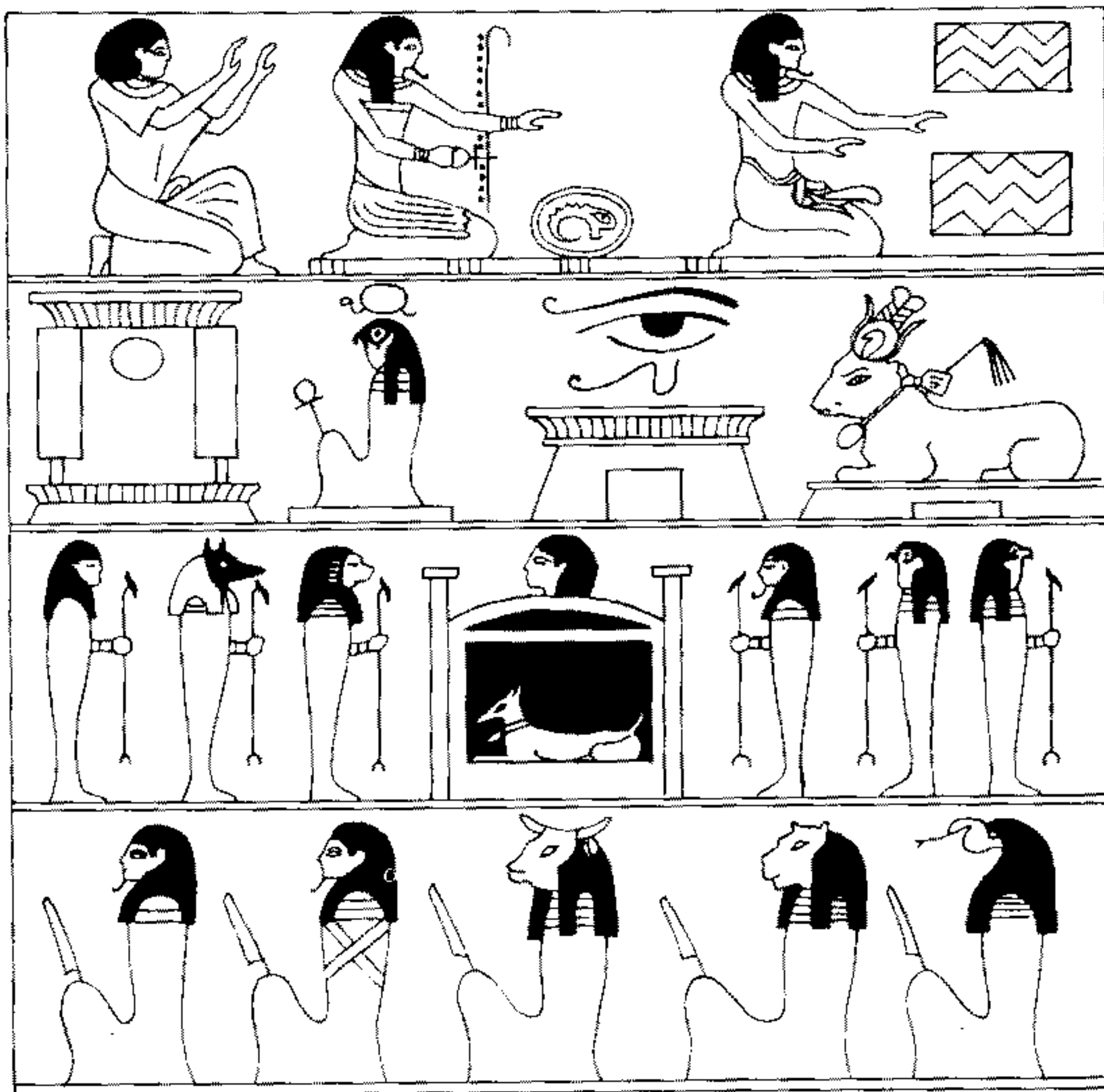

WHITE COLUMN: LOWER SECTION OF EGYPTIAN SYMBOLS

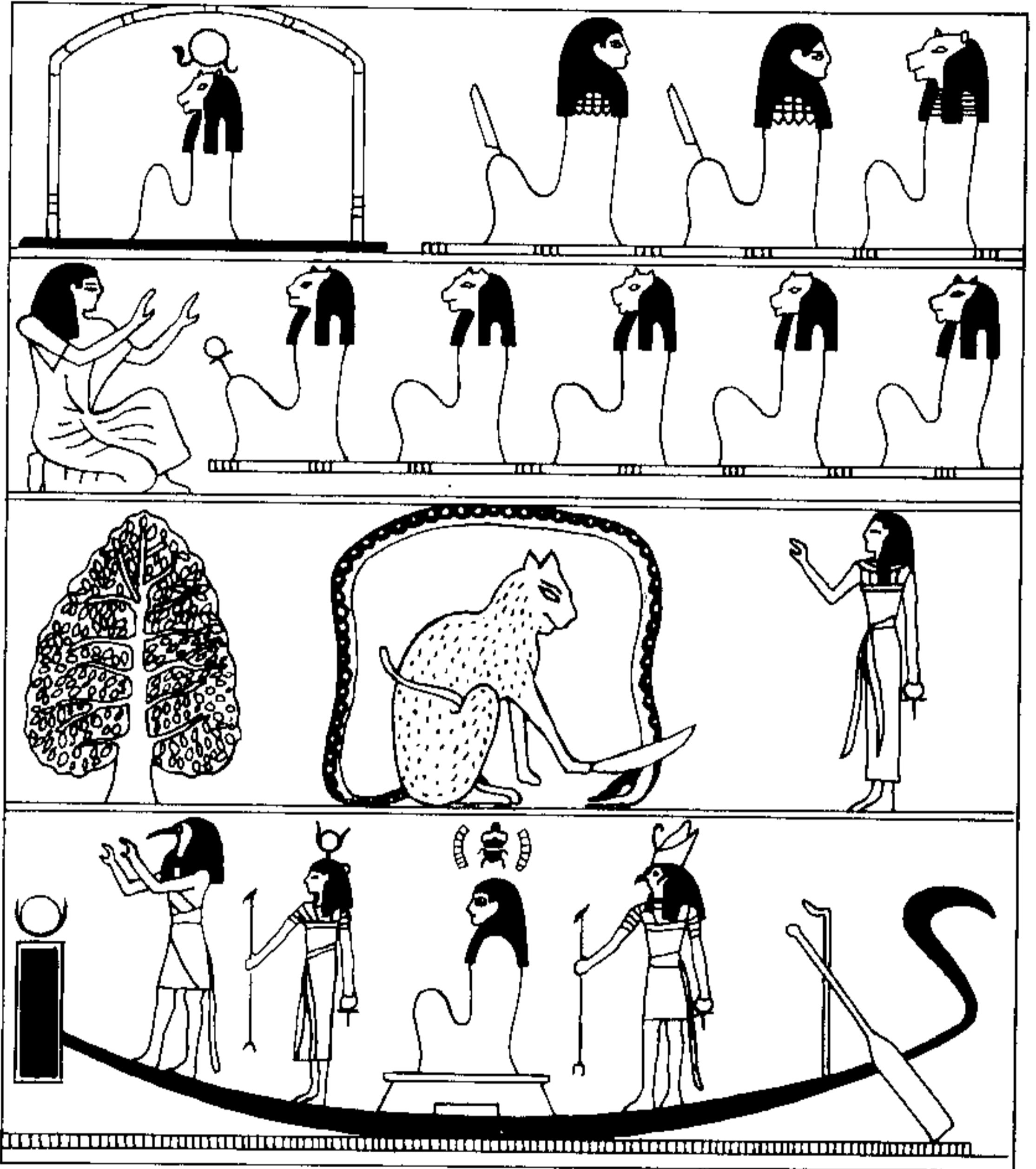

BLACK COLUMN: UPPER SECTION OF EGYPTIAN SYMBOLS

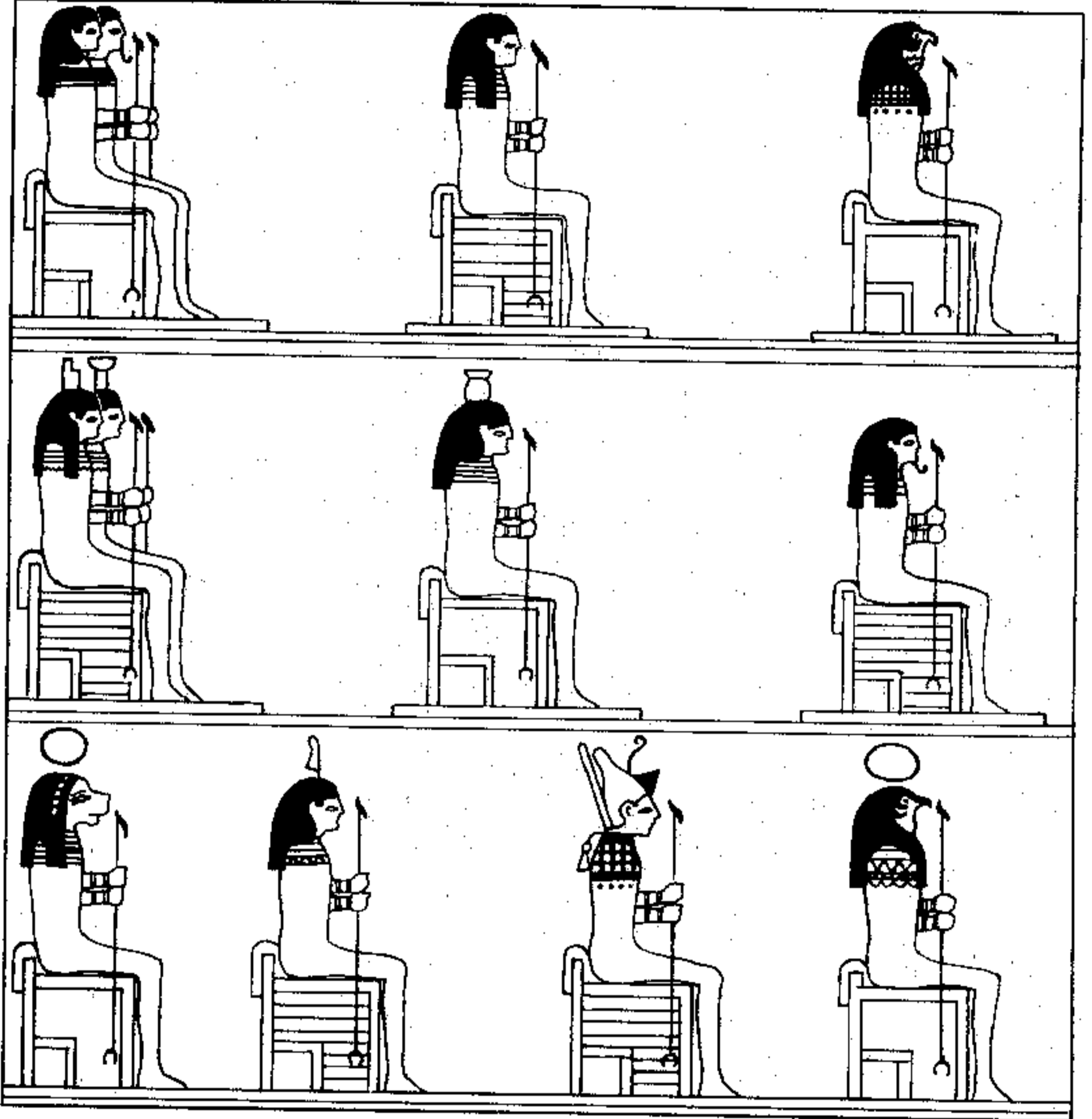

BLACK COLUMN: LOWER SECTION OF EGYPTIAN SYMBOLS



15 / The Temple Diagram

This diagram may be described as a complete "Ceremonial" Tree of Life. On each of the Sefhira the appropriate God Names are painted in their opposite or *flashing* color, as is also found on the instruments. The principle of flashing colors is very basic to the Golden Dawn system. The Qabalah, of which the Tree of Life is the primary symbol, involves opposites, and the desire to bring those opposites into perfect balance. A force functions properly only when its opposite and balancing force is present. Thus the colors, which are the mundane aspects of the actual spiritual forces, are activated in the presence of their opposites.

The Sephiroth are painted in the colors of *Briah*, while the paths are painted in the colors of *Atziluth* providing a balance of masculine and feminine in the same symbol.

The following are the proper colors of the Sephiroth and Paths, the opposites of which can be easily derived from a color wheel, as has been previously noted. The full scales of color in the four worlds, as apparently developed by MacGregor Mathers, can be found in Regardie's *Golden Dawn*, and Crowley's 777.

SEPHIROTH:

1. White brilliance
2. Grey
3. Black

4. Blue
5. Scarlet Red
6. Yellow (gold)
7. Emerald
8. Orange
9. Violet
10. Citrine, olive, russet and black

PATHS:

11. Bright pale yellow
12. Yellow
13. Blue
14. Emerald Green
15. Scarlet
16. Red orange
17. Orange
18. Amber
19. Yellow, greenish
20. Green, yellowish
21. Violet
22. Emerald Green
23. Deep blue
24. Green blue
25. Blue
26. Indigo
27. Scarlet
28. Violet
29. Crimson (ultra-violet)
30. Orange
31. Glowing orange scarlet
32. Indigo

Constructing the Diagram

1) From birch plywood of any thickness cut a panel to some standard size, such as 9 x 12, 11 x 14 or 16 x 20. Any size panel would suffice, but a standard size permits mounting in an inexpensive stock frame.

2) Seal the front and back of the panel with gesso. Allow to dry and sand lightly. Repeat the process with a second coat.

TREE OF LIFE CONSTRUCTION

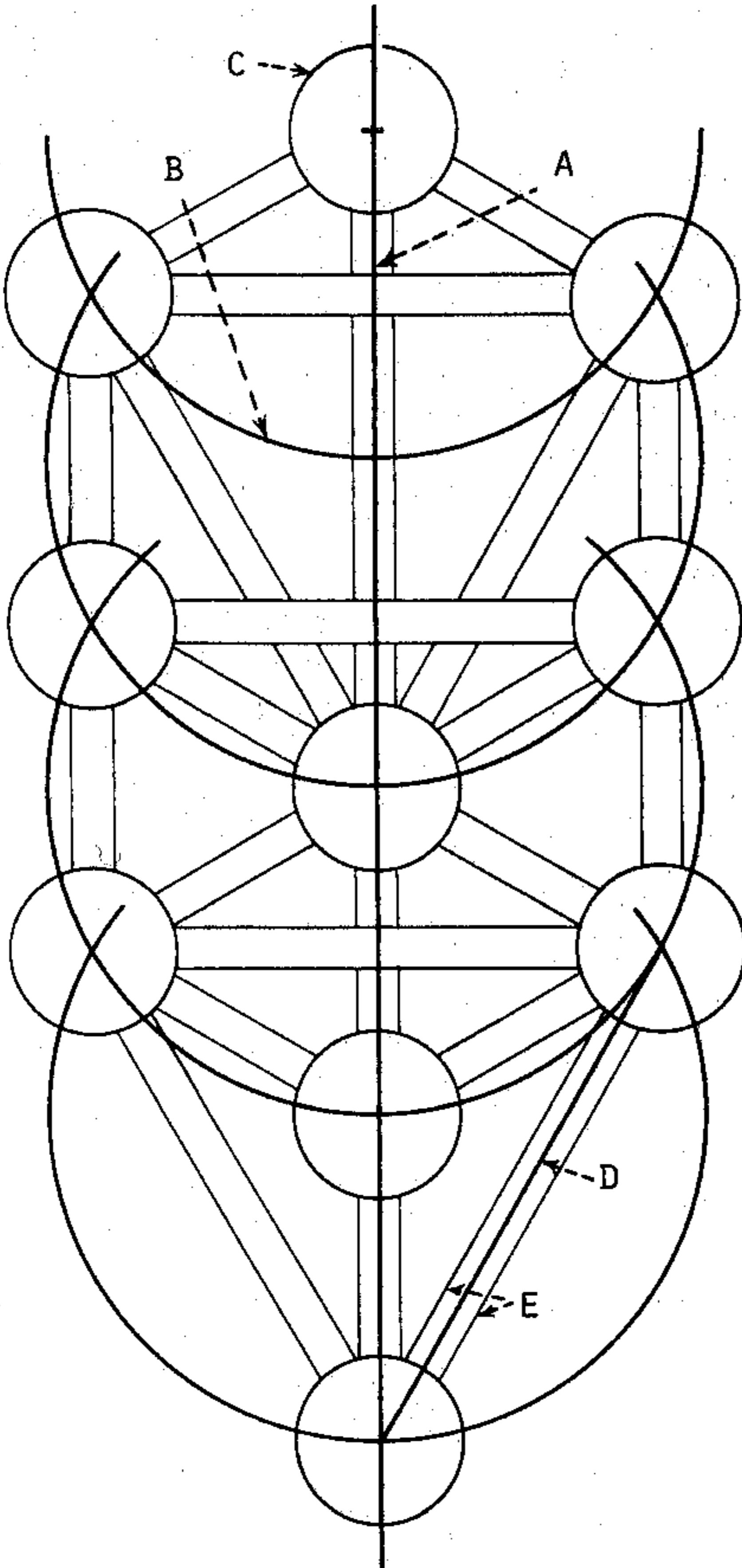

3) Using a pencil, ruler and compass, *construct* a Tree of Life. This is very simple, though a surprising number of even experienced students are unfamiliar with the method:

A. As shown in the illustration following, measure from both sides of the panel, and draw a central line from top to bottom.

B. Determine the length of the Tree on the basis of the space desired above and beneath it. Set the compass to a measure which is $1/4$ the total intended length of the diagram. For example if the Tree is to be eight inches long, set the compass to two inches.

Set the point of the compass at the top of the line and draw a circle. Then bring the compass point to the area of intersection of the central line and circle just drawn. Repeat this procedure until there are four intersecting circles. This establishes the precise centers of the Sephiroth.

C. Draw the Sephiroth with the compass. The proper diameter of each Sephira is one half the original compass line (B; if two inches, the diameter of the circle would be one inch).

D. Draw Path lines between the center points of the Sephiroth.

E. Using dividers or a ruler, establish the width of the Paths by measuring two points equidistant from the central line (D). Note that the width of the Paths must be such that five Paths will fit at the top of the sixth Sephira, Tiphareth. With a ruler, draw the outside line on each Path.

4) Paint the Sephiroth using artist's acrylics. Outlines are most easily established by using water-thinned paint in a compass.

5) Paint the Paths. Here, too, outlines can be established using a ruling pen and thinned paint. Since there are so many colors, and since retouching may be necessary, it is advisable to mix the paints in small bits of aluminum foil.

Try to paint all Paths requiring the same color at one time.

6) Add the Serpent, which touches each Path (see full-color Temple illustration).

7) Add the God Names, to the Sephiroth, and the Hebrew letters to the Paths.

8) Allow the paint to cure, and varnish as usual.

THE DIVINE NAMES ATTRIBUTED TO THE SEPHIROTH

No. OF SEPHIRAH	DIVINE NAME (Atziluth)	ARCHANGELIC NAME (Briah)	CHOIR OF ANGELS (Yetsirah)
1. Kether	Eheieh אהיה	Metatron מטטרון	Chayoth ha-Qadesh חיות הקדש
2. Chokmah	Yah יה	Raziel רזיאל	Auphanim אופנים
3. Binah	Yhvh Elohim יהוה אלהים	Tzaphqiel צפקיאל	Aralim ארלים
4. Chesed	El אל	Tzadqiel צדקיאל	Chashmalim חשמלים
5. Geburah	Elohim Gibor אלהים גבור	Kamael כמאל	Seraphim שרפים
6. Tiphareth	Yhvh Eloah Vedaath יהוה אלוה ודעת	Raphael רפאל	Melekim מלכים
7. Netzach	Yhvh Tzabaoth יהוה צבאות	Haniel האניאל	Elohim אלהים
8. Hod	Elohim Tzabaoth אלהים צבאות	Michael מיכאל	Beni Elohim בני אלהים
9. Yesod	Shaddai El Chai שדי אלהי	Gabriel גבריאל	Kerubim כרוכים
10. Malkuth	Adonai ha-Aretz אדני הארץ	Sandalphon סנדלפון	Ashim אשים

(From Israel Regardie, *The Golden Dawn*)

16 / The Banners of the East and West

The Banners are a difficult craft project because of the sharp corners required on some pieces. Their preparation demands both sewing experience and a rather meticulous sense for detail.

Material for the Banners should be very thin. It is almost impossible to fold thick cottons or other fabrics into these patterns; they invariably appear lumpy and crude. The ideal fabric, from the standpoints of availability of colors, cost and ease of construction, are acetates intended as lining materials.

To some extent, this should be considered a "cut and paste" project. Iron-on seam binding should be used to hold the pieces firmly in place before they are overstitched. It is essential that the pieces be held completely flat before final sewing, if a machine is used. Otherwise fabrics may pull to one side or the other, creating uneven lines.

The following is a technique for sewing a cross. In the absence of iron-on seam binding, the panels should be *basted* (large temporary stitches) to the background panel.

1) Iron the fabric, and on the back of it draw a cross. A soft black pencil will generally show up, even on black fabrics. A white chalk pencil available at fabric stores may also be used. Lines must be measured carefully.

2) Cut around the outside of the Cross, leaving a border of approximately $\frac{3}{8}$ inch.

3) Cut the corners and central angles as shown in the illustration.

4) Apply a very small drop of white glue at each inner or outer corner point. This will keep the fabric from fraying at the point where there is nothing to be folded over.

5) With a steam iron, fold back the edges of the cross. Some materials will hold such an edge easily, but others may require tacking with a small strip of the seam binding.

6) Place the cross on the background material, with strips of seam binding underneath. Cover it with a cloth and press with a hot iron.

7) Finally, overstitch around all of the edges, keeping the lines as straight as possible.

Triangular corner cut for outer fold

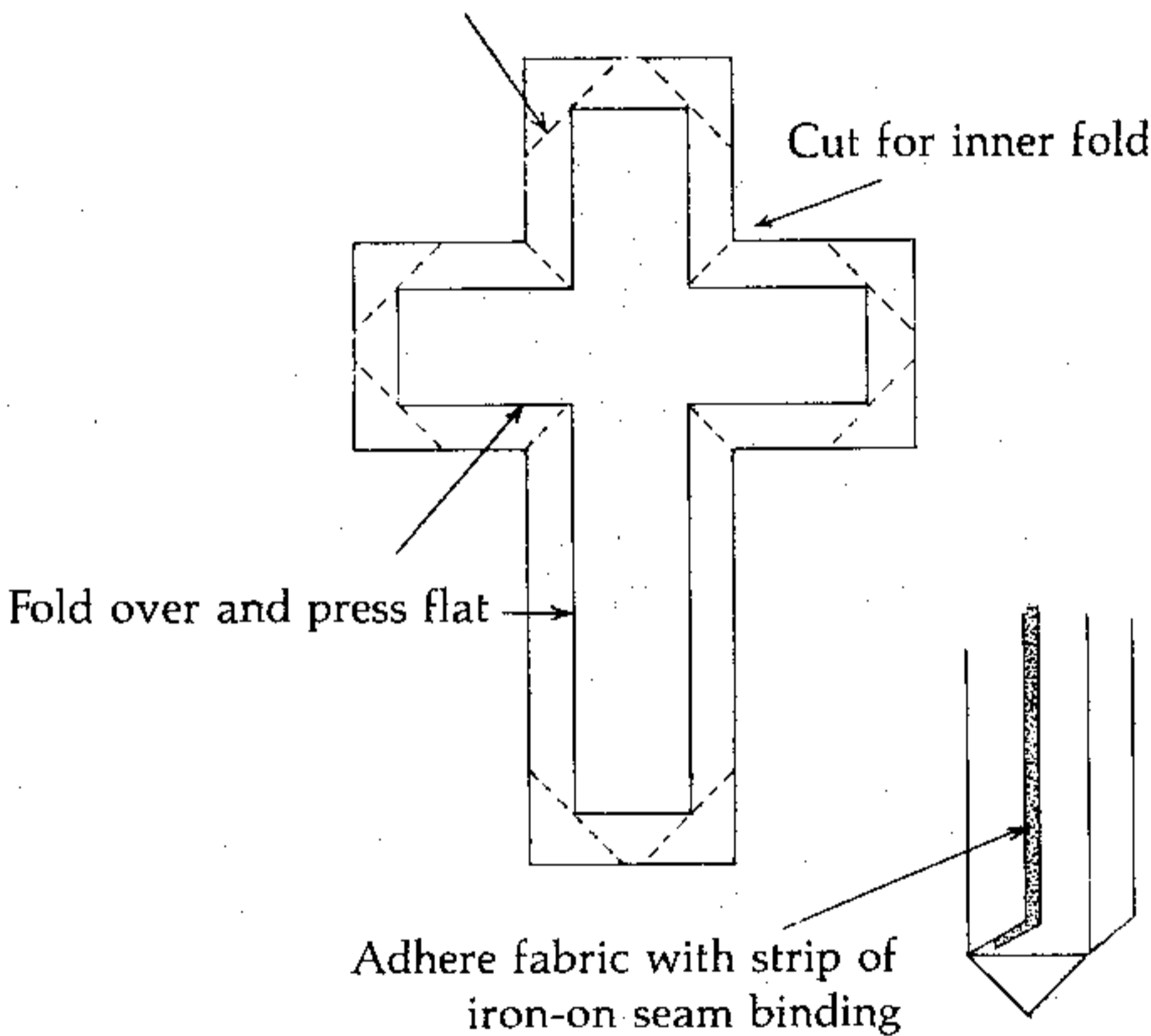

Hanging the Banners

Both Banners have red tassels (available in most fabric stores) at the corners, and are hung from a gold bar. On the black Banner the bar is suspended from a black cord, and on the white Banner the cord is red. The simplest way to suspend the Banners is to attach them with heavy thread. In those illustrated, a metallic gold embroidery thread is used. The cross bars

here are nothing more than simple 3/4 inch dowel rods, with small wooden drawer pulls at the ends.

The Golden Dawn papers state merely that the stand for the Banner of the East should be white, and that of the Banner of the West black. Very simple stands can be made of round or square wood mounted on a base plate. The twisted columns of the stands illustrated here are a commercially available decorative dowel often used as curtain rods. The finials are actually curtain rod end pieces, and the bases are plywood circles sold ready-cut in many hardware and lumber stores. The Banner cord is suspended from another drawer pull.

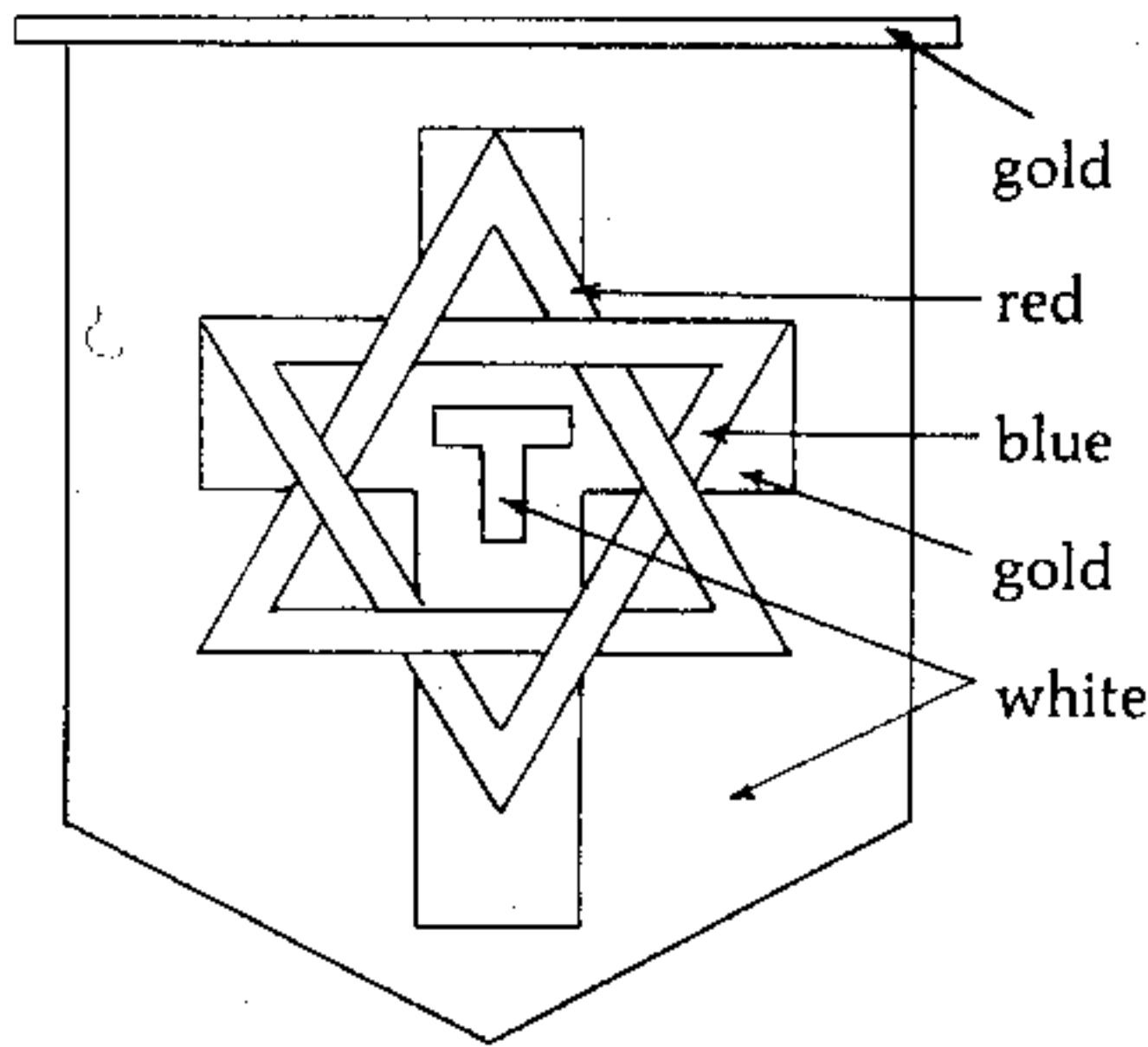

THE BANNER OF THE EAST

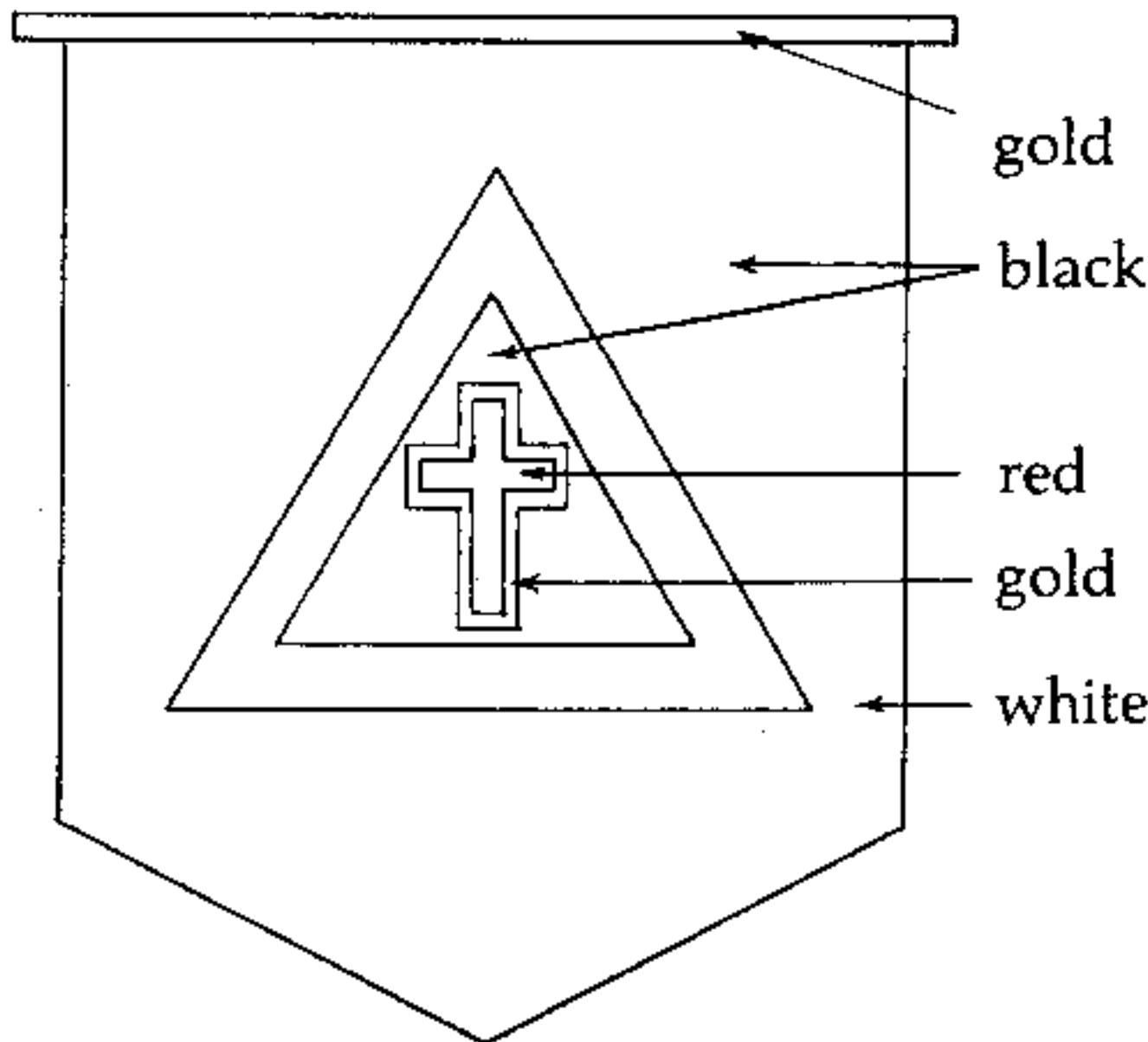

THE BANNER OF THE WEST

17 / The Enochian Tablets

These Tablets are placed at the four cardinal points around the Temple: The Air Tablet is in the east, the Water Tablet is in the west, the Fire Tablet is in the south and the Earth Tablet is in the North.

While these Tablets, or *Watch Towers*, are essential to a completely accurate Temple, particularly for group working, there are some simple alternatives. The first is the use of the Angelic Sigils above the Tablets. These can be painted on round pieces of wood and placed appropriately. A second alternative is the use of small plaques of the *Kerubim*, either painted or carved. The Lion is Fire, the Eagle is Water, the Man is Air and the Bull is Earth.



FIRE



WATER



AIR



EARTH

The painting of the Enochian Tablets is a very time-consuming task, but well worth the effort required. Their presence in the Temple adds extraordinary vitality.

1) Cut four pieces of birch plywood to approximately 16 x 20 inches. Size is less important than the proportions, since the Tablets themselves are square, but with the addition of the Sigils, the whole is a balanced rectangle.

2) Seal the boards, front and back, with gesso, and sand lightly.

3) Paint the background color of the board. *The backgrounds of the boards should not all be painted at once.* After an acrylic (or oil) paint has cured for some time, new paint will not properly adhere to it. And since work on the Tablets is invariably slow, it is best to complete one before beginning another.

4) Carefully measure the squares on the boards, and rule them out with a soft pencil.

5) Paint the lines with a fine brush or with thinned paint in a ruling pen.

6) Paint the letters in the opposite color of the background.

7) Allow the paint to cure, and coat with clear acrylic varnish.

8) Attach picture hooks and wire to the back of the panel.

The Tablets shown in the color photograph of the Temple are arranged strictly for illustration purposes. Normally, the Air Tablet would be hung above the Altar diagram in the east. It should also be noted that these particular Tablets have the square section and the Sigils cut out and raised, which is a more interesting, though unnecessary option.

FIRE TABLET

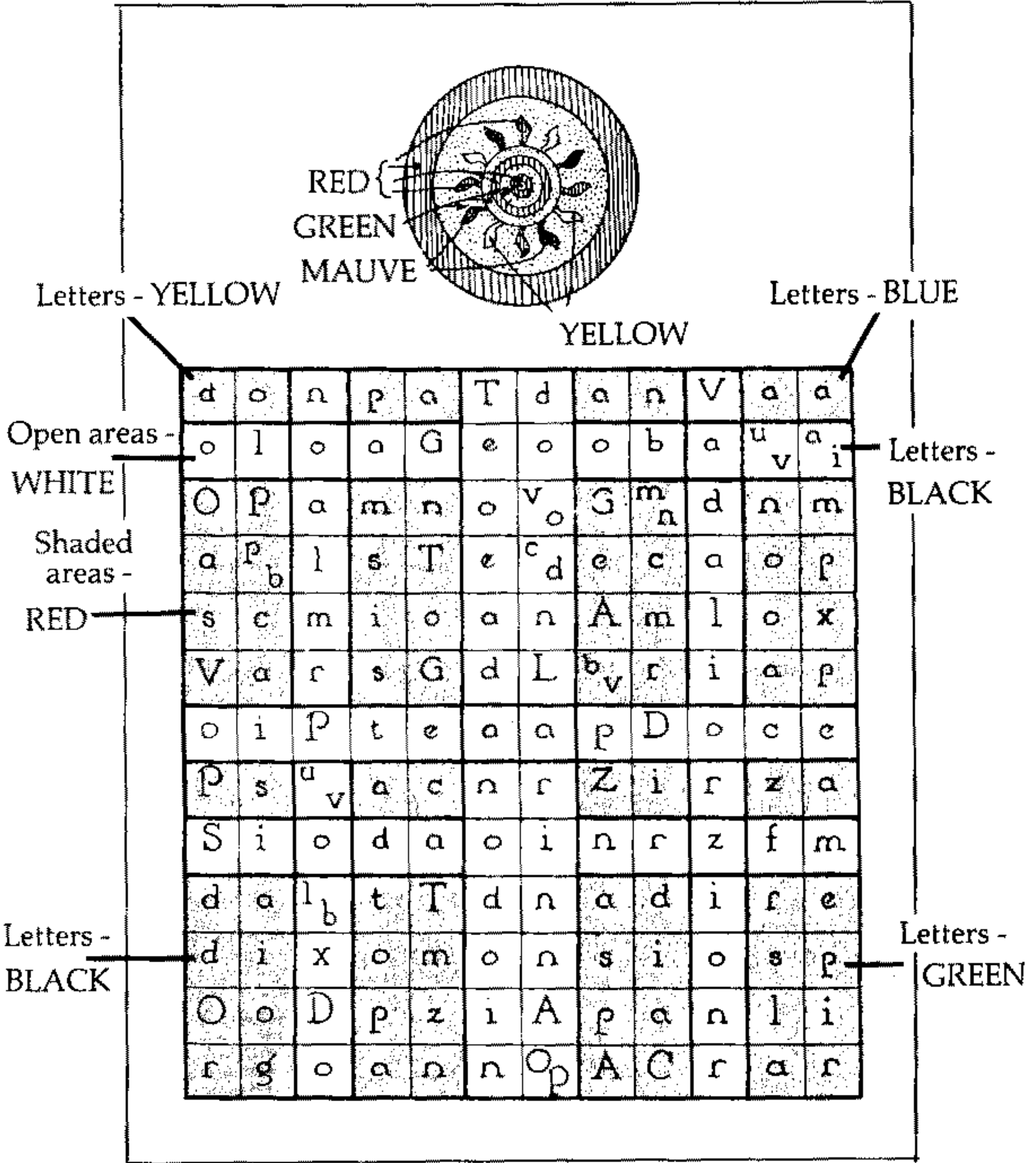

(Adapted from Israel Regardie, *The Golden Dawn*, Vol. 4, 1940)

WATER TABLET

BLUE
 ORANGE
 Letters - YELLOW
 Letters - ORANGE

	T	a	O	A	d	^u v	p	t	D	n	i	m	
Open areas -	a	a	b	c	o	o	r	o	m	e	b	b	Letters -
WHITE													BLACK
	T	o	g	c	o	n	x	m	a	l	G	m	
	n	h	o	d	D	i	a	i	l	a	o	c	
Shaded areas -	f	a	t	A	x	i	v	V	s	p	x	v	
BLUE													
	S	a	a	i	x	a	a	r	V	r	L	i	
	m	p	h	a	r	s	l	g	a	i	o	l	
	M	a	m	g	l	o	i	a	L	i	r	x	
	o	l	a	a	D	ⁿ a	g	a	T	a	p	a	Letters -
Letters -													RED
BLACK													
	p	a	L	e	e	i	d	x	P	a	c	n	
	n	d	a	z	N	^z x	i	V	a	a	s	a	
	r	i	i	d	P	o	n	s	d	A	s	p	i
	x	r	^l r	n	h	t	a	r	ⁿ a	d	i	L	

(Adapted from Israel Regardie, *The Golden Dawn*, Vol. 4, 1940)

AIR TABLET

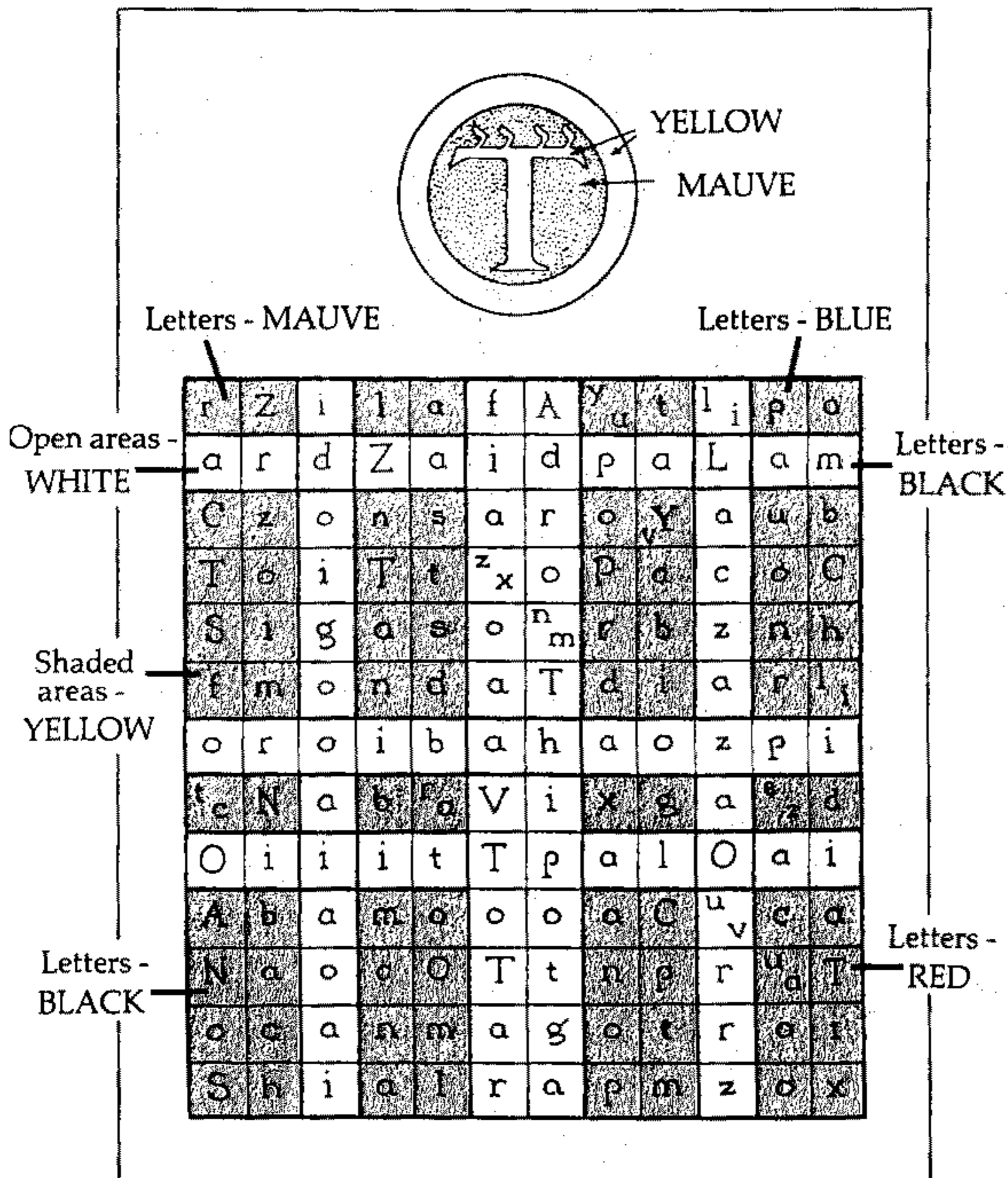

(Adapted from Israel Regardie, *The Golden Dawn*, Vol. 4, 1940)

EARTH TABLET

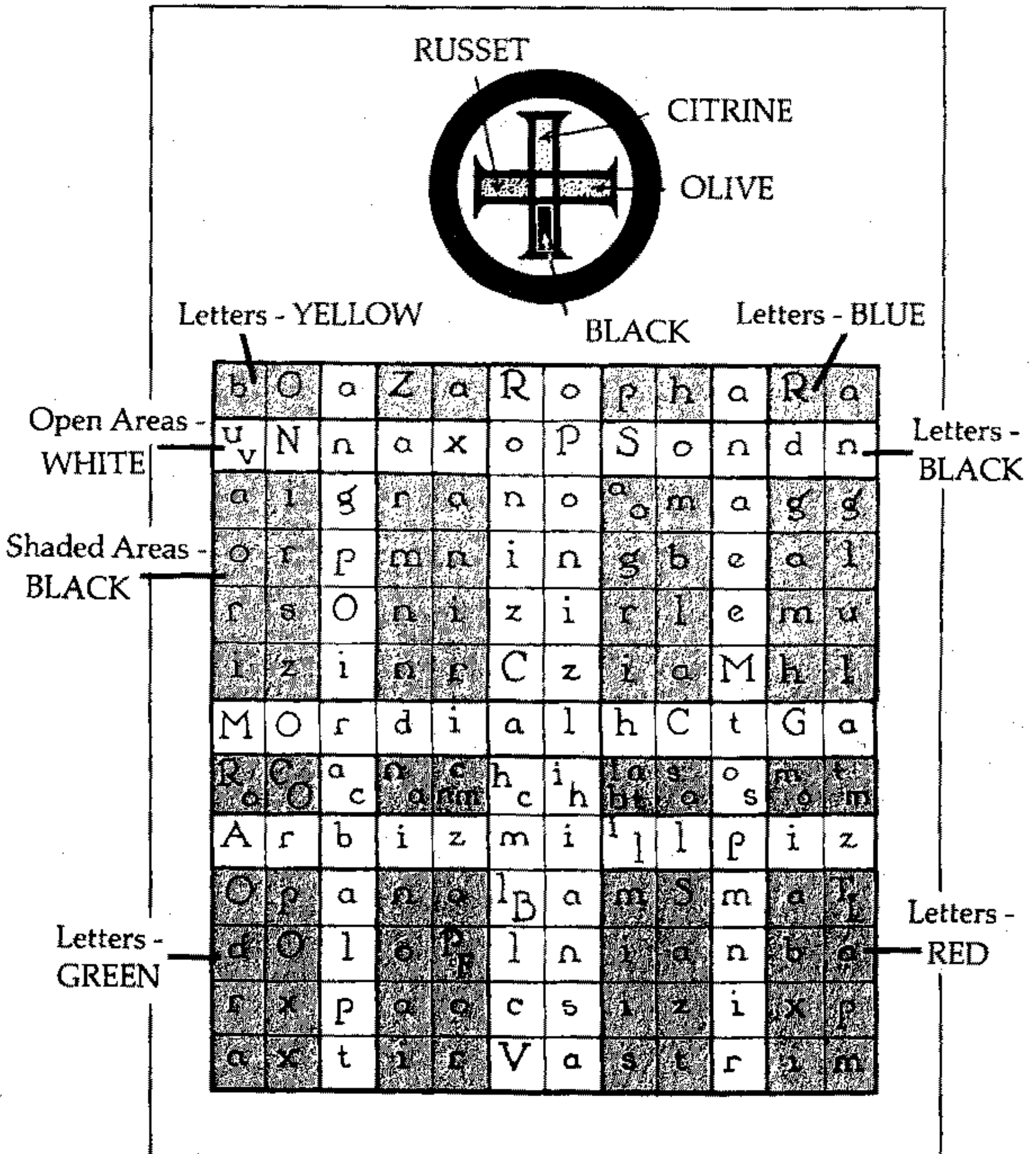

(Adapted from Israel Regardie, *The Golden Dawn*, Vol. 4, 1940)

18 / Robes

On the basis of published descriptions, it would appear that the robes of the original Golden Dawn were extremely elaborate and beautiful. Their rituals must have been art forms in the highest sense of the word.

While a very complicated robe may be produced, the Golden Dawn papers describe one which is little more than a Tau cross. This is worn with a *Nemyss*, an ancient Egyptian form of headgear.

The basic robe of the *Adeptus Minor* is of white material edged with gold. That illustrated here is of a light polyester fabric, with stock gold trim. A hood has been substituted for a *Nemyss*.

This book will not attempt to give sewing instructions on robes, in the belief that those who already sew will not need such assistance, and others are likely to hand the project over to a competent tailor or seamstress.

Whatever the design or construction of the Robe, it is a most important part of the ritual apparatus. As anyone who follows these practices will attest, the wearing of a robe effects a psychological separation from normal life. The more special the robe, the more pronounced this effect is likely to be.

Notes on Consecration

Rituals of consecration for each of the instruments is given in *The Golden Dawn*, Volume Three. These are composite rituals, involving the use of the Pentagrams and Hexagrams, which should be studied very thoroughly before they are actually performed. The rituals presuppose familiarity with all Banishing rituals. Moreover, a student is advised to spend some time working with the exercise of the *Middle Pillar*, which will confer no small appreciation of the energies invoked in these ceremonies.

While it is not explicitly stated in the Golden Dawn documents, some consideration should be given to the astrological aspects under which the instruments are consecrated.

A ritual of consecration may be done repeatedly, thus adding to the potency of the instruments, and increasing understanding of the nature of consecration in general. These Golden Dawn rituals seem to have been developed, partially, as an attempt to teach the methods of invocation. They are unsurpassed in that regard.

Finally, it should be noted that instruments are consecrated through their repeated use.

Recommended Reading

Israel Regardie, *The Golden Dawn*

Israel Regardie, *The Tree of Life*

Aleister Crowley, *The Equinox* (11 volumes)

Aleister Crowley, *Magick in Theory and Practice*

Aleister Crowley, *Book 4*

Aleister Crowley, *Magick without Tears*

Aleister Crowley, *777*

W.E. Butler, *The Magician, His Training and Work*

W.E. Butler, *Magic*

Francis Barrett, *The Magus*

\$7.95

the Secret Temple

This extraordinary new book (by the author of *Introduction to the Golden Dawn Tarot*) contains all that is required to produce a symbolically accurate temple and a full set of magical instruments in the Golden Dawn tradition. Full color photographs of the temple and of the instruments, as well as the precise hieroglyphs of the pillars, appear here in print for the first time. Instructions are given for the construction of the altar, pillars, Enochian tablets, Rose Cross Lamens, wands, etc., the difficult sigils and inscriptions having been worked out completely by the author. *The Secret Temple* is highly recommended to students of the Golden Dawn, Crowley, and the practical Qabalah.

ISBN 0-87728-490-3

SAMUEL WEISER, INC.
740 Broadway
New York, N.Y. 10003